

## HCT CO., LTD.



PRODUCT COMPLIANCE DIVISION  
SAN 136-1, AMI-RI, BUBAL-8EUP, ICHEON-SI, KYOUNGKI-DO, 467-701, KOREA  
TEL: +82 31 639 8518 FAX: +82 31 639 8525 [www.hct.co.kr](http://www.hct.co.kr)

### HAC T-Coil TEST REPORT

Cal-Comp Electronics & Communications Company Limited

3F., No.99, NAN-KING E.RD.,SEC.5, Taipei 105, Taiwan  
TEL: +82 2 2662 2660#7532 FAX: +82 2 8913 2001#7573

Date of Issue: Jul. 22, 2009

Test Report No.: HCT-IA0907-0301-03

Test Site: HCT CO., LTD.

## FCC ID: US7-A150

**APPLICANT: Cal-Comp Electronics & Communications Company Limited**

EUT Type:	Tri-Band CDMA Phone(CDMA/PCS CDMA/AWS CDMA)
Tx Frequency:	824.70 – 848.31 MHz (CDMA) 1 711.25 – 1 753.75 MHz (AWS CDMA) 1 851.25 – 1 908.75 MHz (PCS CDMA)
Maximum Conducted Power (HAC):	0.251 W CDMA (24.0 dBm) 0.251 W PCS CDMA (24.0 dBm) 0.251 W AWS CDMA (24.0 dBm)
Trade Name/Model(s):	Cal-Comp / A150
FCC Classification:	Licensed Portable Transmitter Held to Ear (PCE)
FCC Rule Part(s):	§20.19
HAC Standard:	ANSI C63.19-2007

## T Category: T4

This wireless portable device has been shown to be hearing-aid compatible under the above rated category, specified in ANSI/IEEE Std. C63.19 and had been tested in accordance with the specified measurement procedures. Hearing-Aid Compatibility is based on the assumption that all production units will be designed electrically identical to the device tested in this report.

I attest to the accuracy of data. All measurements reported herein were performed by me or were made under my supervision and are correct to the best of my knowledge and belief. I assume full responsibility for the completeness of these measurements and vouch for the qualifications of all persons taking them.

HCT Co., Ltd. Certifies that no party to this application has been denied FCC benefits pursuant to section 5301 of the Anti- Drug Abuse Act of 1998, 21 U.S. C. 862.

Report prepared by

: Sun-Hee Kim

Test Engineer of SAR Part

Approved by

: Jae-Sang So

Manager of SAR Part

## Table of Contents

1. INTRODUCTION -----	3
2. APPLICANT / EUT DESCRIPTION -----	3
3. TEST CONDITIONS -----	4
4. HAC T-Coil MEASUREMENT SET UP -----	5
5. SYSTEM SPECIFICATIONS -----	6
6. ANSI/IEEE C63.19 PERFORMANCE CATEGORIES -----	8
7. TEST PROCEDURE -----	10
8. AUDIO SIGNALS -----	11
9. T-COIL MEASUREMENT POINT AND REFERENCE PLANE -----	13
10. SIGNAL VERIFICATION -----	15
11. TEST SNR RESULTS -----	17
12. MEASUREMENT UNCERTAINTY OF AUDIO BAND MAGNETIC MEASUREMENTS ---	19
13. T-COIL MEASUREMENT RESULTS -----	20
13.1 Field Strength and Signal Quality -----	20
13.2 Frequency Response -----	23
13.3 T-Rating Results -----	28
APPENDIX A: AMBIENT NOISE PLOTS -----	31
APPENDIX B: AUDIO MAGNETIC PROBE CERTIFICATE -----	34
APPENDIX C: AMCC CERTIFICATE (HELMHOLZ COIL) -----	37
APPENDIX D: CONTOUR PLOTS	
APPENDIX E: HAC T-COIL TEST SETUP PHOTOS	

## 1. INTRODUCTION

This test report describes the Hearing Aid Compatibility (HAC) measurement of a wireless portable device manufactured by UTStarcom, Inc. These measurements were performed for compliance with the rules and regulations of the U.S. Federal Communications Commission (FCC). The testing was performed in accordance with ANSI C63.19-2007.

## 2. APPLICANT / EUT DESCRIPTION

### 2.1 Applicant

- Company Name: Cal-Comp Electronics & Communications Company Limited
- Address: 3F., No.99, NAN-KING E.RD., SEC.5, Taipei 105, Taiwan
- Tel. / Fax : +82 2 2662 2660#7532 / +82 2 8913 2001#7573

### 2.2 EUT Description

- EUT Type: Tri-Band CDMA Phone(CDMA/PCS CDMA/AWS CDMA)
- Trade Name: Cal-Comp
- Model(s): A150
- FCC ID: US7-A150
- Serial Number(s): #1
- Tx Frequency: 824.70 – 848.31 MHz (CDMA)  
1 711.25 – 1 753.75 MHz (AWS CDMA)  
1 851.25 – 1 908.75 MHz (PCS CDMA)
- FCC Classification: Licensed Portable Transmitter Held to Ear (PCE)
- FCC Rule Part(s): § 20.19(b); §6.3(v), §7.3(v)
- Modulation(s): CDMA835/AWS1700/PCS1900
- Antenna Type: Intenna
- Date(s) of Tests: Jul. 21, 2009
- Place of Tests: HCT CO., LTD.  
Icheon, Kyoung ki-Do, KOREA
- Report Serial No.: HCT-IA0907-0907-03

### 3. TEST CONDITIONS

#### 3.1 Environmental Conditions

All tests were performed under the following environmental conditions:

- 1) Ambient Temperature: (23 ± 2) °C
- 2) Relative Humidity (R.H.): 30 % < R.H. < 80 %

#### 3.2 Ambient Noise of the test site

The test site's ambient magnetic level were determined and found to be at least 10 dB below the measurement data ABM2, unless a very low level of AMB2. Measurement of the ambient level was performed for each probe orientation and results are shown in Appendix A.

#### 3.3 Conducted RF Power Test Data

Per the "Preliminary Guidance for Reviewing Applications for Certifications of 3G Devices" released on May 9, 2006, RC1 and RC3 CDMA modes are considered in SO55 service option (steps 3 & 4 of section 4.4.5.2 of 3GPP2 C.5.011 / TIA). In addition, RC1 and RC3 modes are considered in SO2 service option. The conducted power measurements for each mode are shown in the table below.

Band	Channel	SO2	SO2	SO55	SO55	TDSO
		RC1/1	RC3/3	RC1/1	RC3/3	SO32 RC3/3
CDMA	1013	23.71	23.70	23.69	23.73	23.77
	384	23.80	23.60	23.87	23.52	23.56
	777	23.77	23.62	23.76	23.49	23.53
PCS CDMA	25	23.64	23.35	23.61	23.53	23.59
	600	23.78	23.55	23.73	23.45	23.55
	1175	23.98	23.84	24.03	23.80	23.89
AWS CDMA	25	23.93	23.71	23.98	23.70	23.74
	450	23.91	23.77	23.92	23.75	23.72
	875	23.91	23.57	23.87	23.66	23.69

**Table 1 : Conducted Power (dBm)**

## 4. HAC T-Coil MEASUREMENT SET-UP



Figure 1: T-Coil setup with HAC Test Arch and AMCC.

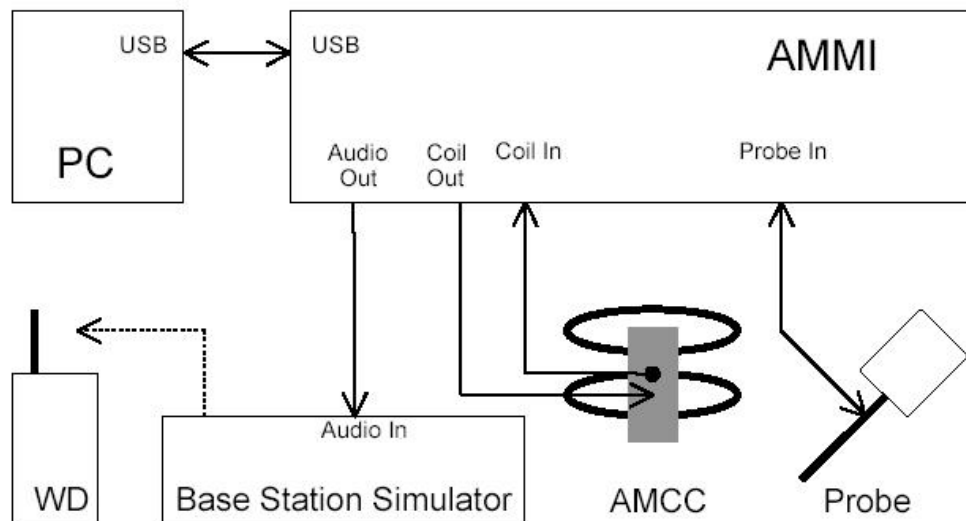

Figure 2: T-Coil setup cabling.

## 5. SYSTEM SPECIFICATIONS

The HCT utilizes a Dosimetric Assessment system (Dasy4<sup>TM</sup> v4.7) manufactured by Schmid & Partner Engineering AG (SPEAG<sup>TM</sup>) of Zurich, Switzerland. All T-coil measurements are taken within a shielded enclosure. The measurement uncertainty budget is shown in Table 7. The list of calibrated equipment used for the measurements is shown in Table 2.

Manufacturer	Type / Model	S/N	Calib. Date	Calib. Interval	Calib. Due
SPEAG	DAE3	446	May 22, 2009	Annual	May 22, 2010
SPEAG	Audio Magnetic 1D Field Probe	1013	N/A	N/A	N/A
SPEAG	AMMI SE UMS 010 AB	1015	N/A	N/A	N/A
SPEAG	AMCC SD HAC P02 A	1001	N/A	N/A	N/A
SPEAG	Test Arch SD HAC D01 BA	-	N/A	N/A	N/A
R&S	Base Station CMU200	838207/050	July 26, 2008	Annual	July 26, 2009
HP	Power Supply 6286A	2411A-08177	May 21, 2009	Annual	May 21, 2010

**Table 2 : Test Equipment**

### 5.1 Audio Magnetic Probe Description

Audio Magnetic Probe (AM1DV2) is an active probe with a single sensor. The same probe coil is used to measure three orthogonal field components (axial, radial 1, radial 2). The probe is rotated to properly orient the coil for each field component.

### 5.2 AMMI (Audio Magnetic Measurement Instrument)

AMMI is a desktop unit containing a sampling unit, a waveform generator for test, calibration signals and a USB interface. Front connectors include: Audio Out – predefined or user definable audio signals for injection into the WD; Probe In – the probe signal is evaluated by AMMI; Coil Out – test and calibration signal to the AMCC; Coil In – monitor signal from the AMCC.

### 5.3 AMCC (Audio Magnetic Calibration Coil)

AMCC is a Helmholtz coil for calibration of the AM1D probe. The two horizontal coils create a homogeneous magnetic field in the z direction. Refer to Appendix C for more details on AMCC coil. The probe is calibrated in AMCC coil. The frequency response and sensitivity are measured and stored. Sensitivity includes both probe sensitivity and pre-amplifier sensitivity.

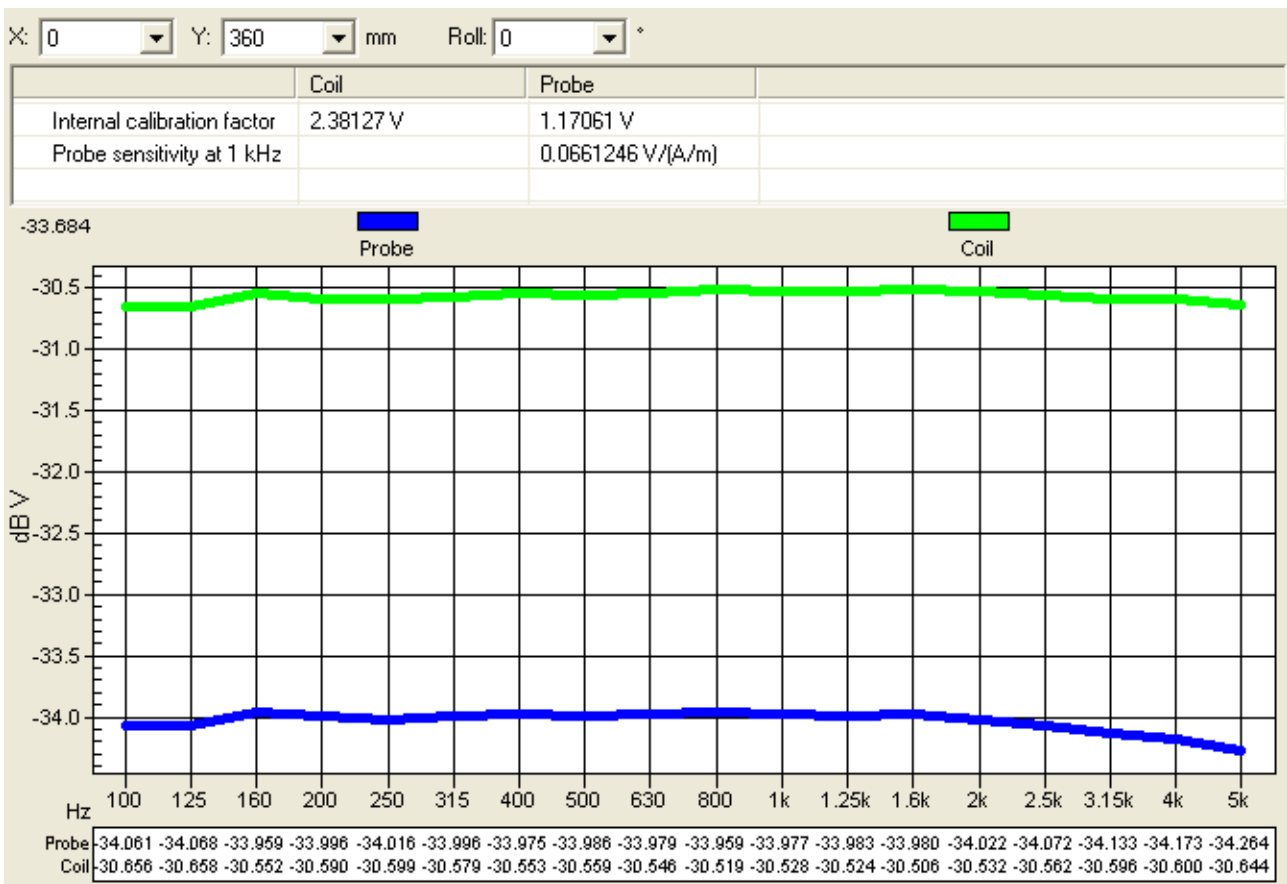

**Figure 3: Frequency Response measured in AMCC**

Sensitivity measured in AMCC: 0.0661246 V / (A/m)

The sensitivity is for 1 kHz sine signal. The sensitivity includes both probe sensitivity and pre-amplifier sensitivity. It is the total calibration, and there are no additional probe calibration factors. The voltage into the Helmholtz coil is across the shunt resistor.

## 6. ANSI/IEEE C63.19 PERFORMANCE CATEGORIES

### Field Intensity

The T-Coil signal shall be  $\geq -18$  dB (A/m) at 1 kHz, in a 1/3 octave band filter for all orientations.

### Frequency Response

The frequency response of the axial component of the magnetic field, measured in 1/3 octave bands, shall follow the response curve specified in EIA RS-504-1983, over the frequency range 300-3 000 Hz. These response curves are for true field strength measurements of the T-Coil signal.

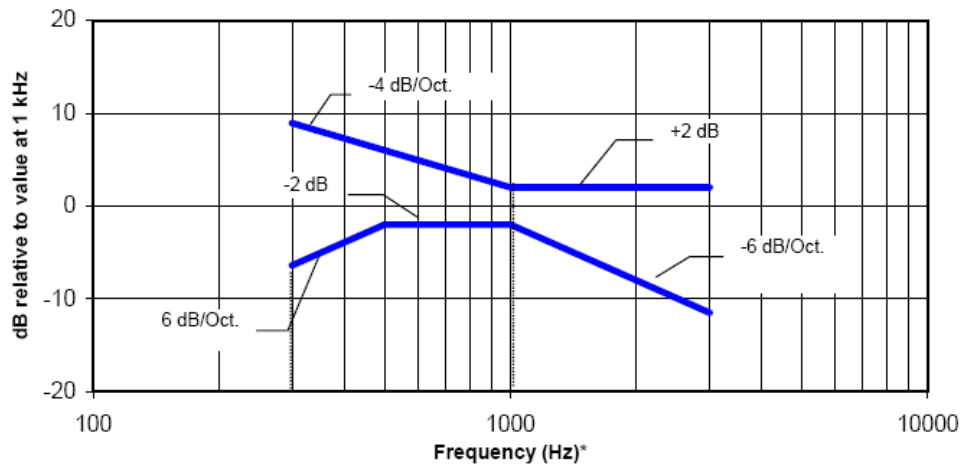

Figure 4 : Magnetic field frequency response for WDs with a field  $\leq -15$  dB (A/m) at 1 kHz

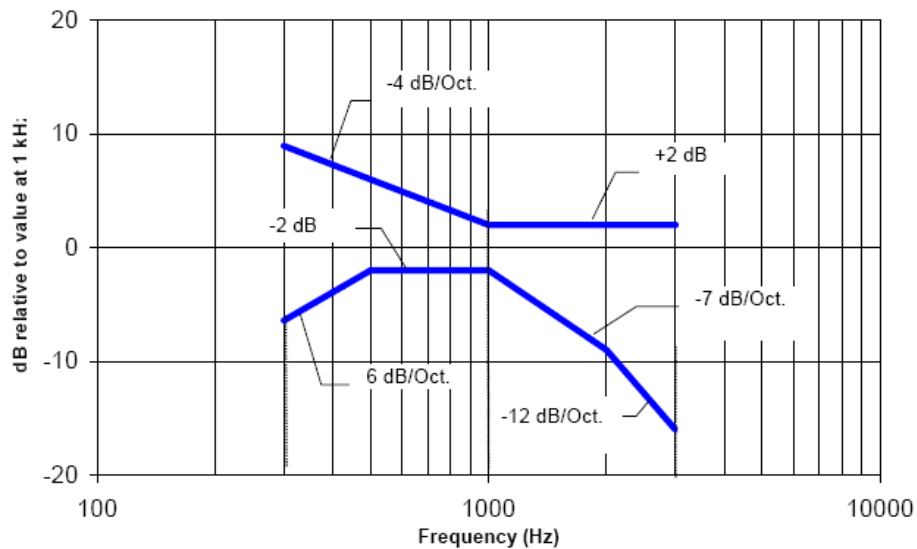

Figure 5 : Magnetic field frequency response for WDs with a field that exceeds  $-15$  dB(A/m) at 1 kHz



**Signal Quality**

This section provides the signal quality requirement for the intended T-Coil signal from a WD. Only the RF immunity of the hearing aid is measured in T-Coil mode. It is assumed that a hearing aid can have no immunity to an interference signal in the audio band, which is the intended reception band for this mode. So, the only criteria that can be measured is the RF immunity in T-Coil mode. This is measured using the same procedure as for the audio coupling mode and at the same levels.

A device may be classified according to its audio coupling mode (M1 through M4), its T-Coil mode (T1 through T4), or both. Note: the T mode rating may be higher than the M mode rating.

<b>Category</b>	<b>Telephone parameters WD signal quality [(signal + noise)-to-noise ratio in decibels]</b>
Category T1	0 dB to 10 dB
Category T2	10 dB to 20 dB
Category T3	20 dB to 30 dB
Category T4	> 30 dB

**Table 3 : T-Coil signal quality categories**

## 7. TEST PROCEDURE

The device was positioned and setup according to ANSI C63.19-2007. Figure 6 shows the T-Coil Signal measurement flowchart:

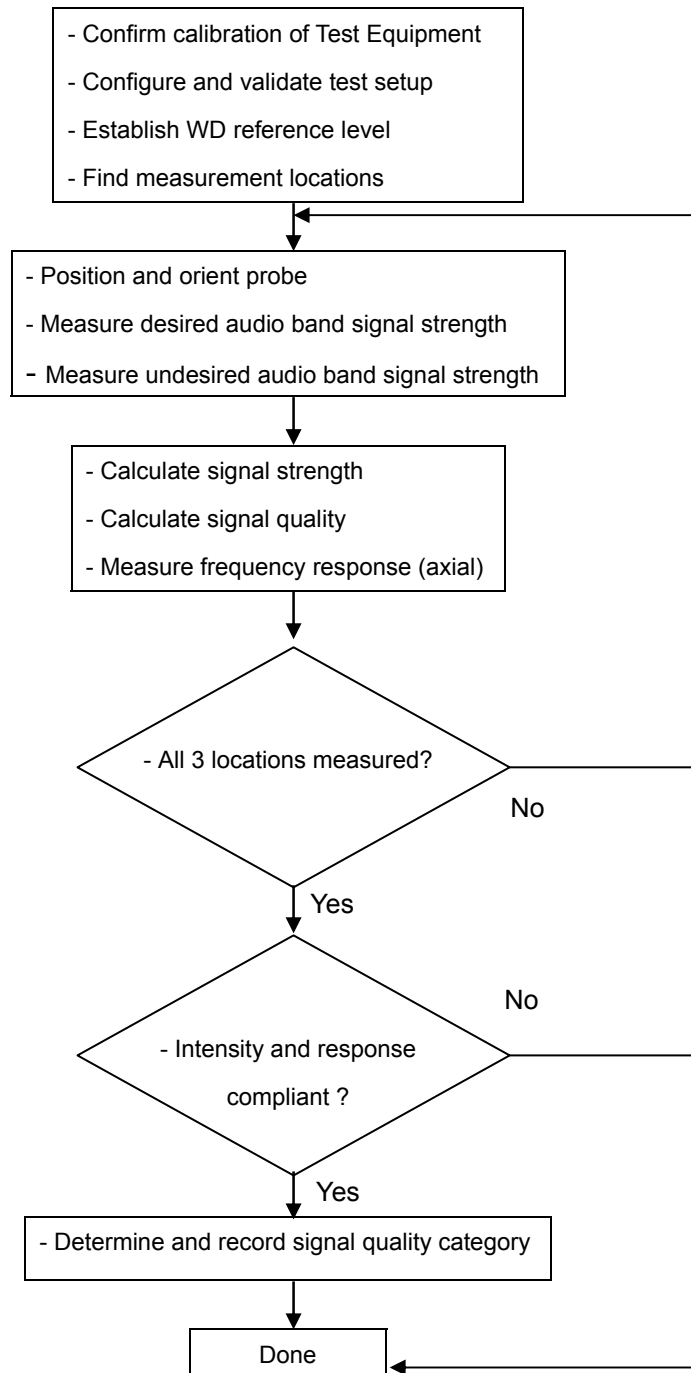

**Figure 6: T-Coil measurement flowchart**

## 8. AUDIO SIGNALS

During tests signal was fed to the EUT via communication Test set. Proper gain setting was used in software to ensure correct signal level fed to communication test set speech input.

The following audio signals were pre-defined by DASY4 and used for calibration and measurements:

**48k voice 1kHz 1 s** (duration 1 s): The signal is voice like and has been further processed from the below signal to have a narrow bandwidth mainly within the 1 kHz third-octave band and an even shorter duration of 1 second for faster measurement. This signal passes through a large variety of codecs and permits a direct amplitude and signal quality measurement without considerable bandwidth compensation.

Peak to RMS ratio: 15.7 dB

The spectrum is shown in a practical measurement in figure 7.

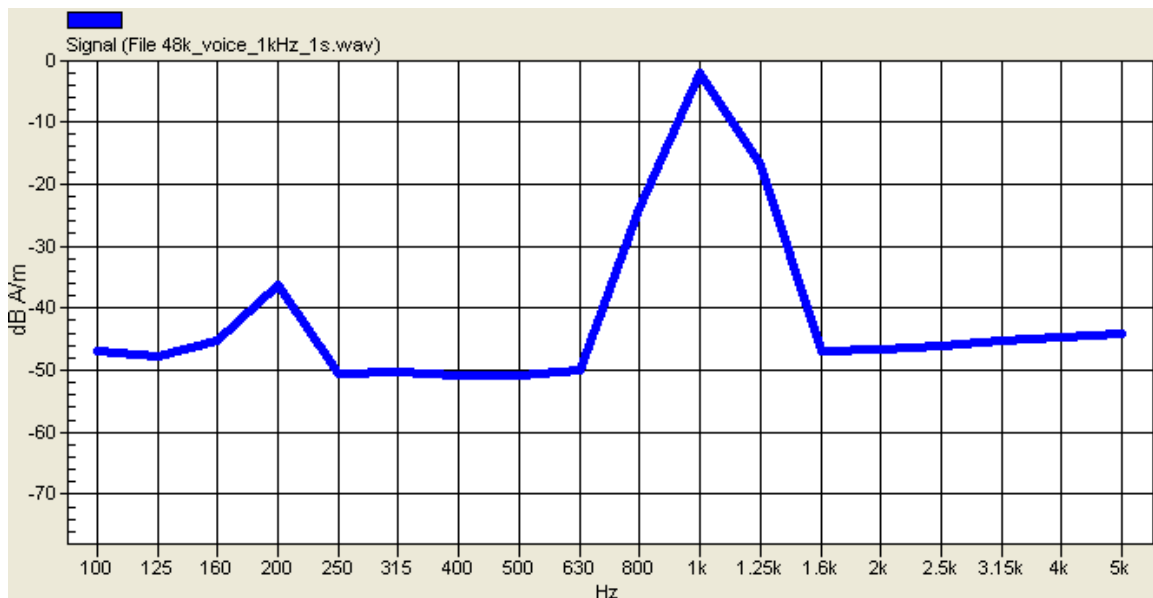

**Figure 7: 1 KHz Voice signal spectrum**

**48k voice 300-3000 2 s** (duration 2 seconds): The signals voice-like and has been processed to have duration of 2 seconds for fast measurement. At the same time, it has a flat spectrum across all third-octave band filters between 300 Hz to 3 kHz and is vanishing at the beginning and end in order to permit longer measurement sequences without transients. It has bandwidth sufficient for frequency response measurements. The spectrum is similar to the measurement in Figure. 8 but considerably flatter. The measurement window length of this signal must be set to a multiple of 2 seconds in order to integrate over the full voice sample.

Peak to RMS ratio: 21.6 dB

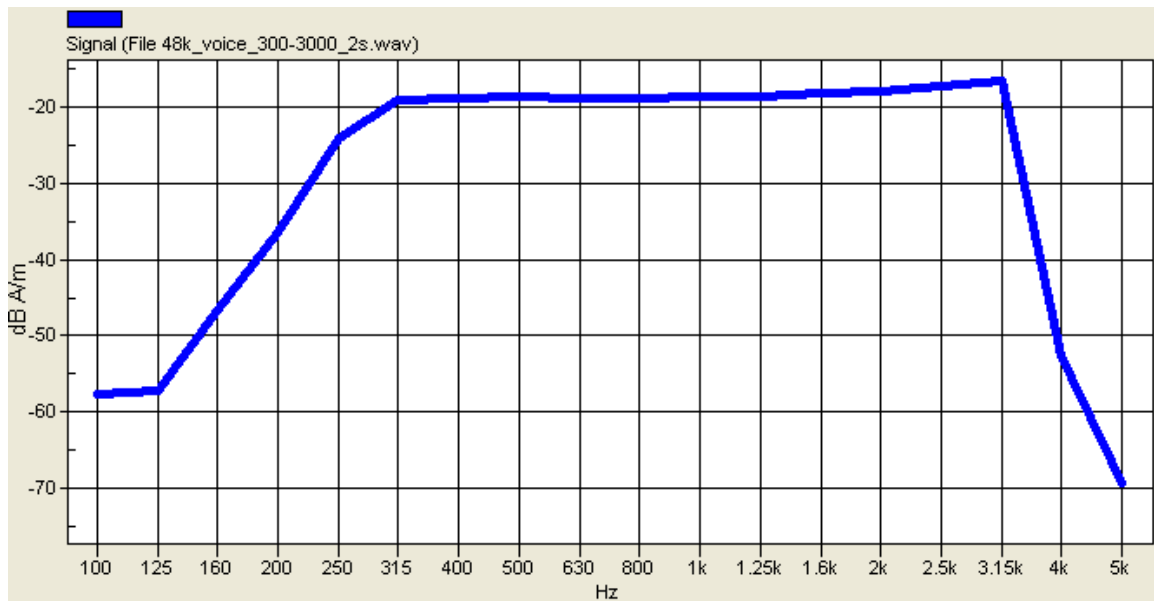

**Figure 8: Broadband signal spectrum**

## 9. T-COIL MEASUREMENT POINTS AND REFERENCE PLANE

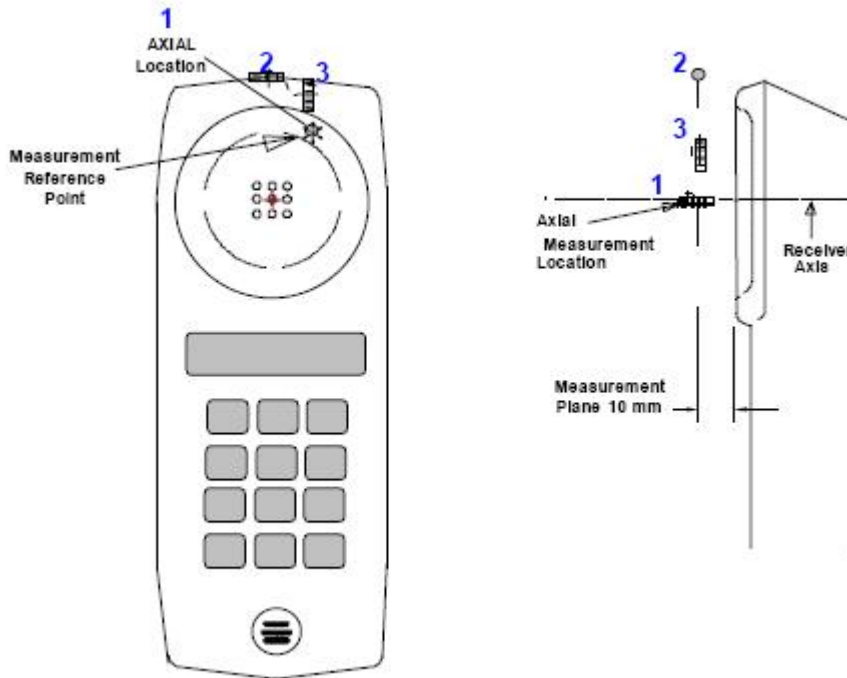

**Figure 9: Axis and planes for WD audio frequency magnetic field measurements**

Figure. 9 illustrates the three standard probe orientations. Position 1 is the axial orientation of the probe coil; orientation 2 and orientation 3 are radial orientations. The space between the measurement positions is not fixed. It is recommended that a scan of the WD be done for each probe coil orientation and that the maximum level recorded be used as the reading for that orientation of the probe coil.

1) The reference plane is the planar area that contains the highest point in the area of the phone that normally rests against the user's ear. It is parallel to the centerline of the receiver area of the phone and is defined by the points of the receiver-end of the WD handset, which, in normal handset use, rest against the ear.

2) The measurement plane is parallel to, and 10 mm in front of, the reference plane.

3) The reference axis is normal to the reference plane and passes through the center of the receiver speaker section (or the center of the hole array); or may be centered on a secondary inductive source. The actual location of the measurement point shall be noted in the test report as the measurement reference point.

4) The measurement points may be located where the axial and radial field intensity measurements are optimum with regard to the requirements. However, the measurement points should be near

the acoustic output of the WD and shall be located in the same half of the phone as the WD receiver. In a WD handset with a centered receiver and a circularly symmetrical magnetic field, the measurement axis and the reference axis would coincide.

5) The relative spacing of each measurement orientation is not fixed. The axial and two radial orientations should be chosen to select the optimal position.

6) The measurement point for the axial position is located 10 mm from the reference plane on the measurement axis. The actual location of the measurement point shall be noted in test reports and designated as the measurement reference point.

## 10. SIGNAL VERIFICATION

An Input Level is measured to verify that it is within  $\pm 0.2$  dB from the Reference Input Level in section 6.3.2.1 of ANSI C63.19-2007 V3.12

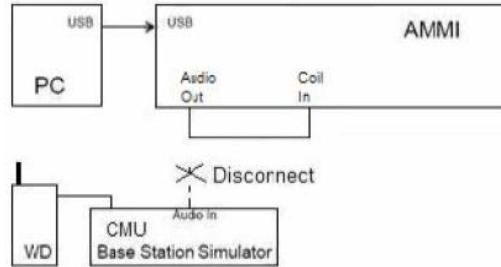

**Figure 10 : Signal Verification Setup**

In Figure 10 setup, “Audio Out” of the AMMI is connected to the “Coil In” of the AMMI.

Decoder: When an acoustic signal is provided to the phone of the device under test it travels through the device audio path. At the CMU this digital signal is Decoder and an analog voltage is generated at the CMU output. This voltage is measured and related to the dBm0 level according to the voltage generated and the dBm0 level.

When the CMU Decoder CAL is selected the CMU generated a voltage equivalent to the full-scale value(3.14 dBm0). The measured RMS voltage was 0.784 V ( $= 20 \times \log(0.784) = -2.11$  dBV)

Section 6.3.2.1 of ANSI C63.19-2007 specifies the reference input level to be - 16 dBm0 for GSM and - 18 dBm0 for CDMA. Each CMU has a slightly different “0 dBm0 Input Reference” value that must be measured. When the CMU box is replaced or externally re-calibrated, an internal calibration procedure must be completed in each transmission mode.

To get the reference level of the CMU200 (SN 838207/050), establish a call to a WD. If call is established, select Network Bistream DecoderCal, and a signal of 3.14 dBm0 will appear at the OUT. Read the RMS voltage which is - 2.11 dBV (0.784 V).

The desired level is calculated, e.g. -18 dBm0 for CDMA signal. The level of the signal in this coder shall therefore appear -21.14 dB lower than the previous, in our system it would be - 2.11 - 21.14 = - 23.25 dBV.

The Target Level for “Audio Out” of the AMMI is shown in Table 4. This target level takes into account the difference between AMMI’s and CMU’s reference levels.

$$Z = Y - (3.14 - X)$$

Where;

Z: signal required into CMU(dBV)

Y: desired dBm0 level(- 18 dBm0 for CDMA HAC T-coil testing)

X: measured actual level in the DecoderCal.(dBV)

$$Y = -18 \text{ dBm0}, X = 0.784 \text{ V} = -2.11 \text{ dBV}$$

$$\text{Therefore, } Z = -18 - (3.14 + 2.11) = -23.25 \text{ dBV}$$

The CMU's 0 dBm0 Input reference Value is  $-3.14 - 2.11 = -5.25 \text{ dBV}$

**Table 4: Measured Input Level**

Modulation	Reference Input Level Form ANSI C63.19 (dBm0)	CMU's 0 dBm0 Input Reference Value(dB)	Target Level For "Audio Out" of AMMI (dBm0)
CDMA	- 18	- 5.25	- 23.25

The signal level for "Audio Out" of the AMMI is measured. Signal Verification has been conducted on the same days as DUT measurements. If it is not within  $\pm 0.2 \text{ dB}$ , the gain settings in the DASY template are adjusted. The obtained results are displayed In Table 5.

**Table 5: Measured Input Level**

Modulation	Measured date	Signal	Measured Level for "Audio Out" of AMMI (dBm0)	Target Level For "Audio Out" of AMMI (dBm0)
CDMA	Jul. 21, 2009	Narrowband	- 23.26	- 23.25
		Broadband	- 23.25	



## **11. TEST SNR RESULTS**

---

The DASY4 v4.7 measurement system specified in section 3 was utilized within the intended operations as set by the SPEAG™ setup. The test Arch provided by SPEAG is used to position the DUT. This phone has one configuration for the ear use – folder open. This configuration is tested at the high, middle and low frequency channel of each applicable frequency band. All tests are done via conducted setup with CMU200. The volume on the phone is adjusted to maximum. Backlight was off during testing, and HAC compliance will be explained in the manual. The tests are performed using normal operation mode.

The distance is established by positioning the device beneath the test arch phantom so that it is touching the frame. The location and thickness of the arch, and the location/orientation of the coil within the probe housing, are precisely known values in the DASY software. The height of the measurement plane is further fine-tuned by performing a Surface Detection job at the beginning of each test. The end result is that the probe sensor is very precisely located 10 mm above the device reference plane.

T-coil SNR measurements are shown in Table 6. The sequence of the T-coil SNR measurement is listed in steps below.

- a) Geometry & signal check.
- b) Background noise measurement. The background noise is measured at the center of the listening area.
- c) Coarse resolution axial scans (narrow band signal, 1 second measurement times, 50 x 50 mm grid with 5.55 mm spacing). Only ABM1 is measured in order to find the location of the T- coil source.
- d) Fine resolution axial, radial-transverse, & radial-longitudinal scans, positioned appropriately based on optimal ABM1 of coarse resolution axial scan (narrowband signal, 1 second measurement times, variable grid size with 2 mm spacing). Both ABM1 and ABM2 are measured in order to find the location of the SNR point.
- e) ABM1 & ABM2 point measurements in axial, radial-transverse, & radial-longitudinal coil orientations, positioned appropriately based on optimal signal quality of fine resolution scans (narrowband signal, 2 seconds measurement times). SNR is calculated for each coil orientation.
- f) Frequency Response point measurement in axial coil orientation, positioned appropriately based on optimal signal quality of fine resolution axial scan (broadband signal, 12 seconds measurement time).

The ABM1, SNR and T-coil Rating results are shown in Table 6. Also shown are the measured conducted output power, location of the measured point, noise and ABM2. The delta between Ambient Noise measurement and ABM2 measurement should be greater than 10 dB. However, in cases where ABM2 is very low, it is suitable for the delta to be less than 10 dB. For the three probe positions, contour plots are given in Appendix D. For the three probe positions, noise spectrum plots for the highest ambient with an A-weight filter applied.

T-coil SNR Limits for AWF = 0		
ABM 1	Greater or equal to - 18 dB A/m	
SNR	T3	Greater than 20 dB
	T4	Greater than 30 dB

**Table 6: T-coil SNR Limits**

## 12. MEASUREMENT UNCERTAINTY OF AUDIO BAND MAGNETIC MEASUREMENTS

Error Description	Uncertainty value [%]	Prob. Dist.	Div.	c ABM1	c ABM2	Std. Unc. ABM1 [%]	Std. Unc. ABM2 [%]
<b>PROBE SENSITIVITY</b>							
Reference level	3.0	N	1.0	1	1	3.0	3.0
AMCC geometry	0.4	R	1.7	1	1	0.2	0.2
AMCC current	0.6	R	1.7	1	1	0.4	0.4
Probe positioning during calibration	0.1	R	1.7	1	1	0.1	0.1
Noise contribution	0.7	R	1.7	0.0143	1	0.0	0.4
Frequency slope	5.9	R	1.7	0.1	1.0	0.3	3.5
<b>PROBE SYSTEM</b>							
Repeatability / Drift	1.0	R	1.7	1	1	0.6	0.6
Linearity / Dynamic range	0.6	R	1.7	1	1	0.4	0.4
Acoustic noise	1.0	R	1.7	0.1	1	0.1	0.6
Probe angle	2.3	R	1.7	1	1	1.4	1.4
Spectral processing	0.9	R	1.7	1	1	0.5	0.5
Integration time	0.6	N	1.0	1	5	0.6	3.0
Field disturbance	0.2	R	1.7	1	1	0.1	0.1
<b>TEST SIGNAL</b>							
Reference signal spectral response	0.6	R	1.7	0	1	0.0	0.4
<b>POSITIONING</b>							
Probe positioning	1.9	R	1.7	1	1	1.1	1.1
Phantom thickness	0.9	R	1.7	1	1	0.5	0.5
DUT positioning	1.9	R	1.7	1	1	1.1	1.1
<b>EXTERNAL CONTRIBUTIONS</b>							
RF interference	0.0	R	1.7	1	1	0.0	0.0
Test signal variation	2.0	R	1.7	1	1	1.2	1.2
<b>COMBINED UNCERTAINTY</b>							
Combined Std. uncertainty (ABM field)						4.1	6.1
Expanded Std. uncertainty [%]						8.1	12.3

Table 7: Measurement uncertainty of audio band magnetic measurements

Notes for table

- 1. N: Nomal
- 2. R: Rectangular

## 13. T-COIL MEASUREMENT RESULTS

### 13.1 Field Strength and Signal Quality

#### 13.1.1 Field Strength and Signal Quality (CDMA)

Mode	Measurement Position	Channel	Probe Position	Measured Point Location (x mm/ y mm)	ABM2 (dB A/m)	ABM1 (dB A/m)	SNR (dB)	T-Rating
CDMA	Acoustic	1013	Axial (Z)	(- 0.5, 0.5)	- 44.1	2.67	46.8	T4
			Radial 1 (X)	(9, 0.5)	- 46.1	- 7.60	38.5	T4
			Radial 2 (Y)	(1.5, 10)	- 43.5	- 7.18	36.3	T4
		384	Axial (Z)	(- 2.5, 0.5)	- 45.0	1.90	46.9	T4
			Radial 1 (X)	(- 8, 1.5)	- 48.0	- 4.79	43.2	T4
			Radial 2 (Y)	(- 0.5, 10)	- 44.5	- 6.69	37.8	T4
		777	Axial (Z)	(1.5, 0.5)	- 41.9	1.14	43.1	T4
			Radial 1 (X)	(- 10, - 1.5)	- 48.1	- 7.51	40.6	T4
			Radial 2 (Y)	(- 2.5, - 9)	- 46.1	- 6.40	39.7	T4

Note:

- 1) Volume is set to maximum and LCD backlight is off during T-coil measurement.
- 2) Minimum Limit: ABM1  $\geq$  -18 dB A/m.
- 3) SNR = ABM1/ABM2.

### 13.1.2 Field Strength and Signal Quality (PCS CDMA)

Mode	Measurement Position	Channel	Probe Position	Measured Point Location (x mm/ y mm)	ABM2 (dB A/m)	ABM1 (dB A/m)	SNR (dB)	T-Rating
PCS CDMA	Acoustic	25	Axial (Z)	(- 0.5, 0.5)	- 43.4	3.72	47.2	T4
			Radial 1(X)	(- 8, 0.5)	- 47.6	- 6.76	40.8	T4
			Radial 2(Y)	(1.5, - 7)	- 44.4	- 7.69	36.7	T4
		600	Axial (Z)	(- 2.5, 0.5)	- 44.7	2.17	46.9	T4
			Radial 1(X)	(- 10, 0.5)	- 48.8	- 6.56	42.2	T4
			Radial 2(Y)	(2.5, - 6)	- 43.9	- 6.41	37.5	T4
		1175	Axial (Z)	(- 4.5, 0.5)	- 45.3	- 1.84	43.5	T4
			Radial 1(X)	(- 8, 2.5)	- 48.2	- 4.76	43.4	T4
			Radial 2(Y)	(1.5, - 9)	- 43.9	- 8.91	35.0	T4

Note:

- 1) Volume is set to maximum and LCD backlight is off during T-coil measurement.
- 2) Minimum Limit: ABM1  $\geq$ -18 dB A/m.
- 3) SNR = ABM1/ABM2.

### 13.1.3 Field Strength and Signal Quality (AWS)

Mode	Measurement Position	Channel	Probe Position	Measured Point Location (x mm/ y mm)	ABM2 (dB A/m)	ABM1 (dB A/m)	SNR (dB)	T-Rating
AWS	Acoustic	25	Axial (Z)	(- 0.5, - 1.5)	- 38.2	0.505	38.7	T4
			Radial 1 (X)	(- 10, 4.5)	- 50.7	- 6.29	44.4	T4
			Radial 2 (Y)	(2.5, 8)	- 41.4	- 4.97	36.5	T4
		450	Axial (Z)	(- 2.5, 0.5)	- 37.4	2.53	39.9	T4
			Radial 1 (X)	(6, 0.5)	- 47.5	- 7.30	40.2	T4
			Radial 2 (Y)	(0.5, 10)	- 43.8	- 8.20	35.6	T4
		875	Axial (Z)	(- 0.5, 1.5)	- 44.0	5.40	49.4	T4
			Radial 1 (X)	(- 9, - 3.5)	- 46.1	- 5.29	40.8	T4
			Radial 2 (Y)	(- 2.5, 10)	- 45.3	- 3.98	41.4	T4

Note:

- 1) Volume is set to maximum and LCD backlight is off during T-coil measurement.
- 2) Minimum Limit: ABM1  $\geq$ -18 dB A/m.
- 3) SNR = ABM1/ABM2.

## 13.2 Frequency Response

**Graph 1 : CDMA 800 (CH 1013) Frequency Response**

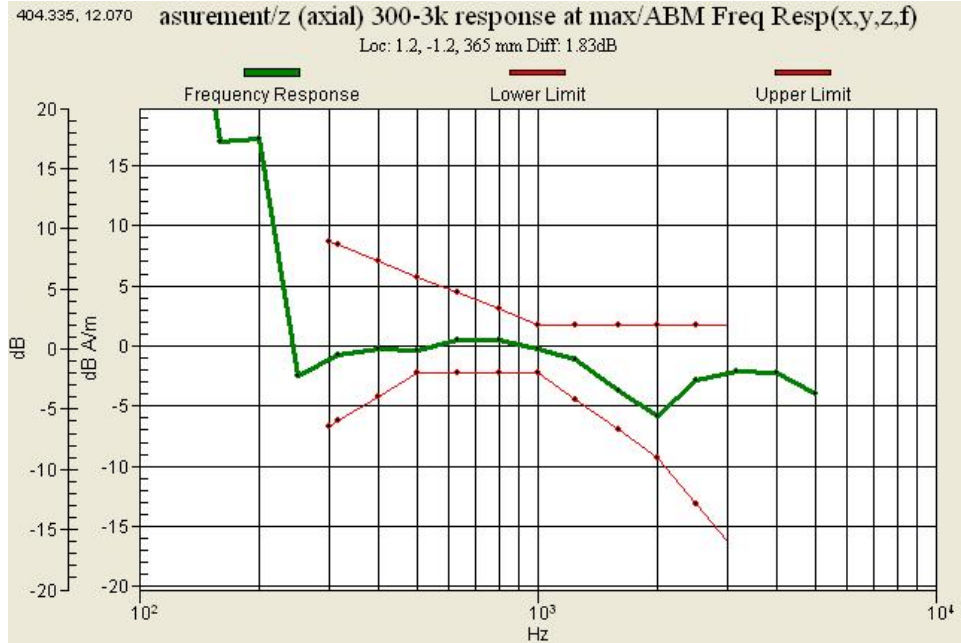

**Graph 2 : CDMA 800 (CH 384) Frequency Response**

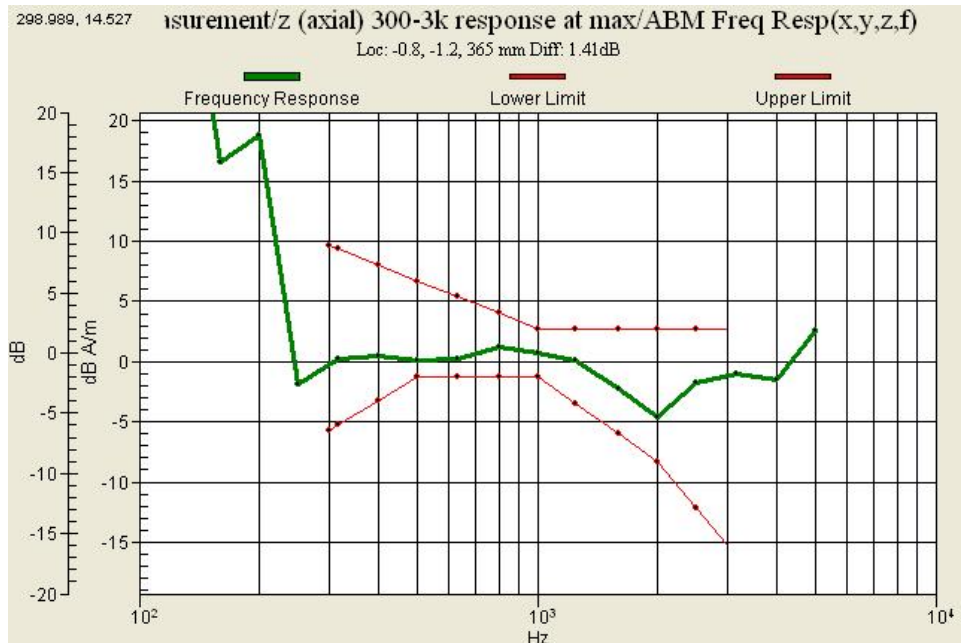

**Graph 3 : CDMA 800 (CH 777) Frequency Response**

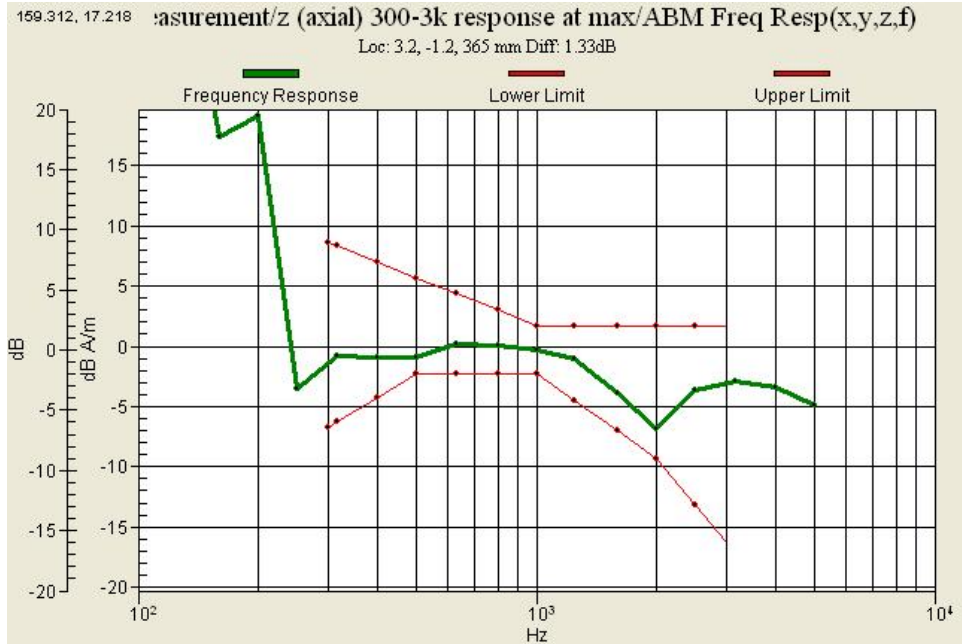

**Graph 4 : PCS 1900 (CH 25) Frequency Response**

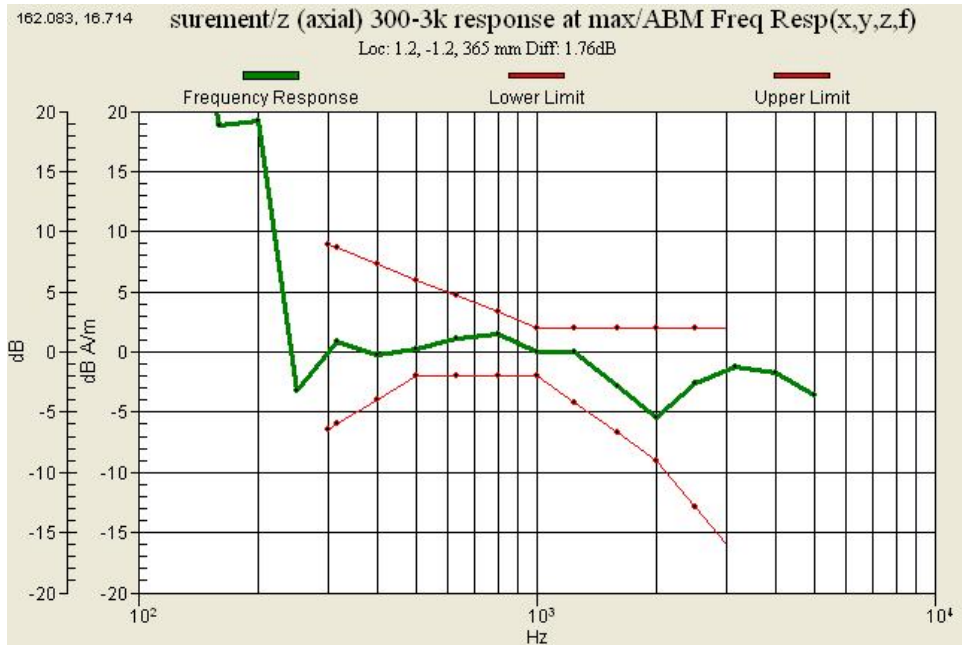



**Graph 5 : PCS 1900 (CH 600) Frequency Response**

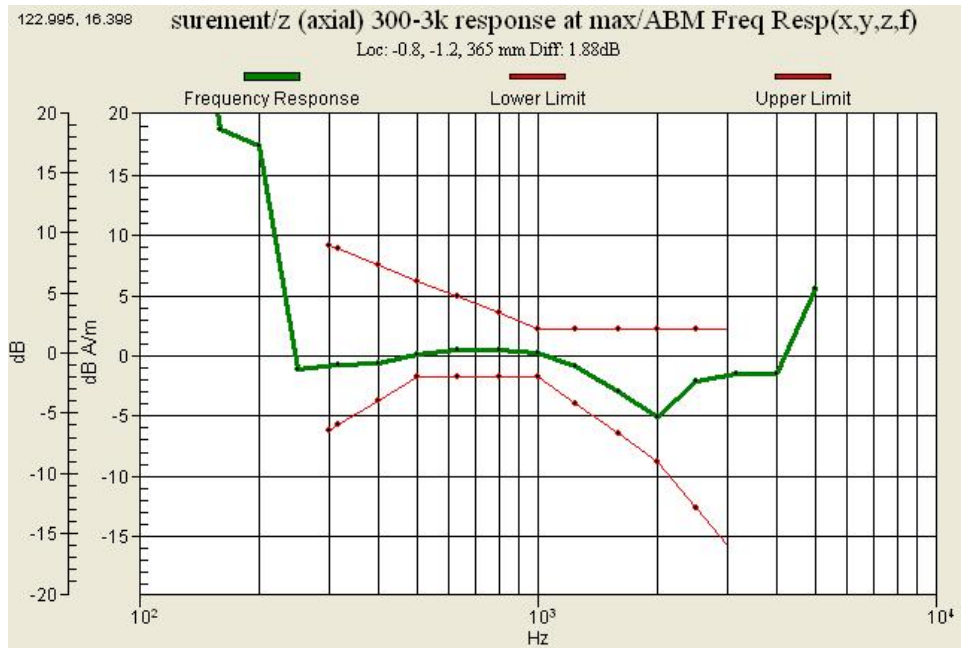

**Graph 6 : PCS 1900 (CH 1175) Frequency Response**

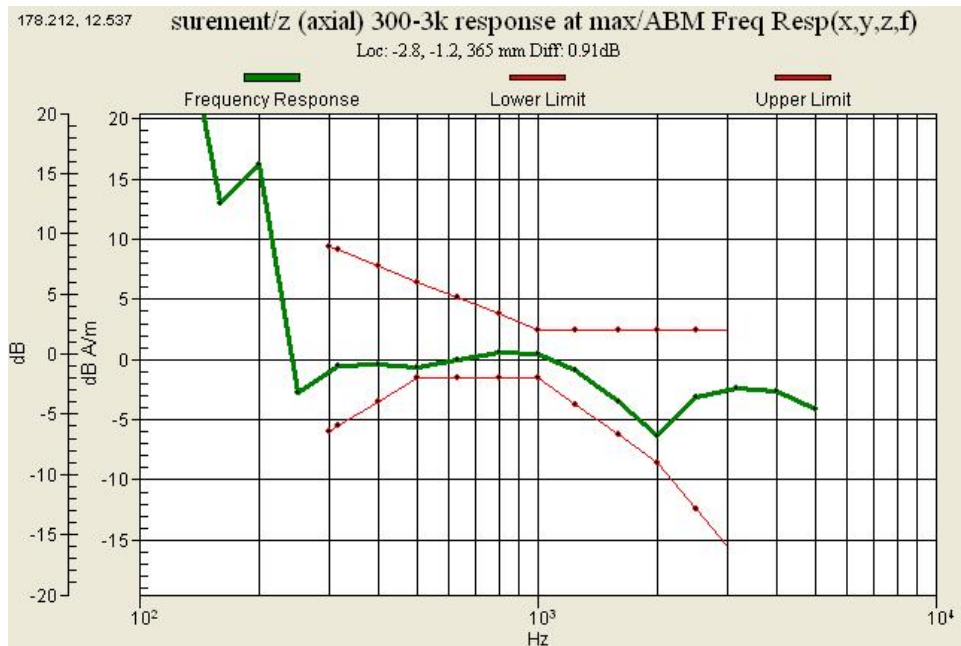

**Graph 7 : AWS 1700(CH 25) Frequency Response**

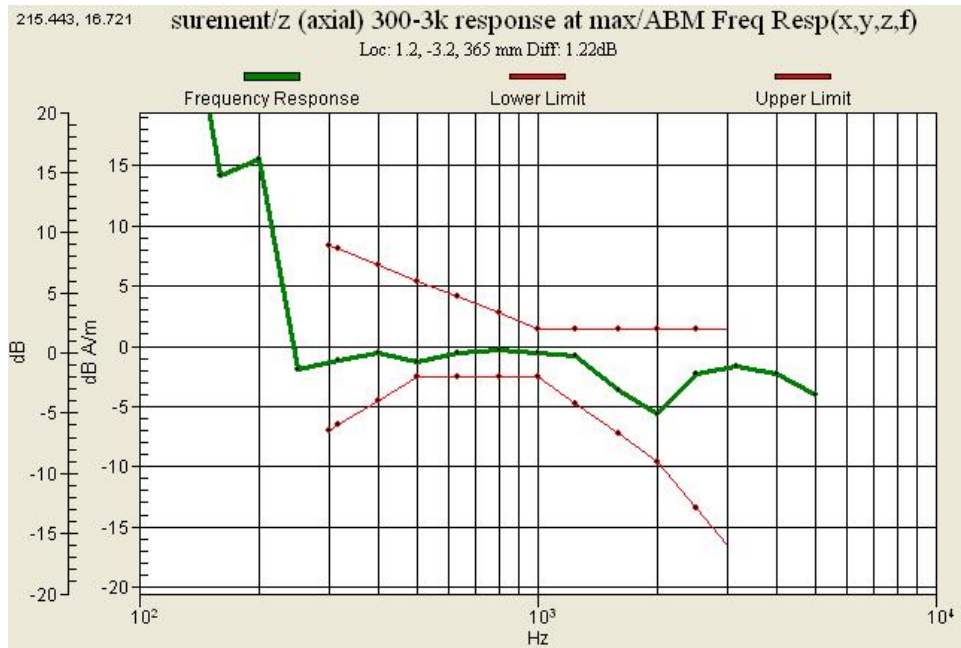

**Graph 8 : AWS 1700(CH 450) Frequency Response**

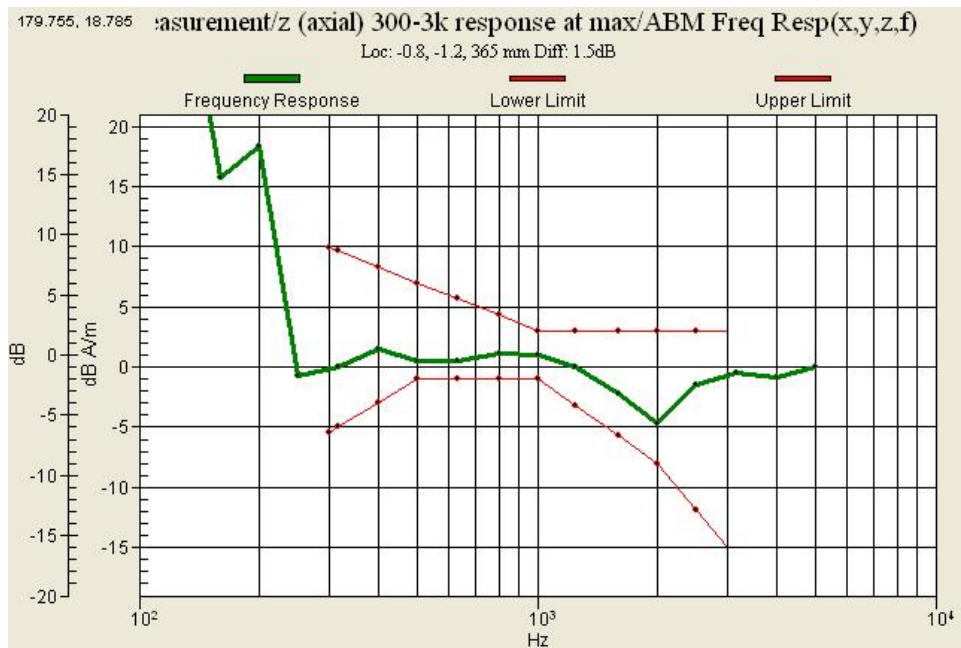

Graph 9 : AWS 1700(CH 875) Frequency Response

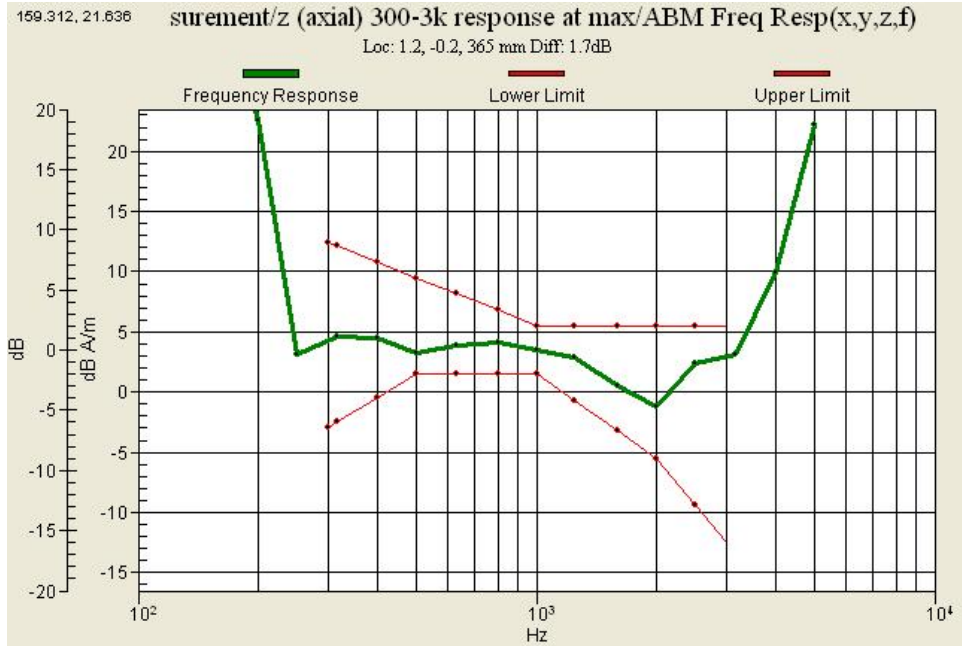

### 13.3 T-Rating Results

For each probe position and frequency band, the T-rating is determined from lower of T-coil SNR and T-coil Environment.

#### 13.3.1 T-Rating Results (CDMA)

Frequency Band (MHz)	Measurement Position	Channel	Probe Position	ABM1	Frequency Response	T-coil SNR Rating	T-rating
CDMA	Acoustic	1013	Axial(Z)	pass	pass	T4	T4
			Radial 1(X)	pass	-	T4	T4
			Radial 2(Y)	pass	-	T4	T4
		384	Axial(Z)	pass	pass	T4	T4
			Radial 1(X)	pass	-	T4	T4
			Radial 2(Y)	pass	-	T4	T4
		777	Axial(Z)	pass	pass	T4	T4
			Radial 1(X)	pass	-	T4	T4
			Radial 2(Y)	pass	-	T4	T4

This CDMA rating is the lowest category across channels and probe positions and measurement positions.

CDMA T-rating	<b>T4</b>
---------------	-----------

**13.3.2 T-Rating Results (PCS CDMA)**

Frequency Band (MHz)	Measurement Position	Channel	Probe Position	ABM1	Frequency Response	T-coil SNR Rating	T-rating
PCS CDMA	Acoustic	25	Axial(Z)	pass	pass	T4	T4
			Radial 1(X)	pass	-	T4	T4
			Radial 2(Y)	pass	-	T4	T4
		600	Axial(Z)	pass	pass	T4	T4
			Radial 1(X)	pass	-	T4	T4
			Radial 2(Y)	pass	-	T4	T4
		1175	Axial(Z)	pass	pass	T4	T4
			Radial 1(X)	pass	-	T4	T4
			Radial 2(Y)	pass	-	T4	T4

This PCS CDMA rating is the lowest category across channels and probe positions and measurement positions.

PCS CDMA T-rating	<b>T4</b>
-------------------	-----------

**13.3.3 T-Rating Results (AWS)**

Frequency Band (MHz)	Measurement Position	Channel	Probe Position	ABM1	Frequency Response	T-coil SNR Rating	T-rating
PCS CDMA	Acoustic	25	Axial(Z)	pass	pass	T4	T4
			Radial 1(X)	pass	-	T4	T4
			Radial 2(Y)	pass	-	T4	T4
		450	Axial(Z)	pass	pass	T4	T4
			Radial 1(X)	pass	-	T4	T4
			Radial 2(Y)	pass	-	T4	T4
		875	Axial(Z)	pass	pass	T4	T4
			Radial 1(X)	pass	-	T4	T4
			Radial 2(Y)	pass	-	T4	T4

This AWS CDMA rating is the lowest category across channels and probe positions and measurement positions.

AWS T-rating	<b>T4</b>
--------------	-----------

## Appendix A

### Ambient Noise Plots

**Ambient Noise Spectrum Plot Axial (Z)**

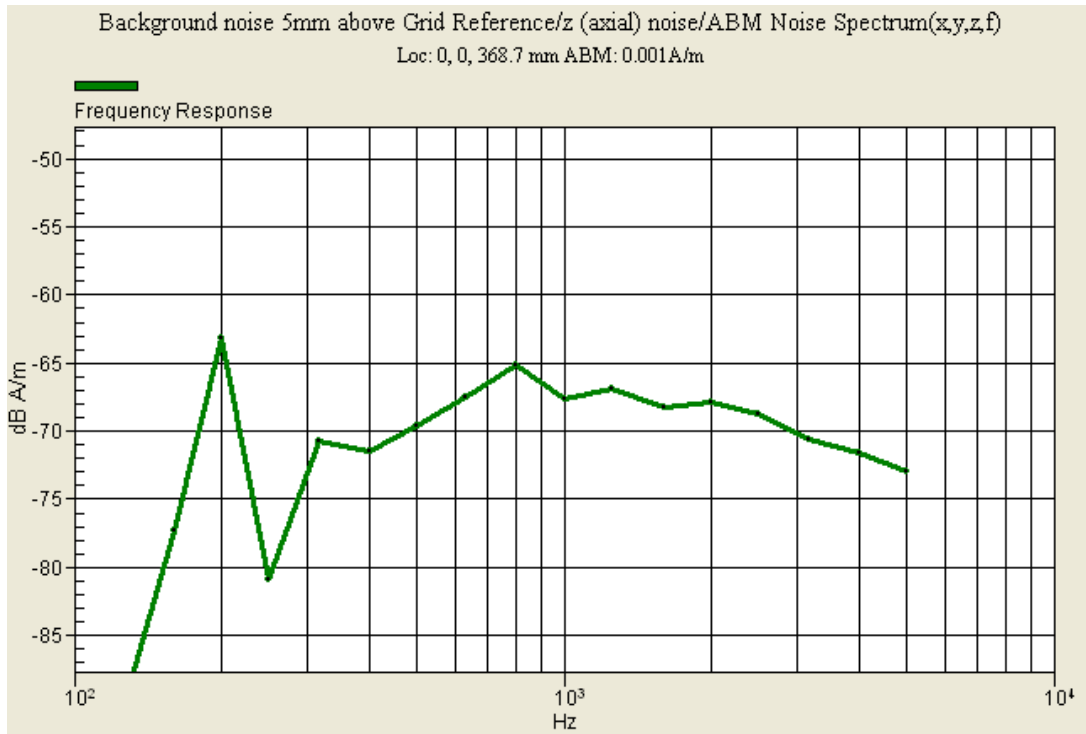

**Ambient Noise Spectrum Plot Radial (X)**

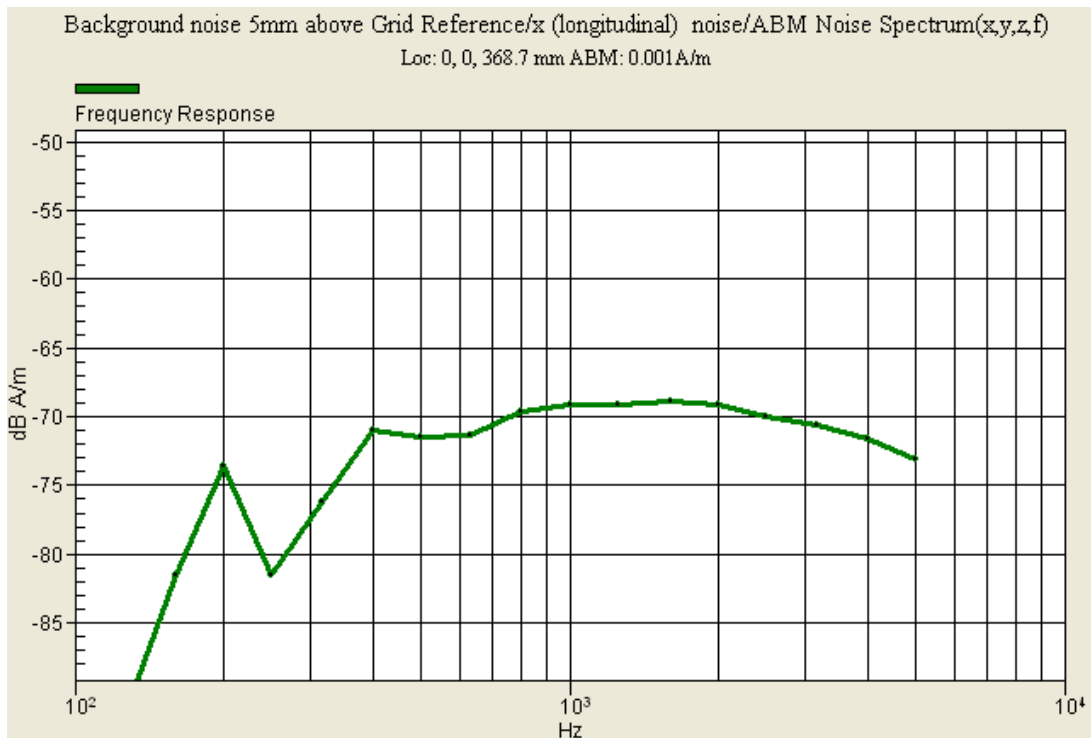



**Ambient Noise Spectrum Plot Radial (Y)**

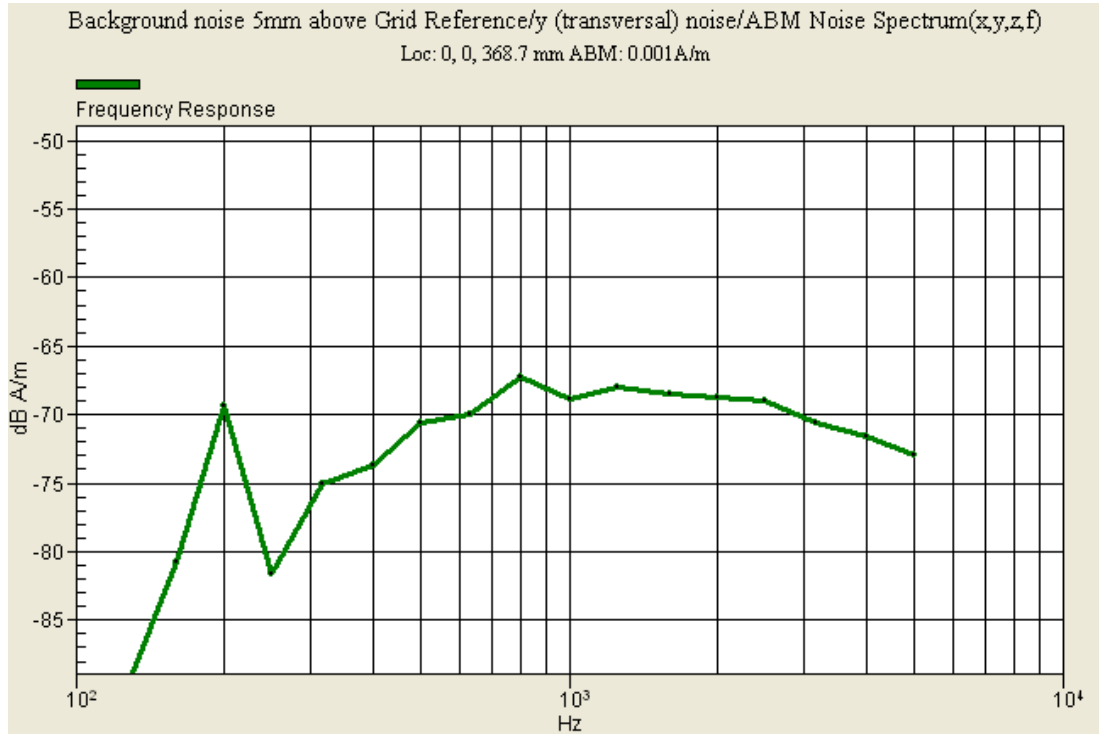

## Appendix B

### Audio Magnetic Probe Certificate



Schmid & Partner Engineering AG

**s p e a g**

Zeughausstrasse 43, 8004 Zurich, Switzerland  
Phone +41 1 245 9700, Fax +41 1 245 9779  
info@speag.com, http://www.speag.com

**Certificate of conformity**

Item	Audio Magnetic 1D Field Probe AM1DV2
Type No	<b>SP AM1 001 A</b>
Series No	1001 ff.
Manufacturer / Origin	Schmid & Partner Engineering AG Zurich, Switzerland

**Description of the item**

The Audio Magnetic Field Probe AM1DV2 is a fully RF shielded magnetic field probe for the frequency range from 100 Hz to 20 kHz. The signal from the pickup coil is amplified in a symmetric 40dB low noise amplifier and fed to a 3 pin connector at the side. Power is supplied via the same and monitored via the LED near the connector. The single sensor in the probe is arranged in a tilt angle allowing measurement of 3 orthogonal field components by rotating the probe around its axis.

**Handling of the item**

The probe is manufactured and designed for operation in air and shall not be exposed to humidity or liquids. In order to keep the performance and alignment, the probe must not be disassembled. The full performance can only be achieved using the SPEAG provided accessories and following the corresponding manual.

**Tests**

Test	Requirement	Details	Units tested
Sensor angle	Probe configuration data for alignment with field	see corresponding probe certificate	all
Dimensions	according to corresponding probe certificate	verified at delivery / light beam alignment prior to measurement usage	all / in setup by user
Frequency response	within +/- 0.5 dB of ideal differentiator from 100 Hz to 10 kHz	Coil current of AMCC measured with R&S UPL, probe including amplifier and AMMI ADC input	First article
Dynamic range	max. + 21 dB A/m @ 1 kHz Noise level typ. -70 dB A/m @ 1 kHz ABM2 typ. -60 dB A/m	with AMMI	Samples / all
Linearity	within < 0.1 dB from 5 dB below limitation to 16 dB above noise level	tested between +15 dB A/m @ 1 kHz, to -70 dB A/m @ 10 kHz	Samples
Sensitivity	typ. -24 dBV / A/m @ 1 kHz at probe output	verified at delivery / calibrated in setup prior to measurement usage	all / in setup by user
RF shielding	immunity to AM modulated RF signal	1 kHz 80 % AM	all

**Standards**

[1] ANSI PC63.19-2006 Draft 3.12

**Conformity**

Based on the tests above, we certify that this item is in compliance with the requirements of [1].

**Date** 22.5.2006

**s p e a g**

**Stamp / Signature**

Schmid & Partner Engineering AG  
Zeughausstrasse 43, 8004 Zurich, Switzerland  
Phone +41 1 245 9700, Fax +41 1 245 9779  
info@speag.com, http://www.speag.com

## Appendix C

### AMCC Certificate (Helmholz Coil)

Schmid & Partner Engineering AG

**s p e a g**

Zeughausstrasse 43, 8004 Zurich, Switzerland  
Phone +41 1 245 9700, Fax +41 1 245 9779  
info@speag.com, http://www.speag.com

**Certificate of conformity**

Item	Audio Magnetic Calibration Coil AMCC
Type No	<b>SD HAC P02 A</b>
Series No	1001 ff.
Manufacturer / Origin	Schmid & Partner Engineering AG Zurich, Switzerland

**Description of the item**

The Audio Magnetic Calibration coil (AMCC) is a Helmholtz Coil designed according to standard [1], section D.9 for calibration of the AM1D probe. Two horizontal coils are positioned above a non-metallic base plate and generate a homogeneous magnetic field in the z direction (normal to it).

**Configuration**

The AMCC consists of two parallel coils of 20 turns with radius 143 mm connected in parallel in a distance of 143 mm. With this design, a current of 10 mA produces a field of 1 A/m. The DC input resistance at the input BNC socket is adjusted by a series resistor to a DC resistance of approximately 50 Ohm. The voltage required to produce a field of 1 A/m is consequently approx. 500 mV. To current through the coil is monitored via a shunt resistor of 10 Ohm +/- 1%. The voltage is available on a BNO socket with 100 mV corresponding to 1 A/m.

**Handling of the item**

The coil shall be positioned in a non-metallic environment to avoid distortion of the magnetic field.

**Tests**

Test	Requirement	Details	Units tested
Number of turns	N = 20 per coil	Resistance measurement	all
Orientation of coils	parallel coils with same direction of windings	Magnetic field variation in the AMCC axis	all
Coil radius	r = 143 mm	mechanical dimension	First article
Coil distance	d = 143 mm distance between coil centers	mechanical dimension	First article
Input resistance	51.7 +/- 2 Ohm	DC resistance at BNC input connector	all
Shunt resistance	R = 10.0 Ohm +/- 1 %	DC resistance at BNO output connector	all
Shunt sensitivity	Hc = 1 A/m per 100 mV according to formula $Hc = (U / R) * N / r / (1.25^{1.5})$	Field measurement compared with Narda ELT400 + BN2300/90.10	First article

**Standards**

[1] ANSI PC63.19-2006 Draft 3.12

**Conformity**

Based on the tests above, we certify that this item is in compliance with the requirements of [1].

**Date** 22.5.2006

**Stamp / Signature**

**s p e a g**  
Schmid & Partner Engineering AG  
Zeughausstrasse 43, 8004 Zurich, Switzerland  
Phone +41 1 245 9700, Fax +41 1 245 9779  
info@speag.com, http://www.speag.com

## **Appendix D: HAC T-Coil Contour Plots**

(See attachment)

## **Appendix E: HAC T-Coil Setup Photos**

(See attachment)