



**SGS-CSTC Standards Technical Services Co., Ltd.  
Shenzhen Branch**

No. 1 Workshop, M-10, Middle section, Science & Technology Park, Nanshan  
District, Shenzhen, Guangdong, China 518057

Telephone: +86 (0) 755 2601 2053  
Fax: +86 (0) 755 2671 0594  
Email: ee.shenzhen@sgs.com

Report No.: SZEM150500286501  
Page: 1 of 59

## FCC REPORT

**Application No:** SZEM1505002865CR  
**Applicant:** WINNERS'SUN PLASTIC & ELECTRONIC (SHENZHEN) CO.,LTD  
**Manufacturer/ Factory:** WINNERS'SUN PLASTIC & ELECTRONIC (SHENZHEN) CO.,LTD  
**Product Name:** One Monopod  
**Model No.(EUT):** WS-SQB956  
**Trade Mark:** Dispho  
**FCC ID:** UR9WS-SQB956  
**Standards:** 47 CFR Part 15, Subpart C (2014)  
**Date of Receipt:** 2015-06-02  
**Date of Test:** 2015-06-04 to 2015-06-12  
**Date of Issue:** 2015-06-17

<b>Test Result:</b>	<b>PASS *</b>
---------------------	---------------

\* In the configuration tested, the EUT complied with the standards specified above.

Authorized Signature:



Jack Zhang  
EMC Laboratory Manager

The manufacturer should ensure that all products in series production are in conformity with the product sample detailed in this report. If the product in this report is used in any configuration other than that detailed in the report, the manufacturer must ensure the new system complies with all relevant standards. Any mention of SGS International Electrical Approvals or testing done by SGS International Electrical Approvals in connection with, distribution or use of the product described in this report must be approved by SGS International Electrical Approvals in writing.

The report must not be used by the client to claim product certification, approval, or endorsement by NVLAP, NIST, or any agency of the federal government. All test results in this report can be traceable to National or International Standards.

"This document is issued by the Company subject to its General Conditions of Service printed overleaf, available on request or accessible at [www.sgs.com/terms\\_and\\_conditions.htm](http://www.sgs.com/terms_and_conditions.htm) and, for electronic format documents, subject to Terms and Conditions for Electronic Documents at [www.sgs.com/terms\\_e-document.htm](http://www.sgs.com/terms_e-document.htm). Attention is drawn to the limitation of liability, indemnification and jurisdiction issues defined therein. Any holder of this document is advised that information contained hereon reflects the Company's findings at the time of its intervention only and within the limits of Client's instructions, if any. The Company's sole responsibility is to its Client and this document does not exonerate parties to a transaction from exercising all their rights and obligations under the transaction documents. This document cannot be reproduced except in full, without prior written approval of the Company. Any unauthorized alteration, forgery or falsification of the content or appearance of this document is unlawful and offenders may be prosecuted to the fullest extent of the law. Unless otherwise stated the results shown in this test report refer only to the sample(s) tested and such sample(s) are retained for 90 days only."



## 2 Version

<b>Revision Record</b>				
<b>Version</b>	<b>Chapter</b>	<b>Date</b>	<b>Modifier</b>	<b>Remark</b>
00		2015-06-17		Original

Authorized for issue by:			
Tested By		2015-06-12	Date
	(Eric Fu) /Project Engineer		
Prepared By		2015-06-17	Date
	(Jade Chen) /Clerk		
Checked By		2015-06-17	Date
	(Emen Li) /Reviewer		

### 3 Test Summary

Test Item	Test Requirement	Test method	Result
<b>Antenna Requirement</b>	47 CFR Part 15, Subpart C Section 15.203/15.247 (c)	ANSI C63.10 (2009)	PASS
<b>AC Power Line Conducted Emission</b>	47 CFR Part 15, Subpart C Section 15.207	ANSI C63.10 (2009)	PASS
<b>Conducted Peak Output Power</b>	47 CFR Part 15, Subpart C Section 15.247 (b)(1)	ANSI C63.10 (2009)	PASS
<b>20dB Occupied Bandwidth</b>	47 CFR Part 15, Subpart C Section 15.247 (a)(1)	ANSI C63.10 (2009)	PASS
<b>Carrier Frequencies Separation</b>	47 CFR Part 15, Subpart C Section 15.247 (a)(1)	ANSI C63.10 (2009)	PASS
<b>Hopping Channel Number</b>	47 CFR Part 15, Subpart C Section 15.247 (a)(1)	ANSI C63.10 (2009)	PASS
<b>Dwell Time</b>	47 CFR Part 15, Subpart C Section 15.247 (a)(1)	ANSI C63.10 (2009)	PASS
<b>Pseudorandom Frequency Hopping Sequence</b>	47 CFR Part 15, Subpart C Section 15.247(b)(4)&TCB Exclusion List (7 July 2002)	ANSI C63.10 (2009)	PASS
<b>Band-edge for RF Conducted Emissions</b>	47 CFR Part 15, Subpart C Section 15.247(d)	ANSI C63.10 (2009)	PASS
<b>RF Conducted Spurious Emissions</b>	47 CFR Part 15, Subpart C Section 15.247(d)	ANSI C63.10 (2009)	PASS
<b>Radiated Spurious emissions</b>	47 CFR Part 15, Subpart C Section 15.205/15.209	ANSI C63.10 (2009)	PASS
<b>Restricted bands around fundamental frequency (Radiated Emission)</b>	47 CFR Part 15, Subpart C Section 15.205/15.209	ANSI C63.10 (2009)	PASS

Remark:

Model No.: WS-SQB956

The model has many different kind of color. Since the circuitry design, PCB layout, electrical components used, internal wiring and functions were identical. Only different on color.



## 4 Contents

	Page
<b>1 COVER PAGE .....</b>	<b>1</b>
<b>2 VERSION .....</b>	<b>2</b>
<b>3 TEST SUMMARY .....</b>	<b>3</b>
<b>4 CONTENTS .....</b>	<b>4</b>
<b>5 GENERAL INFORMATION .....</b>	<b>5</b>
5.1 CLIENT INFORMATION .....	5
5.2 GENERAL DESCRIPTION OF EUT .....	5
5.3 TEST ENVIRONMENT .....	7
5.4 DESCRIPTION OF SUPPORT UNITS .....	7
5.5 TEST LOCATION .....	7
5.6 TEST FACILITY .....	8
5.7 DEVIATION FROM STANDARDS .....	8
5.8 ABNORMALITIES FROM STANDARD CONDITIONS .....	8
5.9 OTHER INFORMATION REQUESTED BY THE CUSTOMER .....	8
5.10 EQUIPMENT LIST .....	9
<b>6 TEST RESULTS AND MEASUREMENT DATA .....</b>	<b>11</b>
6.1 ANTENNA REQUIREMENT .....	11
6.2 CONDUCTED PEAK OUTPUT POWER .....	12
6.3 20dB OCCUPY BANDWIDTH .....	16
6.4 CARRIER FREQUENCIES SEPARATION .....	19
6.5 HOPPING CHANNEL NUMBER .....	23
6.6 DWELL TIME .....	25
6.7 BAND-EDGE FOR RF CONDUCTED EMISSIONS .....	30
6.8 SPURIOUS RF CONDUCTED EMISSIONS .....	33
6.9 OTHER REQUIREMENTS FREQUENCY HOPPING SPREAD SPECTRUM SYSTEM .....	42
6.10 RADIATED SPURIOUS EMISSION .....	44
6.10.1 Radiated Emission below 1GHz .....	47
6.10.2 Transmitter Emission above 1GHz .....	49
6.11 RESTRICTED BANDS AROUND FUNDAMENTAL FREQUENCY .....	52
<b>7 PHOTOGRAPHS - EUT TEST SETUP .....</b>	<b>58</b>
7.1 RADIATED EMISSION .....	58
7.2 RADIATED SPURIOUS EMISSION .....	58
<b>8 PHOTOGRAPHS - EUT CONSTRUCTIONAL DETAILS .....</b>	<b>59</b>



## 5 General Information

### 5.1 Client Information

Applicant:	WINNERS'SUN PLASTIC & ELECTRONIC (SHENZHEN) CO.,LTD
Address of Applicant:	Bld E, Dalang Yingtai Industrial Zone, Longhua Town, Bao'an Dist, Shenzhen, China
Manufacturer:	WINNERS'SUN PLASTIC & ELECTRONIC (SHENZHEN) CO.,LTD
Address of Manufacturer:	Bld E, Dalang Yingtai Industrial Zone, Longhua Town, Bao'an Dist, Shenzhen, China
Factory:	WINNERS'SUN PLASTIC & ELECTRONIC (SHENZHEN) CO.,LTD
Address of Factory:	Bld E, Dalang Yingtai Industrial Zone, Longhua Town, Bao'an Dist, Shenzhen, China

### 5.2 General Description of EUT

Product Name:	One Monopod
Model No.:	WS-SQB956
Trade Mark:	Dispho
Operation Frequency:	2402MHz~2480MHz
Bluetooth Version:	V3.0
Modulation Technique:	Frequency Hopping Spread Spectrum(FHSS)
Modulation Type:	GFSK
Number of Channel:	79
Hopping Channel Type:	Adaptive Frequency Hopping systems
Sample Type:	Portable production
Test Power Grade:	Class II (manufacturer declare )
Test Software of EUT:	Blue Tool (manufacturer declare )
Antenna Type:	Integral
Antenna Gain:	0dBi
Battery :	CR2025L 3.0V



Operation Frequency each of channel							
Channel	Frequency	Channel	Frequency	Channel	Frequency	Channel	Frequency
1	2402MHz	21	2422MHz	41	2442MHz	61	2462MHz
2	2403MHz	22	2423MHz	42	2443MHz	62	2463MHz
3	2404MHz	23	2424MHz	43	2444MHz	63	2464MHz
4	2405MHz	24	2425MHz	44	2445MHz	64	2465MHz
5	2406MHz	25	2426MHz	45	2446MHz	65	2466MHz
6	2407MHz	26	2427MHz	46	2447MHz	66	2467MHz
7	2408MHz	27	2428MHz	47	2448MHz	67	2468MHz
8	2409MHz	28	2429MHz	48	2449MHz	68	2469MHz
9	2410MHz	29	2430MHz	49	2450MHz	69	2470MHz
10	2411MHz	30	2431MHz	50	2451MHz	70	2471MHz
11	2412MHz	31	2432MHz	51	2452MHz	71	2472MHz
12	2413MHz	32	2433MHz	52	2453MHz	72	2473MHz
13	2414MHz	33	2434MHz	53	2454MHz	73	2474MHz
14	2415MHz	34	2435MHz	54	2455MHz	74	2475MHz
15	2416MHz	35	2436MHz	55	2456MHz	75	2476MHz
16	2417MHz	36	2437MHz	56	2457MHz	76	2477MHz
17	2418MHz	37	2438MHz	57	2458MHz	77	2478MHz
18	2419MHz	38	2439MHz	58	2459MHz	78	2479MHz
19	2420MHz	39	2440MHz	59	2460MHz	79	2480MHz
20	2421MHz	40	2441MHz	60	2461MHz		

**Note:**

In section 15.31(m), regards to the operating frequency range over 10 MHz, the Lowest frequency, the middle frequency, and the highest frequency of channel were selected to perform the test, and the selected channel see below:

Channel	Frequency
The Lowest channel	2402MHz
The Middle channel	2441MHz
The Highest channel	2480MHz



"This document is issued by the Company subject to its General Conditions of Service printed overleaf, available on request or accessible at [www.sgs.com/terms\\_and\\_conditions.htm](http://www.sgs.com/terms_and_conditions.htm) and, for electronic format documents, subject to Terms and Conditions for Electronic Documents at [www.sgs.com/terms\\_e-document.htm](http://www.sgs.com/terms_e-document.htm). Attention is drawn to the limitation of liability, indemnification and jurisdiction issues defined therein. Any holder of this document is advised that information contained hereon reflects the Company's findings at the time of its intervention only and within the limits of Client's instructions, if any. The Company's sole responsibility is to its Client and this document does not exonerate parties to a transaction from exercising all their rights and obligations under the transaction documents. This document cannot be reproduced except in full, without prior written approval of the Company. Any unauthorized alteration, forgery or falsification of the content or appearance of this document is unlawful and offenders may be prosecuted to the fullest extent of the law. Unless otherwise stated the results shown in this test report refer only to the sample(s) tested and such sample(s) are retained for 90 days only."



### 5.3 Test Environment

Operating Environment:	
Temperature:	25.0 °C
Humidity:	53 % RH
Atmospheric Pressure:	1010mbar

### 5.4 Description of Support Units

The EUT has been tested independent unit.

### 5.5 Test Location

All tests were performed at:

SGS-CSTC Standards Technical Services Co., Ltd., Shenzhen Branch E&E Lab,  
No. 1 Workshop, M-10, Middle Section, Science & Technology Park, Shenzhen, Guangdong, China.  
518057.

Tel: +86 755 2601 2053 Fax: +86 755 2671 0594

No tests were sub-contracted.

## 5.6 Test Facility

The test facility is recognized, certified, or accredited by the following organizations:

- **CNAS (No. CNAS L2929)**

CNAS has accredited SGS-CSTC Standards Technical Services Co., Ltd. Shenzhen Branch EMC Lab to ISO/IEC 17025:2005 General Requirements for the Competence of Testing and Calibration Laboratories (CNAS-CL01 Accreditation Criteria for the Competence of Testing and Calibration Laboratories) for the competence in the field of testing.

- **VCCI**

The 10m Semi-anechoic chamber and Shielded Room (7.5m x 4.0m x 3.0m) of SGS-CSTC Standards Technical Services Co., Ltd. have been registered in accordance with the Regulations for Voluntary Control Measures with Registration No.: G-823, R-4188, T-1153 and C-2383 respectively.

- **FCC – Registration No.: 556682**

SGS-CSTC Standards Technical Services Co., Ltd., Shenzhen EMC Laboratory has been registered and fully described in a report filed with the (FCC) Federal Communications Commission. The acceptance letter from the FCC is maintained in our files. Registration No.: 556682.

- **Industry Canada (IC)**

Two 3m Semi-anechoic chambers of SGS-CSTC Standards Technical Services Co., Ltd. have been registered by Certification and Engineering Bureau of Industry Canada for radio equipment testing with Registration No.: 4620C-1 & 4620C-2.

## 5.7 Deviation from Standards

None.

## 5.8 Abnormalities from Standard Conditions

None.

## 5.9 Other Information Requested by the Customer

None.



### 5.10 Equipment List

RE in Chamber					
Item	Test Equipment	Manufacturer	Model No.	Inventory No.	Cal.Due date (yyyy-mm-dd)
1	3m Semi-Anechoic Chamber	ETS-LINDGREN	N/A	SEL0017	2016-05-13
2	EMI Test Receiver	Agilent Technologies	N9038A	SEL0312	2015-09-16
3	EMI Test software	AUDIX	E3	SEL0050	N/A
4	BiConiLog Antenna (26-3000MHz)	ETS-LINDGREN	3142C	SEL0015	2015-10-24
5	Double-ridged horn (1-18GHz)	ETS-LINDGREN	3117	SEL0006	2015-10-24
6	Horn Antenna (18-26GHz)	ETS-LINDGREN	3160	SEL0076	2015-10-24
7	Pre-amplifier (0.1-1300MHz)	Agilent Technologies	8447D	SEL0053	2016-05-13
8	Pre-Amplifier (0.1-26.5GHz)	Compliance Directions Systems Inc.	PAP-0126	SEL0168	2015-10-24
9	Coaxial cable	SGS	N/A	SEL0027	2016-05-13
10	Coaxial cable	SGS	N/A	SEL0189	2016-05-13
11	Coaxial cable	SGS	N/A	SEL0121	2016-05-13
12	Coaxial cable	SGS	N/A	SEL0178	2016-05-13
13	Band filter	Amindeon	82346	SEL0094	2016-05-13
14	Barometer	Chang Chun	DYM3	SEL0088	2016-05-13
15	DC Power Supply	Zhao Xin	RXN-305D	SEL0117	2015-10-24
16	Humidity/ Temperature Indicator	Shanghai Qixiang	ZJ1-2B	SEL0103	2015-10-24
17	Signal Generator (10M-27GHz)	Rohde & Schwarz	SMR27	SEL0067	2016-05-13
18	Signal Generator	Rohde & Schwarz	SMY01	SEL0155	2015-10-24
19	Loop Antenna	Beijing Daze	ZN30401	SEL0203	2016-05-13

"This document is issued by the Company subject to its General Conditions of Service printed overleaf, available on request or accessible at [www.sgs.com/terms\\_and\\_conditions.htm](http://www.sgs.com/terms_and_conditions.htm) and, for electronic format documents, subject to Terms and Conditions for Electronic Documents at [www.sgs.com/terms\\_e-document.htm](http://www.sgs.com/terms_e-document.htm). Attention is drawn to the limitation of liability, indemnification and jurisdiction issues defined therein. Any holder of this document is advised that information contained hereon reflects the Company's findings at the time of its intervention only and within the limits of Client's instructions, if any. The Company's sole responsibility is to its Client and this document does not exonerate parties to a transaction from exercising all their rights and obligations under the transaction documents. This document cannot be reproduced except in full, without prior written approval of the Company. Any unauthorized alteration, forgery or falsification of the content or appearance of this document is unlawful and offenders may be prosecuted to the fullest extent of the law. Unless otherwise stated the results shown in this test report refer only to the sample(s) tested and such sample(s) are retained for 90 days only."



**SGS-CSTC Standards Technical Services Co., Ltd.**  
**Shenzhen Branch**

Report No.: SZEM150500286501

Page: 10 of 59

RF connected test					
Item	Test Equipment	Manufacturer	Model No.	Inventory No.	Cal.Due date (yyyy-mm-dd)
1	DC Power Supply	Zhao Xin	RXN-305D	SEL0117	2015-10-24
2	Humidity/ Temperature Indicator	HYGRO	ZJ1-2B	SEL0033	2015-10-24
3	Spectrum Analyzer	Rohde & Schwarz	FSP	SEL0154	2015-10-24
4	Coaxial cable	SGS	N/A	SEL0178	2016-05-13
5	Coaxial cable	SGS	N/A	SEL0179	2016-05-13
6	Barometer	ChangChun	DYM3	SEL0088	2016-05-13
7	Signal Generator	Rohde & Schwarz	SML03	SEL0068	2016-04-25
8	Band filter	amideon	82346	SEL0094	2016-05-13
9	POWER METER	R & S	NRVS	SEL0144	2015-10-24
10	Attenuator	Beijin feihang taida	TST-2-6dB	SEL0205	2016-04-25
11	Power Divider(splitter)	Agilent Technologies	11636B	SEL0130	2015-10-24

Note: The calibration interval is one year, all the instruments are valid.

## 6 Test results and Measurement Data

### 6.1 Antenna Requirement

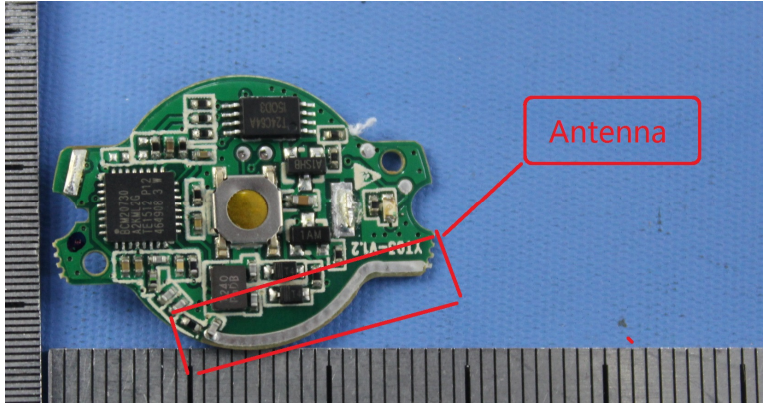
<b>Standard requirement:</b>	47 CFR Part 15C Section 15.203 /247(c)
<p>15.203 requirement:            An intentional radiator shall be designed to ensure that no antenna other than that furnished by the responsible party shall be used with the device. The use of a permanently attached antenna or of an antenna that uses a unique coupling to the intentional radiator, the manufacturer may design the unit so that a broken antenna can be replaced by the user, but the use of a standard antenna jack or electrical connector is prohibited.</p> <p>15.247(b) (4) requirement:            The conducted output power limit specified in paragraph (b) of this section is based on the use of antennas with directional gains that do not exceed 6 dBi. Except as shown in paragraph (c) of this section, if transmitting antennas of directional gain greater than 6 dBi are used, the conducted output power from the intentional radiator shall be reduced below the stated values in paragraphs (b)(1), (b)(2), and (b)(3) of this section, as appropriate, by the amount in dB that the directional gain of the antenna exceeds 6 dBi.</p>	
<b>EUT Antenna:</b>	
<p>The antenna is integrated on the main PCB and no consideration of replacement. The best case gain of the antenna is 0dBi.</p>	

## 6.2 Conducted Peak Output Power

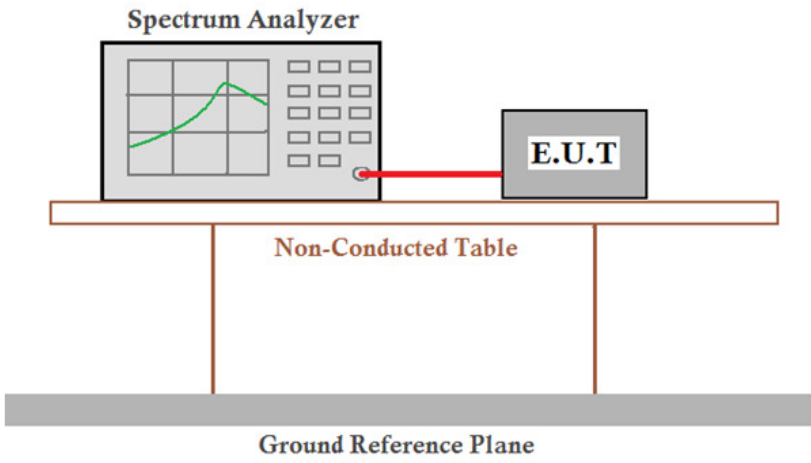
Test Requirement:	47 CFR Part 15C Section 15.247 (b)(1)
Test Method:	ANSI C63.10:2009
Test Setup:	 <p><i>Remark:</i>  Offset the High-Frequency cable loss 1.5dB in the spectrum analyzer.</p>
Limit:	30dBm
Exploratory Test Mode:	Non-hopping transmitting with all kind of data type
Final Test Mode:	Through Pre-scan, find the DH1 of data type is the worst case of GFSK modulation type.
Instruments Used:	Refer to section 5.10 for details
Test Results:	Pass



**Measurement Data**

GFSK mode			
Test channel	Peak Output Power (dBm)	Limit (dBm)	Result
Lowest	-2.69	30.00	Pass
Middle	-3.96	30.00	Pass
Highest	-5.17	30.00	Pass



Test plot as follows:

Test mode:	GFSK	Test channel:	Lowest
------------	------	---------------	--------

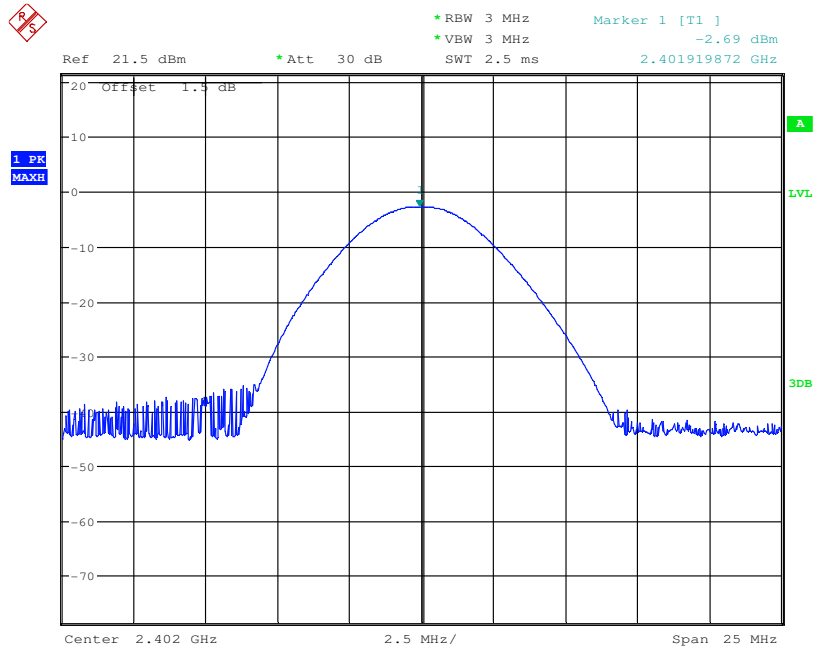

Test mode:	GFSK	Test channel:	Middle
------------	------	---------------	--------

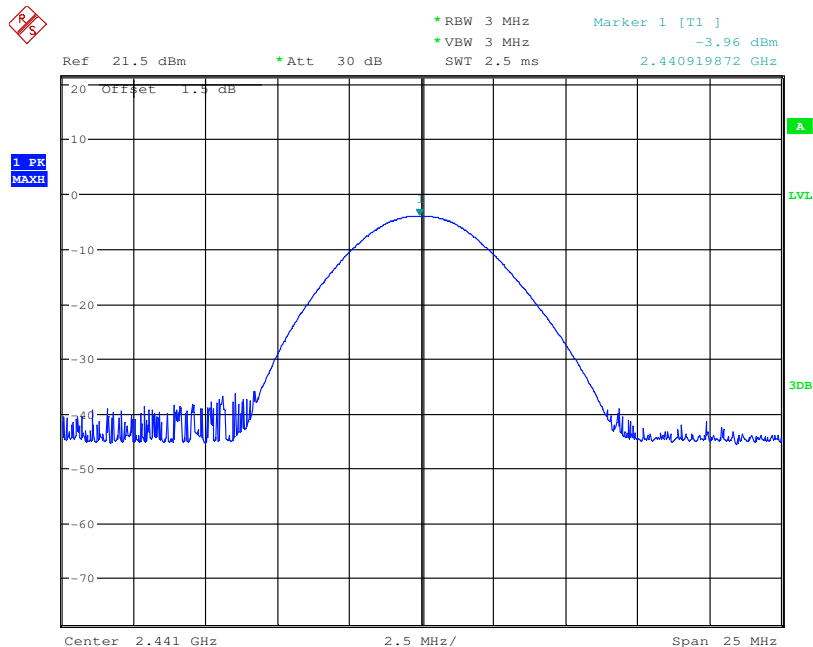

"This document is issued by the Company subject to its General Conditions of Service printed overleaf, available on request or accessible at [www.sgs.com/terms\\_and\\_conditions.htm](http://www.sgs.com/terms_and_conditions.htm) and, for electronic format documents, subject to Terms and Conditions for Electronic Documents at [www.sgs.com/terms\\_e-document.htm](http://www.sgs.com/terms_e-document.htm). Attention is drawn to the limitation of liability, indemnification and jurisdiction issues defined therein. Any holder of this document is advised that information contained hereon reflects the Company's findings at the time of its intervention only and within the limits of Client's instructions, if any. The Company's sole responsibility is to its Client and this document does not exonerate parties to a transaction from exercising all their rights and obligations under the transaction documents. This document cannot be reproduced except in full, without prior written approval of the Company. Any unauthorized alteration, forgery or falsification of the content or appearance of this document is unlawful and offenders may be prosecuted to the fullest extent of the law. Unless otherwise stated the results shown in this test report refer only to the sample(s) tested and such sample(s) are retained for 90 days only."



Test mode:	GFSK	Test channel:	Highest
------------	------	---------------	---------

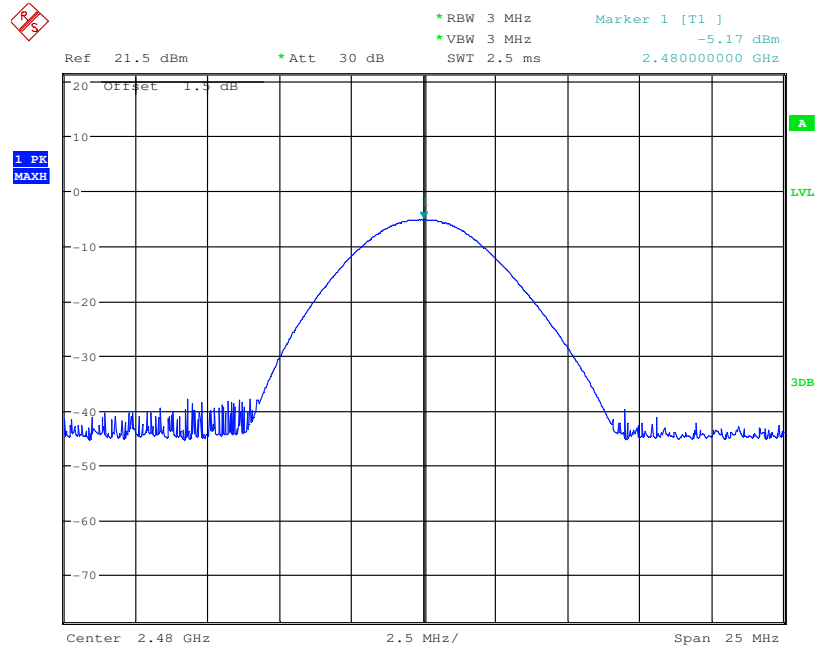

"This document is issued by the Company subject to its General Conditions of Service printed overleaf, available on request or accessible at [www.sgs.com/terms\\_and\\_conditions.htm](http://www.sgs.com/terms_and_conditions.htm) and, for electronic format documents, subject to Terms and Conditions for Electronic Documents at [www.sgs.com/terms\\_e-document.htm](http://www.sgs.com/terms_e-document.htm). Attention is drawn to the limitation of liability, indemnification and jurisdiction issues defined therein. Any holder of this document is advised that information contained hereon reflects the Company's findings at the time of its intervention only and within the limits of Client's instructions, if any. The Company's sole responsibility is to its Client and this document does not exonerate parties to a transaction from exercising all their rights and obligations under the transaction documents. This document cannot be reproduced except in full, without prior written approval of the Company. Any unauthorized alteration, forgery or falsification of the content or appearance of this document is unlawful and offenders may be prosecuted to the fullest extent of the law. Unless otherwise stated the results shown in this test report refer only to the sample(s) tested and such sample(s) are retained for 90 days only."

### 6.3 20dB Occupy Bandwidth

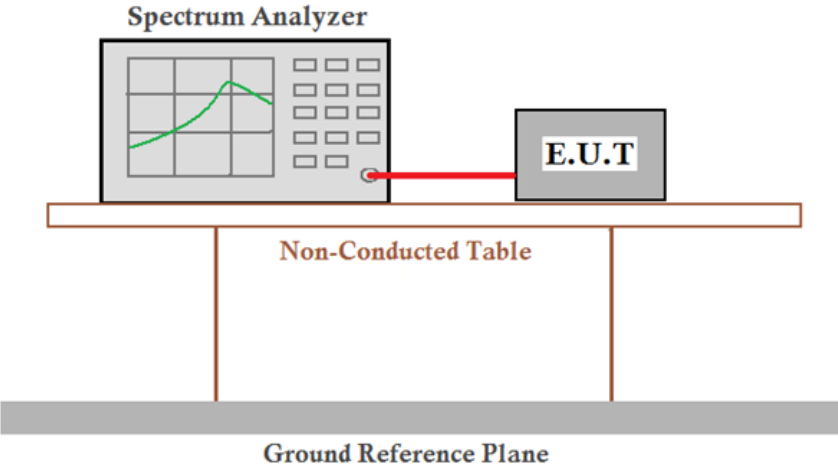
Test Requirement:	47 CFR Part 15C Section 15.247 (a)(1)
Test Method:	ANSI C63.10:2009
Test Setup:	
Limit:	NA
Exploratory Test Mode:	Non-hopping transmitting with all kind of data type
Final Test Mode:	Through Pre-scan, find the DH1 of data type is the worst case of GFSK modulation type.
Instruments Used:	Refer to section 5.10 for details
Test Results:	Pass

#### Measurement Data

Test channel	20dB Occupy Bandwidth (kHz)
	GFSK
Lowest	1052.885
Middle	1052.885
Highest	1048.077







Test plot as follows:

Test mode:	GFSK	Test channel:	Lowest
------------	------	---------------	--------

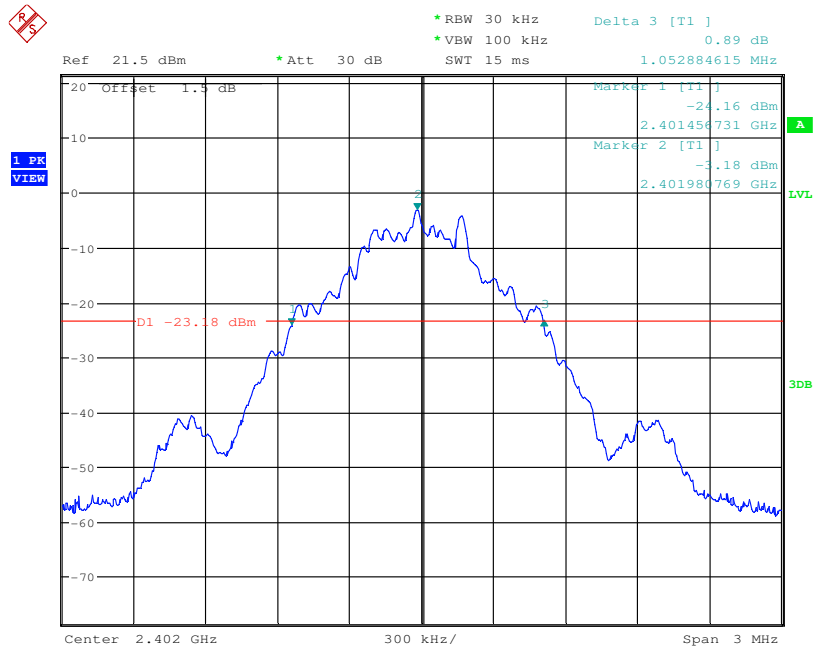

Test mode:	GFSK	Test channel:	Middle
------------	------	---------------	--------

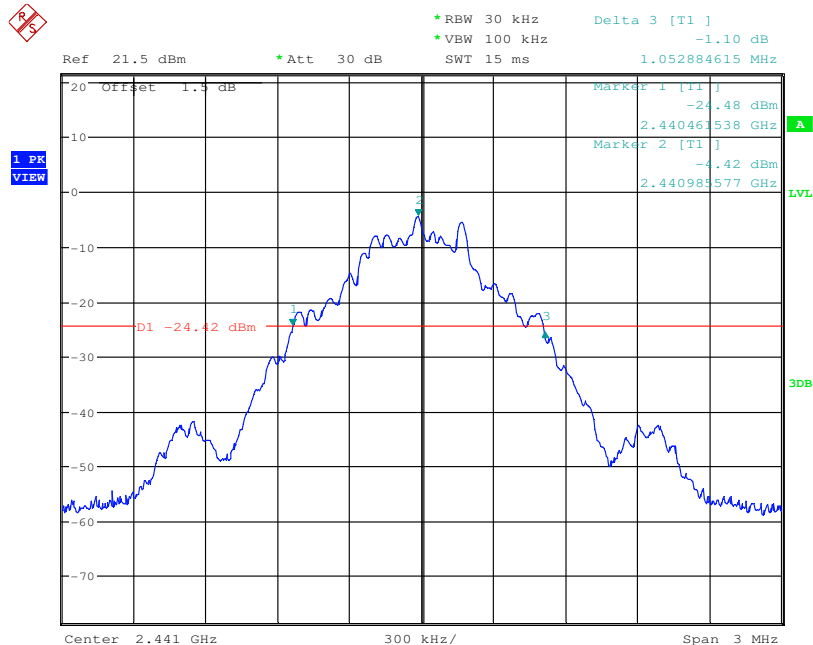

"This document is issued by the Company subject to its General Conditions of Service printed overleaf, available on request or accessible at [www.sgs.com/terms\\_and\\_conditions.htm](http://www.sgs.com/terms_and_conditions.htm) and, for electronic format documents, subject to Terms and Conditions for Electronic Documents at [www.sgs.com/terms\\_e-document.htm](http://www.sgs.com/terms_e-document.htm). Attention is drawn to the limitation of liability, indemnification and jurisdiction issues defined therein. Any holder of this document is advised that information contained hereon reflects the Company's findings at the time of its intervention only and within the limits of Client's instructions, if any. The Company's sole responsibility is to its Client and this document does not exonerate parties to a transaction from exercising all their rights and obligations under the transaction documents. This document cannot be reproduced except in full, without prior written approval of the Company. Any unauthorized alteration, forgery or falsification of the content or appearance of this document is unlawful and offenders may be prosecuted to the fullest extent of the law. Unless otherwise stated the results shown in this test report refer only to the sample(s) tested and such sample(s) are retained for 90 days only."



Test mode:	GFSK	Test channel:	Highest
------------	------	---------------	---------

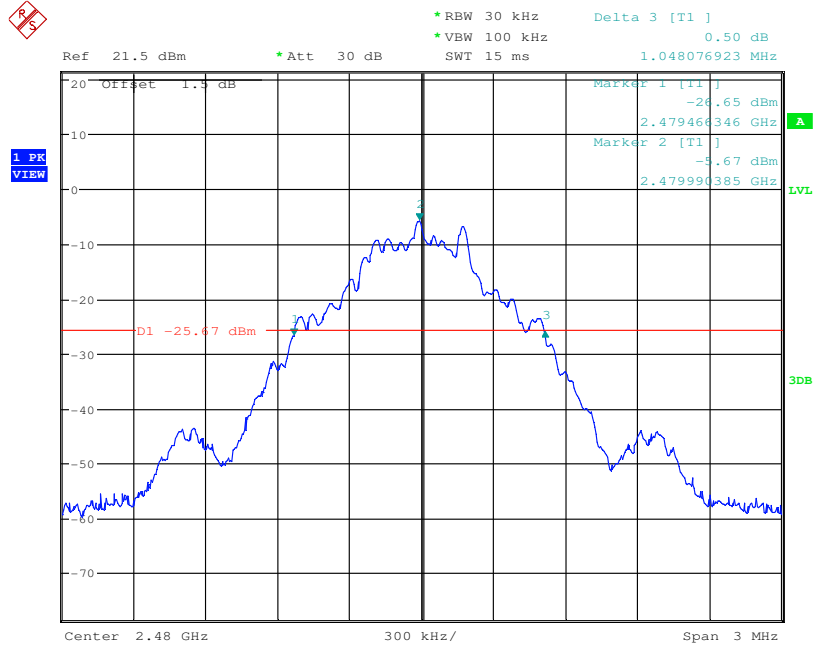

"This document is issued by the Company subject to its General Conditions of Service printed overleaf, available on request or accessible at [www.sgs.com/terms\\_and\\_conditions.htm](http://www.sgs.com/terms_and_conditions.htm) and, for electronic format documents, subject to Terms and Conditions for Electronic Documents at [www.sgs.com/terms\\_e-document.htm](http://www.sgs.com/terms_e-document.htm). Attention is drawn to the limitation of liability, indemnification and jurisdiction issues defined therein. Any holder of this document is advised that information contained hereon reflects the Company's findings at the time of its intervention only and within the limits of Client's instructions, if any. The Company's sole responsibility is to its Client and this document does not exonerate parties to a transaction from exercising all their rights and obligations under the transaction documents. This document cannot be reproduced except in full, without prior written approval of the Company. Any unauthorized alteration, forgery or falsification of the content or appearance of this document is unlawful and offenders may be prosecuted to the fullest extent of the law. Unless otherwise stated the results shown in this test report refer only to the sample(s) tested and such sample(s) are retained for 90 days only."

## 6.4 Carrier Frequencies Separation

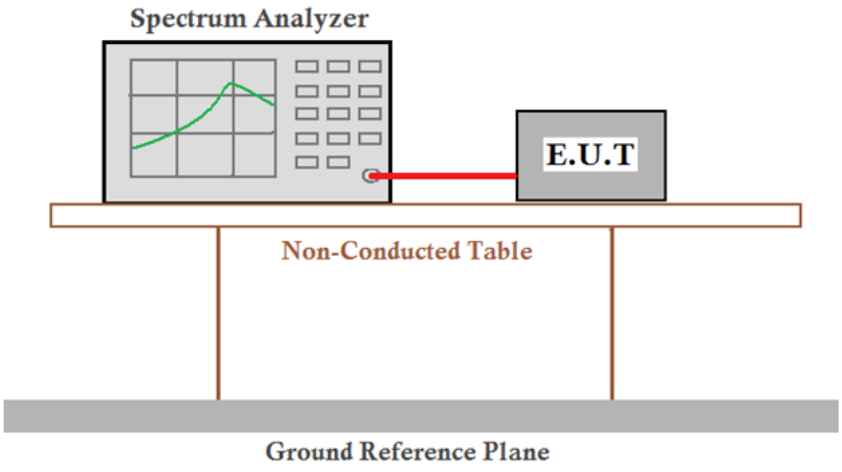
Test Requirement:	47 CFR Part 15C Section 15.247 (a)(1)
Test Method:	ANSI C63.10:2009
Test Setup:	 <p>The diagram illustrates the test setup. A Spectrum Analyzer is connected to an E.U.T. (Equipment Under Test) via a red cable. Both the Spectrum Analyzer and the E.U.T. are placed on a Non-Conducted Table. The table is supported by two legs. Below the table is a Ground Reference Plane.</p>
Limit:	2/3 of the 20dB bandwidth
	Remark: the transmission power is less than 0.125W.
Exploratory Test Mode:	Hopping transmitting with all kind of data type
Final Test Mode:	Through Pre-scan, find the DH1 of data type is the worst case of GFSK modulation type.
Instruments Used:	Refer to section 5.10 for details
Test Results:	Pass



**Measurement Data**

GFSK mode			
Test channel	Carrier Frequencies Separation (kHz)	Limit (kHz)	Result
Lowest	1002	≥702	Pass
Middle	1002	≥702	Pass
Highest	1002	≥702	Pass

Note: According to section 6.4,

Mode	20dB bandwidth (kHz) (worse case)	Limit (kHz) (Carrier Frequencies Separation)
GFSK	1052.885	702



Test plot as follows:

Test mode:	GFSK	Test channel:	Lowest
------------	------	---------------	--------

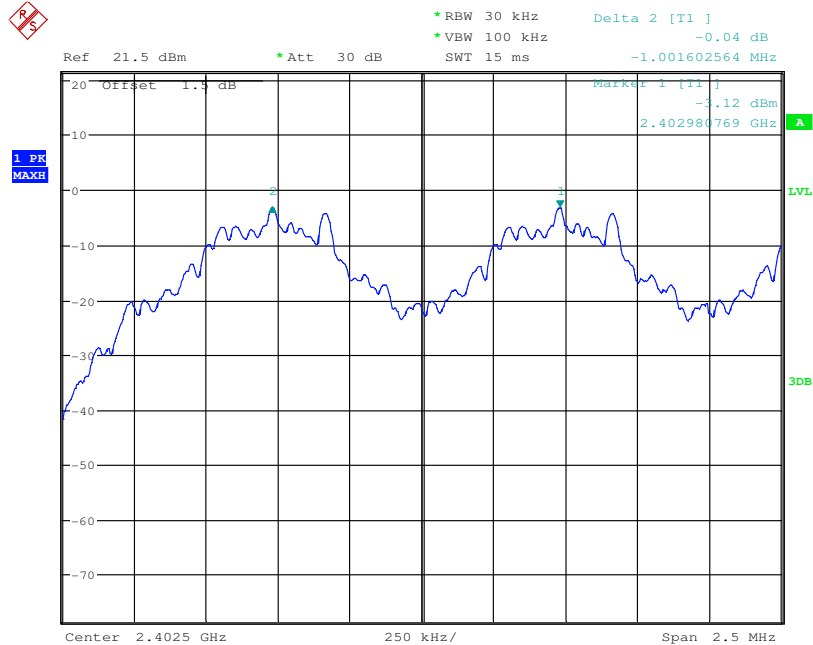

Test mode:	GFSK	Test channel:	Middle
------------	------	---------------	--------

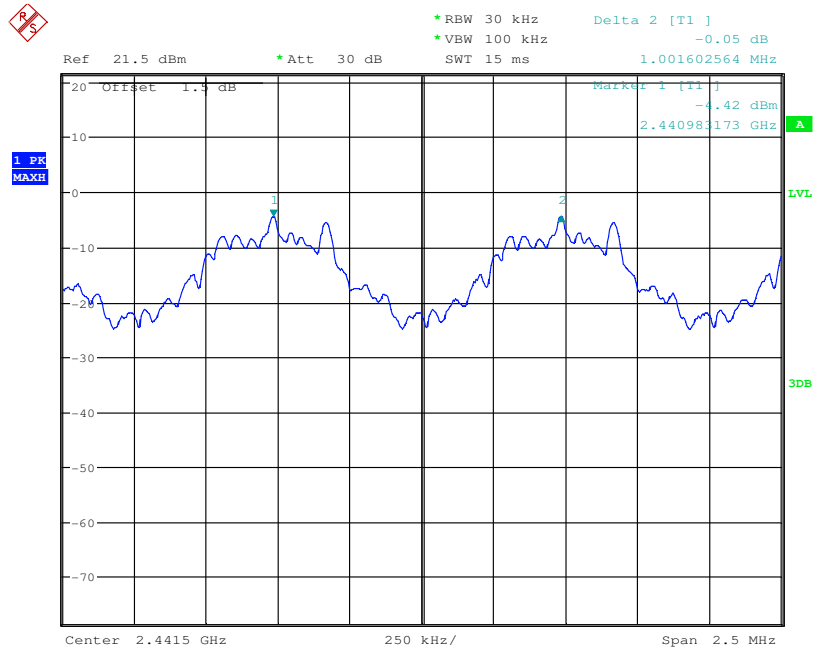

"This document is issued by the Company subject to its General Conditions of Service printed overleaf, available on request or accessible at [www.sgs.com/terms\\_and\\_conditions.htm](http://www.sgs.com/terms_and_conditions.htm) and, for electronic format documents, subject to Terms and Conditions for Electronic Documents at [www.sgs.com/terms\\_e-document.htm](http://www.sgs.com/terms_e-document.htm). Attention is drawn to the limitation of liability, indemnification and jurisdiction issues defined therein. Any holder of this document is advised that information contained hereon reflects the Company's findings at the time of its intervention only and within the limits of Client's instructions, if any. The Company's sole responsibility is to its Client and this document does not exonerate parties to a transaction from exercising all their rights and obligations under the transaction documents. This document cannot be reproduced except in full, without prior written approval of the Company. Any unauthorized alteration, forgery or falsification of the content or appearance of this document is unlawful and offenders may be prosecuted to the fullest extent of the law. Unless otherwise stated the results shown in this test report refer only to the sample(s) tested and such sample(s) are retained for 90 days only."



# SGS-CSTC Standards Technical Services Co., Ltd. Shenzhen Branch

Report No.: SZEM150500286501

Page: 22 of 59

Test mode:	GFSK	Test channel:	Highest
------------	------	---------------	---------

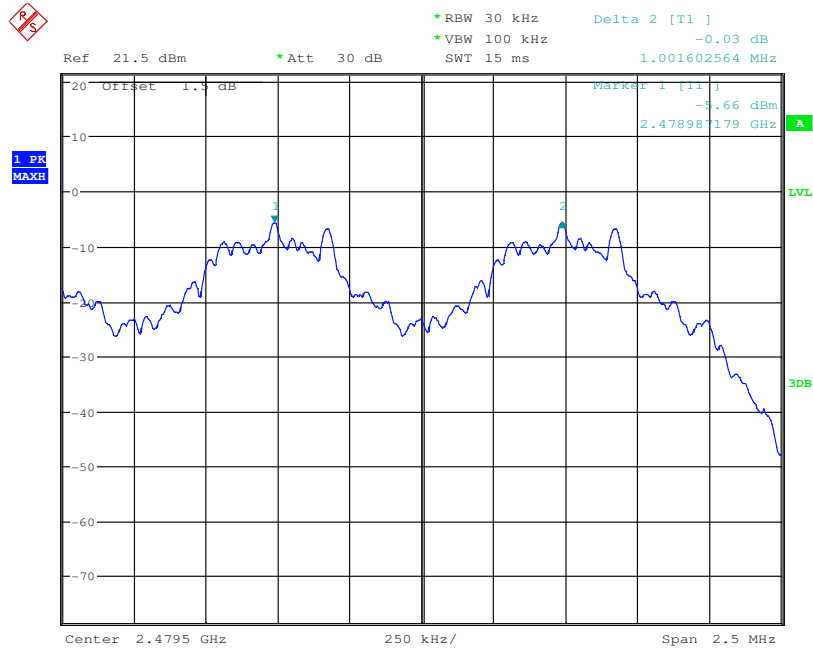

"This document is issued by the Company subject to its General Conditions of Service printed overleaf, available on request or accessible at [www.sgs.com/terms\\_and\\_conditions.htm](http://www.sgs.com/terms_and_conditions.htm) and, for electronic format documents, subject to Terms and Conditions for Electronic Documents at [www.sgs.com/terms\\_e-document.htm](http://www.sgs.com/terms_e-document.htm). Attention is drawn to the limitation of liability, indemnification and jurisdiction issues defined therein. Any holder of this document is advised that information contained hereon reflects the Company's findings at the time of its intervention only and within the limits of Client's instructions, if any. The Company's sole responsibility is to its Client and this document does not exonerate parties to a transaction from exercising all their rights and obligations under the transaction documents. This document cannot be reproduced except in full, without prior written approval of the Company. Any unauthorized alteration, forgery or falsification of the content or appearance of this document is unlawful and offenders may be prosecuted to the fullest extent of the law. Unless otherwise stated the results shown in this test report refer only to the sample(s) tested and such sample(s) are retained for 90 days only."

## 6.5 Hopping Channel Number

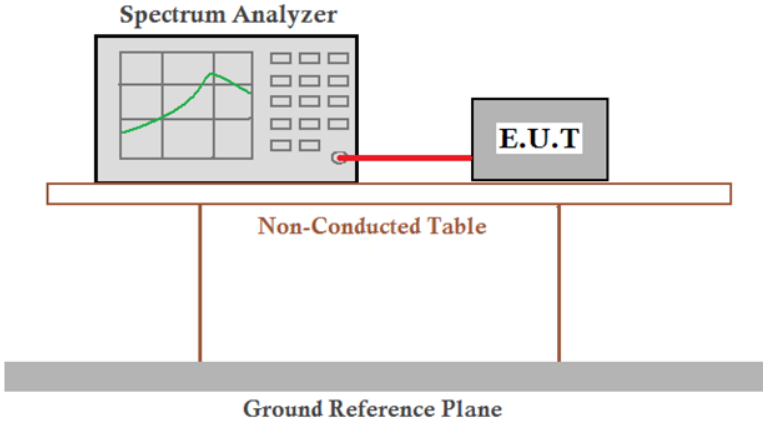
Test Requirement:	47 CFR Part 15C Section 15.247 (a)(1)
Test Method:	ANSI C63.10:2009
Test Setup:	
Limit:	At least 15 channels
Test Mode:	Hopping transmitting with GFSK modulation
Instruments Used:	Refer to section 5.10 for details
Test Results:	Pass

### Measurement Data

Mode	Hopping channel numbers	Limit
GFSK	79	≥15



Test plot as follows:

Test mode:	GFSK
------------	------

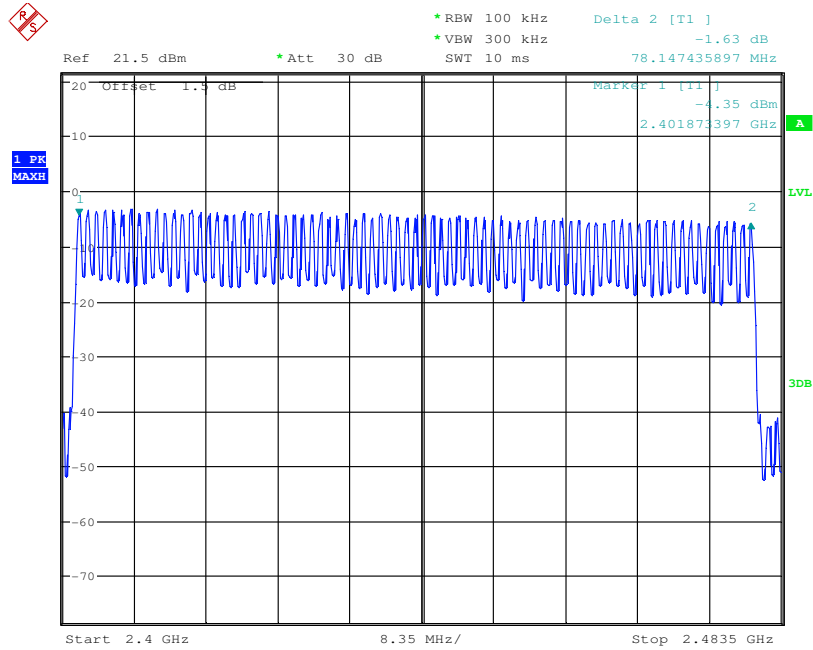

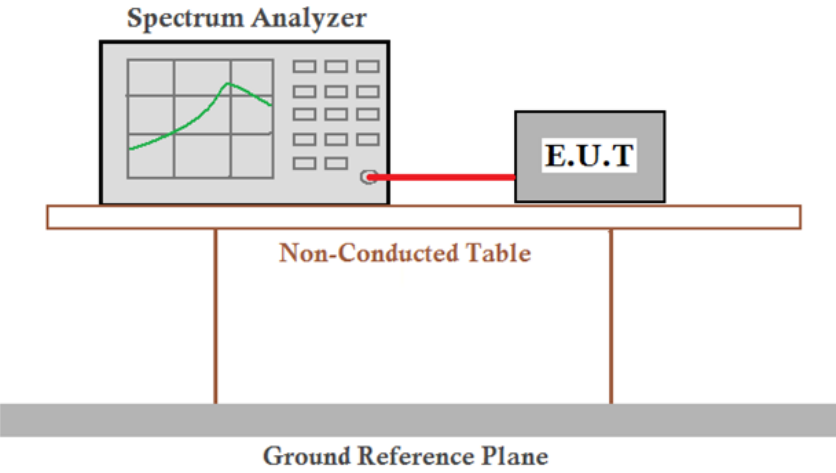

## 6.6 Dwell Time

Test Requirement:	47 CFR Part 15C Section 15.247 (a)(1)
Test Method:	ANSI C63.10:2009
Test Setup:	 <p>The diagram illustrates the test setup. A Spectrum Analyzer is connected to an E.U.T. (Equipment Under Test) via a red cable. Both are placed on a Non-Conducted Table, which is supported by a Ground Reference Plane.</p>
Instruments Used:	Refer to section 5.10 for details
Test Mode:	Hopping transmitting with all kind of data type.
Limit:	0.4 Second
Test Results:	Pass

### Measurement Data

Mode	Packet	Dwell time (second)	Limit (second)
GFSK	DH1	0.137	0.4
	DH3	0.218	0.4
	DH5	0.264	0.4



**Remark:**

The test period:  $T = 0.4 \text{ Second/Channel} \times 79 \text{ Channel} = 31.6 \text{ s}$

On (ms)\*total number=dwell time (ms)

The middle channel (2441MHz), as below:

DH1 time slot=0.429 (ms)\* total number=137.28 (ms)

DH3 time slot=1.679 (ms)\* total number = 218.27 (ms)

DH5 time slot=2.929 (ms)\* total number = 263.61 (ms)





Test plot as follows:

Test Packet:	DH1
--------------	-----

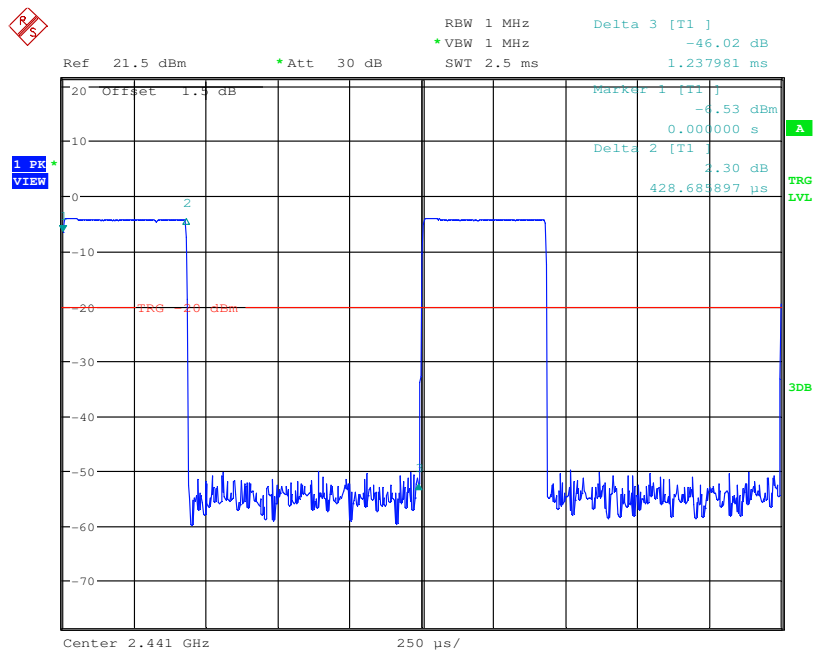
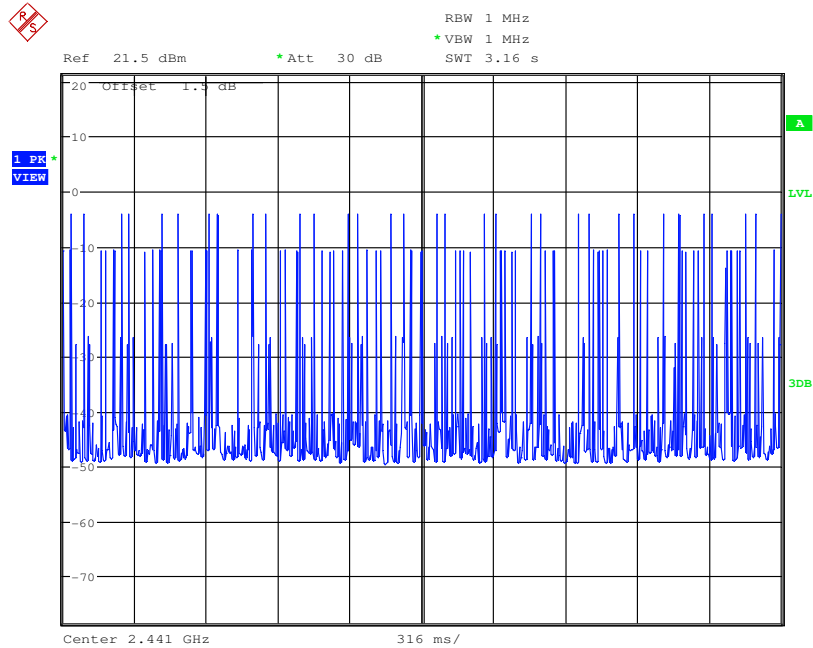

"This document is issued by the Company subject to its General Conditions of Service printed overleaf, available on request or accessible at [www.sgs.com/terms\\_and\\_conditions.htm](http://www.sgs.com/terms_and_conditions.htm) and, for electronic format documents, subject to Terms and Conditions for Electronic Documents at [www.sgs.com/terms\\_e-document.htm](http://www.sgs.com/terms_e-document.htm). Attention is drawn to the limitation of liability, indemnification and jurisdiction issues defined therein. Any holder of this document is advised that information contained hereon reflects the Company's findings at the time of its intervention only and within the limits of Client's instructions, if any. The Company's sole responsibility is to its Client and this document does not exonerate parties to a transaction from exercising all their rights and obligations under the transaction documents. This document cannot be reproduced except in full, without prior written approval of the Company. Any unauthorized alteration, forgery or falsification of the content or appearance of this document is unlawful and offenders may be prosecuted to the fullest extent of the law. Unless otherwise stated the results shown in this test report refer only to the sample(s) tested and such sample(s) are retained for 90 days only."



# SGS-CSTC Standards Technical Services Co., Ltd. Shenzhen Branch

Report No.: SZEM150500286501

Page: 28 of 59

Test Packet:	DH3
--------------	-----

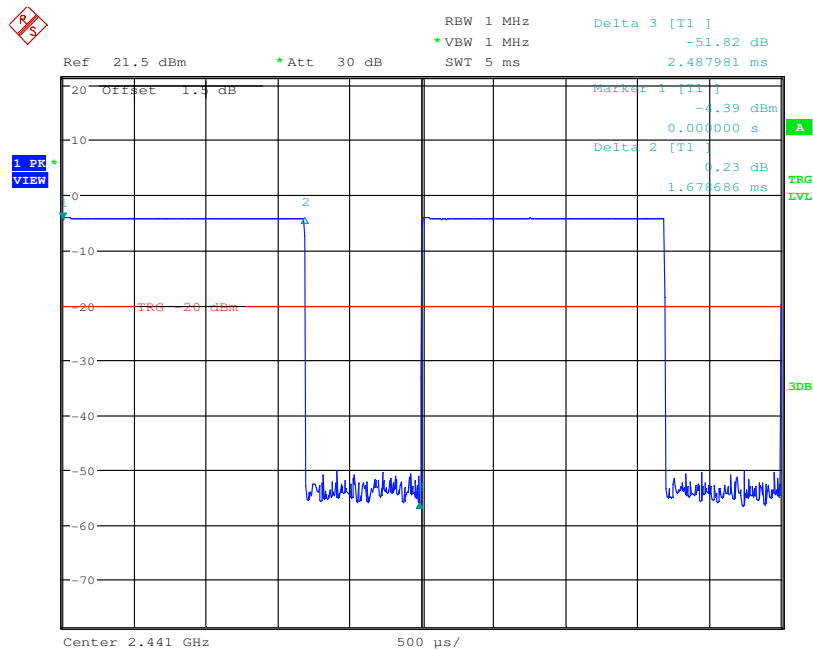
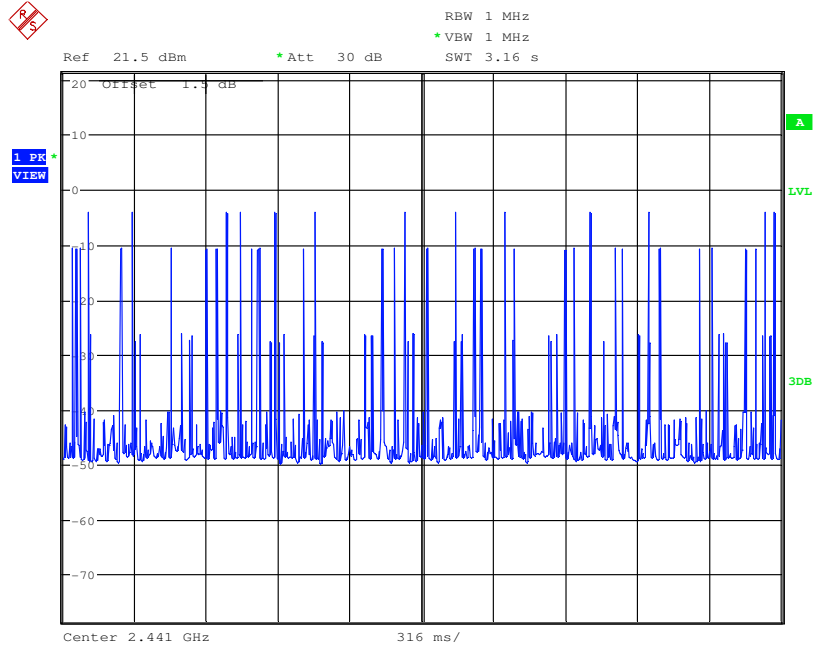

"This document is issued by the Company subject to its General Conditions of Service printed overleaf, available on request or accessible at [www.sgs.com/terms\\_and\\_conditions.htm](http://www.sgs.com/terms_and_conditions.htm) and, for electronic format documents, subject to Terms and Conditions for Electronic Documents at [www.sgs.com/terms\\_e-document.htm](http://www.sgs.com/terms_e-document.htm). Attention is drawn to the limitation of liability, indemnification and jurisdiction issues defined therein. Any holder of this document is advised that information contained hereon reflects the Company's findings at the time of its intervention only and within the limits of Client's instructions, if any. The Company's sole responsibility is to its Client and this document does not exonerate parties to a transaction from exercising all their rights and obligations under the transaction documents. This document cannot be reproduced except in full, without prior written approval of the Company. Any unauthorized alteration, forgery or falsification of the content or appearance of this document is unlawful and offenders may be prosecuted to the fullest extent of the law. Unless otherwise stated the results shown in this test report refer only to the sample(s) tested and such sample(s) are retained for 90 days only."



Test Packet:	DH5
--------------	-----

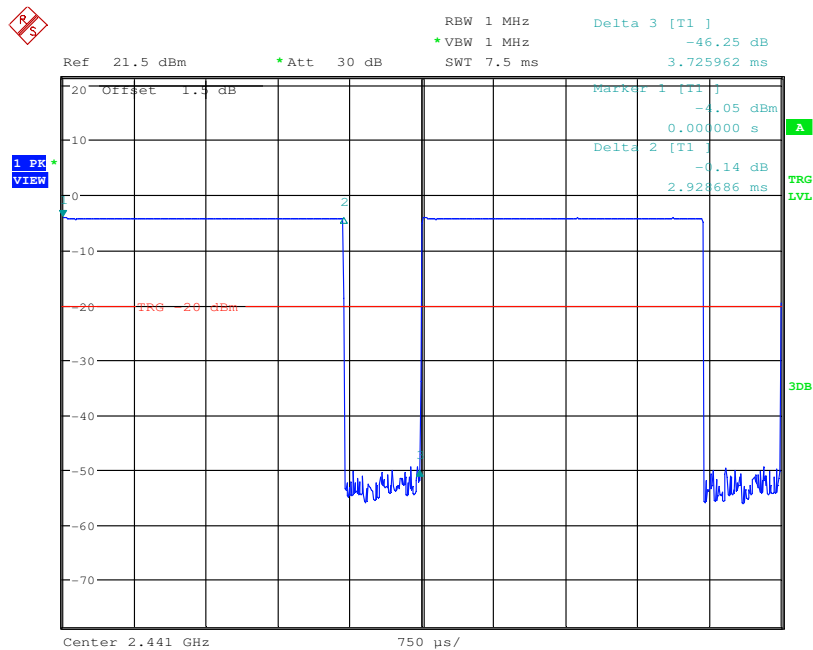
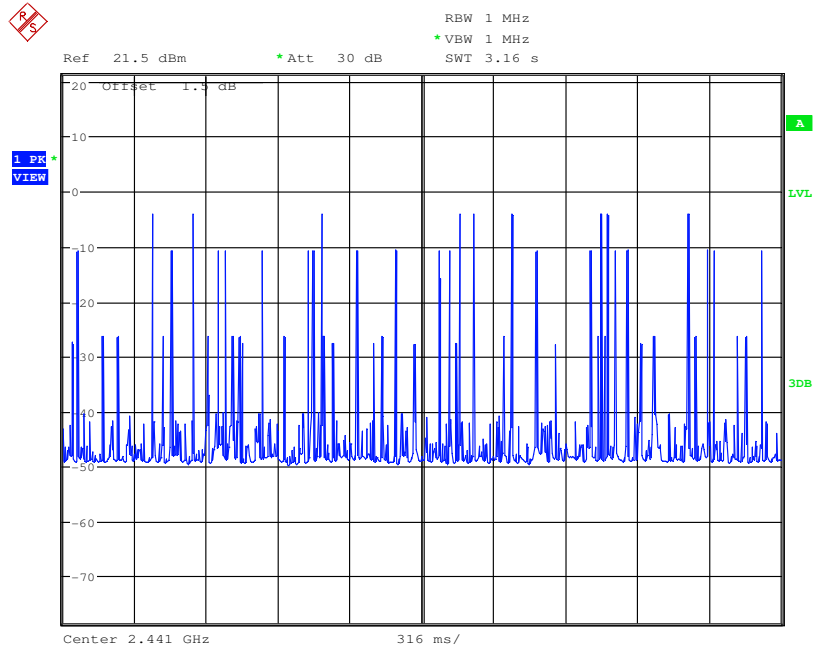

"This document is issued by the Company subject to its General Conditions of Service printed overleaf, available on request or accessible at [www.sgs.com/terms\\_and\\_conditions.htm](http://www.sgs.com/terms_and_conditions.htm) and, for electronic format documents, subject to Terms and Conditions for Electronic Documents at [www.sgs.com/terms\\_e-document.htm](http://www.sgs.com/terms_e-document.htm). Attention is drawn to the limitation of liability, indemnification and jurisdiction issues defined therein. Any holder of this document is advised that information contained hereon reflects the Company's findings at the time of its intervention only and within the limits of Client's instructions, if any. The Company's sole responsibility is to its Client and this document does not exonerate parties to a transaction from exercising all their rights and obligations under the transaction documents. This document cannot be reproduced except in full, without prior written approval of the Company. Any unauthorized alteration, forgery or falsification of the content or appearance of this document is unlawful and offenders may be prosecuted to the fullest extent of the law. Unless otherwise stated the results shown in this test report refer only to the sample(s) tested and such sample(s) are retained for 90 days only."

## 6.7 Band-edge for RF Conducted Emissions

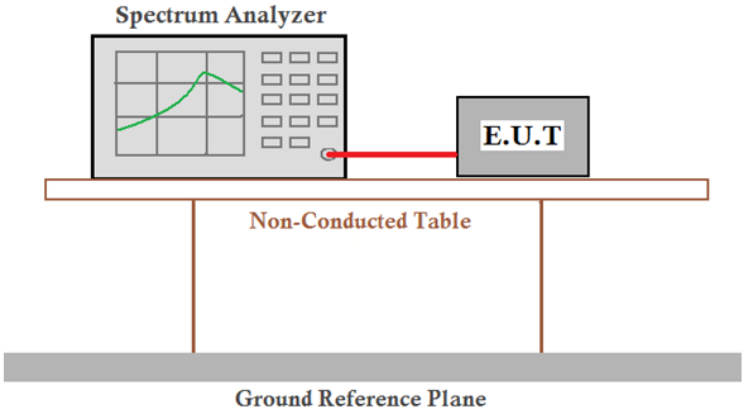
Test Requirement:	47 CFR Part 15C Section 15.247 (d)
Test Method:	ANSI C63.10:2009
Test Setup:	 <p>Remark: Offset the High-Frequency cable loss 1.5dB in the spectrum analyzer.</p>
Limit:	In any 100 kHz bandwidth outside the frequency band in which the spread spectrum intentional radiator is operating, the radio frequency power that is produced by the intentional radiator shall be at least 20 dB below that in the 100 kHz bandwidth within the band that contains the highest level of the desired power, based on either an RF conducted or a radiated measurement.
Exploratory Test Mode:	Hopping and Non-hopping transmitting with all kind of data type
Final Test Mode:	Through Pre-scan, find the DH1 of data type is the worst case of GFSK modulation type.
Instruments Used:	Refer to section 5.10 for details
Test Results:	Pass



Test plot as follows:

Test mode:	GFSK	Test channel:	Lowest
------------	------	---------------	--------

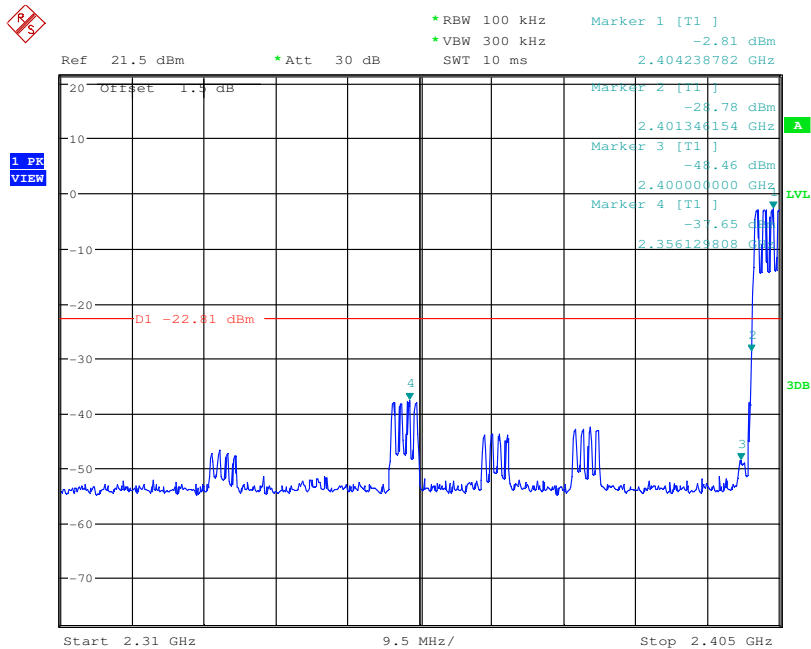
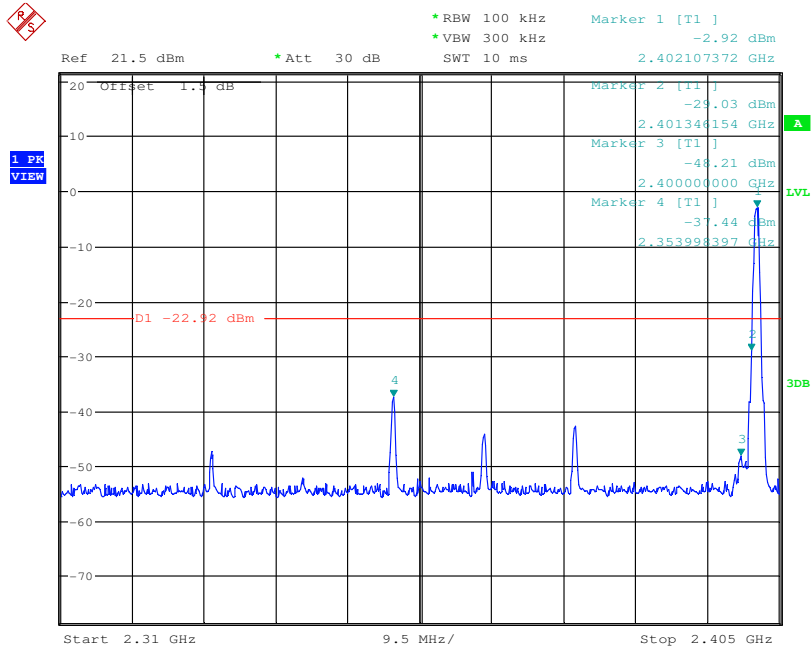

"This document is issued by the Company subject to its General Conditions of Service printed overleaf, available on request or accessible at [www.sgs.com/terms\\_and\\_conditions.htm](http://www.sgs.com/terms_and_conditions.htm) and, for electronic format documents, subject to Terms and Conditions for Electronic Documents at [www.sgs.com/terms\\_e-document.htm](http://www.sgs.com/terms_e-document.htm). Attention is drawn to the limitation of liability, indemnification and jurisdiction issues defined therein. Any holder of this document is advised that information contained hereon reflects the Company's findings at the time of its intervention only and within the limits of Client's instructions, if any. The Company's sole responsibility is to its Client and this document does not exonerate parties to a transaction from exercising all their rights and obligations under the transaction documents. This document cannot be reproduced except in full, without prior written approval of the Company. Any unauthorized alteration, forgery or falsification of the content or appearance of this document is unlawful and offenders may be prosecuted to the fullest extent of the law. Unless otherwise stated the results shown in this test report refer only to the sample(s) tested and such sample(s) are retained for 90 days only."



Test mode:	GFSK	Test channel:	Highest
------------	------	---------------	---------

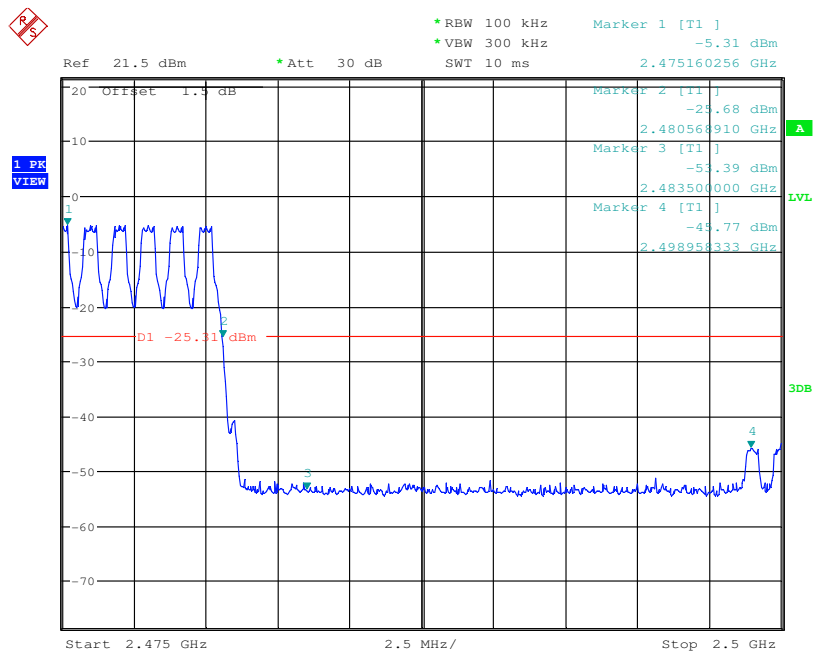
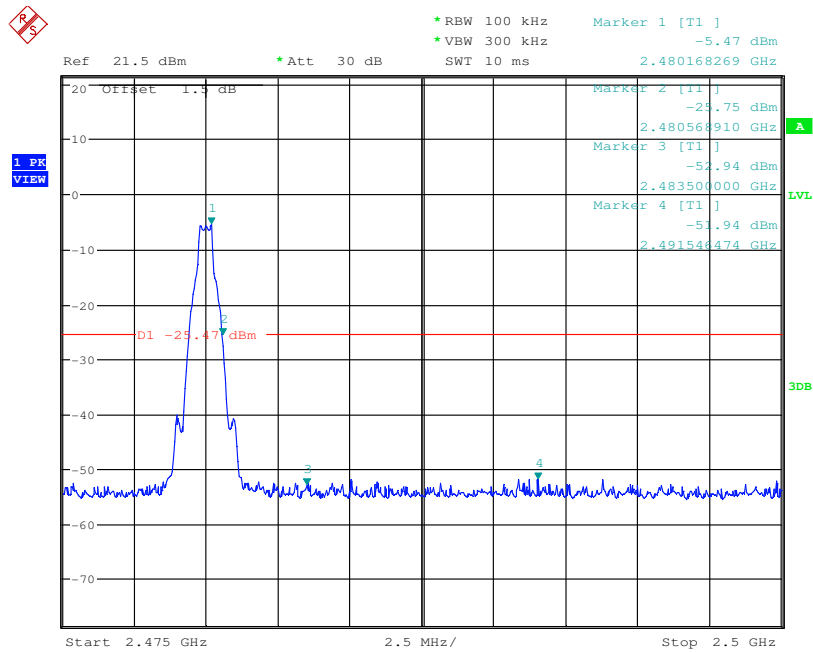

"This document is issued by the Company subject to its General Conditions of Service printed overleaf, available on request or accessible at [www.sgs.com/terms\\_and\\_conditions.htm](http://www.sgs.com/terms_and_conditions.htm) and, for electronic format documents, subject to Terms and Conditions for Electronic Documents at [www.sgs.com/terms\\_e-document.htm](http://www.sgs.com/terms_e-document.htm). Attention is drawn to the limitation of liability, indemnification and jurisdiction issues defined therein. Any holder of this document is advised that information contained hereon reflects the Company's findings at the time of its intervention only and within the limits of Client's instructions, if any. The Company's sole responsibility is to its Client and this document does not exonerate parties to a transaction from exercising all their rights and obligations under the transaction documents. This document cannot be reproduced except in full, without prior written approval of the Company. Any unauthorized alteration, forgery or falsification of the content or appearance of this document is unlawful and offenders may be prosecuted to the fullest extent of the law. Unless otherwise stated the results shown in this test report refer only to the sample(s) tested and such sample(s) are retained for 90 days only."

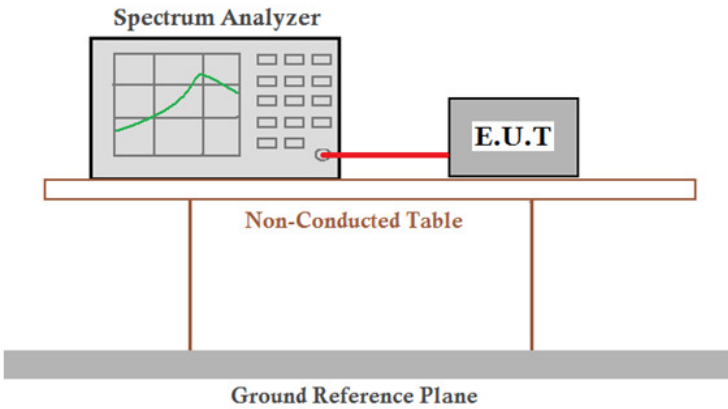

## 6.8 Spurious RF Conducted Emissions

Test Requirement:	47 CFR Part 15C Section 15.247 (d)
Test Method:	ANSI C63.10:2009
Test Setup:	 <p>Remark: Offset the High-Frequency cable loss 1.5dB in the spectrum analyzer.</p>
Limit:	In any 100 kHz bandwidth outside the frequency band in which the spread spectrum intentional radiator is operating, the radio frequency power that is produced by the intentional radiator shall be at least 20 dB below that in the 100 kHz bandwidth within the band that contains the highest level of the desired power, based on either an RF conducted or a radiated measurement.
Exploratory Test Mode:	Non-hopping transmitting with all kind of data type.
Final Test Mode:	Through Pre-scan, find the DH1 of data type is the worst case of GFSK modulation type.
Instruments Used:	Refer to section 5.10 for details
Test Results:	Pass



# SGS-CSTC Standards Technical Services Co., Ltd. Shenzhen Branch

Report No.: SZEM150500286501

Page: 34 of 59

Test mode:	GFSK	Test channel:	Lowest
------------	------	---------------	--------

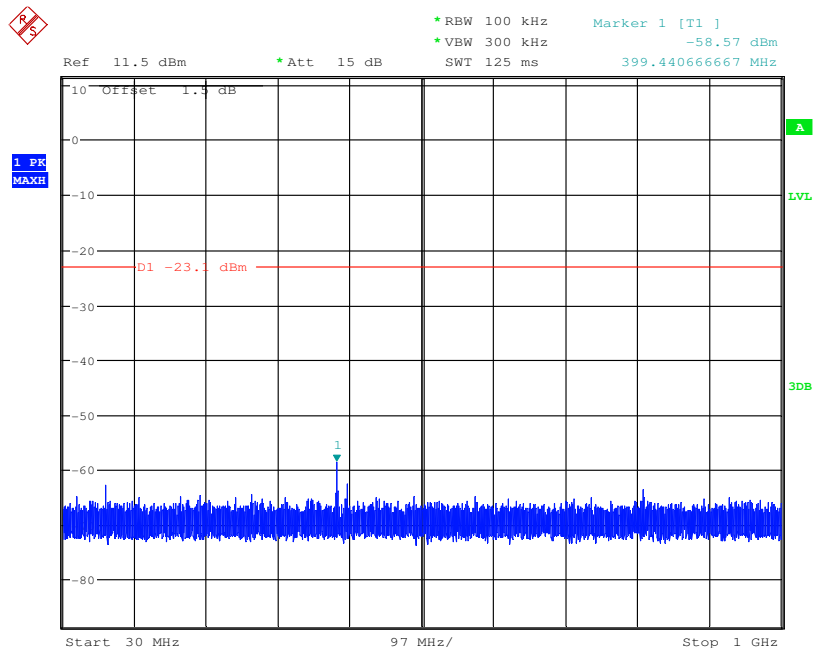
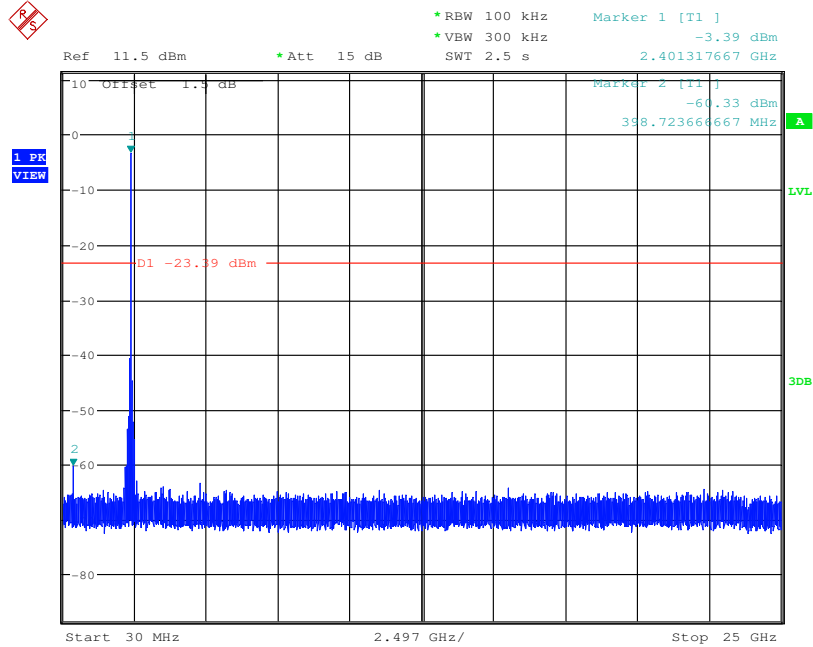

"This document is issued by the Company subject to its General Conditions of Service printed overleaf, available on request or accessible at [www.sgs.com/terms\\_and\\_conditions.htm](http://www.sgs.com/terms_and_conditions.htm) and, for electronic format documents, subject to Terms and Conditions for Electronic Documents at [www.sgs.com/terms\\_e-document.htm](http://www.sgs.com/terms_e-document.htm). Attention is drawn to the limitation of liability, indemnification and jurisdiction issues defined therein. Any holder of this document is advised that information contained hereon reflects the Company's findings at the time of its intervention only and within the limits of Client's instructions, if any. The Company's sole responsibility is to its Client and this document does not exonerate parties to a transaction from exercising all their rights and obligations under the transaction documents. This document cannot be reproduced except in full, without prior written approval of the Company. Any unauthorized alteration, forgery or falsification of the content or appearance of this document is unlawful and offenders may be prosecuted to the fullest extent of the law. Unless otherwise stated the results shown in this test report refer only to the sample(s) tested and such sample(s) are retained for 90 days only."



# SGS-CSTC Standards Technical Services Co., Ltd. Shenzhen Branch

Report No.: SZEM150500286501

Page: 35 of 59

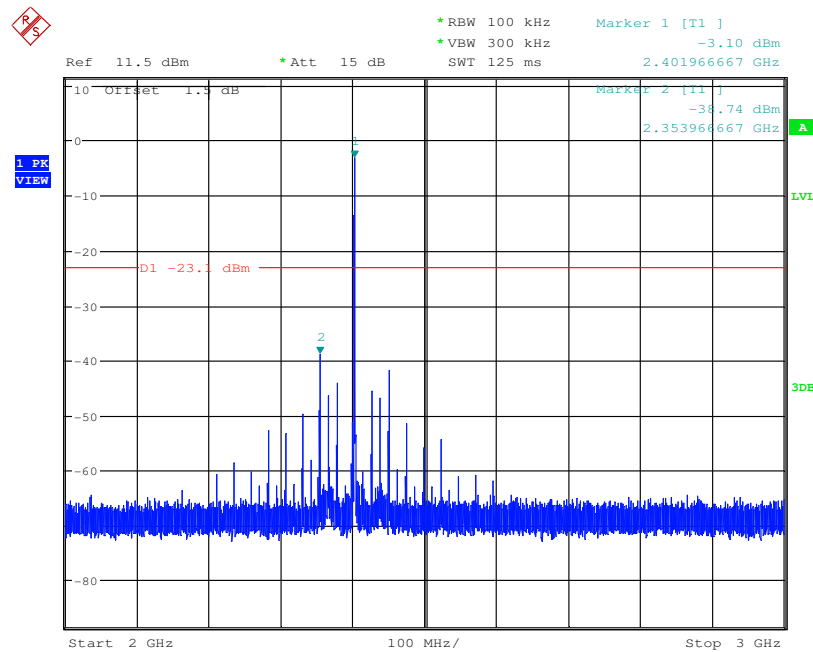
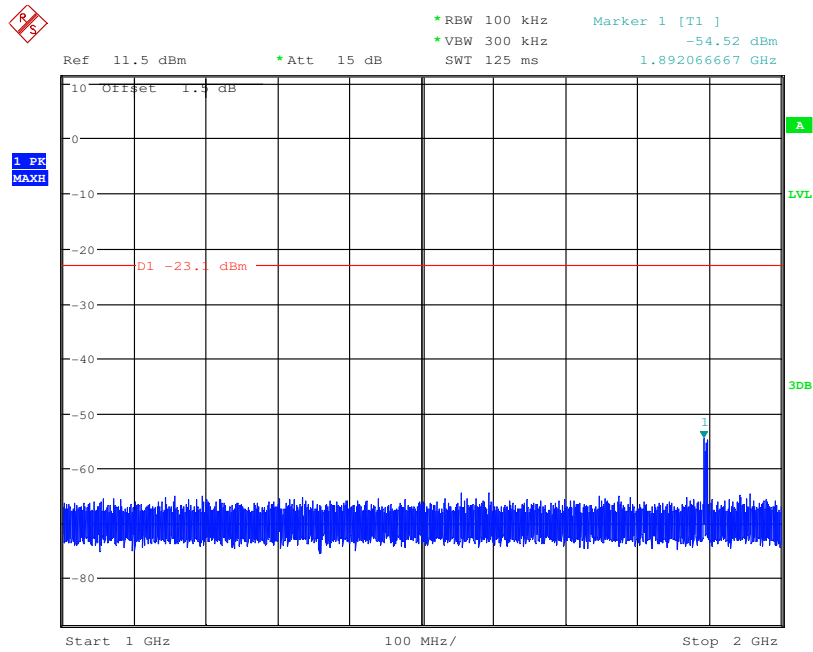

"This document is issued by the Company subject to its General Conditions of Service printed overleaf, available on request or accessible at [www.sgs.com/terms\\_and\\_conditions.htm](http://www.sgs.com/terms_and_conditions.htm) and, for electronic format documents, subject to Terms and Conditions for Electronic Documents at [www.sgs.com/terms\\_e-document.htm](http://www.sgs.com/terms_e-document.htm). Attention is drawn to the limitation of liability, indemnification and jurisdiction issues defined therein. Any holder of this document is advised that information contained hereon reflects the Company's findings at the time of its intervention only and within the limits of Client's instructions, if any. The Company's sole responsibility is to its Client and this document does not exonerate parties to a transaction from exercising all their rights and obligations under the transaction documents. This document cannot be reproduced except in full, without prior written approval of the Company. Any unauthorized alteration, forgery or falsification of the content or appearance of this document is unlawful and offenders may be prosecuted to the fullest extent of the law. Unless otherwise stated the results shown in this test report refer only to the sample(s) tested and such sample(s) are retained for 90 days only."



**SGS-CSTC Standards Technical Services Co., Ltd.**  
**Shenzhen Branch**

Report No.: SZEM150500286501

Page: 36 of 59

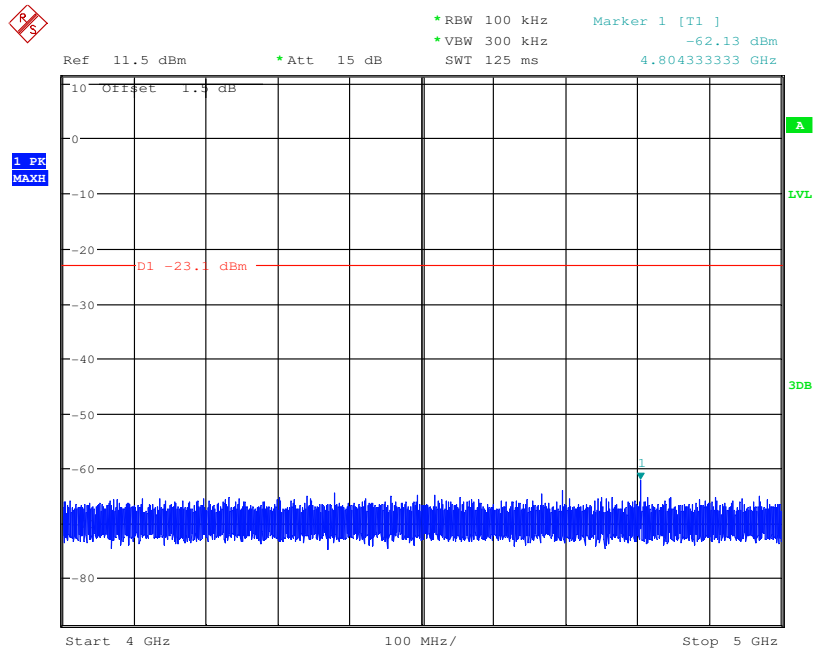

Test mode:	GFSK	Test channel:	Middle
------------	------	---------------	--------

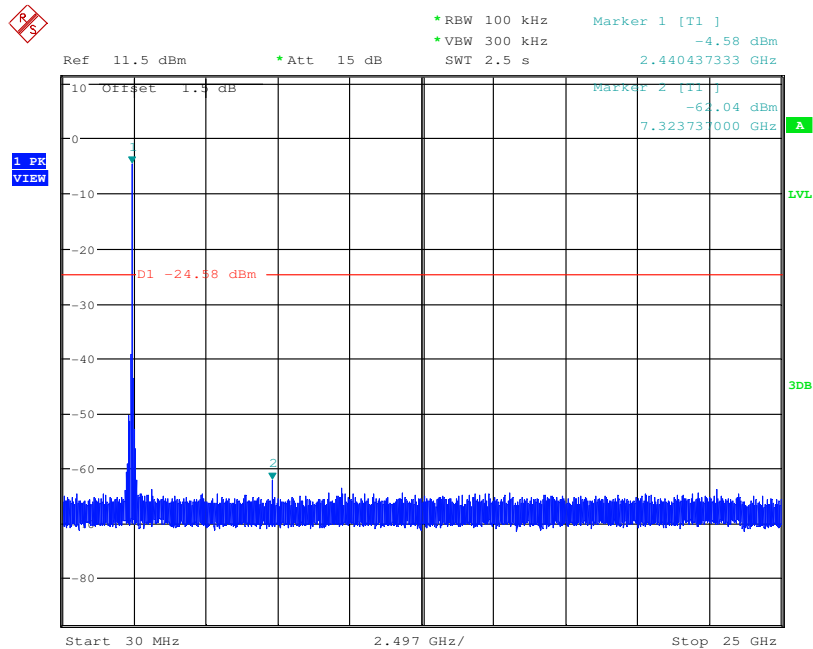

"This document is issued by the Company subject to its General Conditions of Service printed overleaf, available on request or accessible at [www.sgs.com/terms\\_and\\_conditions.htm](http://www.sgs.com/terms_and_conditions.htm) and, for electronic format documents, subject to Terms and Conditions for Electronic Documents at [www.sgs.com/terms\\_e-document.htm](http://www.sgs.com/terms_e-document.htm). Attention is drawn to the limitation of liability, indemnification and jurisdiction issues defined therein. Any holder of this document is advised that information contained hereon reflects the Company's findings at the time of its intervention only and within the limits of Client's instructions, if any. The Company's sole responsibility is to its Client and this document does not exonerate parties to a transaction from exercising all their rights and obligations under the transaction documents. This document cannot be reproduced except in full, without prior written approval of the Company. Any unauthorized alteration, forgery or falsification of the content or appearance of this document is unlawful and offenders may be prosecuted to the fullest extent of the law. Unless otherwise stated the results shown in this test report refer only to the sample(s) tested and such sample(s) are retained for 90 days only."

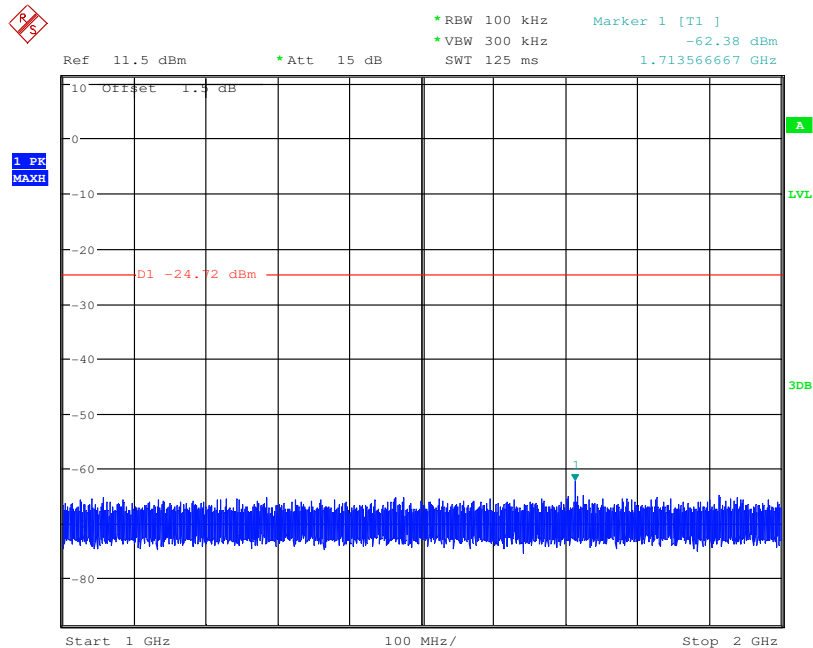
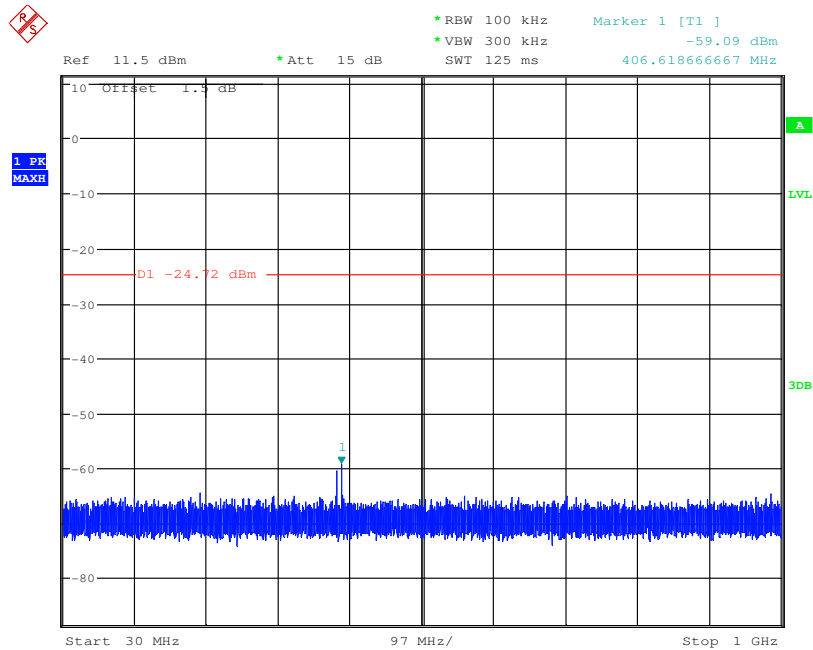



# SGS-CSTC Standards Technical Services Co., Ltd. Shenzhen Branch

Report No.: SZEM150500286501

Page: 38 of 59

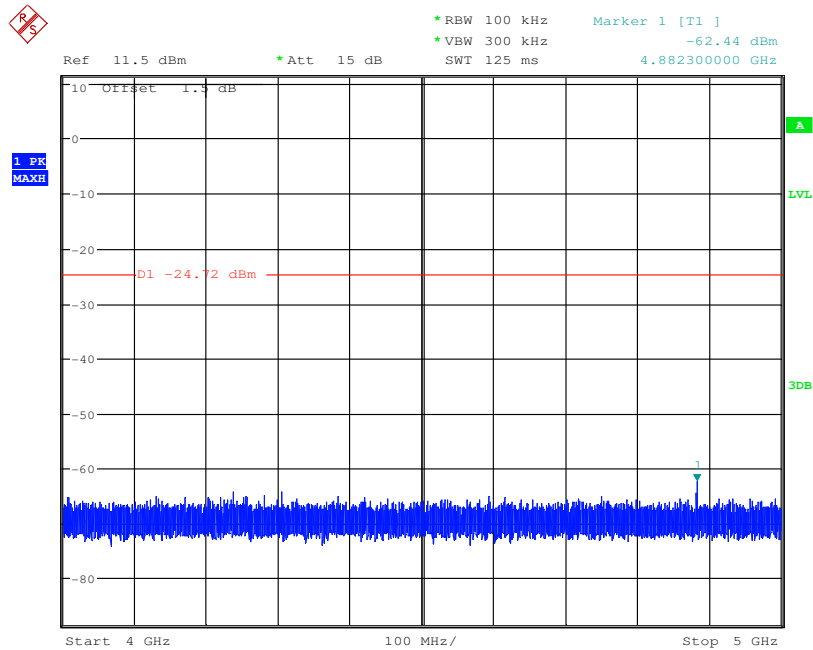
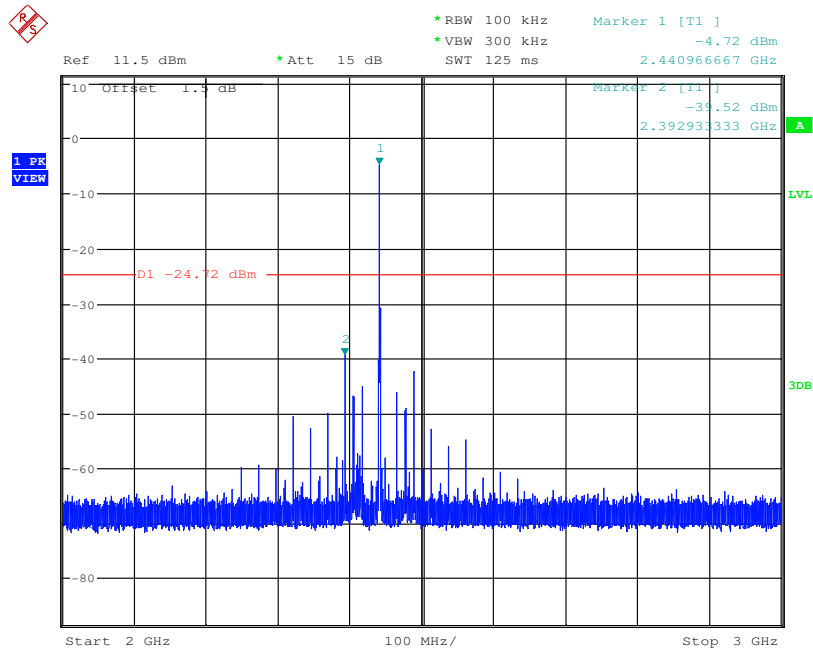

"This document is issued by the Company subject to its General Conditions of Service printed overleaf, available on request or accessible at [www.sgs.com/terms\\_and\\_conditions.htm](http://www.sgs.com/terms_and_conditions.htm) and, for electronic format documents, subject to Terms and Conditions for Electronic Documents at [www.sgs.com/terms\\_e-document.htm](http://www.sgs.com/terms_e-document.htm). Attention is drawn to the limitation of liability, indemnification and jurisdiction issues defined therein. Any holder of this document is advised that information contained hereon reflects the Company's findings at the time of its intervention only and within the limits of Client's instructions, if any. The Company's sole responsibility is to its Client and this document does not exonerate parties to a transaction from exercising all their rights and obligations under the transaction documents. This document cannot be reproduced except in full, without prior written approval of the Company. Any unauthorized alteration, forgery or falsification of the content or appearance of this document is unlawful and offenders may be prosecuted to the fullest extent of the law. Unless otherwise stated the results shown in this test report refer only to the sample(s) tested and such sample(s) are retained for 90 days only."



# SGS-CSTC Standards Technical Services Co., Ltd. Shenzhen Branch

Report No.: SZEM150500286501

Page: 39 of 59

Test mode:	GFSK	Test channel:	Highest
------------	------	---------------	---------

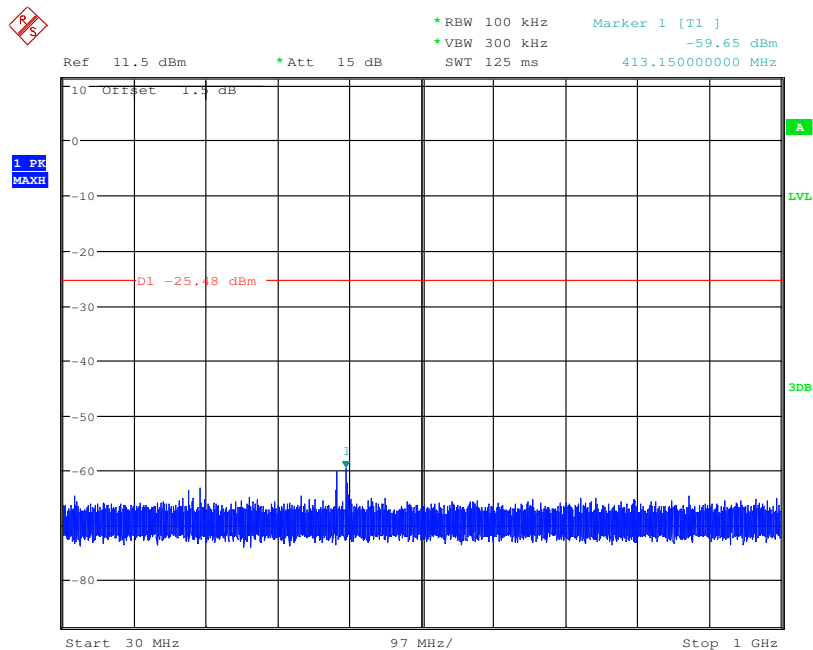
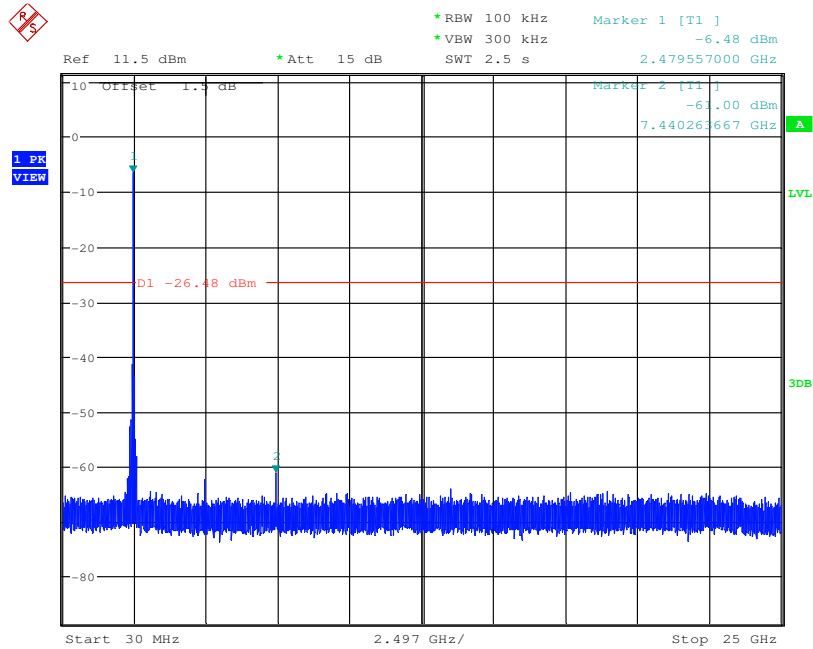

"This document is issued by the Company subject to its General Conditions of Service printed overleaf, available on request or accessible at [www.sgs.com/terms\\_and\\_conditions.htm](http://www.sgs.com/terms_and_conditions.htm) and, for electronic format documents, subject to Terms and Conditions for Electronic Documents at [www.sgs.com/terms\\_e-document.htm](http://www.sgs.com/terms_e-document.htm). Attention is drawn to the limitation of liability, indemnification and jurisdiction issues defined therein. Any holder of this document is advised that information contained hereon reflects the Company's findings at the time of its intervention only and within the limits of Client's instructions, if any. The Company's sole responsibility is to its Client and this document does not exonerate parties to a transaction from exercising all their rights and obligations under the transaction documents. This document cannot be reproduced except in full, without prior written approval of the Company. Any unauthorized alteration, forgery or falsification of the content or appearance of this document is unlawful and offenders may be prosecuted to the fullest extent of the law. Unless otherwise stated the results shown in this test report refer only to the sample(s) tested and such sample(s) are retained for 90 days only."

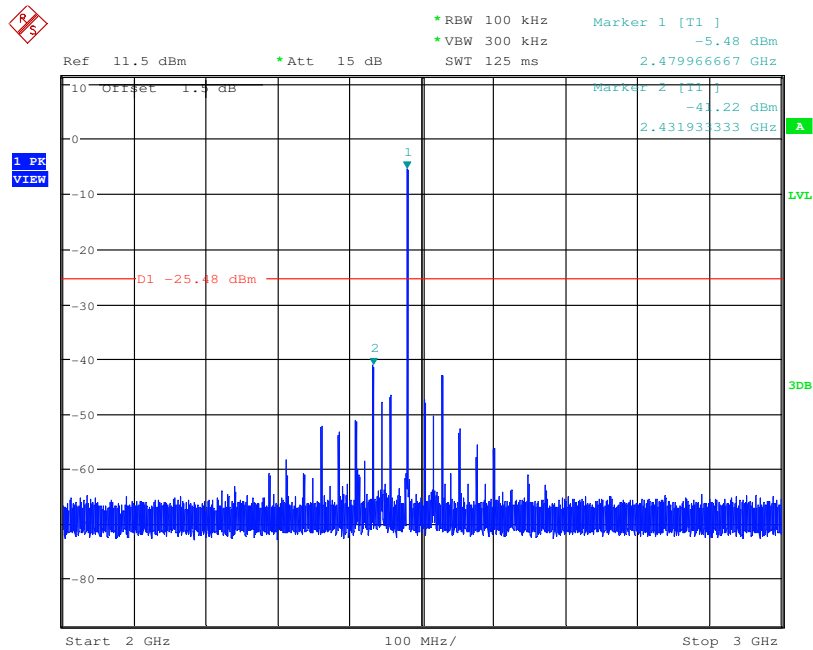
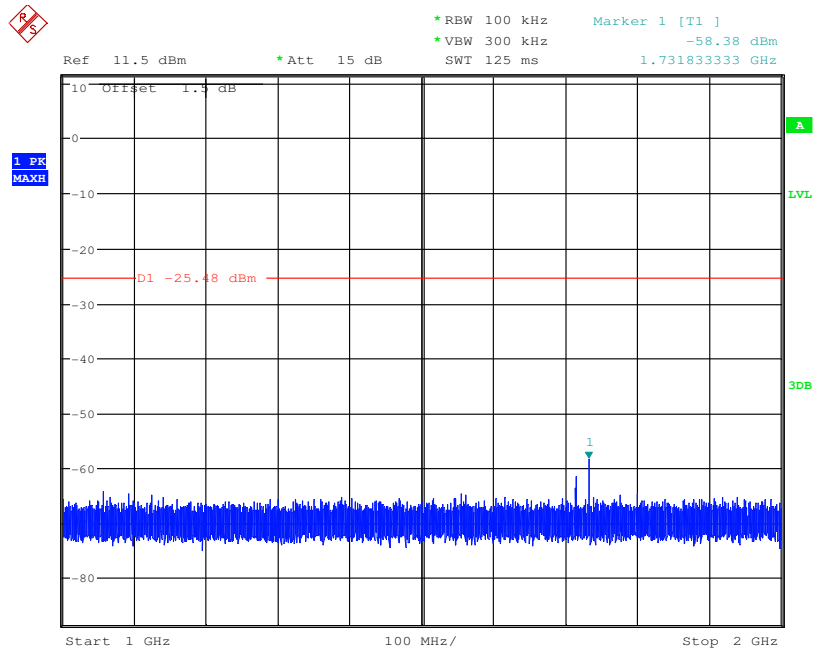

"This document is issued by the Company subject to its General Conditions of Service printed overleaf, available on request or accessible at [www.sgs.com/terms\\_and\\_conditions.htm](http://www.sgs.com/terms_and_conditions.htm) and, for electronic format documents, subject to Terms and Conditions for Electronic Documents at [www.sgs.com/terms\\_e-document.htm](http://www.sgs.com/terms_e-document.htm). Attention is drawn to the limitation of liability, indemnification and jurisdiction issues defined therein. Any holder of this document is advised that information contained hereon reflects the Company's findings at the time of its intervention only and within the limits of Client's instructions, if any. The Company's sole responsibility is to its Client and this document does not exonerate parties to a transaction from exercising all their rights and obligations under the transaction documents. This document cannot be reproduced except in full, without prior written approval of the Company. Any unauthorized alteration, forgery or falsification of the content or appearance of this document is unlawful and offenders may be prosecuted to the fullest extent of the law. Unless otherwise stated the results shown in this test report refer only to the sample(s) tested and such sample(s) are retained for 90 days only."



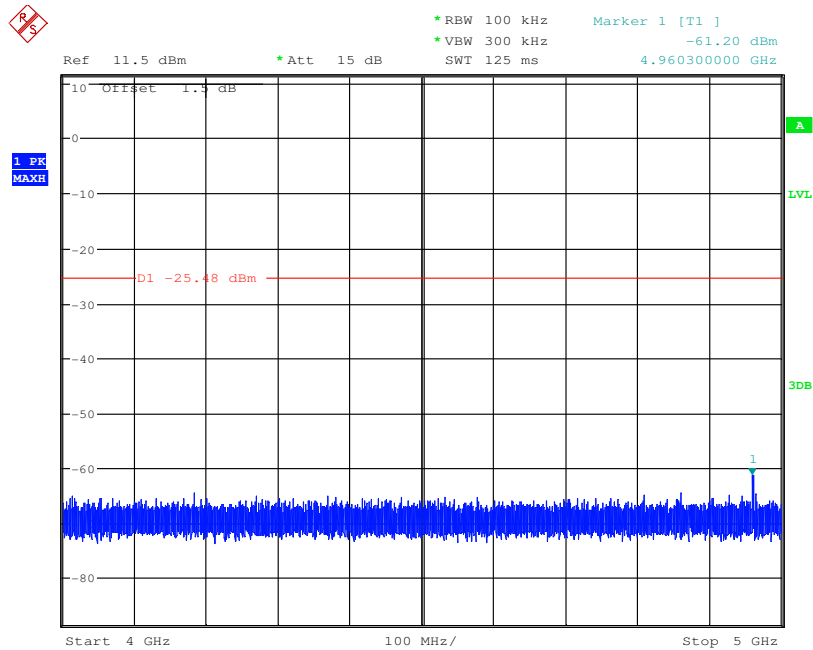

Remark:

Pretest 9kHz to 25GHz, find the highest point when testing, so only the worst data were shown in the test report. Per FCC Part 15.33 (a) and 15.31 (o), The amplitude of spurious emissions from intentional radiators which are attenuated more than 20 dB below the permissible value need not be reported unless specifically required elsewhere in this part.

## 6.9 Other requirements Frequency Hopping Spread Spectrum System

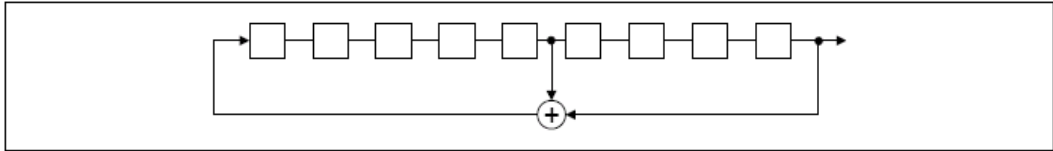
Test Requirement:	47 CFR Part 15C Section 15.247 (a)(1), (h) requirement:																												
	<p>The system shall hop to channel frequencies that are selected at the system hopping rate from a Pseudorandom ordered list of hopping frequencies. Each frequency must be used equally on the average by each transmitter. The system receivers shall have input bandwidths that match the hopping channel bandwidths of their corresponding transmitters and shall shift frequencies in synchronization with the transmitted signals.</p> <p>Frequency hopping spread spectrum systems are not required to employ all available hopping channels during each transmission. However, the system, consisting of both the transmitter and the receiver, must be designed to comply with all of the regulations in this section should the transmitter be presented with a continuous data (or information) stream. In addition, a system employing short transmission bursts must comply with the definition of a frequency hopping system and must distribute its transmissions over the minimum number of hopping channels specified in this section.</p> <p>The incorporation of intelligence within a frequency hopping spread spectrum system that permits the system to recognize other users within the spectrum band so that it individually and independently chooses and adapts its hopsets to avoid hopping on occupied channels is permitted. The coordination of frequency hopping systems in any other manner for the express purpose of avoiding the simultaneous occupancy of individual hopping frequencies by multiple transmitters is not permitted.</p>																												
	<p><b>Compliance for section 15.247(a)(1)</b></p>																												
	<p>According to Bluetooth Core Specification, the pseudorandom sequence may be generated in a nine-stage shift register whose 5th and 9th stage outputs are added in a modulo-two addition stage. And the result is fed back to the input of the first stage. The sequence begins with the first ONE of 9 consecutive ONES; i.e. the shift register is initialized with nine ones.</p> <ul style="list-style-type: none"> <li>• Number of shift register stages: 9</li> <li>• Length of pseudo-random sequence: <math>2^9 - 1 = 511</math> bits</li> <li>• Longest sequence of zeros: 8 (non-inverted signal)</li> </ul> <div data-bbox="300 1451 1358 1601" style="border: 1px solid black; padding: 10px; margin: 10px 0;">  </div> <p style="text-align: center;"><i>Linear Feedback Shift Register for Generation of the PRBS sequence</i></p> <p>An example of Pseudorandom Frequency Hopping Sequence as follow:</p> <div data-bbox="276 1697 1262 1848" style="border: 1px dashed black; padding: 10px; margin: 10px 0;"> <table style="width: 100%; border-collapse: collapse;"> <tr> <td style="text-align: center; border-right: 1px solid black;">20</td> <td style="text-align: center; border-right: 1px solid black;">62</td> <td style="text-align: center; border-right: 1px solid black;">46</td> <td style="text-align: center; border-right: 1px solid black;">77</td> <td style="width: 20%;"></td> <td style="text-align: center; border-right: 1px solid black;">7</td> <td style="text-align: center; border-right: 1px solid black;">64</td> <td style="width: 20%;"></td> <td style="text-align: center; border-right: 1px solid black;">8</td> <td style="text-align: center; border-right: 1px solid black;">73</td> <td style="width: 20%;"></td> <td style="text-align: center; border-right: 1px solid black;">16</td> <td style="text-align: center; border-right: 1px solid black;">75</td> <td style="text-align: center;">1</td> </tr> <tr> <td style="border: 1px solid black; height: 20px;"></td> <td style="border: 1px solid black; height: 20px;"></td> <td style="border: 1px solid black; height: 20px;"></td> <td style="border: 1px solid black; height: 20px;"></td> <td></td> <td style="border: 1px solid black; height: 20px;"></td> <td style="border: 1px solid black; height: 20px;"></td> <td></td> <td style="border: 1px solid black; height: 20px;"></td> <td style="border: 1px solid black; height: 20px;"></td> <td></td> <td style="border: 1px solid black; height: 20px;"></td> <td style="border: 1px solid black; height: 20px;"></td> <td style="border: 1px solid black; height: 20px;"></td> </tr> </table> </div> <p>Each frequency used equally on the average by each transmitter.</p> <p>According to Bluetooth Core Specification, Bluetooth receivers are designed to have input and IF bandwidths that match the hopping channel bandwidths of any Bluetooth transmitters and shift frequencies in synchronization with the transmitted signals.</p>	20	62	46	77		7	64		8	73		16	75	1														
20	62	46	77		7	64		8	73		16	75	1																

\*This document is issued by the Company subject to its General Conditions of Service printed overleaf, available on request or accessible at [www.sgs.com/terms\\_and\\_conditions.htm](http://www.sgs.com/terms_and_conditions.htm) and, for electronic format documents, subject to Terms and Conditions for Electronic Documents at [www.sgs.com/terms\\_e-document.htm](http://www.sgs.com/terms_e-document.htm). Attention is drawn to the limitation of liability, indemnification and jurisdiction issues defined therein. Any holder of this document is advised that information contained hereon reflects the Company's findings at the time of its intervention only and within the limits of Client's instructions, if any. The Company's sole responsibility is to its Client and this document does not exonerate parties to a transaction from exercising all their rights and obligations under the transaction documents. This document cannot be reproduced except in full, without prior written approval of the Company. Any unauthorized alteration, forgery or falsification of the content or appearance of this document is unlawful and offenders may be prosecuted to the fullest extent of the law. Unless otherwise stated the results shown in this test report refer only to the sample(s) tested and such sample(s) are retained for 90 days only."



<b>Compliance for section 15.247(g)</b>
According to Bluetooth Core Specification, the Bluetooth system transmits the packet with the pseudorandom hopping frequency with a continuous data and the short burst transmission from the Bluetooth system is also transmitted under the frequency hopping system with the pseudorandom hopping frequency system.
<b>Compliance for section 15.247(h)</b>
According to Bluetooth Core specification, the Bluetooth system incorporates with an adaptive system to detect other user within the spectrum band so that it individually and independently to avoid hopping on the occupied channels. According to the Bluetooth Core specification, the Bluetooth system is designed not have the ability to coordinated with other FHSS System in an effort to avoid the simultaneous occupancy of individual hopping frequencies by multiple transmitter.



**6.10 Radiated Spurious Emission**

Test Requirement:	47 CFR Part 15C Section 15.209 and 15.205				
Test Method:	ANSI C63.10: 2009				
Test Site:	Measurement Distance: 3m (Semi-Anechoic Chamber)				
Receiver Setup:	Frequency	Detector	RBW	VBW	Remark
	0.009MHz-0.090MHz	Peak	10kHz	30kHz	Peak
	0.009MHz-0.090MHz	Average	10kHz	30kHz	Average
	0.090MHz-0.110MHz	Quasi-peak	10kHz	30kHz	Quasi-peak
	0.110MHz-0.490MHz	Peak	10kHz	30kHz	Peak
	0.110MHz-0.490MHz	Average	10kHz	30kHz	Average
	0.490MHz -30MHz	Quasi-peak	10kHz	30kHz	Quasi-peak
	30MHz-1GHz	Quasi-peak	100 kHz	300kHz	Quasi-peak
	Above 1GHz	Peak	1MHz	3MHz	Peak
		Peak	1MHz	10Hz	Average
Limit:	Frequency	Field strength (microvolt/meter)	Limit (dBuV/m)	Remark	Measurement distance (m)
	0.009MHz-0.490MHz	2400/F(kHz)	-	-	300
	0.490MHz-1.705MHz	24000/F(kHz)	-	-	30
	1.705MHz-30MHz	30	-	-	30
	30MHz-88MHz	100	40.0	Quasi-peak	3
	88MHz-216MHz	150	43.5	Quasi-peak	3
	216MHz-960MHz	200	46.0	Quasi-peak	3
	960MHz-1GHz	500	54.0	Quasi-peak	3
	Above 1GHz	500	54.0	Average	3
<p>Note: 15.35(b), Unless otherwise specified, the limit on peak radio frequency emissions is 20dB above the maximum permitted average emission limit applicable to the equipment under test. This peak limit applies to the total peak emission level radiated by the device.</p>					

"This document is issued by the Company subject to its General Conditions of Service printed overleaf, available on request or accessible at [www.sgs.com/terms\\_and\\_conditions.htm](http://www.sgs.com/terms_and_conditions.htm) and, for electronic format documents, subject to Terms and Conditions for Electronic Documents at [www.sgs.com/terms\\_e-document.htm](http://www.sgs.com/terms_e-document.htm). Attention is drawn to the limitation of liability, indemnification and jurisdiction issues defined therein. Any holder of this document is advised that information contained hereon reflects the Company's findings at the time of its intervention only and within the limits of Client's instructions, if any. The Company's sole responsibility is to its Client and this document does not exonerate parties to a transaction from exercising all their rights and obligations under the transaction documents. This document cannot be reproduced except in full, without prior written approval of the Company. Any unauthorized alteration, forgery or falsification of the content or appearance of this document is unlawful and offenders may be prosecuted to the fullest extent of the law. Unless otherwise stated the results shown in this test report refer only to the sample(s) tested and such sample(s) are retained for 90 days only."

**Test Setup:**

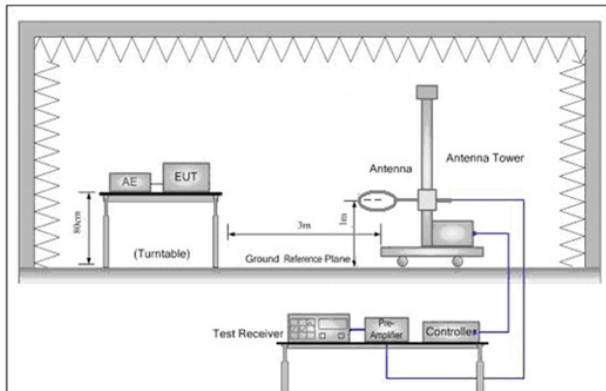

Figure 1. Below 30MHz

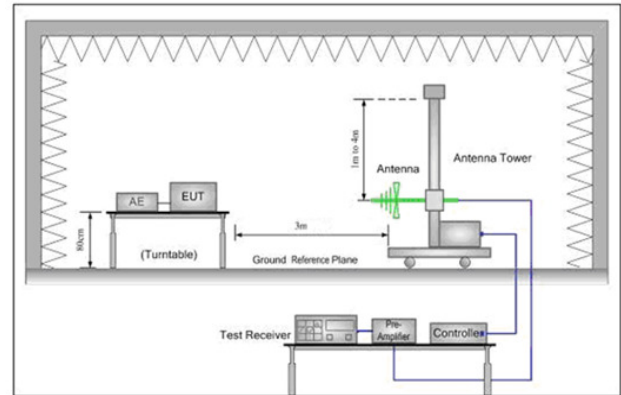

Figure 2. 30MHz to 1GHz

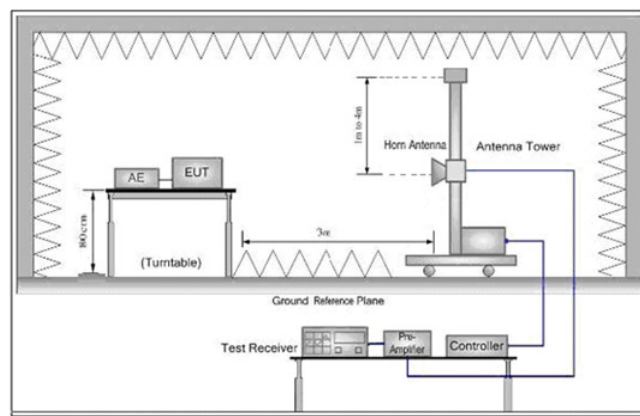

Figure 3. Above 1 GHz

**Test Procedure:**

- a. The EUT was placed on the top of a rotating table 0.8 meters above the ground at a 3 meter semi-anechoic chamber. The table was rotated 360 degrees to determine the position of the highest radiation.
- b. The EUT was set 3 meters away from the interference-receiving antenna, which was mounted on the top of a variable-height antenna tower.
- c. The antenna height is varied from one meter to four meters above the ground to determine the maximum value of the field strength. Both horizontal and vertical polarizations of the antenna are set to make the measurement.
- d. For each suspected emission, the EUT was arranged to its worst case and then the antenna was tuned to heights from 1 meter to 4 meters (for the test frequency of below 30MHz, the antenna was tuned to heights 1 meter) and the rotatable table was turned from 0 degrees to 360 degrees to find the maximum reading.
- e. The test-receiver system was set to Peak Detect Function and Specified Bandwidth with Maximum Hold Mode.
- f. If the emission level of the EUT in peak mode was 10dB lower than the limit specified, then testing could be stopped and the peak values of the EUT would be reported. Otherwise the emissions that did not have 10dB



**SGS-CSTC Standards Technical Services Co., Ltd.  
Shenzhen Branch**

Report No.: SZEM150500286501

Page: 46 of 59

	<p>margin would be re-tested one by one using peak, quasi-peak or average method as specified and then reported in a data sheet.</p> <p>g. Test the EUT in the lowest channel (2402MHz),the middle channel (2441MHz),the Highest channel (2480MHz)</p> <p>h. The radiation measurements are performed in X, Y, Z axis positioning for Transmitting mode, and found the X axis positioning which it is the worst case.</p> <p>i. Repeat above procedures until all frequencies measured was complete.</p>
Exploratory Test Mode:	Non-hopping transmitting mode with all kind of modulation and all kind of data type Transmitting mode.
Final Test Mode:	Through Pre-scan, find the DH1 of data type and GFSK modulation is the worst case. For below 1GHz part, through pre-scan, the worst case is the lowest channel. Only the worst case is recorded in the report.
Instruments Used:	Refer to section 5.10 for details
Test Results:	Pass



"This document is issued by the Company subject to its General Conditions of Service printed overleaf, available on request or accessible at [www.sgs.com/terms\\_and\\_conditions.htm](http://www.sgs.com/terms_and_conditions.htm) and, for electronic format documents, subject to Terms and Conditions for Electronic Documents at [www.sgs.com/terms\\_e-document.htm](http://www.sgs.com/terms_e-document.htm). Attention is drawn to the limitation of liability, indemnification and jurisdiction issues defined therein. Any holder of this document is advised that information contained hereon reflects the Company's findings at the time of its intervention only and within the limits of Client's instructions, if any. The Company's sole responsibility is to its Client and this document does not exonerate parties to a transaction from exercising all their rights and obligations under the transaction documents. This document cannot be reproduced except in full, without prior written approval of the Company. Any unauthorized alteration, forgery or falsification of the content or appearance of this document is unlawful and offenders may be prosecuted to the fullest extent of the law. Unless otherwise stated the results shown in this test report refer only to the sample(s) tested and such sample(s) are retained for 90 days only."



6.10.1 Radiated Emission below 1GHz

30MHz~1GHz (QP)		
Test mode:	Transmitting	Vertical

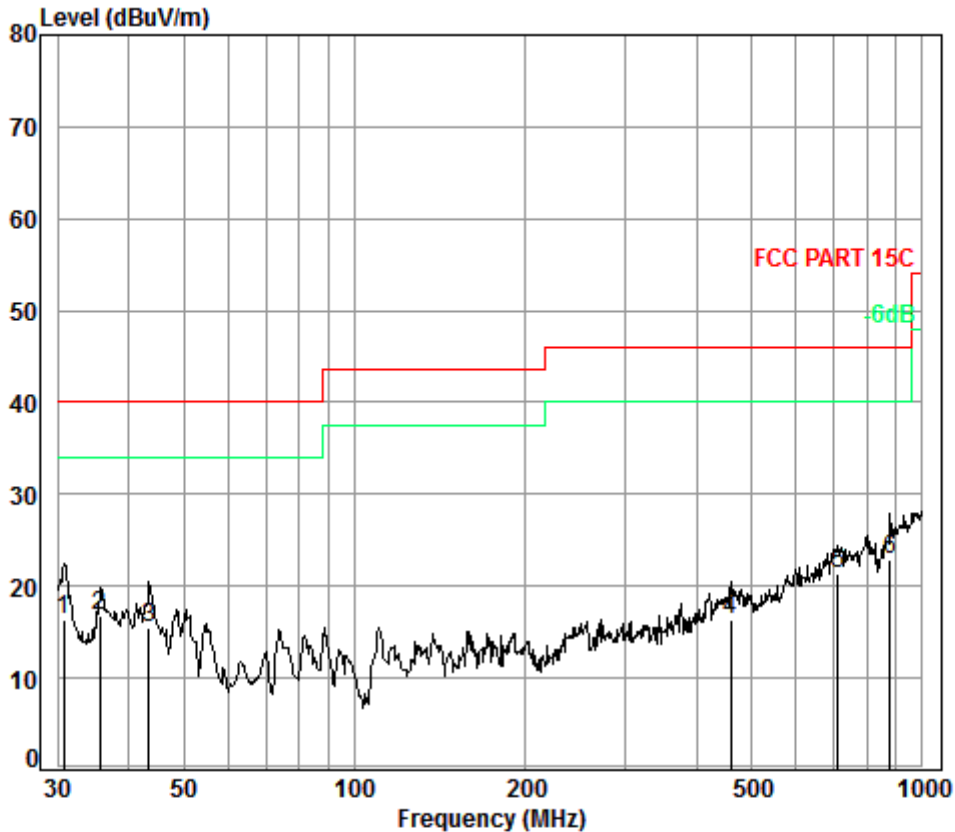

Condition: FCC PART 15C 3m Vertical

Job No. : 2865CR

Test Mode: TX mode

	Freq	Cable Loss	Ant Factor	Preamp Factor	Read Level	Limit Level	Limit Line	Over Limit
	MHz	dB	dB/m	dB	dBuV	dBuV/m	dBuV/m	dB
1	30.75	0.60	18.28	27.35	24.90	16.43	40.00	-23.57
2	35.62	0.60	15.55	27.33	27.96	16.78	40.00	-23.22
3	43.51	0.68	11.56	27.31	30.63	15.56	40.00	-24.44
4	459.11	2.45	17.23	27.50	24.25	16.43	46.00	-29.57
5	711.67	2.94	21.60	27.40	24.31	21.45	46.00	-24.55
6	878.32	3.52	23.03	26.89	23.26	22.92	46.00	-23.08

"This document is issued by the Company subject to its General Conditions of Service printed overleaf, available on request or accessible at [www.sgs.com/terms\\_and\\_conditions.htm](http://www.sgs.com/terms_and_conditions.htm) and, for electronic format documents, subject to Terms and Conditions for Electronic Documents at [www.sgs.com/terms\\_e-document.htm](http://www.sgs.com/terms_e-document.htm). Attention is drawn to the limitation of liability, indemnification and jurisdiction issues defined therein. Any holder of this document is advised that information contained hereon reflects the Company's findings at the time of its intervention only and within the limits of Client's instructions, if any. The Company's sole responsibility is to its Client and this document does not exonerate parties to a transaction from exercising all their rights and obligations under the transaction documents. This document cannot be reproduced except in full, without prior written approval of the Company. Any unauthorized alteration, forgery or falsification of the content or appearance of this document is unlawful and offenders may be prosecuted to the fullest extent of the law. Unless otherwise stated the results shown in this test report refer only to the sample(s) tested and such sample(s) are retained for 90 days only."



Test mode:	Transmitting	Horizontal
------------	--------------	------------

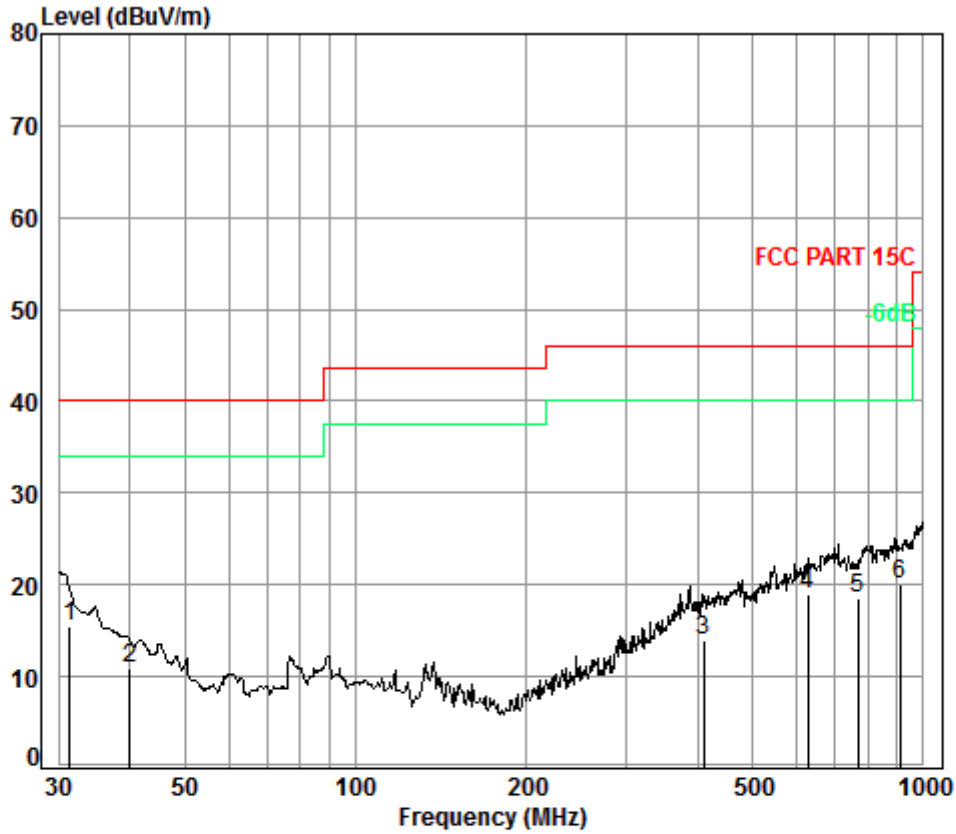

Condition: FCC PART 15C 3m HORIZONTAL

Job No. : 2865CR

Test Mode: TX mode

	Freq	Cable Loss	Ant Factor	Preamp Factor	Read Level	Level	Limit Line	Over Limit
	MHz	dB	dB/m	dB	dBuV	dBuV/m	dBuV/m	dB
1	31.40	0.60	17.92	27.35	24.40	15.57	40.00	-24.43
2	40.13	0.60	13.04	27.32	24.56	10.88	40.00	-29.12
3	410.38	2.24	16.34	27.19	22.64	14.03	46.00	-31.97
4	627.27	2.76	20.51	27.51	23.22	18.98	46.00	-27.02
5	768.75	3.11	21.92	27.33	20.90	18.60	46.00	-27.40
6	909.67	3.61	23.24	26.71	19.84	19.98	46.00	-26.02

"This document is issued by the Company subject to its General Conditions of Service printed overleaf, available on request or accessible at [www.sgs.com/terms\\_and\\_conditions.htm](http://www.sgs.com/terms_and_conditions.htm) and, for electronic format documents, subject to Terms and Conditions for Electronic Documents at [www.sgs.com/terms\\_e-document.htm](http://www.sgs.com/terms_e-document.htm). Attention is drawn to the limitation of liability, indemnification and jurisdiction issues defined therein. Any holder of this document is advised that information contained hereon reflects the Company's findings at the time of its intervention only and within the limits of Client's instructions, if any. The Company's sole responsibility is to its Client and this document does not exonerate parties to a transaction from exercising all their rights and obligations under the transaction documents. This document cannot be reproduced except in full, without prior written approval of the Company. Any unauthorized alteration, forgery or falsification of the content or appearance of this document is unlawful and offenders may be prosecuted to the fullest extent of the law. Unless otherwise stated the results shown in this test report refer only to the sample(s) tested and such sample(s) are retained for 90 days only."





**6.10.2 Transmitter Emission above 1GHz**

Worse case mode:		GFSK(DH1)		Test channel:		Lowest		Remark:	Peak
Frequency (MHz)	Cable Loss (dB)	Antenna Factor (dB/m)	Preamp Factor (dB)	Read Level (dBuV)	Level (dBuV/m)	Limit Line (dBuV/m)	Over Limit (dB)	Polarization	
3735.000	-32.40	32.80	0.00	42.50	42.90	74.00	-31.10	Vertical	
4804.000	-31.80	34.30	0.00	43.40	45.90	74.00	-28.10	Vertical	
6030.000	-30.40	34.90	0.00	41.00	45.50	74.00	-28.50	Vertical	
7206.000	-30.20	35.80	0.00	41.50	47.10	74.00	-26.90	Vertical	
9608.000	-27.90	37.20	0.00	37.50	46.80	74.00	-27.20	Vertical	
12840.000	-27.10	38.20	0.00	37.90	49.00	74.00	-25.00	Vertical	
3810.000	-32.40	33.10	0.00	41.50	42.20	74.00	-31.80	Horizontal	
4804.000	-31.80	34.30	0.00	43.90	46.40	74.00	-27.60	Horizontal	
5940.000	-30.40	34.70	0.00	41.00	45.30	74.00	-28.70	Horizontal	
7206.000	-30.20	35.80	0.00	50.30	55.90	74.00	-18.10	Horizontal	
9608.000	-27.90	37.20	0.00	37.40	46.70	74.00	-27.30	Horizontal	
12225.000	-26.60	37.90	0.00	37.00	48.30	74.00	-25.70	Horizontal	

Worse case mode:		GFSK(DH1)		Test channel:		Lowest		Remark:	Average
Frequency (MHz)	Cable loss (dB)	Antenna factors (dB/m)	Preamp factor (dB)	Reading Level (dBμV)	Emission Level (dBμV/m)	Limit (dBμV/m)	Over Limit (dB)	Polarization	
7,206.000	-30.20	35.80	0.00	35.80	41.40	54.00	-12.60	Horizontal	

"This document is issued by the Company subject to its General Conditions of Service printed overleaf, available on request or accessible at [www.sgs.com/terms\\_and\\_conditions.htm](http://www.sgs.com/terms_and_conditions.htm) and, for electronic format documents, subject to Terms and Conditions for Electronic Documents at [www.sgs.com/terms\\_e-document.htm](http://www.sgs.com/terms_e-document.htm). Attention is drawn to the limitation of liability, indemnification and jurisdiction issues defined therein. Any holder of this document is advised that information contained hereon reflects the Company's findings at the time of its intervention only and within the limits of Client's instructions, if any. The Company's sole responsibility is to its Client and this document does not exonerate parties to a transaction from exercising all their rights and obligations under the transaction documents. This document cannot be reproduced except in full, without prior written approval of the Company. Any unauthorized alteration, forgery or falsification of the content or appearance of this document is unlawful and offenders may be prosecuted to the fullest extent of the law. Unless otherwise stated the results shown in this test report refer only to the sample(s) tested and such sample(s) are retained for 90 days only."



**SGS-CSTC Standards Technical Services Co., Ltd.**  
**Shenzhen Branch**

Report No.: SZEM150500286501

Page: 50 of 59

Worse case mode:		GFSK(DH1)		Test channel:		Middle		Remark:		Peak
Frequency (MHz)	Cable Loss (dB)	Antenna Factor (dB/m)	Preamp Factor (dB)	Read Level (dBuV)	Level (dBuV/m)	Limit Line (dBuV/m)	Over Limit (dB)	Polarization		
3915.000	-32.50	33.20	0.00	41.40	42.10	74.00	-31.90	Vertical		
4882.000	-31.80	34.60	0.00	47.20	50.00	74.00	-24.00	Vertical		
5955.000	-30.40	34.70	0.00	41.00	45.30	74.00	-28.70	Vertical		
7323.000	-30.10	35.70	0.00	45.70	51.30	74.00	-22.70	Vertical		
9764.000	-27.30	37.30	0.00	38.10	48.10	74.00	-25.90	Vertical		
12195.000	-26.60	37.90	0.00	36.80	48.10	74.00	-25.90	Vertical		
3810.000	-32.40	33.10	0.00	41.60	42.30	74.00	-31.70	Horizontal		
4882.000	-31.80	34.60	0.00	45.90	48.70	74.00	-25.30	Horizontal		
5895.000	-30.40	34.60	0.00	41.50	45.70	74.00	-28.30	Horizontal		
7323.000	-30.10	35.70	0.00	50.00	55.60	74.00	-18.40	Horizontal		
9764.000	-27.30	37.30	0.00	43.20	53.20	74.00	-20.80	Horizontal		
11985.000	-30.10	35.70	0.00	42.20	47.80	74.00	-26.20	Horizontal		

Worse case mode:		GFSK(DH1)		Test channel:		Middle		Remark:		Average
Frequency (MHz)	Cable loss (dB)	Antenna factors (dB/m)	Preamp factor (dB)	Reading Level (dBμV)	Emission Level (dBμV/m)	Limit (dBμV/m)	Over Limit (dB)	Polarization		
7323.000	-30.10	35.70	0.00	35.60	41.20	54.00	-12.80	Horizontal		

"This document is issued by the Company subject to its General Conditions of Service printed overleaf, available on request or accessible at [www.sgs.com/terms\\_and\\_conditions.htm](http://www.sgs.com/terms_and_conditions.htm) and, for electronic format documents, subject to Terms and Conditions for Electronic Documents at [www.sgs.com/terms\\_e-document.htm](http://www.sgs.com/terms_e-document.htm). Attention is drawn to the limitation of liability, indemnification and jurisdiction issues defined therein. Any holder of this document is advised that information contained hereon reflects the Company's findings at the time of its intervention only and within the limits of Client's instructions, if any. The Company's sole responsibility is to its Client and this document does not exonerate parties to a transaction from exercising all their rights and obligations under the transaction documents. This document cannot be reproduced except in full, without prior written approval of the Company. Any unauthorized alteration, forgery or falsification of the content or appearance of this document is unlawful and offenders may be prosecuted to the fullest extent of the law. Unless otherwise stated the results shown in this test report refer only to the sample(s) tested and such sample(s) are retained for 90 days only."



**SGS-CSTC Standards Technical Services Co., Ltd.  
Shenzhen Branch**

Report No.: SZEM150500286501

Page: 51 of 59

Worse case mode:		GFSK(DH1)		Test channel:		Highest		Remark:	Peak
Frequency (MHz)	Cable Loss (dB)	Antenna Factor (dB/m)	Preamp Factor (dB)	Read Level (dBuV)	Level (dBuV/m)	Limit Line (dBuV/m)	Over Limit (dB)	Polarization	
3885.000	-32.50	33.20	0.00	42.60	43.30	74.00	-30.70	Vertical	
4960.000	-31.70	34.60	0.00	43.90	46.80	74.00	-27.20	Vertical	
6000.000	-30.30	34.90	0.00	41.70	46.30	74.00	-27.70	Vertical	
7440.000	-30.00	35.80	0.00	45.20	51.00	74.00	-23.00	Vertical	
9920.000	-26.60	37.30	0.00	39.80	50.50	74.00	-23.50	Vertical	
12720.000	-26.80	38.10	0.00	37.20	48.50	74.00	-25.50	Vertical	
3900.000	-32.50	33.20	0.00	41.80	42.50	74.00	-31.50	Horizontal	
4960.000	-31.70	34.60	0.00	44.20	47.10	74.00	-26.90	Horizontal	
6015.000	-30.30	34.90	0.00	41.30	45.90	74.00	-28.10	Horizontal	
7440.000	-30.00	35.80	0.00	50.50	56.30	74.00	-17.70	Horizontal	
9920.000	-26.60	37.30	0.00	40.70	51.40	74.00	-22.60	Horizontal	
12150.000	-26.60	37.90	0.00	37.10	48.40	74.00	-25.60	Horizontal	

Worse case mode:		GFSK(DH1)		Test channel:		Highest		Remark:	Average
Frequency (MHz)	Cable loss (dB)	Antenna factors (dB/m)	Preamp factor (dB)	Reading Level (dBμV)	Emission Level (dBμV/m)	Limit (dBμV/m)	Over Limit (dB)	Polarization	
7440.000	-30.00	35.80	0.00	37.00	42.80	54.00	-11.20	Horizontal	

Remark:

- 1) The field strength is calculated by adding the Antenna Factor, Cable Factor & Pre-amplifier. The basic equation with a sample calculation is as follows:  
Final Test Level = Receiver Reading + Antenna Factor + Cable Factor – Pre-amplifier Factor
- 2) Scan from 9kHz to 25GHz, the disturbance above 13GHz and below 30MHz was very low, and the above harmonics were the highest point could be found when testing, so only the above harmonics had been displayed. The amplitude of spurious emissions from the radiator which are attenuated more than 20dB below the limit need not be reported.
- 3) As shown in this section, for frequencies above 1GHz, the field strength limits are based on average limits. However, the peak field strength of any emission shall not exceed the maximum permitted average limits specified above by more than 20 dB under any condition of modulation. So, only the above measurement data were shown in the report.

"This document is issued by the Company subject to its General Conditions of Service printed overleaf, available on request or accessible at [www.sgs.com/terms\\_and\\_conditions.htm](http://www.sgs.com/terms_and_conditions.htm) and, for electronic format documents, subject to Terms and Conditions for Electronic Documents at [www.sgs.com/terms\\_e-document.htm](http://www.sgs.com/terms_e-document.htm). Attention is drawn to the limitation of liability, indemnification and jurisdiction issues defined therein. Any holder of this document is advised that information contained hereon reflects the Company's findings at the time of its intervention only and within the limits of Client's instructions, if any. The Company's sole responsibility is to its Client and this document does not exonerate parties to a transaction from exercising all their rights and obligations under the transaction documents. This document cannot be reproduced except in full, without prior written approval of the Company. Any unauthorized alteration, forgery or falsification of the content or appearance of this document is unlawful and offenders may be prosecuted to the fullest extent of the law. Unless otherwise stated the results shown in this test report refer only to the sample(s) tested and such sample(s) are retained for 90 days only."

### 6.11 Restricted bands around fundamental frequency

Test Requirement:	47 CFR Part 15C Section 15.209 and 15.205		
Test Method:	ANSI C63.10: 2009		
Test Site:	Measurement Distance: 3m (Semi-Anechoic Chamber)		
Limit:	Frequency	Limit (dBuV/m @3m)	Remark
	30MHz-88MHz	40.0	Quasi-peak Value
	88MHz-216MHz	43.5	Quasi-peak Value
	216MHz-960MHz	46.0	Quasi-peak Value
	960MHz-1GHz	54.0	Quasi-peak Value
	Above 1GHz	54.0	Average Value
74.0		Peak Value	
Test Setup:			

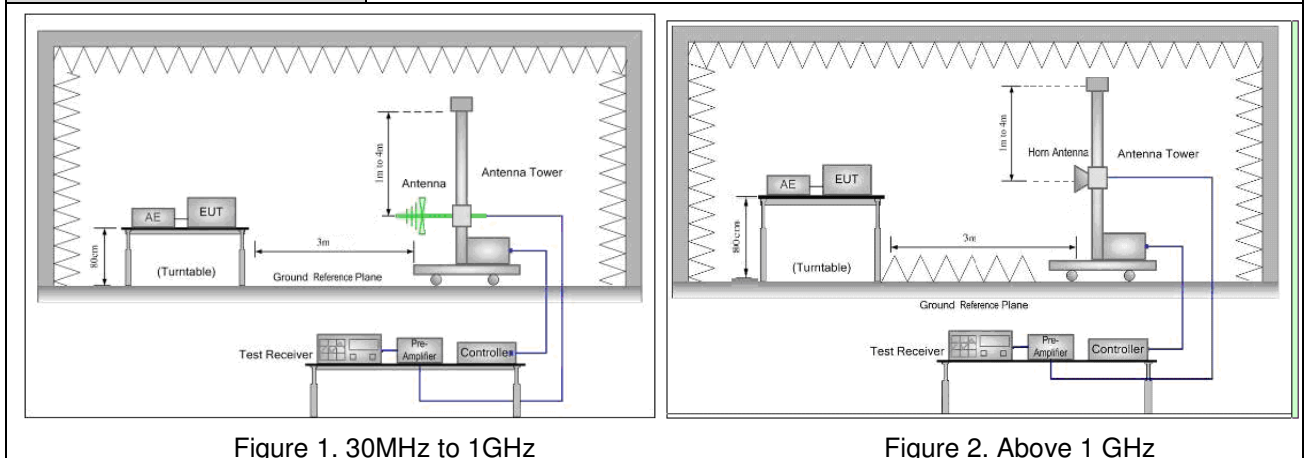

Figure 1. 30MHz to 1GHz

Figure 2. Above 1 GHz



Test Procedure:	<ul style="list-style-type: none"><li>a. The EUT was placed on the top of a rotating table 0.8 meters above the ground at a 3 meter semi-anechoic chamber. The table was rotated 360 degrees to determine the position of the highest radiation.</li><li>b. The EUT was set 3 meters away from the interference-receiving antenna, which was mounted on the top of a variable-height antenna tower.</li><li>c. The antenna height is varied from one meter to four meters above the ground to determine the maximum value of the field strength. Both horizontal and vertical polarizations of the antenna are set to make the measurement.</li><li>d. For each suspected emission, the EUT was arranged to its worst case and then the antenna was tuned to heights from 1 meter to 4 meters and the rotatable table was turned from 0 degrees to 360 degrees to find the maximum reading.</li><li>e. The test-receiver system was set to Peak Detect Function and Specified Bandwidth with Maximum Hold Mode.</li><li>f. Place a marker at the end of the restricted band closest to the transmit frequency to show compliance. Also measure any emissions in the restricted bands. Save the spectrum analyzer plot. Repeat for each power and modulation for lowest and highest channel</li><li>g. Test the EUT in the lowest channel , the Highest channel</li><li>h. The radiation measurements are performed in X, Y, Z axis positioning for Transmitting mode, and found the X axis positioning which it is the worst case.</li><li>i. Repeat above procedures until all frequencies measured was complete.</li></ul>
Exploratory Test Mode:	Non-hopping transmitting mode with all kind of data type .Transmitting mode.
Final Test Mode:	Through Pre-scan, find the DH5 of data type and GFSK modulation is the worst case. Only the worst case is recorded in the report.
Instruments Used:	Refer to section 5.10 for details
Test Results:	Pass

Test plot as follows:

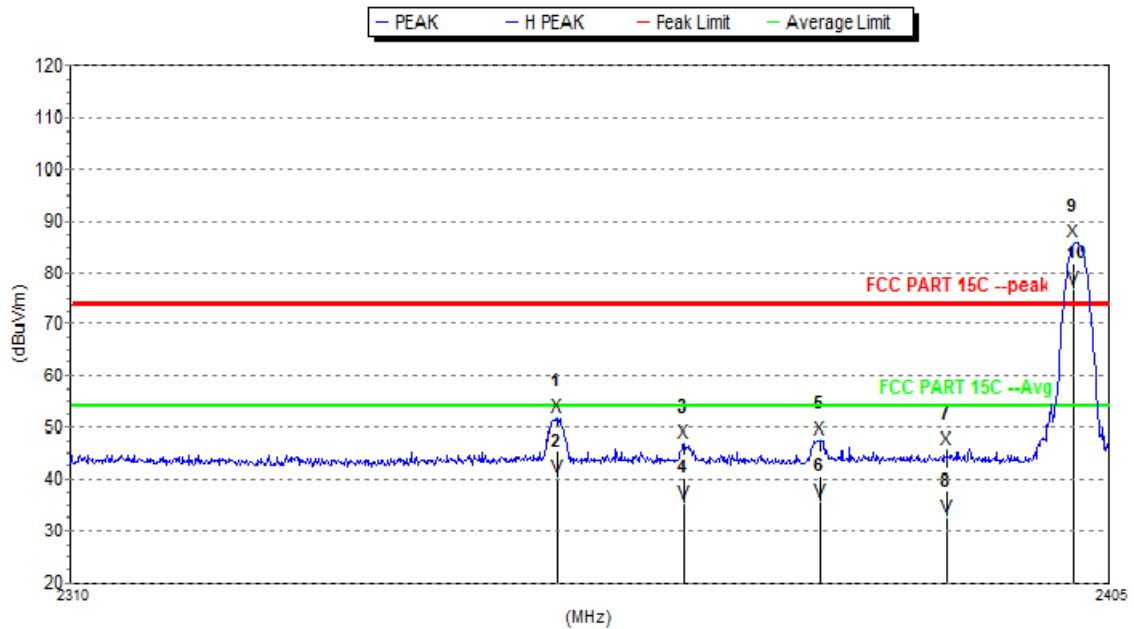

Mk.	Freq.(MHz)	Level(dBuV/m)	Limit(dBuV/m)	Margin(dB)	Ant.F.(dB/m)	Amp.G.(dB)	Cbl.L.(dB)	Pol.
Peak:								
1	2354.175	52.0	74.0	22.0	32.2	0.0	-20.8	H
2	2365.765	47.1	74.0	26.9	32.3	0.0	-20.7	H
3	2378.115	47.7	74.0	26.3	32.4	0.0	-20.6	H
4	2390	45.6	74.0	28.4	32.5	0.0	-20.8	H
5 F	2401.770	85.9	74.0	-11.9	32.6	0.0	-21.0	H
Avg								
1	2354.175	40.3	54.0	13.7	32.2	0.0	-20.8	H
2	2365.765	35.3	54.0	18.7	32.3	0.0	-20.7	H
3	2378.115	35.6	54.0	18.4	32.4	0.0	-20.6	H
4	2390	32.6	54.0	21.4	32.5	0.0	-20.8	H
5 F	2401.770	76.9	54.0	-22.9	32.6	0.0	-21.0	H

"This document is issued by the Company subject to its General Conditions of Service printed overleaf, available on request or accessible at [www.sgs.com/terms\\_and\\_conditions.htm](http://www.sgs.com/terms_and_conditions.htm) and, for electronic format documents, subject to Terms and Conditions for Electronic Documents at [www.sgs.com/terms\\_e-document.htm](http://www.sgs.com/terms_e-document.htm). Attention is drawn to the limitation of liability, indemnification and jurisdiction issues defined therein. Any holder of this document is advised that information contained hereon reflects the Company's findings at the time of its intervention only and within the limits of Client's instructions, if any. The Company's sole responsibility is to its Client and this document does not exonerate parties to a transaction from exercising all their rights and obligations under the transaction documents. This document cannot be reproduced except in full, without prior written approval of the Company. Any unauthorized alteration, forgery or falsification of the content or appearance of this document is unlawful and offenders may be prosecuted to the fullest extent of the law. Unless otherwise stated the results shown in this test report refer only to the sample(s) tested and such sample(s) are retained for 90 days only."

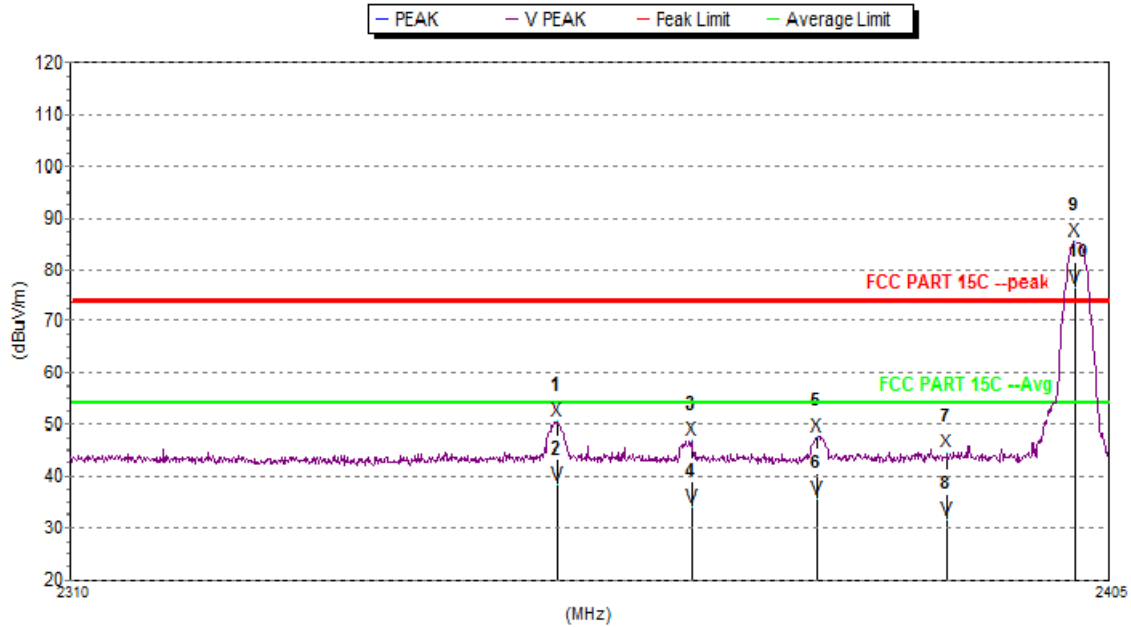

Mk.	Freq.(MHz)	Level(dBuV/m)	Limit(dBuV/m)	Margin(dB)	Ant.F.(dB/m)	Amp.G.(dB)	Cbl.L.(dB)	Pol.
Peak:								
1	2354.080	50.7	74.0	23.3	32.2	0.0	-20.8	V
2	2366.430	47.0	74.0	27.0	32.3	0.0	-20.7	V
3	2377.830	47.9	74.0	26.1	32.4	0.0	-20.6	V
4	2390	44.9	74.0	29.1	32.5	0.0	-20.8	V
5 F	2401.865	85.5	74.0	-11.5	32.6	0.0	-21.0	V
Avg								
1	2354.080	38.3	54.0	15.7	32.2	0.0	-20.8	V
2	2366.430	34.2	54.0	19.8	32.3	0.0	-20.7	V
3	2377.830	35.6	54.0	18.4	32.4	0.0	-20.6	V
4	2390	31.7	54.0	22.3	32.5	0.0	-20.8	V
5 F	2401.865	76.4	54.0	-22.4	32.6	0.0	-21.0	V

"This document is issued by the Company subject to its General Conditions of Service printed overleaf, available on request or accessible at [www.sgs.com/terms\\_and\\_conditions.htm](http://www.sgs.com/terms_and_conditions.htm) and, for electronic format documents, subject to Terms and Conditions for Electronic Documents at [www.sgs.com/terms\\_e-document.htm](http://www.sgs.com/terms_e-document.htm). Attention is drawn to the limitation of liability, indemnification and jurisdiction issues defined therein. Any holder of this document is advised that information contained hereon reflects the Company's findings at the time of its intervention only and within the limits of Client's instructions, if any. The Company's sole responsibility is to its Client and this document does not exonerate parties to a transaction from exercising all their rights and obligations under the transaction documents. This document cannot be reproduced except in full, without prior written approval of the Company. Any unauthorized alteration, forgery or falsification of the content or appearance of this document is unlawful and offenders may be prosecuted to the fullest extent of the law. Unless otherwise stated the results shown in this test report refer only to the sample(s) tested and such sample(s) are retained for 90 days only."

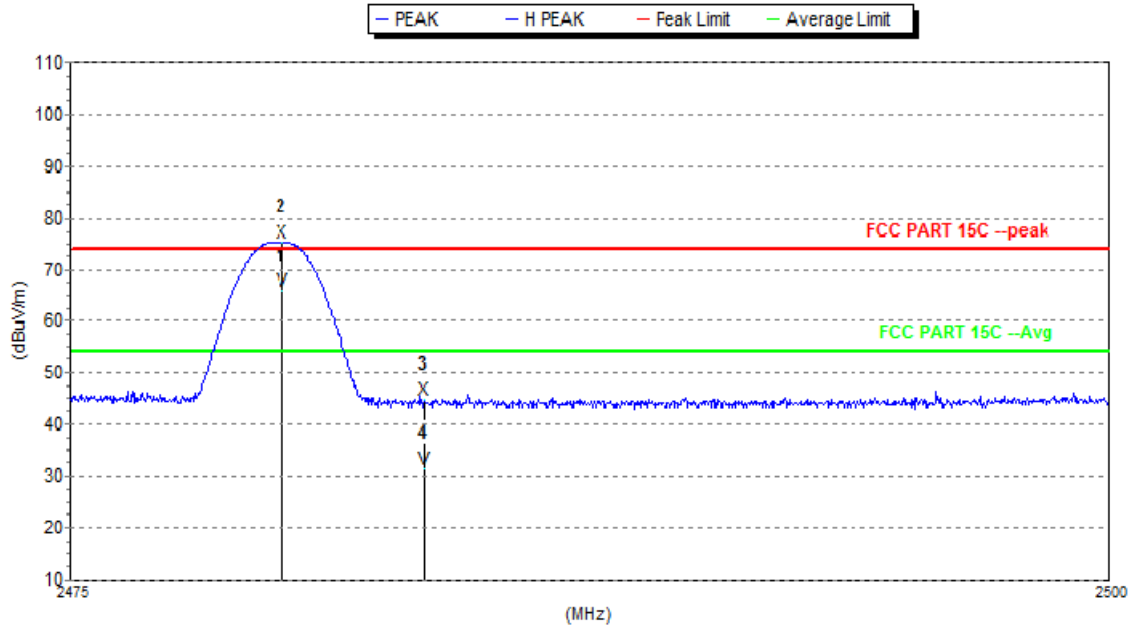

Mk.	Freq.(MHz)	Level(dBuV/m)	Limit(dBuV/m)	Margin(dB)	Ant.F.(dB/m)	Amp.G.(dB)	Cbl.L.(dB)	Pol.
Peak:								
1 F	2480.100	75.3	74.0	-1.3	32.5	0.0	-20.5	H
2	2483.5	44.7	74.0	29.3	32.5	0.0	-20.5	H
Avg								
1 F	2480.100	65.9	54.0	-11.9	32.5	0.0	-20.5	H
2	2483.5	31.3	54.0	22.7	32.5	0.0	-20.5	H





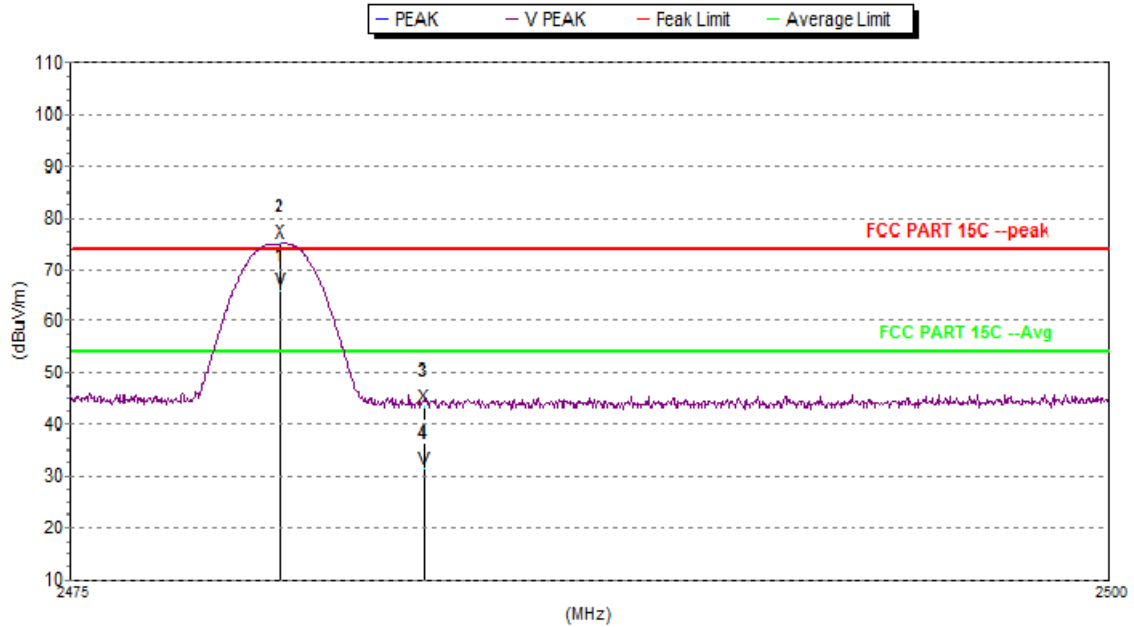

Mk.	Freq.(MHz)	Level(dBuV/m)	Limit(dBuV/m)	Margin(dB)	Ant.F.(dB/m)	Amp.G.(dB)	Cbl.L.(dB)	Pol.
Peak:								
1 F	2480.075	75.1	74.0	-1.1	32.5	0.0	-20.5	V
2	2483.5	43.5	74.0	30.5	32.5	0.0	-20.5	V
Avg								
1 F	2480.075	65.9	54.0	-11.9	32.5	0.0	-20.5	V
2	2483.5	31.5	54.0	22.5	32.5	0.0	-20.5	V

**Note:**

The field strength is calculated by adding the Antenna Factor, Cable Factor & Preamplifier. The basic equation with a sample calculation is as follows:

$$\text{Final Test Level} = \text{Receiver Reading} + \text{Antenna Factor} + \text{Cable Factor} - \text{Preamplifier Factor}$$

"This document is issued by the Company subject to its General Conditions of Service printed overleaf, available on request or accessible at [www.sgs.com/terms\\_and\\_conditions.htm](http://www.sgs.com/terms_and_conditions.htm) and, for electronic format documents, subject to Terms and Conditions for Electronic Documents at [www.sgs.com/terms\\_e-document.htm](http://www.sgs.com/terms_e-document.htm). Attention is drawn to the limitation of liability, indemnification and jurisdiction issues defined therein. Any holder of this document is advised that information contained hereon reflects the Company's findings at the time of its intervention only and within the limits of Client's instructions, if any. The Company's sole responsibility is to its Client and this document does not exonerate parties to a transaction from exercising all their rights and obligations under the transaction documents. This document cannot be reproduced except in full, without prior written approval of the Company. Any unauthorized alteration, forgery or falsification of the content or appearance of this document is unlawful and offenders may be prosecuted to the fullest extent of the law. Unless otherwise stated the results shown in this test report refer only to the sample(s) tested and such sample(s) are retained for 90 days only."

## 7 Photographs - EUT Test Setup

Test model No.: WS-SQB956

### 7.1 Radiated Emission



### 7.2 Radiated Spurious Emission





## **8 Photographs - EUT Constructional Details**

Appendix A - Photographs of EUT Constructional Details for SZEM1505002865CR.