



Stay Connected with the
World's Premier Revolutionary
DAS Solution



In-Building Wireless Solution User Manual

Software Version 5.21

© 2016-2023 Zinwave Ltd All Rights Reserved

Zinwave retains all ownership rights to all computer programs offered by Zinwave, their products, and the contents of this manual. The source code for both software and firmware are confidential trade secrets of Zinwave. You may not attempt to decipher, decompile, develop or otherwise reverse engineer Zinwave software, firmware, or products. Information necessary to achieve interoperability is furnished upon request.

This manual is furnished under license and may only be used or copied in accordance with the terms of such license. The information in the manual is furnished for informational use only, is subject to change without notice, and should not be construed as commitment by Zinwave. Zinwave assumes no responsibility or liability for any errors or inaccuracies that may appear in this manual. No part of this manual may be reproduced, stored in a retrieval system, or transmitted, in any form or by any means, electronic, mechanical, recording, or otherwise, without the express written permission of Zinwave.

Existing artwork or images that you may desire to scan may be protected by copyright law. Be sure to obtain permission for use of existing artwork.

Trademarks

This product carries the Trademark of Zinwave, Ltd. All the trademarks of component parts used by Zinwave in the manufacture of this product are the property of their respective owners. The Zinwave logo is a registered trademark of Zinwave

All brand or product names are trademarks or registered trademarks of their respective companies or organizations.

Warranty

The material contained in this document is provided “as is,” and is subject to being changed, without notice, in future editions. Further, to the maximum extent permitted by applicable law, Zinwave disclaims all warranties, either express or implied, with regard to this manual and any information contained herein, including but not limited to the implied warranties of merchantability and fitness for a particular purpose. Zinwave shall not be liable for errors or for incidental or consequential damages in connection with the furnishing, use, or performance of this document or of any information contained herein. Should Zinwave and the user have a separate written agreement with warranty terms covering the material in this document that conflict with these terms, the warranty terms in the separate agreement shall control

Table of Contents

Safety and Regulatory Information.....	vii
Safety Information.....	vii
RF Exposure.....	vii
Installation.....	vii
Signal and Input Power	vii
Fiber Considerations	viii
Optical Safety Precautions	ix
Software Installation	ix
Symbols	x
Regulatory Information.....	x
UL NRTL Listing	xi
FCC	xi
About this Manual.....	xiv
Intended Audience	xiv
Conventions	xiv
Getting Help	xiv
1 System Overview.....	1-1
1.1 How Does It Work?	1-1
1.2 Key Features.....	1-2
1.3 Network Topologies	1-2
1.3.1 Single-Star Configuration.....	1-3
1.3.2 Double Star Configuration	1-3
1.3.3 Mixed Topology Configuration	1-4
1.3.4 Support for MIMO Services	1-4
1.4 Understanding Optional Components.....	1-5
1.4.1 How the PSU Fits in.....	1-5
1.4.2 How the Uniwave POI Fits in	1-6
2 Understanding the Components	2-1
2.1 Hubs.....	2-1
2.1.1 Configuration GUI	2-1
2.1.2 Primary Hub	2-2
2.1.3 Secondary Hub	2-3
2.2 Service Module	2-4
2.3 Optical Module	2-5
2.4 Transport Module	2-6

2.5	Remote Unit	2-7
2.5.1	Antennas	2-8
2.6	Fiber Patch Cords	2-9
3	Hub and Module LEDs.....	3-10
3.1	Primary Hub Front Panel LEDs.....	3-10
3.2	Secondary Hub Status LEDs.....	3-10
3.2.1	Optical Link to Primary Hub	3-10
3.2.2	Optical Links to 8x Remote Units.....	3-11
3.2.3	Secondary Hub Status LEDs	3-11
3.3	Service, Optical and Transport Module LEDs.....	3-11
3.3.1	Power LED—Right.....	3-12
3.3.2	Communications—Middle	3-12
3.3.3	Status—Left	3-13
3.4	Start-up Sequence	3-13
3.4.1	Service Module	3-13
3.4.2	Optical Module	3-13
3.4.3	Transport Module.....	3-14
3.5	Remote Unit LEDs	3-15
4	Performing a Basic Installation	4-2
5	Installing and Populating Hubs	5-1
5.1	Installing the Hub	5-1
5.1.1	Mounting Kit.....	5-1
5.1.2	Standard 19" (48.26cm) Rack Mounting	5-2
5.1.3	Open Frame Rack Mounting.....	5-3
5.1.4	Installing Blank Panels.....	5-4
5.2	Installing Secondary Hub	5-5
5.3	Installing Service Modules in Primary Hub	5-7
5.4	Installing Optical Modules in Primary Hub	5-8
5.5	Powering the Primary Hub	5-8
5.6	Powering the Secondary Hub	5-9
6	Installing Remote Units	6-1
6.1	Mounting Remote Units	6-1
6.1.1	Considerations before Mounting.....	6-1
6.2	Powering Remote Units	6-7
6.2.1	PSU DC Power	6-7
7	DAS Installation Considerations	7-1
7.1	Antenna Requirements	7-1

7.1.1	Isolation.....	7-1
7.1.2	Isolation Measurement Techniques.....	7-1
7.2	Uplink/Downlink Balance	7-2
7.3	Connecting Antennas to Remote Units.....	7-2
7.4	Connecting the PSU or Secondary Hub Power Port to Remote Units	7-2
7.4.1	Power Distribution Requirements.....	7-2
7.4.2	Understanding Connectors & Cabling	7-3
7.5	Uplink System Noise	7-4
7.5.1	Introduction	7-4
7.5.2	Optimising SNR and Noise Level	7-4
7.5.3	UniTransport	7-6
8	Performing Basic Configuration.....	8-7
9	Understanding the Configuration GUI.....	9-2
9.1	Supported Browsers.....	9-2
9.2	Initial Standalone Access	9-2
9.3	Accessing the GUI	9-4
9.4	Understanding the Main Window	9-6
9.4.1	Address Bar	9-6
9.4.2	Login Bar.....	9-6
9.4.3	Help Button	9-6
9.4.4	Display Area.....	9-7
9.4.5	Progress Indicator.....	9-7
9.4.6	Changing User Passwords and Timeouts	9-8
10	Initial System Setup.....	10-1
10.1	Connection to DAS System	10-1
10.2	Software Upgrade	10-1
10.2.1	Full System Software Upgrade	10-1
10.2.2	To update RU and SH Firmware from an Installed Primary Hub Software Release: 10-3	
10.3	System Setup.....	10-3
10.3.1	Import Coverage Tool setting	10-3
10.3.2	Primary Hub Configuration	10-3
10.3.3	Service Frequency Range and Regulatory Territory	10-4
10.3.4	Service Module Downlink AGC.....	10-5
10.3.5	Transport Module AGC.....	10-5
10.3.6	Rack-Mount Power Supply Unit Configuration	10-6
10.3.7	Secondary Hub Configuration and Controls	10-6
10.3.8	Remote Unit Configuration	10-6
10.4	System Status	10-9
10.4.1	System Status Topology Tree and Modules.....	10-9

10.4.2	Unit and Module Details.....	10-9
10.5	Event Log.....	10-10
10.6	Hub Setup.....	10-10
10.6.1	Restart Hub.....	10-10
10.6.2	IP Settings.....	10-10
10.6.3	SNMP Settings.....	10-10
10.6.4	User Interface Settings.....	10-11
10.6.5	Date & Time.....	10-11
10.6.6	Security Settings.....	10-12
10.7	Alarms Setup.....	10-12
10.8	System Maintenance.....	10-12
10.9	System Views.....	10-13
10.9.1	System Snapshot.....	10-13
10.9.2	Alarm Counts.....	10-14
10.9.3	Link Quality.....	10-14
10.9.4	RU DC Power.....	10-14
10.9.5	RU Calculations.....	10-14
10.9.6	RF System Check.....	10-14
11	Additional System Setup.....	11-16
11.1	System Uplink/Downlink Balance.....	11-16
11.2	Calculated Input Level.....	11-16
11.3	Changing or Swapping Equipment.....	11-16
11.3.1	Hub.....	11-17
11.3.2	Remote Unit.....	11-17
11.3.3	Optical Module.....	11-17
11.4	Factory Reset of a Primary Hub.....	11-17
12	UniTransport System Setup.....	12-19
12.1	UniTransport Functionality.....	12-19
12.2	Configuration of UniTransport Hub.....	12-20
12.3	Configuration of Downstream Primary Hub.....	12-21
12.4	Remote Configuration of UniTransport Hub.....	12-22
13	Understanding Alarms & Reporting.....	13-24
13.1	Alarms.....	13-24
13.1.1	Loss of Service.....	13-24
13.1.2	Service Warning.....	13-25
13.1.3	Hardware Warning.....	13-27
13.1.4	Informational.....	13-29
13.2	Alarms Setup.....	13-30
13.3	Alarm Connections.....	13-30
13.4	SNMP.....	13-31

13.4.1	SNMP V3 Manager Configuration	13-31
13.4.2	SNMP Trap Events	13-32
13.4.3	SNMP Get Objects.....	13-32
13.4.4	3000 SNMP Traps	13-33
13.4.5	Additional 5000 SNMP Objects	13-33
14	Performing Diagnostics and Testing.....	14-1
14.1	Diagnosing Optical Links with an OTDR.....	14-1
14.1.1	Diagnose an Optical Link.....	14-1
14.2	LED Testing	14-2
14.2.1	Modules	14-2
14.2.2	Remote Unit LED Test.....	14-3
14.3	Event Log.....	14-4
14.3.1	Viewing and saving the Event Log.....	14-4
14.3.2	System Logging	14-4
14.4	Downloading Event Log	14-4
14.5	System Log	14-4
15	Specifications	15-1

Safety and Regulatory Information





Safety Information

The following safety warnings and cautions are listed to prevent damage to equipment or property and prevent any risk of personal injury.







RF Exposure

	Warning: This equipment complies with European, FCC and Canadian radiation exposure limits set forth for an occupational/ controlled environment. The Remote Unit should be operated with a minimum distance of 20cm (8 in) between antenna and your body
-----------------------------------------------------------------------------------	------------------------------------------------------------------------------------------------------------------------------------------------------------------------------------------------------------------------------------------------------------------

Installation

	Caution: Incorrect installation, operation, and use of this equipment may cause failure to product and could cause accidents which may harm personnel.
	Caution: Optical Module must ONLY be installed on the front panel of a Primary Hub or the unit will not function as expected.
	Warning: The Remote Unit should be installed in Restricted Access Locations only where the maximum ambient operating temperature is 50degC. If the Remote Unit is installed in an Operator Access Area, then the maximum ambient operating temperature must be de-rated to 45degC.
	Warning: This is NOT a CONSUMER device. It is designed for installation by an installer approved by an ISED licensee (Innovation, Science and Economic Development Canada). You MUST have an ISED LICENCE or the express consent of an ISED licensee to operate this device.





Signal and Input Power

	Warning: If the service module is connected directly to the output of a BTS or any RF input source, maximum power delivered to a service module must not exceed 15dBm (damage level is 22dBm). Use additional equipment to attenuate the power.
	Caution: The input power to the Zinwave Remote Unit should not exceed -10dBm. Power levels greater than +10dBm will damage the unit
	Caution: The total broadband composite output power of the 308-0007-1 Remote Unit is limited to +24 dBm in USA Caution: The total broadband composite output power of the 308-0007-2 Remote Unit is limited to +27 dBm in USA Contact Zinwave for the maximum output power in other regions.
	Caution: Alarm Relays on the Hubs and Remote Unit are intended for low voltage/current signaling only. Maximum operating voltage 50V, maximum operating current 1A.
  N	CAUTION :

DOUBLE POLE/NEUTRAL FUSING

The Power Supply Module in the Primary Hub 308-0001, and in the Secondary Hub 308-0004 has multiple sources and may include a fuse in the Neutral AC connection. Disconnect the AC mains supply to de-energize the phase conductors. After operation of the fuse, parts of the equipment that remain energized might represent a hazard during servicing.

Fiber Considerations

	Caution: Avoid dust ingress to fiber connectors by mounting the Remote Unit with the fiber connector facing downwards, or by leaving the dust-caps in place until the fiber is connected.
	Caution: Connector types must match (i.e. SC-APC to SC-APC). Otherwise, there will be an air gap between the connector faces that will create high back reflection and high optical loss.
	Caution: Zinwave hardware ONLY supports SINGLE Mode Fiber.
	Caution: Fiber handling procedures should be carefully observed so as not to damage or introduce dirt to fiber interfaces during installation.
	Caution: Observe safety precautions when working with fiber cables and devices.

Optical Safety Precautions

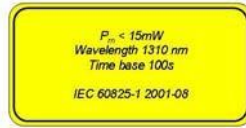
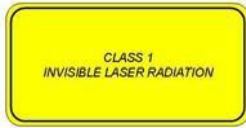











	Warning: Use of controls or adjustments or performance of procedures other than those specified herein may result in hazardous radiation exposure.
	Caution: Do not remove the fiber Port dust covers unless the port is in use. Do not stare directly into a fiber Port.
	Caution: Cover any unconnected fiber ends with an approved cap.
	Caution: Do not stare with unprotected eyes at any broken ends of the fiber.
	Caution: Use only approved methods for cleaning optical fiber connectors.
	Caution: Do not make any unauthorized modifications to this fiber optical system.
	Caution: No warning signs are required as it is a Class 1 hazard.
	Caution: Use Class 1 test equipment.

Software Installation

	Caution: When new firmware is being installed it is very important not to break or interrupt the connection between source file and the Hub. Interrupting firmware installation may put the Hub into an irrecoverable state that requires factory reset.
	Caution: While the system can be configured with poor optical links present, this may affect the system performance and such links should be examined and brought into specification in order to obtain optimum performance.

Symbols

This section identifies the symbols that are displayed on Uniwave devices. Labels or symbols may not appear on every device.

Symbol	Description
	Consult Manual
	Electric shock hazard
	UL certified UL NRTL Listing
	The European CE mark
	The UKCA (UK Conformity Assessed) marking is a new UK product marking that is used for goods being placed on the market in Great Britain (England, Wales and Scotland). It covers most goods which previously required the CE marking.
	ISO 9001 Certified
	USB Port
	Ethernet Port
	Electrostatic Discharge Sensitive
	This symbol indicates that the waste of electrical and electronic equipment must not be disposed as unsorted municipal waste and must be collected separately. Please contact an authorized representative of the manufacturer for information concerning the decommissioning of your equipment.

Regulatory Information

- EN 50174/50173 series: Information technology – Cabling installation
- ANSI/TIA/EIA-568 series North America Cabling
- ISO/IEC 11801 - International cabling
- IEC 60825-2: Safety of laser products – Part 2: Safety of optical fiber communication systems (OFCS)
- This equipment complies with 21CFR1040 - Performance Standards For Light-Emitting Products (FDA).
- EN 55032/CISPR32
- FCC Part 15 Class A
- European Radio Equipment Directive 2014/53/EU
- Electrical Safety IEC 60950-1 (Primary Hub); 62368-1:2014 (Secondary Hub, Remote Units)
- Laser Safety EN 60825-1:2014 (308-XXXX units)
- ISO 9001
- UL-60950-1

-
- RoHS DIRECTIVE 2011/65/EU
 - UL2043 compliance

In reference to UL2043 compliance, Remote Units are suitable for use in environmental air space in accordance with Section 300-22(c) of the National Electrical Code, and Sections 2-128, 12-010(3) and 12-100 of the Canadian Electrical Code, Part 1, CSA C22.1.

Note: The system contains a device which is classified as a “CLASS I LASER PRODUCT”, with an internal Class 1 laser source (as defined in CBTR # DE3-500286 by TUV). The component within the unit is in compliance with “U.S. Code of Federal Regulations, 21 CFR 1040”. See the Detailed Data Sheet for label placement.

UL NRTL Listing



Uniwave has been tested and shown to meet UL and CSA requirements through testing carried out at a Nationally Recognized Testing Laboratory (NRTL). The UL certification Mark indicates national compliance to UL and CSA standards by virtue of accreditations obtained.

Product: Distributed Antenna System

Model: Uniwave Primary Hub 308-0001, Secondary Hub 308-0004 and Remote Unit 308-0007-1 and 308-0007-2

UL Listing ID: E486578

FCC

FCC Compliance and Interference Statements

Hub: Uniwave devices comply with Part 15 of the FCC rules. Operation is subject to the following two conditions:

- 1) This device must accept any interference and
- 2) This device must accept any interference received including interference that may cause undesired operation

Changes or modifications not expressly approved by Zinwave Ltd. could void the user's authority to operate the equipment.

308-0007-1 and 308-0007-2 Remote Units: These devices comply with Part 22, Part 24 and Part 27 of the FCC rules. Changes or modifications not expressly approved by Zinwave Ltd. could void the user's authority to operate the equipment. For a list of services, please contact Zinwave.

- This device must only be used with antennas having a maximum gain of 5.2 dBi



Warning: This is NOT a CONSUMER device. It is designed for installation by FCC LICENSEES and QUALIFIED INSTALLERS. You MUST have an FCC LICENSE or express consent of an FCC Licensee to operate this device. Unauthorized use may result in significant forfeiture penalties, including penalties in excess of \$100,000 for each continuing violation.

When operating on a channel or channels under 47CFR parts 22, 24 or as identified in the following table, the **308-0007-1 and 308-0007-2** Remote Units are an Industrial Booster as per 47CFR part 20.

Rule Part	Band	LTE band	Downlink Frequency Range (MHz)	Service	Modulation	Transmit power per port (dBm)	Emissions Designator
27	Digital Dividend	71	617 – 652	LTE	16-QAM/64-QAM	21	F9W W9W
	700 MHz LTE	12	716 – 757	LTE	16-QAM/64-QAM	21	
13							
17							
22	Cellular	5	869 - 894	GSM	GMSK	21	
				EDGE	8-PSK		
				UMTS	QPSK		
				HSPA/HSPA+	16-QAM/64-QAM		
				CDMA	QPSK		
				CDMA2000 Ev-DO	8PSK, 16-QAM		
24	PCS	2 25	1930 - 1995	UMTS	QPSK	24	
				HSPA/HSPA+	16-QAM/64-QAM		
				FDD LTE (band 2/25)	QPSK + QAM		
				CDMA	QPSK		
				CDMA2000 Ev-DO	8PSK, 16-QAM		
27	AWS-1 AWS-3	4 66	2110 - 2180	UMTS	QPSK	24	
				HSPA/HSPA+	16-QAM/64-QAM		
				FD-LTE (band 4)	16-QAM/64-QAM		
				FD-LTE (band 10)	16-QAM/64-QAM		
	BRS/EBS	7	2496 – 2690	LTE	16-QAM/64-QAM	24	
	C-Band	43	3700 – 3980	LTE	16-QAM/64-QAM	24	

FCC Cautionary Note

Any changes or modifications in construction of this equipment which are not expressly approved by the party responsible for compliance could void the user's authority to operate the equipment.

FCC Verification: Primary and Secondary Hub

These devices comply with part 15 of the FCC Rules. Operation is subject to the following two conditions: (1) this device may not cause harmful interference, (2) this device must accept any interference received, including interference that may cause undesired operation.

This is a Class A Digital Device

This equipment has been tested and found to comply with the limits for a Class A digital device, pursuant to part 15 of the FCC rules. These limits are designed to provide reasonable protection against harmful interference when the equipment is operated in a commercial environment. This equipment generates, uses, and can radiate radio frequency energy and, if not installed and used in accordance with the instruction manual, may cause harmful interference to radio communications. Operation of this equipment in a residential area is likely to cause harmful interference in which case the user will be required to correct the interference at his own expense.

Note: This is Class A product (as defined in European Norm (EN) 55032). In a domestic environment this product may cause radio interference.

About this Manual



This manual provides user instructions for the Uniwave In-Building Wireless Solution.

Intended Audience

The intended users for this manual are trained and competent in the configuration of Distributed Antenna Systems (DAS).

Conventions

Icons are used to alert you to potential safety hazards in one of the following ways:

	Warning: A warning notice denotes a hazard. It calls attention to an operating procedure, practice, or the like that, if not correctly performed or adhered to, could result in personal injury or death. Do not proceed beyond a Warning notice until the indicated conditions are fully understood and met.
	Caution A caution notice denotes a hazard. It calls attention to an operating procedure, practice, or the like that, if not correctly performed or adhered to, could result in damage to the product or loss of important data. Do not proceed beyond a caution notice until the indicated conditions are fully understood and met.
	Sensitive to electrostatic discharge: An Electrostatic Discharge (ESD) Susceptibility symbol is displayed to alert personnel that the part(s) are sensitive to electrostatic discharge and that static control procedures must be used to prevent damage to the equipment.
Bold	Actions you should take such as text or data to be typed exactly or items to click.
<i>Italic</i>	Items to type for which you must supply a value.
Initial Caps	Screen Names are in initial caps.

Note: A note provides additional information to clarify a point in the text.

Important: An important statement is similar to a note but is used for greater emphasis.

Getting Help

[Help for the Configuration GUI is available by clicking the right arrow \(<\) on the right of each page. If you need further assistance, please contact Zinwave support at \[support@zinwave.com\]\(mailto:support@zinwave.com\) or your service partner.](#)

1 System Overview

Zinwave's Uniwave in-building wireless solution provides cellular and public safety access services to buildings, campuses, and venues, delivering end-to-end all fiber service on a single converged system. Zinwave's unique wideband architecture supports any service mix, protocol, or modulation scheme over a wide frequency range. The 308-XXXX product components cover 150 MHz to 5000 MHz (NB some components are planned/ready to support 150 – 6000 MHz). Uniwave provides RF coverage over large areas and supports a multitude of wireless and IP data services, irrespective of carrier frequency or signal protocol.

The components of Uniwave are:

- Primary Hub
- Service Module - installed in Primary Hubs
- Optical Module - installed in Primary Hubs
- Transport Module - installed in Primary Hubs to bring Services over fiber to a downstream Primary Hub
- Secondary Hub – incorporates 48V DC Power Supply Unit (PSU) for Remote Units
- Remote Unit
- Configuration Graphical User Interface (GUI) - supplied on Primary Hubs
- Central 48V DC Power Supply (Optional) – used for powering any Remote Units directly connected to Primary Hub

The system's network infrastructure uses standard structured cabling, broadband Single-mode optical fiber.

1.1 How Does It Work?

At a high-level, the standard solution provides a complete in-building wireless infrastructure with a few core components. Radio Frequency (RF) source inputs come into the Primary Hub's Service Module directly or indirectly. The Primary Hub converts these RF signal inputs to optical and connects via optical fiber directly to Remote Units or through a Secondary Hub. The Secondary Hub connects up to 8 Remote Units via optical fiber to one optical slot of a Primary Hub. The Remote Units connect to antennas, taking the optical signal back to RF and amplifying it for wider distribution.

System Overview

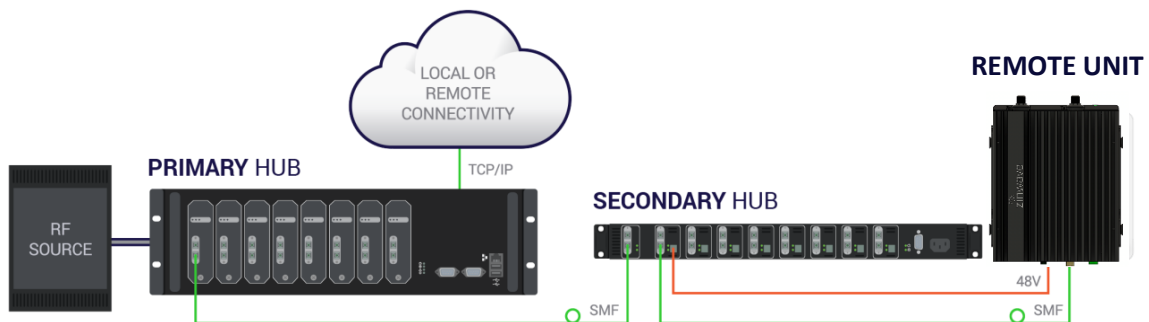

1.2 Key Features

The Uniwave solution provides the following key features:

- Wideband 150 – 5000MHz capability
- Supports single star or double star topologies, supporting up to 64 Remote Units.
- Single mode Fiber (SMF) from head-end to antenna
- Supports Frequency Division Duplex (FDD) and Time Division Duplex (TDD)
- Modular Primary and dedicated Secondary Hubs, with 48V PSU functionality for powering Remote Units incorporated in Secondary Hub.
- Support for long fiber distances (typically 2 km per fiber) thanks to accurate measurement of optical loss (5dBo max).
- Self-calibrating system - gain levels are adjusted automatically to accommodate different cable length and optical losses.
- Hot-swappable Modules
- Web-based configuration and management system including SNMP v3 monitoring.
- Unique service distribution matrix on the Hubs provides flexibility on how the services are routed within a deployment

1.3 Network Topologies

Uniwave supports a number of configuration topologies making it a flexible system that can support small venues to very large facilities and campuses. This, coupled with Uniwave's wideband attributes, enable system growth for both coverage of additional areas or buildings, or for adding support for new frequencies, wireless operators or services. The Uniwave system can range from a single Primary Hub and Remote Unit (a 1-1 configuration) to a maximum configuration consisting of a Primary Hub, 8 associated Secondary Hubs, and 64 Remote Units (a 1-8-64 configuration).

1.3.1 Single-Star Configuration

In its single star fiber-to-antenna topology, Uniwave supports a Primary Hub with up to 8 Remote Units.

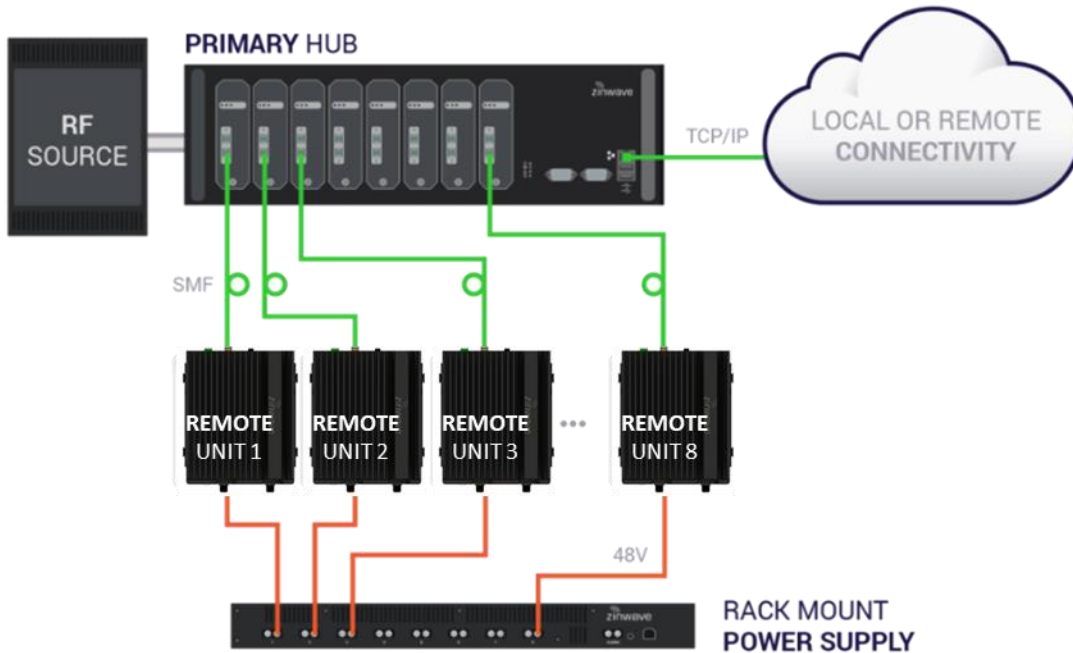

1.3.2 Double Star Configuration

In its double star configuration, Uniwave supports a single Primary Hub connected to up to 8 Secondary Hubs each supporting 8 Remote Units, bringing the system total to up to 64 Remote Units.

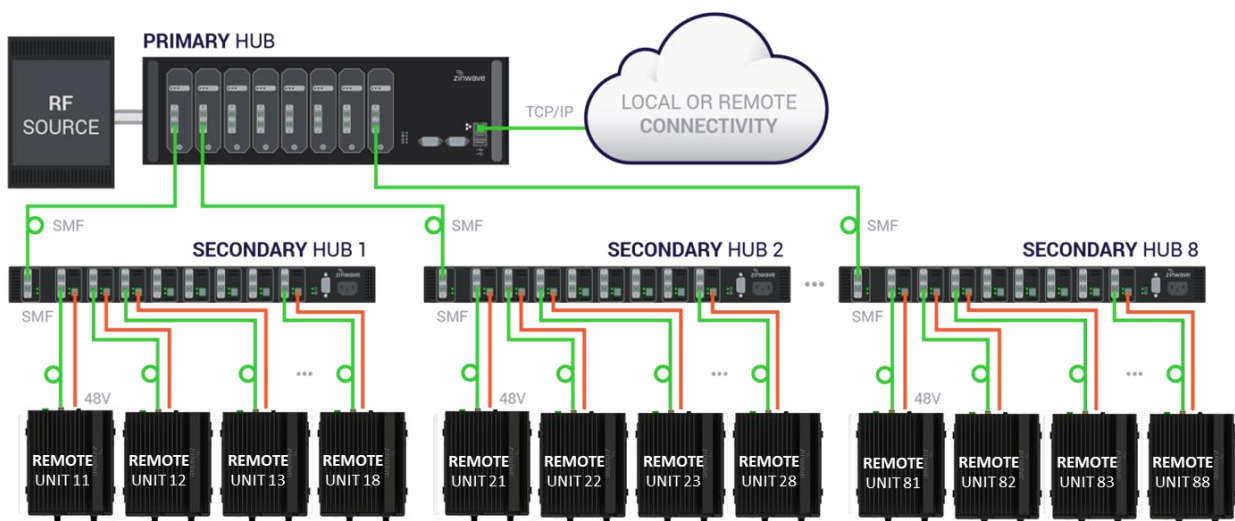

1.3.3 Mixed Topology Configuration

The Uniwave system can also support a mixed topology, such that some of the Remotes can be directly connected to the Primary Hub (single star configuration) while also supporting other Remotes connected via Secondary Hubs (double star configuration). A typical mixed topology use case has a location needing coverage that is in close proximity to the Primary Hub, while also needing to support longer fiber runs or other buildings from that same Primary Hub such that it would be necessary to deploy a Secondary Hub.

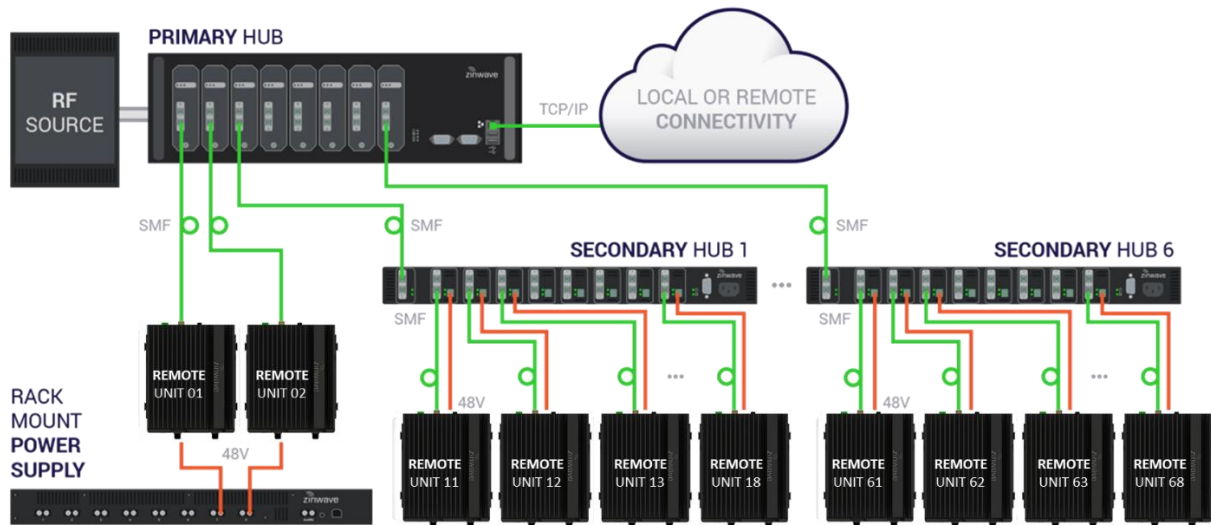

1.3.4 Support for MIMO Services

The next generation of high data-rate services such as LTE provide various Multiple-Input Multiple-Output (MIMO) options. Where base stations (BTS) are deployed to provide in-building coverage, these options can be used to increase the overall data throughput capacity or coverage of the system.

Typically, BTS signals are distributed inside buildings via a Distributed Antenna System (DAS) which has multiple antenna locations to provide multiple copies of each signal. In the case of MIMO, each antenna location will require 2 or more independent signals from the same BTS. The standard Uniwave single star and double star architectures support a traditional single signal (SISO) BTS. See [“Single Star Configuration”](#) and [“Double Star Configuration”](#).

To make best use of MIMO, the two or four base-station signal paths must remain isolated right through to each Remote Unit. The data processing advantage is lost if the signals are combined. This means that each signal path must be connected through independent Service Modules, and each one shall not be combined by any matrix switch settings. It may be appropriate to pass the MIMO channels through independent Primary Hubs, depending on the size of the system. Fiber connections to a MIMO Remote Unit must keep the paths separate. If a Secondary Hub architecture is used, each MIMO channel must be routed to separate and independent Secondary Hubs.

The 2-path Remote Unit 308-0007-2 and 4-path Remote unit 308-0007-4 (which is a kit comprising a double bracket and two 2-path Remote Units) are intended for MIMO operation.

The MIMO installation could employ SISO antennas on each RU port, but there are also MIMO antennas available that incorporate 2 antennas in a single package. When these are used, pair the two

Tx signals into one antenna and take two Rx signals from another MIMO antenna. This will maximise Tx to Rx isolation, which is a more demanding requirement than the isolation of the MIMO paths.

The example MIMO system below has 32 antennas for MIMO Tx and 32 for MIMO Rx, where each antenna has 2 RF connections.

MIMO CONFIGURATION

One Primary Hub feeding eight Secondary Hubs; 64 Remote Units connected to 64 MIMO antennae; 32 antennae locations with two MIMO antennae per location.

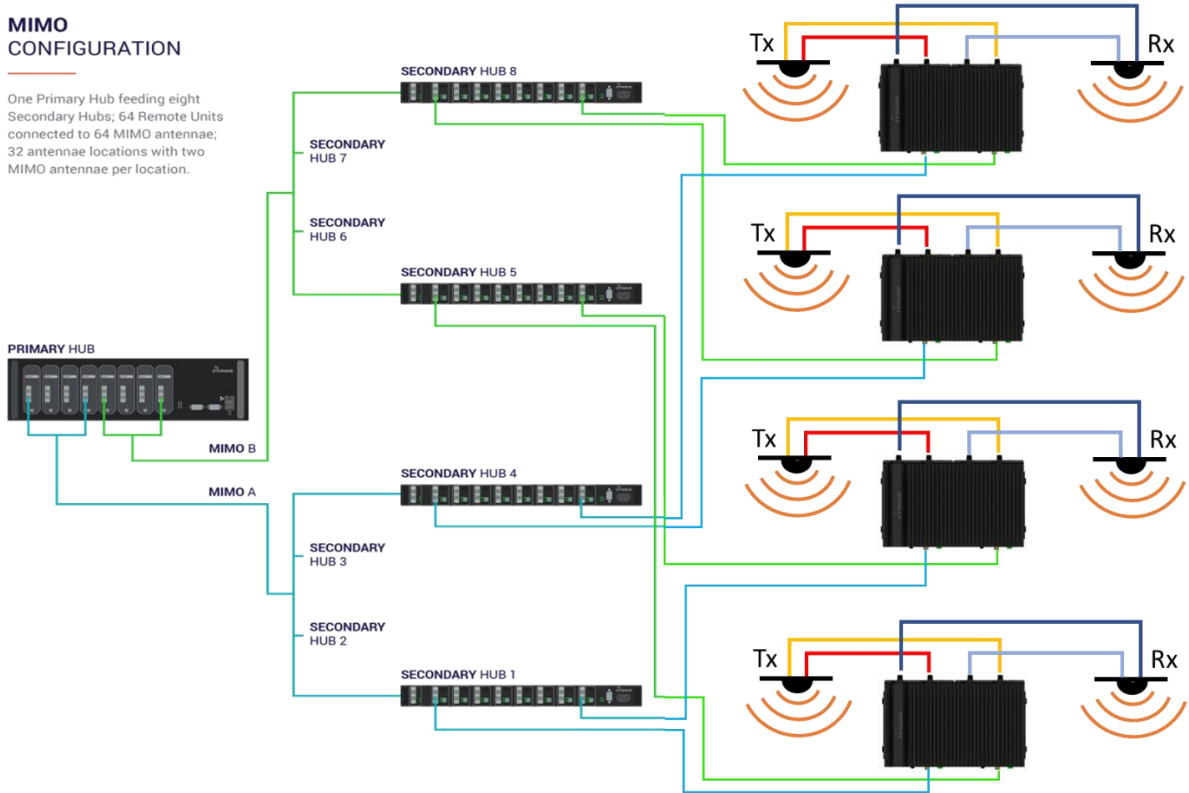

Note: The MIMO routing is done via the Signal Routing Matrix in the Primary Hub.

Be aware of the aggregate RF power produced by the 2-path and 4-path Remote Unit. Regulatory limits generally require the same non-interference with other spectrum users, regardless of the number of MIMO channels employed. This may mean that the composite power setpoint for each Remote Unit need to be backed off to achieve compliance.

1.4 Understanding Optional Components

You can enrich the standard Uniwave solution by incorporating optional components. Optional components enhance the system input capability or the operation of a core component. The POI expands system RF input capability while the stand-alone PSU provides a simple to install power capability for Remote Units connected directly to the Primary Hub.

1.4.1 How the PSU Fits in

The Central 48V DC Power Supply is a 1U rack mountable unit that can be used to power Remote

Units directly connected to the Primary Hub. This 600W unit provides eight 48V outputs on terminals supporting twin core cabling. If it is co-located with the Primary Hub, it can be monitored via a USB port on the Primary Hub. Secondary Hubs incorporate similar Power Supply functionality as standard.

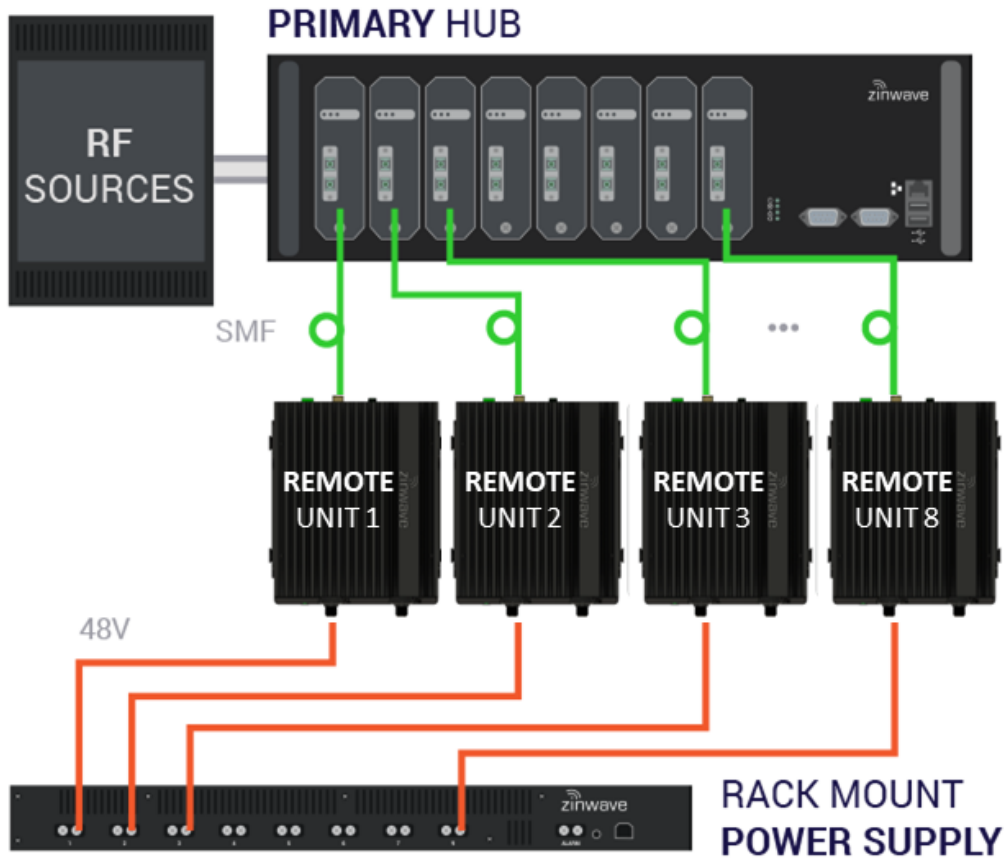

1.4.2 How the Uniwave POI Fits in

The Uniwave POI provides the interconnection between the RF source (for example, high power sources like BTS or repeaters where significant attenuation is needed) and the Service Module that is installed in the Primary Hub. Its compact design provides multiple passive elements for signal conditioning/attenuation.



The Uniwave POI Unit can connect up to 8 RF sources (eg. base-stations, repeaters, remote radio heads, etc.) to one or more Uniwave DAS systems. The 8 RF sources are combined together, and the

resulting composite signal is split out into 2 outputs that can feed into 2 separate DAS systems.

The POI integrates directly to the Uniwave system and includes overload protection, filtering, attenuation, and combining/splitting. Reliability is designed in with a single point of connection to BTS Duplex and a Simplex connection to the Primary Hub.

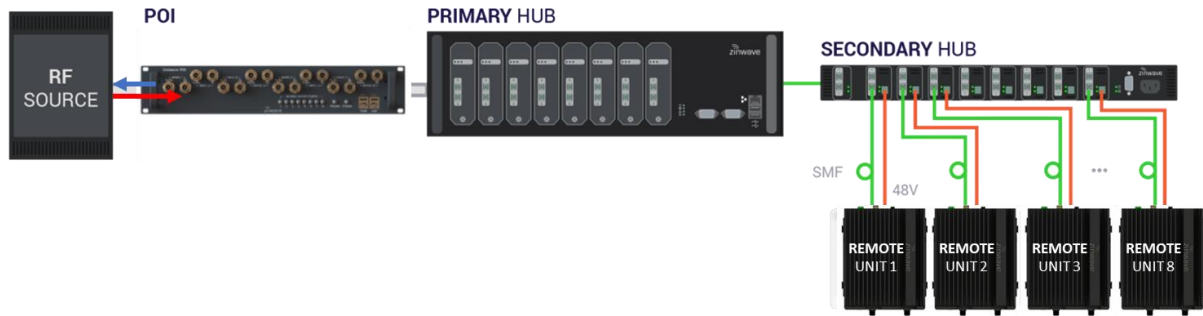

2 Understanding the Components

Uniwave has core and optional components. Core components are all necessary for system operation.

Part Number (order code and product sticker)	Serial Number (on barcode and Hub software)
308-0001, Primary Hub	82xxxxnnnnnn
308-0002, Optical Module	84xxxxnnnnnn
308-0003, Service Module	86xxxxnnnnnn
308-0004, Secondary Hub (rear AC inlet)	83xxxxnnnnnn
308-0005, Transport Module	87xxxxnnnnnn
308-0007-1, Remote Unit (single)	81xxxxnnnnnn
308-0007-2, Remote Unit (2x2 MIMO)	90xxxxnnnnnn

Part numbers starting with 308-xxxx indicate support for 150 – 5000 MHz frequency band.

The 308-0001 Primary Hub is designed to operate only with 308-XXXX components.

In addition to the core components, optional components are available to enhance the system's capabilities. Regardless of the addition of optional components, a double star topology remains scalable to 64 Remote Units. Optional components include:

- Central 48V PSU (1U - 600W)

2.1 Hubs

A Uniwave system consists of a single Primary Hub at the head-end, and up to 8 connected Secondary Hubs. Both Hubs have a universal AC power input.

2.1.1 Configuration GUI

The Configuration GUI is delivered with and resides on the Primary Hub. It provides all the parameters needed to configure and monitor Primary Hubs, Secondary Hubs, and Remote Units. The GUI application is accessible via standard Web browsers. SNMP support is also provided by the Hub software to integrate with SNMP monitoring tools for alarm notification.

The Configuration GUI supplied with the Primary Hub has identical functionality for either frequency band, although some of the selectable levels are band-specific. The same software image will run on either type of hub – it contains all firmware variants and detects the capability of the hardware that it is installed on.

Detailed functionality of the GUI is provided in the later sections of this manual.

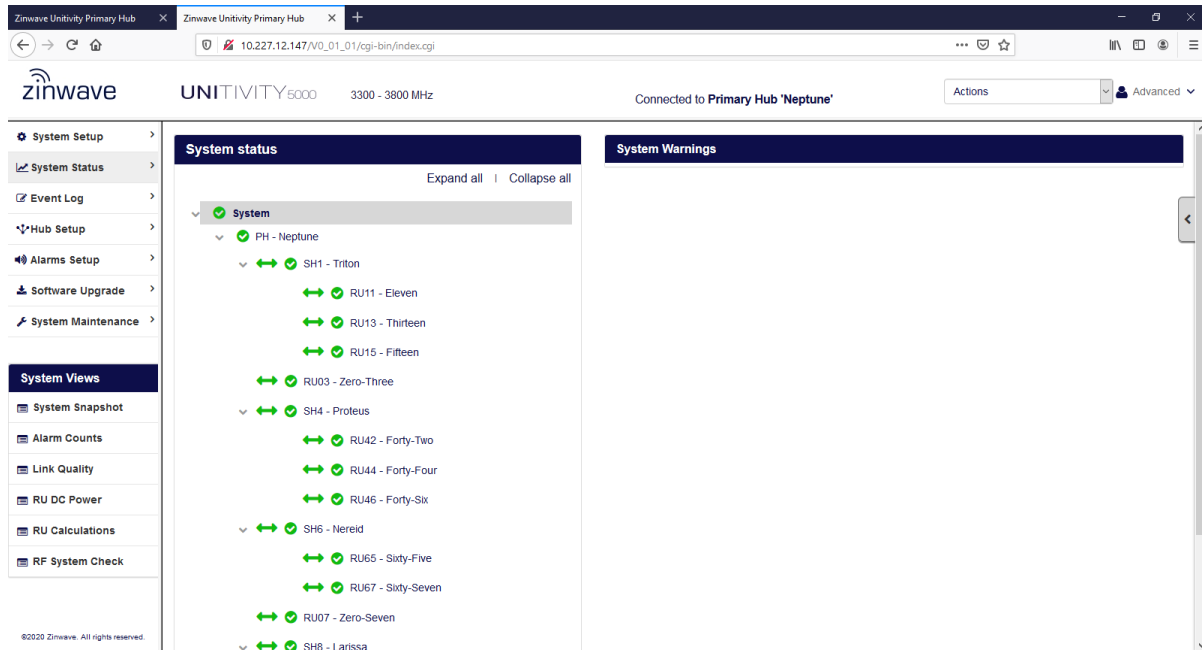

2.1.2 Primary Hub

A Primary Hub provides the interface to the RF sources and converts RF signals to optical. It then connects via fiber to either Secondary Hubs and/or Remote Units.

The Primary Hub includes at least one Service Module (see [“Service Module”](#)). Service Modules interface with RF sources such as base stations or repeaters. The Hub can be equipped with up to four Service Modules (installed in the rear) to accept any combination of frequencies within their entire supported pass-band, and up to 8 Optical Modules (located at the front, see [“Optical Module”](#)) to connect via optical fiber to Secondary Hubs or Remote Units directly. The Primary Hub supports single or dual star configurations or a mix of both. The Primary Hub is normally co-located with a BTS or RF source equipment.

Additionally, two hubs may be cascaded through the use of Transport Modules, so that Services connected to the first, UniTransport Hub, may be coupled via fiber to the rear slots of other downstream Primary Hubs.

Front View

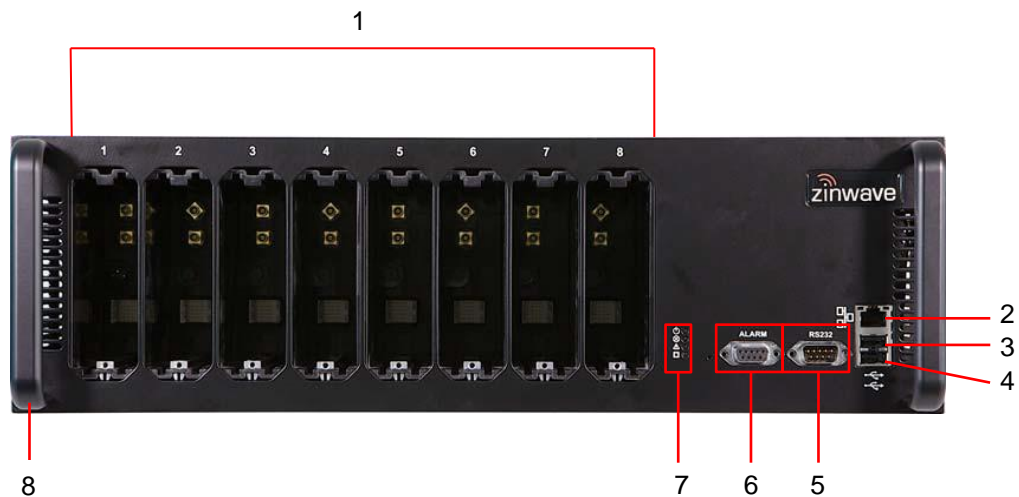

Number	Description
1	Slots1 to 8 for Optical Modules or Transport Modules
2	Ethernet connector
3	USB Connector (Type A)
4	USB Connector (Type A)
5	RS232 Connector
6	Alarm Connector (9 way D-type)
7	Status LEDs
8	Handle and Mounting Bracket (both sides of device)

Rear View



Number	Description
1	Slots A to D (right to left, from the rear view) for Service Modules or Transport Modules.
2	Optional Grounding Post, main protection is provided in the IEC inlet.
3	IEC AC Power Cord Connector shown.
4	Fuse
5	On/Off Power Switch

2.1.3 Secondary Hub

A Secondary Hub receives input via an optical link from a Primary Hub to distribute RF feeds between the Primary Hub and Remote Units. The Secondary Hub supports fiber connections to up to 8 Remote Units as standard. As the Secondary Hub can be located far from the Primary Hub, the deployed architecture can be tailored to meet and work with building layout and location of appropriate equipment rooms. The Secondary Hubs can be co-located with the Primary Hub or distributed throughout the site as appropriate.



Front View



Number	Description
1	Duplex SC-APC/SC-APC Optical connection to the Primary Hub
2	Duplex SC-APC/SC-APC Optical connection to a Remote Unit (8 positions)
3	Phoenix Contact 5.08mm connector: 48V power for a Remote Unit (8 positions)
4	Alarm Connector (9 way D-type)
5	IEC AC Power Cord Connector

2.2 Service Module

Service Modules provide the interface to the RF signal source such as BTS, or small cell. The modules are hot swappable units, allowing for system maintenance or the addition of operators or frequencies to be done without disrupting service. Up to 4 Service Modules can be deployed in the back of a Primary Hub.

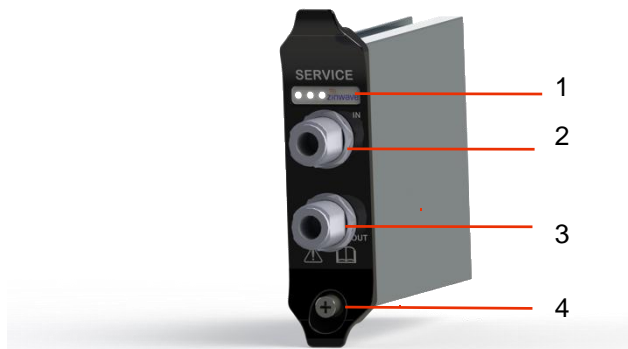

Number	Description
1	Status LEDs
2	RF Input N type
3	RF Output N type
4	Retaining Screw

Rear View

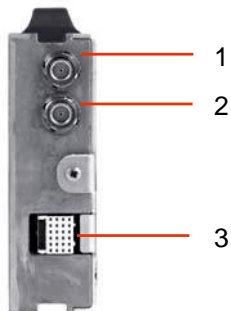

Number	Description
1	Floating BMA RF Connector
2	Floating BMA RF Connector
3	Multi-pin Data and Power Connector

2.3 Optical Module

The Optical Module provides the fiber link between a Primary Hub and a Secondary Hub or a Remote Unit. Up to 8 Optical Modules can be installed in the front of a Primary Hub to connect to Remote Units or Secondary Hubs as required. These modules are hot swappable to allow for system maintenance or adding Secondary Hubs or Remote Units with no impact to service. Optical Modules are intended to connect only by optical fiber.

Front View

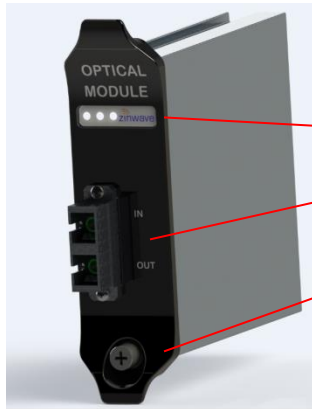

Number	Description
1	Status LEDs
2	Optical Fiber connector (Duplex SC-APC/SC-APC connector)
3	Retaining Screw

Optical Modules are intended to connect via Zinwave patch cords.

Rear View



Number	Description
1	Floating BMA RF Connector
2	Floating BMA RF Connector
3	Multi pin Data and Power Connector

2.4 Transport Module

The Transport Module provides the fiber link between two cascaded Primary Hubs. The Transport Module is visually similar to an Optical Module, but with internal hardware differences to permit it to also perform the job of a Service Module. It is not interchangeable with an Optical Module. A pair of Transport Modules is required to create a UniTransport link.

Up to 8 Transport Modules can be installed in the front of a Primary Hub, or up to 4 Transport Modules in the rear of a Primary Hub. It is not permitted to fit Transport Modules into both front and rear of the same Primary Hub.

Front View



Number	Description
1	Status LEDs
2	Optical Fiber connector (Duplex SC-APC/SC-APC connector)
3	Retaining Screw

Transport Modules are intended to connect via Zinwave patch cords.

Rear View



Number	Description
1	Floating BMA RF Connector
2	Floating BMA RF Connector
3	Multi pin Data and Power Connector

2.5 Remote Unit

The Remote Unit is a small, wall or ceiling mountable unit that amplifies the downlink signals for transmission over a wireless link, and amplifies the uplink wireless signals for transmission over the optical link. It is connected to the Primary or Secondary Hub via optical fiber. It defines the final cell coverage, communicates via optical link to Hubs, and receives and amplifies signals from smart phones, tablets, laptops, and other hand-held devices.

Bottom View

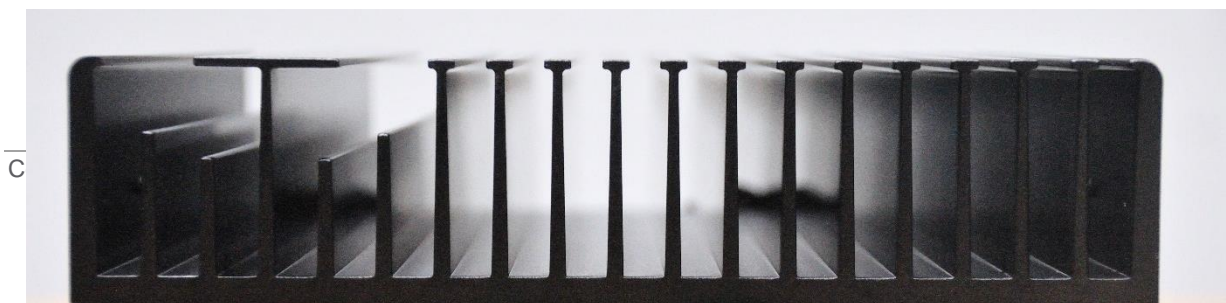

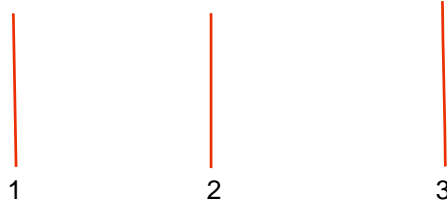

Number	Description
1	Phoenix Contact 5.08mm Connector 2-way: 48V DC Input
2	Optical Fiber connector (Duplex LC-APC/LC-APC connector)
3	Phoenix Contact 5.08mm Connector 3-way: Alarm Relay

Top View

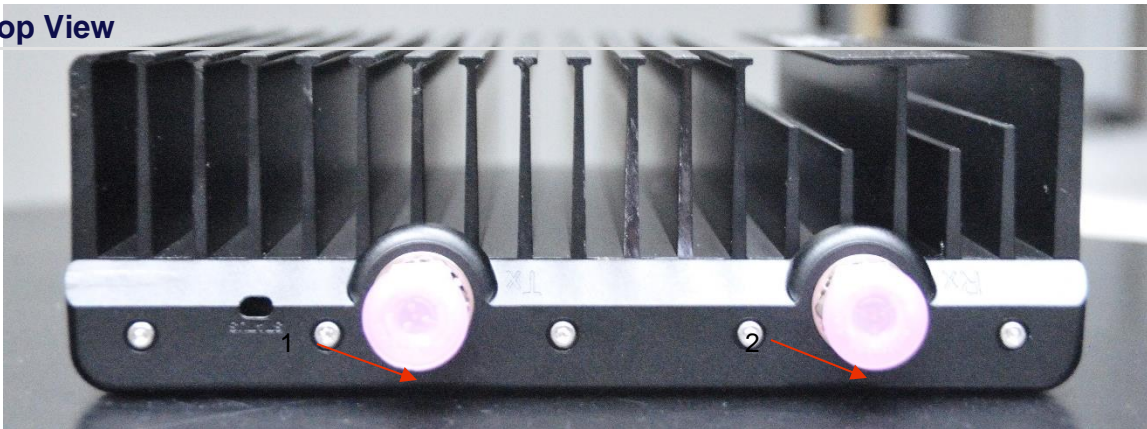

Number	Description
1	Antenna Connector Transmit (Tx) Coax N type
2	Antenna Connector Receive (Rx) Coax N type

2.5.1 Antennas

A variety of antennas can be connected to the Remote Unit via short coaxial cables. The choice of antenna will depend on the service requirement within the operational bandwidth of the system. Up to 8dBi antenna gain is permitted according to the regulatory approvals for the system.

It is important to ensure that any installed antennas meet the Tx/Rx isolation requirements and that

they are installed in accordance with all relevant safety and exposure regulations. Typically at least 40dB and ideally 50dB isolation is required between the Tx and Rx antennas to avoid downlink signals interfering with the uplink.

2.6 Fiber Patch Cords

Duplex SC-APC/SC-APC type fiber connectors are used on the Optical Module, Secondary Hub and Remote Unit. The system uses a laser in the transmit direction and photodiode in the receive direction. Uniwave is intended to be deployed with Single-mode fiber infrastructure. Zinwave supplies various fiber patch cords with the correct duplex SC-APC/SC-APC terminations for the Zinwave Uniwave equipment, and other optical connectors as required to match the installed infrastructure. The Duplex SC-APC/SC-APC connectivity is shown below:

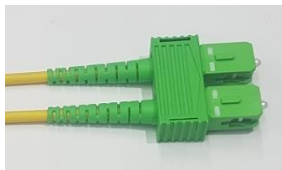

Number	Description
1	Out - transmit (laser)
2	In - receive (photodetector)

The TIA 568 color code for connector bodies and/or boots is Beige for Multimode fiber, Blue for Single mode UPC fiber connector, and Green for Single mode SC-APC (angled polished) connectors.

The UniWave 308-0007 Remote Unit is equipped with more modern duplex LC-APC fiber connectors. The fibers are the same type and orientated the same way as with all of the other Zinwave components, but the connector body is smaller.







Number	Description
1	Out - transmit (laser)
2	In - receive (photodetector)

3 Hub and Module LEDs





3.1 Primary Hub Front Panel LEDs

There are four LEDs on the front of the Primary Hub. The following table describes them:







Symbol	Name	Status Color	Description	Comment
	Power Indicator	Green	Power connected to CPU board	Shows processor is correctly powered
		Off	No power connected	
	Service Indications	Green	No error. System is fully functional	This alarm cannot be masked and will ALWAYS be Red when loss of service conditions active.
		Red	Loss of service currently active	
		Red/Green Flashing	Firmware programming in progress	
	Warning Indicator	Green	All Units operating correctly	
		Orange	Service or Hardware warning currently active	
	CPU Indicator	Green	CPU running	Shows Processor is correctly operational
		Orange	CPU restarting	

3.2 Secondary Hub Status LEDs

3.2.1 Optical Link to Primary Hub



LED	Color	Description
	Off	Secondary Hub not powered.
	Red	Secondary Hub that had been in fully operational state has lost communication/association with Primary Hub.
	Alternate Red/ Green	Secondary Hub waiting to be associated with Primary Hub following power-on/reboot.
	Green Flash	Secondary Hub successfully associated with PH, but there are no fully operational Remote Units attached.
	Green	Secondary Hub successfully associated with Hub, and there is at least 1 fully operational Remote Unit attached.

3.2.2 Optical Links to 8x Remote Units

LED	Color	Description
	Off	No Remote Unit laser detected on port, and no Remote configured to be present on port.
	Red	Remote unit configured to be present on port, but no Remote Unit laser detected
	Red Flash	Alarm active on Remote Unit attached to port
	Alternate Red/ Green	Waiting for attached Remote Unit to be associated with Primary Hub (once Remote Unit laser detected).
	Green Flash	Remote Unit on port successfully associated with Primary and Secondary Hub. Optical link auto-setup is in progress, and/or radio transceiver of attached Remote Unit is disabled.
	Green	Remote Unit attached to port is fully operational

3.2.3 Secondary Hub Status LEDs

There are two status LEDs on the right-hand side of the Secondary Hub front panel. The following table describes them:

Symbol	Name	Status Color	Description	Comment
	Power Indicator	Green	Power connected to CPU board	Shows processor is correctly powered
		Off	No power connected	
	Alarm Indicator	Green	Running normally, no alarms	Shows Alarm status of the Secondary Hub. Alarm details are reported to the Primary Hub and visible on the web GUI
		Red flashing	An alarm is present (alarm relay is also set)	

3.3 Service, Optical and Transport Module LEDs

There are three LEDs on the front of each module which indicate operational status.

- The right LED indicates power status.
- The middle LED indicates communication status between the module and the far end.
- The left LED indicates the current state of the module.

As part of the auto discovery process the Hub communicates with each module in turn, and cycles

through the installed modules. During this period, the Primary Hub checks for the presence of any Secondary Hubs and Remote Units.



For Optical Modules, if no Remote Units are connected, only the right and middle LEDs are operational.

Initially the right LED will be a dull red, indicating that power is connected but the module is disabled. This will change to green when the Hub has detected the presence of the module and initialized it. If the module is disabled (in the Configuration GUI) the right LED will display red. The middle LED shows green if the unit has successfully discovered one or more downstream system elements connected to the Optical Module. Only when a Remote Unit is detected will the third LED be activated.

A fully functioning Optical module with operational downstream elements displays three green LEDs.





3.3.1 Power LED—Right

LED	Color	Description
	Dull Red	Initial power-up. Power present on Hub allowing Module detection to proceed; or Module NOT Enabled through System Setup; or Module not inserted in valid Hub slot.
	Green	Module in normal operation. Ready for use (Power to module).
	Off	No power to module.





3.3.2 Communications—Middle

Once plugged in, the Optical or Transport Module attempts to establish communication with the far end.

Service Modules do not communicate with Remote Units or other Hubs; therefore, the Communications LED is deactivated for Service Modules.

LED	Color	Optical / Transport Module Description
	Solid Red	No successful communication with any downstream system elements after initial attempts.
	Green	Module in normal operation. Communication established with at least one downstream system element.
	Off	Module is not powered or has not yet completed initial attempts to communicate with downstream system elements.







3.3.3 Status—Left

LED	Color	Service Module	Optical / Transport Module
	Off	Normal condition	Module is not powered, or optical calibration and auto-setup of downstream units not yet completed.
	Green	Not Used	Optical / Transport Module and all downstream system elements operating normally.
	Flashing Green	Not Used	Optical link calibration and auto-setup of downstream units in progress; and/or One or more downstream Remote Units have their radio transceivers disabled.
	Flashing Orange	Flashing Orange	RF Path Calibration or RF System Check in progress
	Red	Not Used	Optical calibration and auto-setup Error – For Possible causes refer to “System Status” page on GUI

3.4 Start-up Sequence



3.4.1 Service Module















The following table shows a typical LED start-up sequence for a fully enabled Service Module:

Left		Middle		Right		Status
	Off		Off		Dull Red	Initial power-up. Power present on Hub allowing Service Module detection; or Service Module NOT Enabled through System Setup; or Service Module inserted in invalid slot. (E.g. In an output (front) slot).
	Off		Green		Green	Service Module successfully detected and in normal operation; or Service Module with Service Warning; or Service Module with Service Loss.

3.4.2 Optical Module



















The following table shows a typical LED start up sequence for a fully enabled Optical Module:

Left		Middle		Right		Status
	Off		Off		Dull Red	Initial power-up. Power present on Hub allowing Optical Module to be detected; or Optical Module NOT Enabled through System Setup; or















Left		Middle		Right		Status
						Optical Module inserted in invalid slot. (E.g. In an input (rear) slot).
	Off		Off		Green	Optical Module successfully detected, starting discovery of downstream system elements.
	Off		Red		Green	Potential communication failure state: No incoming light on fiber or no downstream system elements have responded after several communication attempts (discovery continues).
	Off		Green		Green	Communication success state: communication with at least one downstream system element successfully established.
	Green Flash		Green		Green	Optical calibration and auto-setup of downstream units in progress, and/or one or more downstream Remote Units have their radio transceivers disabled.
	Green		Green		Green	Optical Module and all downstream system elements operating normally.

3.4.3 Transport Module

The following table shows a typical LED start up sequence for a fully enabled Transport Module plugged into the front slot of a UniTransport Hub.









Left		Middle		Right		Status
	Off		Off		Dull Red	Initial power-up. Power present on Hub allowing Transport Module to be detected; or Transport Module NOT Enabled through System Setup.
	Off		Off		Green	Transport Module successfully detected, starting discovery of downstream Primary Hub.
	Off		Red		Green	Potential communication failure state: No incoming light on fiber or no downstream system elements have responded after several communication attempts (discovery continues).
	Off		Green		Green	Communication success state: communication established with a downstream Primary Hub.
	Green Flash		Green		Green	Optical calibration and auto-setup of downstream units in progress, and/or RF path to downstream Primary Hub is disabled.
	Green		Green		Green	Transport Module is connected to active downstream Primary Hub.

The following table shows a typical LED start up sequence for a fully enabled Transport Module plugged into the rear slot of a Primary Hub.

Left		Middle		Right		Status
	Off		Off		Dull Red	Initial power-up. Power present on Hub allowing Transport Module to be detected; or Transport Module NOT Enabled through System Setup.
	Off		Off		Green	Transport Module successfully detected, starting discovery of downstream Primary Hub.
	Off		Red		Green	Potential communication failure state: No incoming light on fiber or no messages from upstream UniTransport Hub.
	Off		Red Flash		Green	Potential failure state: Hardware Warning Alarm is present on this Transport Module.
	Off		Green		Green	Transport Module is connected to active upstream UniTransport Hub.

3.5 Remote Unit LEDs

There is an LED window on the Remote Unit next to the Tx connector and another between the fiber and power connectors. Both LEDs show the same information.

LED	Color	Description
	Off	No power to Remote Unit
	Red	No connection to Hub
	Red Flash	Alarm active
	Alternate Green/ Blue	Uplink Rx Power AGC
	Alternate Red/ Green	Associating with Hub
	Green Flash	Unit successfully associated with Hub. Optical link measurement and auto-setup in progress, and/or Remote Unit radio transceiver disabled.
	Green	Remote Unit fully operational
	Blue	Remote Unit in calibration mode (not operational)

4 Performing a Basic Installation

The following procedure is intended to provide you with a basic work flow to get a new system up and running. It provides references to specific instruction for that step.

To install Uniwave:

- 1) Unpack and verify all components (See section [“Installing and Populating Hubs”](#)).
- 2) Rack mount Hubs and populate with the appropriate modules (See section [“Installing and Populating Hubs”](#)).
- 3) Install Remote Units and antennas (See section [“Installing Remote Units”](#) and [“Connecting Antennas to Remote Units”](#)).
- 4) Install power for Remote Units (local or PSU) (See section [“Powering Remote Units”](#)).
- 5) Make and check all connections for power and data between Primary, Secondary, and Remote Units. This will be fiber for Optical Connections. (See section [“Fiber Patch Cords”](#)).
- 6) Ground any Rack Mounted Equipment.
- 7) Power on all equipment.
- 8) Watch LEDs for self-test and connection. (See section [“Start-up Sequence”](#)). Trouble shoot connections on infrastructure cables using LEDs (see [“Hub and Module LEDs”](#)). Swap fibers and check power as needed.
- 9) Connect the PC to the Primary Hub to configure system. (See section [“Initial Standalone Access”](#)).
- 10) Access the GUI and view status pages (See section [“Accessing the GUI”](#)) and ensure Primary Hub software is the latest version. Perform software upgrade if needed.
- 11) Set up the system based on the coverage tool and measured inputs. (See section [“System Setup”](#)).

5 Installing and Populating Hubs







This chapter describes how to install insert modules into Primary and Secondary Hubs.

5.1 Installing the Hub

You can mount a Primary or Secondary Hub in a standard 19" (48.26cm) rack or an open frame rack. There are many 19" rack systems available on the market of various depths. It is essential that the weight of the Hub is supported at the front and back. If the Hub is not adequately supported in your rack, you must provide support items, such as front-to-rear chassis runners (rails) or fully supported shelves. This manual provides instructions to mount a Hub in a rack using the only items supplied in the mounting kit.

5.1.1 Mounting Kit

Each Hub is delivered with an accessory box of parts used for rack mounting. This box contains the following parts:

Part Number	Qty	Detail	Function	Image
128-0118	8	Screw M4 X 10 CSK POZI STL Black	Mounting Bracket Screw	
142-0257-01	2	Rack Mounting Bracket	Mounting bracket for rack	
142-0048-05	12	5000 Hub Module Blank Plate	Blanking plates for unused slots	
128-0043	12	Screw Thumb 6- 32X8mm PC Case	Retaining Screws	
128-0113	4	M6 Cup Washer Black	Mounting Bracket washers	
128-0112	4	Screw M6x12 PAN POZI STL Black	Hub Mounting Screws (suitable for M6 Cage nuts, not supplied)	
	1	Power Cord	Country specific power cord	

5.1.2 Standard 19" (48.26cm) Rack Mounting

The Primary Hub is designed to mount directly into a 19 inch rack framework with no additional mounting materials.

The following tools are required for installation (Not provided):

- 4x M6 cage nuts appropriate for 19 inch rack frame
- Pozi-drive screwdriver
- Cage nut insertion/extraction tool

Note: If rack frame does not use M6 nuts, you must supply appropriate nuts to secure the Hub.

To install the Primary Hub in a rack:

- 12) Remove all parts from the Accessory Box included in the box with the Primary Hub.
- 13) Attach the mounting brackets (using the black countersunk screws 128-0118) to the side of

the Primary Hub so that the mounting face is flush with the front of the Hub.



- 14) Using the cage/nut insert/extraction tool, install 2 M6 cage nuts on each side of the rack. The spacing must align with the holes in the Hub.
- 15) Place the Primary Hub into the rack and secure using screws 128-0112 and washers 128-0113.

5.1.3 Open Frame Rack Mounting

The Primary Hub is designed to mount into an open frame rack with an offset of either 75mm or 125mm (approx. 3 or 5 inches), using supplied mounting materials.

The following tools are required for installation (Not provided):

- 4x M6 cage nuts appropriate for 19 inch rack frame
- Pozi-drive screwdriver
- Washers and Screws, suitable for Rack type, to secure equipment

To install the Primary Hub in a rack:

- 16) Remove all parts from the Accessory Box included in the box with the Hub.
- 17) Attach the mounting brackets (using the black countersunk screws 128-0118) to the side of the Hub in the correct position for the rack.



- 18) Place the Primary Hub into the rack and secure using suitable Hub mounting screws and washers.



5.1.4 Installing Blank Panels

Blank panels are available to cover unused slots on a Primary Hub.

To install blank panels:

- 19) Place a blank panel over a slot that will not be used and align so that plate hole fits over screw hole at bottom.
- 20) Slots are ordered in the back from A to D and in the front from 1 to 8. Place blank panels on slots that are not needed. For example, if you are using slots 1 to 4, place blank plates on slots 5 to 8.



- 21) Insert a retaining screw in the hole and turn to hand-tighten.

5.2 Installing Secondary Hub

The Secondary Hub is designed to mount directly into a 19-inch rack framework with no additional mounting materials. Below dimensions are in millimeters.

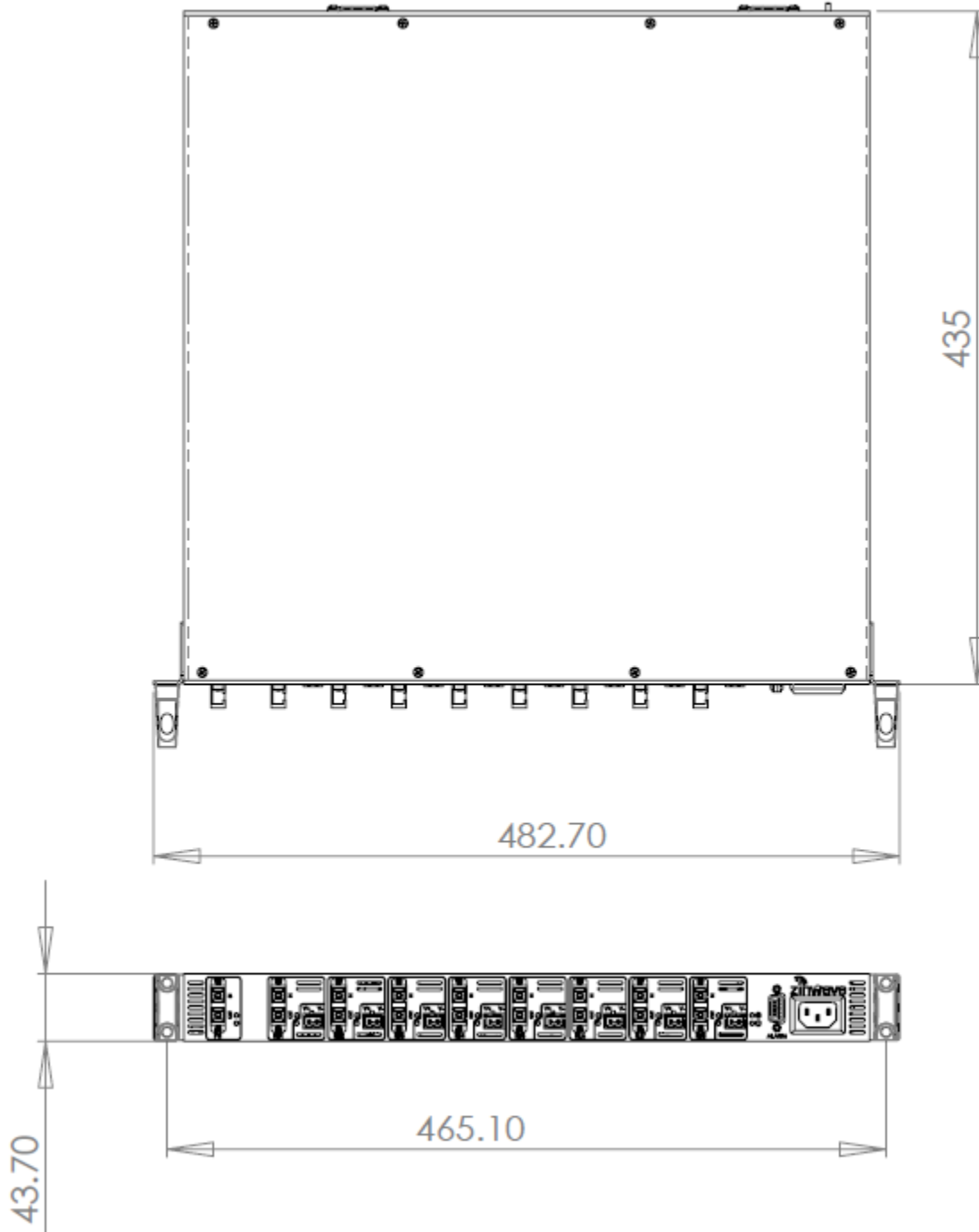

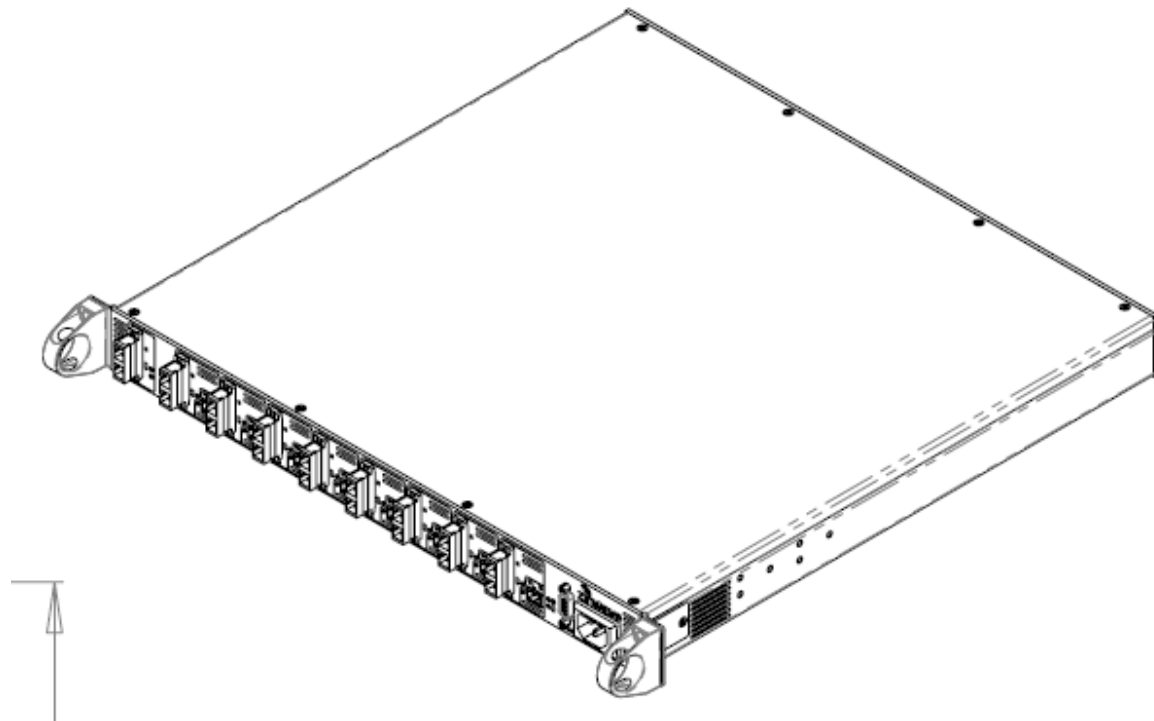
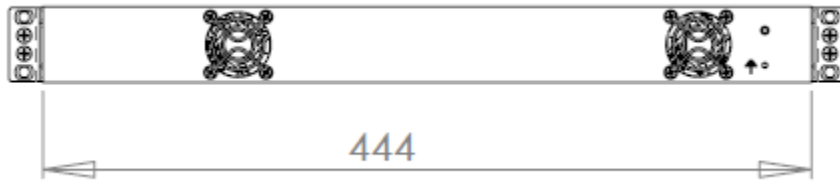

5.3 Installing Service Modules in Primary Hub

Service Modules are inserted in the back of a Primary Hub in slots A to D. See [“Primary Hub”](#) for slot descriptions.



Caution: Service Modules must ONLY be installed in the REAR of a Primary Hub. Optical Modules must ONLY be installed on the front panel of a Primary Hub or the unit will not function as expected.

To install Service Modules in the back of a Primary Hub:

Note: If you are adding or updating modules, remove any blanking plates in the rear slots you wish to populate by turning the retaining screw and pulling on the top and bottom of the plate.

1. Visually align the module with the rear slot (screw hole should be on bottom) and insert with your thumbs at the top and bottom of the front of the module.
2. Press the module slightly, until you feel it set against the back of the slot.

Modules are equipped with floating BMA connectors in the back that are slightly sprung to enhance connectivity.

3. Insert a Retaining Screw and hand-tighten.
4. A tightened screw ensures best performance. Performance may degrade if screws are not properly in place.
5. If power is applied before insertion, see [“Primary Hub Front Panel LEDs”](#) for LED descriptions.

Note: LEDs will only fully function when equipment on the other end of the fiber is present and working.

5.4 Installing Optical Modules in Primary Hub

Optical Modules are inserted in the front of Primary Hubs.

To install Optical Modules

Note: If you are adding or updating modules, remove any blanking plates in the slots you wish to populate by turning the retaining screw and pulling on the top and bottom of the plate.

1. Visually align the module with the slot (screw hole should be on bottom) and insert with your thumbs at the top and bottom of the front of the module.
2. Press the module slightly, until you feel it set against the back of the slot.

Modules are equipped with floating BMA connectors in the back that are slightly sprung to enhance connectivity.

3. Insert a Retaining Screw and hand-tighten.

A tightened screw ensures best performance. Performance may degrade if screws are not properly in place.

4. If power is applied before insertion, see “Hub and Hub Module LEDs” on page 3-1 for LED descriptions.

Note: LEDs will only fully function when equipment on the other end of the fiber is present and working.

5.5 Powering the Primary Hub

The Primary Hub has an IEC AC power socket in the rear; the cord is country-specific.

CAUTION :

DOUBLE POLE/NEUTRAL FUSING

The Power Supply Module in the Primary Hub 308-0001 has multiple sources and may include a fuse in the Neutral AC connection. Disconnect the AC mains supply to de-energize the phase conductors. After operation of the fuse, parts of the equipment that remain energized might represent a hazard during servicing.

To Power on the Primary Hub:

1. Make sure the On/Off switch is in the Off (O) position.
2. Plug the AC power cord into the rear of the Primary Hub and into an AC power outlet.
3. Move the ON/OFF switch to the On (I) position.
4. Verify the LED status shows correct start up sequence and the equipment is ready for operation. See [“Start-up Sequence”](#).

Note: If powered up with no modules installed the Primary Hub shows 4 green LEDs. If modules are installed then the alarm warning and fault LEDs may show alarm conditions at initial start-up. This could be due to the fact that no Remote Unit elements are connected. These alarms can be cleared via the Primary Hub Set Up page of the Configuration GUI once the system is correctly configured.

Although modules may be hot swapped, during initial installation it is recommended that the Primary Hub power is switched off until the initial module installation is completed.

5.6 Powering the Secondary Hub

The Secondary Hub has an IEC AC power socket in the front; the cord is country-specific.

CAUTION :

DOUBLE POLE/NEUTRAL FUSING

The Power Supply Module in the Secondary Hub 308-0004 has multiple sources and may include a fuse in the Neutral AC connection. Disconnect the AC mains supply to de-energize the phase conductors. After operation of the fuse, parts of the equipment that remain energized might represent a hazard during servicing.

To Power on the Secondary Hub:

1. Plug the AC power cord into the front of the Secondary Hub and into an AC power outlet.
2. Verify the LED status shows correct start up sequence (Flashing red, flashing green, stable green) and the equipment is ready for operation.

6 Installing Remote Units

This chapter describes how to install the Remote Units along with their power options.

6.1 Mounting Remote Units

Your system installation plan provides the locations to mount each Remote Unit and their associated antennas. Depending on the available wall space a Remote Unit can be mounted vertically (with antenna connector closest to ceiling) or horizontally (with antenna connectors facing a side wall). Remote units can also be mounted to the ceiling.

Remote Units are suitable for use in environmental air space in accordance with Section 300-22(c) of the US National Electrical Code, and Sections 2-128, 12-010(3) and 12-100 of the Canadian Electrical Code, Part 1, CSA C22.1.

Tools required:

- Drill with M4 bit
- Pencil
- M4 Screwdriver
- Screws, rawlplugs, etc. to attach RU brackets to wall or ceiling.

Supplied equipment:

- Remote Unit
- Zinwave Patch Cords
- Mounting Bracket
- 2x M4 screws to lock RU into bracket

6.1.1 Considerations before Mounting

The Remote Unit (with mounting bracket) has the following dimensions displayed in millimeters:

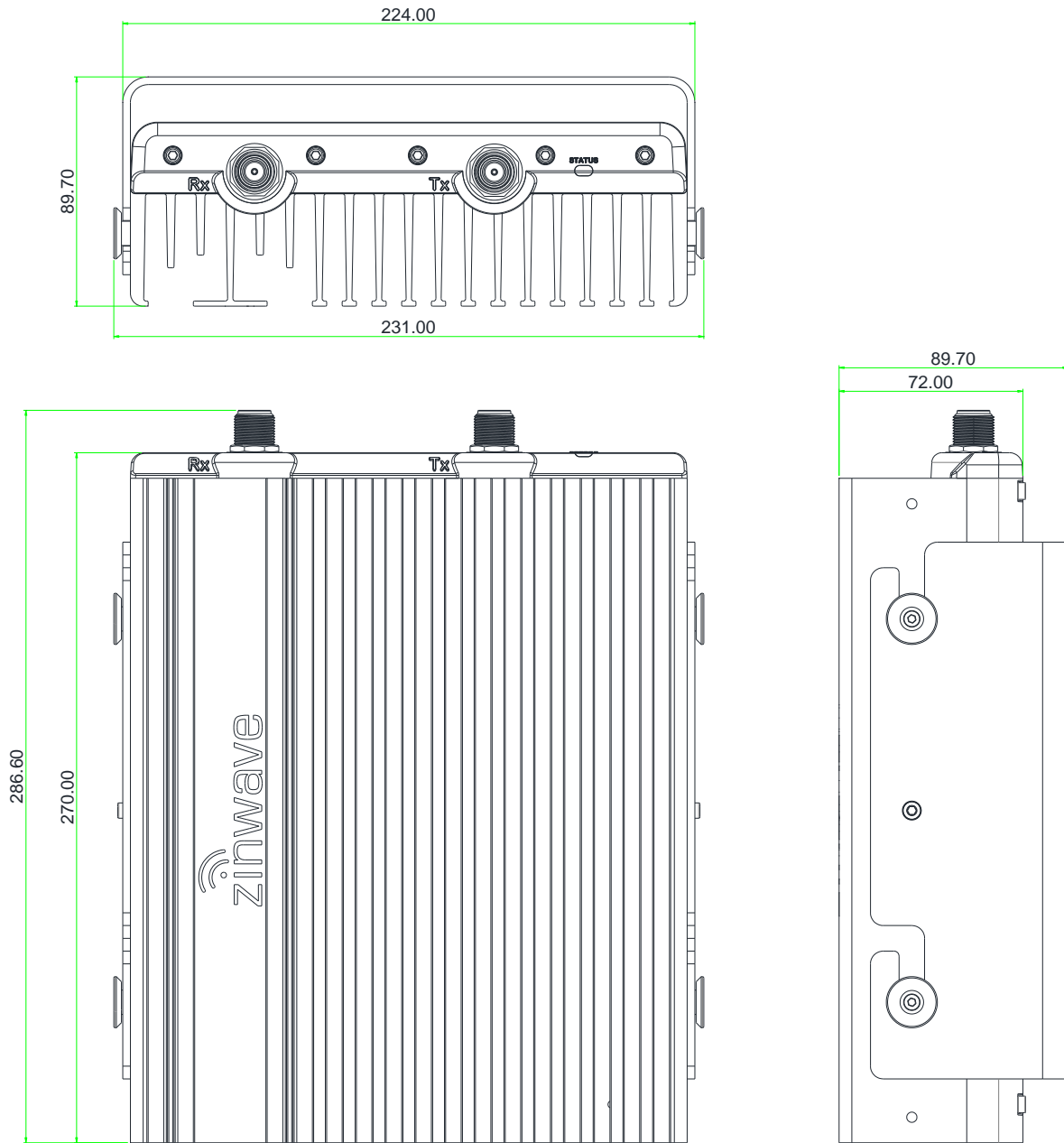

308-0007-1 Uniwave Remote Unit

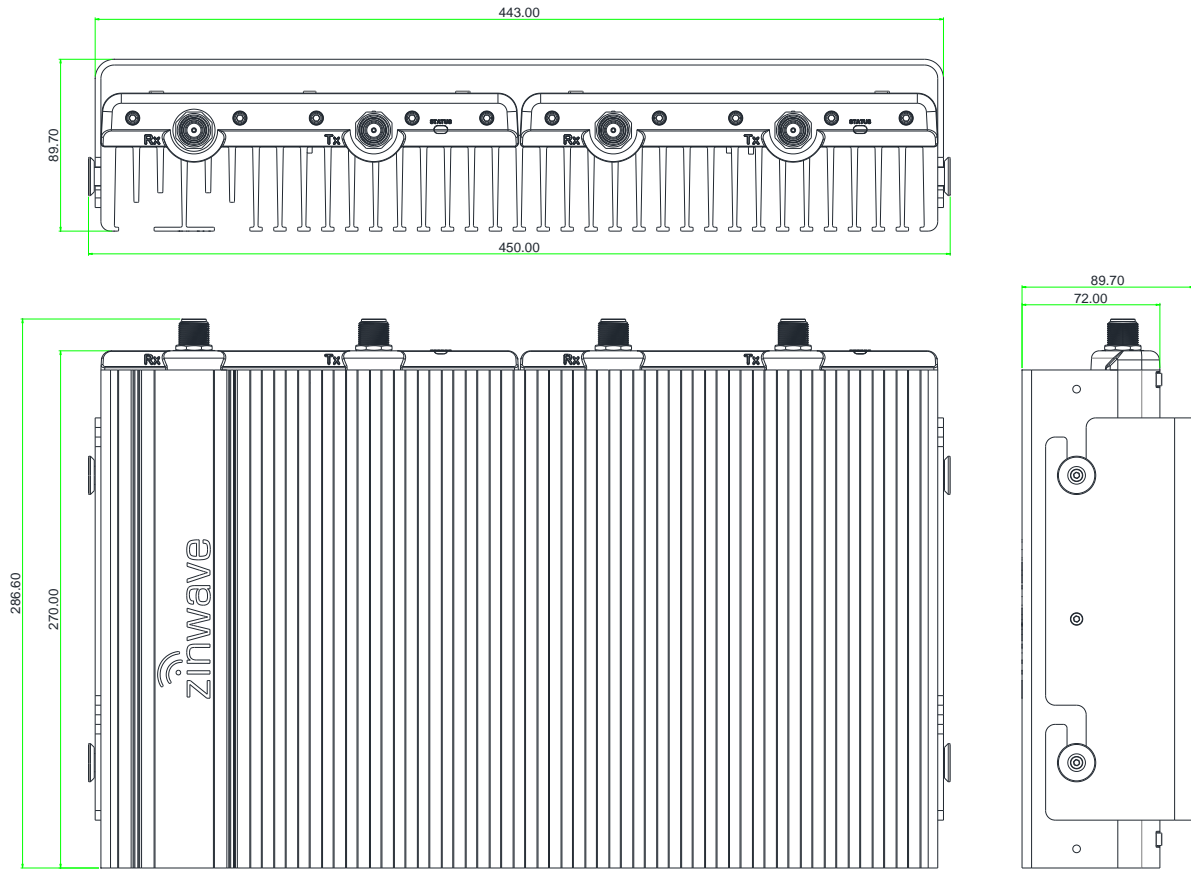

308-0007-2 Uniwave 2-Path Remote Unit

The 2-Path Remote Unit has two identical paths within it. The Hub software identifies the two halves as “Uniwave 2-Path RU, Path A” and “Uniwave 2-Path RU, Path B”. Physically, the “A” half of the Remote Unit is under the Zinwave Logo on the heatsink.

The 4-Path Remote Unit comprises two 2-Path Remote Units and a double bracket. The 2-Path Remote Units each have independent serial numbers of the form 90xxxxnnnnn.

Each of the 2-Path Remote Units has two identical paths within it. The Hub software identifies the two halves as "Uniwave 2-Path RU, Path A" and "Uniwave 2-Path RU, Path B". Physically, the "A" half of the Remote Unit is under the Zinwave Logo on the heatsink.

During installation, it may be important to record which Remote Unit is used for which MIMO path.

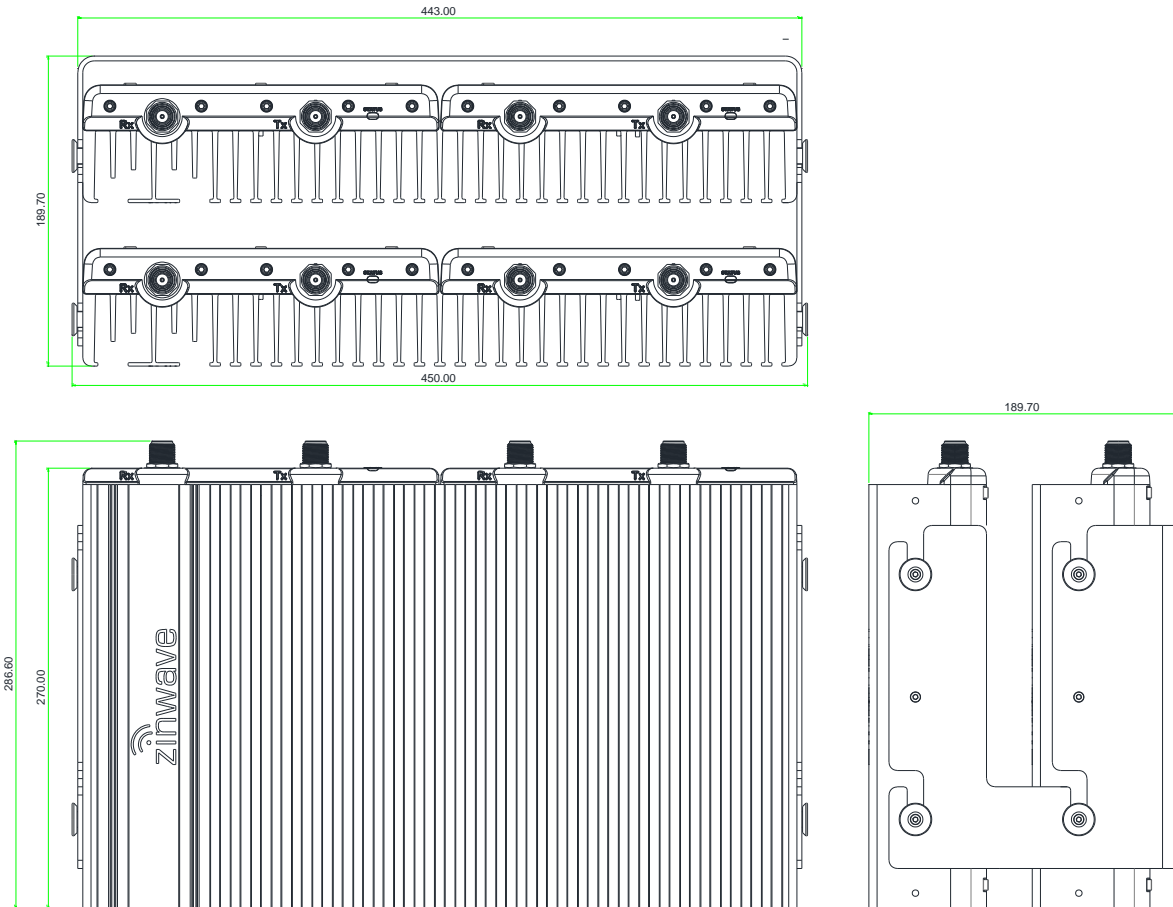

308-0007-4 Uniwave 4-Path Remote Unit

For all types of Remote Unit:

- Ensure that adequate space is provided to allow for any power and signal cables to be connected and that minimum bend radii of cables and fibers are met.
- Make sure there is room for antenna connections to exit through the ceiling.
- Make sure there is adequate clearance around each Remote Unit to allow some convection.

The following wall brackets are provided for mounting each type of Remote Unit:

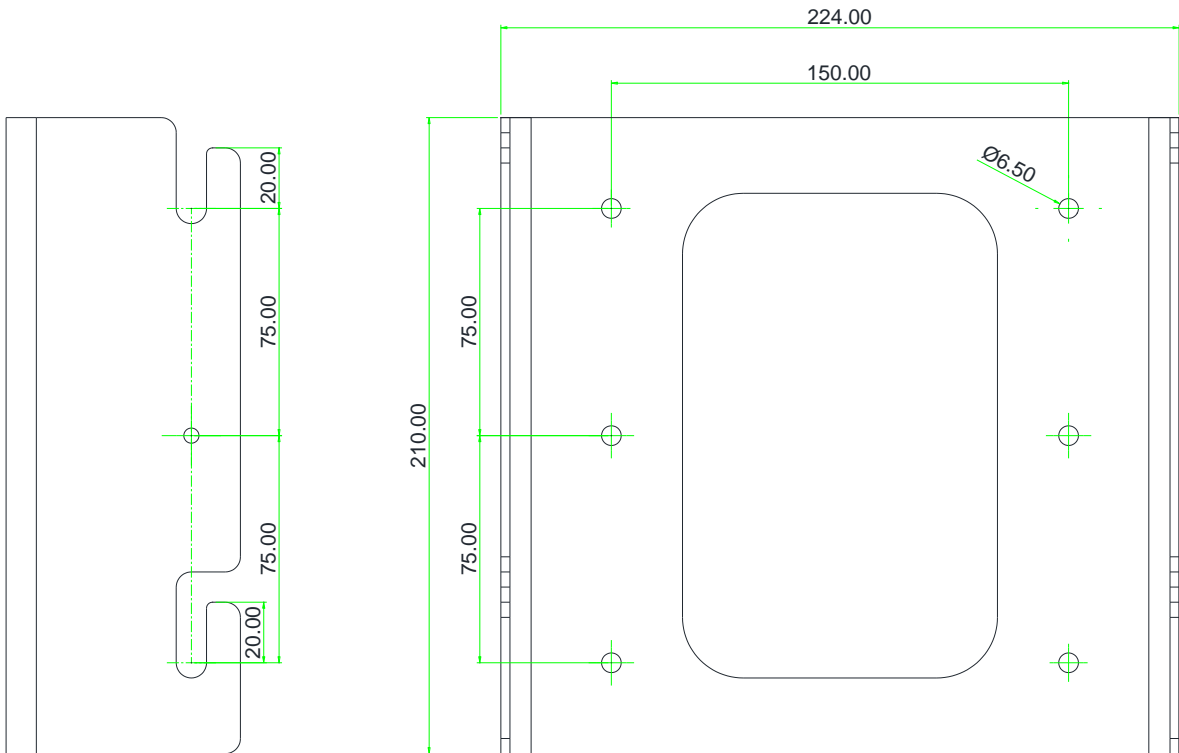

Wall Bracket for 308-0007-1 Uniwave Remote Unit

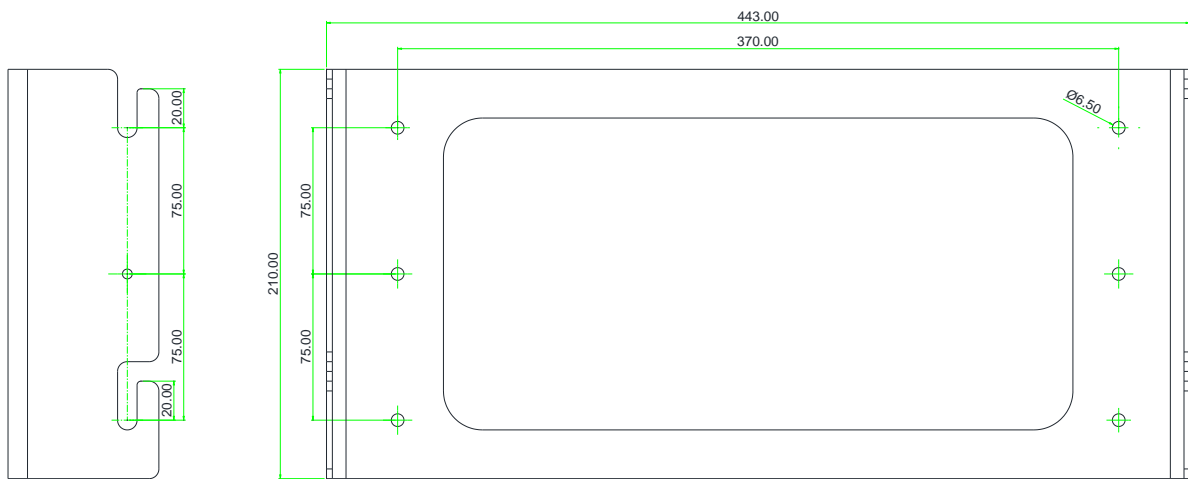

Wall Bracket for 308-0007-2 Uniwave 2-Path Remote Unit

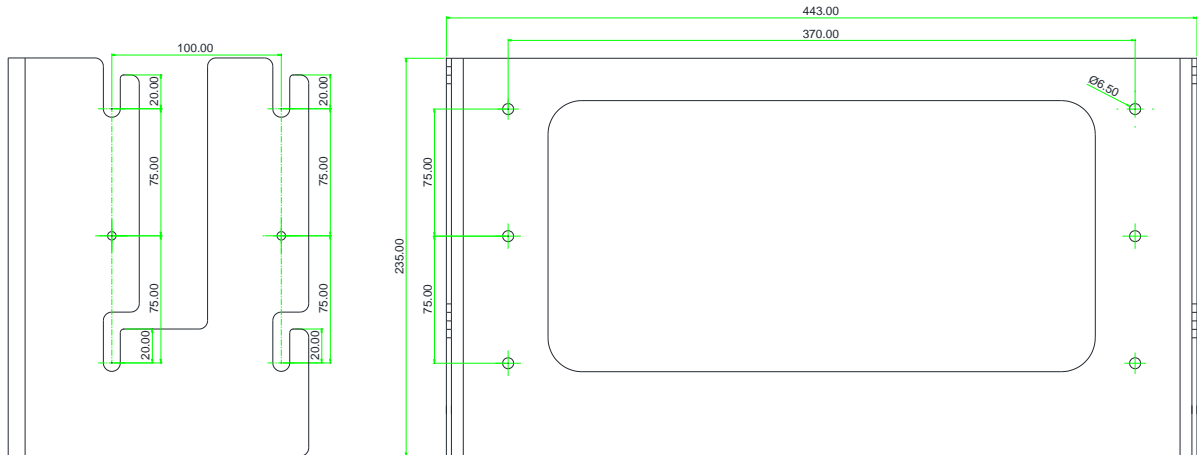

Wall Bracket for 308-0007-4 Uniwave 4-Path Remote Unit

1. Place the mounting bracket on the wall in the desired location and position (Horizontal or Vertical).
2. Select suitable screws for attachment and mark the 6 holes to be used with a pencil.
3. Remove the bracket.
4. Drill the 6 screw holes.
5. Attach the bracket to the wall using a screwdriver and suitable screws.
6. You may need to use additional hardware such as rawlplugs, for a secure fit.
7. Align the lugs on the side of the Remote Unit with the dog-leg slots in the bracket. Orientate the product such that the cooling fins provide the best convection. This may mean that the fins are outermost or uppermost.
8. Once the Remote Unit is engaged in the bracket, fit the 2x M4 locking bolts on each side to ensure the Remote Unit cannot become detached from the wall mounting. This step is particularly important if the Remote Unit is suspended from the wall bracket and might cause a hazard if it were to become detached.

6.2 Powering Remote Units

A Remote Unit receives power from a 48V Central PSU (if connected directly to a Primary Hub), or from the Secondary Hub to which it is connected. In the case of the Uniwave 2-path Remote Unit 308-0007-2, there are two DC connectors as well as two sets of fiber connectors. Each half of the 2-path Remote Unit needs to be connected to its corresponding DC and fiber ports on the appropriate Secondary Hub.

6.2.1 PSU DC Power

6.2.1.1 Rack Mount the PSU

The following tools are required for installation (Not provided):

- 4x M6 cage nuts appropriate for 19 inch rack frame (If required)
- M6 pozi-drive screwdriver
- Cage nut insertion/extraction tool
- Washers and Screws, suitable for Rack type, to secure equipment

To install the PSU in a rack

1. Using the cage/nut insert/extraction tool, install 2 cage nuts on each side of the rack. The spacing needs to align with the holes in the PSU.
2. Place the PSU into the rack and secure using suitable mounting screws and washers.

Note: While a power lead is not supplied inside the box as shipped – Zinwave does provide the country specific power lead in with the shipment where PSU are required by the customer.

6.2.1.2 Applying DC power to the Remote Unit

See “[Connecting the PSU or Secondary Hub Power Port to Remote Units](#)” for pin out information and, specifically, “[Power Distribution Requirements](#)” For power distribution information.

To connect the PSU to the Remote Unit.

1. Connect/plug the cable to the appropriate connector on the PSU or Secondary Hub.
2. Route the cable from the PSU / Secondary Hub to the Remote Unit.
3. Plug the cable into the 48V connector on the Remote Unit.
4. Repeat for each PSU / Secondary Hub to Remote Unit connection. Once power is plugged in, the unit is powered on.

Note: It is recommended to connect fiber prior to powering on the Remote Unit.

7 DAS Installation Considerations

This chapter describes requirements and considerations to get the best performance from your DAS.

7.1 Antenna Requirements

This section describes antennas that can be connected to Remote Units. For physical connection of the antenna to the Remote Units see [“Connecting Antennas to Remote Units”](#).

7.1.1 Isolation

The minimum isolation between Tx and Rx required for correct operation of Uniwave in both the uplink and downlink service bands is usually 40dB (this requirement should be confirmed for any given installation within the Zinwave Coverage Tool). However, performance (uplink noise and downlink inter-mode interference) of the system can be improved if greater isolation is achieved. Isolation between the antennas is achieved by separating them at a sufficient distance to achieve at least 40dB over the antenna passband or the entire Uniwave passband, whichever is narrower.

It has been found empirically that omni-directional antennas supporting the Cellular bands from 700MHz and above require a horizontal separation distance of approximately 20 ft (6m).

Although this distance provides a rule of thumb for initial planning, the particular antennas in use and the environment in which they are installed will affect the isolation. It is recommended to check and measure the isolation of each antenna pair (see isolation measurement section below) prior to enabling service operation.

With directional antennas care should also be taken to ensure the high-gain propagation direction is oriented towards the coverage area and the low-gain (“null”) propagation direction is oriented towards the second antenna. The effect of this null will be to reduce the distance between the antennas required to achieve the 40dB isolation.

7.1.2 Isolation Measurement Techniques

The most accurate way of measuring the antenna isolation, is to disconnect the cables at the Remote Unit antenna ports and connect these directly to either a network analyzer or a spectrum analyzer with a tracking generator. Every antenna in the installation should meet the requirements of the Tx-Rx Isolation section above. The Hub Software also includes an antenna isolation check feature (System Maintenance > System Check), which should be used for quick isolation checks where problems are suspected or may arise.

7.2 Uplink/Downlink Balance

Care should be taken not to separate the two antennas by so much distance that the path difference between Tx and Rx to the mobile affects system performance. Some services are more affected by uplink/downlink path difference than others, especially those using high dynamic range mobile power-control such as WCDMA.

There are two WCDMA system effects to be aware of when testing a separated antenna coverage area:

- When the mobile is close to the Tx antenna but some distance from the Rx antenna, the initial call-setup power that the mobile transmits will be lower than expected by the BTS. It is likely that the BTS will fail to receive the initial call-setup attempt, so the mobile will transmit again at a higher power level. The mobile will continue to ramp up its power level until the BTS receives and acknowledges the message. This effect can cause longer initial setup times close to the Tx antenna and in extreme cases may cause the mobile to timeout during call setup. In order to compensate for this effect, the balance of gain between uplink and downlink can be adjusted to increase the uplink gain. This is usually done in the head-end by moving attenuation from the uplink to downlink paths. However, in some case the UL/DL balance setting can also be used within the Uniwave platform if the uplink gain is not already at maximum.
- When the mobile is close to the Rx antenna but some distance from the Tx antenna, the initial call-setup power that the mobile transmits will be higher than expected by the BTS. As long as the mobile power does not overload either the Remote Unit or the BTS input then this should not cause a call setup failure.

Note that the path difference between Tx and Rx at the edge-of-cell is likely to be much smaller than near the antennas due to the effect of the indoor propagation conditions. Where there are no line-of-sight differences between Tx and Rx the edge-of-cell path difference will be less than 3dB for most services.

7.3 Connecting Antennas to Remote Units

The Remote Unit has separate connectors for transmit and receive antennas. The choice of antenna depends on the RF coverage and planned designs for a building, you may need extension cables depending in where the antennas are placed relative the Remote Unit.

To connect antennas to Remote Units:

1. Connect the N-type male connections into N-type female connectors on the top of the Remote Unit. Note the markings on the unit for Rx and Tx.
2. If you have not already done so, feed the RF extension cables through from the Remote Unit to the Antenna.
3. Connect the N-type female connections into N-type male connectors to the RF tails.

Pay attention to the mechanical stress placed on the connector if using large inflexible cable. Use short flexible jumpers where appropriate.

7.4 Connecting the PSU or Secondary Hub Power Port to Remote Units

7.4.1 Power Distribution Requirements

Power for Remote Units is generally supplied from a centrally located source – either a dedicated PSU or a Secondary Hub - that drives multiple Remote Units. The distance of the Remote from the centralized location depends upon the cable type used. Regardless of the cable used, the maximum loop resistance should generally be kept below 8 ohms to ensure the minimum input voltage requirement of the Remote Unit is not violated.

Copper wire containing 2 cores is typically used to carry 48V power to Remote Units. This can either be run in parallel with fiber infrastructure, or as part of a composite cable.

The power supply capability of each Secondary Hub DC port is limited to 100W continuous, to comply with PS2 power source class in UL 62368-1 safety standard. The total output load supported by a Secondary Hub is 600W. This supports 1 or 2 Remote Units powered from a single Secondary Hub power port, each one requires typically 38W. Note that a 2-path RU (308-0007-2) has two 48V DC inputs, and a 4-path RU (308-0007-4) has four 48V DC inputs. It is advised to connect each 48V DC input to a separate power port on a Secondary Hub. This provides best operating margin, some system redundancy, and also permits the RF System Check to monitor the DC status of each RU.

With AWG 16, the maximum distance that can be achieved is approximately 300 m (~1000 ft). If greater distances are required, larger gauge cable may be used. The Phoenix Contact connectors used on the Zinwave equipment support wire thickness up to AWG 12. The guidance for the maximum distance that can be achieved for given AWG wire is as follows, when a single Remote Unit is powered with a single conductor pair. If 2 collocated Remote Units are powered with a single conductor pair, below distances are halved.

Distance (ft)	Distance (m)	Recommended AWG wire Size
≤ 2500	≤ 760	AWG 12
≤ 1500	≤ 455	AWG 14
≤ 1000	≤ 305	AWG 16
≤ 600	≤ 180	AWG 18
≤ 375	≤ 115	AWG 20
≤ 235	≤ 70	AWG 22

AWG wire size (solid)	Diameter (inches)	Resistance per 1000 ft (ohms)	Resistance per 1000 m (ohms)
24	0.0201	25.67	84.2
22	0.0254	16.14	52.7
20	0.032	10.15	33.2
18	0.0403	6.385	20.9
16	0.0508	4.016	13.2
14	0.064	2.525	8.28
12	0.0808	1.588	5.21

Wire Conversion Chart: American Wire Gauge to Square Millimeters							
AWG	mm ²	AWG	mm ²	AWG	mm ²	AWG	mm ²
30	0.05	18	0.75	6	16	4/0	120
28	0.08	17	1.0	4	25	300 MCM	150
26	0.14	16	1.5	2	35	350 MCM	185
24	0.25	14	2.5	1	50	500 MCM	240
22	0.34	12	4.0	1/0	55	600 MCM	300
21	0.38	10	6.0	2/0	70	750 MCM	400
20	0.50	8	10	3/0	95	1000 MCM	500

7.4.2 Understanding Connectors & Cabling

Cabling between the PSU or Secondary Hub is not supplied.

Ensure that the 48 V cable used is one of the following:

- 2-core power cable listed in accordance with NEC 645.5(B)
- Or Installed in an enclosed raceway
- Or be installed in accordance with NEC 721.135(C)
- Or be type CMP, CMR, CN or CMG
- Or be listed type DP cable suitable for use under raised floors

Termination of each cable type will depend on the PSU version used, and you may need to utilize an adapter to make the final connection. Ensure the 48V connection is made with correct polarity.

Note: If you use your own 48V power supply, rather than the Zinwave Remote PSU or Secondary Hub, the cable instructions are the same as for the Zinwave equipment.

The 48V power connector used on the Zinwave Secondary Hub and Remote Unit is:

- Terminal block HDR 2pos 5.08mm
- Phoenix contact
- P/n: 1757242



Pin	Detail
Left	48V (+)
Right	0V (-)

Mating plugs from the same series of connector are provided and should be used to terminate the 2-core cable.

The 1U Rack-mount PSU uses screw terminals, so the wire pair can be connected directly in that case.

7.5 Uplink System Noise

7.5.1 Introduction

Anything with active electronics will generate some level of noise in addition to the desired function. Usually this becomes a consideration in an amplifier system such as an Active DAS. Cellular systems assess “noise” as part of their operation and its presence is monitored and can cause an alarm condition.

Older 2G (GSM) technology usually has an alarm for “interference” which an excessive noise level will trigger.

3G (UMTS W-CDMA) is a spread spectrum system and the signals also look like “noise” in the receiver. The incoming noise level rise (wanted signal and /or unwanted noise) is used for “access control” in a 3G BTS which limits the number of users that can be connected. Due to this noise into the receiver is a very critical issue for 3G and will affect the efficient operation of the BTS.

4G and 5G (OFDMA) is a multiple access system using multiple sub-carriers at low data rates to achieve an overall high data rate. OFDMA is affected by intermodulation and excess system noise – both may affect the performance of the system.

7.5.2 Optimising SNR and Noise Level

With most active systems a Point of Interconnection (POI) is used to match the BTS power and signals to the input of the DAS. The POI must apply downlink (DL) power attenuation to manage the level into the Primary Hub of the DAS.

The POI must also apply a suitable amount of UL attenuation. With 3G, 4G and 5G a lot more attention must be paid to the uplink (UL) signals and noise such that the noise level fed to the base station (BTS) is at or below the level which affects the BTS operation.

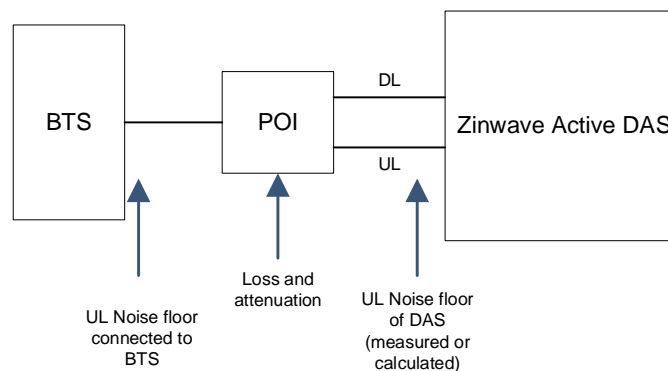

The Noise contribution of the Zinwave Active DAS is related to the amount of equipment in the system. It is proportional to the additive noise power from each Remote Unit. It can be calculated from:

$$NF = 14 + 10 \times \text{LOG}(\text{SQRT}(\text{qty of RUs})) + 10 \times \text{LOG}(\text{SQRT}(\text{qty of SHs}))$$

This is an empirical formula that gives a “best fit” to the measured results of the system and was used to generate the data below.

Calculated using Empirical Formula: $NF = 14 + 10 \times \text{LOG}(\text{SQRT}(\text{qty of RUs})) + 10 \times \text{LOG}(\text{SQRT}(\text{qty of SHs}))$									
Data Table of ORU/SH combinations		number of ORU/SH---->							
Noise Figure		1	2	3	4	5	6	7	8
number of SH--->	1	14.0	15.5	16.4	17.0	17.5	17.9	18.2	18.5
	2	17.0	18.5	19.4	20.0	20.5	20.9	21.2	21.5
	3	18.8	20.3	21.2	21.8	22.3	22.7	23.0	23.3
	4	20.0	21.5	22.4	23.0	23.5	23.9	24.2	24.5
	5	21.0	22.5	23.4	24.0	24.5	24.9	25.2	25.5
	6	21.8	23.3	24.2	24.8	25.3	25.7	26.0	26.3
	7	22.5	24.0	24.8	25.5	25.9	26.3	26.7	27.0
	8	23.0	24.5	25.4	26.0	26.5	26.9	27.3	27.5

The desired maximum noise level at the BTS is known from the MNO (3G typically -104 dBm, 4G typically -114 dBm)

Therefore, a simple calculation can be made calculate the POI attenuation needed to match the DAS UL noise level to required level at the BTS

$$\text{Noise power (noise floor)} = KTB + NF + \text{gain of the DAS} - \text{POI attenuation}$$

Where

K= Boltzmann's constant= 1.380×10^{-23} J/K

T = temperature in Kelvin

B = bandwidth in Hz

“POI Attenuation” is the total loss in the POI including cables to the BTS and all attenuators and other losses

e.g. a WCDMA channel is 3.88 MHz, therefore the thermal noise in the channel is -108.1 dBm

27.5 dB noise from 1-8-64 system,

25 dB system gain

$$-108.1 + 27.5 + 25 = -55.6 \text{ dBm}$$

50 dB POI UL attenuation

$$-55.6 - 50 = -105.6 \text{ dBm}$$

The uplink gain of the DAS is internally configured to mirror the downlink values, modified by the UL/DL balance setting on the Hub GUI. Under normal circumstances, selecting a lower gain than the maximum of 25dB will simply add more attenuation into the service module. This has no impact on the noise figure, and is equivalent to adding attenuation in the POI. Noise figure is impacted, however, if the RU applies AGC protection due to an excessive interferer. It may be necessary to re-site the Rx antenna if there are persistent high measured background RF levels.

The UL noise floor from the Active DAS could also be measured at the POI input using the correct system bandwidth and the UL POI attenuation calculated from that value.

Comparing calculated Noise floor against that measured will also confirm that no other issues are causing a higher than expect noise floor output from the DAS

7.5.3 UniTransport

Cascading two Primary Hubs in a UniTransport system makes little difference to the foregoing discussion. The overall gain between a Service Module in the UniTransport Hub and a Remote Unit in the downstream Primary Hub is configured to have the same gain as if the Service Module had been plugged directly into the downstream Primary Hub. The internal setup of the system optimizes the levels to minimize overall distortion and noise, typically to within 1 dB of what would be achieved with the downstream Hub and its components alone.

The main contributor to Uplink noise is the number of Remote Units that are being aggregated together. Each one adds some noise, but only one has the signal to be received by the BTS. The values in the Noise Figure table and formula above are valid for up to 64 Remote Units connected indirectly to a UniTransport Hub. If the number of connected RUs were to be doubled from 64 to 128, expect the noise power at the BTS to increase by 3dB. As before, the POI UL attenuation would need to be adjusted to achieve a compliant uplink noise power at the BTS.

8 Performing Basic Configuration

The following procedures are intended to be executed after the hardware installation is complete. All hardware has been installed and configured with at least an IP address. All equipment is connected, and the system is ready to be configured

To Configure Uniwave :

1. The Zinwave Coverage Tool is used to plan the system and calculate the setting required for its deployment. Gather all needed input information generated by the coverage tool and any measured signal input powers.

This will provide you the following information:

- Input power from each Service
 - Service mix and allocation to Remote Units
 - Composite power settings
 - Results of any coverage calculations for each Remote Unit
2. Make sure power is on for every unit.
 3. Make sure all modules have been inserted.
 4. Make sure all connections have been made, self-discovery happens, and LEDs settle to solid green

Note: Indicator lights will adjust as system setup configuration is corrected.

1. Login to the Primary Hub. See [“Accessing the GUI”](#).
2. Set date and time on Primary Hub in the Hub Setup page. See [”Date and Time”](#)
3. On the Primary Hub check and, if necessary, upgrade to the latest software version.
 - See [“Software Upgrade”](#).
4. Enter the System Setup information for all Hubs and Remote Units. See [“System Setup”](#).
5. Review System Status and RU Calculations. See [“System Status”](#)
6. Enter sensitivity and configure alarms. See [“Understanding Alarms & Reporting”](#)
7. Enter Hub Setup details, if desired. See [”Hub Setup”](#)
8. Save config file and system snapshot. See [“System Snapshot”](#)

9 Understanding the Configuration GUI

A Configuration Graphical User Interface (GUI) is available to configure your equipment locally or remotely via ethernet. The GUI is hosted on the Primary Hub and is used to configure and monitor the Primary Hub and all connected Secondary Hubs and Remote Units. This section describes how to access the GUI and the general features of this interface. Specific configuration items are located in their respective sections.

Windows may appear slightly different based on your browser; however, all features are the same. The screen shots shown in this document are from Google Chrome.

Each main GUI page is selected via the items in the left navigation menu. Comprehensive help is easily accessible in the GUI by clicking on the arrow tab on the right side as circled in red below. Help for System Views in the bottom left of the screen is provided within the help for the System Status GUI page.

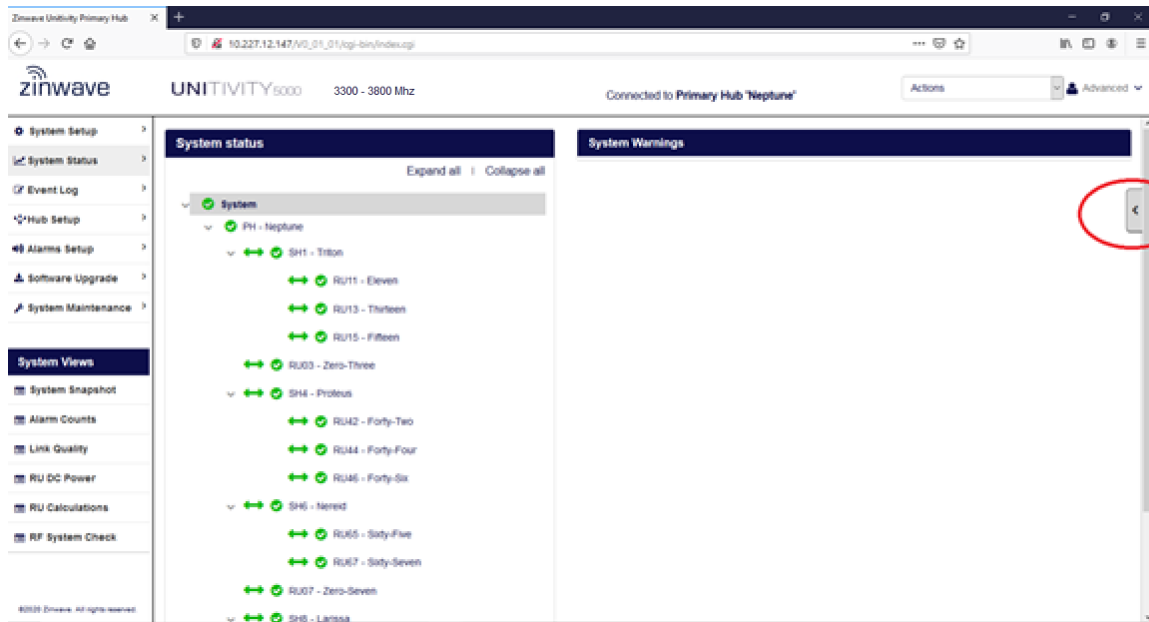

9.1 Supported Browsers

The Configuration GUI is a web-based application. It runs on a variety of browsers including: Windows Edge and Internet Explorer, Mozilla Firefox, Google Chrome, and Safari.

9.2 Initial Standalone Access

Every hub is set to the same IP address (192.168.0.2) on leaving the factory, and after performing factory preset. In order to access the GUI in this state, the simplest method is to use a direct ethernet connection from a standalone PC. To do this, you need to match the PC's IP address to the same subnet as the default Primary Hub address.

To change the IP address of the standalone PC:

1. Set the standalone PC to use a static IP address on the same subnet e.g. 192.168.0.3, with a subnet mask of 255.255.255.0.
2. Make an Ethernet connection from the standalone PC to the Primary Hub (either a crossover or straight-through Ethernet cable can be used).
3. Access the GUI as described in [“Accessing the GUI”](#) and go to the Hub Setup page to change the IP address. See [“IP Settings”](#).

9.3 Accessing the GUI

The GUI is initially accessible via a Web browser through a secure (https) connection (but can be changed to an unsecured (http) connection via the [“User Interface Settings”](#) section of the Hub Setup page.) For initial configuration of a device, you need local access via an ethernet connection to the front of the Primary Hub. After that, you can access the Hubs and Remote Units remotely on the network you created during the initial setup.

To access the GUI:

1. Open the desired browser.
2. In the address line, enter “https://ip_address” where the *IP address* is the address of the Primary Hub you wish to configure. For an initial configuration the IP address is https://192.168.0.2. If you changed it in the [“IP Settings”](#) section of the Hub Setup page, use that address.
3. Press Enter.
4. A Security Certificate authorization may appear depending on whether the PC you are using to access the device has previously been used. If it appears, continue to step 5. If not, and the Login window appears. Go to step 7.
5. Accept the Security Certificate.
6. Depending on your browser, a series of acceptances may need to be confirmed. Click through the options to accept the Certificate. You may need to select advanced options to see all acceptance options.
7. The Login window appears (browser specific.)

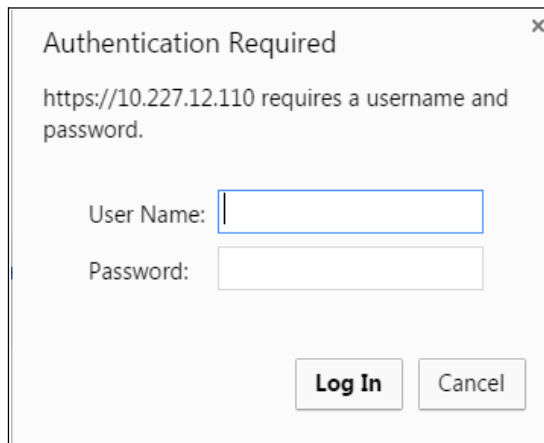

8. Enter the username and password. There are three privilege levels available.

Username	Default Password	Description
viewer	No Password	View system status but cannot make any changes.
basic	installer	View system status and can make only a subset of configuration changes.
advanced	supervisor	View and change all options.

See “[Changing User Passwords and Timeouts](#)” for information on changing passwords.

9. Click Log In.
10. On successful login, the System Status window appears. The left navigation menu allows access to all other screens in the application.

The table below outlines specific actions available to a “basic” user:

Page	Setting	Permission
System Setup	Setting up the Hub system	Read-only access.
Event Log	Logging and Filtering	Start and stop System logging, Download Event and System logs, and start and stop event log filtering. (Same as an “advanced” user.)
Hub Setup	All, except Security Settings	Read-only access.
Hub Setup	Security Settings	Can change “basic” user’s password (Not “advanced” user.) Can set the “Inactivity Timeout” period (but, NOT set it to “Keep me logged in”).
Alarms Setup	All	Can change the Warning LEDs configuration. Can configure and customize the Warning and Fault relays (Same as an “advanced” user.)
Software Upgrade	All	No privileges to upgrade software.
System Maintenance	All	No privileges to schedule or run System Maintenance tasks.
System Views	All	Can open and view all System Views. Can save System Snapshot Report. (Same as an “advanced” user.)
Actions (Dropdown)	All	No privileges to Save or Load configuration. Cannot Download System Tables.

9.4 Understanding the Main Window

Once logged in, the Main Window is displayed. Depending on the browser used, the look and feel may differ slightly, but the functionality remains the same. The GUI opens to the System Status page by default and displays the Hub to which the PC is connected.

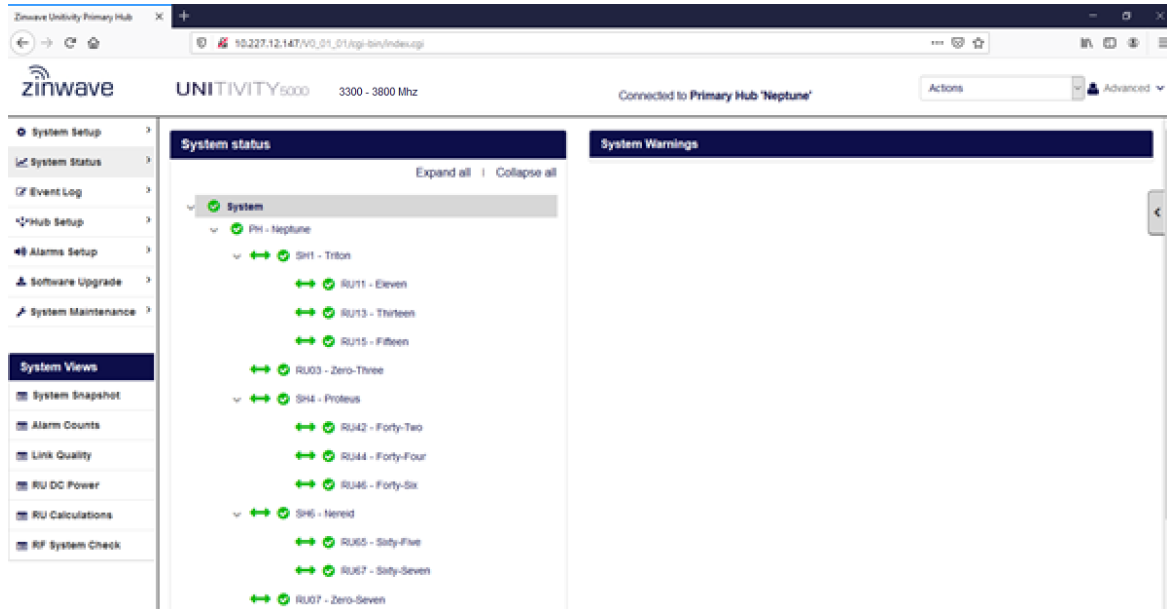

9.4.1 Address Bar

The address bar displays the IP address of the Hub you are currently logged into. Depending on the choice of browser, it may also show the version of the software installed on the Hub.

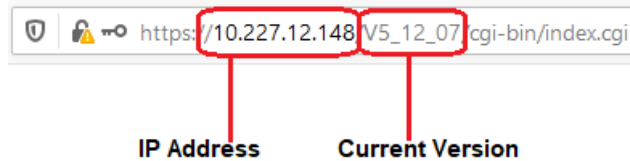

9.4.2 Login Bar

The login bar shows the Primary Hub label (if set) and who is logged into this application.



9.4.3 Help Button

The Help Button is available on the right side of the screen.

To access help:

1. Click the arrow Help button on the right side of the screen.

The help window opens with help specific to your current screen.

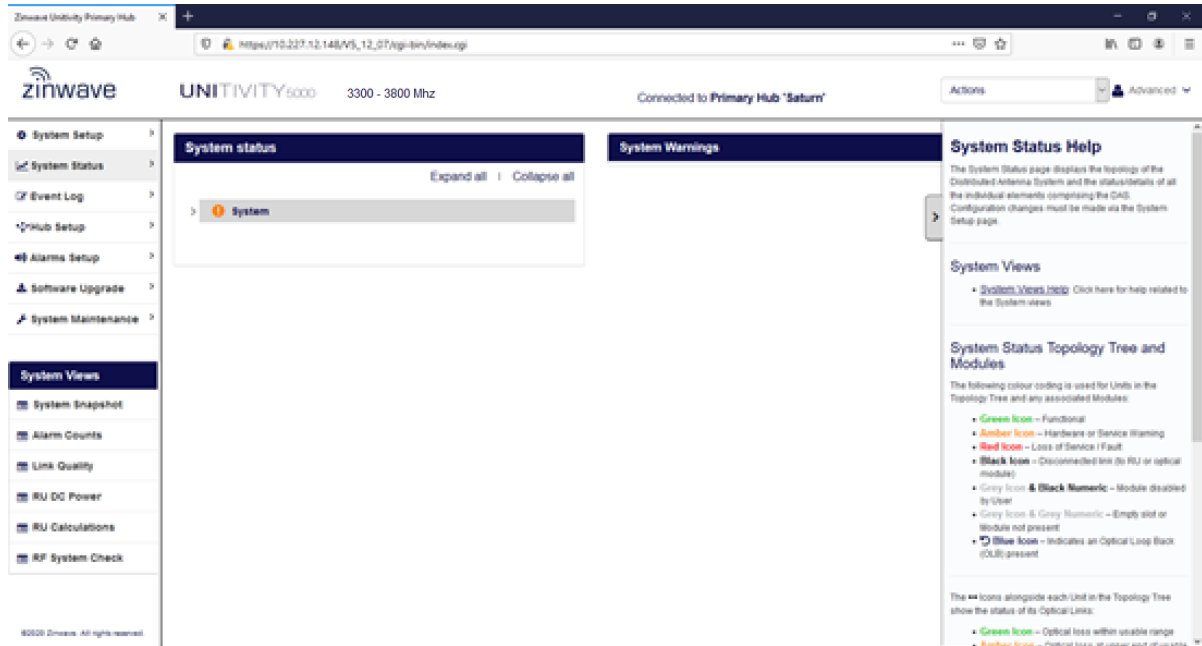

2. View the help and click through to get to additional information, if desired.

9.4.4 Display Area

The Display area shows the screen selected via the top-left navigation bar. In the System Status page, selecting individual units in the expanded Topology tree will show additional information about those units.

9.4.5 Progress Indicator



Throughout the use of the application, the progress indicator is displayed. This indicates that the system is gathering or calculating information. When the task is complete, the desired information or page is displayed.

9.4.6 Changing User Passwords and Timeouts

In the Security Settings section of the Hub Setup page an “advanced” user can change the password for both an “advanced” and “basic” user. The Inactivity Timeout period can be set too.

To change User Security settings for a Hub

1. Click Hub Setup in the left navigation bar.

The Current user is shown in the Security Settings pane.

The screenshot displays the Uniwave Configuration GUI for a Primary Hub. The left sidebar contains navigation options: System Setup, System Status, Event Log, Hub Setup (selected), Alarms Setup, Software Upgrade, and System Maintenance. Below these are System Views: System Snapshot, Alarm Counts, Link Quality, RU DC Power, RU Calculations, and RF System Check. The main content area is titled 'Hub Setup' and includes a 'Restart Hub' button. It is divided into five panels:

- IP Settings:** IP Address (10.227.12.148), Subnet Mask (255.255.255.0), Gateway Address (10.227.12.1). Includes an 'Update' button.
- SNMP Settings:** Trap IP Address (10.227.17.24), Trap Port (162), Trap Type (Trap), RO Community (public), RW Community (private). Includes an 'Update' button.
- User Interface Settings:** Connection Encryption (SSL) (enabled (https)). Includes an 'Update' button.
- Date & Time:** NTP Client (Disabled), NTP Server (216.239.35.0), Time (03:08:02), Date (29/03/2020), Time Zone (WET (Standard: UTC, Summer: UTC+1)), Custom TZ string (GMT0BST,M3.5.0/1,M10.5.0/1). Includes an 'Update' button.
- Security Settings:** Current User (advanced), Inactivity Timeout (minutes) (Keep me Logged In), Select user password to change (basic), Enter Password, Re-enter Password. Includes an 'Update' button.

2. Select the desired number of minutes from the Inactivity Timeout pulldown in the Security Settings pane to set the period of inactivity in the Configuration GUI before forcing a logout.

Security Settings	
Current User	advanced
Inactivity Timeout (minutes)	Keep me Logged In <input type="button" value="v"/>
Select user password to change	basic <input type="button" value="v"/>
Enter Password	<input type="text"/>
Re-enter Password	<input type="text"/>
Click to update settings	<input type="button" value="Update"/>

Advanced users can also choose to “keep me Logged in”.

3. To change a user password...
 1. Select the user type password to change from the pulldown.
 2. Enter a new password
 3. Re-enter the new password.
 4. Click Update.

10 Initial System Setup

This chapter provides the basic configuration setup items to get a system up and running.

Note: If you wish to setup SNMP during the initial setup of the system, see [“SNMP”](#).

10.1 Connection to DAS System

The entire DAS system is setup and configured via the Configuration GUI on the Primary Hub. Access the GUI on your Primary Hub using a Web Browser, as described in the previous section.

10.2 Software Upgrade

Equipment is shipped with the latest version of software at the time of manufacture. However, updates may have been made after shipping. The latest version of software is always available via your Zinwave supplier or from the support area on our website <https://portal.zinwave.com/portal-gateway/> (Registration is required). A Uniwave software update will update the Primary Hub software, as well as firmware on connected Secondary Hubs and Remote Units. Complete this step first if newer software is available.

10.2.1 Full System Software Upgrade

The Software Upgrade feature allows the user to deploy a software update to the Primary Hub and all attached Secondary Hubs and Remote Units in a DAS, using a single upgrade file.

The Units table in the Software Upgrade page shows all the hardware elements present in the system, including their Labels and Hardware and Software versions. Ensure that the system is complete and stable prior to starting an upgrade. All Secondary Hubs and Remote Units in the system should be updated to the firmware versions contained in the software release image that is deployed to the Primary Hub.

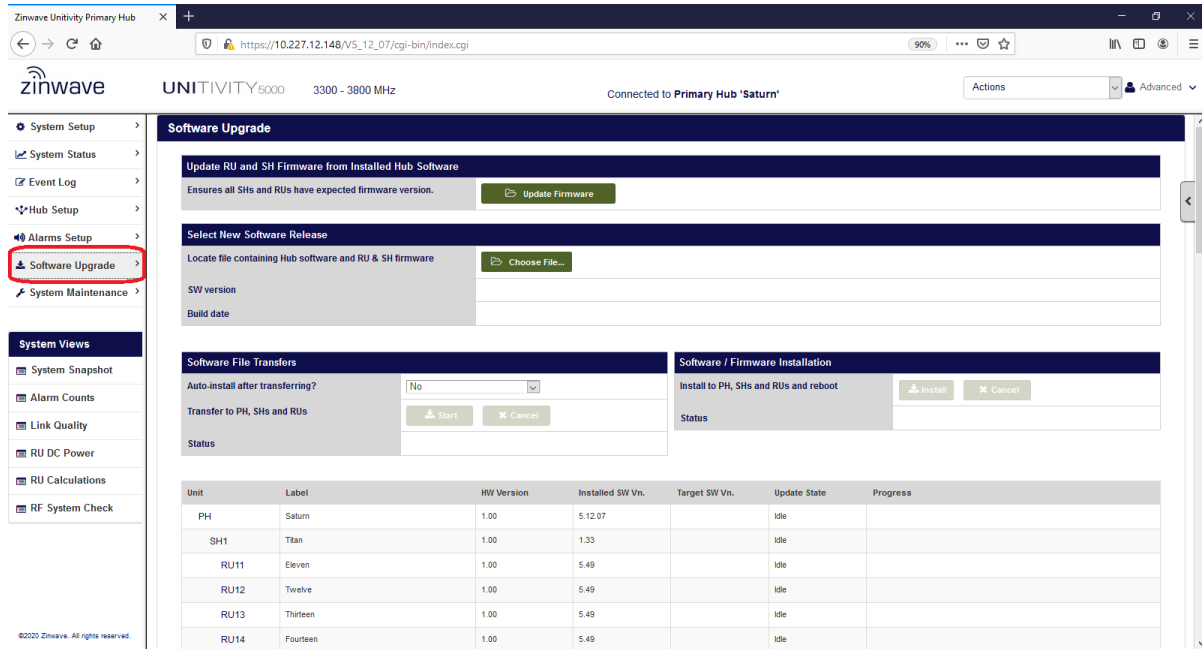

To install a new software release:

The software release '.das' file must be accessible to the system hosting the Web browser being used to access the Configuration GUI. Go to the Software Upgrade page.

Select New Software Release

Click the 'Choose File...' button to select a full new Software Release to be uploaded to the system. The software version details will be displayed.

Software File Transfer

Specify whether software auto-installation (involving reboot of affected units) should be automatically performed after software file transfers are completed or not, by selecting one of the options from the drop-down list "Auto-Install after transferring":

- *No* the "Install" button or "Cancel" button are available at the end of the transfer.
- *Yes, asap following upload* The firmware is installed onto the Primary Hub and flashed onto every Remote Unit and Secondary Hub automatically. The system reboots.
- *Yes, by scheduler* The installation and reboot process can be scheduled on the System Maintenance page, so the down-time can be arranged at a convenient moment out-of-hours.

Click the "Start" button to Upload and Decompress the software image files to all the Primary Hub, Secondary Hubs and Remote Units. This is carried out in a serial manner, and firmware transfers may take up to 4 hours in a large DAS. The firmware image will only be transferred to SHs and RUs that require updating. A progress bar will indicate the status of each Hub and Remote Unit transfer.

Software / Firmware Installation

Once all required Hub and Remote Unit transfers have reached 100%, software / firmware installation will proceed according to the "Auto-install after transferring" setting. The "Install" button will be made available and can be selected to initiate the software installation process manually.

Note that the entire DAS will be rebooted when a full new software Installation takes place.

Please wait for all the RUs and SHs to be Flashed, after which the Primary Hub will reboot. Following the system restart, warnings will be displayed if any SHs or RUs contain firmware that is not the expected version. If any unexpected firmware versions are reported, use the option to 'Update RU and SH Firmware from Installed Hub Software'.

10.2.2 To update RU and SH Firmware from an Installed Primary Hub Software Release:

In cases where the installed Primary Hub software is the desired version, but the system is warning that some Remote Units or Secondary Hubs contain an unexpected firmware version, it is possible to update the firmware on those units by clicking "Update Firmware". No release file is required in this case, as firmware that already exists on the Primary Hub is used. Only the SHs and RUs that require updating will be rebooted when firmware installation takes place.

10.3 System Setup

The System Setup page allows the user to view and apply an RF configuration to the DAS and enable and disable modules. It allows the user to declare how much power will be arriving at each Service Module Input, and how much transmitted power is required at each Remote Unit output. The system configures the corresponding downlink gains to achieve the requested output powers. It also configures the uplink gain, according to the downlink gain and the desired UL/DL balance.

10.3.1 Import Coverage Tool setting

This feature is used to load the RF design parameters during the system setup process. The user has the option of directly importing Coverage Tool settings or entering them manually.

To import Coverage Tool settings, click "Choose File" and locate a file with '.cts' extension, previously exported from the Coverage Tool (<https://tools.zinwave.com:8443>).

After changes are made to the configuration parameters, they can be validated by pressing the "Validate System Settings" button, which will cause the Validation Results page to be displayed. Click "Apply" to save the changed configuration (resulting in the System Status page opening). Changes can be cancelled at any stage prior to clicking "Apply" by clicking the "Undo" button, leaving the system running with the previously installed values.

Applying new settings reconfigures the entire system and will take several minutes on a large DAS.

10.3.2 Primary Hub Configuration

The expected input power arriving at each Service Module Input is dependent on the base-station output power and the attenuation in the POI hardware that feeds the Service Module. It is declared as the Calculated Input Level (dBm) at the Service Module input.

Services may also be brought to the hub over fiber using a Transport Module in a rear slot. The

Calculated Input Level (dBm) corresponds to the RF level on the fiber, which is recommended to be set to -25dBm.

Separately, the relative mix of power levels from each service input is specified by the Calculated Relative Power Level. The dominant input is set to 0dB, and the lesser inputs are set to a negative dB value. This determines the mix of signal levels appearing at the Remote Unit outputs.

The system uses these input parameters together with the desired DL Power required from each RU to configure the gains of each path in the downlink. It also configures the uplink gain, following from the downlink gain and the desired UL/DL Balance.

In this section, configure the label for the Primary Hub and the Services, enable or disable Service Modules (and Transport Modules). The Relative Input AGC Threshold is described below, where excessive input levels are managed. The RF Matrix has 4 inputs from each of the service modules, connected to 4 outputs via 16 independent switches. The 4 outputs feed consecutive pairs of the 8 Optical Modules on the front of the Hub, such that the Services may be flexibly routed to some or all of the Remote Units.

Note that composite RF input into a Service Module should not exceed +15dBm.

Individual Optical Modules and Transport Modules in the front slots of the Primary Hub can be directly disabled by clicking the green icon next to the port. A Module can be re-enabled by clicking the red icon next to the port. Enabling or disabling the Module is applied immediately the relevant icon is clicked (resulting in the System Status page opening.) There is no requirement to click "Validate Settings" and "Apply Settings" to enable or disable an Optical Module or Transport Module in a front slot.

10.3.3 Service Frequency Range and Regulatory Territory

Although the Uniwave DAS is fully wide-band, the system can make use of frequency band knowledge to maximise system performance.

System Setup

Import Coverage Tool Settings

Select new Settings Choose File...

Primary Hub Configuration

Hub Label	<input type="text" value="Earth (CM3 Wideband)"/>			
Minimum Service Frequency (MHz)	<input type="text" value="150"/>			
Maximum Service Frequency (MHz)	<input type="text" value="5000"/>			
Regulatory Territory	<input type="text" value="US/FCC"/>			
Slot	A	B	C	D
Module Type	Service			
Module State	<input type="text" value="Enabled"/>			
Calculated Input Level (dBm)	<input type="text" value="-1"/>			
Relative Input AGC Threshold (dB)	<input type="text" value="+3"/>			
Calculated Relative Power Level (dB)	<input type="text" value="0"/>			
Uplink/Downlink balance (dB)	<input type="text" value="0"/>			
Module Label	<input type="text" value="SM-A"/>			OPTICAL LINK
	<input checked="" type="checkbox"/>	<input type="checkbox"/>	<input type="checkbox"/>	<input type="checkbox"/>
				SH1 ➔

Choose from the **Minimum Service Frequency** and **Maximum Service Frequency** options that encompass all of the services that are to be passed by the DAS. Any unused portions of the RU circuitry will be configured to a low power mode such that unwanted harmonics or intermodulation products will not be passed through those parts of the DAS. Setting the narrowest operating band will permit the most power within that band to meet regulatory requirements. See the following section in this chapter entitled “Uniwave Remote Unit Architecture” for more details.

If the **Minimum Service Frequency** is set to 600 MHz or higher, an uplink switchable filter is activated in each Remote Unit. This is a high-pass filter with a corner frequency at 600 MHz. Enable this filter if the system is vulnerable to overload by high-power mobile radios, and where the wanted services carried by the DAS are at 600 MHz or above.

The Regulatory Territory setting may be selected from US/FCC or EU/CE, meaning American or European operating standards. This information is used in the internal calculations of the system when determining the operating point of the RF signals. This assists the set-up, but the system still relies on proper configuration by a professional installer to achieve regulatory compliance.

10.3.4 Service Module Downlink AGC

An AGC function is implemented for the Downlink of each Service Module, to protect the DAS system from overload due to excessive input signal levels. This is configured by adjusting the ‘Relative Input AGC Threshold’ settings within the Primary Hub Configuration section of the System Setup screen.

The value specified for each Service Module is relative to the Calculated (maximum) Input Level specified for that Service Module. If a maximum Input Level of 0 dBm is configured, and the Relative Input AGC Threshold is set to +3 dB, then the Primary Hub will limit the downlink signal level internal to the Service Module to +3 dBm by dynamically dialing in additional attenuation in the Service Module as required. Such signal limiting will occur until the available attenuation in the Service Module is exhausted, or the input signal applied to the Service Module achieves the maximum permitted level of 15dBm, at which point the service input will be disabled and a loss of service alarm will be raised. Note that the Service Module AGC function incorporates limited hysteresis to avoid excessive AGC cycling.

10.3.5 Transport Module AGC

Similar to a Service Module, an AGC function is implemented for the Downlink of each Transport Module, to protect the DAS system from overload due to excessive input signal levels. This is done by adjusting the ‘Relative Input AGC Threshold’ setting within the Primary Hub Configuration section of the System Setup screen.

The value specified for each Transport Module is relative to the Calculated (maximum) Input Level specified for that Service Module. If a maximum Input Level of -25 dBm is configured, and the Relative Input AGC Threshold is set to +5 dB, then the Primary Hub will limit the downlink signal level internal to the Transport Module to -20 dBm by dynamically dialing in additional attenuation in the Transport Module as required.

For a UniTransport Hub, there is an UL AGC Threshold (dBm) for each Transport Module connected to a Downstream Primary Hub. The System Setup screen shows a table entitled Downstream PH Configuration, where the UL AGC Threshold is configured. Similar to the settings for a Remote Unit, the level is in absolute power (dBm). Typically this is set to -20dBm.

Signal limiting will occur until the available attenuation in the Transport Module is exhausted (31dB range).

10.3.6 Rack-Mount Power Supply Unit Configuration

Zinwave's Rack Mount PSU (RM-PSU) is used to power Remote Units directly-connected to the primary Hub, that don't have an accessible Secondary Hub power port. This section allows the user to configure a Zinwave RM-PSU that has been connected to a USB port on the Primary Hub. Clicking on the green icons for each power port and then clicking Apply will configure the power state of the power ports.

10.3.7 Secondary Hub Configuration and Controls

The Secondary Hub Configuration section allows the user to label Secondary Hubs. It is necessary to click "Validate Settings" and "Apply Settings" to save the changed configuration (Clicking "Apply Settings" results in the System Status page opening).

The Secondary Hub Controls section allows the user to individually enable/disable Secondary Hub optical and power ports by clicking the relevant green (enabled) or red (disabled) icon. Clicking the "Apply" button at the bottom right of the section saves these settings (resulting in the System Status page opening).

Note that after a system restart, all SH optical and power ports will always be re-enabled.

10.3.8 Remote Unit Configuration

This section allows the user to set the configuration of each Remote Unit in the system. Primarily, the **DL Power** for each Remote Unit tells the system how much composite transmit power is required from the Remote Unit. Composite Power refers to the power sum of a group of services combined together. The weighting of each individual service depends on how the services are combined prior to entering each Service Module, then the Calculated Relative Power Level (dB) setting on each Service Module, and which of the Matrix paths has been enabled. The system uses these input parameters to configure the gains of each path in the downlink. See next section to learn about how Composite Power works in the 308-0007-x Remote Unit.

Under normal circumstances, the Remote Unit and all of the other components in the system operate with a constant, linear gain. If an input signal is high enough to cause overload or unacceptable distortion, an Automatic Gain Control (AGC) system acts to reduce gain to avoid creating unwanted emissions. For each remote Unit, the **Downlink AGC** is calculated from the **DL Power** setting plus an **AGC threshold**, which can be configured at +1, +2 or No AGC (which is actually +5 dB). In countries where FCC regulations apply, the **DL Power** can be set slightly higher than that permitted for CE regulations.

The DAS automatically configures the Uplink gain for each RU to match its Downlink gain, plus any **Uplink/Downlink Balance** selected at the Service Modules and Transport Modules.

Each Remote Unit needs to protect the system from very high uplink signal levels, to avoid blocking out weaker uplink signals on the other paths. The **Uplink AGC Threshold** is specified for each remote unit as the expected maximum received power at this Remote Unit location. Commonly the threshold is set to mitigate against interference from walkie-talkie and WLAN devices, while permitting harmless background signals to co-exist.

The uplink power detector in each Remote Unit reduces the RU gain as soon as the detected power level reaches the AGC threshold. There is no particular period that must expire before AGC is cleared, rather, it is cleared as soon as the constantly-monitored power level drops below the threshold (minus a 0.5dB hysteresis margin).

The Uplink AGC operating region continues through higher uplink signal levels, until the AGC/overload

attenuator in the Remote Unit has run out of range. This is typically 5 to 20 dB of active AGC range. At that point the uplink will be switched off to protect the system.

The Uplink AGC threshold for each RU does not directly affect the uplink gain, though in some cases where the target Uplink gains and RU AGC levels are high, the system may warn that the uplink gain needs to be limited when a new configuration is Validated/Applied, to avoid over-driving the Service Module outputs.

The user can Enable or Disable the power amplifier and the LNA in the Remote Unit (**Radio State**).

All Remote Units can be conveniently enabled/disabled and set to the same default settings by selecting from the relevant drop-down at the top of the list of RUs, and clicking the adjacent “Set” button.

10.3.8.1 Uniwave Remote Unit Architecture (308-0007-x)

The 308-0007-1 and 308-0007-2 Remote Units have a number of parallel Power Amplifiers (PAs) in order to cover the wide operating band with high performance. It may be helpful for the user to understand the architecture in order to get the most from each PA. The 308-0007-1 can be identified from a 12-digit serial number starting 81xxxxnnnnnn, whereas the 308-0007-2 has a serial number starting 90xxxxnnnnnn. Both types have separate PA bands that cover 150-1575MHz (Path A), 1575-2700MHz (Path B) and 3300-5000MHz (Path C). There is also near-term development effort to add 5000-6000MHz (Path D).

The maximum transmit power (in FCC territories) from Path A is 17 dBm, and 24 dBm for the other bands. The precise mix of service frequencies determines how much work is done by each PA, but theoretically each PA could be fully loaded.

Historically, Zinwave Remote Units have an RF architecture that delivers a wide, flat frequency response. Although this is conceptually simpler to understand and use, it does not take into account the differing power levels required by different types of carrier signal. There is also a requirement to not transmit anything in the 2700-3300MHz range due to the need to protect certain radar systems.

The 308-0007-x has a stepped frequency response, dynamically configured by the system. The gain of each PA path is tailored to the services it is carrying. It is used to deliver a higher power to the higher-frequency services that suffer poorer coverage due to the shorter wavelength. Lower-frequency services are not so resource-hungry, and in fact it is better for the DAS to transmit at a lower power level in order to minimize any impact of wideband noise on neighboring non-DAS systems.

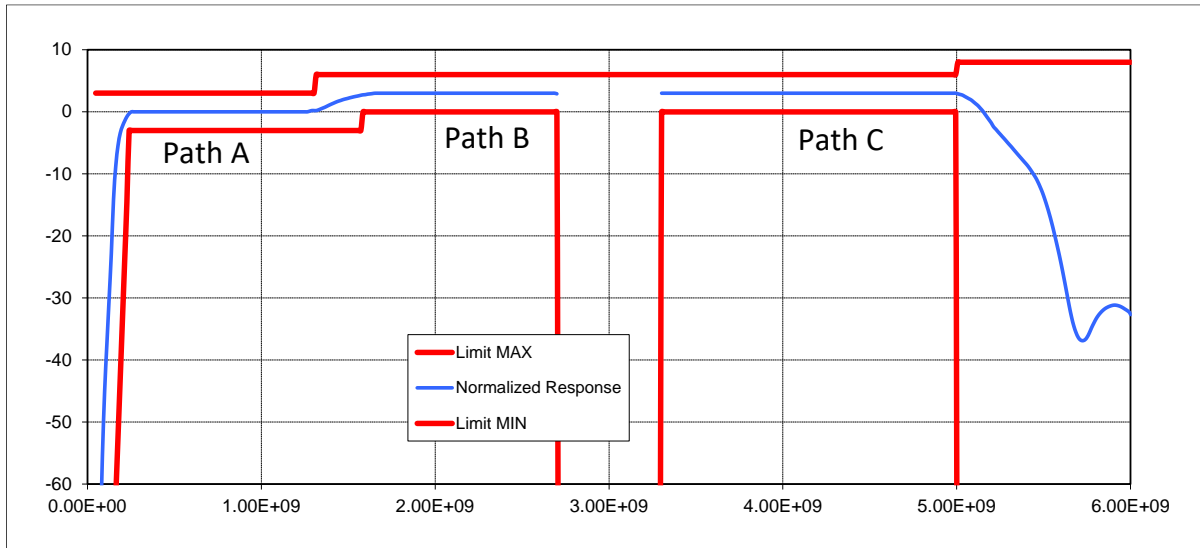

The settings applied from the System Setup screen are literally applied for any services above 1575 MHz. Any services that lie below 1575 MHz will experience approximately 3 dB lower Downlink and Uplink gain. The **DL Power** setting refers to the required Composite Power from any one of the PA bands, therefore the total measured Tx power when in operation may exceed the value configured as the DL Power.

10.4 System Status

The System Status page displays the topology of the Distributed Antenna System and the status/details of all the individual elements comprising the DAS. Configuration changes must be made via the System Setup page.

10.4.1 System Status Topology Tree and Modules

The following color coding is used for Units in the Topology Tree and any associated Modules:

- **Green Icon** – Functional
- **Amber Icon** – Hardware or Service Warning
- **Red Icon** – Loss of Service / Fault
- **Black Icon** – Disconnected link (to RU or optical module)
- **Grey Icon & Black Numeric** – Module disabled by User
- **Grey Icon & Grey Numeric** – Empty slot or Module not present
- **Blue Icon** – Indicates an Optical Loop Back (OLB) present

The Icons alongside each Unit in the Topology Tree show the status of its Optical Links:

- **Green Icon** – Optical loss within usable range
- **Amber Icon** – Optical loss at upper end of usable range – clean connections
- **Red Icon** – Optical loss out of specification – link must be improved
- **Blue Icon** – Optical loss not yet measured

10.4.2 Unit and Module Details

When the System Status tree is expanded, it is possible to click on each item in the tree to see its current properties, such as measured power levels and alarm status. All discovered Units and the Modules in the Primary Hub are displayed:

- **Primary Hub (PH):** Head-end of DAS, interfacing Services to SHs and/or RUs
 - **Service Module (SM)** - Provides interface for RF services from BTS, etc. The table also shows input Transport Modules (TMs)
 - **Optical Module (OM)** - Provides optical links to a Secondary Hub or Remote Unit. The table also shows any output Transport Modules (TMs).
- **Secondary Hub (SH):** Fans out optical links from the PH to up to 8 Remote Units per SH.
- **Remote Unit (RU):** Provides RF connections to antennas for Tx/Rx to RF devices.
- **Downstream Primary Hub (PH0x):** The tree shows other Primary Hubs that are connected to receive Services from this Primary Hub (a.k.a. UniTransport Hub).

10.5 Event Log

The event log page provides a history of the last 500 events recorded by the Hub.

In this page, the user can “Download Event Log” as an event/log text file and “Download System Log” as a rawlog.zip compressed text file. This zipped file contains at least 15 minutes of system logging data immediately prior to the “Download System Log” button being clicked. System Logs may be sent to Zinwave to facilitate diagnosis of system issues. System Logging is disabled by default and should be enabled only where a problem is suspected.

Ensure that the System Log is downloaded within 15 minutes of the occurrence of the issue that is to be investigated by Zinwave.

Event Log filtering can be enabled to avoid some repetitive warnings/alarms filling up the Event Log. For example, by customizing the Service Warning Alarm Relay to ‘ignore’ Uplink AGC service warnings on the RUs, and then enabling Event Log filtering, it is possible to eliminate unwanted AGC warnings from the Event Log.

10.6 Hub Setup

On this GUI screen, the user can Restart the Primary Hub, set the IP network settings, configure the SNMP Traps, choose between a secure (https) or insecure (http:) connection, set the Date & Time and configure the User Security Settings.

10.6.1 Restart Hub

Click the 'Restart Hub' button to reboot the Primary Hub.

10.6.2 IP Settings

IP Address

The address of the Hub on the network. Ensure that it does not clash with an existing device on the network.

Subnet Mask

This defines how IP addresses are partitioned on your network.

Gateway Address

The address of a router on your network that provides access to other networks and/or the internet. If you do not have such a device set this field to 0.0.0.0.

10.6.3 SNMP Settings

Trap IP Address

The network address to which traps are to be sent. This would usually be the network management computer. Setting this field to 0.0.0.0 disables traps.

Trap Port

The UDP port number to which traps are sent. For most systems this will be 162.

Trap Type

SNMP traps can be configured to use either the "Trap" or "Inform" transport mechanism. "Trap" is more widely supported, but "Inform" provides additional reliability.

RO Community

SNMP Read-Only Community string is the password that must be used by an SNMP Manager to gain SNMP GET Request access to the Hub. This should be changed from the default value of "public" if SNMP access is to be secured.

RW Community

SNMP Read-Write Community string is the password that must be used by an SNMP Manager to gain SNMP SET Request access to the Hub. This should be changed from the default value of "private" if SNMP access is to be secured.

10.6.4 User Interface Settings

Connection Encryption (SSL)

Connection encryption for the browser can be set to enabled (https) or disabled (http).

This determines whether browser connections must use an encrypted (https) or unencrypted (http) connection.

Note: On changing this setting, the user will be required to log back into the GUI.

10.6.5 Date & Time

The date and time used by the Hub can be configured.

NTP Client

This enables or disables the Network Time Protocol (NTP) feature. When enabled, the Hub will fetch the current time from a time server on the local network or the internet.

If NTP is enabled, the Time and Date settings will be disabled.

NTP Server

This is the IP address of the NTP server used to synchronize the time.

Time Zone

Select your Time Zone from the pre-defined drop-down list. Ignore the "Custom TZ String" field if your Time Zone is available. If your Time Zone is not available please contact Zinwave, who will provide a custom TZ string.

Note: Any change to the Date & Time configuration will result in the Hub restarting.

European daylight saving starts on the last Sunday of March and ends the last Sunday of October. US daylight saving starts on the second Sunday of March and ends the first Sunday of November.

10.6.6 Security Settings

Current User

The user currently logged into the GUI.

Inactivity Timeout

This option allows the user to set a period of allowed inactivity before the user is logged out from the Hub. There is a warning message displayed one minute before the timeout during which the user can select to stay logged in or confirm logout. One of four time periods can be set - 15, 30, 45 or 60 minutes. Alternatively, the user can select 'Keep me logged in' but this option is only recommended where security is not a concern.

Password

You can change the password for the users your account is authorized to change by selecting the user whose password is to be changed using the "Select user password to change" drop-down. Then, type the new password in the two password fields and click the "Update" button.

If the current user has no rights to set a password, then no password entry fields will be displayed.

10.7 Alarms Setup

On this GUI screen, the user can define how alarm LEDs and relays are handled. Alarms can be one of three types: Loss of Service, Service Warning and Hardware Warning.

Alarms can be customized and allow the user to select whether individual alarms from a specific category will activate the Fault or Warning relay or will be ignored.

Clicking Restore Default sets all values to the factory default values:

- Service Warning LED - Amber
- Hardware Warning LED - Amber
- Relay for Loss of Service - Fault
- Relay for Service Warning - Warning
- Relay for Hardware Warning – Warning

10.8 System Maintenance

Note: Any actions executed from this page will result in the DAS service being temporarily interrupted.

In this section, the user can set the start time for the system maintenance window. Only one action will occur at a time in the order (when more than one is scheduled): Software Installation, RF Calibration then System Check. The user can also check the status of any scheduled actions.

Note: For a software upgrade where the installation is scheduled by System Maintenance, all software file transfers must have completed before the System Maintenance Start Time (and Day, if specified). Otherwise, installation will be delayed until the next System Maintenance window for software installation.

RF Calibration performs an end-to-end (Service Module input/output to the Remote Unit DL/UL ports) system calibration. The user can enable a recurring calibration on a specified schedule. The user can

also perform a one-time RF Calibration.

Note: RF Calibration values are stored in non-volatile configuration memory. The user is able to clear all existing RF Calibration values, if desired, by clicking the 'Clear RF Calibration' button at the bottom of the screen.

System Check performs a system-wide scan to measure the RF isolation between TX and RX antennas on the same Remote Unit, as well as between the neighboring Remote Units. It also checks the RU PA gains and establishes 48V power port mappings between RUs and Secondary Hubs and any RM-PSU present.

The antenna check is performed by transmitting a test signal from the Primary Hub through each Remote Unit. The 308-xxxx system selects test tones at 2400, 2440 and 2483 MHz. Commercial services are disconnected during this phase. As with the RF Calibration, System Check can be scheduled to reoccur in user-specified maintenance windows or be performed on a one-off basis. The Full System check (includes antenna cross coupling between multiple Remote Units) of a 64 Remote Unit system (i.e. maximum number of Remote Units on a Primary Hub) should take approximately 15-20 minutes. It is recommended that the Full System check is done during the original system commissioning. Select Omit antenna cross-coupling if a more limited antenna scan with reduced run-time is required.

Note: the TX-RX antenna isolation for an RU will be reported with '>=' (greater than or equals symbol) pre-pended if the value measured was impaired by background noise/interference at the time of the measurement. This occurs when the measurement with an active test tone is not at least 1dB above the maximum background noise level recorded when the test tones were off. All we can be certain of is that the TX-RX antenna isolation will not be lower than the value shown. It is also possible that the TX antenna may be disconnected in this scenario.

When the symbol '-' is displayed in place of a TX-RX isolation number in the report, this represents an unmeasurable TX-RX antenna isolation. The measured RX signal level was not sufficiently above the RU RX noise floor. This could be due to either antenna being disconnected, or a very high TX-RX antenna isolation condition, due to wide antenna separation or low antenna gain at the frequencies used for the test.

It is important that the System Check is run when the building is as quiet as possible (e.g. 2am), to minimize measurement errors due to background RF noise. The wide-band RU RX power measurement cannot distinguish between wanted power for test (from RU Tx signal), and other uplink background noise power received. Inconsistent antenna isolation or cross-coupling measurements may occasionally be logged due to some background interference being present in that location at the time of the test. Logging and comparing isolation measurements obtained over a number of System Check runs should help highlight where to focus on-site attention.

10.9 System Views

The System Views section provides collated Status/Configuration Information related to the DAS.

10.9.1 System Snapshot

This section provides the view of the entire system configuration and status information for the DAS in a tabular form. The user can save the view as an HTML file that can be displayed by any supported browser.

10.9.2 Alarm Counts

This View lists all units/modules for which the count of any alarms is non-zero (the Alarm Count is a cumulative number for all the instances of an alarm since the last system restart).

10.9.3 Link Quality

This is a single page View of the fiber optic link quality for the DAS. Uplink and Downlink paths are shown for all optical links in the system. Measured optical losses are displayed. If the RF Calibration function on the System Maintenance page has been executed, then applied RF calibration values are also displayed.

10.9.4 RU DC Power

This is a single page View showing the DC power parameters for all Remote Units in the DAS. The table reports the input voltage, input current and power dissipation measured by each RU. The power dissipation of each DC supply cable is also calculated if the SH or RM-PSU voltage is available for that particular RU. PSU Port Association is displayed, an output from performing the RF System Check. It maps the power ports on the Secondary Hubs with the Remote Units they are connected to.

10.9.5 RU Calculations

This single page View displays the applied RF settings and calculated gain for all the Remote Units in the DAS, from each Service Module input that has been enabled. It is updated by clicking Validate Settings and Apply Settings on the System Setup page.

10.9.6 RF System Check

This view displays a number of RF parameters for each Remote Unit in the system :- the health of the Power Amplifier in the Remote Units (PA Health); background noise level (Background Level); isolation between Tx and Rx antennas for each Remote Unit (Tx/Rx Antenna Isolation); and cross-coupling (Cross-Coupling Tx/Rx) between the transmitting Remote Unit and receiving ports of the other Remote Units in the system. Note that strong background RF signals can potentially cause false readings with the cross-coupling test.

PA Health is highlighted **amber** when there is 8dB or greater difference between the Tx output power and the expected level from measuring the input power and **red** if there is no measurable output power. A fault may actually be due to mismatch at the Tx port of the RU, rather than the PA.

If the background RF pickup is $> -30\text{dBm}$ when the DAS is off it shows **amber**; if it is $> -20\text{dBm}$ it shows **red**. The test for each RU includes an “off” measurement and 3 test frequencies, so for a test on each transmitting RU there are many “off” measurements measured on all of the Rus. This is presented as a range of values, giving an indication that the background pickup might be “bursty”.

If Tx-Rx isolation is in the range -45 to -40dB , it shows **amber**; if it is more coupling than that it shows **red**; if the background RF pickup was strong enough to compromise the measurement, it also shows as **amber** and the result has “ \geq ” added to the result text. It means that the Tx-Rx isolation measurement had a smaller received level than the Rx level when the DAS was off.

If cross-coupling is in the range -50 to -45dB it is shown as **amber**; stronger than -45dB is it **red**. Strong coupling from one RU's Tx to another RU's Rx is not to be expected.

RF System Check									
Last System Check Date/Time				2020-08-14 13:09					
RU	Label	PA Health	Antenna Measurements						
			Background Level (dBm)	Tx/Rx Antenna Isolation (dB)	Cross-Coupling Tx/Rx (dB)	Cross-Coupling Tx/Rx (dB)	Cross-Coupling Tx/Rx (dB)	Cross-Coupling Tx/Rx (dB)	
RU11	Eleven	Good	-51.9	55.2					
RU13	Thirteen	Good	-52.8	58.9					
RU15	Fifteen	Good	-52.3	65.7					
RU03	Zero-Three	Good	-51.8 .. -51.7	57.6					
RU42	Forty-Two	Good	-51.9	56.1					
RU44	Forty-Four	Good	-54.1	62.1					
RU46	Forty-Six	Good	-55.9	>=64					
RU65	Sixty-Five	Good	-53.4	53.8					
RU67	Sixty-Seven	Good	-53.2 .. -53.1	53.7					
RU07	Zero-Seven	Good	-52.6	54.5					
RU86	Eighty-Six	Good	-53	>=59.5					
RU88	Eighty-Eight	Good	-52.1	61.3					

Interpreting the Antenna Measurement Results

The RF System Check is performed by transmitting a test signal from the hub through each RU in turn. It is initiated from the System Maintenance page. The antennas connected to the Tx and Rx ports of each RU are tested as well as the DAS hardware. External services are disconnected during the test. The uplink power meter in all of the RUs report how much signal is picked up from each transmitting RU. The system selects three different test tones, as well as one test with no transmission, to check for background signals. The 305-series hub generates test tones at 2400, 2440 and 2483 MHz, and the 306-series hub generates 3450, 3550 and 3650 MHz. If the system is fitted with lower-frequency antennas, the results may show lower coupling than expected.

PA Health : RF Power measurements are taken from the input and the output of the Power Amplifier (PA) in each Remote Unit (RU), and the gain of the amplifier is checked.

Background Level : The uplink power observed by an RU with no services and no test signals present. A large power reading could interfere with the uplink of the DAS, and might indicate a co-located WIFI access point or similar device near an RU antenna.

Tx/Rx Antenna Isolation : The installation guide recommends at least 40dB isolation at 800MHz, and 50dB isolation is expected at 2400 MHz. Strong coupling is due to insufficient separation between Tx and Rx antennas. If the coupling is extremely small ("=" means around 70dB isolation), this may indicate that one or more antennas are disconnected or faulty. Note that strong background RF signals can cause false readings with this test.

Cross-Coupling Tx/Rx : Strong coupling from Tx of the transmitting RU (as identified in the RU column) to the Rx of other RUs is shown as cross-coupling. Normally, RUs are sited well-apart, so less coupling is expected compared with the Tx-to-Rx of a given RU. Cross-coupling could indicate poorly-sited antennas. Note that strong background RF signals can cause false readings with this test.

Sample RF System Check View showing two RUs amber highlighted “Tx/Rx Antenna Isolation (dB)” values due to the “>=” prefix.

11 Additional System Setup

11.1 System Uplink/Downlink Balance

The uplink / downlink balance allows for variation in transmit and receive path gains depending upon system requirements. A mobile device will estimate the level at which it should register with the base-station, based on its received downlink strength, and adjusting the balance in the DAS affects the reliability of devices registering on the system.

With the uplink / downlink balance at its default value of 0, the uplink and downlink gains are equal. A setting of +5 will request an uplink gain of 5dB higher than the downlink gain. Similarly, a setting of -5dB will set the uplink gain at 5dB lower than the downlink gain.

Note: The maximum gain of the system is 25 dB. If levels configured in the system require greater gain, then System Setup will limit the values to an achievable gain.

The actual gain is determined by a combination of input, output and balance parameters. The gain is primarily defined from the Downlink parameters. The downlink gain, before service balancing, is determined by the Calculated Input Level and the Remote Unit Downlink power. For example, to achieve a downlink gain of 25dB with an output level set at +18dBm the minimum input level that can be set is -7dB when a single service module is enabled. When the Uplink / Downlink balance is set to 0dB, the system will try to set the uplink gain to the same value as the downlink gain.

However, the Uplink gain is also constrained by the Uplink AGC Threshold configured on the Remote Unit, and the maximum output level of the Service Module in the uplink direction. The maximum output level of the Service module is +5 dBm. If the user attempts to apply settings that may result in the output level of the service module being exceeded, then the system will automatically limit the DAS uplink gain to avoid this. The user may need to lower the uplink AGC thresholds to reduce the maximum uplink level from RUs.

11.2 Calculated Input Level

The Calculated input level is the measured composite power level delivered to the Service Module from the Signal source (BTS, POI etc.). The total composite input power level should not exceed +15dBm.

Care must be taken to ensure that the setting reflects the total power possible at the SM. It is important to know not only what is currently connected and being measured, but also what will be present when fully loaded services are present.

Particular care should be taken when using CDMA signals where the initial power measured is often that of the Pilot and not the maximum transmit power. Similarly, with cellular services, initial measurements often do not show all traffic channels which will only be operational under loaded conditions.

11.3 Changing or Swapping Equipment

If equipment is removed from an existing system, the system will recalibrate links and apply stored configuration settings. This will be shown in System Setup with a message like, "The following remote

units are missing. Apply a new system setup to acknowledge them". This is because the system has changed from the baseline configuration set up after the Apply button was pressed.

Do not make any equipment changes while the system is validating its set up as this will invalidate any System Setup process and the setup will fail. A message will be displayed indicating the failure and request that you run System Setup again.

11.3.1 Hub

If a Remote Unit or Secondary Hub is disconnected from the system by removing either its power supply or optical link, and then it is subsequently reconnected, it will restore the same configuration. If a different unit is installed in its place, the new unit will have factory default configuration (unless restored from a previous configuration elsewhere) and must be changed through the Hub Setup page and by re-running the System Setup process to set the correct matrix configuration.

11.3.2 Remote Unit

If a Remote Unit is disconnected from the system, when the same unit is reconnected to the same optical module, the system recalibrates the links and applies the stored settings. If a different unit is reconnected, the system sets the unit to its default condition. Edit the System Setup to input its desired values.

11.3.3 Optical Module

If a link is broken either due to fault or intervention the system automatically recalibrates the link and applies the appropriate gains when the system is restored even if a different unit is swapped into the system.

11.4 Factory Reset of a Primary Hub

It may be necessary to set the Hub back to factory default values when redeploying or reconfiguring equipment.

The reset button can be found behind the small hole located to the left of the Alarm Serial interface. If an installation was interrupted or if there has been a catastrophic issue with a Hub that cannot be recovered, you can return the Hub to factory settings. This requires a physical reset to the system.

To reset a Hub to factory settings:

1. Using a small device (such as an open paper clip), push the Reset button located on the front of the Hub and hold in for 10 seconds.



2. You need to insert the tip of the device into the hole as the button is set in from the front face. The Hub restarts and the LEDs flash. The Hub is returned to the default IP address and configuration settings:
 - IP Address: default 192.168.0.2
 - Sub Net: Default 255.255.255.0
 - Gateway: Default 192.168.0.1
 - Passwords: Advanced: supervisor
 - NTP Settings: default disabled
 - Alarm Settings: default condition Fault

Configure as desired as described throughout this manual.

12 UniTransport System Setup

12.1 UniTransport Functionality

The UniTransport concept permits any primary hub to accept service connections over fiber, in place of coax. Remotely situated base-stations can be connected to a co-located Primary Hub (a.k.a. UniTransport hub) which is populated with Service Modules in the rear slots and Transport Modules in the front slots. Identical Transport Modules are configured in the Service slots of each downstream Primary Hub to receive those services.

One UniTransport Hub may be connected to multiple downstream Primary Hubs, and any Primary Hub may be served by multiple UniTransport Hubs. However, no further cascading is supported – i.e. no hub may have Transport Modules fitted to both front and rear slots simultaneously.

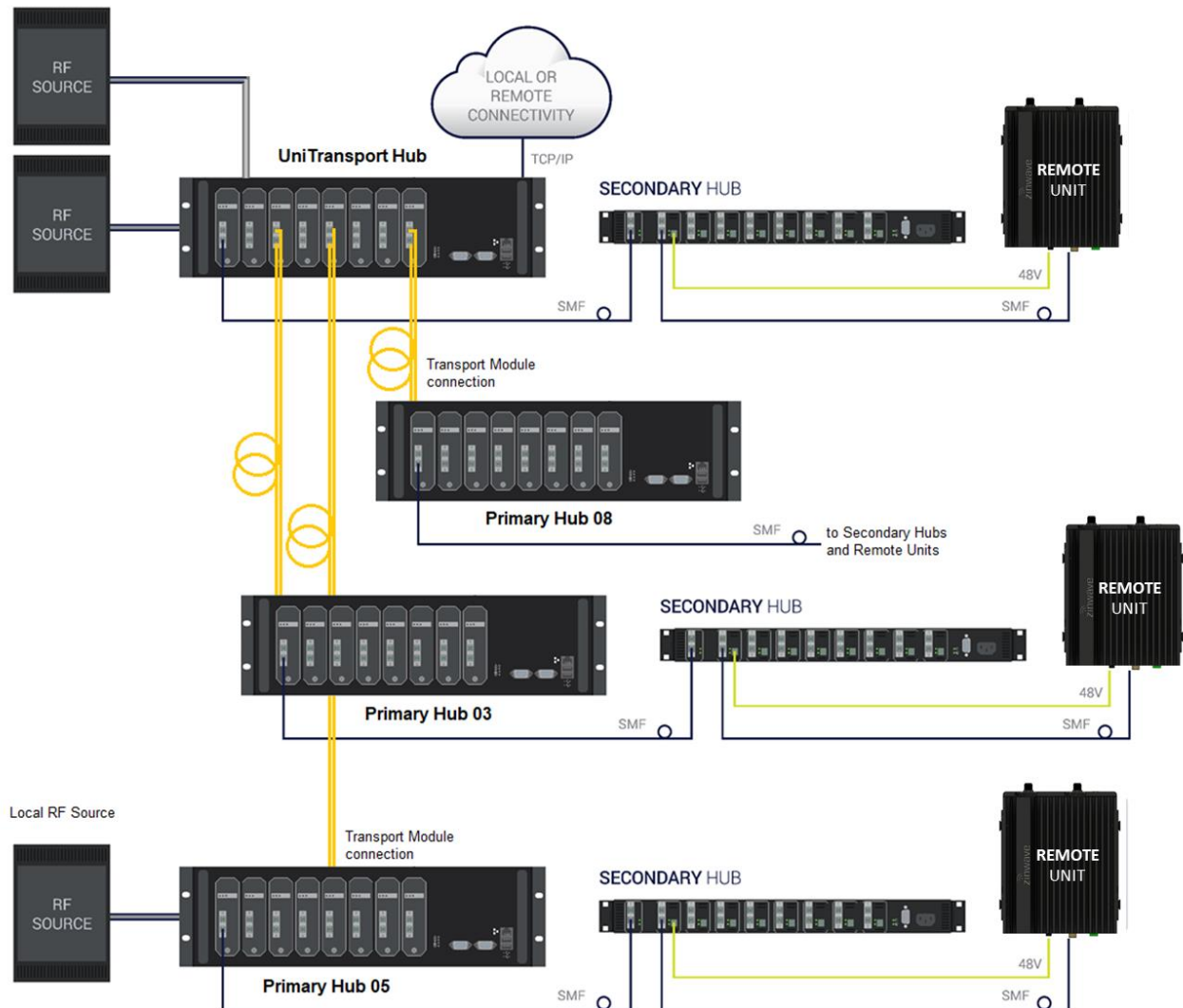

The Transport Module is visually similar to an Optical Module, but with internal hardware differences to permit it to also perform the job of a Service Module. It is not interchangeable with an Optical Module. A pair of Transport Modules is required to create a UniTransport link.

From a software perspective, any permutation of Service Module and Transport Module may be fitted to the input slots of a Primary Hub, and any permutation of Optical Module and Transport Module may be fitted to the output slots of a UniTransport Hub.

From an RF perspective, note that the uplink performance as seen by any one Base-Station is inversely proportional to the number of Remote Units that it is connected to – a UniTransport system needs to be designed and planned just like any other DAS.



12.2 Configuration of UniTransport Hub

As with all Primary Hubs, up to 4 Services are connected through Service Modules in the rear slots and their levels are adjusted according to the required relative levels and the expected absolute levels. The UniTransport Hub is capable of grouping the input services through a switch matrix and routing some or all to the outgoing Transport Modules in the front Optical slots. These controls on the System Setup page are configured as normal.

The right-hand side of the System Setup view shows a list of connected downstream Primary Hubs, as well as the usual list of Remote Units, if any are connected.

The key difference between a directly-connected Remote Unit and one connected via a downstream Primary Hub is that the gain budget is now split into two parts. There might be a need for 20dB gain between a service input and each Remote Unit output, and to reach the overall link target, both the UniTransport Hub and the downstream Primary Hub need gain settings that add up to 20dB. To make it as simple as possible, the hub software calculates all the settings from your input of the power level that is to be sent over the fiber.

Zinwave recommends that the DL IP power presented to the Downstream PH is set to **-25dBm**. Also set the UL AGC Threshold to a little higher than this, **-20dBm** is recommended.

The settings are calculated when you click **Validate Settings**, and applied to the hardware when you then click the **Apply Settings** button. Expect the calculated uplink gain to be higher than the downlink gain, even when Uplink/Downlink balance is set to 0dB – this is correct, the overall system gain is balanced, but the gain split between the upstream and downstream hubs is deliberately not the same in UL and DL directions.

12.3 Configuration of Downstream Primary Hub

Any Primary Hubs connected to a UniTransport Hub are described as downstream of the UniTransport Hub. They will have Transport Modules fitted to their Service input slots. These Transport Modules need to have the same RF input power level assigned to them as the output Transport Modules that feed them in the UniTransport hub. Zinwave recommends that you set the Calculated Input Level to **-25dBm**.

Primary Hub Configuration					
Hub Label	Primary Hub 146				
Slot	A	B	C	D	
Module Type	Service	Transport Setup	Transport Setup		
Module State	Enabled	Enabled	Enabled		
Calculated Input Level (dBm)	-6	-25	-25		
Relative Input AGC Threshold (dB)	+2	+5	+5		
Calculated Relative Power Level (dB)	0	0	0		
Uplink/Downlink balance (dB)	0	0	0		
Module Label	Service A	Transport B	Transport C		OPTICAL LINK
	<input checked="" type="checkbox"/>	<input checked="" type="checkbox"/>	<input checked="" type="checkbox"/>	<input type="checkbox"/>	SH1
	<input checked="" type="checkbox"/>	<input checked="" type="checkbox"/>	<input type="checkbox"/>	<input type="checkbox"/>	
	<input checked="" type="checkbox"/>	<input checked="" type="checkbox"/>	<input type="checkbox"/>	<input type="checkbox"/>	
	<input checked="" type="checkbox"/>	<input checked="" type="checkbox"/>	<input type="checkbox"/>	<input type="checkbox"/>	

12.4 Remote Configuration of UniTransport Hub

The physical separation of the UniTransport hub could be several kilometres from the Primary Hubs it serves. To assist with configuring the services arriving at a downstream Primary Hub, there is a **Setup** button associated with each input Transport Module on the System Setup page of the GUI. Internal communication between the downstream Primary Hub and the UniTransport hub works to fetch the UniTransport's Service settings and pass modifications to those settings back upstream. In this way, a downstream Primary Hub can be completely configured without access to the UniTransport Hub.

Clicking the **Setup** button for a given Transport Module will open a new tab or window in the browser to show the services routed to that Transport Module. Clicking **Apply Settings** will send any changes back to the UniTransport Hub.

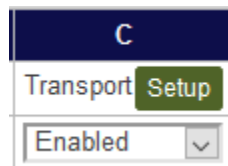

Apply Settings

UniTransport Hub Setup

UniTransport Hub connected to Slot C - 'Transport C'

Hub Label	UniTransport Hub					
Slot	A	B	C	D	Transport Module	
Module Type	Service	Service	Service			
Module State	Enabled <small>▼</small>	Enabled <small>▼</small>	Enabled <small>▼</small>			
Calculated Input Level (dBm)	-5 <small>▼</small>	-5 <small>▼</small>	-5 <small>▼</small>			
Relative Input AGC Threshold (dB)	+5 <small>▼</small>	+5 <small>▼</small>	+5 <small>▼</small>			
Calculated Relative Power Level (dB)	0 <small>▼</small>	0 <small>▼</small>	0 <small>▼</small>			
Uplink/Downlink balance (dB)	0 <small>▼</small>	0 <small>▼</small>	0 <small>▼</small>			
Module Label	Service A					
Matrix Switches	<input type="checkbox"/>	<input checked="" type="checkbox"/>	<input type="checkbox"/>	<input type="checkbox"/>	DL Power -25 <small>▼</small>	UL AGC -20 <small>▼</small>

The Services provided by the UniTransport hub may also be routed to its own Secondary Hubs and Remote Units as well as other hubs, so keep in mind that changing any power levels and switch settings will have a wider effect.

13 Understanding Alarms & Reporting

13.1 Alarms

The term Event is a generic term for any occurrence in the system that could cause an entry in the Event Log to be generated. Events are defined into four categories.

- Loss of Service
- Service warning
- Hardware Warning
- Informational

Some events also cause alarms and are sub-divided as described in the following sections. All these event types are recorded in the log files accessible in the Configuration GUI. See "[Event Log](#)".

13.1.1 Loss of Service

This occurs when the Primary Hub detects an event that will result in the complete loss of 1 or more services in at least 1 RU location, e.g. a link calibration failure, Overload "Safe Mode", RU communication timeout, thermal shutdown, etc.

A typical example of a Loss of Service alarm occurs when a Remote Unit is disconnected from the system.

The log file will show the following type of behavior.

```
2020-03-31 16:40:47: Raised loss of service alarm: Device is missing on Optical
Remote Unit S/N: 660102004510 RU System
2020-03-31 16:40:47: Deleted RU03 s/n 660102004510
```

Alarm	Description	Action
Calibration error	An error has occurred in the calibration of an optical link.	Either carry out a manual recalibration through the System Maintenance page or remove and replace the optical cable which will force a recalibration to occur. If the fault persists, check the equipment at both ends of the affected link.
RU services are restricted by a missing Service Module, or by matrix settings	The system cannot be configured as desired and some services will not be present due to incomplete Matrix settings.	Check that each Matrix has valid input and output paths set

Alarm	Description	Action
The uplink power has exceeded the safe limit, and the receiver has been turned off	The power in the uplink (primarily the Remote Unit) has exceeded the defined threshold. This will cause the LNA in the Remote Unit to switch off until the overload condition is removed. It can be caused by uncontrolled uplink power from mobiles or by poor installation causing reduction in Tx Rx isolation.	Remove the overload condition
The downlink power has exceeded the safe limit, and the receiver has been turned off	This relates primarily to the service Module and is raised when the downlink power from the connected BTS or POI exceeds the specified input level.	Check the measured input level and either modify input settings value or reduce BTS input level to the level required.
Device is missing	A unit that was present at the application of Validate / Apply Settings is no longer connected to the system.	Correct or accept through System Setup

13.1.2 Service Warning

This type of event is one that may be affecting the performance of at least 1 service in at least 1 RU location, e.g. a bad optical link, Overload “AGC Mode”, etc.

2020-03-31 16:55:44: Raised service warning alarm: Downlink Automatic Gain Control activated on PH Service Module B

Alarm	Description	Action
Configuration has not been confirmed by the user	The settings of the system need to be confirmed by clicking Validate / Apply Settings.	Run System Setup.
The requested composite power could not be achieved	The output power requested at System Setup cannot be achieved. This will be due to a poor optical link which requires too much compensation (gain).	Check Optical connections and link quality.

Alarm	Description	Action
Uplink Automatic Gain Control activated	This indicates that the Remote Unit has detected a signal that has reach the "UL AGC Threshold". It is currently working in a "limited" region before it switches off completely.	This indicates that the Remote Unit is sensing a higher than expected uplink RF level. This may be due to the temporary presence of a high power mobile without power control close to the antenna or a lack of isolation between transmit and receive antenna ports. If the condition is transitory, consider setting the "UL AGC Threshold" to a higher level. If the alarm is due to poor isolation between antennas, try to space the antennas correctly.
Downlink Automatic Gain Control activated	This indicates that the Service Module has detected a signal above its "Relative Input AGC Threshold". It is currently working in a "limited" region before it switches off completely.	This indicates that the Service Module is sensing a higher than expected downlink RF level from the connected RF source. This may be due to an incorrect setting for "Calculated Input Level " or an unexpected increase in BTS output. Check the measured input signal to the Service Module and against expected input signal loading and levels, paying special attention to level changes caused by pilot back off. If the level has increased due to unexpected increase in either channel numbers or service types, check with BTS providers and modify settings accordingly.
Uplink has poor RF performance	The uplink optical link has poor performance usually due to high optical loss.	Check and clean link.
Downlink has poor RF performance	The downlink optical link has poor performance usually due to high optical loss.	Check and clean link.
Uplink gain is limited by the maximum allowable output power of a Service Module	The uplink gain is limited by the maximum input signal level at the Remote Unit and the maximum output level of the Service module (+5dBm).	The system will automatically configure the desired Uplink/Downlink balance for each service path to every RU. It does this by adjusting the uplink gain according to the DL power set on each RU. If the resulting uplink power at the Service Module exceeds the limit, resolve it by lowering the Uplink/Downlink balance setting on the affected service

Alarm	Description	Action
<p>UL gain setting too high, decrease balance "Required uplink gain is too high."</p> <p>Input level too low - changing to appropriate level "The SM Calculated Input Level has been changed to prevent the downlink gain from being too high."</p>	<p>The uplink gain is potentially greater than the downlink gain. The system cannot achieve the required output with the input level set on the Set-Up page. The system has a maximum gain of 25 dB between service level input and Remote Unit output power settings.</p>	<p>The system will automatically set the uplink gain to be the same as the downlink gain with a UL/DL balance of 0, but will show this condition indicating that the UL /DL balance can be adjusted if required.</p> <p>If the value provided at System Setup requires greater than this the input value will be adjusted while maintaining the requested output power. The delivered input power should be adjusted (raised) to ensure that excessive gain is not required.</p>
<p>Different power levels on uplink matrix input</p>	<p>The system has detected that there are inconsistencies with the automatic setting of the internal system parameters due to inequalities in connected components.</p>	<p>This should not prevent satisfactory operation, but values for all elements connected to the affected Matrix should be checked (RU output etc power and all optical links should be checked to ensure that they are performing inside optical limits.)</p>

13.1.3 Hardware Warning

This type of event is one that may be affecting the performance or lifespan of a component, e.g. temperature, voltage or current limits, fan failure, etc.

2020-04-01 09:51:29: Raised hardware warning alarm: Fan fault (PH) on PH PSU

In each case of a hardware warning the unit identity is included in the message.

This condition can also be cleared if you disable the faulty component (where possible) through the System Setup window or Apply a new set of parameters that disable the potentially affected service(s) at the affected location(s). For Hardware warnings this condition is also self-cleared by the Hub if the component returns within limits.

13.1.3.1 Hardware Warning Alarms

Alarm	Description	Action
<p>The module temperature is above the limit</p> <p>The module temperature is below the limit</p>	<p>In each case the unit affected will be included in the log message Example "The module temperature is above the upper limit" on PH PSU.</p> <p>The cause will be the ambient temperature of the device in question.</p>	<p>Adjust the temperature or trace the specific problem through the equipment. See specific over and under temp alarms below.</p>
<p>Current1 over limit</p>		

Alarm	Description	Action
Current1 under limit	This indicates a problem with the power supply rails of the device in question. In the case of Optical Modules, Service Modules and Hub alarms it relates to the Hub Power supply. If the alarm is raised in conjunction with a Remote Unit, the fault will be with local unit or the centralized feed.	If the issue persists, contact Support and arrange for unit RMA in accordance with your maintenance and support agreement.
Current2 over limit		
Current2 under limit		
Voltage1 over limit		
Voltage1 under limit		
Voltage2 over limit		
Voltage2 under limit	These are Hub alarms indicating problems with the Hub power supply. Some are used directly by modules and others are intermediate step-down voltages.	
3.3 volt supply fault		
+ve 5 volt supply fault		
15 volt supply fault		
-ve 5 volt supply fault		
PSU 13v supply fault		
PSU 3.3v supply fault		
PSU 8v supply fault		
PSU -ve 12v supply fault		
PSU comms error		
PSU 13v supply current over limit	Power supply fault	
Power supply fault		
Fan fault	The fan speed is monitored as part of the internal control of the Hub. A fan fault will either indicate a power supply issue or functional problem with the fan.	Check for build-up of dirt and dust and replace as required.
The uplink power is below the lower limit	The received optical power is below the minimum threshold for satisfactory operation and will result in any connected modules being disconnected/ deleted. The problem can be either a power failure at the far end or a break in the optical fiber cable.	Check the optical connection and fibers for damage, cleanliness and poor connection. If necessary, clean both sides of the optical interface carefully or replace if damaged.
The uplink power is above the upper limit	The optical power level exceeds the maximum value in the case of an optical link or if reported in conjunction with a Remote Unit indicates that the overload value for the RU has been exceeded.	Remove the overload condition

Alarm	Description	Action
The downlink power is below the limit	The received optical power is below the minimum threshold for satisfactory operation and will result in any connected modules being disconnected/ deleted. The problem can be either a power failure at the far end or a break in the optical fiber cable.	Check the optical connection and fibers for damage, cleanliness and poor connection. If necessary, clean both sides of the optical interface carefully or replace if damaged.
The downlink power is above the limit	This relates primarily to the service Module and is raised when the downlink power from the connected BTS or Repeater exceeds the specified input level.	In the case of the service module this will be due to higher than expected RF signal levels from the connected RF sources. Measure input signal and check against the set value. Correct settings or report increase in BTS signal to operator.
System error	This indicates one of the following: 1) a low-level system error in the reporting unit. 2) The unit does not operate on the same frequency band as the hub.	Usually, the unit will reboot itself to clear the problem. System errors may occur as part of normal operation and can be masked if required.

13.1.4 Informational

This category covers information presented to the user in the log file which records events that have been carried out by the user such as application of a new system set up, changing time and date or passwords. These are for information only and will not raise an alarm.

2020-04-01 11:33:22: New System Setup being set by: advanced.

13.2 Alarms Setup

For each of these alarm types, it is possible to configure whether the Fault or Warning relay (or neither) is activated. For Service Warning and Hardware Warning alarms the Primary Hub Warning LED color (amber or green) can also be configured.

1. The Service and Warning LEDs will be automatically cleared when the alarm is cleared, as will the relevant Fault or Warning relay.
2. Alarm Customization. This feature enables the user to configure individual alarms from a particular category (as opposed to all alarms in that category) to activate the Fault or Warning relay or to be ignored and not activate either relay.

Choosing the Custom option from one of the drop-down lists in the Relay settings enables the Customize Settings button.

Clicking the Customize Settings button opens the Customize Alarms page. In this page it is possible to configure the Relay Setting for individual alarms in a particular category as Fault, Warning or Ignore.

Clicking the Update button saves the changes and returns to the Alarms Setup page.

Clicking the Cancel button cancels all changes and returns to the Alarms Setup page.

13.3 Alarm Connections

Uniwave can connect to external alarm sources or monitors via the 9-way D-type connector on the Primary and Secondary Hubs. The connector provides 4 relay outputs: normally open alarm; normally closed alarm; normally open warning; normally closed warning.

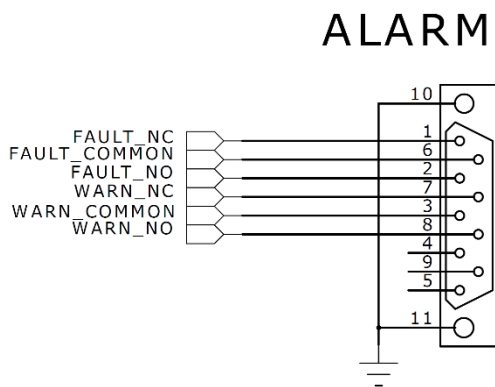

The relays are activated by an alarm or warning event. The relays are deactivated by clearing the alarm or warning condition.

The Uniwave Remote Unit supports a single alarm relay to indicate applicable alarms that have been assigned to activate the Fault relay. Fault relay normally open (NO), normally closed (NC), and common (COM) connections are provided on the Phoenix Contact 3-way Alarm connector on the bottom of the Remote Unit.

13.4 SNMP

An SNMP interface supports integration with higher order NMS applications such as Network Operation Center software, used to remotely monitor all of the hubs and POIs within the DAS. Security features such as separate user classes and secure communications via SSH & SSL are provided, along with support for secure SNMP v3. Local diagnostics are also available via LEDs indicating equipment status on the Hubs for rapid fault isolation.

There are three sections of interest within the MIB tree:

1. The hub3000 section supports an SNMP V2 MIB interface, which offers simple polling of the alarm relay state and current fault description. This section is compatible with earlier Zinwave 3000 DAS products. The definition for this interface is provided in the ZINWAVE-MIB file (supplied as zw5000-5.21_mib.txt)
2. The hub3000extended section requires an SNMP V3 connection, and is also compatible with Zinwave 3000 DAS products running V4.74.
3. The UNITIVITY5000-MIB section contains extensions added to the Zinwave 5000 DAS. Both the ZINWAVE-MIB file and the UNITIVITY5000-MIB file (e.g. UNITIVITY5000-5.21_mib.txt) must be loaded in order to use it.

SNMP Get and SNMP Traps are currently supported, the following tree view shows the structure of the interface:

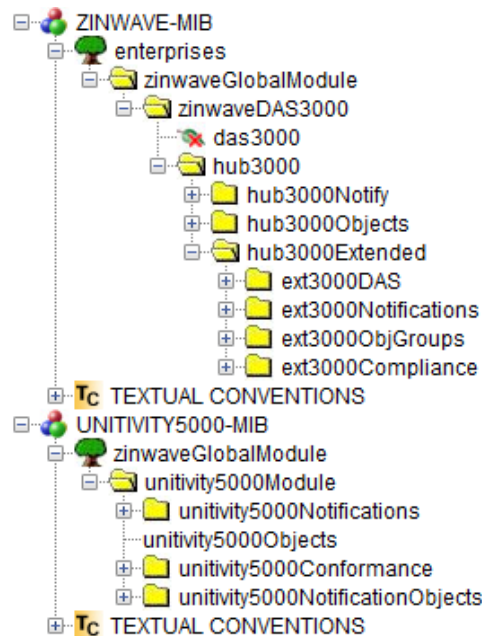

13.4.1 SNMP V3 Manager Configuration

The following are the required SNMP details when connecting to the SNMP Agent running on a hub:

- Target Host IP Address: < Zinwave DAS system > e.g. 192.168.0.2
- Port: 161
- SNMP Version: 3

- User: advanced
- Security Level: auth,priv
- Auth Algo: SHA
- Auth Password: supervisor
- Privacy Algo: AES
- Privacy Password: supervisor

A typical settings dialog is shown below for the ManageEngine MibBrowser:

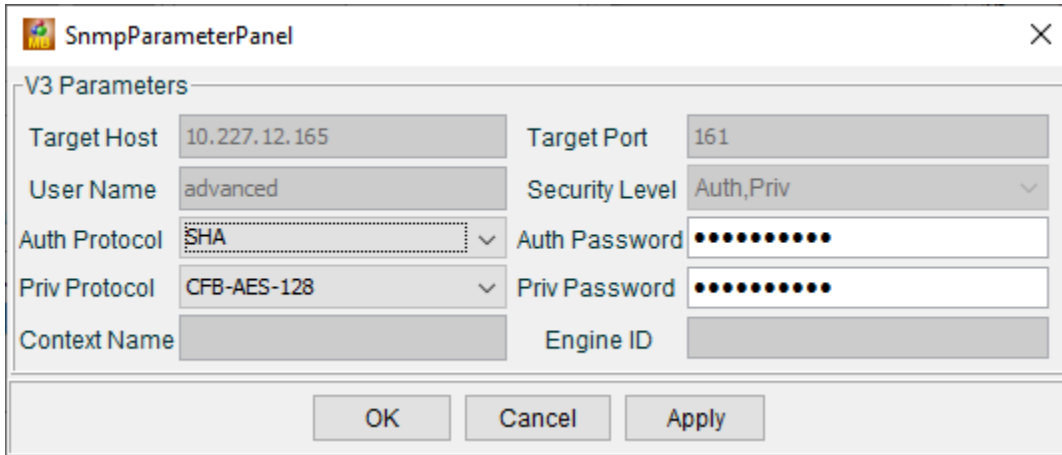

13.4.2 SNMP Trap Events

The Fault Relay Status trap will be sent for all alarms which are reported by the Primary Hub. The Fault Relay activates and the SNMP fault relay status trap is sent, in the event of an alarm. When the first trap is sent, the fault relay is set, subsequent traps are sent for additional alarms raised even if the fault relay has not been cleared. This feature is not enabled during the first 5 minutes from power on of the system. This initial start-up phase is to allow for any transient start-up alarms which may occur prior to the system coming online.

13.4.3 SNMP Get Objects

The following objects can be queried using v2 SNMP Get requests:

- Hub3000Objects.Hub3000String – This is the label of the Hub, as has been set in System Setup.
- Hub3000Objects.Hub3000DeviceType – This is the type of Uniwave unit.
- Hub3000Objects.Hub3000ModelName – This is the model name of the Uniwave unit.
- Hub3000Objects.Hub3000FaultRelayState – The state of the fault relay, either set(1) or cleared(0).
- Hub3000Objects.Hub3000FaultDescription – A description of the last fault detected by the system.
- Hub3000Objects.Hub3000PrevFaultDescription – A description of the previous fault detected by the system.

13.4.4 3000 SNMP Traps

The following SNMP traps are supported:

- Hub3000Notify.Hub3000Heartbeat – This is a heartbeat trap which is sent every 20 minutes to the listening SNMP manager. It contains the following objects: Hub3000String, Hub3000DeviceType, Hub3000ModelName, Hub3000FaultRelayState
- Hub3000Notify.Hub3000FaultRelayStatus – This trap is sent each time a new alarm is raised in the system, and when the fault relay is manually cleared from the PH GUI. It contains the following objects: Hub3000String, Hub3000DeviceType, Hub3000ModelName, Hub3000FaultDescription, Hub3000FaultRelayState

The IP address and port of the SNMP trap receiver (SNMP Manager), is set via the LAN Setup page of the Hub graphical user interface.

Some notes on the SNMP interface and alarms:

- During start-up alarms will be written to the event log, but the fault relay will not set, and no trap will be sent. This start-up period lasts 5 minutes.
- If any alarms remain or any units are still missing once start-up has completed, the Hub will loop through the alarm conditions and send out traps.

13.4.5 Additional 5000 SNMP Objects

The unitivity5000Module group contains notifications which augment the ext3000UnitConfigTable from ZINWAVE-MIB.

13.4.5.1 unitivity5000Notifications

This group supersedes both the Hub3000Events and the ext3000NotificationsGroup.

The unitivity5000Notifications group contains these notifications :

- unitivity5000Heartbeat
- unitivity5000FaultRelayStatus
- unitivity5000DASoperationalStatusChange
- unitivity5000ServiceLossOfServiceChange
- unitivity5000RUconfigLossOfServiceChange
- unitivity5000ModuleLossOfServiceChange
- unitivity5000ModuleServiceWarningChange
- unitivity5000ModuleHardwareWarningChange
- unitivity5000NotificationsLost
- unitivity5000RMPSUALarmsChange

Which replace similar notifications in ZINWAVE-MIB and should be used in the same manner

14 Performing Diagnostics and Testing

14.1 Diagnosing Optical Links with an OTDR

The Infrastructure Cable between Hub Optical Module and Remote Unit must meet the following specifications:

- Maximum Optical Loss 5dBo
- Minimum Optical Return Loss 45dB

This can be guaranteed only with Single mode fiber and SC-APC connections throughout the installation.

14.1.1 Diagnose an Optical Link

In presence of high levels of back reflection due to poor Return loss, the Zinwave system performance is degraded. The effects of this can be easily seen on the system and diagnosed using appropriate test equipment. The effects of back reflection can be seen by looking at the level of the noise floor. In cases where there are high levels of back reflection, the noise floor in either the downlink or the uplink can vary significantly (10-15dB). It may also show as increased levels of harmonics which will also vary in level by significant amounts.

The best way to check the return loss of a fiber link is to use an Optical Time Domain Reflectometer (OTDR) with the appropriate connectors and launch cables. A typical graph result is shown below:

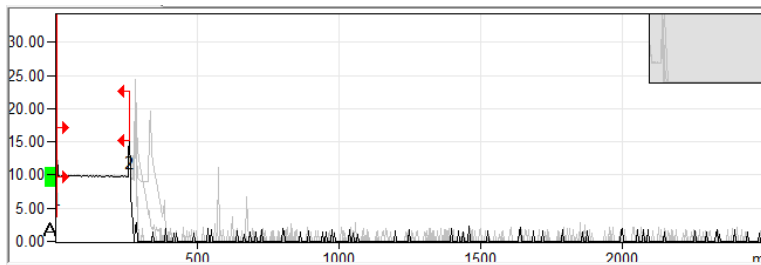

The graph shows the performance of fiber along its length. In this case the first horizontal line represents the first 250m of fiber in the launch box. Each of the subsequent peaks relates to the situations where internal reflection has occurred along the fiber length. This could be connectors, splices or even damaged cables. Generally, the highest peak shows the worst case of back reflection and hence source of return loss and potential interference, depending on the OTDR used results, can be displayed in a tabular form giving distances and the relevant reflection or return loss.

Type	No.	Loc.	Loss	Refl.
→	1	0.0000	- - -	-54.3
←	(0.2566)		0.088	
↕	2	0.2566	- - -	-39.3

In the example above a single reflection of -39.3dB is present. In this case the -39.3dB reflection is at the PC/PC interface at the end of the link and in a link with multiple connections there will be an event for each connection.

It should be noted that the OTDR is not able to distinguish between 2 reflections very close to each other over long lengths of cable and in the case of two reflections close together, only the worst reflection will be shown. However, this will allow installers to identify where in the overall fiber link the problem occurs. Available in Left- navigation bar

14.2 LED Testing

14.2.1 Modules













In order to test the proper operation of the module LEDs, follow the steps below:-

1. Insert an Optical Module into the front of a Primary Hub.
2. Insert a Service Module into the rear of a Primary Hub.
3. Connect the Optical Module to a Remote Unit.









The system should be set up with auto-Setup running and all alarms enabled as faults. The following test sequence should be followed:

4. Switch off the Hub at the mains switch - all module LEDs will be off.
5. Switch on the Hub at the mains switch.

The Optical Module LEDs will follow the sequence shown below:

Left		Middle		Right		Status
	Off		Off		Dull Red	Initial start-up. Basic Power present to allow Module detection
	Off		Off		Green	Module detected and full power connected to module
	Green Flash		Green		Green	Calibration complete, but final output stage not enabled
	Green		Green		Green	Fully operational

The Service Module LEDs will follow the sequence shown below:

Left		Middle		Right		Status
	Off		Off		Dull Red	Initial start-up. Basic Power present to allow Module detection
	Off		Off		Green	Module detected and full power connected to module
	Off		Green		Green	Module Fully Operational

6. Disconnect the optical fiber from the Optical Module connector.

The Optical Module LEDs will alternate between the states shown below:

Left		Middle		Right		Status
	Off		Red		Green	Communication failed with Remote Unit
	Off		Off		Dull Red	Basic Power present to allow Module detection

7. Wait at least 10 seconds then reconnect the optical fiber to the Optical Module. The Optical Module LEDs will follow the same sequence shown in step 2 above.

Note: It is not possible to initiate a module alarm so the left side LED “RED” state cannot be tested.

14.2.2 Remote Unit LED Test

In order to test the correct operation of the Remote Unit LED, make a fiber connection between the Remote Unit and an (enabled) Optical Module in the front of a Primary Hub. Begin the test with 48V disconnected from the power connector of the Remote Unit.

The following test sequence should be followed:

1. Power up the Remote Unit by plugging in the power supply The LED will follow the sequence:
 - a. OFF – RED – ALT. RED/GREEN – GREEN FLASH – GREEN
2. Using “System Setup” disable the Remote Unit output
 - a. The LED will FLASH GREEN
3. Using “System Setup” re-enable the Remote Unit output
 - a. The LED will go GREEN.

14.3 Event Log

Each activity that takes place on this system is recorded as an event. Events can be informational or can generate alarms. For detailed information about alarms, see ["Understanding Alarms & Reporting"](#).

14.3.1 Viewing and saving the Event Log

To view the Event Log:

The event log page provides a history of the last 500 events recorded by the Hub. Event logging is active by default.

14.3.2 System Logging

System Logs are stored on the Hub's internal flash memory and can be sent to Zinwave for more detailed fault-finding. System Logging is commenced by clicking the "Start System Logs" button and is stopped by clicking the "Stop System Logs" button. Alternatively, the system will automatically stop System Logging after 1 week to avoid excessive flash memory wear.

14.4 Downloading Event Log

The Event Log can be downloaded as an "event.txt" text file by clicking the "Download Event Log" button. This provides the option to download the current log as shown on this page.

14.5 System Log

The System Log can be downloaded as an "rawlog.zip" compressed file by clicking the "Download System Log" button.

Note: Depending on your browser, the files may automatically download to a predetermined location. If this is the case, navigate to the file and move or copy the file as desired.

15 Specifications

System RF Parameters		
System Bandwidth (Part No. 308-XXXX)	150 MHz to 5000 MHz	
System Band Gain Flatness	±1 dB	In any 100 MHz band
Wideband Gain Flatness	-5 dB / +1 dB	
Downlink		
Gain (Part No. 308-XXXX)	25 dB (max)	1dB steps
RF Input Power to Service Module	-25 dBm (min) to +15 dBm (max)	Working input power to Service Module
RF output power at Remote Unit Tx port (Part No. 308-0007)	+21 dBm (F < 1575 MHz) +24 dBm (1575 MHz < F < 2700 MHz) +23 dBm (3300 MHz < F < 3700 MHz) +24 dBm (3700 MHz < F < 5000 MHz)	Composite Power at Remote Unit Output for services approved to FCC
	+9 dBm (150 < F < 600 MHz) +13 dBm (600 < F < 850 MHz) +17 dBm (850 < F < 1575 MHz) +21 dBm (1575 MHz < F < 2700 MHz) +22 dBm (3300 MHz < F < 5000 MHz)	Composite Power at Remote Unit Output for services approved to CE
Uplink		
Gain (Part No. 308-XXXX)	25 dB (max)	1 dB steps
RF input level to Remote Unit Rx port	+10 dBm (max)	Overload condition. Signal internally limited to -20dBm max by Remote Unit Uplink AGC
RF output power from Service Module	+5 dBm (max)	Output power of Service Module in Hub
Fiber Optic		
Number of optical ports	Up to 8 duplex ports supported on Primary Hub (Optical Modules); 9 duplex ports on Secondary Hub; 1 duplex port on Remote Unit; SC-APC / SC-APC connectors (except 308-XXXX has LC/APC connectors)	
Wavelength	1310 nm	
Fiber types supported	Single-mode (SM) cable 9/125 μm	
Fiber distance	5 dBo optical link budget, distance dependent on fiber type & quality (typically 2 km)	
Laser safety classification	Class 1, IEC 60825-1:2014	

Connectivity	
Primary Hub	<p>RF Service connection: 2 N-type female connectors (1 pair per Service Module, maximum 4 Service Modules supported)</p> <p>Optical interconnect (Primary Hub to Secondary Hub, or Primary Hub to Remote Unit): duplex fiber SC-APC / SC-APC connector (1 per Optical Module, maximum 8 Optical Modules supported)</p> <p>10/100 Base-T Ethernet connection: 1 RJ45 connector</p> <p>USB2 Host connections: 2 USB type-A receptacles</p> <p>RS232 Serial Terminal: 1 DB-9 male connector</p> <p>Alarm Relay connections: 1 DB-9 female connector</p>
Secondary Hub	<p>Optical interconnect (connections to 1 Primary Hub and 8 Remote Units): 9 duplex fiber SC-APC/SC-APC connectors</p> <p>Alarm Relay connections: 1 DB-9 female connector</p>
Remote Unit	<p>RF Antenna connections: 2 N-type female connectors</p> <p>Optical interconnect: duplex fiber LC-APC connector</p> <p>Alarm Relay connector: 1 Phoenix Contact 5.08 mm 3-way male</p>