

SAR Test Report

Product Name : GSM Mobile Phone

Model No. : AM89

FCC ID : UOSAM89

Applicant : Amgoo Telecom Co., Ltd.

Address : 6/F, Block 3, Tongjian Building, Middle Shennan Rd, Futian
District, Shenzhen, China

Date of Receipt : 22/12/2011

Date of Test : 29/12/2011

Issued Date : 31/12/2011

Report No. : 11CS079R-HP-US-P03V01

Report Version : V1.0

The test results relate only to the samples tested.

The test report shall not be reproduced except in full without the written approval of QuieTek Corporation.

Test Report Certification

Issued Date: 31/12/2011

Report No.: 11CS079R-HP-US-P03V01



Product Name : GSM Mobile Phone

Applicant : Amgoo Telecom Co., Ltd.

Address : 6/F, Block 3, Tongjian Building, Middle Shennan Rd, Futian District, Shenzhen, China

Manufacturer : Amgoo Telecom Co., Ltd.

Address : 6/F, Block 3, Tongjian Building, Middle Shennan Rd, Futian District, Shenzhen, China

Model No. : AM89

FCC ID : UOSAM89

Brand Name : AMGOO

EUT Voltage : DC 3.7V

Applicable Standard : FCC Oet65 Supplement C June 2001
: IEEE Std. 1528-2003,47CFR § 2.1093

Test Result : Max. SAR Measurement (1g)
Head: 1.470W/kg
Body: 1.290W/kg

Performed Location : Suzhou EMC Laboratory
No.99 Hongye Rd., Suzhou Industrial Park Loufeng Hi-Tech Development Zone., Suzhou, China
TEL: +86-512-6251-5088 / FAX: +86-512-6251-5098
FCC Registration Number: 800392

Documented By : Alice Ni
(Engineering ADM: Alice Ni)

Reviewed By : Robin Wu
(Engineering Supervisor: Robin Wu)

Approved By : Marlin Chen
(Engineering Manager: Marlin Chen)

Laboratory Information

We, **QuieTek Corporation**, are an independent EMC and safety consultancy that was established the whole facility in our laboratories. The test facility has been accredited/accepted(audited or listed) by the following related bodies in compliance with ISO 17025, EN 45001 and specified testing scope:

Taiwan R.O.C.	: BSMI, NCC, TAF
Germany	: TUV Rheinland
Norway	: Nemko, DNV
USA	: FCC, NVLAP
Japan	: VCCI

The related certificate for our laboratories about the test site and management system can be downloaded from QuieTek Corporation’s Web Site : <http://www.quietek.com/tw/ctg/cts/accreditations.htm>
 The address and introduction of QuieTek Corporation’s laboratories can be founded in our Web site : <http://www.quietek.com/>

If you have any comments, Please don’t hesitate to contact us. Our contact information is as below:

HsinChu Testing Laboratory :

No.75-2, 3rd Lin, Wangye Keng, Yonghxing Tsuen, Qionglin Shiang, Hsinchu County 307, Taiwan, R.O.C.
 TEL:+886-3-592-8858 / FAX:+886-3-592-8859 E-Mail : service@quietek.com



LinKou Testing Laboratory :

No. 5-22, Ruei-Shu Valley, Ruei-Ping Tsuen, Lin-Kou Shiang, Taipei, Taiwan, R.O.C.
 TEL : 886-2-8601-3788 / FAX : 886-2-8601-3789 E-Mail : service@quietek.com



Suzhou (China) Testing Laboratory :

No. 99 Hongye Rd., Suzhou Industrial Park Loufeng Hi-Tech Development Zone., Suzhou,China.
 TEL : +86-512-6251-5088 / FAX : +86-512-6251-5098 E-Mail : service@quietek.com



TABLE OF CONTENTS

Description	Page
1. General Information	6
1.1. EUT Description	6
1.2. Test Procedure	7
1.3. Test Environment.....	7
2. SAR Measurement System	8
2.1. DASY5 System Description.....	8
2.1.1. Applications	9
2.1.2. Area Scans	9
2.1.3. Zoom Scan (Cube Scan Averaging)	9
2.1.4. Uncertainty of Inter-/Extrapolation and Averaging	9
2.2. DASY5 E-Field Probe.....	10
2.2.1. Isotropic E-Field Probe Specification	10
2.3. Boundary Detection Unit and Probe Mounting Device	11
2.4. DATA Acquisition Electronics (DAE) and Measurement Server	11
2.5. Robot.....	12
2.6. Light Beam Unit.....	12
2.7. Device Holder.....	13
2.8. SAM Twin Phantom.....	13
3. Tissue Simulating Liquid	14
3.1. The composition of the tissue simulating liquid	14
3.2. Tissue Calibration Result.....	15
3.3. Tissue Dielectric Parameters for Head and Body Phantoms	16
4. SAR Measurement Procedure	17
4.1. SAR System Validation.....	17
4.1.1. Validation Dipoles	17
4.1.2. Validation Result	18
4.2. SAR Measurement Procedure.....	19
5. SAR Exposure Limits	20
6. Test Equipment List.....	21
7. Measurement Uncertainty.....	26
8. Conducted Power Measurement	27

9. Test Results.....28

 9.1. SAR Test Results Summary28

Appendix A. SAR System Validation Data33

Appendix B. SAR measurement Data37

Appendix C. Test Setup Photographs & EUT Photographs63

Appendix D. Probe Calibration Data69

Appendix E. Dipole Calibration Data.....80

Appendix F. DAE Calibration Data.....98

1. General Information

1.1. EUT Description

Product Name	GSM Mobile Phone
Model No.	AM89
IMEI 1	356728047057605
IMEI 2	356728047057613
Hardware Version	F707
Software Version	--
Device Category	Portable
RF Exposure Environment	Uncontrolled
Antenna Type	Internal
2G	
Support Band	GSM850/PCS1900
GPRS Type	Class B
GPRS Class	Class 10
Tx Frequency Range	GSM 850: 824~849MHz PCS 1900: 1850~1910MHz
Rx Frequency Range	GSM 850: 869~894MHz PCS 1900: 1930~1990MHz
Release Version	R99
Type of modulation	GMSK for GSM/GPRS
Antenna Gain	0.8dBi
Max. Output Power (Avg. Burst Power)	GSM850:32.91dBm Maximum Peak Conducted Power (31.92dBm Average) PCS1900:29.78dBm Maximum Peak Conducted Power (28.91dBm Average)
Max. Output Power (Radiated)	GSM850: 31.03 dBm- ERP PCS1900: 28.62 dBm- EIRP
Bluetooth	
Bluetooth Frequency	2402~2480MHz
Bluetooth Version	V2.1+EDR
Type of modulation	GFSK,Pi/4 DQPSK,8DPSK
Data Rate	1Mbps(GFSK),2Mbps(Pi/4 DQPSK),3Mbps(8DPSK)
Antenna Gain	0.8dBi

Components

Battery	Brand name: AMGOO Model No. : AM-4CA Voltage and Capacitance: DC 3.7V 800mAh
Adapter	Brand name: AMGOO Model No. : CH4 Input: 100-240V~50/60Hz Output: 5.0VDC, 500mA

Note: The sample used for testing is end product.

1.2. Test Procedure

1	Setup the EUT and simulators as shown on above.
2	Turn on the power of all equipment.
3	EUT communicate with CMU 200, and test them respectively at GSM 850 & PCS1900.

1.3. Test Environment

Ambient conditions in the laboratory:

Items	Required	Actual
Temperature (°C)	18-25	21.5± 2
Humidity (%RH)	30-70	52

2. SAR Measurement System

2.1. DASY5 System Description

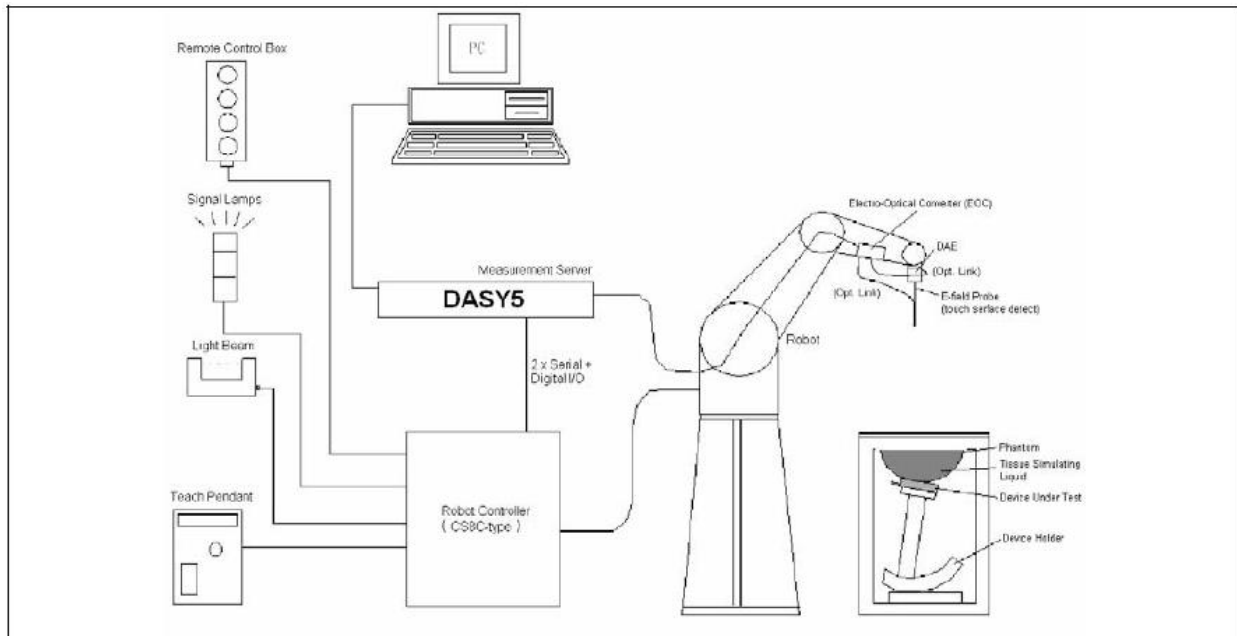

The DASY5 system for performing compliance tests consists of the following items:

- A standard high precision 6-axis robot with controller, teach pendant and software. An arm extension for accommodating the data acquisition electronics (DAE).
- A data acquisition electronics (DAE) which performs the signal amplification, signal multiplexing, AD-conversion, offset measurements, mechanical surface detection, collision detection, etc. The unit is battery powered with standard or rechargeable batteries. The signal is optically transmitted to the EOC.
- The Electro-optical converter (EOC) performs the conversion from optical to electrical signals for the digital communication to the DAE. To use optical surface detection, a special version of the EOC is required. The EOC signal is transmitted to the measurement server.
- The Light Beam used is for probe alignment. This improves the (absolute) accuracy of the probe positioning.
- A computer running WinXP and the DASY5 software.
- Remote control and teach pendant as well as additional circuitry for robot safety such as warning lamps, etc.
- The phantom, the device holder and other accessories according to the targeted measurement.

2.1.1. Applications

Predefined procedures and evaluations for automated compliance testing with all worldwide standards, e.g., IEEE 1528, OET 65, IEC 62209-1, IEC 62209-2, EN 50360, EN 50383 and others.

2.1.2. Area Scans

Area scans are defined prior to the measurement process being executed with a user defined variable spacing between each measurement point (integral) allowing low uncertainty measurements to be conducted. Scans defined for FCC applications utilize a 10mm² step integral, with 1mm interpolation used to locate the peak SAR area used for zoom scan assessments.

When an Area Scan has measured all reachable points, it computes the field maxima found in the scanned area, within a range of the global maximum. The range (in dB) is specified in the standards for compliance testing. For example, a 2 dB range is required in IEEE 1528-2003, EN 50361 and IEC 62209 standards, whereby 3 dB is a requirement when compliance is assessed in accordance with the ARIB standard (Japan).

2.1.3. Zoom Scan (Cube Scan Averaging)

Zoom Scans are used to assess the peak spatial SAR values within a cubic averaging volume containing 1 g and 10 g of simulated tissue. A density of 1000 kg/m³ is used to represent the head and body tissue density and not the phantom liquid density, in order to be consistent with the definition of the liquid dielectric properties, i.e. the side length of the 1 g cube is 10mm, with the side length of the 10 g cube 21,5mm.

The zoom scan integer steps can be user defined so as to reduce uncertainty, but normal practice for typical test applications utilize a physical step of 7x7x7 (5mmx5mmx5mm) providing a volume of 30mm in the X & Y axis, and 30mm in the Z axis.

2.1.4. Uncertainty of Inter-/Extrapolation and Averaging

In order to evaluate the uncertainty of the interpolation, extrapolation and averaged SAR calculation algorithms of the Postprocessor, DASY5 allows the generation of measurement grids which are artificially predefined by analytically based test functions. Therefore, the grids of area scans and zoom scans can be filled with uncertainty test data, according to the SAR benchmark functions of IEEE 1528. The three analytical functions shown in equations as below are used to describe the possible range of the expected SAR distributions for the tested handsets. The field gradients are covered by the spatially flat distribution f1, the spatially steep distribution f3 and f2 accounts for H-field cancellation on the phantom/tissue surface.

$$f_1(x, y, z) = Ae^{-\frac{z}{2a}} \cos^2 \left(\frac{\pi \sqrt{x'^2 + y'^2}}{2 \cdot 5a} \right)$$

$$f_2(x, y, z) = Ae^{-\frac{z}{a}} \frac{a^2}{a^2 + x'^2} \left(3 - e^{-\frac{2z}{a}} \right) \cos^2 \left(\frac{\pi y'}{2 \cdot 3a} \right)$$

$$f_3(x, y, z) = A \frac{a^2}{\frac{a^2}{4} + x'^2 + y'^2} \left(e^{-\frac{2z}{a}} + \frac{a^2}{2(a + 2z)^2} \right)$$

2.2. DASYS E-Field Probe

The SAR measurement is conducted with the dosimetric probe manufactured by SPEAG. The probe is specially designed and calibrated for use in liquid with high permittivity. The dosimetric probe has special calibration in liquid at different frequency. SPEAG conducts the probe calibration in compliance with international and national standards (e.g. IEEE 1528, EN 62209-1, IEC 62209, etc.) under ISO 17025. The calibration data are in Appendix D.

2.2.1. Isotropic E-Field Probe Specification

Model	EX3DV4	
Construction	Symmetrical design with triangular core Built-in shielding against static charges PEEK enclosure material (resistant to organic solvents, e.g., DGBE)	
Frequency	10 MHz to 6 GHz Linearity: ± 0.2 dB (30 MHz to 6 GHz)	
Directivity	± 0.3 dB in HSL (rotation around probe axis) ± 0.5 dB in tissue material (rotation normal to probe axis)	
Dynamic Range	10 µW/g to 100 mW/g Linearity: ± 0.2 dB (noise: typically < 1 µW/g)	
Dimensions	Overall length: 330 mm (Tip: 20 mm) Tip diameter: 2.5 mm (Body: 12 mm) Typical distance from probe tip to dipole centers: 1 mm	
Application	High precision dosimetric measurements in any exposure scenario (e.g., very strong gradient fields). Only probe which enables compliance testing for frequencies up to 6 GHz with precision of better 30%.	

2.3. Boundary Detection Unit and Probe Mounting Device

The DASY5 probes use a precise connector and an additional holder for the probe, consisting of a plastic tube and a flexible silicon ring to center the probe. The connector at the DAE is flexibly mounted and held in the default position with magnets and springs. Two switching systems in the connector mount detect frontal and lateral probe collisions and trigger the necessary software response.

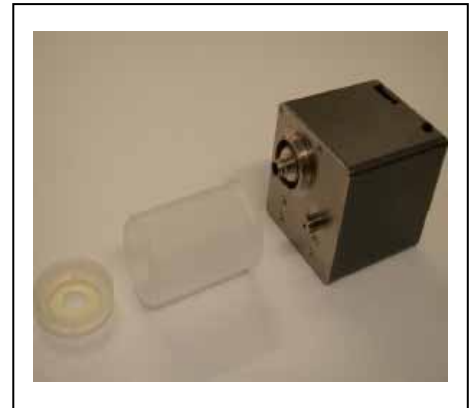

2.4. DATA Acquisition Electronics (DAE) and Measurement Server

The data acquisition electronics (DAE) consists of a highly sensitive electrometer-grade preamplifier with auto-zeroing, a channel and gain-switching multiplexer, a fast 16 bit AD-converter and a command decoder and control logic unit.

Transmission to the measurement server is accomplished through an optical downlink for data and status information as well as an optical uplink for commands and the clock.

The input impedance of the DAE4 is 200M Ohm; the inputs are symmetrical and floating. Common mode rejection is above 80dB.

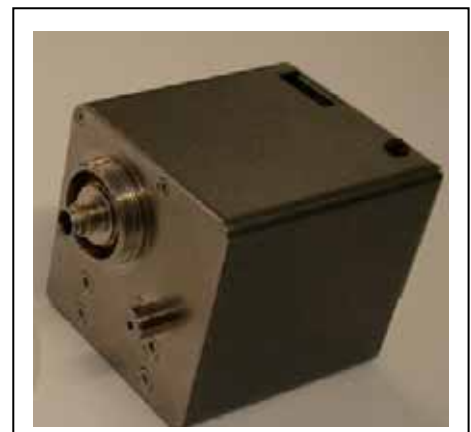

The DASY5 measurement server is based on a PC/104 CPU board with a 400MHz intel ULV Celeron, 128MB chipdisk and 128MB RAM. The necessary circuits for communication with the DAE electronics box, as well as the 16 bit AD converter system for optical detection and digital I/O interface are contained on the DASY5 I/O board, which is directly connected to the PC/104 bus of the CPU board.



2.5. Robot

The DASY5 system uses the high precision robots TX90 XL type out of the newer series from Stäubli SA (France). For the 6-axis controller DASY5 system, the CS8C robot controller version from Stäubli is used.

The XL robot series have many features that are important for our application:

- High precision (repeatability 0.02 mm)
- High reliability (industrial design)
- Jerk-free straight movements
- Low ELF interference (the closed metallic construction shields against motor control fields)
- 6-axis controller



2.6. Light Beam Unit

The light beam switch allows automatic "tooling" of the probe. During the process, the actual position of the probe tip with respect to the robot arm is measured, as well as the probe length and the horizontal probe offset. The software then corrects all movements, such that the robot coordinates are valid for the probe tip.

The repeatability of this process is better than 0.1 mm. If a position has been taught with an aligned probe, the same position will be reached with another aligned probe within 0.1 mm, even if the other probe has different dimensions. During probe rotations, the probe tip will keep its actual position.



2.7. Device Holder

The DASY5 device holder is designed to cope with different positions given in the standard. It has two scales for the device rotation (with respect to the body axis) and the device inclination (with respect to the line between the ear reference points). The rotation center for both scales is the ear reference point (EPR).

Thus the device needs no repositioning when changing the angles.

The DASY5 device holder has been made out of low-loss POM material having the following dielectric parameters: relative permittivity $\epsilon_r = 3$ and loss tangent $\delta = 0.02$. The amount of dielectric material has been reduced in the closest vicinity of the device, since measurements have suggested that the influence of the clamp on the test results could thus be lowered.



2.8. SAM Twin Phantom

The SAM twin phantom is a fiberglass shell phantom with 2mm shell thickness (except the ear region where shell thickness increases to 6mm). It has three measurement areas:

- Left head
- Right head
- Flat phantom



The bottom plate contains three pair of bolts for locking the device holder. The device holder positions are adjusted to the standard measurement positions in the three sections. A white cover is provided to tap the phantom during off-periods to prevent water evaporation and changes in the liquid parameters. On the phantom top, three reference markers are provided to identify the phantom position with respect to the robot.

3. Tissue Simulating Liquid

3.1. The composition of the tissue simulating liquid

INGREDIENT (% Weight)	835MHz Head	835MHz Body	1900MHz Head	1900MHz Body
Water	40.45	52.4	54.90	40.5
Salt	1.45	1.40	0.18	0.50
Sugar	57.6	45.0	0.00	58.0
HEC	0.40	1.00	0.00	0.50
Preventol	0.10	0.20	0.00	0.50
DGBE	0.00	0.00	44.92	0.00

3.2. Tissue Calibration Result

The dielectric parameters of the liquids were verified prior to the SAR evaluation using DASY5 Dielectric Probe Kit and Agilent Vector Network Analyzer E5071C

Head Tissue Simulant Measurement				
Frequency [MHz]	Description	Dielectric Parameters		Tissue Temp. [°C]
		ϵ_r	σ [s/m]	
835 MHz	Reference result ± 5% window	41.50 39.43 to 43.58	0.90 0.86 to 0.95	N/A
	29-12-2011	42.27	0.91	21.0

Body Tissue Simulant Measurement				
Frequency [MHz]	Description	Dielectric Parameters		Tissue Temp. [°C]
		ϵ_r	σ [s/m]	
835 MHz	Reference result ± 5% window	55.2 52.44 to 57.96	0.97 0.92 to 1.02	N/A
	29-12-2011	54.73	0.98	21.0

Head Tissue Simulant Measurement				
Frequency [MHz]	Description	Dielectric Parameters		Tissue Temp. [°C]
		ϵ_r	σ [s/m]	
1900 MHz	Reference result ± 5% window	40.0 38.00 to 42.00	1.40 1.33 to 1.47	N/A
	29-12-2011	39.27	1.42	21.0

Body Tissue Simulant Measurement				
Frequency [MHz]	Description	Dielectric Parameters		Tissue Temp. [°C]
		ϵ_r	σ [s/m]	
1900 MHz	Reference result ± 5% window	53.3 50.64 to 55.97	1.52 1.44 to 1.60	N/A
	29-12-2011	52.45	1.54	21.0

3.3. Tissue Dielectric Parameters for Head and Body Phantoms

The head tissue dielectric parameters recommended by the IEEE SCC-34/SC-2 in P1528 have been incorporated in the following table. These head parameters are derived from planar layer models simulating the highest expected SAR for the dielectric properties and tissue thickness variations in a human head. Other head and body tissue parameters that have not been specified in P1528 are derived from the tissue dielectric parameters computed from the 4-Cole-Cole equations described in Reference [12] and extrapolated according to the head parameters specified in P1528.

Target Frequency (MHz)	Head		Body	
	ϵ_r	σ (S/m)	ϵ_r	σ (S/m)
150	52.3	0.76	61.9	0.80
300	45.3	0.87	58.2	0.92
450	43.5	0.87	56.7	0.94
835	41.5	0.90	55.2	0.97
900	41.5	0.97	55.0	1.05
915	41.5	0.98	55.0	1.06
1450	40.5	1.20	54.0	1.30
1610	40.3	1.29	53.8	1.40
1800 – 2000	40.0	1.40	53.3	1.52
2450	39.2	1.80	52.7	1.95
3000	38.5	2.40	52.0	2.73
5800	35.3	5.27	48.2	6.00

(ϵ_r = relative permittivity, σ = conductivity and $\rho = 1000 \text{ kg/m}^3$)

4. SAR Measurement Procedure

4.1. SAR System Validation

4.1.1. Validation Dipoles

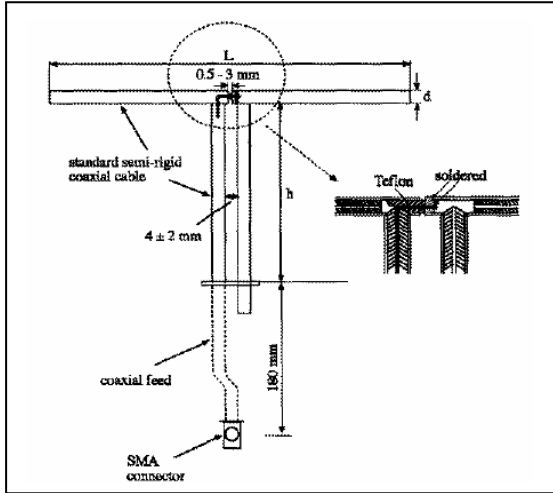

The dipoles used is based on the IEEE-1528 standard, and is complied with mechanical and electrical specifications in line with the requirements of both IEEE and FCC Supplement C. the table below provides details for the mechanical and electrical specifications for the dipoles.

Frequency	L (mm)	h (mm)	d (mm)
835MHz	161.0	89.8	3.6
1900MHz	68.0	39.5	3.6

4.1.2. Validation Result

System Performance Check at 835MHz &1900MHz for Head				
Validation Kit: D835V2-SN 4d094				
Frequency [MHz]	Description	SAR [w/kg] 1g	SAR [w/kg] 10g	Tissue Temp. [°C]
835 MHz	Reference result ± 10% window	9.70 8.73 to 10.67	6.30 5.67 to 6.93	N/A
	29-12-2011	10.04	6.56	21.0
Validation Kit: D1900V2-SN 5d121				
Frequency [MHz]	Description	SAR [w/kg] 1g	SAR [w/kg] 10g	Tissue Temp. [°C]
1900 MHz	Reference result ± 10% window	39.8 35.82 to 43.78	21.1 18.99 to 23.21	N/A
	29-12-2011	42.00	21.44	21.0
Note: All SAR values are normalized to 1W forward power.				
System Performance Check at 835MHz &1900MHz for Body				
Validation Kit: D835V2-SN 4d094				
Frequency [MHz]	Description	SAR [w/kg] 1g	SAR [w/kg] 10g	Tissue Temp. [°C]
835 MHz	Reference result ± 10% window	9.90 8.91 to 10.89	6.53 5.88 to 7.18	N/A
	29-12-2011	9.68	6.24	21.0
Validation Kit: D1900V2-SN 5d121				
Frequency [MHz]	Description	SAR [w/kg] 1g	SAR [w/kg] 10g	Tissue Temp. [°C]
1900 MHz	Reference result ± 10% window	41.4 37.26 to 45.54	22.3 20.07 to 24.53	N/A
	29-12-2011	42.40	21.60	21.0
Note: All SAR values are normalized to 1W forward power.				

4.2. SAR Measurement Procedure

The DASYS calculates SAR using the following equation,

$$SAR = \frac{\sigma |E|^2}{\rho}$$

σ : represents the simulated tissue conductivity

ρ : represents the tissue density

The EUT is set to transmit at the required power in line with product specification, at each frequency relating to the LOW, MID, and HIGH channel settings.

Pre-scans are made on the device to establish the location for the transmitting antenna, using a large area scan in either air or tissue simulation fluid.

The EUT is placed against the Universal Phantom where the maximum area scan dimensions are larger than the physical size of the resonating antenna. When the scan size is not large enough to cover the peak SAR distribution, it is modified by either extending the area scan size in both the X and Y directions, or the device is shifted within the predefined area.

The area scan is then run to establish the peak SAR location (interpolated resolution set at 1mm²) which is then used to orient the center of the zoom scan. The zoom scan is then executed and the 1g and 10g averages are derived from the zoom scan volume (interpolated resolution set at 1mm³).

When multiple peak SAR locations were found during the same configuration or test mode, Zoom scan shall performed on each peak SAR location, only the peak point with maximum SAR value will be reported for the configuration or test mode.

5. SAR Exposure Limits

SAR assessments have been made in line with the requirements of IEEE-1528, FCC Supplement C, and comply with ANSI/IEEE C95.1-1992 “Uncontrolled Environments” limits. These limits apply to a location which is deemed as “Uncontrolled Environment” which can be described as a situation where the general public may be exposed to an RF source with no prior knowledge or control over their exposure.

Limits for General Population/Uncontrolled Exposure (W/kg)

Type Exposure	Uncontrolled Environment Limit
Spatial Peak SAR (1g cube tissue for brain or body)	1.60 W/kg
Spatial Average SAR (whole body)	0.08 W/kg
Spatial Peak SAR (10g for hands, feet, ankles and wrist)	4.00 W/kg

6. Test Equipment List

Instrument	Manufacturer	Model No.	Serial No.	Cali. Due Date
Stäubli Robot TX60L	Stäubli	TX60L	F10/5C90A1/A/01	only once
Controller	Stäubli	SP1	S-0034	only once
Dipole Validation Kits	Speag	D835V2	4d094	2012.03.15
Dipole Validation Kits	Speag	D1900V2	5d121	2012.03.23
SAM Twin Phantom	Speag	SAM	TP-1561/1562	N/A
Device Holder	Speag	SD 000 H01 HA	N/A	N/A
Data Acquisition Electronic	Speag	DAE4	915	2012.07.26
E-Field Probe	Speag	EX3DV4	3661	2012.01.24
SAR Software	Speag	DASY5	V5.2 Build 162	N/A
Power Amplifier	Mini-Circuit	ZVA-183-S+	N657400950	N/A
Directional Coupler	Agilent	778D	20160	N/A
Universal Radio Communication Tester	R&S	CMU 200	117088	2012.04.29
Vector Network	Agilent	E5071C	MY48367267	2012.04.10
Signal Generator	Agilent	E4438C	MY49070163	2012.04.23
Power Meter	Anritsu	ML2495A	0905006	2012.01.12
Wide Bandwidth Sensor	Anritsu	MA2411B	0846014	2012.01.12

Note: Per KDB 450824 D02 requirements for dipole calibration, Quietek Lab has adopted two years calibration intervals. On annual basis, every measurement dipole has been evaluated and is in compliance with the following criteria:

1. There is no physical damage on the dipole;
2. System validation with specific dipole is within 10% of calibrated value;
3. Return-loss is within 20% of calibrated measurement (Show below);
4. Impedance is within 5Ω of calibrated measurement (Show below).

Impedance Plot for D835V2

835 Head

Calibrated impedance: 52.2 Ω; Measured impedance: 50.322 Ω (within 5Ω)

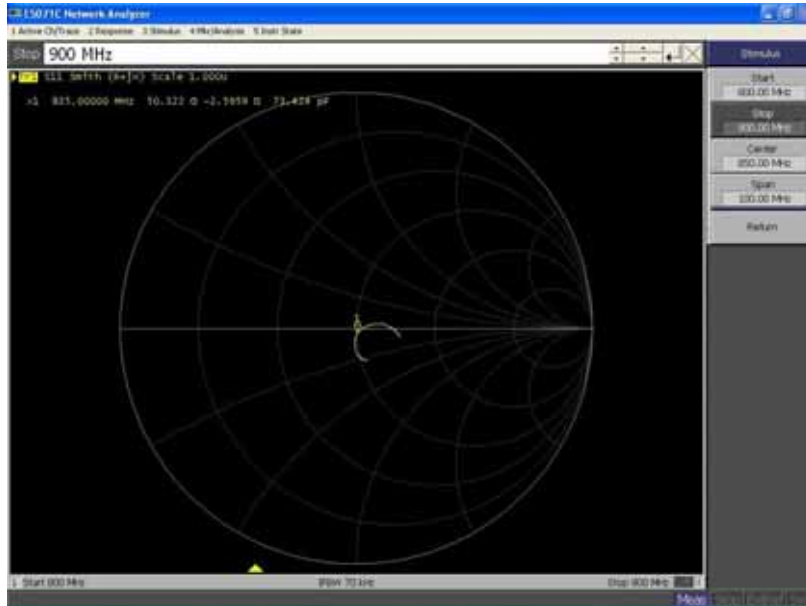

Calibrated return loss: -29.4 dB; Measured impedance: -27.246 dB (within 20%)

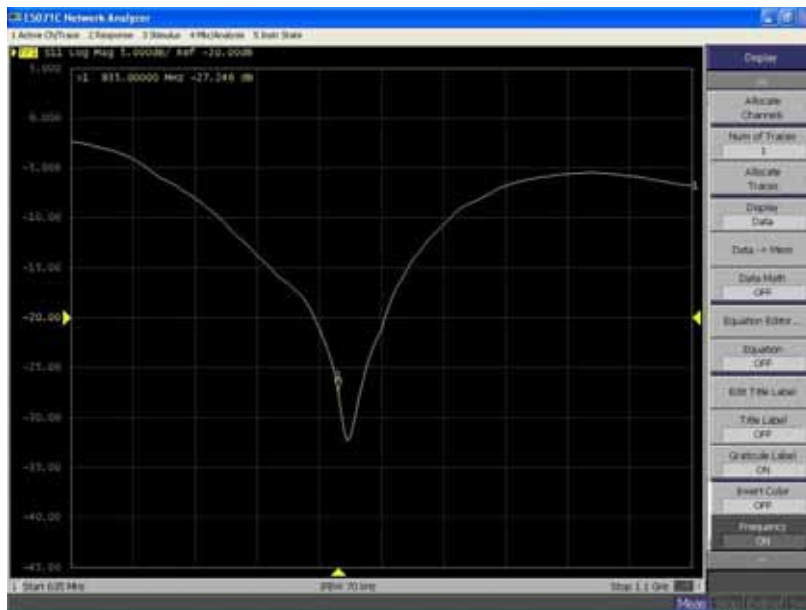

835 Body

Calibrated impedance: 48.0 Ω; Measured impedance: 48.611 Ω (within 5%)

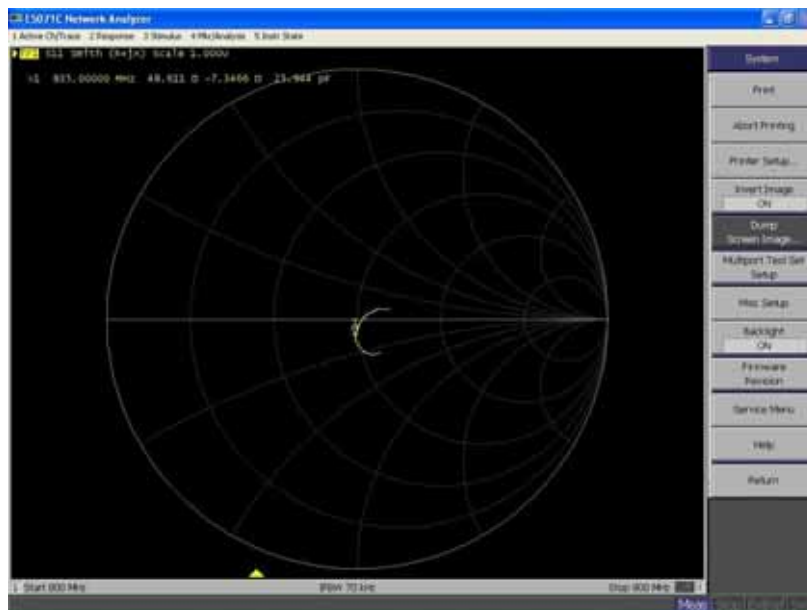

Calibrated return loss: -25.5 dB; Measured impedance: -26.333 dB (within 20%)

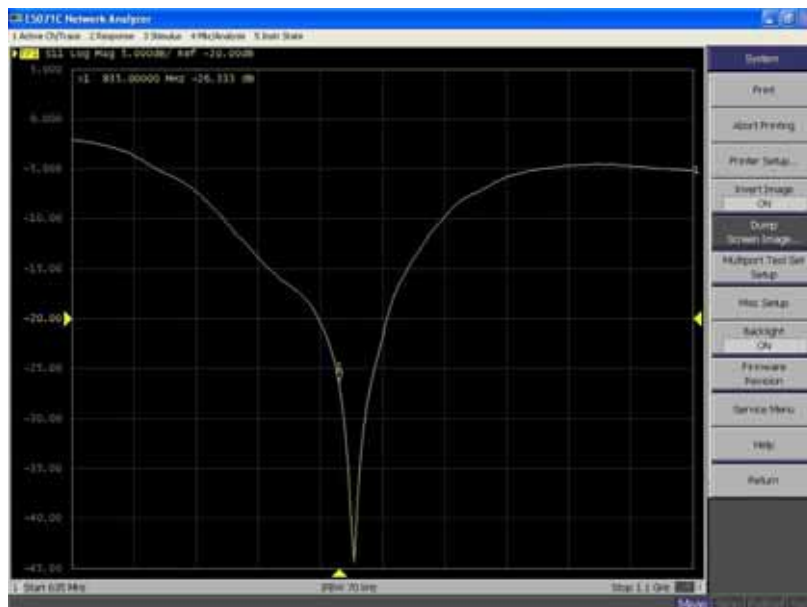

Impedance Plot for D1900V2

1900 Head

Calibrated impedance: 50.6 Ω; Measured impedance: 51.610 Ω (within 5Ω)

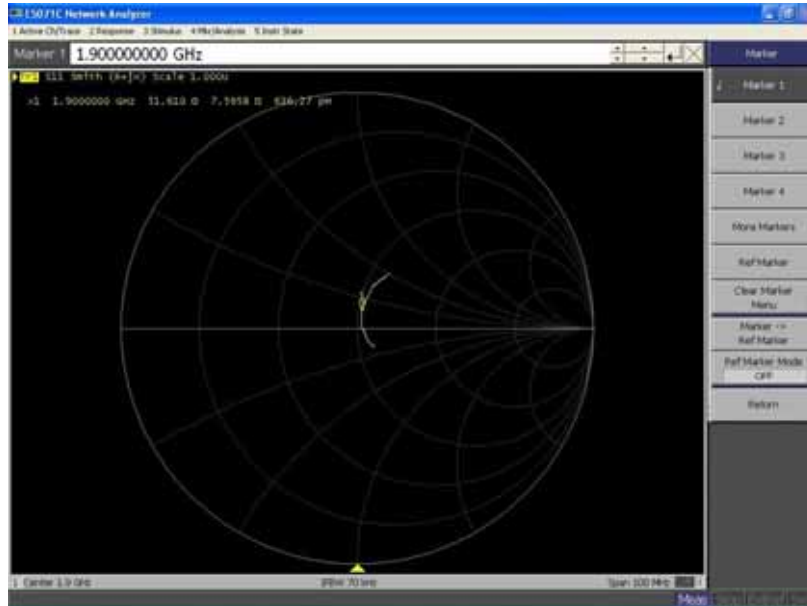

Calibrated return loss: -22.7 dB; Measured impedance: -23.651 dB (within 20%)

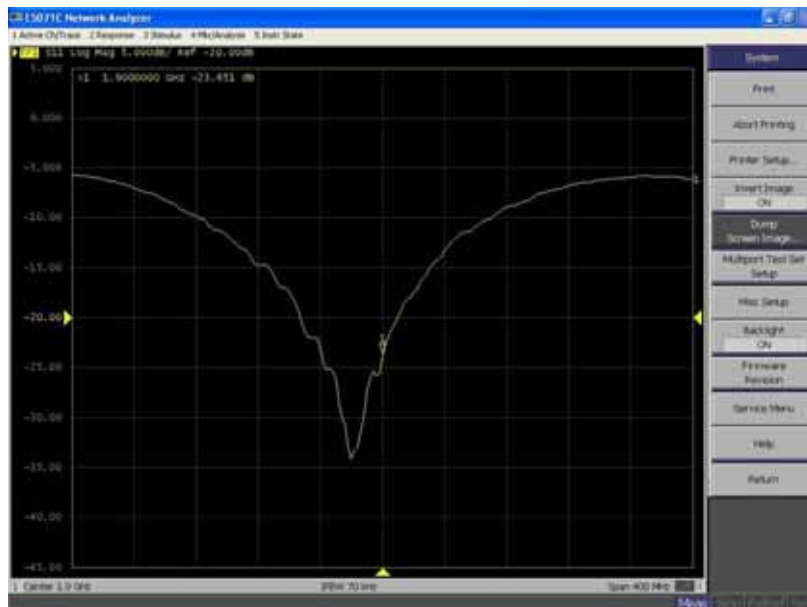

1900 Body

Calibrated impedance: 46.1 Ω ; Measured impedance: 45.692 Ω (within 5 Ω)

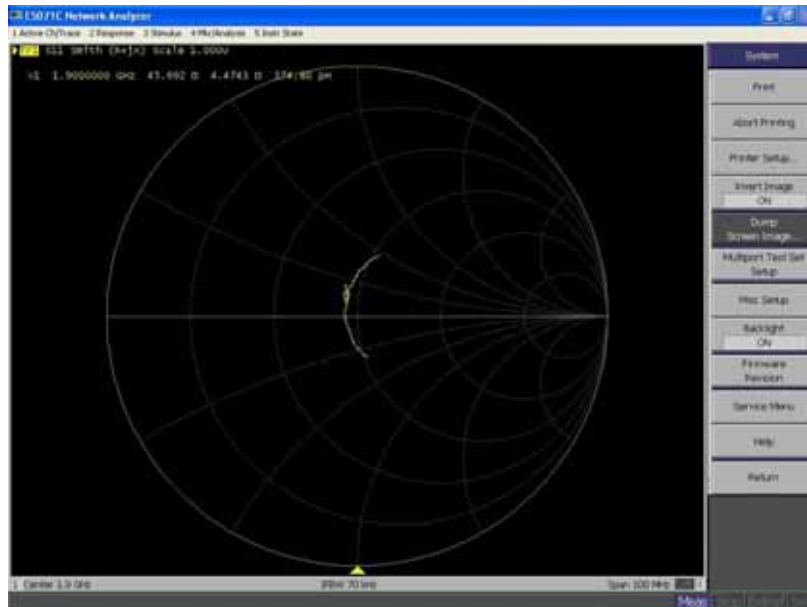

Calibrated return loss: -21.5 dB; Measured impedance: -20.425 dB (within 20%)

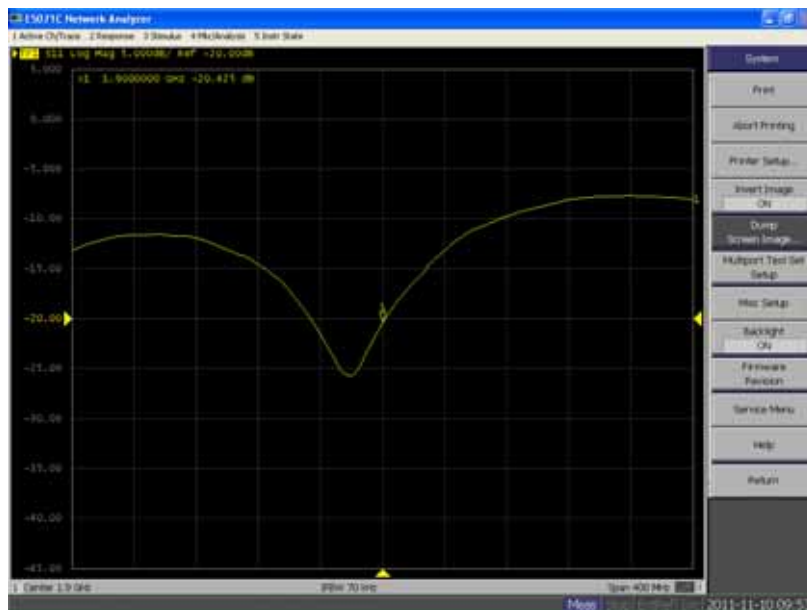

7. Measurement Uncertainty

DASY5 Uncertainty								
Measurement uncertainty for 300 MHz to 3 GHz averaged over 1 gram / 10 gram.								
Error Description	Uncert. value	Prob. Dist.	Div.	(ci) 1g	(ci) 10g	Std. Unc. (1g)	Std. Unc. (10g)	(vi) V _{eff}
Measurement System								
Probe Calibration	±5.5%	N	1	1	1	±5.5%	±5.5%	∞
Axial Isotropy	±4.7%	R	√3	0.7	0.7	±1.9%	±1.9%	∞
Hemispherical Isotropy	±9.6%	R	√3	0.7	0.7	±3.9%	±3.9%	∞
Boundary Effects	±1.0%	R	√3	1	1	±0.6%	±0.6%	∞
Linearity	±4.7%	R	√3	1	1	±2.7%	±2.7%	∞
System Detection Limits	±1.0%	R	√3	1	1	±0.6%	±0.6%	∞
Readout Electronics	±0.3%	N	1	1	1	±0.3%	±0.3%	∞
Response Time	±0.8%	R	√3	1	1	±0.5%	±0.5%	∞
Integration Time	±2.6%	R	√3	1	1	±1.5%	±1.5%	∞
RF Ambient Noise	±3.0%	R	√3	1	1	±1.7%	±1.7%	∞
RF Ambient Reflections	±3.0%	R	√3	1	1	±1.7%	±1.7%	∞
Probe Positioner	±0.4%	R	√3	1	1	±0.2%	±0.2%	∞
Probe Positioning	±2.9%	R	√3	1	1	±1.7%	±1.7%	∞
Max. SAR Eval.	±1.0%	R	√3	1	1	±0.6%	±0.6%	∞
Test Sample Related								
Device Positioning	±2.9%	N	1	1	1	±2.9%	±2.9%	145
Device Holder	±3.6%	N	1	1	1	±3.6%	±3.6%	5
Power Drift	±5.0%	R	√3	1	1	±2.9%	±2.9%	∞
Phantom and Setup								
Phantom Uncertainty	±4.0%	R	√3	1	1	±2.3%	±2.3%	∞
Liquid Conductivity (target)	±5.0%	R	√3	0.64	0.43	±1.8%	±1.2%	∞
Liquid Conductivity (meas.)	±2.5%	N	1	0.64	0.43	±1.6%	±1.1%	∞
Liquid Permittivity (target)	±5.0%	R	√3	0.6	0.49	±1.7%	±1.4%	∞
Liquid Permittivity (meas.)	±2.5%	N	1	0.6	0.49	±1.5%	±1.2%	∞
Combined Std. Uncertainty						±10.7%	±10.5%	387
Expanded STD Uncertainty						±21.4%	±21.0%	

8. Conducted Power Measurement

Mode	Frequency (MHz)	Avg. Burst Power (dBm)	Duty Cycle Factor (dB)	Frame Power (dBm)
Maximum Power <SIM 1>				
GSM850	824.2	30.73	-9	21.73
	836.4	30.53	-9	21.53
	848.6	30.27	-9	21.27
PCS1900	1850.2	30.65	-9	21.65
	1880.0	30.41	-9	21.41
	1909.8	30.10	-9	21.10
GPRS850(2 Slot)	824.2	30.13	-6	24.13
	836.4	29.80	-6	23.80
	848.6	29.54	-6	23.54
GPRS1900(2 Slot)	1850.2	30.47	-6	24.47
	1880.0	30.89	-6	24.89
	1909.8	29.84	-6	23.84
Maximum Power <SIM 2>				
GSM850	836.4	30.46	-9	21.46
PCS1900	1880.0	30.39	-9	21.39

Note: All SAR testing was done in SIM 1.

9. Test Results

9.1. SAR Test Results Summary

9.1.1. Test position and configuration

Head SAR was performed with the device configured in the positions according to IEEE1528, and Body SAR was performed with the device 15mm from the phantom. Body SAR was also performed with the headset attached and without.

9.1.2. Body SAR with Headset

Testing with the headset was performed at the position and channels that resulted in the highest body SAR. This testing was performed with GPRS transmitting with 2 uplink timeslots. This operation mode represents the maximum SAR situation, when downloading data via GPRS and listening to music by headset. SAR without the headset attached was significantly higher than with the headset, and also was verified several times and confirmed, so the final test data shown were the worst case without headset.

In the Body SAR test result table, body-worn means display of device down, body-front means display of device up.

9.1.3. Operation Mode

This is a multislots class 10 device capable of 2 uplink timeslots. During the head SAR test, the device was transmitting with 1 uplink timeslot; during the body SAR test, it was transmitting with 2 uplink timeslots. Additionally, this device doesn't support dual transfer mode (DTM).

9.1.4. Reference Document

KDB 447498 and KDB 648474, KDB 941225.

9.1.5. Test Result

SAR MEASUREMENT							
Ambient Temperature (°C) : 21.5 ±2				Relative Humidity (%) : 52			
Liquid Temperature (°C) : 21.0 ±2				Depth of Liquid (cm) : >15			
Product: GSM Mobile Phone							
Test Mode: GSM850 <SIM 1>							
Test Position Head	Antenna Position	Frequency		Frame Power (dBm)	Power Drift (<±0.2)	SAR 1g (W/kg)	Limit (W/kg)
		Channel	MHz				
Left-Cheek	Fixed	128	824.2	21.73	--	--	1.6
Left-Cheek	Fixed	189	836.4	21.53	-0.130	0.453	1.6
Left-Cheek	Fixed	251	848.6	21.27	--	--	1.6
Left-Tilted	Fixed	189	836.4	21.53	-0.180	0.113	1.6
Right-Cheek	Fixed	128	824.2	21.73	--	--	1.6
Right-Cheek	Fixed	189	836.4	21.53	-0.142	0.590	1.6
Right-Cheek	Fixed	251	848.6	21.27	--	--	1.6
Right-Tilted	Fixed	189	836.4	21.53	-0.193	0.118	1.6
Test Mode: GSM850 <SIM 2>							
Right-Cheek	Fixed	189	836.4	21.46	-0.157	0.520	1.6
Note: when the 1-g SAR is ≤ 0.8 W/kg, testing for low and high channel is optional, refer to KDB 941225.							

SAR MEASUREMENT								
Ambient Temperature (°C) : 21.5 ±2					Relative Humidity (%) : 52			
Liquid Temperature (°C) : 21.0 ±2					Depth of Liquid (cm):>15			
Product: GSM Mobile Phone								
Test Mode: GSM850								
Test Position Body	Antenna Position	Frequency		Separation Distance (mm)	Frame Power (dBm)	Power Drift (≤±0.2)	SAR 1g (W/kg)	Limit (W/kg)
		Channel	MHz					
Body-worn	Fixed	128	824.2	15	21.73	--	--	1.6
Body-worn	Fixed	189	836.4	15	21.53	0.022	0.284	1.6
Body-worn	Fixed	251	848.6	15	21.27	--	--	1.6
Test Mode: GPRS850 2slot								
Body-worn	Fixed	128	824.2	15	24.13	--	--	1.6
Body-worn	Fixed	189	836.4	15	23.80	-0.117	0.565	1.6
Body-worn	Fixed	251	848.6	15	23.54	--	--	1.6
Body-front	Fixed	189	836.4	15	23.80	-0.123	0.298	1.6
Body-worn (With Headset)	Fixed	189	836.4	15	23.80	-0.047	0.437	1.6
Note: when the 1-g SAR is ≤ 0.8 W/kg, testing for low and high channel is optional, refer to KDB 941225.								

SAR MEASUREMENT							
Ambient Temperature (°C) : 21.5 ±2				Relative Humidity (%): 52			
Liquid Temperature (°C) : 21.0 ±2				Depth of Liquid (cm):>15			
Product: GSM Mobile Phone							
Test Mode: PCS1900 <SIM 1>							
Test Position Head	Antenna Position	Frequency		Frame Power (dBm)	Power Drift (<±0.2)	SAR 1g (W/kg)	Limit (W/kg)
		Channel	MHz				
Left-Cheek	Fixed	512	1850.2	21.65	-0.080	1.310	1.6
Left-Cheek	Fixed	661	1880.0	21.41	-0.172	1.320	1.6
Left-Cheek	Fixed	810	1909.8	21.10	-0.001	1.350	1.6
Left-Tilted	Fixed	661	1880.0	21.41	-0.098	0.725	1.6
Right-Cheek	Fixed	512	1850.2	21.65	-0.082	1.410	1.6
Right-Cheek	Fixed	661	1880.0	21.41	0.045	1.360	1.6
Right-Cheek	Fixed	810	1909.8	21.10	0.022	1.470	1.6
Right-Tilted	Fixed	661	1880.0	21.41	-0.065	0.664	1.6
Test Mode: PCS1900 <SIM 2>							
Right-Cheek	Fixed	661	1880.0	21.39	-0.161	1.310	1.6
Note: when the 1-g SAR is ≤ 0.8 W/kg, testing for low and high channel is optional, refer to KDB 941225.							

SAR MEASUREMENT								
Ambient Temperature (°C) : 21.5 ±2				Relative Humidity (%): 52				
Liquid Temperature (°C) : 21.0 ±2				Depth of Liquid (cm):>15				
Product: GSM Mobile Phone								
Test Mode: PCS1900								
Test Position Body	Antenna Position	Frequency		Separation Distance (mm)	Frame Power (dBm)	Power Drift (≤±0.2)	SAR 1g (W/kg)	Limit (W/kg)
		Channel	MHz					
Body-worn	Fixed	512	1850.2	15	21.65	--	--	1.6
Body-worn	Fixed	661	1880.0	15	21.41	0.087	0.251	1.6
Body-worn	Fixed	810	1909.8	15	21.10	--	--	1.6
Test Mode: GPRS1900 2slot								
Body-worn	Fixed	512	1850.2	15	24.47	--	--	1.6
Body-worn	Fixed	661	1880.0	15	24.89	-0.136	0.487	1.6
Body-worn	Fixed	810	1909.8	15	23.84	--	--	1.6
Body-front	Fixed	512	1850.2	15	24.47	-0.194	1.250	1.6
Body-front	Fixed	661	1880.0	15	24.89	-0.148	1.290	1.6
Body-front	Fixed	810	1909.8	15	23.84	-0.146	1.180	1.6
Body-worn (With Headset)	Fixed	661	1880.0	15	24.89	-0.185	0.478	1.6
Note: when the 1-g SAR is ≤ 0.8 W/kg, testing for low and high channel is optional, refer to KDB 941225.								

Appendix A. SAR System Validation Data

Date/Time: 29-12-2011

Test Laboratory: QuieTek Lab

System Check Head 835MHz

DUT: Dipole 835 MHz D835V2; Type: D835V2

Communication System: CW; Communication System Band: D835 (835.0 MHz); Duty Cycle: 1:1;

Frequency: 835 MHz; Medium parameters used: $f = 835 \text{ MHz}$; $\sigma = 0.91 \text{ mho/m}$; $\epsilon_r = 42.27$; $\rho = 1000 \text{ kg/m}^3$;

Phantom section: Flat Section ; Input Power=250mW

Ambient temperature (°C): 21.5, Liquid temperature (°C): 21.0

DASY5 Configuration:

- Probe: EX3DV4 - SN3661; ConvF(9.58, 9.58, 9.58); Calibrated: 24/01/2011
- Sensor-Surface: 4mm (Mechanical Surface Detection)
- Electronics: DAE4 Sn915; Calibrated: 26/07/2011
- Phantom: SAM2; Type: SAM; Serial: TP1562
- Measurement SW: DASY5, V5.2 Build 162; SEMCAD X Version 14.0 Build 59

Configuration/System Check GSM850 Head/Area Scan (6x19x1): Measurement grid: $dx=10\text{mm}$, $dy=10\text{mm}$, Maximum value of SAR (measured) = 2.59 mW/g

Configuration/System Check GSM850 Head/Zoom Scan (7x7x7)/Cube 0: Measurement grid: $dx=5\text{mm}$, $dy=5\text{mm}$, $dz=5\text{mm}$, Reference Value = 55.7 V/m; Power Drift = -0.078 dB

Peak SAR (extrapolated) = 3.8 W/kg

SAR(1 g) = 2.51 mW/g; SAR(10 g) = 1.64 mW/g Maximum value of SAR (measured) = 2.71 mW/g

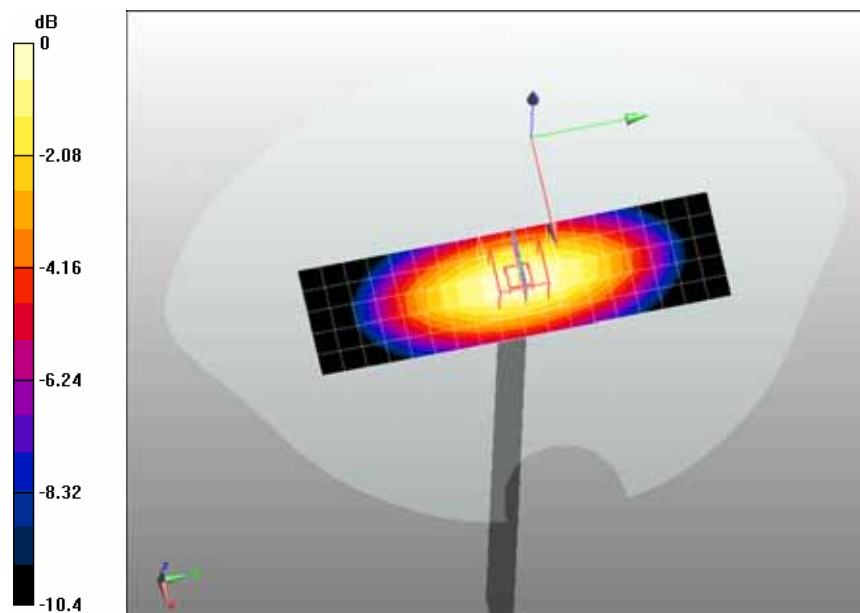

0 dB = 2.71mW/g

Date/Time: 29-12-2011

Test Laboratory: QuieTek Lab

System Check Body 835MHz

DUT: Dipole 835 MHz D835V2; Type: D835V2

Communication System: CW; Communication System Band: D835 (835.0 MHz); Duty Cycle: 1:1;

Frequency: 835 MHz; Medium parameters used: $f = 835 \text{ MHz}$; $\sigma = 0.98 \text{ mho/m}$; $\epsilon_r = 54.73$; $\rho = 1000 \text{ kg/m}^3$;

Phantom section: Flat Section ; Input Power=250mW

Ambient temperature (°C): 21.5, Liquid temperature (°C): 21.0

DASY5 Configuration:

- Probe: EX3DV4 - SN3661; ConvF(9.58, 9.58, 9.58); Calibrated: 24/01/2011
- Sensor-Surface: 4mm (Mechanical Surface Detection)
- Electronics: DAE4 Sn915; Calibrated: 26/07/2011
- Phantom: SAM1; Type: SAM; Serial: TP1561
- Measurement SW: DASY5, V5.2 Build 162; SEMCAD X Version 14.0 Build 59

Configuration/System Check GSM835 Body/Area Scan (8x16x1): Measurement grid: dx=10mm, dy=10mm, Maximum value of SAR (measured) = 2.49 mW/g

Configuration/System Check GSM835 Body/Zoom Scan (7x7x7)/Cube 0: Measurement grid: dx=5mm, dy=5mm, dz=5mm, Reference Value = 52.1 V/m; Power Drift = 0.027 dB

Peak SAR (extrapolated) = 3.68 W/kg

SAR(1 g) = 2.42 mW/g; SAR(10 g) = 1.56 mW/g Maximum value of SAR (measured) = 2.61 mW/g

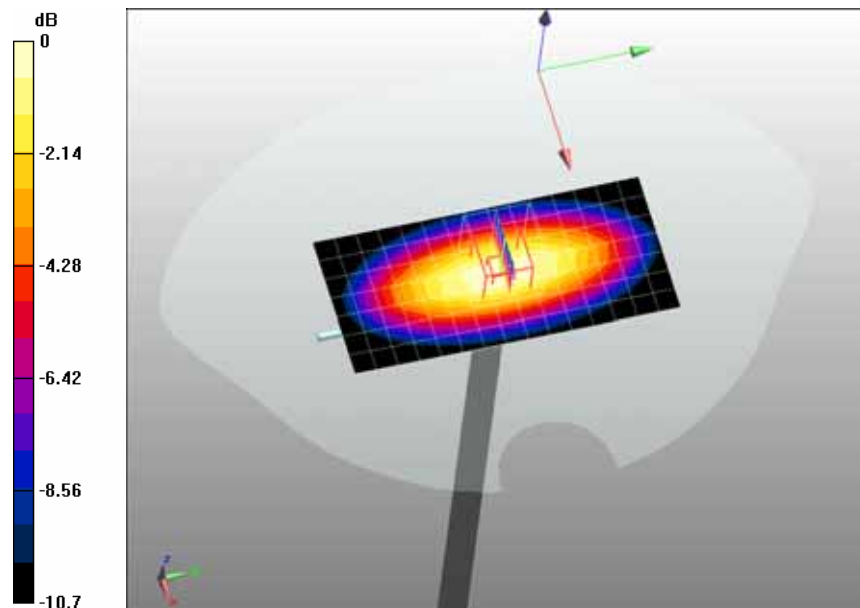

0 dB = 2.61mW/g

Date/Time: 29-12-2011

Test Laboratory: QuieTek Lab

System Check Head 1900MHz

DUT: Dipole 1900 MHz D1900V2; Type: D1900V2

Communication System: CW; Communication System Band: D1900 (1900.0 MHz); Duty Cycle: 1:1;

Frequency: 1900 MHz; Medium parameters used: $f = 1900$ MHz; $\sigma = 1.42$ mho/m; $\epsilon_r = 39.27$; $\rho = 1000$ kg/m³; Phantom section: Flat Section ; Input Power=250mW

Ambient temperature (°C): 21.5, Liquid temperature (°C): 21.0

DASY5 Configuration:

- Probe: EX3DV4 - SN3661; ConvF(8.68, 8.68, 8.68); Calibrated: 24/01/2011
- Sensor-Surface: 4mm (Mechanical Surface Detection)
- Electronics: DAE4 Sn915; Calibrated: 26/07/2011
- Phantom: SAM2; Type: SAM; Serial: TP1562
- Measurement SW: DASY5, V5.2 Build 162; SEMCAD X Version 14.0 Build 59

Configuration/System Check PCS1900 Head/Area Scan (6x11x1): Measurement grid: dx=10mm, dy=10mm

Maximum value of SAR (measured) = 11.1 mW/g

Configuration/System Check PCS1900 Head/Zoom Scan (7x7x7)/Cube 0: Measurement grid: dx=5mm, dy=5mm, dz=5mm, Reference Value = 90.8 V/m; Power Drift = -0.099 dB

Peak SAR (extrapolated) = 20 W/kg

SAR(1 g) = 10.5 mW/g; SAR(10 g) = 5.36 mW/g Maximum value of SAR (measured) = 12 mW/g

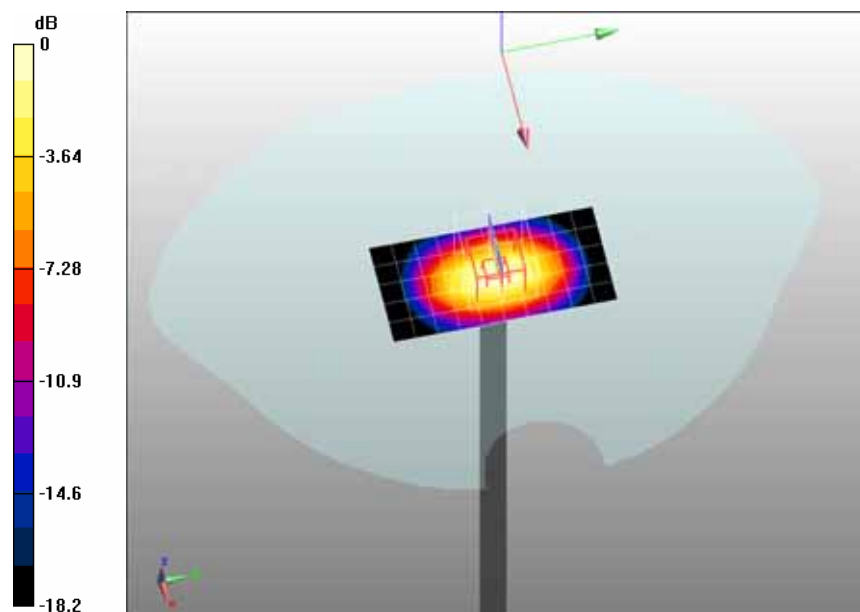

0 dB = 12mW/g

Date/Time: 29-12-2011

Test Laboratory: QuieTek Lab

System Check Body 1900MHz

DUT: Dipole 1900 MHz D1900V2; Type: D1900V2

Communication System: CW; Communication System Band: D1900 (1900.0 MHz); Duty Cycle: 1:1;

Frequency: 1900 MHz; Medium parameters used: $f = 1900$ MHz; $\sigma = 1.54$ mho/m; $\epsilon_r = 52.45$; $\rho = 1000$ kg/m³; Phantom section: Flat Section ; Input Power=250mW

Ambient temperature (°C): 21.5, Liquid temperature (°C): 21.0

DASY5 Configuration:

- Probe: EX3DV4 - SN3661; ConvF(7.72, 7.72, 7.72); Calibrated: 24/01/2011
- Sensor-Surface: 4mm (Mechanical Surface Detection)
- Electronics: DAE4 Sn915; Calibrated: 26/07/2011
- Phantom: SAM1; Type: SAM; Serial: TP1561
- Measurement SW: DASY5, V5.2 Build 162; SEMCAD X Version 14.0 Build 59

Configuration/System Check PCS1900 Body/Area Scan (7x11x1): Measurement grid: dx=10mm, dy=10mm

Maximum value of SAR (measured) = 12 mW/g

Configuration/System Check PCS1900 Body/Zoom Scan (7x7x7)/Cube 0: Measurement grid: dx=5mm, dy=5mm, dz=5mm, Reference Value = 88.6 V/m; Power Drift = 0.025 dB

Peak SAR (extrapolated) = 19.7 W/kg

SAR(1 g) = 10.6 mW/g; SAR(10 g) = 5.4 mW/g Maximum value of SAR (measured) = 12 mW/g

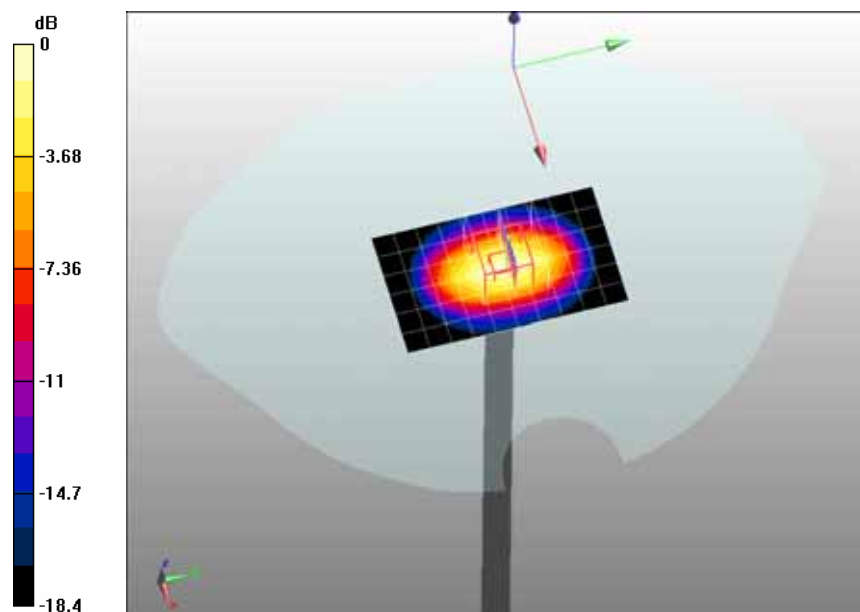

0 dB = 12mW/g

Appendix B. SAR measurement Data

Date/Time: 29-12-2011

Test Laboratory: QuieTek Lab

GSM850 Mid Touch-Left

DUT: GSM Mobile Phone ; Type: AM89

Communication System: Generic GSM; Communication System Band: GSM 850 (824.0 - 849.0 MHz); Duty Cycle: 1:8.3; Frequency: 836.4 MHz; Medium parameters used: $f = 836.4$ MHz; $\sigma = 0.91$ mho/m; $\epsilon_r = 42.3$; $\rho = 1000$ kg/m³ ; Phantom section: Left Section

Ambient temperature (°C): 21.5, Liquid temperature (°C): 21.0

DASY5 Configuration:

- Probe: EX3DV4 - SN3661; ConvF(9.58, 9.58, 9.58); Calibrated: 24/01/2011
- Sensor-Surface: 4mm (Mechanical Surface Detection)
- Electronics: DAE4 Sn915; Calibrated: 26/07/2011
- Phantom: SAM2; Type: SAM; Serial: TP1562
- Measurement SW: DASY5, V5.2 Build 162; SEMCAD X Version 14.0 Build 59

Configuration/GSM850 Mid Touch-Left/Area Scan (6x11x1): Measurement grid: dx=20mm, dy=20mm

Maximum value of SAR (measured) = 0.409 mW/g

Configuration/GSM850 Mid Touch-Left/Zoom Scan (5x5x7)/Cube 0: Measurement grid: dx=8mm,

dy=8mm, dz=5mm, Reference Value = 5.11 V/m; Power Drift = -0.130 dB

Peak SAR (extrapolated) = 0.649 W/kg

SAR(1 g) = 0.453 mW/g; SAR(10 g) = 0.293 mW/g Maximum value of SAR (measured) = 0.486 mW/g

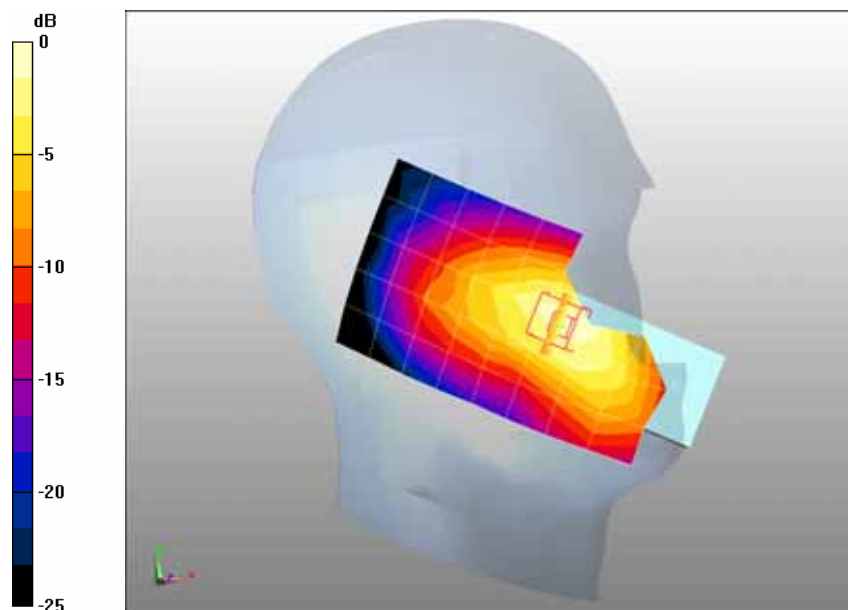

0 dB = 0.486mW/g

Date/Time: 29-12-2011

Test Laboratory: QuieTek Lab

GSM850 Mid Tilt-Left

DUT: GSM Mobile Phone ; Type: AM89

Communication System: Generic GSM; Communication System Band: GSM 850 (824.0 - 849.0 MHz); Duty Cycle: 1:8.3; Frequency: 836.4 MHz; Medium parameters used: $f = 836.4$ MHz; $\sigma = 0.91$ mho/m; $\epsilon_r = 42.3$; $\rho = 1000$ kg/m³ ; Phantom section: Left Section

Ambient temperature (°C): 21.5, Liquid temperature (°C): 21.0

DASY5 Configuration:

- Probe: EX3DV4 - SN3661; ConvF(9.58, 9.58, 9.58); Calibrated: 24/01/2011
- Sensor-Surface: 4mm (Mechanical Surface Detection)
- Electronics: DAE4 Sn915; Calibrated: 26/07/2011
- Phantom: SAM2; Type: SAM; Serial: TP1562
- Measurement SW: DASY5, V5.2 Build 162; SEMCAD X Version 14.0 Build 59

Configuration/GSM850 Mid Tilt-Left/Area Scan (6x11x1): Measurement grid: dx=20mm, dy=20mm

Maximum value of SAR (measured) = 0.119 mW/g

Configuration/GSM850 Mid Tilt-Left/Zoom Scan (5x5x7)/Cube 0: Measurement grid: dx=8mm, dy=8mm, dz=5mm, Reference Value = 6.37 V/m; Power Drift = -0.180 dB

Peak SAR (extrapolated) = 0.147 W/kg

SAR(1 g) = 0.113 mW/g; SAR(10 g) = 0.084 mW/g Maximum value of SAR (measured) = 0.119 mW/g

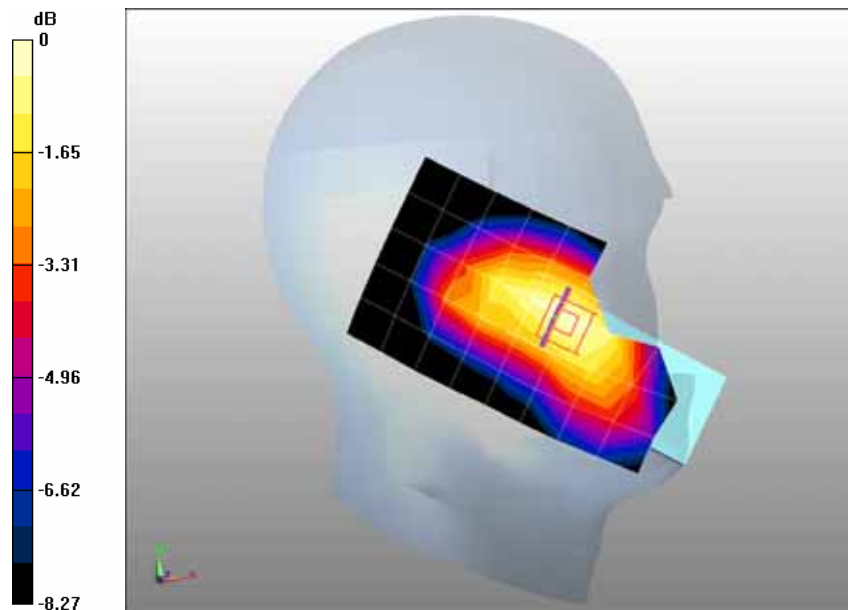

0 dB = 0.119mW/g

Date/Time: 29-12-2011

Test Laboratory: QuieTek Lab

GSM850 Mid Touch-Right

DUT: GSM Mobile Phone ; Type: AM89

Communication System: Generic GSM; Communication System Band: GSM 850 (824.0 - 849.0 MHz); Duty Cycle: 1:8.3; Frequency: 836.4 MHz; Medium parameters used: $f = 836.4$ MHz; $\sigma = 0.91$ mho/m; $\epsilon_r = 42.3$; $\rho = 1000$ kg/m³ ; Phantom section: Right Section

Ambient temperature (°C): 21.5, Liquid temperature (°C): 21.0

DASY5 Configuration:

- Probe: EX3DV4 - SN3661; ConvF(9.58, 9.58, 9.58); Calibrated: 24/01/2011
- Sensor-Surface: 4mm (Mechanical Surface Detection)
- Electronics: DAE4 Sn915; Calibrated: 26/07/2011
- Phantom: SAM2; Type: SAM; Serial: TP1562
- Measurement SW: DASY5, V5.2 Build 162; SEMCAD X Version 14.0 Build 59

Configuration/GSM850 Mid Touch-Right/Area Scan (6x11x1): Measurement grid: dx=20mm, dy=20mm

Maximum value of SAR (measured) = 0.555 mW/g

Configuration/GSM850 Mid Touch-Right/Zoom Scan (5x5x7)/Cube 0: Measurement grid: dx=8mm, dy=8mm, dz=5mm, Reference Value = 4.84 V/m; Power Drift = -0.142 dB

Peak SAR (extrapolated) = 0.892 W/kg

SAR(1 g) = 0.590 mW/g; SAR(10 g) = 0.374 mW/g Maximum value of SAR (measured) = 0.627 mW/g

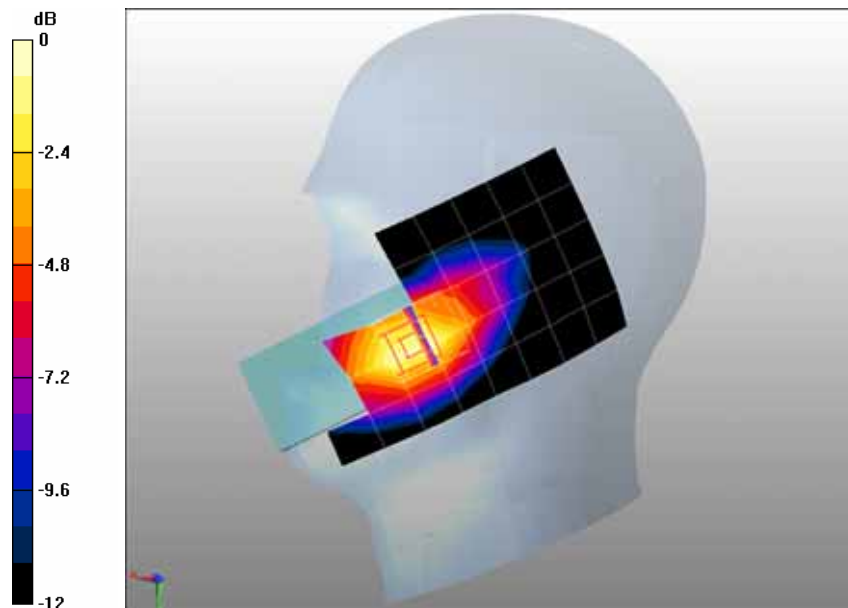

0 dB = 0.627mW/g

Z-Axis Plot

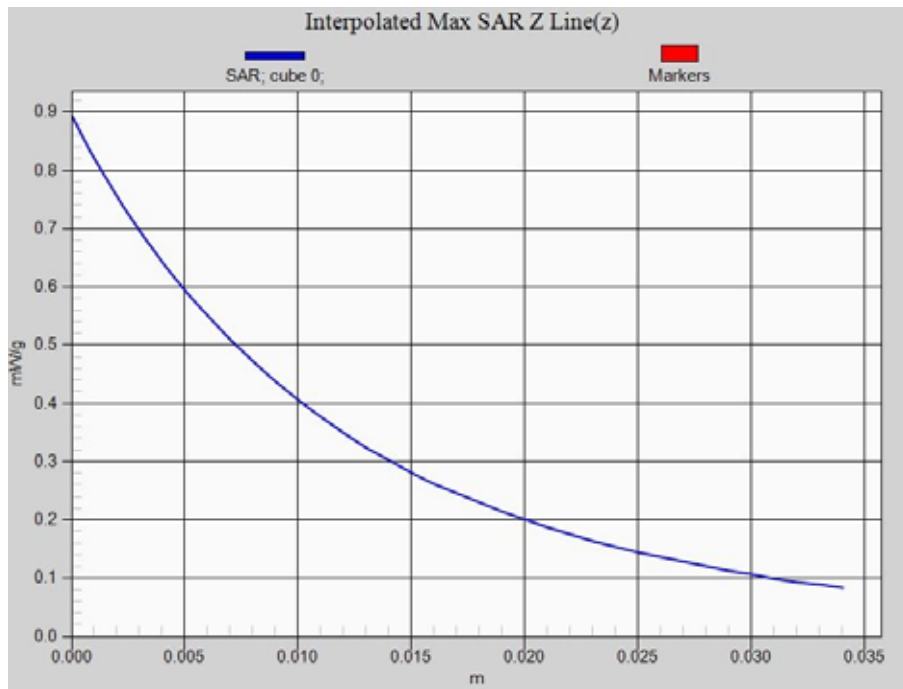

Date/Time: 29-12-2011

Test Laboratory: QuieTek Lab

GSM850 Mid Tilt-Right

DUT: GSM Mobile Phone ; Type: AM89

Communication System: Generic GSM; Communication System Band: GSM 850 (824.0 - 849.0 MHz); Duty Cycle: 1:8.3; Frequency: 836.4 MHz; Medium parameters used: $f = 836.4$ MHz; $\sigma = 0.91$ mho/m; $\epsilon_r = 42.3$; $\rho = 1000$ kg/m³ ; Phantom section: Right Section

Ambient temperature (°C): 21.5, Liquid temperature (°C): 21.0

DASY5 Configuration:

- Probe: EX3DV4 - SN3661; ConvF(9.58, 9.58, 9.58); Calibrated: 24/01/2011
- Sensor-Surface: 4mm (Mechanical Surface Detection)
- Electronics: DAE4 Sn915; Calibrated: 26/07/2011
- Phantom: SAM2; Type: SAM; Serial: TP1562
- Measurement SW: DASY5, V5.2 Build 162; SEMCAD X Version 14.0 Build 59

Configuration/GSM850 Mid Tilt-Right/Area Scan (6x11x1): Measurement grid: dx=20mm, dy=20mm

Maximum value of SAR (measured) = 0.123 mW/g

Configuration/GSM850 Mid Tilt-Right/Zoom Scan (5x5x7)/Cube 0: Measurement grid: dx=8mm, dy=8mm, dz=5mm, Reference Value = 6.01 V/m; Power Drift = -0.193 dB

Peak SAR (extrapolated) = 0.155 W/kg

SAR(1 g) = 0.118 mW/g; SAR(10 g) = 0.088 mW/g Maximum value of SAR (measured) = 0.123 mW/g

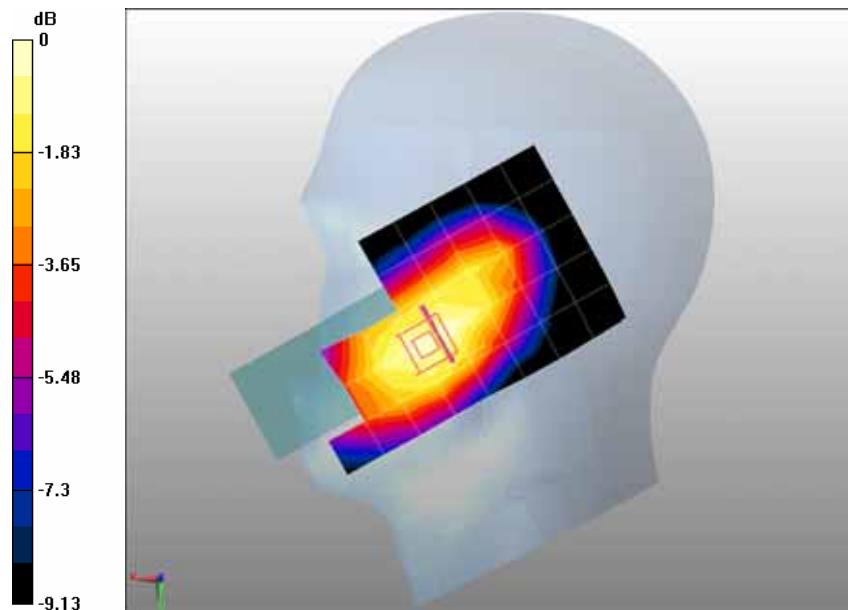

0 dB = 0.123mW/g

Date/Time: 29-12-2011

Test Laboratory: QuieTek Lab

GSM850 Mid Touch-Right <SIM 2>

DUT: GSM Mobile Phone ; Type: AM89

Communication System: Generic GSM; Communication System Band: GSM 850 (824.0 - 849.0 MHz); Duty Cycle: 1:8.3; Frequency: 836.4 MHz; Medium parameters used: $f = 836.4$ MHz; $\sigma = 0.91$ mho/m; $\epsilon_r = 42.3$; $\rho = 1000$ kg/m³ ; Phantom section: Right Section

Ambient temperature (°C): 21.5, Liquid temperature (°C): 21.0

DASY5 Configuration:

- Probe: EX3DV4 - SN3661; ConvF(9.58, 9.58, 9.58); Calibrated: 24/01/2011
- Sensor-Surface: 4mm (Mechanical Surface Detection)
- Electronics: DAE4 Sn915; Calibrated: 26/07/2011
- Phantom: SAM2; Type: SAM; Serial: TP1562
- Measurement SW: DASY5, V5.2 Build 162; SEMCAD X Version 14.0 Build 59

Configuration/GSM850 Mid Touch-Right/Area Scan (6x11x1): Measurement grid: dx=20mm, dy=20mm

Maximum value of SAR (measured) = 0.481 mW/g

Configuration/GSM850 Mid Touch-Right/Zoom Scan (5x5x7)/Cube 0: Measurement grid: dx=8mm, dy=8mm, dz=5mm, Reference Value = 4.58 V/m; Power Drift = -0.157 dB

Peak SAR (extrapolated) = 0.798 W/kg

SAR(1 g) = 0.520 mW/g; SAR(10 g) = 0.328 mW/g Maximum value of SAR (measured) = 0.563 mW/g

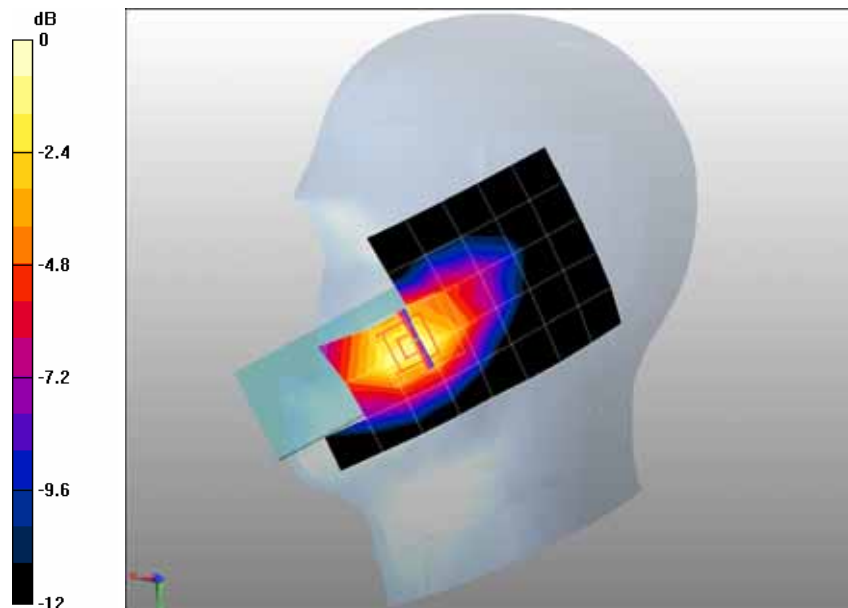

0 dB = 0.563mW/g

Date/Time: 29-12-2011

Test Laboratory: QuieTek Lab

GSM850 Mid Body-Back

DUT: GSM Mobile Phone ; Type: AM89

Communication System: Generic GSM; Communication System Band: GSM 850 (824.0 - 849.0 MHz); Duty Cycle: 1:8.3; Frequency: 836.4 MHz; Medium parameters used: $f = 836.4$ MHz; $\sigma = 0.98$ mho/m; $\epsilon_r = 54.7$; $\rho = 1000$ kg/m³ ; Phantom section: Flat Section

Ambient temperature (°C): 21.5, Liquid temperature (°C): 21.0

DASY5 Configuration:

- Probe: EX3DV4 - SN3661; ConvF(9.58, 9.58, 9.58); Calibrated: 24/01/2011
- Sensor-Surface: 4mm (Mechanical Surface Detection)
- Electronics: DAE4 Sn915; Calibrated: 26/07/2011
- Phantom: SAM1; Type: SAM; Serial: TP1561
- Measurement SW: DASY5, V5.2 Build 162; SEMCAD X Version 14.0 Build 59

Configuration/GSM850 Mid Body-Back/Area Scan (6x9x1): Measurement grid: dx=20mm, dy=20mm

Maximum value of SAR (measured) = 0.301 mW/g

Configuration/GSM850 Mid Body-Back/Zoom Scan (5x5x7)/Cube 0: Measurement grid: dx=8mm, dy=8mm, dz=5mm, Reference Value = 13.9 V/m; Power Drift = 0.022 dB

Peak SAR (extrapolated) = 0.399 W/kg

SAR(1 g) = 0.284 mW/g; SAR(10 g) = 0.196 mW/g Maximum value of SAR (measured) = 0.299 mW/g

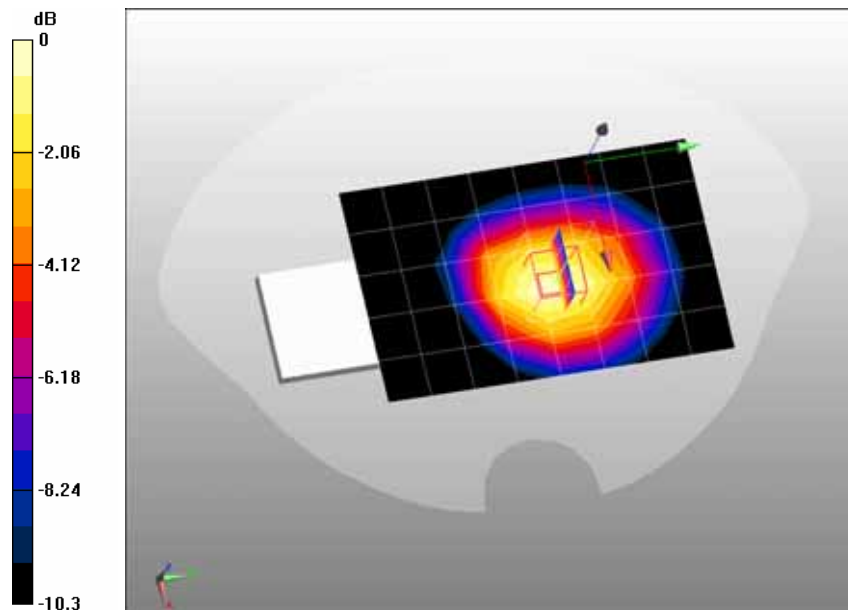

0 dB = 0.299mW/g

Date/Time: 29-12-2011

Test Laboratory: QuieTek Lab

GPRS850 Mid Body-Back(2up)

DUT: GSM Mobile Phone ; Type: AM89

Communication System: GPRS/EGPRS-2 Slot; Communication System Band: GSM850; Duty Cycle: 1:4.2 ;
 Frequency: 836.4 MHz; Medium parameters used: $f = 836.4 \text{ MHz}$; $\sigma = 0.98 \text{ mho/m}$; $\epsilon_r = 54.7$; $\rho = 1000 \text{ kg/m}^3$; Phantom section: Flat Section

Ambient temperature (°C): 21.5, Liquid temperature (°C): 21.0

DASY5 Configuration:

- Probe: EX3DV4 - SN3661; ConvF(9.58, 9.58, 9.58); Calibrated: 24/01/2011
- Sensor-Surface: 4mm (Mechanical Surface Detection)
- Electronics: DAE4 Sn915; Calibrated: 26/07/2011
- Phantom: SAM1; Type: SAM; Serial: TP1561
- Measurement SW: DASY5, V5.2 Build 162; SEMCAD X Version 14.0 Build 59

Configuration/GPRS850 Mid Body-Back/Area Scan (6x11x1): Measurement grid: dx=20mm, dy=20mm

Maximum value of SAR (measured) = 0.607 mW/g

Configuration/GPRS850 Mid Body-Back/Zoom Scan (5x5x7)/Cube 0: Measurement grid: dx=8mm, dy=8mm, dz=5mm, Reference Value = 20.5 V/m; Power Drift = -0.117 dB

Peak SAR (extrapolated) = 0.791 W/kg

SAR(1 g) = 0.565 mW/g; SAR(10 g) = 0.391 mW/g Maximum value of SAR (measured) = 0.598 mW/g

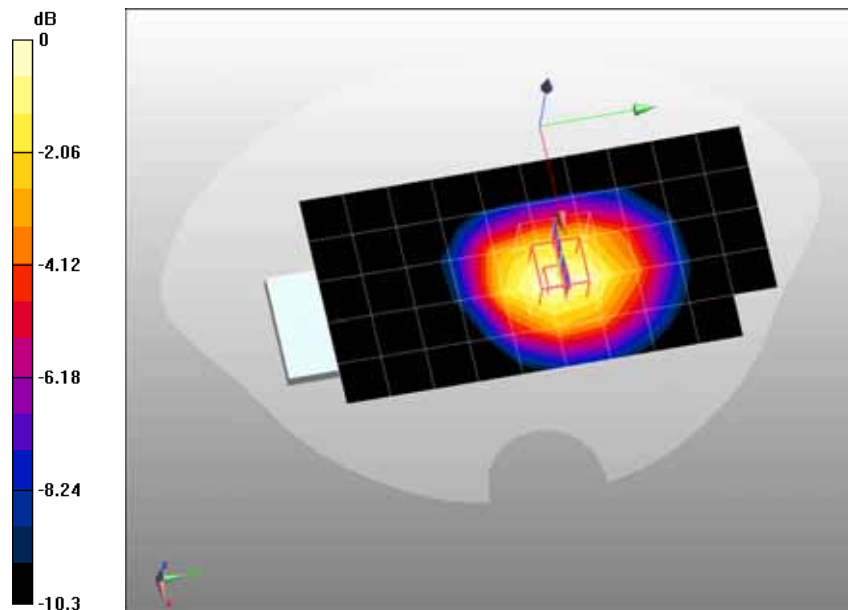

0 dB = 0.598mW/g

Date/Time: 29-12-2011

Test Laboratory: QuieTek Lab

GPRS850 Mid Body-Front(2up)

DUT: GSM Mobile Phone ; Type: AM89

Communication System: GPRS/EGPRS-2 Slot; Communication System Band: GSM850; Duty Cycle: 1:4.2 ;
 Frequency: 836.4 MHz; Medium parameters used: $f = 836.4$ MHz; $\sigma = 0.98$ mho/m; $\epsilon_r = 54.7$; $\rho = 1000$
 kg/m³ ; Phantom section: Flat Section

Ambient temperature (°C): 21.5, Liquid temperature (°C): 21.0

DASY5 Configuration:

- Probe: EX3DV4 - SN3661; ConvF(9.58, 9.58, 9.58); Calibrated: 24/01/2011
- Sensor-Surface: 4mm (Mechanical Surface Detection)
- Electronics: DAE4 Sn915; Calibrated: 26/07/2011
- Phantom: SAM1; Type: SAM; Serial: TP1561
- Measurement SW: DASY5, V5.2 Build 162; SEMCAD X Version 14.0 Build 59

Configuration/GPRS850 Mid Body-Front/Area Scan (6x11x1): Measurement grid: dx=20mm, dy=20mm

Maximum value of SAR (measured) = 0.312 mW/g

Configuration/GPRS850 Mid Body-Front/Zoom Scan (5x5x7)/Cube 0: Measurement grid: dx=8mm, dy=8mm, dz=5mm, Reference Value = 15.8 V/m; Power Drift = -0.123 dB

Peak SAR (extrapolated) = 0.413 W/kg

SAR(1 g) = 0.298 mW/g; SAR(10 g) = 0.206 mW/g Maximum value of SAR (measured) = 0.317 mW/g

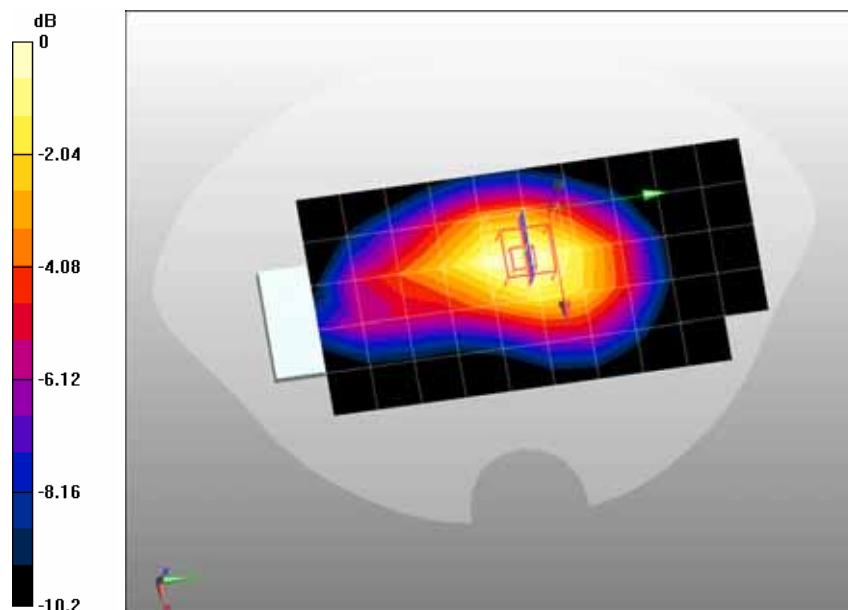

0 dB = 0.317mW/g

Date/Time: 29-12-2011

Test Laboratory: QuieTek Lab

GPRS850 Mid Body-Back(2up)(With headset)

DUT: GSM Mobile Phone ; Type: AM89

Communication System: GPRS/EGPRS-2 Slot; Communication System Band: GSM850; Duty Cycle: 1:4.2 ;
 Frequency: 836.4 MHz; Medium parameters used: $f = 836.4$ MHz; $\sigma = 0.98$ mho/m; $\epsilon_r = 54.7$; $\rho = 1000$ kg/m³ ; Phantom section: Flat Section

Ambient temperature (°C): 21.5, Liquid temperature (°C): 21.0

DASY5 Configuration:

- Probe: EX3DV4 - SN3661; ConvF(9.58, 9.58, 9.58); Calibrated: 24/01/2011
- Sensor-Surface: 4mm (Mechanical Surface Detection)
- Electronics: DAE4 Sn915; Calibrated: 26/07/2011
- Phantom: SAM1; Type: SAM; Serial: TP1561
- Measurement SW: DASY5, V5.2 Build 162; SEMCAD X Version 14.0 Build 59

Configuration/GPRS850 Mid Body-Back/Area Scan (6x11x1): Measurement grid: dx=20mm, dy=20mm

Maximum value of SAR (measured) = 0.465 mW/g

Configuration/GPRS850 Mid Body-Back/Zoom Scan (5x5x7)/Cube 0: Measurement grid: dx=8mm, dy=8mm, dz=5mm, Reference Value = 18 V/m; Power Drift = -0.047 dB

Peak SAR (extrapolated) = 0.611 W/kg

SAR(1 g) = 0.437 mW/g; SAR(10 g) = 0.302 mW/g Maximum value of SAR (measured) = 0.463 mW/g

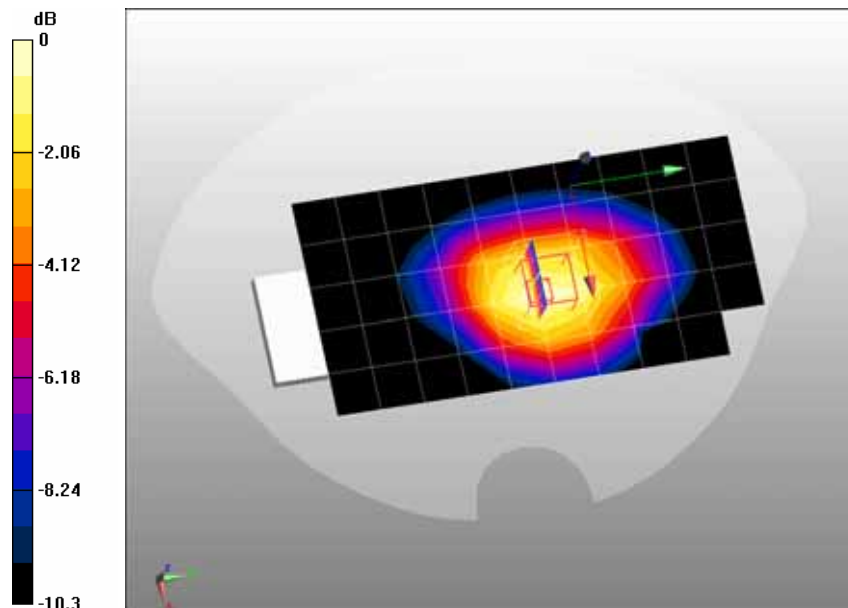

0 dB = 0.463mW/g

Date/Time: 29-12-2011

Test Laboratory: QuieTek Lab

PCS1900 Low Touch-Left

DUT: GSM Mobile Phone ; Type: AM89

Communication System: Generic GSM; Communication System Band: PCS 1900 (1850.0 - 1910.0 MHz);
 Duty Cycle: 1:8.3; Frequency: 1850.2 MHz; Medium parameters used: $f = 1850.2$ MHz; $\sigma = 1.4$ mho/m; $\epsilon_r = 39.5$; $\rho = 1000$ kg/m³ ; Phantom section: Left Section

Ambient temperature (°C): 21.5, Liquid temperature (°C): 21.0

DASY5 Configuration:

- Probe: EX3DV4 - SN3661; ConvF(8.68, 8.68, 8.68); Calibrated: 24/01/2011
- Sensor-Surface: 4mm (Mechanical Surface Detection)
- Electronics: DAE4 Sn915; Calibrated: 26/07/2011
- Phantom: SAM2; Type: SAM; Serial: TP1562
- Measurement SW: DASY5, V5.2 Build 162; SEMCAD X Version 14.0 Build 59

Configuration/PCS1900 Low Touch-Left/Area Scan (6x12x1): Measurement grid: dx=20mm, dy=20mm

Maximum value of SAR (measured) = 0.977 mW/g

Configuration/PCS1900 Low Touch-Left/Zoom Scan (5x5x7)/Cube 0: Measurement grid: dx=8mm, dy=8mm, dz=5mm, Reference Value = 13.4 V/m; Power Drift = -0.080 dB

Peak SAR (extrapolated) = 2.25 W/kg

SAR(1 g) = 1.31 mW/g; SAR(10 g) = 0.680 mW/g Maximum value of SAR (measured) = 1.39 mW/g

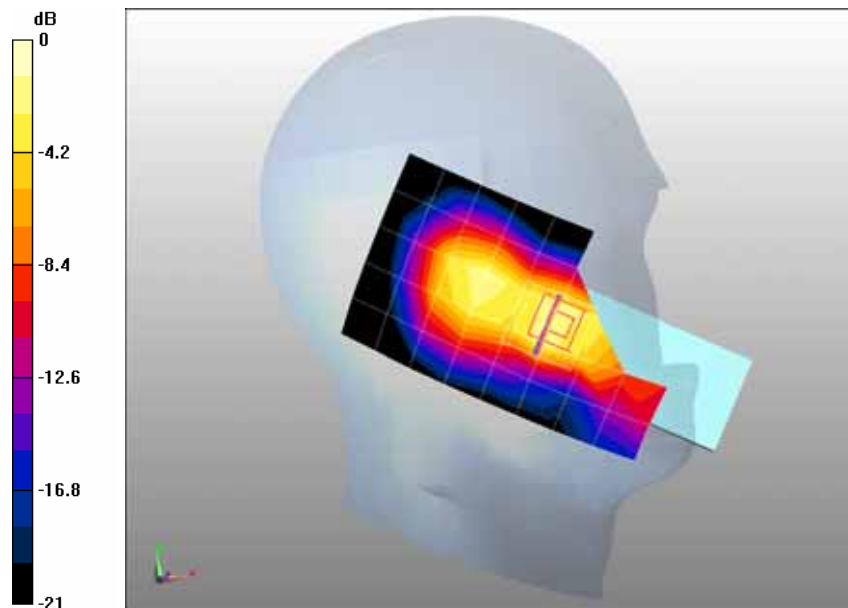

0 dB = 1.39mW/g

Date/Time: 29-12-2011

Test Laboratory: QuieTek Lab

PCS1900 Mid Touch-Left

DUT: GSM Mobile Phone ; Type: AM89

Communication System: Generic GSM; Communication System Band: PCS 1900 (1850.0 - 1910.0 MHz);
 Duty Cycle: 1:8.3; Frequency: 1880 MHz; Medium parameters used: $f = 1880$ MHz; $\sigma = 1.41$ mho/m; $\epsilon_r = 39.4$; $\rho = 1000$ kg/m³ ; Phantom section: Left Section

Ambient temperature (°C): 21.5, Liquid temperature (°C): 21.0

DASY5 Configuration:

- Probe: EX3DV4 - SN3661; ConvF(8.68, 8.68, 8.68); Calibrated: 24/01/2011
- Sensor-Surface: 4mm (Mechanical Surface Detection)
- Electronics: DAE4 Sn915; Calibrated: 26/07/2011
- Phantom: SAM2; Type: SAM; Serial: TP1562
- Measurement SW: DASY5, V5.2 Build 162; SEMCAD X Version 14.0 Build 59

Configuration/PCS1900 Mid Touch-Left/Area Scan (6x12x1): Measurement grid: dx=20mm, dy=20mm

Maximum value of SAR (measured) = 1.13 mW/g

Configuration/PCS1900 Mid Touch-Left/Zoom Scan (5x5x7)/Cube 0: Measurement grid: dx=8mm, dy=8mm, dz=5mm, Reference Value = 14.2 V/m; Power Drift = -0.172 dB

Peak SAR (extrapolated) = 2.23 W/kg

SAR(1 g) = 1.32 mW/g; SAR(10 g) = 0.688 mW/g Maximum value of SAR (measured) = 1.45 mW/g

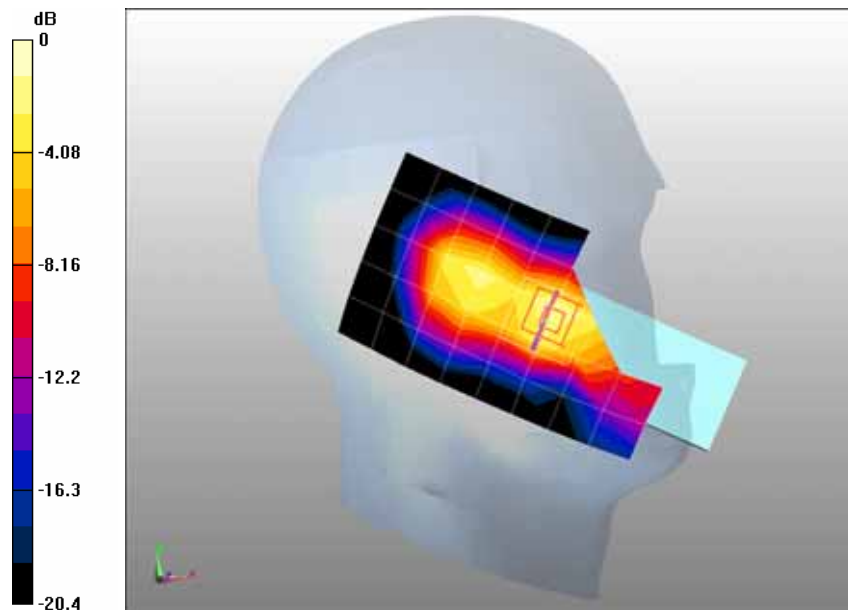

0 dB = 1.45mW/g

Date/Time: 29-12-2011

Test Laboratory: QuieTek Lab

PCS1900 High Touch-Left

DUT: GSM Mobile Phone ; Type: AM89

Communication System: Generic GSM; Communication System Band: PCS 1900 (1850.0 - 1910.0 MHz);
 Duty Cycle: 1:8.3; Frequency: 1909.8 MHz; Medium parameters used: $f = 1909.8$ MHz; $\sigma = 1.43$ mho/m; $\epsilon_r = 39.2$; $\rho = 1000$ kg/m³ ; Phantom section: Left Section

Ambient temperature (°C): 21.5, Liquid temperature (°C): 21.0

DASY5 Configuration:

- Probe: EX3DV4 - SN3661; ConvF(8.68, 8.68, 8.68); Calibrated: 24/01/2011
- Sensor-Surface: 4mm (Mechanical Surface Detection)
- Electronics: DAE4 Sn915; Calibrated: 26/07/2011
- Phantom: SAM2; Type: SAM; Serial: TP1562
- Measurement SW: DASY5, V5.2 Build 162; SEMCAD X Version 14.0 Build 59

Configuration/PCS1900 High Touch-Left/Area Scan (6x12x1): Measurement grid: dx=20mm, dy=20mm

Maximum value of SAR (measured) = 0.963 mW/g

Configuration/PCS1900 High Touch-Left/Zoom Scan (5x5x7)/Cube 0: Measurement grid: dx=8mm, dy=8mm, dz=5mm, Reference Value = 13 V/m; Power Drift = -0.001 dB

Peak SAR (extrapolated) = 2.39 W/kg

SAR(1 g) = 1.35 mW/g; SAR(10 g) = 0.692 mW/g Maximum value of SAR (measured) = 1.46 mW/g

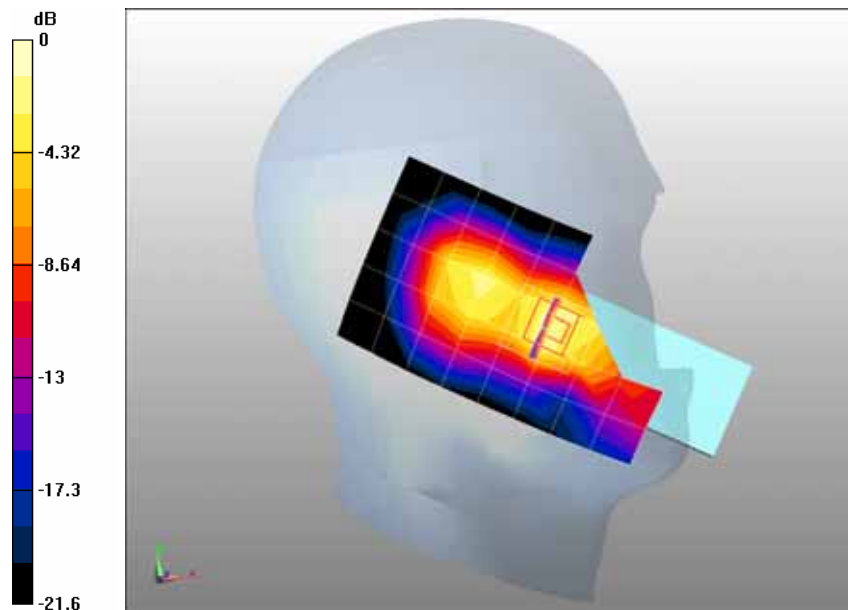

0 dB = 1.46mW/g

Date/Time: 29-12-2011

Test Laboratory: QuieTek Lab

PCS1900 Mid Tilt-Left

DUT: GSM Mobile Phone ; Type: AM89

Communication System: Generic GSM; Communication System Band: PCS 1900 (1850.0 - 1910.0 MHz);
 Duty Cycle: 1:8.3; Frequency: 1880 MHz; Medium parameters used: $f = 1880$ MHz; $\sigma = 1.41$ mho/m; $\epsilon_r = 39.4$; $\rho = 1000$ kg/m³ ; Phantom section: Left Section

Ambient temperature (°C): 21.5, Liquid temperature (°C): 21.0

DASY5 Configuration:

- Probe: EX3DV4 - SN3661; ConvF(8.68, 8.68, 8.68); Calibrated: 24/01/2011
- Sensor-Surface: 4mm (Mechanical Surface Detection)
- Electronics: DAE4 Sn915; Calibrated: 26/07/2011
- Phantom: SAM2; Type: SAM; Serial: TP1562
- Measurement SW: DASY5, V5.2 Build 162; SEMCAD X Version 14.0 Build 59

Configuration/PCS1900 Mid Tilt-Left/Area Scan (6x12x1): Measurement grid: dx=20mm, dy=20mm

Maximum value of SAR (measured) = 0.669 mW/g

Configuration/PCS1900 Mid Tilt-Left/Zoom Scan (5x5x7)/Cube 0: Measurement grid: dx=8mm, dy=8mm, dz=5mm, Reference Value = 15.4 V/m; Power Drift = -0.098 dB

Peak SAR (extrapolated) = 1.15 W/kg

SAR(1 g) = 0.725 mW/g; SAR(10 g) = 0.428 mW/g Maximum value of SAR (measured) = 0.771 mW/g

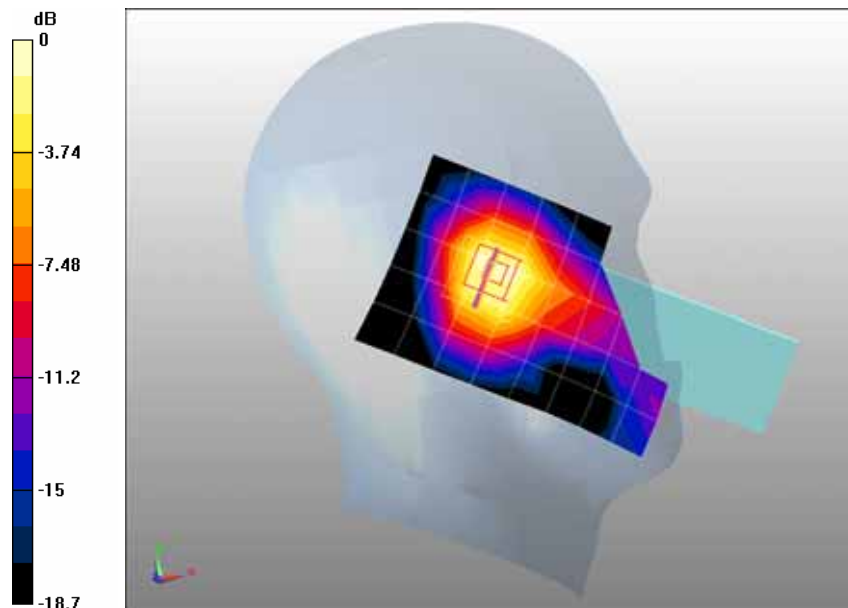

0 dB = 0.771mW/g

Date/Time: 29-12-2011

Test Laboratory: QuieTek Lab

PCS1900 Low Touch-Right

DUT: GSM Mobile Phone ; Type: AM89

Communication System: Generic GSM; Communication System Band: PCS 1900 (1850.0 - 1910.0 MHz);
 Duty Cycle: 1:8.3; Frequency: 1850.2 MHz; Medium parameters used: $f = 1850.2$ MHz; $\sigma = 1.4$ mho/m; $\epsilon_r = 39.5$; $\rho = 1000$ kg/m³ ; Phantom section: Right Section

Ambient temperature (°C): 21.5, Liquid temperature (°C): 21.0

DASY5 Configuration:

- Probe: EX3DV4 - SN3661; ConvF(8.68, 8.68, 8.68); Calibrated: 24/01/2011
- Sensor-Surface: 4mm (Mechanical Surface Detection)
- Electronics: DAE4 Sn915; Calibrated: 26/07/2011
- Phantom: SAM2; Type: SAM; Serial: TP1562
- Measurement SW: DASY5, V5.2 Build 162; SEMCAD X Version 14.0 Build 59

Configuration/PCS1900 Low Touch-Right/Area Scan (6x12x1): Measurement grid: dx=20mm, dy=20mm

Maximum value of SAR (measured) = 1.03 mW/g

Configuration/PCS1900 Low Touch-Right/Zoom Scan (5x5x7)/Cube 0: Measurement grid: dx=8mm, dy=8mm, dz=5mm, Reference Value = 14.6 V/m; Power Drift = -0.082 dB

Peak SAR (extrapolated) = 2.43 W/kg

SAR(1 g) = 1.41 mW/g; SAR(10 g) = 0.738 mW/g Maximum value of SAR (measured) = 1.58 mW/g

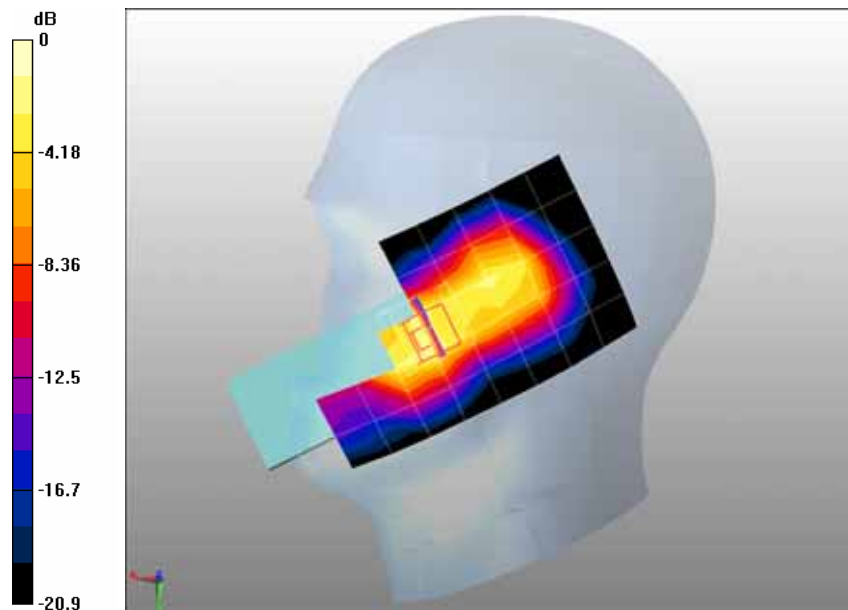

0 dB = 1.58mW/g

Date/Time: 29-12-2011

Test Laboratory: QuieTek Lab

PCS1900 Mid Touch-Right

DUT: GSM Mobile Phone ; Type: AM89

Communication System: Generic GSM; Communication System Band: PCS 1900 (1850.0 - 1910.0 MHz);
 Duty Cycle: 1:8.3; Frequency: 1880 MHz; Medium parameters used: $f = 1880$ MHz; $\sigma = 1.41$ mho/m; $\epsilon_r = 39.4$; $\rho = 1000$ kg/m³ ; Phantom section: Right Section

Ambient temperature (°C): 21.5, Liquid temperature (°C): 21.0

DASY5 Configuration:

- Probe: EX3DV4 - SN3661; ConvF(8.68, 8.68, 8.68); Calibrated: 24/01/2011
- Sensor-Surface: 4mm (Mechanical Surface Detection)
- Electronics: DAE4 Sn915; Calibrated: 26/07/2011
- Phantom: SAM2; Type: SAM; Serial: TP1562
- Measurement SW: DASY5, V5.2 Build 162; SEMCAD X Version 14.0 Build 59

Configuration/PCS1900 Mid Touch-Right/Area Scan (6x12x1): Measurement grid: dx=20mm, dy=20mm

Maximum value of SAR (measured) = 0.960 mW/g

Configuration/PCS1900 Mid Touch-Right/Zoom Scan (5x5x7)/Cube 0: Measurement grid: dx=8mm, dy=8mm, dz=5mm, Reference Value = 10.7 V/m; Power Drift = 0.045 dB

Peak SAR (extrapolated) = 2.38 W/kg

SAR(1 g) = 1.36 mW/g; SAR(10 g) = 0.701 mW/g Maximum value of SAR (measured) = 1.56 mW/g

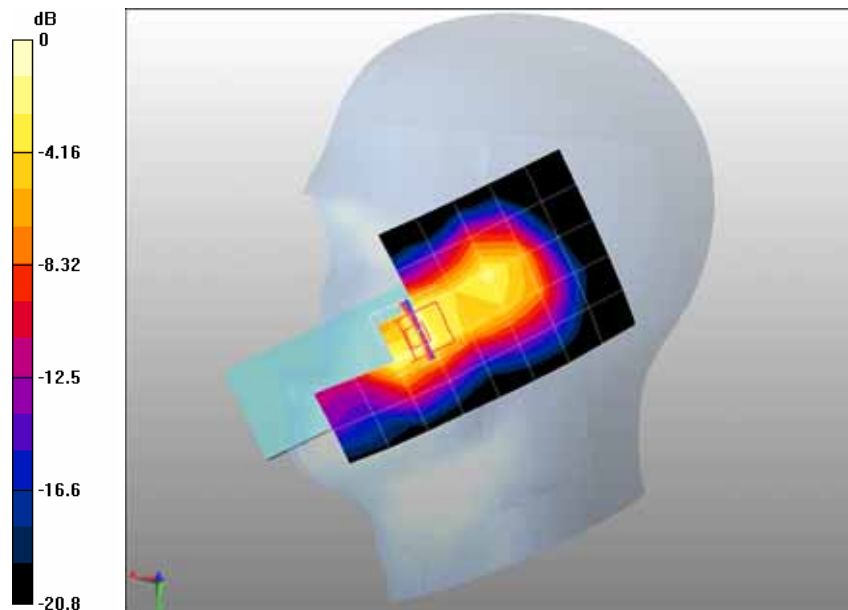

0 dB = 1.56mW/g

Date/Time: 29-12-2011

Test Laboratory: QuieTek Lab

PCS1900 High Touch-Right

DUT: GSM Mobile Phone ; Type: AM89

Communication System: Generic GSM; Communication System Band: PCS 1900 (1850.0 - 1910.0 MHz);
 Duty Cycle: 1:8.3; Frequency: 1909.8 MHz; Medium parameters used: $f = 1909.8$ MHz; $\sigma = 1.43$ mho/m; $\epsilon_r = 39.2$; $\rho = 1000$ kg/m³ ; Phantom section: Right Section

Ambient temperature (°C): 21.5, Liquid temperature (°C): 21.0

DASY5 Configuration:

- Probe: EX3DV4 - SN3661; ConvF(8.68, 8.68, 8.68); Calibrated: 24/01/2011
- Sensor-Surface: 4mm (Mechanical Surface Detection)
- Electronics: DAE4 Sn915; Calibrated: 26/07/2011
- Phantom: SAM2; Type: SAM; Serial: TP1562
- Measurement SW: DASY5, V5.2 Build 162; SEMCAD X Version 14.0 Build 59

Configuration/PCS1900 High Touch-Right/Area Scan (6x12x1): Measurement grid: dx=20mm, dy=20mm

Maximum value of SAR (measured) = 1.05 mW/g

Configuration/PCS1900 High Touch-Right/Zoom Scan (5x5x7)/Cube 0: Measurement grid: dx=8mm, dy=8mm, dz=5mm, Reference Value = 14.4 V/m; Power Drift = 0.022 dB

Peak SAR (extrapolated) = 2.65 W/kg

SAR(1 g) = 1.47 mW/g; SAR(10 g) = 0.760 mW/g Maximum value of SAR (measured) = 1.67 mW/g

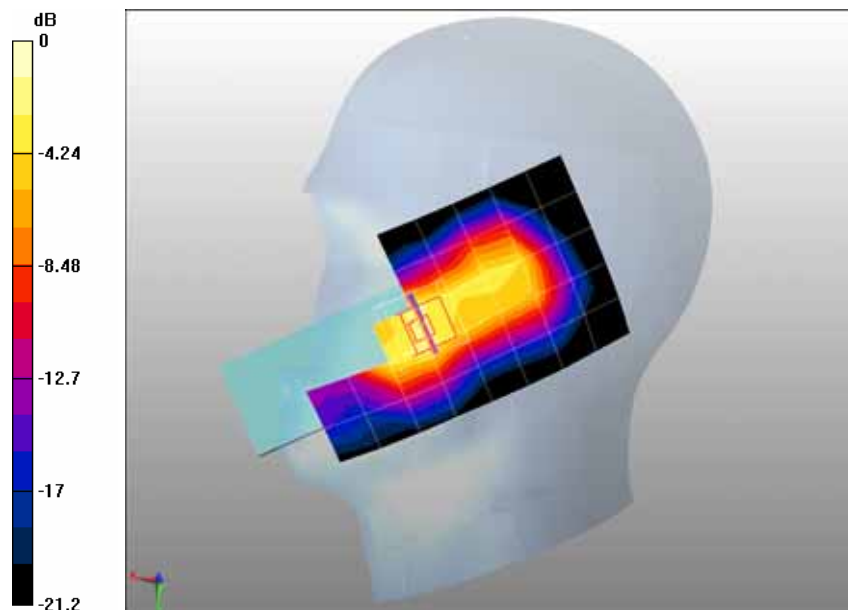

0 dB = 1.67mW/g

Z-Axis Plot

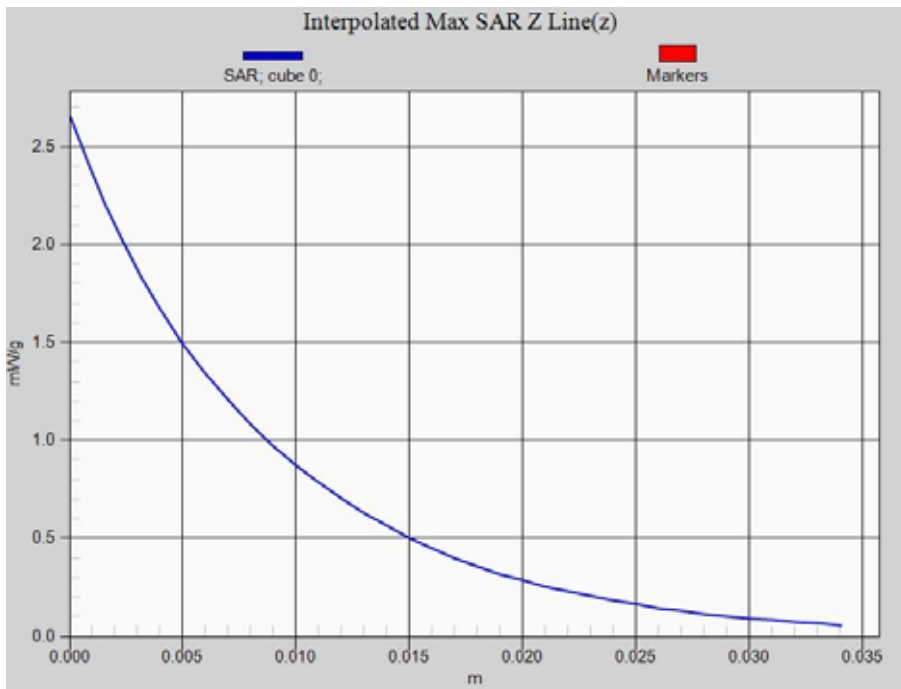

Date/Time: 29-12-2011

Test Laboratory: QuieTek Lab

PCS1900 Mid Tilt-Right

DUT: GSM Mobile Phone ; Type: AM89

Communication System: Generic GSM; Communication System Band: PCS 1900 (1850.0 - 1910.0 MHz);
 Duty Cycle: 1:8.3; Frequency: 1880 MHz; Medium parameters used: $f = 1880$ MHz; $\sigma = 1.41$ mho/m; $\epsilon_r = 39.4$; $\rho = 1000$ kg/m³ ; Phantom section: Right Section

Ambient temperature (°C): 21.5, Liquid temperature (°C): 21.0

DASY5 Configuration:

- Probe: EX3DV4 - SN3661; ConvF(8.68, 8.68, 8.68); Calibrated: 24/01/2011
- Sensor-Surface: 4mm (Mechanical Surface Detection)
- Electronics: DAE4 Sn915; Calibrated: 26/07/2011
- Phantom: SAM2; Type: SAM; Serial: TP1562
- Measurement SW: DASY5, V5.2 Build 162; SEMCAD X Version 14.0 Build 59

Configuration/PCS1900 Mid Tilt-Right/Area Scan (6x12x1): Measurement grid: dx=20mm, dy=20mm

Maximum value of SAR (measured) = 0.630 mW/g

Configuration/PCS1900 Mid Tilt-Right/Zoom Scan (5x5x7)/Cube 0: Measurement grid: dx=8mm, dy=8mm, dz=5mm, Reference Value = 13 V/m; Power Drift = -0.065 dB

Peak SAR (extrapolated) = 1.01 W/kg

SAR(1 g) = 0.664 mW/g; SAR(10 g) = 0.402 mW/g Maximum value of SAR (measured) = 0.704 mW/g

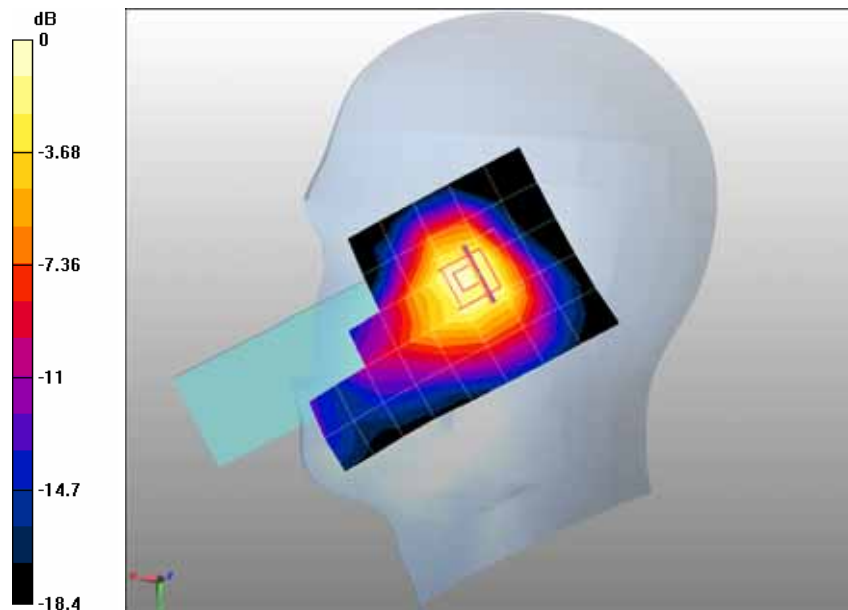

0 dB = 0.704mW/g

Date/Time: 29-12-2011

Test Laboratory: QuieTek Lab

PCS1900 Mid Touch-Right <SIM 2>

DUT: GSM Mobile Phone ; Type: AM89

Communication System: Generic GSM; Communication System Band: PCS 1900 (1850.0 - 1910.0 MHz);
 Duty Cycle: 1:8.3; Frequency: 1880 MHz; Medium parameters used: $f = 1880$ MHz; $\sigma = 1.41$ mho/m; $\epsilon_r = 39.4$; $\rho = 1000$ kg/m³ ; Phantom section: Right Section

Ambient temperature (°C): 21.5, Liquid temperature (°C): 21.0

DASY5 Configuration:

- Probe: EX3DV4 - SN3661; ConvF(8.68, 8.68, 8.68); Calibrated: 24/01/2011
- Sensor-Surface: 4mm (Mechanical Surface Detection)
- Electronics: DAE4 Sn915; Calibrated: 26/07/2011
- Phantom: SAM2; Type: SAM; Serial: TP1562
- Measurement SW: DASY5, V5.2 Build 162; SEMCAD X Version 14.0 Build 59

Configuration/PCS1900 Mid Touch-Right/Area Scan (6x12x1): Measurement grid: dx=20mm, dy=20mm

Maximum value of SAR (measured) = 0.964 mW/g

Configuration/PCS1900 Mid Touch-Right/Zoom Scan (5x5x7)/Cube 0: Measurement grid: dx=8mm, dy=8mm, dz=5mm, Reference Value = 12.3 V/m; Power Drift = -0.161 dB

Peak SAR (extrapolated) = 2.3 W/kg

SAR(1 g) = 1.31 mW/g; SAR(10 g) = 0.670 mW/g Maximum value of SAR (measured) = 1.5 mW/g

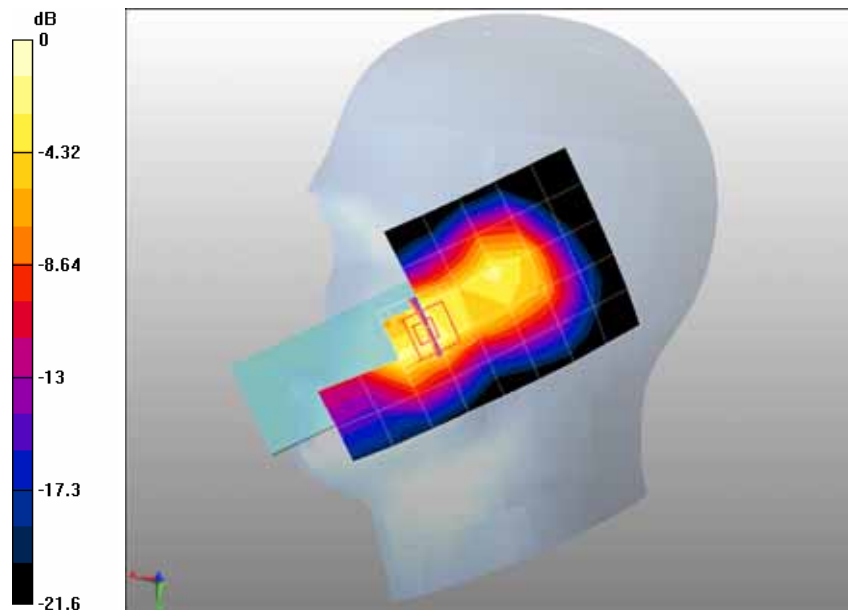

0 dB = 1.5mW/g

Date/Time: 29-12-2011

Test Laboratory: QuieTek Lab

PCS1900 Mid Body-Back

DUT: GSM Mobile Phone ; Type: AM89

Communication System: Generic GSM; Communication System Band: PCS 1900 (1850.0 - 1910.0 MHz);
 Duty Cycle: 1:8.3; Frequency: 1880 MHz; Medium parameters used: $f = 1880$ MHz; $\sigma = 1.51$ mho/m; $\epsilon_r = 52.5$; $\rho = 1000$ kg/m³ ; Phantom section: Flat Section

Ambient temperature (°C): 21.5, Liquid temperature (°C): 21.0

DASY5 Configuration:

- Probe: EX3DV4 - SN3661; ConvF(7.72, 7.72, 7.72); Calibrated: 24/01/2011
- Sensor-Surface: 4mm (Mechanical Surface Detection)
- Electronics: DAE4 Sn915; Calibrated: 26/07/2011
- Phantom: SAM1; Type: SAM; Serial: TP1561
- Measurement SW: DASY5, V5.2 Build 162; SEMCAD X Version 14.0 Build 59

Configuration/PCS1900 Mid Body-Back/Area Scan (6x11x1): Measurement grid: dx=20mm, dy=20mm

Maximum value of SAR (measured) = 0.258 mW/g

Configuration/PCS1900 Mid Body-Back/Zoom Scan (5x5x7)/Cube 0: Measurement grid: dx=8mm, dy=8mm, dz=5mm, Reference Value = 8.89 V/m; Power Drift = 0.087 dB

Peak SAR (extrapolated) = 0.392 W/kg

SAR(1 g) = 0.251 mW/g; SAR(10 g) = 0.155 mW/g Maximum value of SAR (measured) = 0.270 mW/g

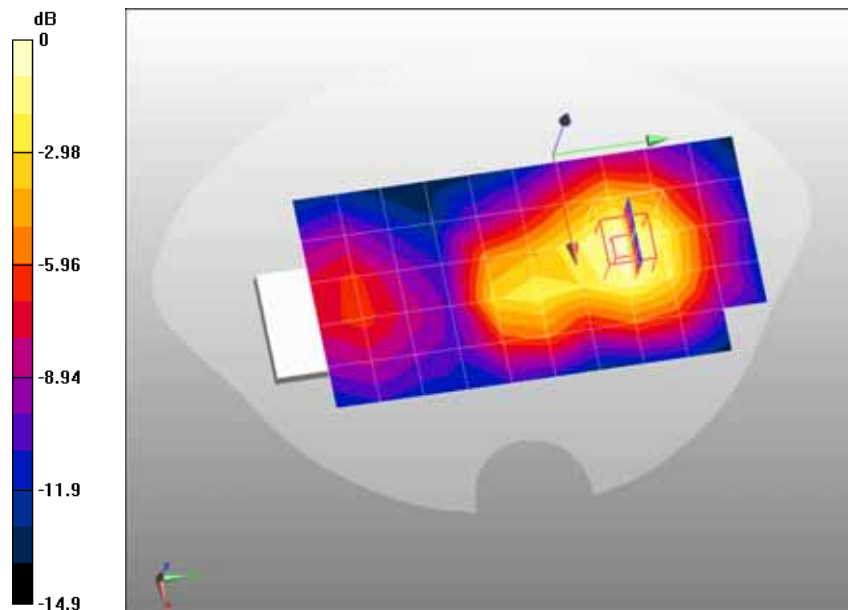

0 dB = 0.270mW/g

Date/Time: 29-12-2011

Test Laboratory: QuieTek Lab

GPRS1900 Mid Body-Back(2up)

DUT: GSM Mobile Phone ; Type: AM89

Communication System: GPRS/EGPRS-2 Slot; Communication System Band: PCS1900; Duty Cycle: 1:4.2 ;
 Frequency: 1880 MHz; Medium parameters used: $f = 1880$ MHz; $\sigma = 1.51$ mho/m; $\epsilon_r = 52.5$; $\rho = 1000$ kg/m³ ;
 Phantom section: Flat Section

Ambient temperature (°C): 21.5, Liquid temperature (°C): 21.0

DASY5 Configuration:

- Probe: EX3DV4 - SN3661; ConvF(7.72, 7.72, 7.72); Calibrated: 24/01/2011
- Sensor-Surface: 4mm (Mechanical Surface Detection)
- Electronics: DAE4 Sn915; Calibrated: 26/07/2011
- Phantom: SAM1; Type: SAM; Serial: TP1561
- Measurement SW: DASY5, V5.2 Build 162; SEMCAD X Version 14.0 Build 59

Configuration/GPRS1900 Mid Body-Back/Area Scan (6x11x1): Measurement grid: dx=20mm, dy=20mm

Maximum value of SAR (measured) = 0.511 mW/g

Configuration/GPRS1900 Mid Body-Back/Zoom Scan (5x5x7)/Cube 0: Measurement grid: dx=8mm, dy=8mm, dz=5mm, Reference Value = 12.3 V/m; Power Drift = -0.136 dB

Peak SAR (extrapolated) = 0.760 W/kg

SAR(1 g) = 0.487 mW/g; SAR(10 g) = 0.302 mW/g Maximum value of SAR (measured) = 0.523 mW/g

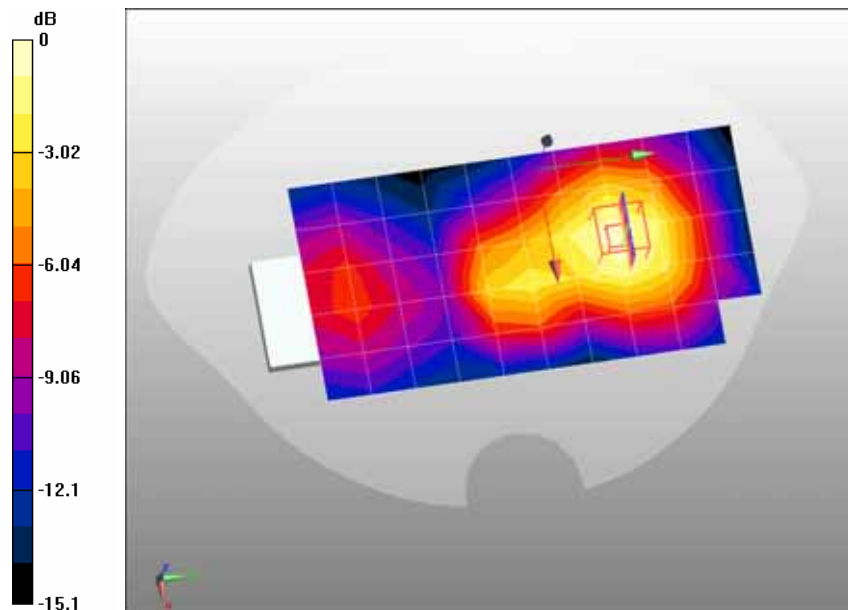

0 dB = 0.523mW/g

Date/Time: 29-12-2011

Test Laboratory: QuieTek Lab

GPRS1900 Low Body-Front(2up)

DUT: GSM Mobile Phone ; Type: AM89

Communication System: GPRS/EGPRS-2 Slot; Communication System Band: PCS1900; Duty Cycle: 1:4.2 ;
 Frequency: 1850.2 MHz; Medium parameters used: $f = 1850.2$ MHz; $\sigma = 1.48$ mho/m; $\epsilon_r = 52.6$; $\rho = 1000$ kg/m³ ; Phantom section: Flat Section

Ambient temperature (°C): 21.5, Liquid temperature (°C): 21.0

DASY5 Configuration:

- Probe: EX3DV4 - SN3661; ConvF(7.72, 7.72, 7.72); Calibrated: 24/01/2011
- Sensor-Surface: 4mm (Mechanical Surface Detection)
- Electronics: DAE4 Sn915; Calibrated: 26/07/2011
- Phantom: SAM1; Type: SAM; Serial: TP1561
- Measurement SW: DASY5, V5.2 Build 162; SEMCAD X Version 14.0 Build 59

Configuration/GPRS1900 Low Body-Front/Area Scan (6x11x1): Measurement grid: dx=20mm, dy=20mm

Maximum value of SAR (measured) = 1.34 mW/g

Configuration/GPRS1900 Low Body-Front/Zoom Scan (5x5x7)/Cube 0: Measurement grid: dx=8mm, dy=8mm, dz=5mm, Reference Value = 9.38 V/m; Power Drift = -0.194 dB

Peak SAR (extrapolated) = 2 W/kg

SAR(1 g) = 1.25 mW/g; SAR(10 g) = 0.751 mW/g Maximum value of SAR (measured) = 1.33 mW/g

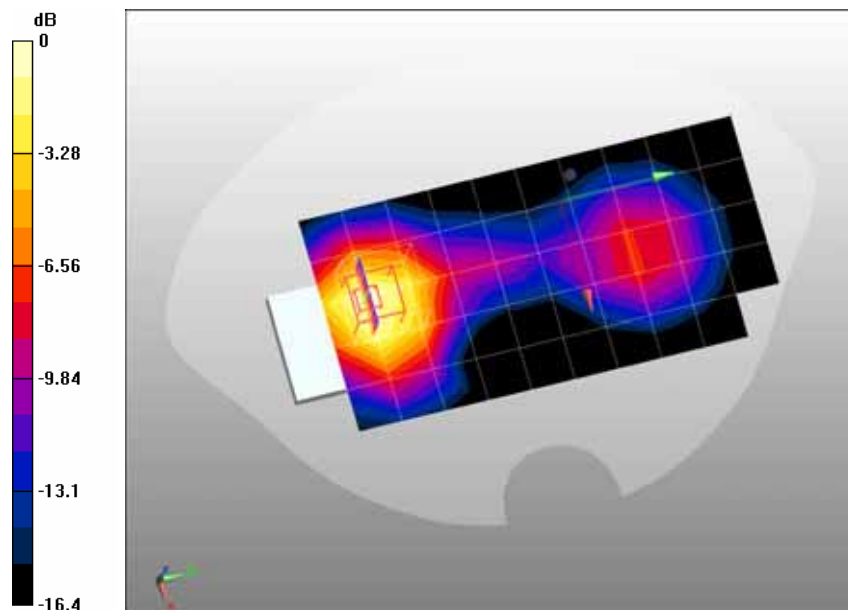

0 dB = 1.33mW/g

Date/Time: 29-12-2011

Test Laboratory: QuieTek Lab

GPRS1900 Mid Body-Front(2up)

DUT: GSM Mobile Phone ; Type: AM89

Communication System: GPRS/EGPRS-2 Slot; Communication System Band: PCS1900; Duty Cycle: 1:4.2 ;
 Frequency: 1880 MHz; Medium parameters used: $f = 1880$ MHz; $\sigma = 1.51$ mho/m; $\epsilon_r = 52.5$; $\rho = 1000$ kg/m³ ;
 Phantom section: Flat Section

Ambient temperature (°C): 21.5, Liquid temperature (°C): 21.0

DASY5 Configuration:

- Probe: EX3DV4 - SN3661; ConvF(7.72, 7.72, 7.72); Calibrated: 24/01/2011
- Sensor-Surface: 4mm (Mechanical Surface Detection)
- Electronics: DAE4 Sn915; Calibrated: 26/07/2011
- Phantom: SAM1; Type: SAM; Serial: TP1561
- Measurement SW: DASY5, V5.2 Build 162; SEMCAD X Version 14.0 Build 59

Configuration/GPRS1900 Mid Body-Front/Area Scan (6x11x1): Measurement grid: dx=20mm, dy=20mm

Maximum value of SAR (measured) = 1.39 mW/g

Configuration/GPRS1900 Mid Body-Front/Zoom Scan (5x5x7)/Cube 0: Measurement grid: dx=8mm, dy=8mm, dz=5mm, Reference Value = 10.4 V/m; Power Drift = -0.148 dB

Peak SAR (extrapolated) = 2.04 W/kg

SAR(1 g) = 1.29 mW/g; SAR(10 g) = 0.765 mW/g Maximum value of SAR (measured) = 1.37 mW/g

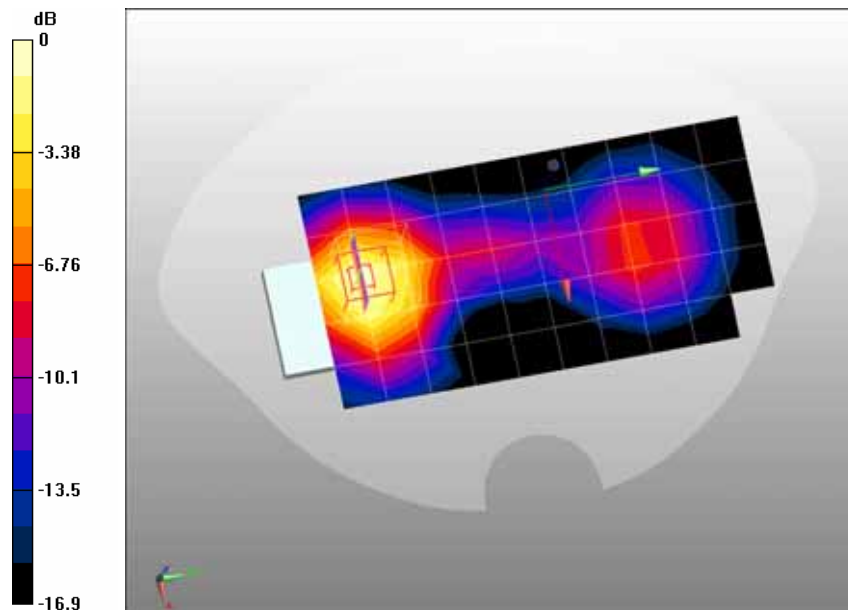

0 dB = 1.37mW/g

Date/Time: 29-12-2011

Test Laboratory: QuieTek Lab

GPRS1900 High Body-Front(2up)

DUT: GSM Mobile Phone ; Type: AM89

Communication System: GPRS/EGPRS-2 Slot; Communication System Band: PCS1900; Duty Cycle: 1:4.2 ; Frequency: 1909.8 MHz; Medium parameters used: $f = 1909.8$ MHz; $\sigma = 1.55$ mho/m; $\epsilon_r = 52.4$; $\rho = 1000$ kg/m³ ; Phantom section: Flat Section

Ambient temperature (°C): 21.5, Liquid temperature (°C): 21.0

DASY5 Configuration:

- Probe: EX3DV4 - SN3661; ConvF(7.72, 7.72, 7.72); Calibrated: 24/01/2011
- Sensor-Surface: 4mm (Mechanical Surface Detection)
- Electronics: DAE4 Sn915; Calibrated: 26/07/2011
- Phantom: SAM1; Type: SAM; Serial: TP1561
- Measurement SW: DASY5, V5.2 Build 162; SEMCAD X Version 14.0 Build 59

Configuration/GPRS1900 High Body-Front/Area Scan (6x11x1): Measurement grid: dx=20mm, dy=20mm

Maximum value of SAR (measured) = 1.27 mW/g

Configuration/GPRS1900 High Body-Front/Zoom Scan (5x5x7)/Cube 0: Measurement grid: dx=8mm, dy=8mm, dz=5mm, Reference Value = 10.5 V/m; Power Drift = -0.146 dB

Peak SAR (extrapolated) = 1.92 W/kg

SAR(1 g) = 1.18 mW/g; SAR(10 g) = 0.695 mW/g Maximum value of SAR (measured) = 1.24 mW/g

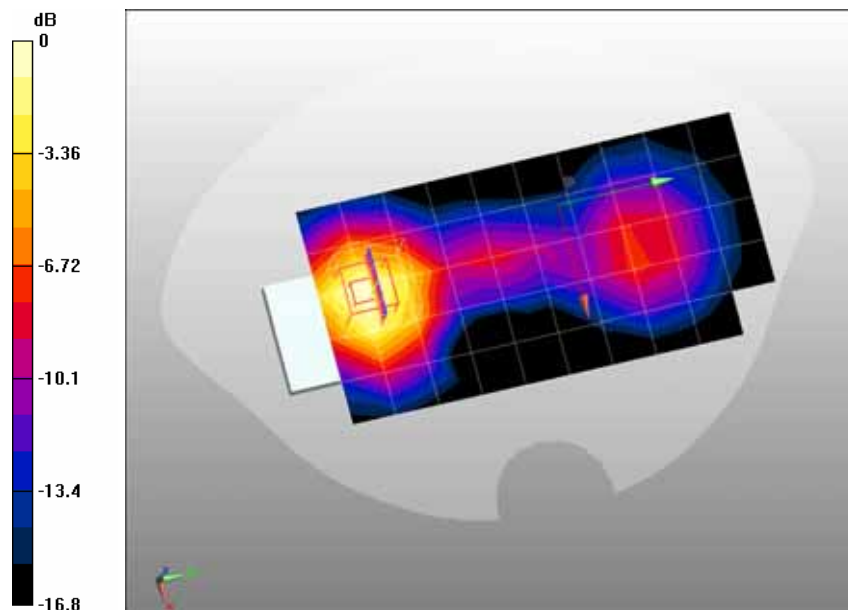

0 dB = 1.24mW/g

Date/Time: 29-12-2011

Test Laboratory: QuieTek Lab

GPRS1900 Mid Body-Back(2up) (with headset)

DUT: GSM Mobile Phone ; Type: AM89

Communication System: GPRS/EGPRS-2 Slot; Communication System Band: PCS1900; Duty Cycle: 1:4.2 ;
 Frequency: 1880 MHz; Medium parameters used: $f = 1880 \text{ MHz}$; $\sigma = 1.51 \text{ mho/m}$; $\epsilon_r = 52.5$; $\rho = 1000 \text{ kg/m}^3$;
 Phantom section: Flat Section

Ambient temperature (°C): 21.5, Liquid temperature (°C): 21.0

DASY5 Configuration:

- Probe: EX3DV4 - SN3661; ConvF(7.72, 7.72, 7.72); Calibrated: 24/01/2011
- Sensor-Surface: 4mm (Mechanical Surface Detection)
- Electronics: DAE4 Sn915; Calibrated: 26/07/2011
- Phantom: SAM1; Type: SAM; Serial: TP1561
- Measurement SW: DASY5, V5.2 Build 162; SEMCAD X Version 14.0 Build 59

Configuration/GPRS1900 Mid Body-Back/Area Scan (6x11x1): Measurement grid: dx=20mm, dy=20mm

Maximum value of SAR (measured) = 0.504 mW/g

Configuration/GPRS1900 Mid Body-Back/Zoom Scan (5x5x7)/Cube 0: Measurement grid: dx=8mm, dy=8mm, dz=5mm, Reference Value = 13.4 V/m; Power Drift = -0.185 dB

Peak SAR (extrapolated) = 0.731 W/kg

SAR(1 g) = 0.478 mW/g; SAR(10 g) = 0.298 mW/g Maximum value of SAR (measured) = 0.515 mW/g

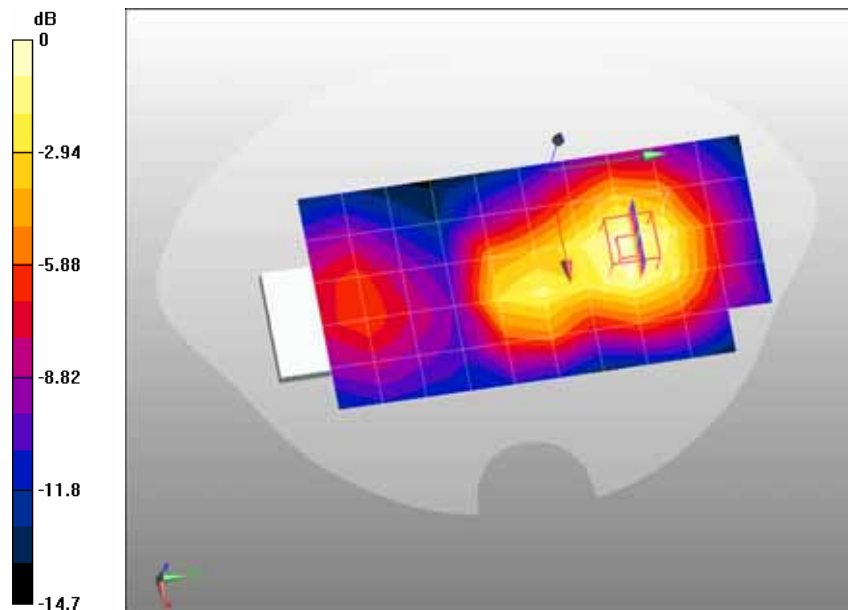

0 dB = 0.515mW/g

Appendix C. Test Setup Photographs & EUT Photographs

Test Setup Photographs



Left-Cheek Touch

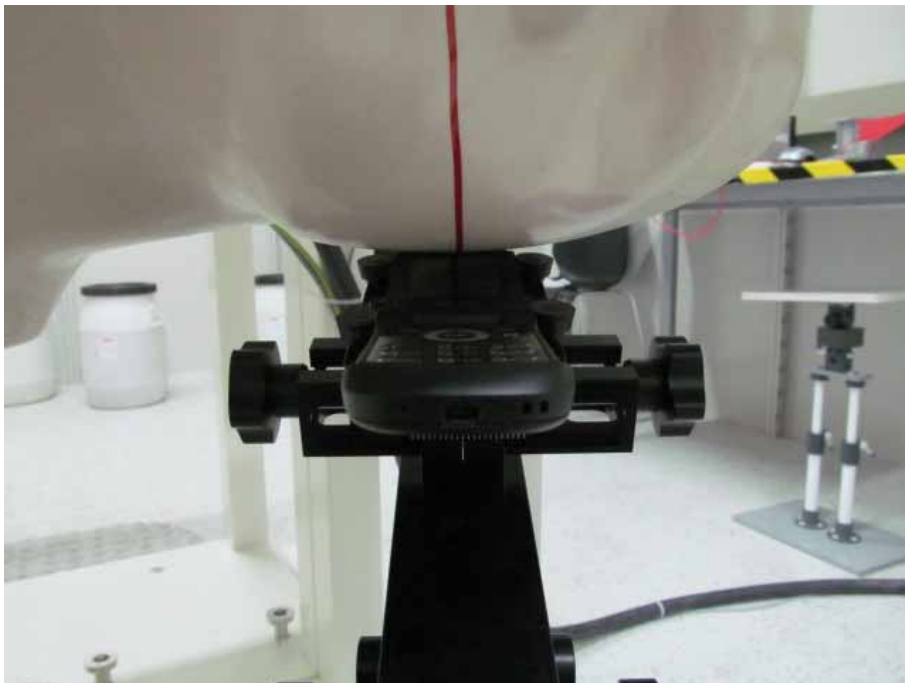

Left-Tilt 15°



Right-Cheek Touch



Right-Tilt 15°

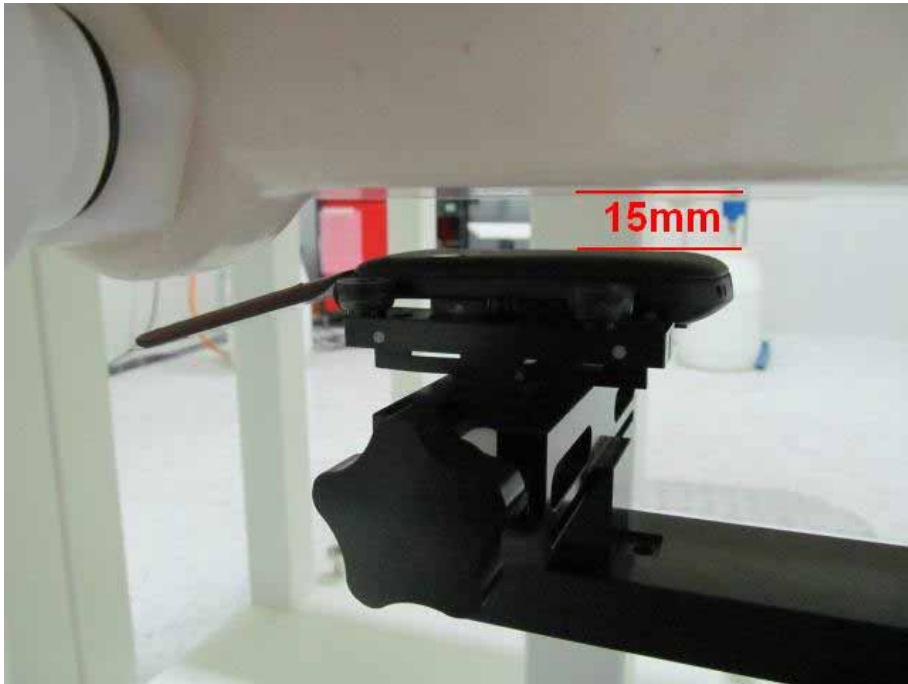

Body SAR Back 15mm

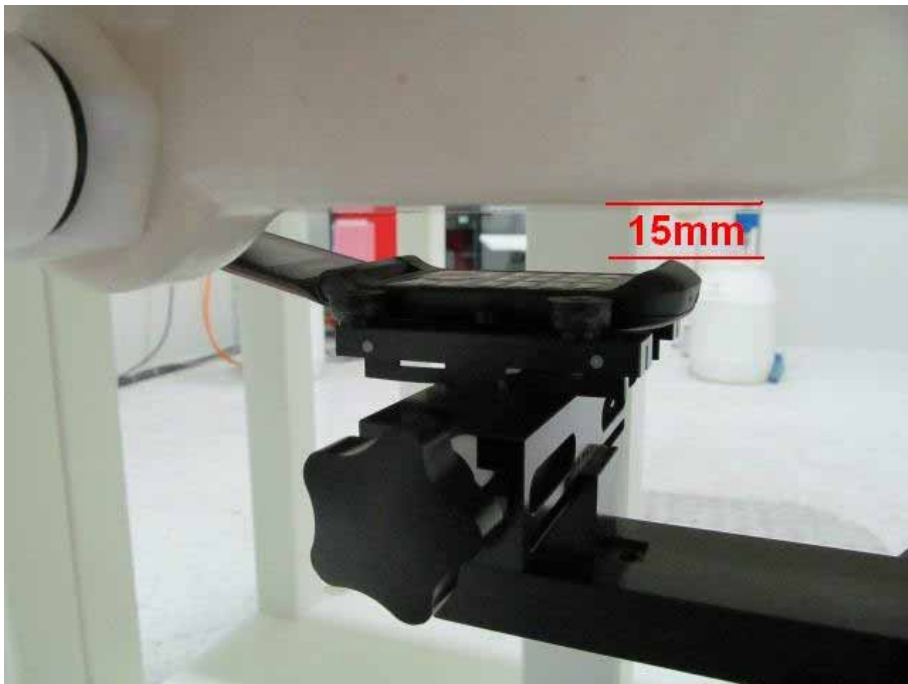

Body SAR Front 15mm

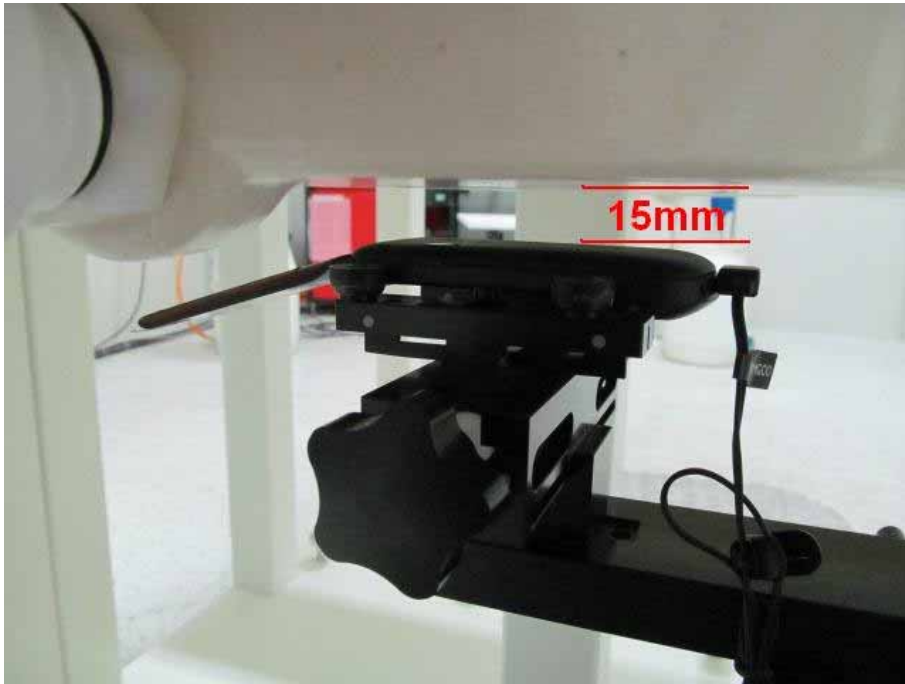

Body SAR Back 15mm with Headset

Depth of the liquid in the phantom – Zoom in

Note: The position used in the measurements were according to IEEE 1528 - 2003

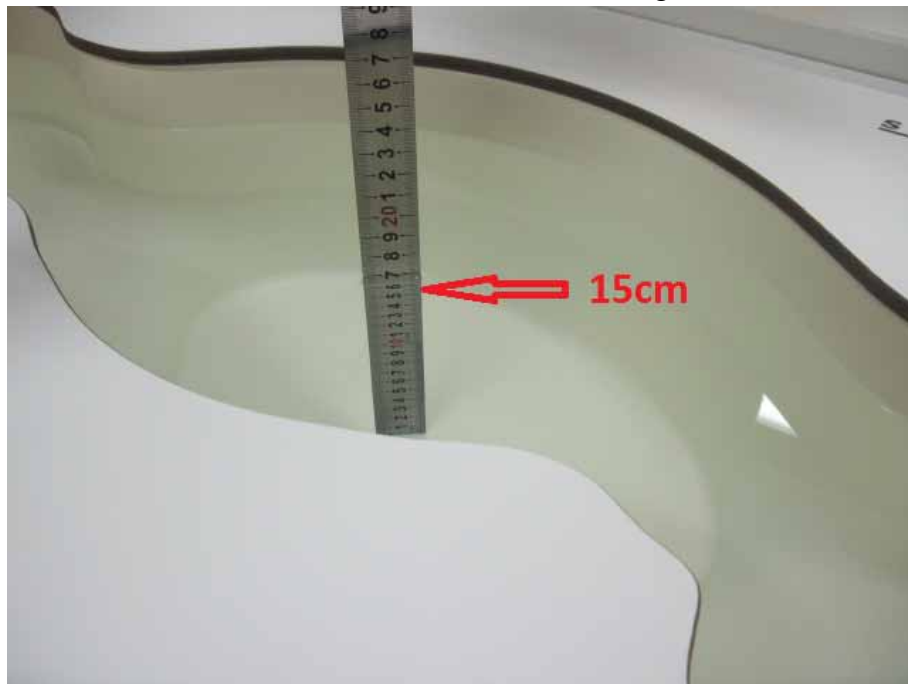

EUT Photographs

(1) EUT Photo



(2) EUT Photo



(3) EUT Photo



(4) EUT Photo

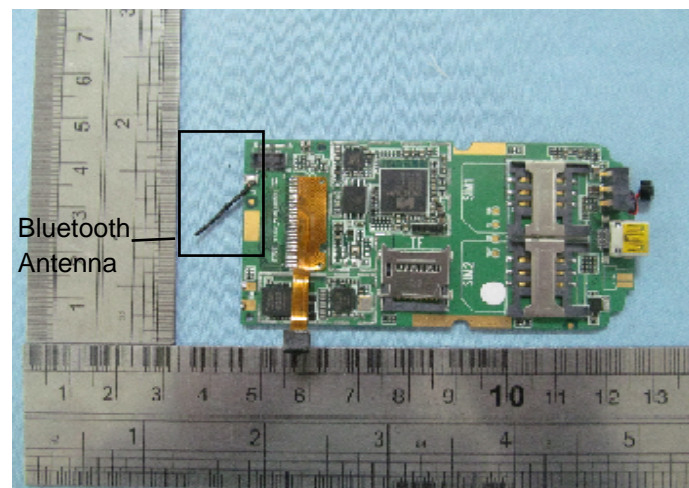

Appendix D. Probe Calibration Data

**Calibration Laboratory of
Schmid & Partner
Engineering AG**
Zeughausstrasse 43, 8004 Zurich, Switzerland



S Schweizerischer Kalibrierdienst
C Service suisse d'étalonnage
S Servizio svizzero di taratura
S Swiss Calibration Service

Accredited by the Swiss Accreditation Service (SAS)
The Swiss Accreditation Service is one of the signatories to the EA
Multilateral Agreement for the recognition of calibration certificates

Accreditation No.: **SCS 108**

Client **Auden**

Certificate No. **EX3-3661_Jan11**

CALIBRATION CERTIFICATE																																																			
Object	EX3DV4 - SN:3661																																																		
Calibration procedure(s)	QA CAL-01.v7, QA CAL-14.v3, QA CAL-23.v4 and QA CAL-25.v3 Calibration procedure for dosimetric E-field probes																																																		
Calibration date:	January 24, 2011																																																		
<p>This calibration certificate documents the traceability to national standards, which realize the physical units of measurements (SI). The measurements and the uncertainties with confidence probability are given on the following pages and are part of the certificate.</p> <p>All calibrations have been conducted in the closed laboratory facility: environment temperature (22 ± 3)°C and humidity < 70%.</p> <p>Calibration Equipment used (M&TE critical for calibration)</p> <table border="1"> <thead> <tr> <th>Primary Standards</th> <th>ID #</th> <th>Cal Date (Certificate No.)</th> <th>Scheduled Calibration</th> </tr> </thead> <tbody> <tr> <td>Power meter E4419B</td> <td>GB41293874</td> <td>1-Apr-10 (No. 217-01136)</td> <td>Apr-11</td> </tr> <tr> <td>Power sensor E4412A</td> <td>MY41495277</td> <td>1-Apr-10 (No. 217-01136)</td> <td>Apr-11</td> </tr> <tr> <td>Power sensor E4412A</td> <td>MY41498087</td> <td>1-Apr-10 (No. 217-01136)</td> <td>Apr-11</td> </tr> <tr> <td>Reference 3 dB Attenuator</td> <td>SN: S5054 (3c)</td> <td>30-Mar-10 (No. 217-01159)</td> <td>Mar-11</td> </tr> <tr> <td>Reference 20 dB Attenuator</td> <td>SN: S5086 (20b)</td> <td>30-Mar-10 (No. 217-01161)</td> <td>Mar-11</td> </tr> <tr> <td>Reference 30 dB Attenuator</td> <td>SN: S5129 (30b)</td> <td>30-Mar-10 (No. 217-01160)</td> <td>Mar-11</td> </tr> <tr> <td>Reference Probe ES3DV2</td> <td>SN: 3013</td> <td>29-Dec-10 (No. ES3-3013_Dec10)</td> <td>Dec-11</td> </tr> <tr> <td>DAE4</td> <td>SN: 660</td> <td>20-Apr-10 (No. DAE4-660_Apr10)</td> <td>Apr-11</td> </tr> </tbody> </table> <table border="1"> <thead> <tr> <th>Secondary Standards</th> <th>ID #</th> <th>Check Date (in house)</th> <th>Scheduled Check</th> </tr> </thead> <tbody> <tr> <td>RF generator HP 8648C</td> <td>US3642U01700</td> <td>4-Aug-99 (in house check Oct-09)</td> <td>In house check: Oct-11</td> </tr> <tr> <td>Network Analyzer HP 8753E</td> <td>US37390585</td> <td>18-Oct-01 (in house check Oct-10)</td> <td>In house check: Oct-11</td> </tr> </tbody> </table>				Primary Standards	ID #	Cal Date (Certificate No.)	Scheduled Calibration	Power meter E4419B	GB41293874	1-Apr-10 (No. 217-01136)	Apr-11	Power sensor E4412A	MY41495277	1-Apr-10 (No. 217-01136)	Apr-11	Power sensor E4412A	MY41498087	1-Apr-10 (No. 217-01136)	Apr-11	Reference 3 dB Attenuator	SN: S5054 (3c)	30-Mar-10 (No. 217-01159)	Mar-11	Reference 20 dB Attenuator	SN: S5086 (20b)	30-Mar-10 (No. 217-01161)	Mar-11	Reference 30 dB Attenuator	SN: S5129 (30b)	30-Mar-10 (No. 217-01160)	Mar-11	Reference Probe ES3DV2	SN: 3013	29-Dec-10 (No. ES3-3013_Dec10)	Dec-11	DAE4	SN: 660	20-Apr-10 (No. DAE4-660_Apr10)	Apr-11	Secondary Standards	ID #	Check Date (in house)	Scheduled Check	RF generator HP 8648C	US3642U01700	4-Aug-99 (in house check Oct-09)	In house check: Oct-11	Network Analyzer HP 8753E	US37390585	18-Oct-01 (in house check Oct-10)	In house check: Oct-11
Primary Standards	ID #	Cal Date (Certificate No.)	Scheduled Calibration																																																
Power meter E4419B	GB41293874	1-Apr-10 (No. 217-01136)	Apr-11																																																
Power sensor E4412A	MY41495277	1-Apr-10 (No. 217-01136)	Apr-11																																																
Power sensor E4412A	MY41498087	1-Apr-10 (No. 217-01136)	Apr-11																																																
Reference 3 dB Attenuator	SN: S5054 (3c)	30-Mar-10 (No. 217-01159)	Mar-11																																																
Reference 20 dB Attenuator	SN: S5086 (20b)	30-Mar-10 (No. 217-01161)	Mar-11																																																
Reference 30 dB Attenuator	SN: S5129 (30b)	30-Mar-10 (No. 217-01160)	Mar-11																																																
Reference Probe ES3DV2	SN: 3013	29-Dec-10 (No. ES3-3013_Dec10)	Dec-11																																																
DAE4	SN: 660	20-Apr-10 (No. DAE4-660_Apr10)	Apr-11																																																
Secondary Standards	ID #	Check Date (in house)	Scheduled Check																																																
RF generator HP 8648C	US3642U01700	4-Aug-99 (in house check Oct-09)	In house check: Oct-11																																																
Network Analyzer HP 8753E	US37390585	18-Oct-01 (in house check Oct-10)	In house check: Oct-11																																																
Calibrated by:	Name Katja Pakovic	Function Technical Manager	Signature 																																																
Approved by:	Name Fin Borchelt	Function R&D Director	Signature 																																																
			Issued: January 25, 2011																																																
This calibration certificate shall not be reproduced except in full without written approval of the laboratory.																																																			

Calibration Laboratory of
Schmid & Partner
Engineering AG
 Zeughausstrasse 43, 8004 Zurich, Switzerland



S Schweizerischer Kalibrierdienst
S Service suisse d'étalonnage
C Servizio svizzero di taratura
S Swiss Calibration Service

Accredited by the Swiss Accreditation Service (SAS)
 The Swiss Accreditation Service is one of the signatories to the EA
 Multilateral Agreement for the recognition of calibration certificates

Accreditation No.: **SCS 108**

Glossary:

TSL	tissue simulating liquid
NORM _{x,y,z}	sensitivity in free space
ConvF	sensitivity in TSL / NORM _{x,y,z}
DCP	diode compression point
CF	crest factor (1/duty_cycle) of the RF signal
A, B, C	modulation dependent linearization parameters
Polarization φ	φ rotation around probe axis
Polarization ϑ	ϑ rotation around an axis that is in the plane normal to probe axis (at measurement center), i.e., $\vartheta = 0$ is normal to probe axis

Calibration is Performed According to the Following Standards:

- a) IEEE Std 1528-2003, "IEEE Recommended Practice for Determining the Peak Spatial-Averaged Specific Absorption Rate (SAR) in the Human Head from Wireless Communications Devices: Measurement Techniques", December 2003
- b) IEC 62209-1, "Procedure to measure the Specific Absorption Rate (SAR) for hand-held devices used in close proximity to the ear (frequency range of 300 MHz to 3 GHz)", February 2005

Methods Applied and Interpretation of Parameters:

- **NORM_{x,y,z}:** Assessed for E-field polarization $\vartheta = 0$ ($f \leq 900$ MHz in TEM-cell; $f > 1800$ MHz: R22 waveguide). NORM_{x,y,z} are only intermediate values, i.e., the uncertainties of NORM_{x,y,z} does not effect the E²-field uncertainty inside TSL (see below ConvF).
- **NORM(f)_{x,y,z} = NORM_{x,y,z} * frequency_response** (see Frequency Response Chart). This linearization is implemented in DASY4 software versions later than 4.2. The uncertainty of the frequency response is included in the stated uncertainty of ConvF.
- **DCP_{x,y,z}:** DCP are numerical linearization parameters assessed based on the data of power sweep with CW signal (no uncertainty required). DCP does not depend on frequency nor media.
- **A_{x,y,z}; B_{x,y,z}; C_{x,y,z}; VR_{x,y,z}:** A, B, C are numerical linearization parameters assessed based on the data of power sweep for specific modulation signal. The parameters do not depend on frequency nor media. VR is the maximum calibration range expressed in RMS voltage across the diode.
- **ConvF and Boundary Effect Parameters:** Assessed in flat phantom using E-field (or Temperature Transfer Standard for $f \leq 800$ MHz) and inside waveguide using analytical field distributions based on power measurements for $f > 800$ MHz. The same setups are used for assessment of the parameters applied for boundary compensation (alpha, depth) of which typical uncertainty values are given. These parameters are used in DASY4 software to improve probe accuracy close to the boundary. The sensitivity in TSL corresponds to NORM_{x,y,z} * ConvF whereby the uncertainty corresponds to that given for ConvF. A frequency dependent ConvF is used in DASY version 4.4 and higher which allows extending the validity from ± 50 MHz to ± 100 MHz.
- **Spherical isotropy (3D deviation from isotropy):** in a field of low gradients realized using a flat phantom exposed by a patch antenna.
- **Sensor Offset:** The sensor offset corresponds to the offset of virtual measurement center from the probe tip (on probe axis). No tolerance required.

EX3DV4 SN:3661

January 24, 2011

Probe EX3DV4

SN:3661

Manufactured:	October 20, 2008
Last calibrated:	December 30, 2009
Recalibrated:	January 24, 2011

Calibrated for DASY/EASY Systems

(Note: non-compatible with DASY2 system!)

EX3DV4 SN:3661

January 24, 2011

DASY/EASY - Parameters of Probe: EX3DV4 SN:3661

Basic Calibration Parameters

	Sensor X	Sensor Y	Sensor Z	Unc (k=2)
Norm ($\mu V/(V/m)^2$) ^A	0.47	0.52	0.50	± 10.1%
DCP (mV) ^B	99.7	99.0	97.2	

Modulation Calibration Parameters

UID	Communication System Name	PAR		A dB	B dBuV	C	VR mV	Unc ^E (k=2)
10000	CW	0.00	X	0.00	0.00	1.00	157.5	± 3.4 %
			Y	0.00	0.00	1.00	151.6	
			Z	0.00	0.00	1.00	156.6	

The reported uncertainty of measurement is stated as the standard uncertainty of measurement multiplied by the coverage factor k=2, which for a normal distribution corresponds to a coverage probability of approximately 95%.

^A The uncertainties of NormX,Y,Z do not affect the E²-field uncertainty inside TSL (see Pages 5 and 6).

^B Numerical linearization parameter; uncertainty not required.

^E Uncertainty is determined using the maximum deviation from linear response applying recatangular distribution and is expressed for the square of the field value.

EX3DV4 SN:3661

January 24, 2011

DASY/EASY - Parameters of Probe: EX3DV4 SN:3661

Calibration Parameter Determined in Head Tissue Simulating Media

f [MHz]	Validity [MHz] ^c	Permittivity	Conductivity	ConvF X	ConvF Y	ConvF Z	Alpha	Depth Unc (k=2)
750	± 50 / ± 100	41.9 ± 5%	0.89 ± 5%	9.96	9.96	9.96	0.47	0.71 ± 11.0%
835	± 50 / ± 100	41.5 ± 5%	0.90 ± 5%	9.58	9.58	9.58	0.58	0.67 ± 11.0%
1750	± 50 / ± 100	40.1 ± 5%	1.37 ± 5%	9.05	9.05	9.05	0.31	0.97 ± 11.0%
1900	± 50 / ± 100	40.0 ± 5%	1.40 ± 5%	8.68	8.68	8.68	0.40	0.95 ± 11.0%
2000	± 50 / ± 100	40.0 ± 5%	1.40 ± 5%	8.53	8.53	8.53	0.47	0.81 ± 11.0%
2450	± 50 / ± 100	39.2 ± 5%	1.80 ± 5%	7.80	7.80	7.80	0.28	1.13 ± 11.0%
5200	± 50 / ± 100	36.0 ± 5%	4.66 ± 5%	4.88	4.88	4.88	0.40	1.80 ± 13.1%
5300	± 50 / ± 100	35.9 ± 5%	4.76 ± 5%	4.59	4.59	4.59	0.42	1.80 ± 13.1%
5500	± 50 / ± 100	35.6 ± 5%	4.96 ± 5%	4.41	4.41	4.41	0.45	1.80 ± 13.1%
5600	± 50 / ± 100	35.5 ± 5%	5.07 ± 5%	4.17	4.17	4.17	0.50	1.80 ± 13.1%
5800	± 50 / ± 100	35.3 ± 5%	5.27 ± 5%	4.15	4.15	4.15	0.50	1.80 ± 13.1%

^c The validity of ± 100 MHz only applies for DASY v4.4 and higher (see Page 2). The uncertainty is the RSS of the ConvF uncertainty at calibration frequency and the uncertainty for the indicated frequency band.

EX3DV4 SN:3661

January 24, 2011

DASY/EASY - Parameters of Probe: EX3DV4 SN:3661

Calibration Parameter Determined in Body Tissue Simulating Media

f [MHz]	Validity [MHz] ^c	Permittivity	Conductivity	ConvF X	ConvF Y	ConvF Z	Alpha	Depth Unc (k=2)
750	± 50 / ± 100	55.5 ± 5%	0.96 ± 5%	9.75	9.75	9.75	0.47	0.79 ± 11.0%
835	± 50 / ± 100	55.2 ± 5%	0.97 ± 5%	9.58	9.58	9.58	0.35	0.89 ± 11.0%
1750	± 50 / ± 100	53.4 ± 5%	1.49 ± 5%	7.95	7.95	7.95	0.64	0.68 ± 11.0%
1900	± 50 / ± 100	53.3 ± 5%	1.52 ± 5%	7.72	7.72	7.72	0.52	0.75 ± 11.0%
2000	± 50 / ± 100	53.3 ± 5%	1.52 ± 5%	7.81	7.81	7.81	0.46	0.80 ± 11.0%
2450	± 50 / ± 100	52.7 ± 5%	1.95 ± 5%	7.55	7.55	7.55	0.66	0.64 ± 11.0%
5200	± 50 / ± 100	49.0 ± 5%	5.30 ± 5%	4.42	4.42	4.42	0.50	1.90 ± 13.1%
5300	± 50 / ± 100	48.9 ± 5%	5.42 ± 5%	4.20	4.20	4.20	0.55	1.90 ± 13.1%
5500	± 50 / ± 100	48.6 ± 5%	5.65 ± 5%	3.88	3.88	3.88	0.55	1.90 ± 13.1%
5600	± 50 / ± 100	48.5 ± 5%	5.77 ± 5%	3.59	3.59	3.59	0.60	1.90 ± 13.1%
5800	± 50 / ± 100	48.2 ± 5%	6.00 ± 5%	3.87	3.87	3.87	0.60	1.90 ± 13.1%

^c The validity of ± 100 MHz only applies for DASY v4.4 and higher (see Page 2). The uncertainty is the RSS of the ConvF uncertainty at calibration frequency and the uncertainty for the indicated frequency band.

EX3DV4 SN:3661

January 24, 2011

Frequency Response of E-Field

(TEM-Cell:ifi110 EXX, Waveguide: R22)

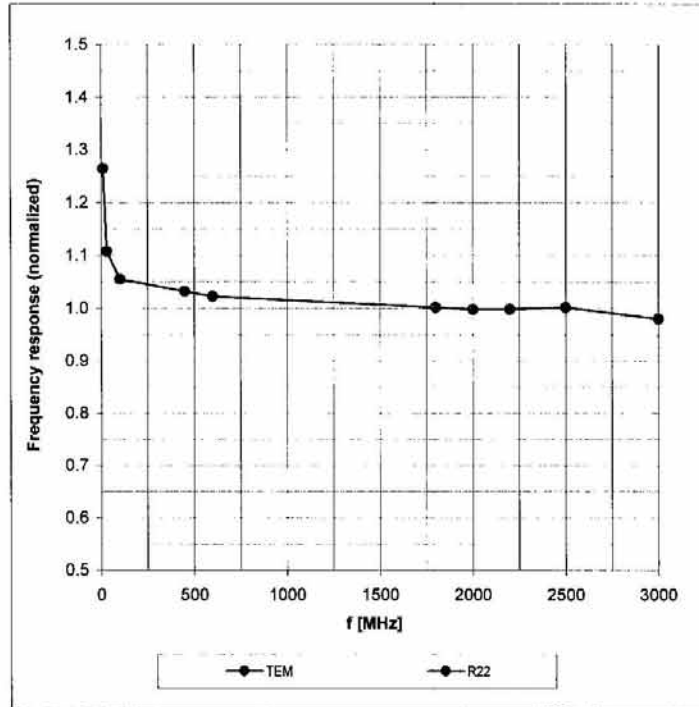

Uncertainty of Frequency Response of E-field: $\pm 6.3\%$ (k=2)

EX3DV4 SN:3661

January 24, 2011

Receiving Pattern (ϕ), $\theta = 0^\circ$

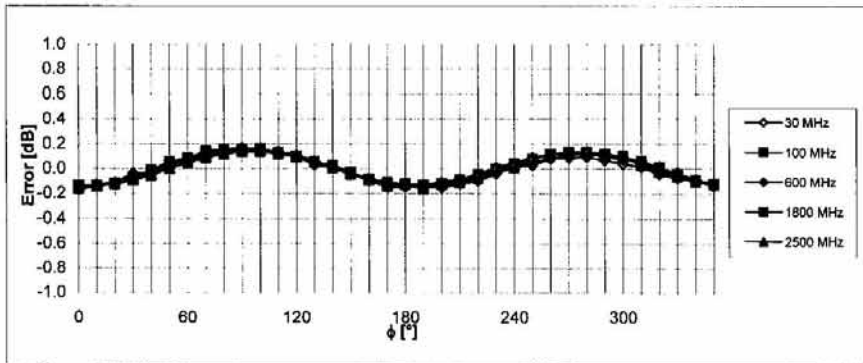
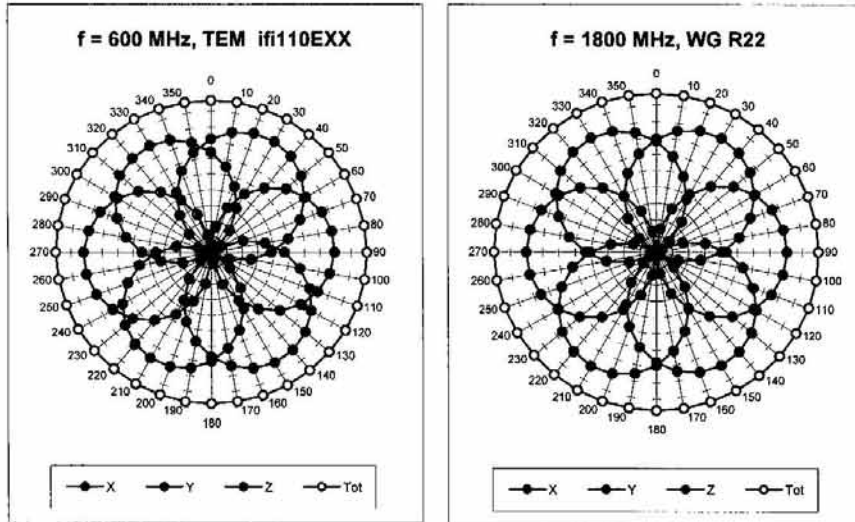

Uncertainty of Axial Isotropy Assessment: $\pm 0.5\%$ (k=2)

EX3DV4 SN:3661

January 24, 2011

Dynamic Range f(SAR_{head})
 (TEM cell, f = 900 MHz)

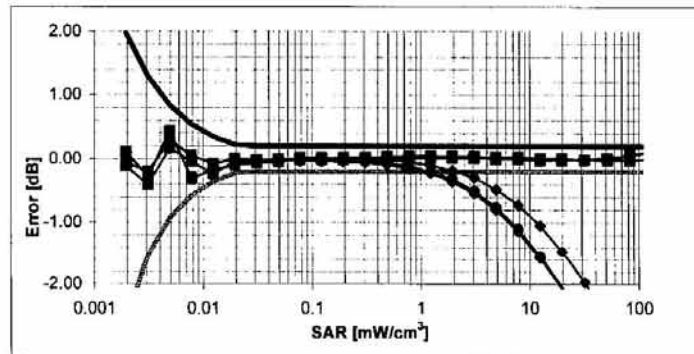
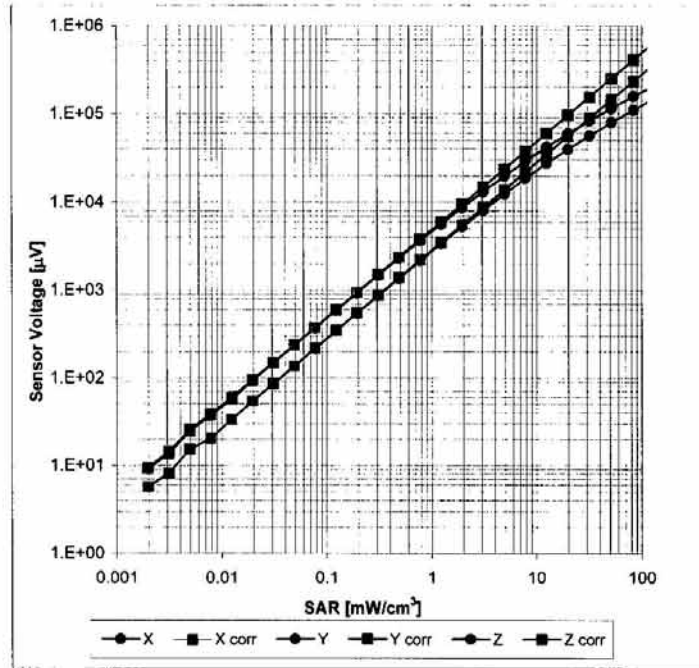

Uncertainty of Linearity Assessment: ± 0.6% (k=2)

EX3DV4 SN:3661

January 24, 2011

Conversion Factor Assessment

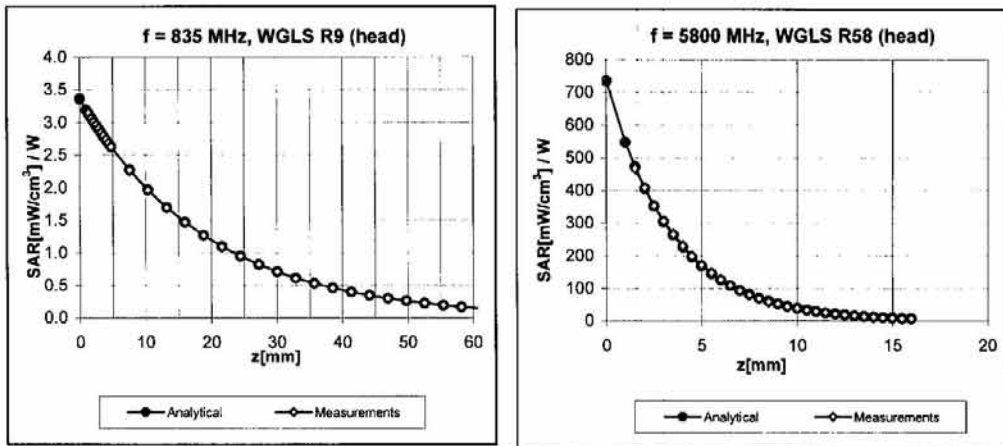

Deviation from Isotropy in HSL

Error (ϕ , θ), f = 900 MHz

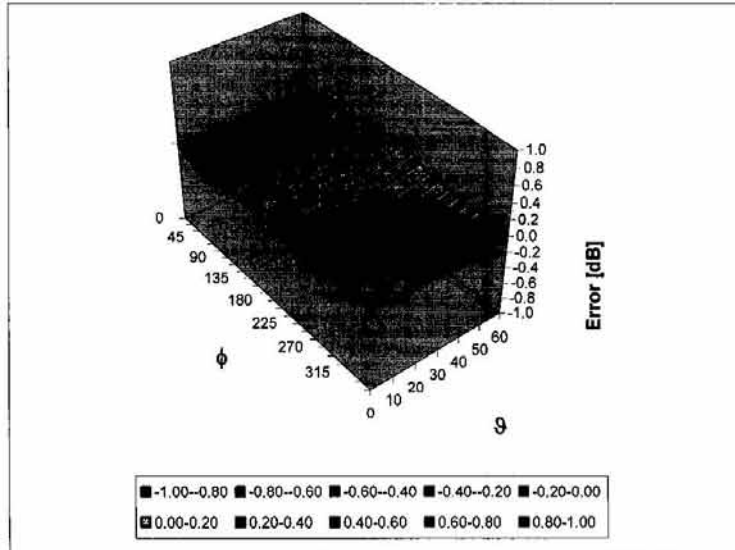

Uncertainty of Spherical Isotropy Assessment: $\pm 2.6\%$ (k=2)

EX3DV4 SN:3661

January 24, 2011

Other Probe Parameters

Sensor Arrangement	Triangular
Connector Angle (°)	Not applicable
Mechanical Surface Detection Mode	enabled
Optical Surface Detection Mode	disabled
Probe Overall Length	337 mm
Probe Body Diameter	10 mm
Tip Length	9 mm
Tip Diameter	2.5 mm
Probe Tip to Sensor X Calibration Point	1 mm
Probe Tip to Sensor Y Calibration Point	1 mm
Probe Tip to Sensor Z Calibration Point	1 mm
Recommended Measurement Distance from Surface	2 mm

Appendix E. Dipole Calibration Data

**Calibration Laboratory of
Schmid & Partner
Engineering AG**
Zeughausstrasse 43, 8004 Zurich, Switzerland



S Schweizerischer Kalibrierdienst
S Service suisse d'étalonnage
C Servizio svizzero di taratura
S Swiss Calibration Service

Accredited by the Swiss Accreditation Service (SAS)
The Swiss Accreditation Service is one of the signatories to the EA
Multilateral Agreement for the recognition of calibration certificates

Accreditation No.: **SCS 108**

Client **Quietek (Auden)**

Certificate No: **D835V2-4d094_Mar10**

CALIBRATION CERTIFICATE

Object: **D835V2 - SN: 4d094**

Calibration procedure(s): **QA CAL-05.v7
Calibration procedure for dipole validation kits**

Calibration date: **March 15, 2010**

This calibration certificate documents the traceability to national standards, which realize the physical units of measurements (SI).
The measurements and the uncertainties with confidence probability are given on the following pages and are part of the certificate.

All calibrations have been conducted in the closed laboratory facility: environment temperature (22 ± 3)°C and humidity < 70%.

Calibration Equipment used (M&TE critical for calibration)

Primary Standards	ID #	Cal Date (Certificate No.)	Scheduled Calibration
Power meter EPM-442A	GB37480704	06-Oct-09 (No. 217-01086)	Oct-10
Power sensor HP 8481A	US37292783	06-Oct-09 (No. 217-01086)	Oct-10
Reference 20 dB Attenuator	SN: 5086 (20g)	31-Mar-09 (No. 217-01025)	Mar-10
Type-N mismatch combination	SN: 5047.2 / 08327	31-Mar-09 (No. 217-01029)	Mar-10
Reference Probe ES3DV3	SN: 3205	26-Jun-09 (No. ES3-3205_Jun09)	Jun-10
DAE4	SN: 601	02-Mar-10 (No. DAE4-601_Mar10)	Mar-11
Secondary Standards	ID #	Check Date (in house)	Scheduled Check
Power sensor HP 8481A	MY41092317	18-Oct-02 (in house check Oct-09)	In house check: Oct-11
RF generator R&S SMT-06	100005	4-Aug-99 (in house check Oct-09)	In house check: Oct-11
Network Analyzer HP 8753E	US37390585 S4206	18-Oct-01 (in house check Oct-09)	In house check: Oct-10

Calibrated by:	Name Dirce Iliev	Function Laboratory Technician	Signature
Approved by:	Name Katja Pokovic	Function Technical Manager	Signature

Issued: March 15, 2010

This calibration certificate shall not be reproduced except in full without written approval of the laboratory.

**Calibration Laboratory of
Schmid & Partner
Engineering AG**
Zeughausstrasse 43, 8004 Zurich, Switzerland



S Schweizerischer Kalibrierdienst
C Service suisse d'étalonnage
S Servizio svizzero di taratura
S Swiss Calibration Service

Accredited by the Swiss Accreditation Service (SAS)
The Swiss Accreditation Service is one of the signatories to the EA
Multilateral Agreement for the recognition of calibration certificates

Accreditation No.: **SCS 108**

Glossary:

TSL	tissue simulating liquid
ConvF	sensitivity in TSL / NORM x,y,z
N/A	not applicable or not measured

Calibration is Performed According to the Following Standards:

- a) IEEE Std 1528-2003, "IEEE Recommended Practice for Determining the Peak Spatial-Averaged Specific Absorption Rate (SAR) in the Human Head from Wireless Communications Devices: Measurement Techniques", December 2003
- b) IEC 62209-1, "Procedure to measure the Specific Absorption Rate (SAR) for hand-held devices used in close proximity to the ear (frequency range of 300 MHz to 3 GHz)", February 2005
- c) Federal Communications Commission Office of Engineering & Technology (FCC OET), "Evaluating Compliance with FCC Guidelines for Human Exposure to Radiofrequency Electromagnetic Fields; Additional Information for Evaluating Compliance of Mobile and Portable Devices with FCC Limits for Human Exposure to Radiofrequency Emissions", Supplement C (Edition 01-01) to Bulletin 65

Additional Documentation:

- d) DASY4/5 System Handbook

Methods Applied and Interpretation of Parameters:

- *Measurement Conditions:* Further details are available from the Validation Report at the end of the certificate. All figures stated in the certificate are valid at the frequency indicated.
- *Antenna Parameters with TSL:* The dipole is mounted with the spacer to position its feed point exactly below the center marking of the flat phantom section, with the arms oriented parallel to the body axis.
- *Feed Point Impedance and Return Loss:* These parameters are measured with the dipole positioned under the liquid filled phantom. The impedance stated is transformed from the measurement at the SMA connector to the feed point. The Return Loss ensures low reflected power. No uncertainty required.
- *Electrical Delay:* One-way delay between the SMA connector and the antenna feed point. No uncertainty required.
- *SAR measured:* SAR measured at the stated antenna input power.
- *SAR normalized:* SAR as measured, normalized to an input power of 1 W at the antenna connector.
- *SAR for nominal TSL parameters:* The measured TSL parameters are used to calculate the nominal SAR result.

Measurement Conditions

DASY system configuration, as far as not given on page 1.

DASY Version	DASY5	V5.2
Extrapolation	Advanced Extrapolation	
Phantom	Modular Flat Phantom V4.9	
Distance Dipole Center - TSL	15 mm	with Spacer
Zoom Scan Resolution	dx, dy, dz = 5 mm	
Frequency	835 MHz ± 1 MHz	

Head TSL parameters

The following parameters and calculations were applied.

	Temperature	Permittivity	Conductivity
Nominal Head TSL parameters	22.0 °C	41.5	0.90 mho/m
Measured Head TSL parameters	(22.0 ± 0.2) °C	42.9 ± 6 %	0.91 mho/m ± 6 %
Head TSL temperature during test	(21.5 ± 0.2) °C	----	----

SAR result with Head TSL

SAR averaged over 1 cm ³ (1 g) of Head TSL	Condition	
SAR measured	250 mW input power	2.43 mW / g
SAR normalized	normalized to 1W	9.72 mW / g
SAR for nominal Head TSL parameters	normalized to 1W	9.70 mW /g ± 17.0 % (k=2)

SAR averaged over 10 cm ³ (10 g) of Head TSL	condition	
SAR measured	250 mW input power	1.58 mW / g
SAR normalized	normalized to 1W	6.32 mW / g
SAR for nominal Head TSL parameters	normalized to 1W	6.30 mW /g ± 16.5 % (k=2)

Body TSL parameters

The following parameters and calculations were applied.

	Temperature	Permittivity	Conductivity
Nominal Body TSL parameters	22.0 °C	55.2	0.97 mho/m
Measured Body TSL parameters	(22.0 ± 0.2) °C	55.3 ± 6 %	1.01 mho/m ± 6 %
Body TSL temperature during test	(21.3 ± 0.2) °C	----	----

SAR result with Body TSL

SAR averaged over 1 cm ³ (1 g) of Body TSL	Condition	
SAR measured	250 mW input power	2.55 mW / g
SAR normalized	normalized to 1W	10.2 mW / g
SAR for nominal Body TSL parameters	normalized to 1W	9.90 mW / g ± 17.0 % (k=2)

SAR averaged over 10 cm ³ (10 g) of Body TSL	condition	
SAR measured	250 mW input power	1.67 mW / g
SAR normalized	normalized to 1W	6.68 mW / g
SAR for nominal Body TSL parameters	normalized to 1W	6.53 mW / g ± 16.5 % (k=2)

Appendix

Antenna Parameters with Head TSL

Impedance, transformed to feed point	52.2 Ω - 2.7 j Ω
Return Loss	- 29.4 dB

Antenna Parameters with Body TSL

Impedance, transformed to feed point	48.0 Ω - 4.8 j Ω
Return Loss	- 25.5 dB

General Antenna Parameters and Design

Electrical Delay (one direction)	1.388 ns
----------------------------------	----------

After long term use with 100W radiated power, only a slight warming of the dipole near the feedpoint can be measured.

The dipole is made of standard semirigid coaxial cable. The center conductor of the feeding line is directly connected to the second arm of the dipole. The antenna is therefore short-circuited for DC-signals.

No excessive force must be applied to the dipole arms, because they might bend or the soldered connections near the feedpoint may be damaged.

Additional EUT Data

Manufactured by	SPEAG
Manufactured on	September 15, 2009

DASY5 Validation Report for Head TSL

Date/Time: 08.03.2010 10:52:27

Test Laboratory: SPEAG, Zurich, Switzerland

DUT: Dipole 835 MHz; Type: D835V2; Serial: D835V2 - SN:4d094

Communication System: CW; Frequency: 835 MHz; Duty Cycle: 1:1

Medium: HSL900

Medium parameters used: $f = 835 \text{ MHz}$; $\sigma = 0.91 \text{ mho/m}$; $\epsilon_r = 42.7$; $\rho = 1000 \text{ kg/m}^3$

Phantom section: Flat Section

Measurement Standard: DASY5 (IEEE/IEC/ANSI C63.19-2007)

DASY5 Configuration:

- Probe: ES3DV3 - SN3205; ConvF(6.04, 6.04, 6.04); Calibrated: 26.06.2009
- Sensor-Surface: 3mm (Mechanical Surface Detection)
- Electronics: DAE4 Sn601; Calibrated: 02.03.2010
- Phantom: Flat Phantom 4.9L; Type: QD000P49AA; Serial: 1001
- Measurement SW: DASY5, V5.2 Build 157; SEMCAD X Version 14.0 Build 57

Pin=250 mW /d=15mm, dist=3.0mm (ES-Probe)/Zoom Scan (7x7x7) /Cube 0: Measurement

grid: dx=5mm, dy=5mm, dz=5mm

Reference Value = 57.3 V/m; Power Drift = 0.00297 dB

Peak SAR (extrapolated) = 3.65 W/kg

SAR(1 g) = 2.43 mW/g; SAR(10 g) = 1.58 mW/g

Maximum value of SAR (measured) = 2.84 mW/g

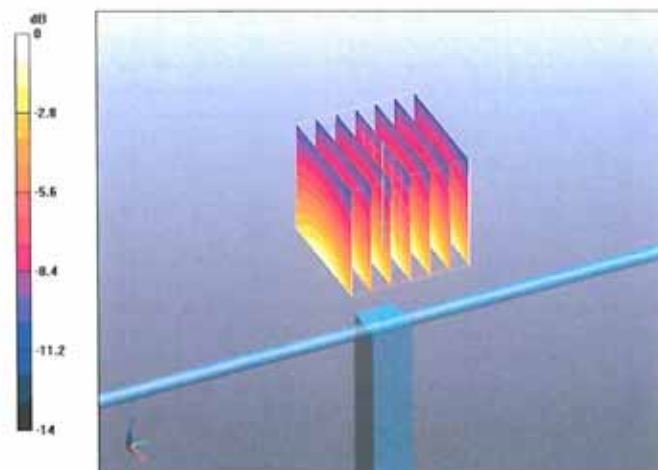

0 dB = 2.84mW/g

Impedance Measurement Plot for Head TSL

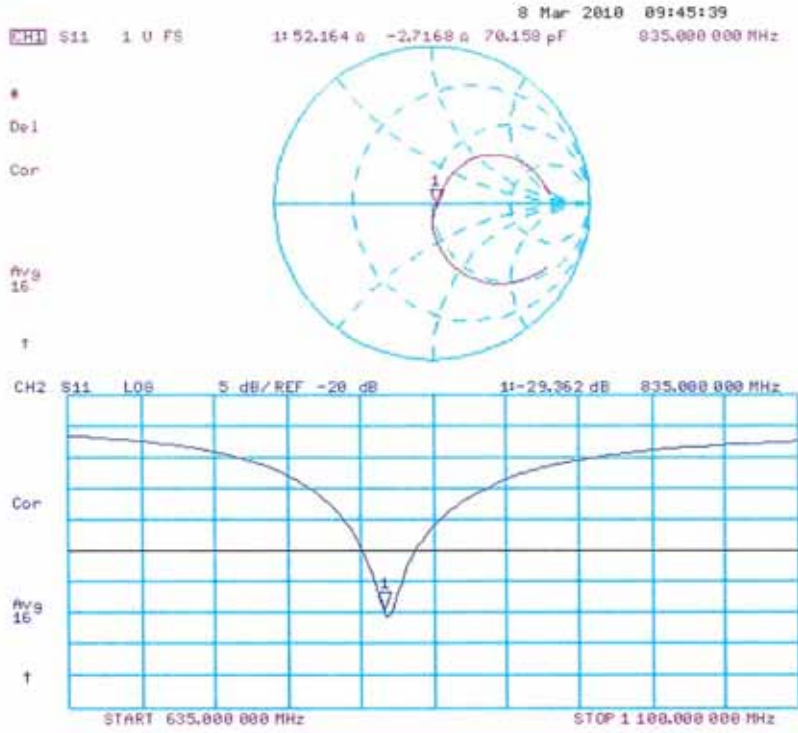

DASY5 Validation Report for Body

Date/Time: 15.03.2010 11:52:53

Test Laboratory: SPEAG, Zurich, Switzerland

DUT: Dipole 835 MHz; Type: D835V2; Serial: D835V2 - SN:4d094

Communication System: CW; Frequency: 835 MHz; Duty Cycle: 1:1

Medium: MSL900

Medium parameters used: $f = 835 \text{ MHz}$; $\sigma = 1.01 \text{ mho/m}$; $\epsilon_r = 55.3$; $\rho = 1000 \text{ kg/m}^3$

Phantom section: Flat Section

Measurement Standard: DASY5 (IEEE/IEC/ANSI C63.19-2007)

DASY5 Configuration:

- Probe: ES3DV3 - SN3205; ConvF(5.97, 5.97, 5.97); Calibrated: 26.06.2009
- Sensor-Surface: 3mm (Mechanical Surface Detection)
- Electronics: DAE4 Sn601; Calibrated: 02.03.2010
- Phantom: Flat Phantom 4.9L; Type: QD000P49AA; Serial: 1001
- Measurement SW: DASY5, V5.2 Build 157; SEMCAD X Version 14.0 Build 57

Pin250 mW /d=15mm, dist=3.0mm (ES-Probe)/Zoom Scan (7x7x7) /Cube 0: Measurement

grid: dx=5mm, dy=5mm, dz=5mm

Reference Value = 55.9 V/m; Power Drift = -0.00975 dB

Peak SAR (extrapolated) = 3.77 W/kg

SAR(1 g) = 2.55 mW/g; SAR(10 g) = 1.67 mW/g

Maximum value of SAR (measured) = 2.98 mW/g

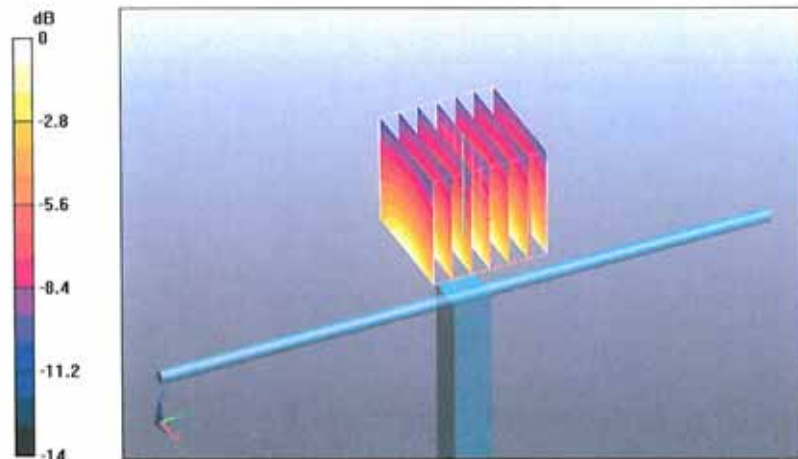

0 dB = 2.98mW/g

Impedance Measurement Plot for Body TSL

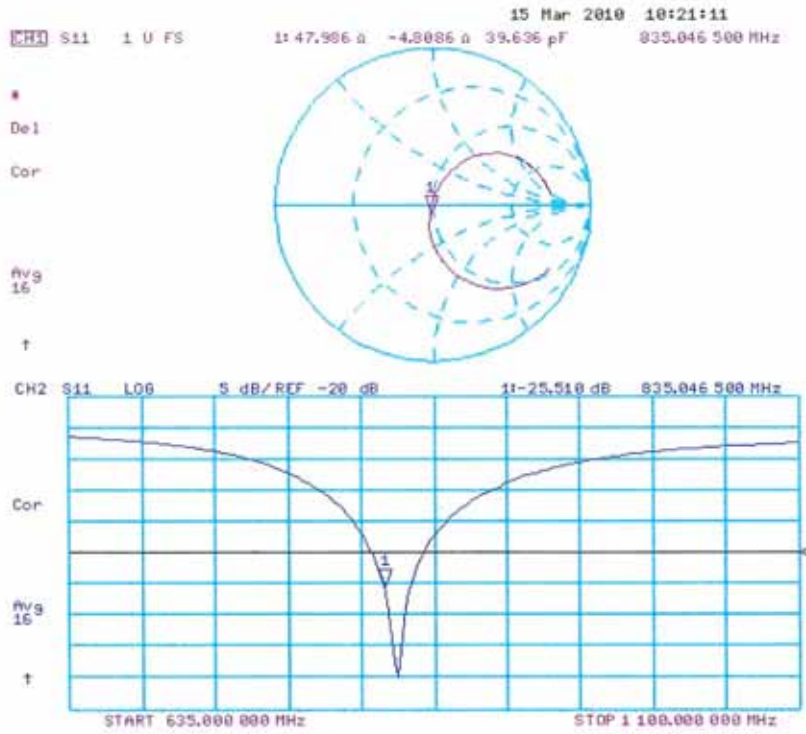

**Calibration Laboratory of
Schmid & Partner
Engineering AG**
Zeughausstrasse 43, 8004 Zurich, Switzerland



S Schweizerischer Kalibrierdienst
S Service suisse d'étalonnage
S Servizio svizzero di taratura
S Swiss Calibration Service

Accredited by the Swiss Accreditation Service (SAS)
The Swiss Accreditation Service is one of the signatories to the EA
Multilateral Agreement for the recognition of calibration certificates

Accreditation No.: **SCS 108**

Client **Quietek (Auden)**

Certificate No: **D1900V2-5d121_Mar10**

CALIBRATION CERTIFICATE

Object: **D1900V2 - SN: 5d121**

Calibration procedure(s): **QA CAL-05.v7
Calibration procedure for dipole validation kits**

Calibration date: **March 23, 2010**

This calibration certificate documents the traceability to national standards, which realize the physical units of measurements (SI).
The measurements and the uncertainties with confidence probability are given on the following pages and are part of the certificate.

All calibrations have been conducted in the closed laboratory facility: environment temperature (22 ± 3)°C and humidity < 70%.

Calibration Equipment used (M&TE critical for calibration)

Primary Standards	ID #	Cal Date (Certificate No.)	Scheduled Calibration
Power meter EPM-442A	GB37480704	06-Oct-09 (No. 217-01086)	Oct-10
Power sensor HP 8481A	US37292783	06-Oct-09 (No. 217-01086)	Oct-10
Reference 20 dB Attenuator	SN: 5086 (20g)	31-Mar-09 (No. 217-01025)	Mar-10
Type-N mismatch combination	SN: 5047.2 / 06327	31-Mar-09 (No. 217-01029)	Mar-10
Reference Probe ES3DV3	SN: 3205	26-Jun-09 (No. ES3-3205_Jun09)	Jun-10
DAE4	SN: 601	02-Mar-10 (No. DAE4-601_Mar10)	Mar-11
Secondary Standards	ID #	Check Date (in house)	Scheduled Check
Power sensor HP 8481A	MY41092317	18-Oct-02 (in house check Oct-09)	In house check: Oct-11
RF generator R&S SMT-06	100005	4-Aug-99 (in house check Oct-09)	In house check: Oct-11
Network Analyzer HP 8753E	US37390585 S4206	18-Oct-01 (in house check Oct-09)	In house check: Oct-10

	Name	Function	Signature
Calibrated by:	Dimce Iliev	Laboratory Technician	
Approved by:	Katja Pokovic	Technical Manager	

Issued: March 23, 2010

This calibration certificate shall not be reproduced except in full without written approval of the laboratory.

**Calibration Laboratory of
Schmid & Partner
Engineering AG**
Zeughausstrasse 43, 8004 Zurich, Switzerland



S Schweizerischer Kalibrierdienst
C Service suisse d'étalonnage
S Servizio svizzero di taratura
S Swiss Calibration Service

Accredited by the Swiss Accreditation Service (SAS)
The Swiss Accreditation Service is one of the signatories to the EA
Multilateral Agreement for the recognition of calibration certificates

Accreditation No.: **SCS 108**

Glossary:

TSL tissue simulating liquid
ConvF sensitivity in TSL / NORM x,y,z
N/A not applicable or not measured

Calibration is Performed According to the Following Standards:

- a) IEEE Std 1528-2003, "IEEE Recommended Practice for Determining the Peak Spatial-Averaged Specific Absorption Rate (SAR) in the Human Head from Wireless Communications Devices: Measurement Techniques", December 2003
- b) IEC 62209-1, "Procedure to measure the Specific Absorption Rate (SAR) for hand-held devices used in close proximity to the ear (frequency range of 300 MHz to 3 GHz)", February 2005
- c) Federal Communications Commission Office of Engineering & Technology (FCC OET), "Evaluating Compliance with FCC Guidelines for Human Exposure to Radiofrequency Electromagnetic Fields; Additional Information for Evaluating Compliance of Mobile and Portable Devices with FCC Limits for Human Exposure to Radiofrequency Emissions", Supplement C (Edition 01-01) to Bulletin 65

Additional Documentation:

- d) DASY4/5 System Handbook

Methods Applied and Interpretation of Parameters:

- *Measurement Conditions:* Further details are available from the Validation Report at the end of the certificate. All figures stated in the certificate are valid at the frequency indicated.
- *Antenna Parameters with TSL:* The dipole is mounted with the spacer to position its feed point exactly below the center marking of the flat phantom section, with the arms oriented parallel to the body axis.
- *Feed Point Impedance and Return Loss:* These parameters are measured with the dipole positioned under the liquid filled phantom. The impedance stated is transformed from the measurement at the SMA connector to the feed point. The Return Loss ensures low reflected power. No uncertainty required.
- *Electrical Delay:* One-way delay between the SMA connector and the antenna feed point. No uncertainty required.
- *SAR measured:* SAR measured at the stated antenna input power.
- *SAR normalized:* SAR as measured, normalized to an input power of 1 W at the antenna connector.
- *SAR for nominal TSL parameters:* The measured TSL parameters are used to calculate the nominal SAR result.

Measurement Conditions

DASY system configuration, as far as not given on page 1.

DASY Version	DASY5	V5.2
Extrapolation	Advanced Extrapolation	
Phantom	Modular Flat Phantom V5.0	
Distance Dipole Center - TSL	10 mm	with Spacer
Zoom Scan Resolution	dx, dy, dz = 5 mm	
Frequency	1900 MHz ± 1 MHz	

Head TSL parameters

The following parameters and calculations were applied.

	Temperature	Permittivity	Conductivity
Nominal Head TSL parameters	22.0 °C	40.0	1.40 mho/m
Measured Head TSL parameters	(22.0 ± 0.2) °C	41.1 ± 6 %	1.45 mho/m ± 6 %
Head TSL temperature during test	(21.5 ± 0.2) °C	----	----

SAR result with Head TSL

SAR averaged over 1 cm ³ (1 g) of Head TSL	Condition	
SAR measured	250 mW input power	10.1 mW / g
SAR normalized	normalized to 1W	40.4 mW / g
SAR for nominal Head TSL parameters	normalized to 1W	39.8 mW / g ± 17.0 % (k=2)

SAR averaged over 10 cm ³ (10 g) of Head TSL	condition	
SAR measured	250 mW input power	5.30 mW / g
SAR normalized	normalized to 1W	21.2 mW / g
SAR for nominal Head TSL parameters	normalized to 1W	21.1 mW / g ± 16.5 % (k=2)

Body TSL parameters

The following parameters and calculations were applied.

	Temperature	Permittivity	Conductivity
Nominal Body TSL parameters	22.0 °C	53.3	1.52 mho/m
Measured Body TSL parameters	(22.0 ± 0.2) °C	54.9 ± 6 %	1.58 mho/m ± 6 %
Body TSL temperature during test	(21.5 ± 0.2) °C	----	----

SAR result with Body TSL

SAR averaged over 1 cm ³ (1 g) of Body TSL	Condition	
SAR measured	250 mW input power	10.5 mW / g
SAR normalized	normalized to 1W	42.0 mW / g
SAR for nominal Body TSL parameters	normalized to 1W	41.4 mW / g ± 17.0 % (k=2)

SAR averaged over 10 cm ³ (10 g) of Body TSL	condition	
SAR measured	250 mW input power	5.60 mW / g
SAR normalized	normalized to 1W	22.4 mW / g
SAR for nominal Body TSL parameters	normalized to 1W	22.3 mW / g ± 16.5 % (k=2)

Appendix

Antenna Parameters with Head TSL

Impedance, transformed to feed point	50.6 Ω + 7.4 j Ω
Return Loss	- 22.7 dB

Antenna Parameters with Body TSL

Impedance, transformed to feed point	46.1 Ω + 7.1 j Ω
Return Loss	- 21.5 dB

General Antenna Parameters and Design

Electrical Delay (one direction)	1.205 ns
----------------------------------	----------

After long term use with 100W radiated power, only a slight warming of the dipole near the feedpoint can be measured.

The dipole is made of standard semirigid coaxial cable. The center conductor of the feeding line is directly connected to the second arm of the dipole. The antenna is therefore short-circuited for DC-signals.

No excessive force must be applied to the dipole arms, because they might bend or the soldered connections near the feedpoint may be damaged.

Additional EUT Data

Manufactured by	SPEAG
Manufactured on	August 25, 2009

DASY5 Validation Report for Head TSL

Date/Time: 23.03.2010 12:23:06

Test Laboratory: SPEAG, Zurich, Switzerland

DUT: Dipole 1900 MHz; Type: D1900V2; Serial: D1900V2 - SN:5d121

Communication System: CW; Frequency: 1900 MHz; Duty Cycle: 1:1

Medium: HSL U11 BB

Medium parameters used: $f = 1900$ MHz; $\sigma = 1.45$ mho/m; $\epsilon_r = 41.2$; $\rho = 1000$ kg/m³

Phantom section: Flat Section

Measurement Standard: DASY5 (IEEE/IEC/ANSI C63.19-2007)

DASY5 Configuration:

- Probe: ES3DV3 - SN3205; ConvF(5.09, 5.09, 5.09); Calibrated: 26.06.2009
- Sensor-Surface: 3mm (Mechanical Surface Detection)
- Electronics: DAE4 Sn601; Calibrated: 02.03.2010
- Phantom: Flat Phantom 5.0 (front); Type: QD000P50AA; Serial: 1001
- Measurement SW: DASY5, V5.2 Build 157; SEMCAD X Version 14.0 Build 57

Pin=250 mW /d=10mm, dist=3.0mm (ES-Probe)/Zoom Scan (7x7x7) /Cube 0: Measurement

grid: dx=5mm, dy=5mm, dz=5mm

Reference Value = 97.6 V/m; Power Drift = 0.00658 dB

Peak SAR (extrapolated) = 18.5 W/kg

SAR(1 g) = 10.1 mW/g; SAR(10 g) = 5.3 mW/g

Maximum value of SAR (measured) = 12.8 mW/g

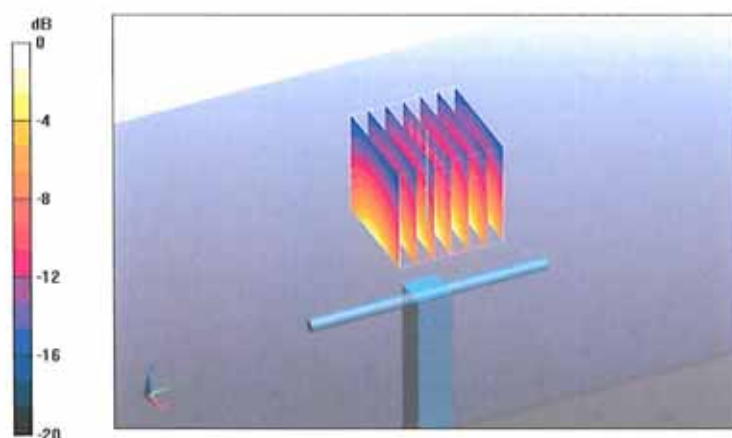

0 dB = 12.8mW/g

Impedance Measurement Plot for Head TSL

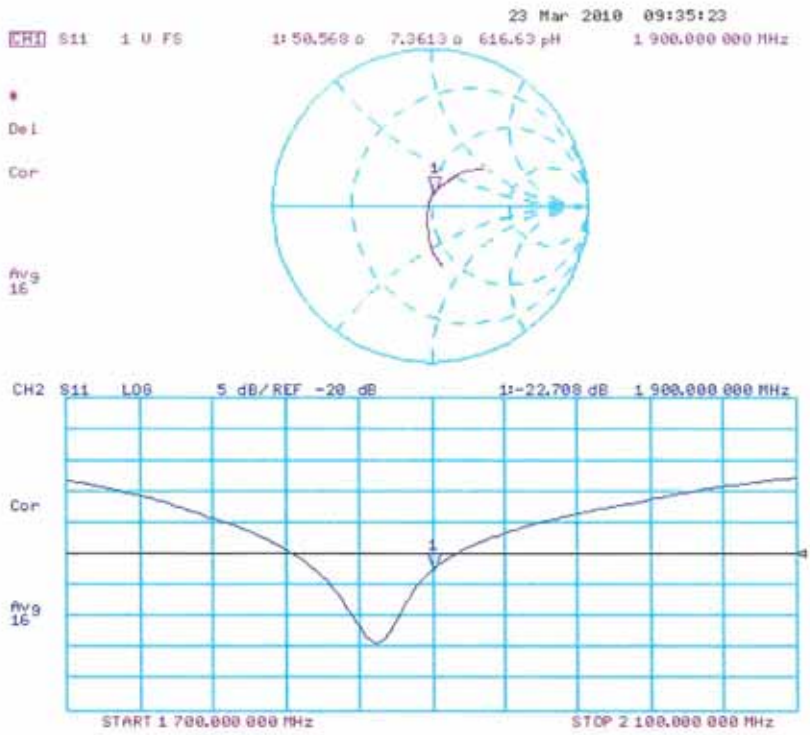

DASY5 Validation Report for Body

Date/Time: 17.03.2010 13:29:09

Test Laboratory: SPEAG, Zurich, Switzerland

DUT: Dipole 1900 MHz; Type: D1900V2; Serial: D1900V2 - SN:5d121

Communication System: CW; Frequency: 1900 MHz; Duty Cycle: 1:1

Medium: MSL U11 BB

Medium parameters used: $f = 1900$ MHz; $\sigma = 1.58$ mho/m; $\epsilon_r = 55$; $\rho = 1000$ kg/m³

Phantom section: Flat Section

Measurement Standard: DASY5 (IEEE/IEC/ANSI C63.19-2007)

DASY5 Configuration:

- Probe: ES3DV3 - SN3205; ConvF(4.59, 4.59, 4.59); Calibrated: 26.06.2009
- Sensor-Surface: 3mm (Mechanical Surface Detection)
- Electronics: DAE4 Sn601; Calibrated: 02.03.2010
- Phantom: Flat Phantom 5.0 (back); Type: QD000P50AA; Serial: 1002
- Measurement SW: DASY5, V5.2 Build 157; SEMCAD X Version 14.0 Build 57

Pin250 mW /d=10mm, dist=3.0mm (ES-Probe)/Zoom Scan (7x7x7) /Cube 0: Measurement

grid: dx=5mm, dy=5mm, dz=5mm

Reference Value = 97 V/m; Power Drift = 0.00345 dB

Peak SAR (extrapolated) = 17.6 W/kg

SAR(1 g) = 10.5 mW/g; SAR(10 g) = 5.6 mW/g

Maximum value of SAR (measured) = 13.3 mW/g

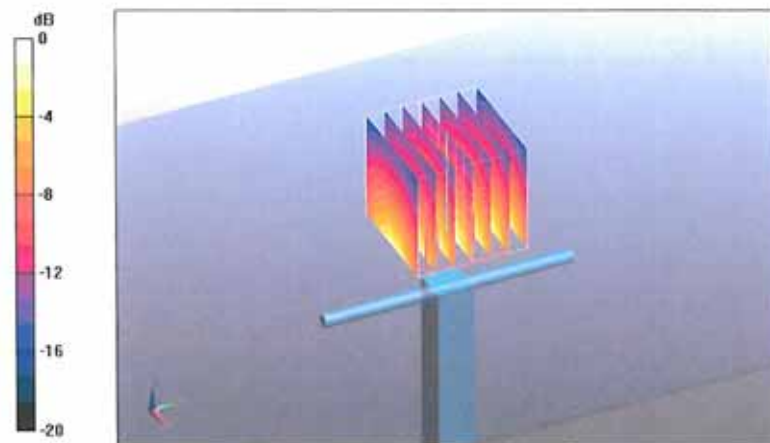

0 dB = 13.3mW/g

Impedance Measurement Plot for Body TSL

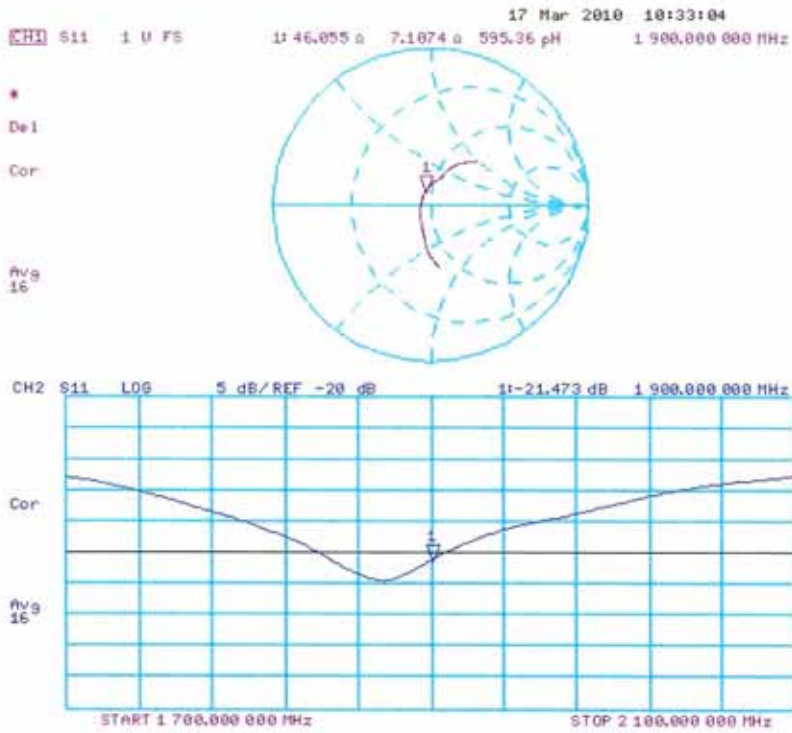

Appendix F. DAE Calibration Data

Calibration Laboratory of
 Schmid & Partner
 Engineering AG
 Zeughausstrasse 43, 8004 Zurich, Switzerland



S Schweizerischer Kalibrierdienst
S Service suisse d'étalonnage
C Servizio svizzero di taratura
S Swiss Calibration Service

Accredited by the Swiss Accreditation Service (SAS)
 The Swiss Accreditation Service is one of the signatories to the EA
 Multilateral Agreement for the recognition of calibration certificates

Accreditation No.: **SCS 108**

Client **Auden**

Certificate No: **DAE4-915_Jul11**

CALIBRATION CERTIFICATE

Object: **DAE4 - SD 000 D04 BK - SN: 915**

Calibration procedure(s): **QA CAL-06.v23
 Calibration procedure for the data acquisition electronics (DAE)**

Calibration date: **July 26, 2011**

This calibration certificate documents the traceability to national standards, which realize the physical units of measurements (SI).
 The measurements and the uncertainties with confidence probability are given on the following pages and are part of the certificate.

All calibrations have been conducted in the closed laboratory facility: environment temperature (22 ± 3)°C and humidity < 70%.

Calibration Equipment used (M&TE critical for calibration)

Primary Standards	ID #	Cal Date (Certificate No.)	Scheduled Calibration
Keithley Multimeter Type 2001	SN: 0810278	28-Sep-10 (No:10376)	Sep-11
Secondary Standards	ID #	Check Date (in house)	Scheduled Check
Calibrator Box V1.1	SE UMS 006 AB 1004	08-Jun-11 (in house check)	In house check: Jun-12

Calibrated by: **Andree Guntli** (Name), **Technician** (Function), *[Signature]* (Signature)

Approved by: **Fin Bormholt** (Name), **R&D Director** (Function), *[Signature]* (Signature)

Issued: July 26, 2011

This calibration certificate shall not be reproduced except in full without written approval of the laboratory.

**Calibration Laboratory of
Schmid & Partner
Engineering AG**
Zeughausstrasse 43, 8004 Zurich, Switzerland



S Schweizerischer Kalibrierdienst
C Service suisse d'étalonnage
S Servizio svizzero di taratura
S Swiss Calibration Service

Accredited by the Swiss Accreditation Service (SAS)
The Swiss Accreditation Service is one of the signatories to the EA
Multilateral Agreement for the recognition of calibration certificates

Accreditation No.: **SCS 108**

Glossary

DAE data acquisition electronics
Connector angle information used in DASY system to align probe sensor X to the robot coordinate system.

Methods Applied and Interpretation of Parameters

- *DC Voltage Measurement:* Calibration Factor assessed for use in DASY system by comparison with a calibrated instrument traceable to national standards. The figure given corresponds to the full scale range of the voltmeter in the respective range.
- *Connector angle:* The angle of the connector is assessed measuring the angle mechanically by a tool inserted. Uncertainty is not required.
- The following parameters as documented in the Appendix contain technical information as a result from the performance test and require no uncertainty.
 - *DC Voltage Measurement Linearity:* Verification of the Linearity at +10% and -10% of the nominal calibration voltage. Influence of offset voltage is included in this measurement.
 - *Common mode sensitivity:* Influence of a positive or negative common mode voltage on the differential measurement.
 - *Channel separation:* Influence of a voltage on the neighbor channels not subject to an input voltage.
 - *AD Converter Values with inputs shorted:* Values on the internal AD converter corresponding to zero input voltage
 - *Input Offset Measurement:* Output voltage and statistical results over a large number of zero voltage measurements.
 - *Input Offset Current:* Typical value for information; Maximum channel input offset current, not considering the input resistance.
 - *Input resistance:* Typical value for information: DAE input resistance at the connector, during internal auto-zeroing and during measurement.
 - *Low Battery Alarm Voltage:* Typical value for information. Below this voltage, a battery alarm signal is generated.
 - *Power consumption:* Typical value for information. Supply currents in various operating modes.

DC Voltage Measurement

A/D - Converter Resolution nominal

High Range: 1LSB = 6.1 μ V, full range = -100...+300 mV

Low Range: 1LSB = 61nV, full range = -1.....+3mV

DASY measurement parameters: Auto Zero Time: 3 sec; Measuring time: 3 sec

Calibration Factors	X	Y	Z
High Range	404.285 \pm 0.1% (k=2)	404.391 \pm 0.1% (k=2)	404.754 \pm 0.1% (k=2)
Low Range	3.97635 \pm 0.7% (k=2)	4.00755 \pm 0.7% (k=2)	3.98639 \pm 0.7% (k=2)

Connector Angle

Connector Angle to be used in DASY system	116.0 \circ \pm 1 \circ
-------------------------------------------	-------------------------------

Appendix

1. DC Voltage Linearity

High Range	Reading (μV)	Difference (μV)	Error (%)
Channel X + Input	200000.4	-0.64	-0.00
Channel X + Input	20001.45	1.55	0.01
Channel X - Input	-19997.34	2.36	-0.01
Channel Y + Input	199995.7	-0.78	-0.00
Channel Y + Input	19998.85	-1.15	-0.01
Channel Y - Input	-19999.50	0.20	-0.00
Channel Z + Input	199994.5	-1.17	-0.00
Channel Z + Input	19999.11	-0.79	-0.00
Channel Z - Input	-19999.13	0.37	-0.00

Low Range	Reading (μV)	Difference (μV)	Error (%)
Channel X + Input	1999.6	-0.27	-0.01
Channel X + Input	200.22	0.52	0.26
Channel X - Input	-199.22	0.78	-0.39
Channel Y + Input	1999.9	-0.17	-0.01
Channel Y + Input	199.72	-0.28	-0.14
Channel Y - Input	-200.18	-0.28	0.14
Channel Z + Input	1999.9	0.05	0.00
Channel Z + Input	199.87	-0.13	-0.07
Channel Z - Input	-200.28	-0.38	0.19

2. Common mode sensitivity

DASY measurement parameters: Auto Zero Time: 3 sec; Measuring time: 3 sec

	Common mode Input Voltage (mV)	High Range Average Reading (μV)	Low Range Average Reading (μV)
Channel X	200	-15.44	-17.05
	-200	18.73	17.12
Channel Y	200	-5.83	-6.14
	-200	5.34	4.60
Channel Z	200	-0.97	-1.09
	-200	-0.24	-0.53

3. Channel separation

DASY measurement parameters: Auto Zero Time: 3 sec; Measuring time: 3 sec

	Input Voltage (mV)	Channel X (μV)	Channel Y (μV)	Channel Z (μV)
Channel X	200	-	3.91	0.10
Channel Y	200	2.17	-	5.26
Channel Z	200	0.57	-0.09	-

4. AD-Converter Values with inputs shorted

DASY measurement parameters: Auto Zero Time: 3 sec; Measuring time: 3 sec

	High Range (LSB)	Low Range (LSB)
Channel X	16140	15733
Channel Y	15996	15679
Channel Z	15882	15699

5. Input Offset Measurement

DASY measurement parameters: Auto Zero Time: 3 sec; Measuring time: 3 sec

Input 10MΩ

	Average (μV)	min. Offset (μV)	max. Offset (μV)	Std. Deviation (μV)
Channel X	0.08	-0.73	2.01	0.38
Channel Y	-1.66	-4.46	-0.38	0.45
Channel Z	0.49	-0.80	1.79	0.32

6. Input Offset Current

Nominal Input circuitry offset current on all channels: <25fA

7. Input Resistance (Typical values for information)

	Zeroing (kOhm)	Measuring (MOhm)
Channel X	200	200
Channel Y	200	200
Channel Z	200	200

8. Low Battery Alarm Voltage (Typical values for information)

Typical values	Alarm Level (VDC)
Supply (+ Vcc)	+7.9
Supply (- Vcc)	-7.6

9. Power Consumption (Typical values for information)

Typical values	Switched off (mA)	Stand by (mA)	Transmitting (mA)
Supply (+ Vcc)	+0.01	+6	+14
Supply (- Vcc)	-0.01	-8	-9