

---

# FCC Test Report

---

Report No.: AGC00688140802FE04

**FCC ID** : UOSAM513  
**APPLICATION PURPOSE** : Original Equipment  
**PRODUCT DESIGNATION** : mobile phone  
**BRAND NAME** : AMGOO  
**MODEL NAME** : AM513  
**CLIENT** : AMGOO TELECOM (Shenzhen) CO., LTD.  
**DATE OF ISSUE** : Sept.02, 2014  
**STANDARD(S)** : FCC Part 15.247  
**TEST PROCEDURE(S)** : KDB 558074 v03r02  
**REPORT VERSION** : V1.0

Attestation of *Global Compliance (Shenzhen) Co., Ltd*

**CAUTION:**

This report shall not be reproduced except in full without the written permission of the test laboratory and shall not be quoted out of context.



**Report Revise Record**

<b>Report Version</b>	<b>Revise Time</b>	<b>Issued Date</b>	<b>Valid Version</b>	<b>Notes</b>
V1.0	/	Sept.02, 2014	Valid	Original Report

## TABLE OF CONTENTS

<b>1. VERIFICATION OF CONFORMITY .....</b>	<b>5</b>
<b>2. GENERAL INFORMATION .....</b>	<b>6</b>
2.1. PRODUCT DESCRIPTION.....	6
2.2. TABLE OF CARRIER FREQUENCIES.....	6
2.3. IEEE 802.11N MODULATION SCHEME .....	7
2.4. RELATED SUBMITTAL(S) / GRANT (S).....	7
2.5. TEST METHODOLOGY.....	7
2.6. SPECIAL ACCESSORIES .....	7
2.7. EQUIPMENT MODIFICATIONS .....	8
<b>3. MEASUREMENT UNCERTAINTY.....</b>	<b>9</b>
<b>4. DESCRIPTION OF TEST MODES.....</b>	<b>9</b>
<b>5. SYSTEM TEST CONFIGURATION .....</b>	<b>10</b>
5.1. CONFIGURATION OF EUT SYSTEM .....	10
5.2. EQUIPMENT USED IN EUT SYSTEM .....	10
5.3. SUMMARY OF TEST RESULTS .....	10
<b>6. TEST FACILITY .....</b>	<b>11</b>
<b>7. PEAK OUTPUT POWER .....</b>	<b>12</b>
7.1. MEASUREMENT PROCEDURE .....	12
7.2. TEST SET-UP (BLOCK DIAGRAM OF CONFIGURATION).....	13
7.3. LIMITS AND MEASUREMENT RESULT .....	14
<b>8. 6DB BANDWIDTH .....</b>	<b>16</b>
8.1. MEASUREMENT PROCEDURE .....	16
8.2. TEST SET-UP (BLOCK DIAGRAM OF CONFIGURATION).....	16
8.3. LIMITS AND MEASUREMENT RESULTS.....	17
<b>9. CONDUCTED SPURIOUS EMISSION .....</b>	<b>25</b>
9.1. MEASUREMENT PROCEDURE .....	25
9.2. TEST SET-UP (BLOCK DIAGRAM OF CONFIGURATION).....	25
9.3. MEASUREMENT EQUIPMENT USED.....	25
9.4. LIMITS AND MEASUREMENT RESULT .....	25
<b>10. MAXIMUM CONDUCTED OUTPUT PEAK POWER SPECTRAL DENSITY .....</b>	<b>32</b>
10.1 MEASUREMENT PROCEDURE .....	32
10.2 TEST SET-UP (BLOCK DIAGRAM OF CONFIGURATION).....	32
10.3 MEASUREMENT EQUIPMENT USED.....	32
10.4 LIMITS AND MEASUREMENT RESULT .....	32

- 11. RADIATED EMISSION ..... 40**
  - 11.1. MEASUREMENT PROCEDURE ..... 40
  - 11.2. TEST SETUP ..... 41
  - 11.3. LIMITS AND MEASUREMENT RESULT ..... 42
  - 11.4. TEST RESULT ..... 42
- 12. BAND EDGE EMISSION ..... 51**
  - 12.1. MEASUREMENT PROCEDURE ..... 51
  - 12.2. TEST SET-UP ..... 51
  - 12.3. Radiated Test Result ..... 52
  - 12.4. Conducted Test Result ..... 56
- 13. FCC LINE CONDUCTED EMISSION TEST ..... 59**
  - 13.1. LIMITS OF LINE CONDUCTED EMISSION TEST ..... 59
  - 13.2. BLOCK DIAGRAM OF LINE CONDUCTED EMISSION TEST ..... 59
  - 13.3. PRELIMINARY PROCEDURE OF LINE CONDUCTED EMISSION TEST ..... 60
  - 13.4. FINAL PROCEDURE OF LINE CONDUCTED EMISSION TEST ..... 60
  - 13.5. TEST RESULT OF LINE CONDUCTED EMISSION TEST ..... 61
- APPENDIX A: PHOTOGRAPHS OF TEST SETUP ..... 63**
- APPENDIX B: PHOTOGRAPHS OF EUT ..... 64**

### 1. VERIFICATION OF CONFORMITY

<b>Applicant</b>	AMGOO TELECOM (Shenzhen) CO., LTD.
<b>Address</b>	3/F, Block R2-A(North),Gaoxin S. Ave. 4th, Hi-Tech Industrial Park, Nanshan District, Shenzhen, China
<b>Manufacturer</b>	AMGOO TELECOM (Shenzhen) CO., LTD.
<b>Address</b>	3/F, Block R2-A(North),Gaoxin S. Ave. 4th, Hi-Tech Industrial Park, Nanshan District, Shenzhen, China
<b>Product Designation</b>	mobile phone
<b>Brand Name</b>	AMGOO
<b>Test Model</b>	AM513
<b>Date of test</b>	Aug.23, 2014 to Aug.30, 2014
<b>Deviation</b>	None
<b>Condition of Test Sample</b>	Normal
<b>Report Template</b>	AGCRT-US-BGN/RF

We hereby certify that:

The above equipment was tested by Attestation of Global Compliance (Shenzhen) Co., Ltd. The test data, data evaluation, test procedures, and equipment configurations shown in this report were made in accordance with the procedures given in ANSI C63.4 (2003) and the energy emitted by the sample EUT tested as described in this report is in compliance with requirement of FCC Part 15 Rules requirement.

Prepared By	<u>Matt Zhang</u>
	Matt Zhang      Sept.02, 2014
Checked By	<u>Kidd Yang</u>
	Kidd Yang      Sept.02, 2014
Authorized By	<u>Solger Zhang</u>
	Solger Zhang      Sept.02, 2014

## 2. GENERAL INFORMATION

### 2.1. PRODUCT DESCRIPTION

The EUT is designed as “mobile phone”. It is designed by way of utilizing the DSSS and OFDM technology to achieve the system operation.

A major technical description of EUT is described as following

<b>Operation Frequency</b>	2.412 GHz~2.462GHz
<b>Output Power</b>	IEEE 802.11b:11.23dBm; IEEE 802.11g:9.36dBm; IEEE 802.11n(20):8.87dBm; IEEE 802.11n(40):6.24dBm
<b>Modulation</b>	DSSS(DBPSK/DQPSK/CCK);OFDM(BPSK/QPSK/16-QAM/64-QAM)
<b>Number of channels</b>	11
<b>Hardware Version</b>	YK828_MB_V1.0
<b>Software Version</b>	N/A
<b>Antenna Designation</b>	Integrated Antenna
<b>Antenna Gain</b>	1.0 dBi
<b>Power Supply</b>	DC3.7V by Built-in Li-ion Battery

### 2.2. TABLE OF CARRIER FREQUENCIES

Frequency Band	Channel Number	Frequency
2400~2483.5MHZ	1	2412 MHZ
	2	2417 MHZ
	3	2422 MHZ
	4	2427 MHZ
	5	2432 MHZ
	6	2437 MHZ
	7	2442 MHZ
	8	2447 MHZ
	9	2452 MHZ
	10	2457 MHZ
	11	2462 MHZ

Note: For 20MHZ bandwidth system use Channel 1 to Channel 11  
For 40MHZ bandwidth system use Channel 3 to Channel 9

### 2.3. IEEE 802.11N MODULATION SCHEME

MCS Index	Nss	Modulation	R	NBPS	NCBPS		NDBPS		Data rate(Mbps)			
					800nsGI		20MHz	40MHz	20MHz	40MHz	20MHz	40MHz
					20MHz	40MHz						
0	1	BPSK	1/2	1	52	108	26	54	6.5	13.5		
1	1	QPSK	1/2	2	104	216	52	108	13.0	27.0		
2	1	QPSK	3/4	2	104	216	78	162	19.5	40.5		
3	1	16-QAM	1/2	4	208	432	104	216	26.0	54.0		
4	1	16-QAM	3/4	4	208	432	156	324	39.0	81.0		
5	1	64-QAM	2/3	6	312	648	208	432	52.0	108.0		
6	1	64-QAM	3/4	6	312	648	234	489	58.5	121.5		
7	1	64-QAM	5/6	6	312	648	260	540	65.0	135.0		

Symbol	Explanation
NSS	Number of spatial streams
R	Code rate
NBPS	Number of coded bits per single carrier
NCBPS	Number of coded bits per symbol
NDBPS	Number of data bits per symbol
GI	Guard interval

### 2.4. RELATED SUBMITTAL(S) / GRANT (S)

This submittal(s) (test report) is intended for **FCC ID: UOSAM513** filing to comply with the FCC Part 15 requirements.

### 2.5. TEST METHODOLOGY

Both conducted and radiated testing was performed according to the procedures in ANSI C63.4 (2003).

Radiated testing was performed at an antenna to EUT distance 3 meters.

Others testing (listed at item 5.3) was performed according to the procedures in FCC Part 15.247 rules KDB 558074 D01 DTS Meas Guidance v03r02.

### 2.6. SPECIAL ACCESSORIES

Refer to section 5.2.

## **2.7. EQUIPMENT MODIFICATIONS**

Not available for this EUT intended for grant.



### 3. MEASUREMENT UNCERTAINTY

Conducted measurement: +/- 2.75dB

Radiated measurement: +/- 3.2dB

### 4. DESCRIPTION OF TEST MODES

NO.	TEST MODE DESCRIPTION
1	Low channel TX
2	Middle channel TX
3	High channel TX
4	Normal operating

**Note:**

Transmit by 802.11b with Data rate (1/2/5.5/11)

Transmit by 802.11g with Data rate (6/9/12/18/24/36/48/54)

Transmit by 802.11n (20MHz) with Data rate (6.5/13/19.5/26/39/52/58.5/65)

Transmit by 802.11n (40MHz) with Data rate

(13.5/27/40.5/54/81/108/121.5/135)

**Note:**

1. The EUT has been set to operate continuously on the lowest, middle and highest operation frequency Individually, and the eut is operating at its maximum duty cycle>or equal 98%
2. All modes under which configure applicable have been tested and the worst mode test data recording in the test report, if no other mode data.
3. For Radiated Emission, 3axis were chosen for testing for each applicable mode.

## 5. SYSTEM TEST CONFIGURATION

### 5.1. CONFIGURATION OF EUT SYSTEM

Configure:

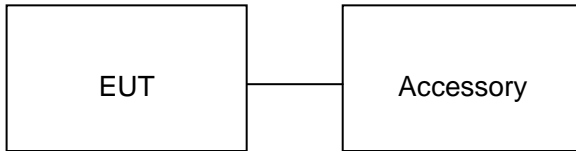

### 5.2. EQUIPMENT USED IN EUT SYSTEM

Item	Equipment	Model No.	ID or Specification	Remark
1	Mobile phone	AM513	FCC ID:UOSAM513	EUT
2	Adapter	CH17	DC5.0V / 500mA	Accessory
3	Battery	AM513	DC3.7V / 1350 mAh	Accessory
4	Earphone	AM513	N/A	Accessory
5	USB Cable	AM513	N/A	Accessory

Note: All the accessories have been used during the test in conduction emission test.

### 5.3. SUMMARY OF TEST RESULTS

FCC RULES	DESCRIPTION OF TEST	RESULT
§15.247	Peak Output Power	Compliant
§15.247	6 dB Bandwidth	Compliant
§15.247	Conducted Spurious Emission	Compliant
§15.247	Maximum Conducted Output Power SPECTRAL Density	Compliant
§15.209	Radiated Emission	Compliant
§15.247	Band Edges	Compliant
§15.207	Line Conduction Emission	Compliant

**Note:** The EUT received power from DC3.7V lithium battery.

**6. TEST FACILITY**

<b>Site</b>	Attestation of Global Compliance (Shenzhen) Co., Ltd
<b>Location</b>	2/F., Building 2, No.1-No.4, Chaxi Sanwei Technical Industrial Park, Gushu, Xixiang, Bao'an District, Shenzhen, Guangdong, China
<b>Description</b>	The test site is constructed and calibrated to meet the FCC requirements in documents ANSI C63.4:2003.

**ALL TEST EQUIPMENT LIST**

<b>Description</b>	<b>Manufacturer</b>	<b>Model</b>	<b>S/N</b>	<b>Cal. Date</b>	<b>Cal. Due</b>
Power Probe	R&S	NRP-Z23	100323	07/25/2014	07/24/2015
Power Meter	Agilent	N1911A	MY45100361	04/20/2014	04/20/2015
RF attenuator	N/A	RFA20db	68	N/A	N/A
Spectrum Analyzer	Agilent	E4440A	US41421290	07/25/2014	07/24/2015
Amplifier	EM	EM30180	0607030	02/27/2014	02/26/2015
Horn Antenna	EM	EM-AH-10180	67	04/19/2014	04/18/2015
Horn Antenna	A.H. Systems Inc.	SAS-574	--	07/25/2014	07/24/2015
EMI Test Receiver	Rohde & Schwarz	ESCI	100694	07/25/2014	07/24/2015
Biological Antenna	A.H. Systems Inc.	SAS-521-4	26	06/06/2014	06/05/2015
Loop Antenna	A.H.	SAS-526B	264	07/13/2014	07/12/2015
LISN	R&S	ESH3-Z5	8389791009	07/25/2014	07/24/2015
Radiation Cable 1	Sat	RE1	R003	06/04/2014	06/03/2015
Radiation Cable 2	Sat	RE2	R002	06/04/2014	06/03/2015
Conduction Cable	Sat	CE1	C001	06/04/2014	06/03/2015

## 7. PEAK OUTPUT POWER

### 7.1. MEASUREMENT PROCEDURE

For peak power test:

1. Use a direct connection between the antenna port of the transmitter and the power meter, through suitable attenuation
2. Set the bandwidth of the power meter is 40MHz
3. Record the peak value

For average power test:

1. Connect EUT RF output port to power probe through an RF attenuator.
2. Connect the power probe to the PC.
3. Set the EUT Work on the top, the middle and the bottom operation frequency individually.
4. Record the maximum power from the software.
5. The maximum peak power shall be less 1 Watt (30dBm).

**Note** : The EUT was tested according to KDB 558074v03r02 for compliance to FCC 47CFR 15.247 requirements.

**7.2. TEST SET-UP (BLOCK DIAGRAM OF CONFIGURATION)**

**PEAK POWER TEST SETUP**

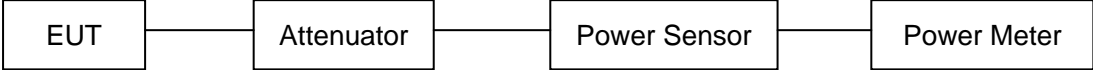

**AVERAGE POWER SETUP**

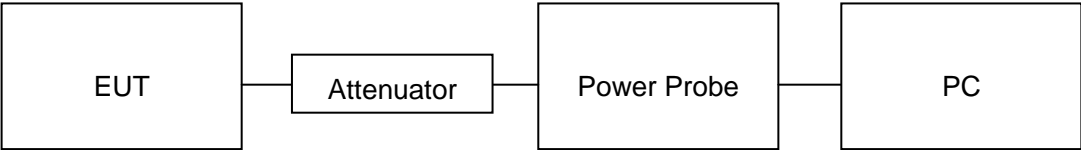

**7.3. LIMITS AND MEASUREMENT RESULT**

<b>TEST ITEM</b>	PEAK POWER
<b>TEST MODE</b>	802.11b with data rate 1

<b>LIMITS AND MEASUREMENT RESULT</b>				
<b>Frequency (GHz)</b>	<b>Average Power (dBm)</b>	<b>Peak Power (dBm)</b>	<b>Applicable Limits (dBm)</b>	<b>Pass or Fail</b>
2.412	9.25	11.23	30	Pass
2.437	9.14	11.12	30	Pass
2.462	9.09	11.07	30	Pass

<b>TEST ITEM</b>	PEAK POWER
<b>TEST MODE</b>	802.11g with data rate 6

<b>LIMITS AND MEASUREMENT RESULT</b>				
<b>Frequency (GHz)</b>	<b>Average Power (dBm)</b>	<b>Peak Power (dBm)</b>	<b>Applicable Limits (dBm)</b>	<b>Pass or Fail</b>
2.412	7.38	9.36	30	Pass
2.437	7.29	9.27	30	Pass
2.462	7.18	9.16	30	Pass

<b>TEST ITEM</b>	PEAK POWER
<b>TEST MODE</b>	802.11n 20 with data rate 6.5

<b>LIMITS AND MEASUREMENT RESULT</b>				
<b>Frequency (GHz)</b>	<b>Average Power (dBm)</b>	<b>Peak Power (dBm)</b>	<b>Applicable Limits (dBm)</b>	<b>Pass or Fail</b>
2.412	6.89	8.87	30	Pass
2.437	6.48	8.46	30	Pass
2.462	6.34	8.32	30	Pass

<b>TEST ITEM</b>	PEAK POWER
<b>TEST MODE</b>	802.11n 40 with data rate 13.5

<b>LIMITS AND MEASUREMENT RESULT</b>				
<b>Frequency (GHz)</b>	<b>Average Power (dBm)</b>	<b>Peak Power (dBm)</b>	<b>Applicable Limits (dBm)</b>	<b>Pass or Fail</b>
2.422	4.26	6.24	30	Pass
2.437	4.19	6.17	30	Pass
2.452	4.14	6.12	30	Pass

## 8. 6DB BANDWIDTH

### 8.1. MEASUREMENT PROCEDURE

1. Connect EUT RF output port to the Spectrum Analyzer through an RF attenuator
2. Set the EUT Work on the top, the middle and the bottom operation frequency individually.
3. Set SPA Centre Frequency = Operation Frequency, RBW= 100 KHz, VBW $\geq$ 3 $\times$ RBW.
4. Set SPA Trace 1 Max hold, then View.

**Note:** The EUT was tested according to KDB 558074 for compliance to FCC 47CFR 15.247 requirements.

### 8.2. TEST SET-UP (BLOCK DIAGRAM OF CONFIGURATION)

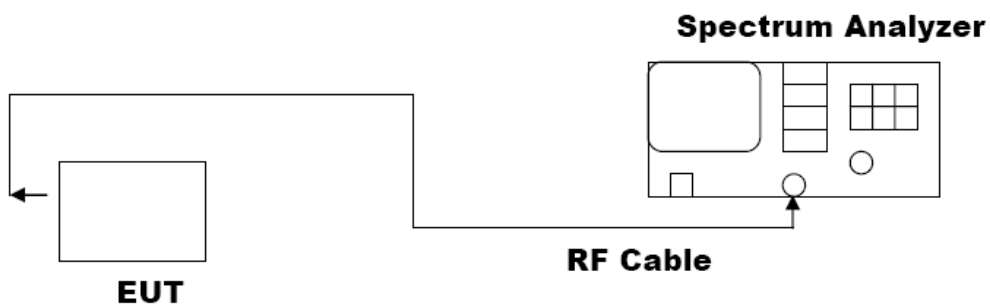



**8.3. LIMITS AND MEASUREMENT RESULTS**

<b>TEST ITEM</b>	6DB BANDWIDTH
<b>TEST MODE</b>	802.11b with data rate 11

<b>LIMITS AND MEASUREMENT RESULT</b>			
<b>Applicable Limits</b>	<b>Applicable Limits</b>		
	<b>Test Data (MHz)</b>		<b>Criteria</b>
>500KHZ	Low Channel	9.565	PASS
	Middle Channel	9.073	PASS
	High Channel	9.566	PASS

<b>TEST ITEM</b>	6DB BANDWIDTH
<b>TEST MODE</b>	802.11g with data rate 54

<b>LIMITS AND MEASUREMENT RESULT</b>			
<b>Applicable Limits</b>	<b>Applicable Limits</b>		
	<b>Test Data (MHz)</b>		<b>Criteria</b>
>500KHZ	Low Channel	16.293	PASS
	Middle Channel	15.154	PASS
	High Channel	16.289	PASS

<b>TEST ITEM</b>	6DB BANDWIDTH
<b>TEST MODE</b>	802.11n 20 with data rate 65

<b>LIMITS AND MEASUREMENT RESULT</b>			
<b>Applicable Limits</b>	<b>Applicable Limits</b>		
	<b>Test Data (MHz)</b>		<b>Criteria</b>
>500KHZ	Low Channel	17.283	PASS
	Middle Channel	15.450	PASS
	High Channel	15.072	PASS

<b>TEST ITEM</b>	6DB BANDWIDTH
<b>TEST MODE</b>	802.11n 40 with data rate 135

<b>LIMITS AND MEASUREMENT RESULT</b>			
<b>Applicable Limits</b>	<b>Applicable Limits</b>		
	<b>Test Data (MHz)</b>		<b>Criteria</b>
>500KHZ	Low Channel	35.167	PASS
	Middle Channel	35.098	PASS
	High Channel	35.087	PASS

**802.11b TEST RESULT**  
**TEST PLOT OF BANDWIDTH FOR LOW CHANNEL**

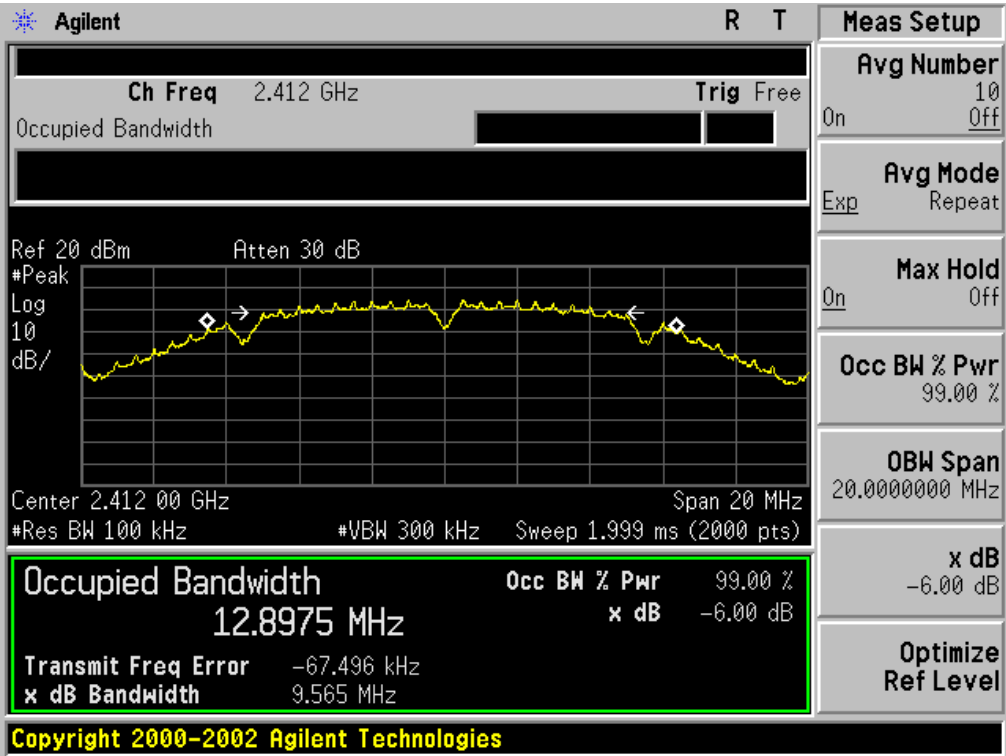

**TEST PLOT OF BANDWIDTH FOR MIDDLE CHANNEL**

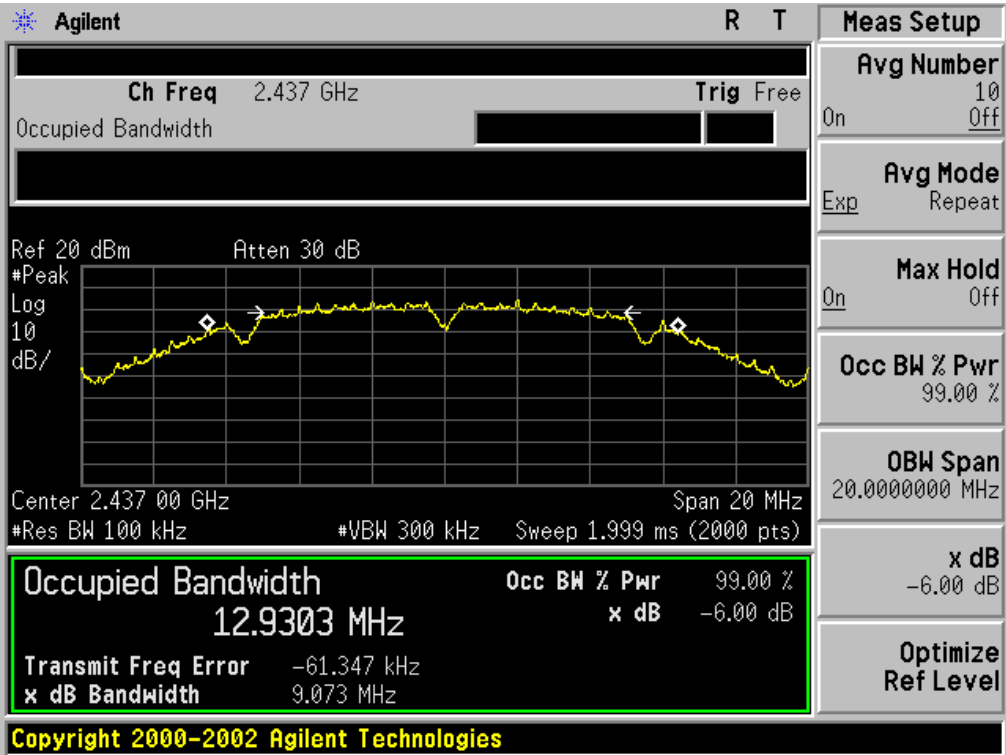

TEST PLOT OF BANDWIDTH FOR HIGH CHANNEL

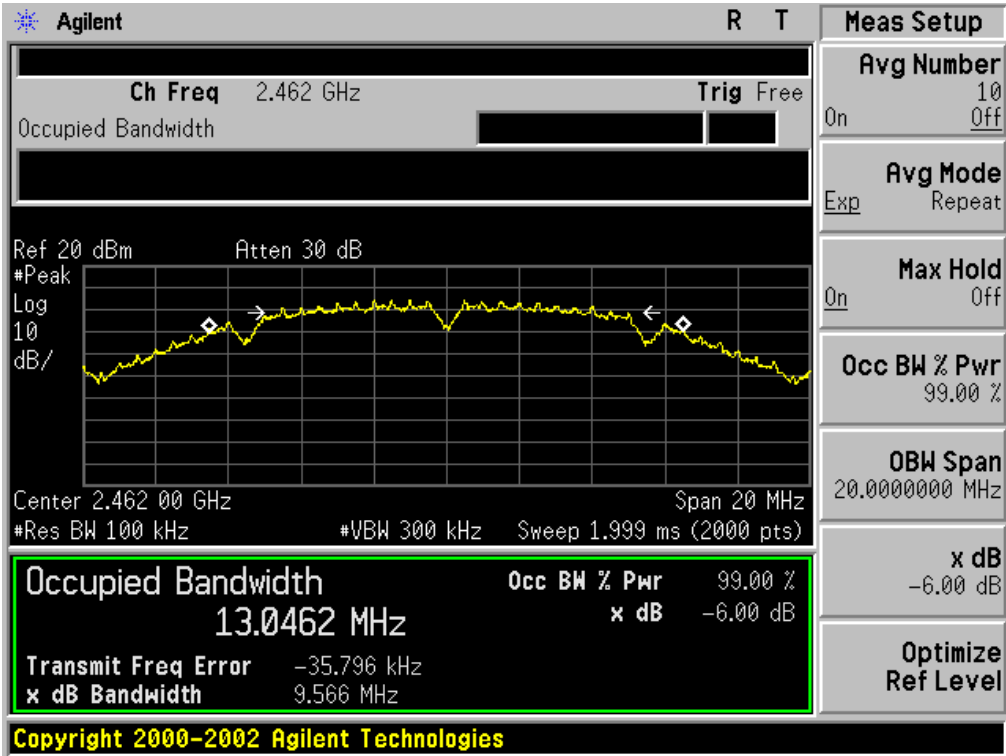

802.11g TEST RESULT

TEST PLOT OF BANDWIDTH FOR LOW CHANNEL

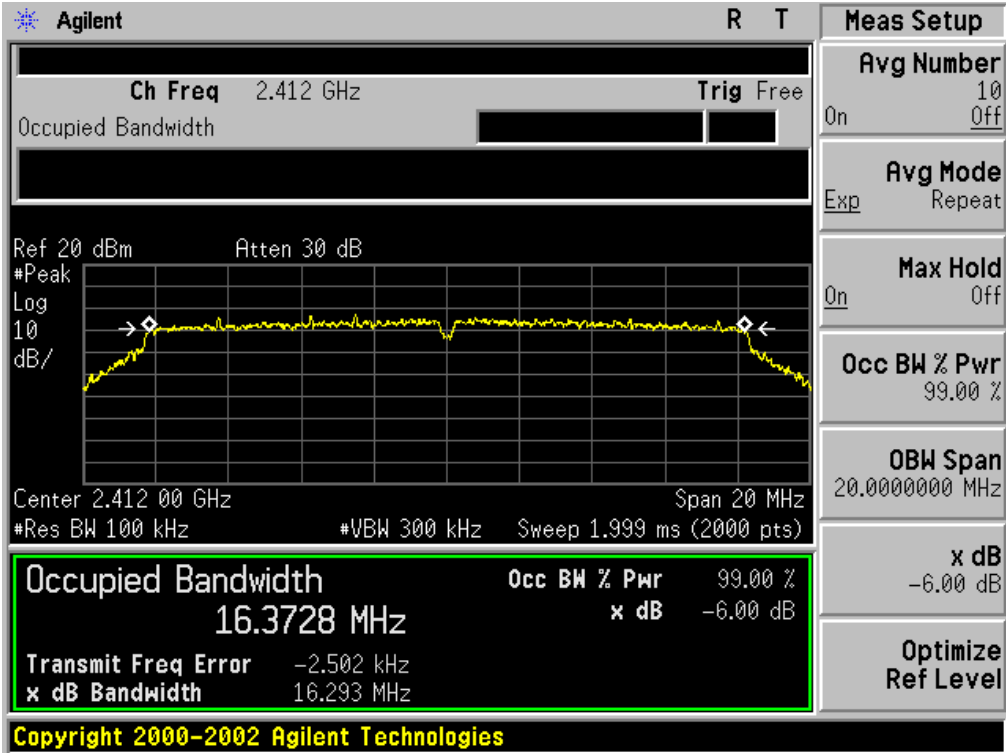

TEST PLOT OF BANDWIDTH FOR MIDDLE CHANNEL

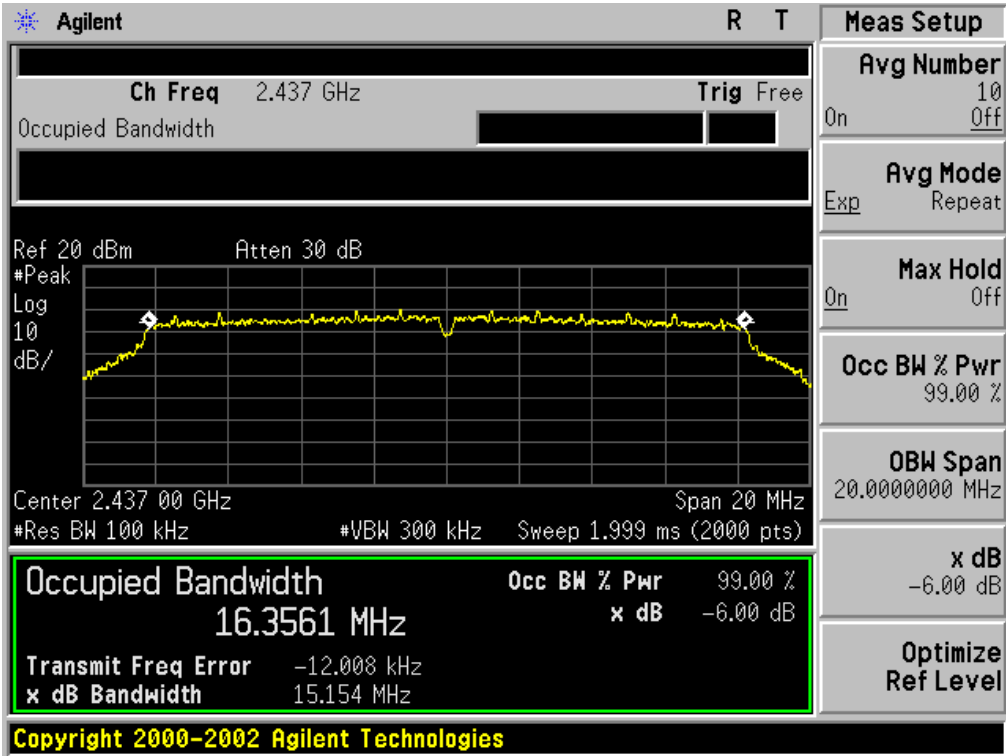

TEST PLOT OF BANDWIDTH FOR HIGH CHANNEL

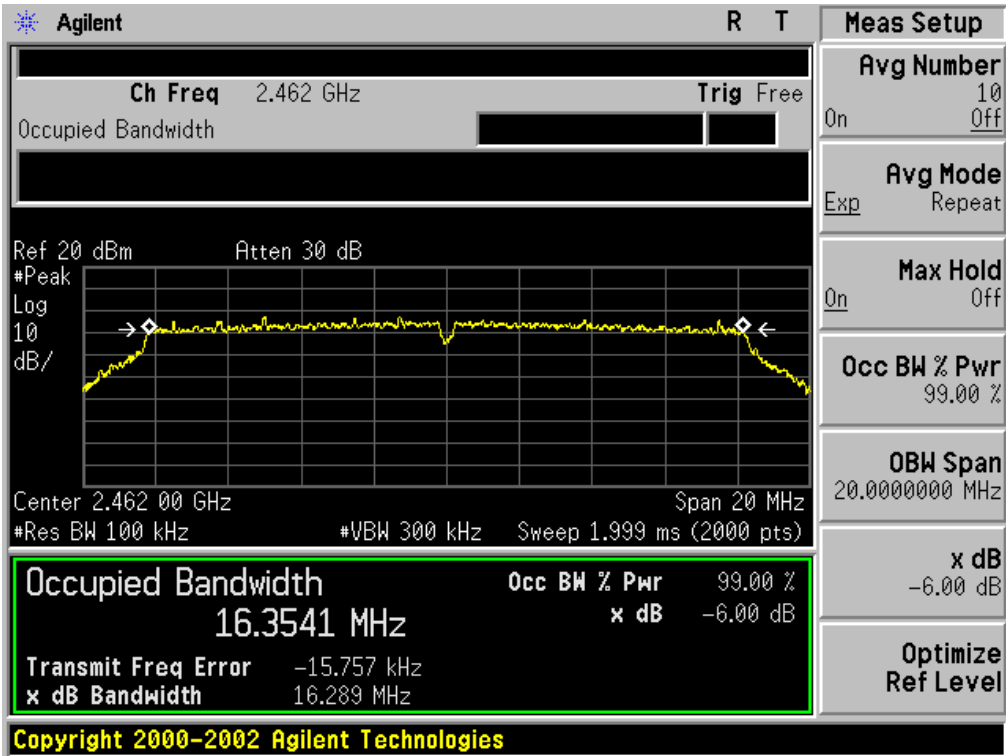

**802.11n (20) TEST RESULT**  
**TEST PLOT OF BANDWIDTH FOR LOW CHANNEL**

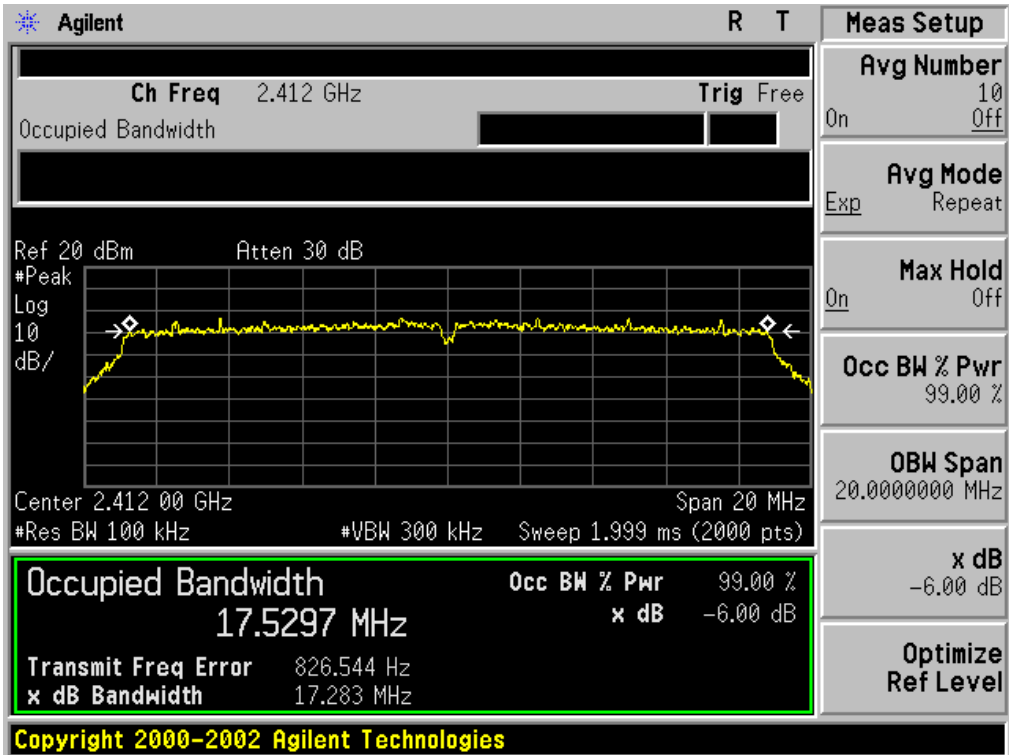

**TEST PLOT OF BANDWIDTH FOR MIDDLE CHANNEL**

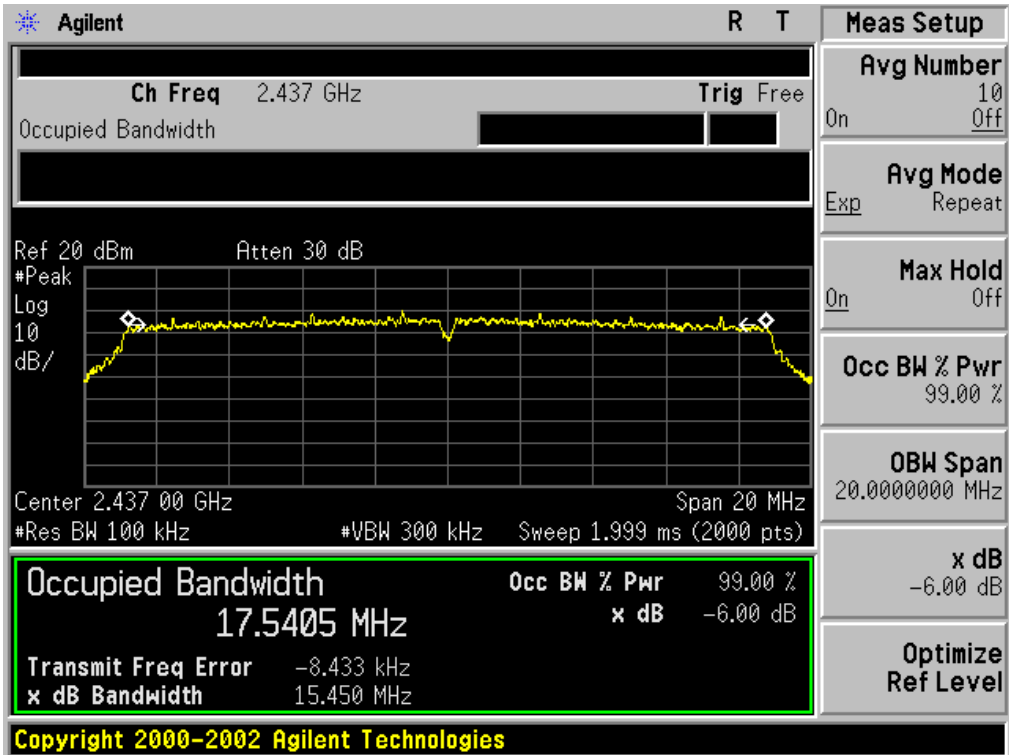

TEST PLOT OF BANDWIDTH FOR HIGH CHANNEL

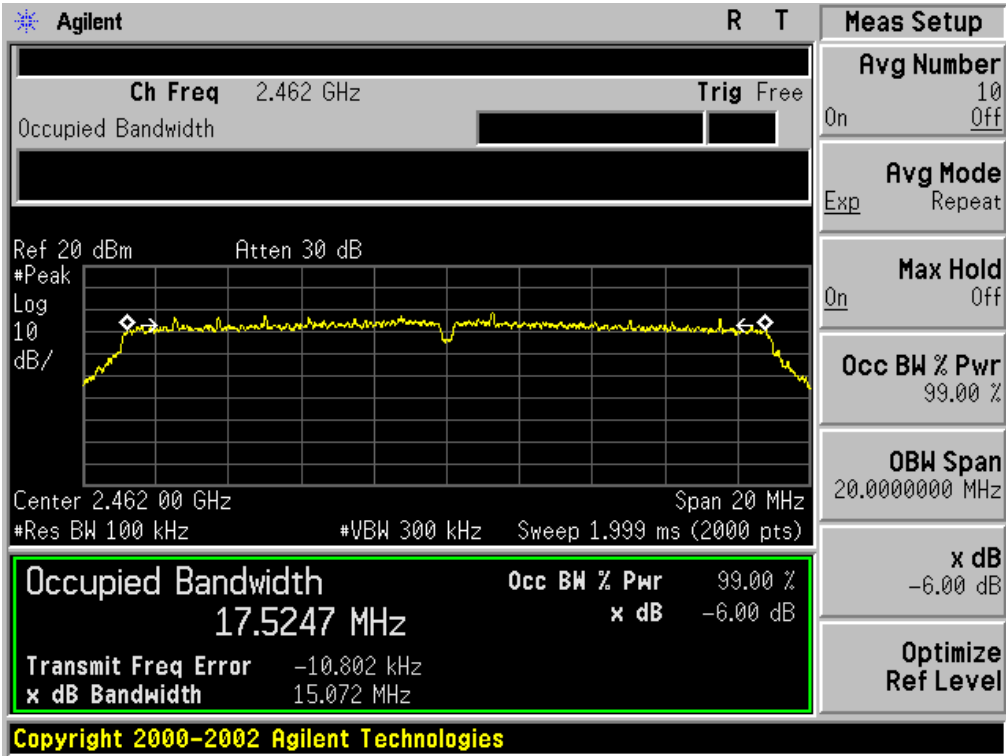

802.11n(40) TEST RESULT

TEST PLOT OF BANDWIDTH FOR LOW CHANNEL

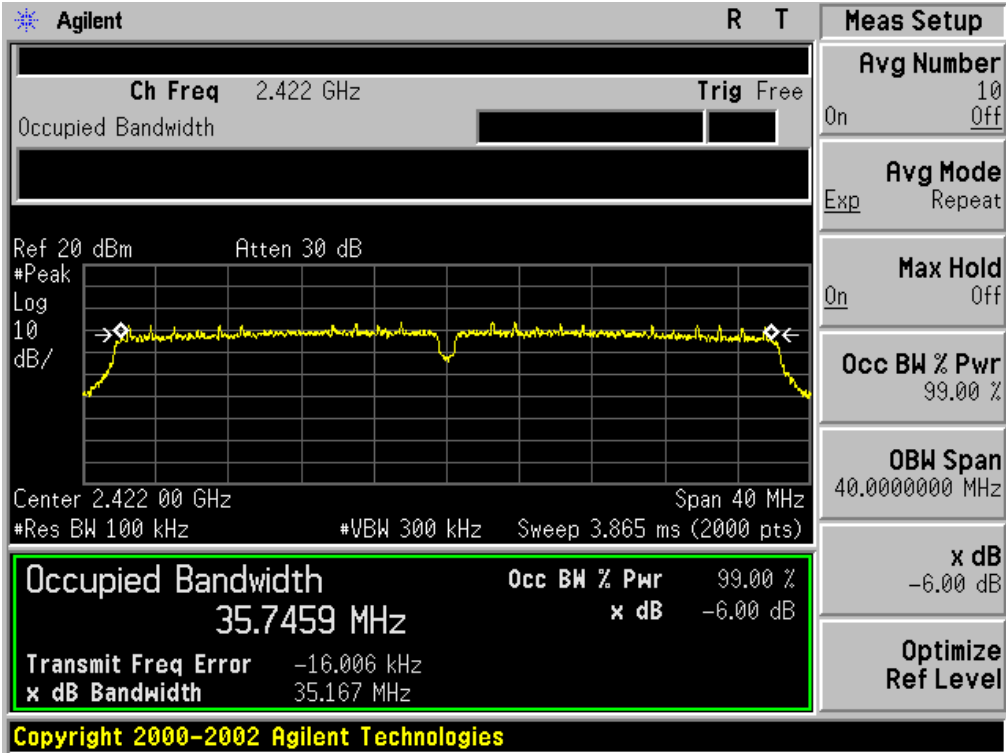

TEST PLOT OF BANDWIDTH FOR MIDDLE CHANNEL

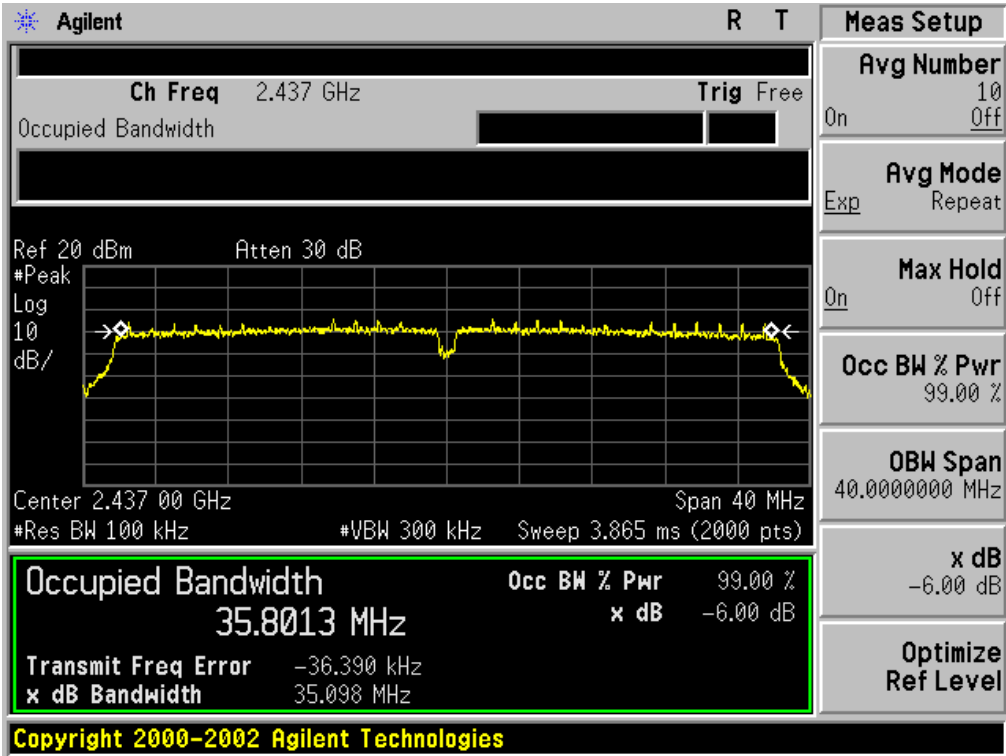

TEST PLOT OF BANDWIDTH FOR HIGH CHANNEL

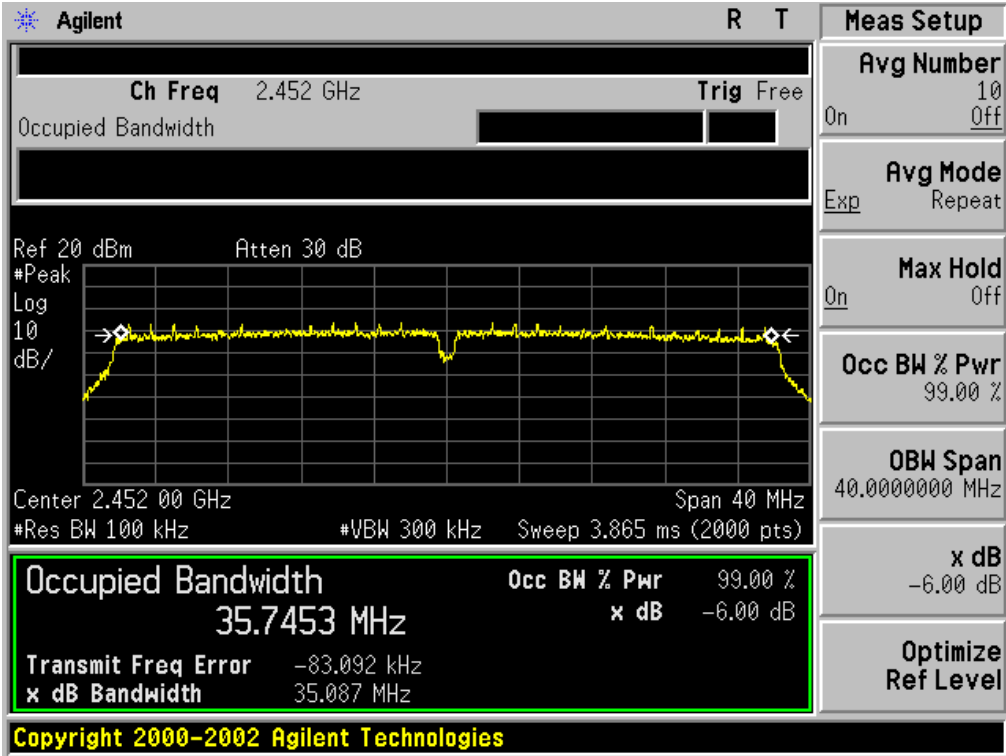



## 9. CONDUCTED SPURIOUS EMISSION

### 9.1. MEASUREMENT PROCEDURE

1. Connect EUT RF output port to the Spectrum Analyzer through an RF attenuator
2. Set the EUT Work on the top, the middle and the bottom operation frequency individually.
3. Set SPA Trace 1 Max hold, then View.

**Note:** The EUT was tested according to KDB 558074 for compliance to FCC 47CFR 15.247 requirements.

Owing to satisfy the requirements of the number of measurement points, we set the RBW=1MHz, VBW>RBW, scan up through 10th harmonic, and consider the tested results as the worst case, if the tested results conform to the requirement, we can deem that the real tested results(set the RBW=100KHz, VBW>RBW) are conform to the requirement.

### 9.2. TEST SET-UP (BLOCK DIAGRAM OF CONFIGURATION)

The same as described in section 8.2.

### 9.3. MEASUREMENT EQUIPMENT USED

The same as described in section 6.

### 9.4. LIMITS AND MEASUREMENT RESULT

LIMITS AND MEASUREMENT RESULT		
Applicable Limits	Measurement Result	
	Test Data	Criteria
In any 100 KHz Bandwidth Outside the frequency band in which the spread spectrum intentional radiator is operating, the radio frequency power that is produce by the intentional radiator shall be at least 20 dB below that in 100KHz bandwidth within the band that contains the highest level of the desired power. In addition, radiation emissions which fall in the restricted bands, as defined in §15.205(a), must also comply with the radiated emission limits specified in§15.209(a)	At least -20dBc than the limit Specified on the BOTTOM Channel	PASS
	At least -20dBc than the limit Specified on the TOP Channel	PASS

TEST PLOT OF OUT OF BAND EMISSIONS WITH THE WORST CASE  
 OF 802.11b FOR MODULATION IN LOW CHANNEL

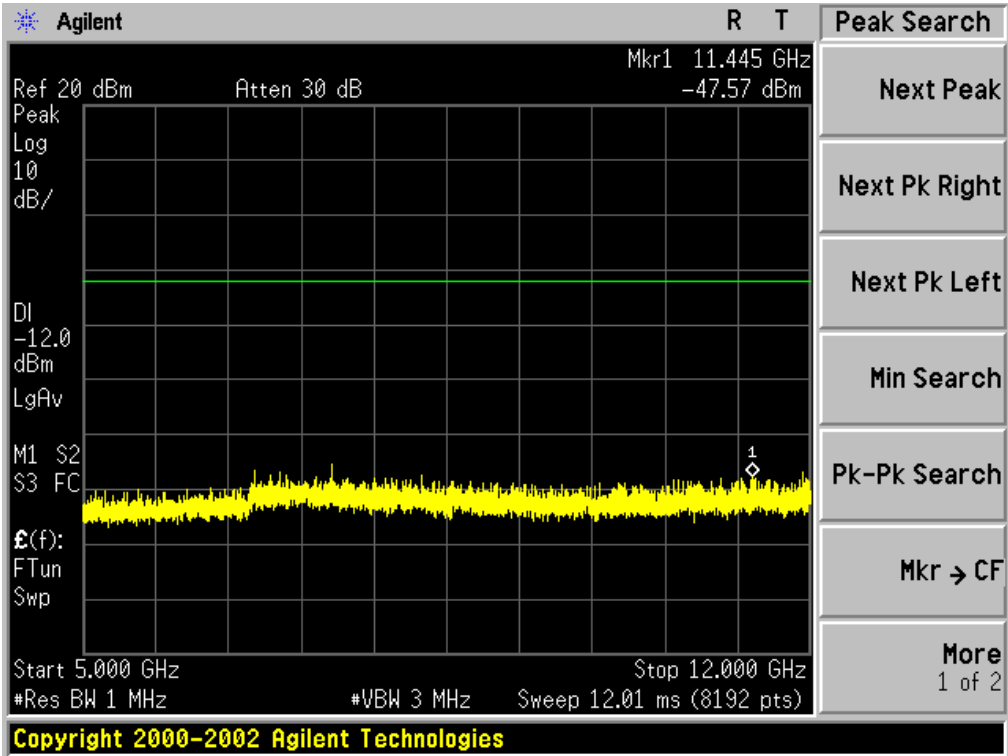
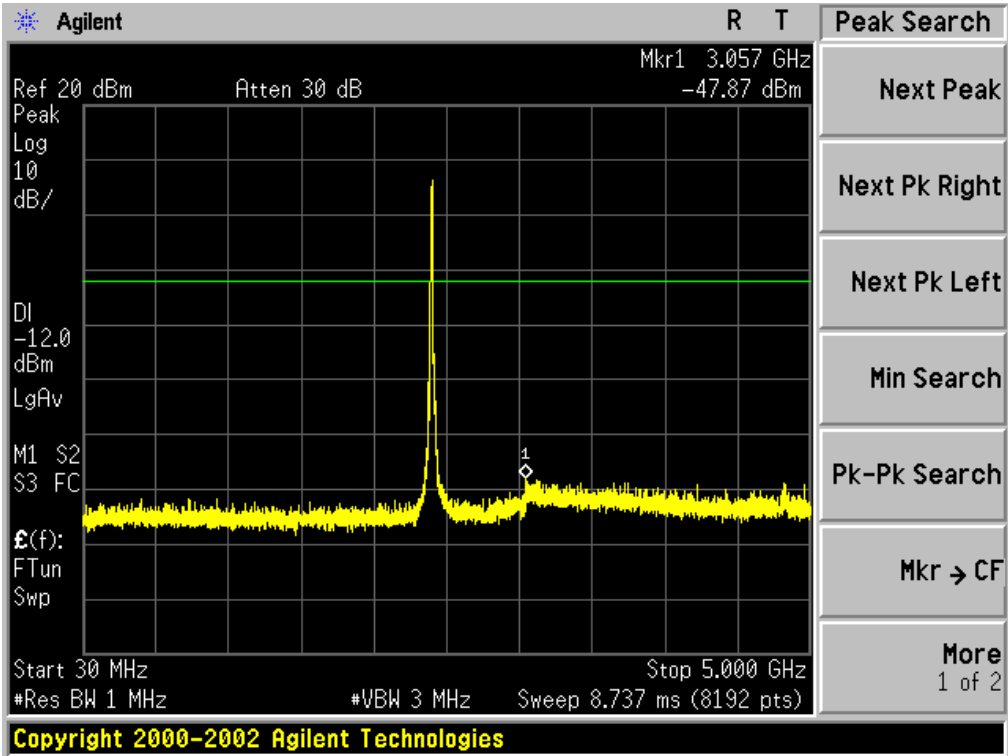

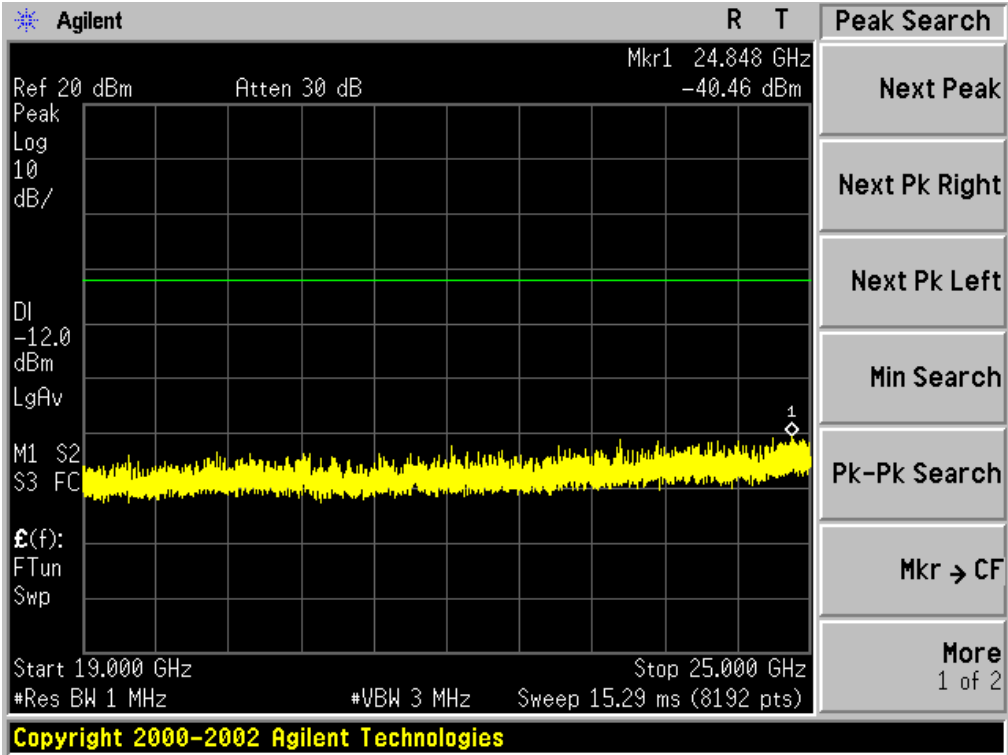
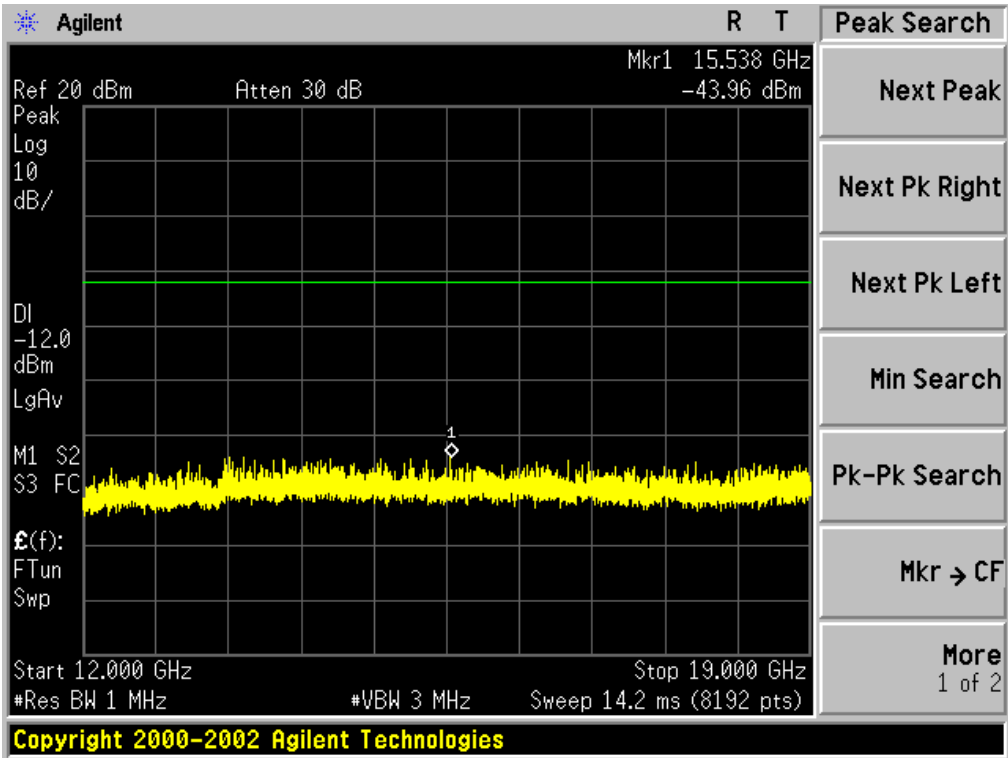

TEST PLOT OF OUT OF BAND EMISSIONS  
 OF 802.11b FOR MODULATION IN MIDDLE CHANNEL

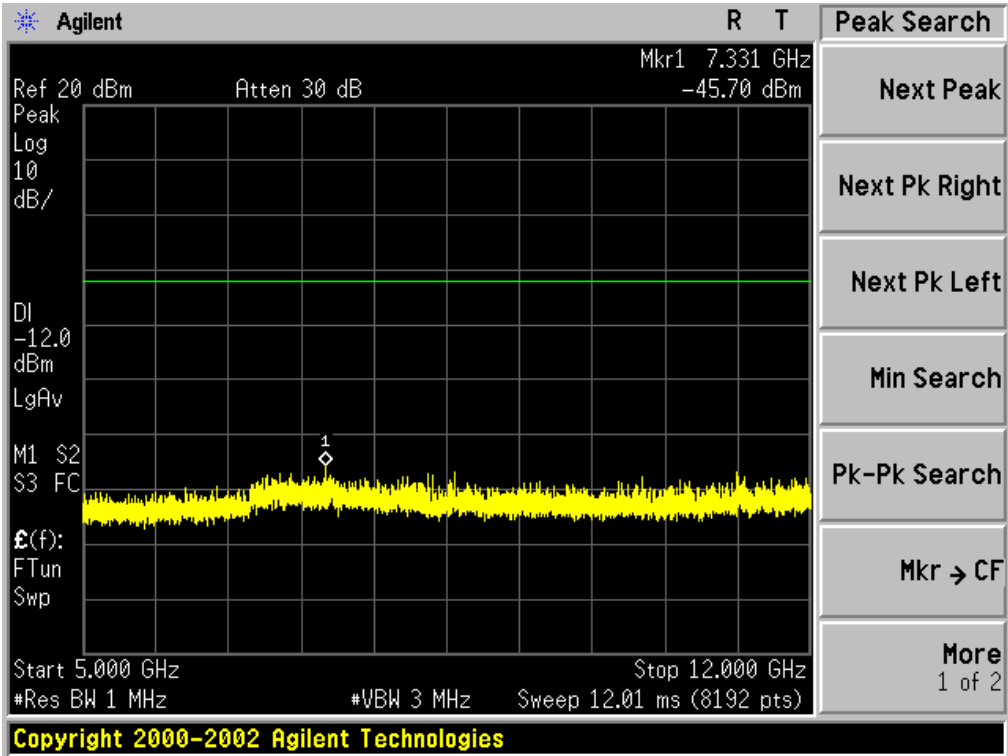
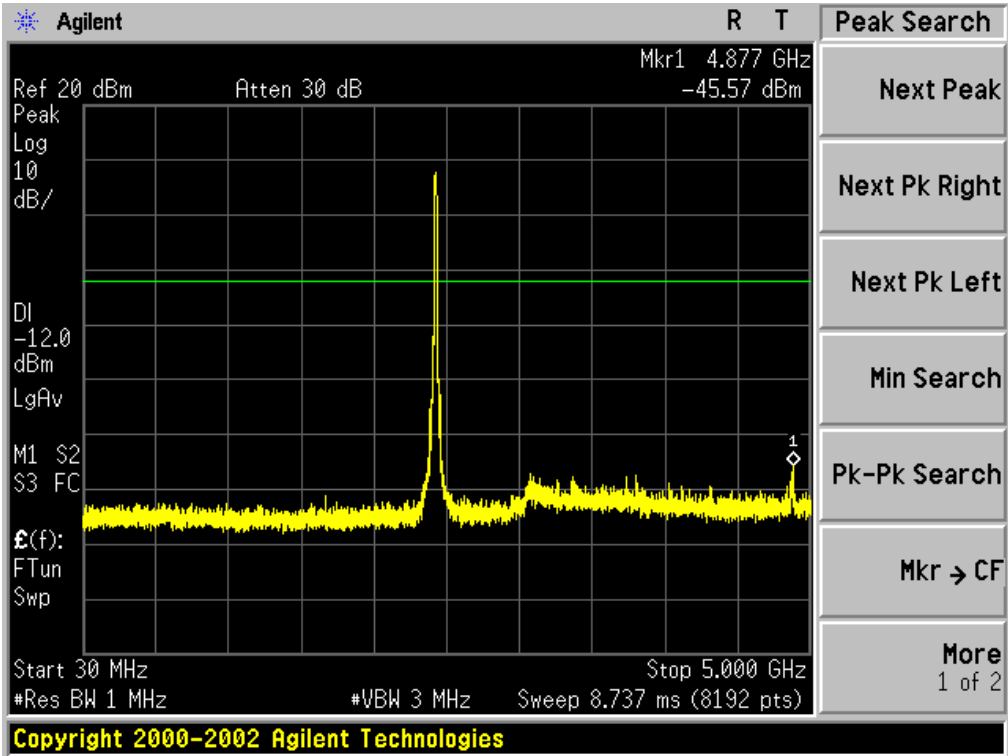

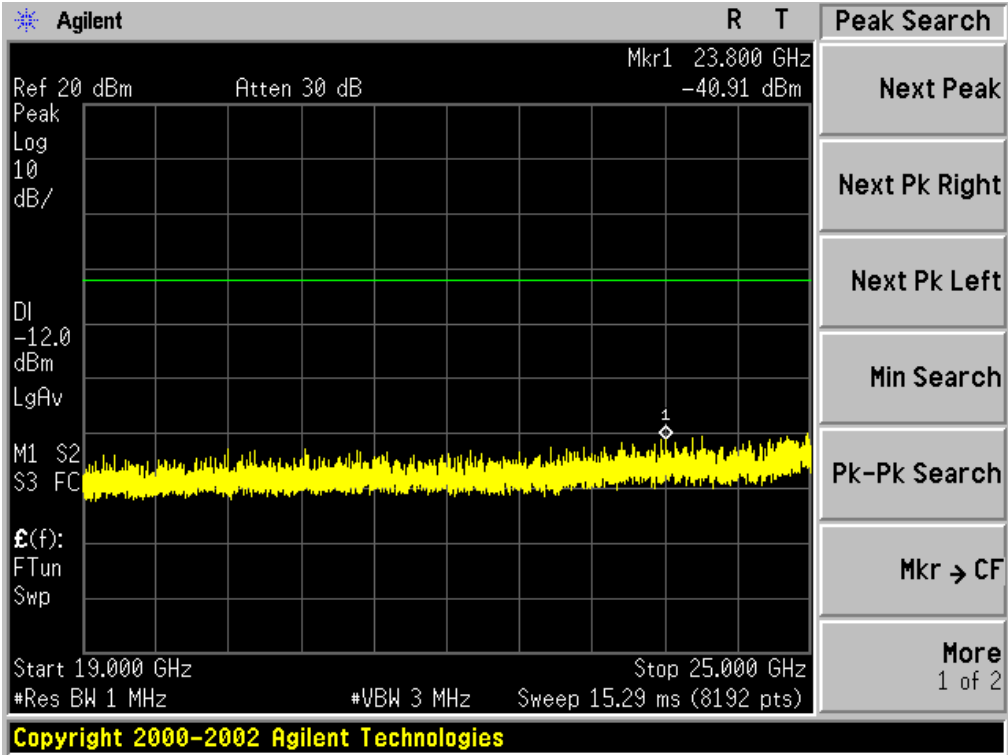
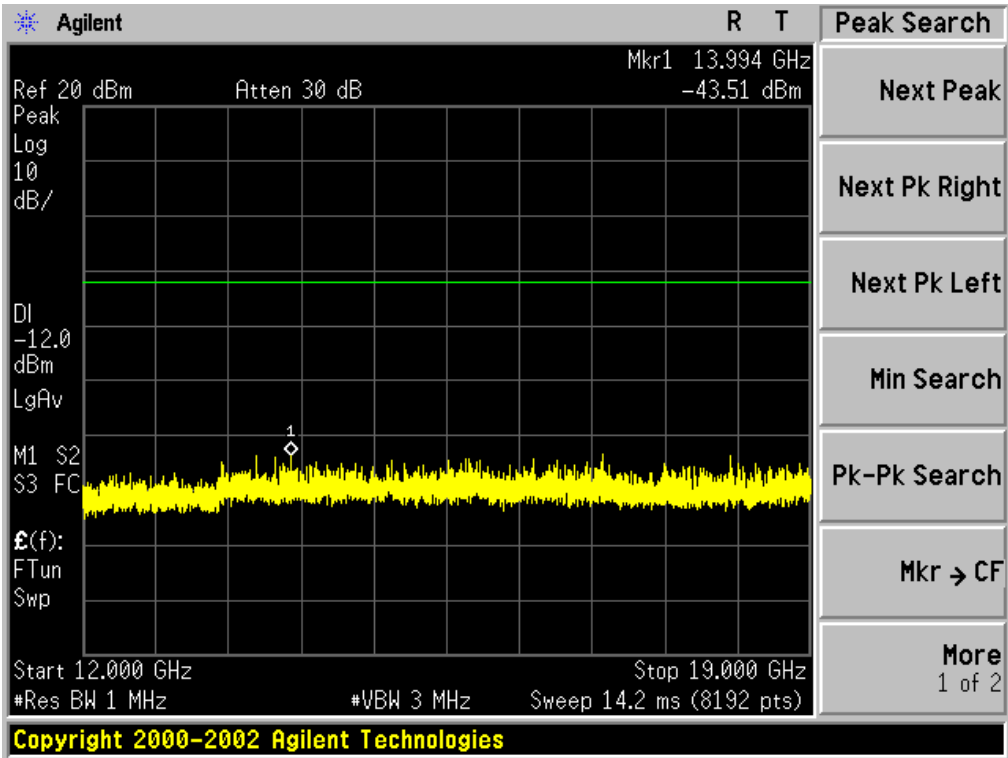

TEST PLOT OF OUT OF BAND EMISSIONS  
 OF 802.11b FOR MODULATION IN HIGH CHANNEL

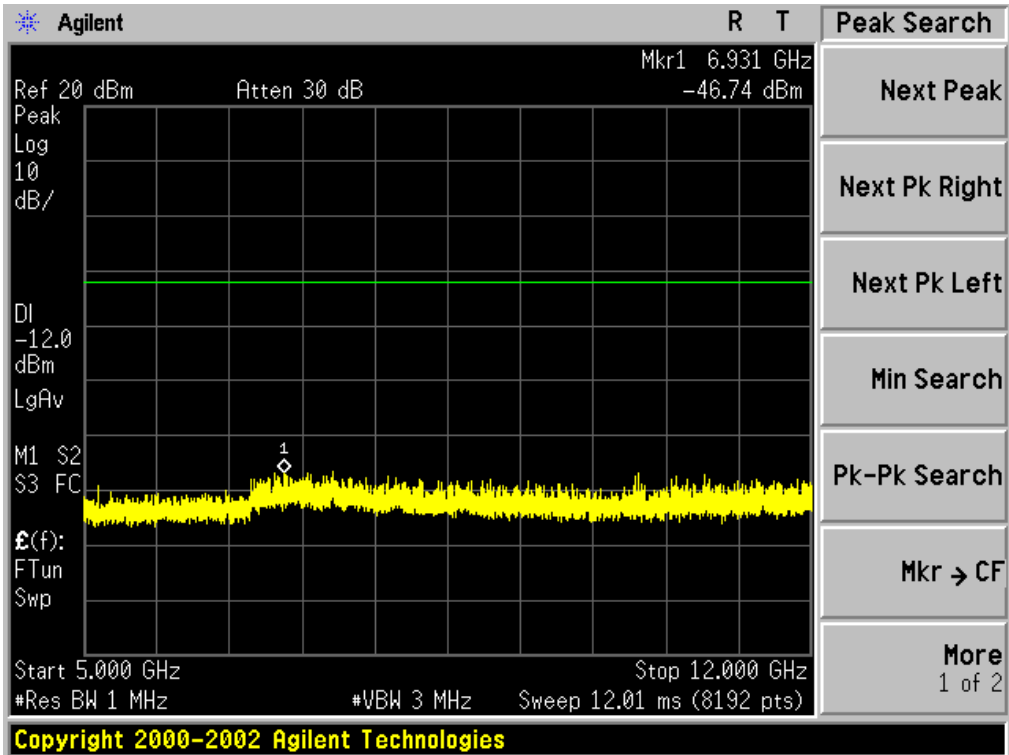
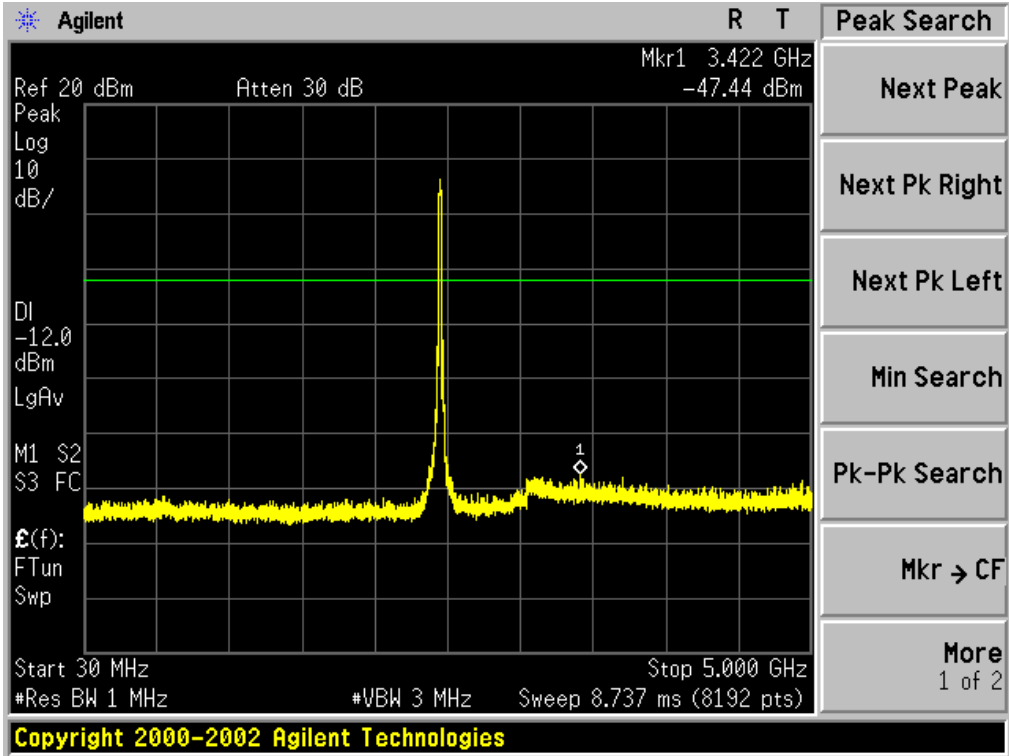

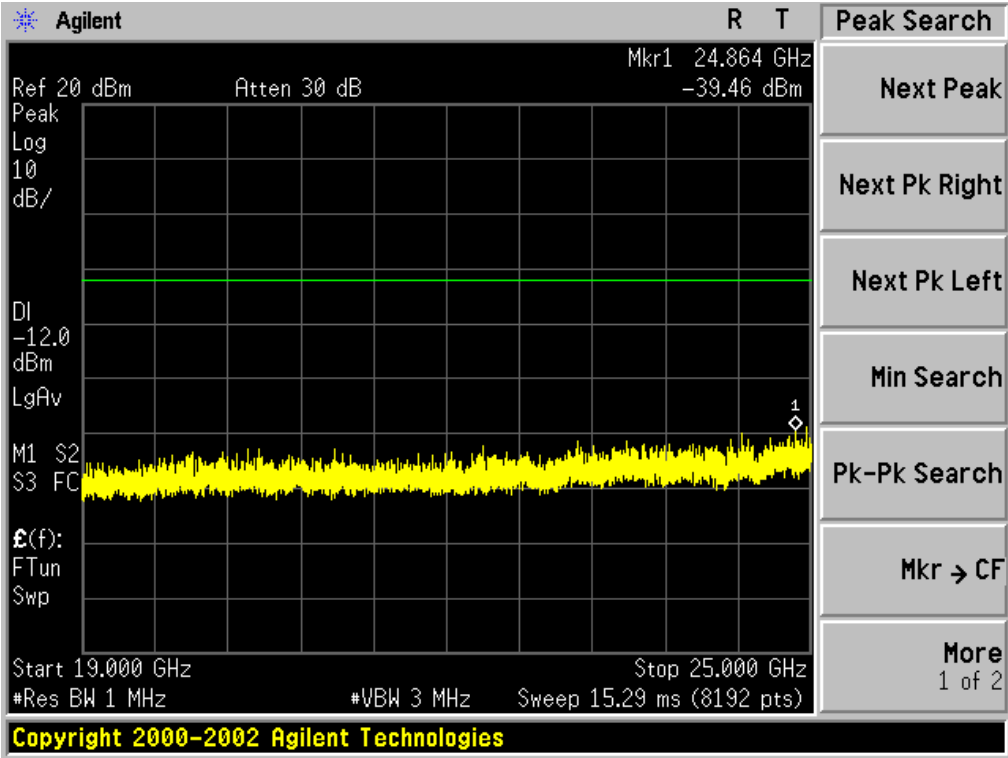
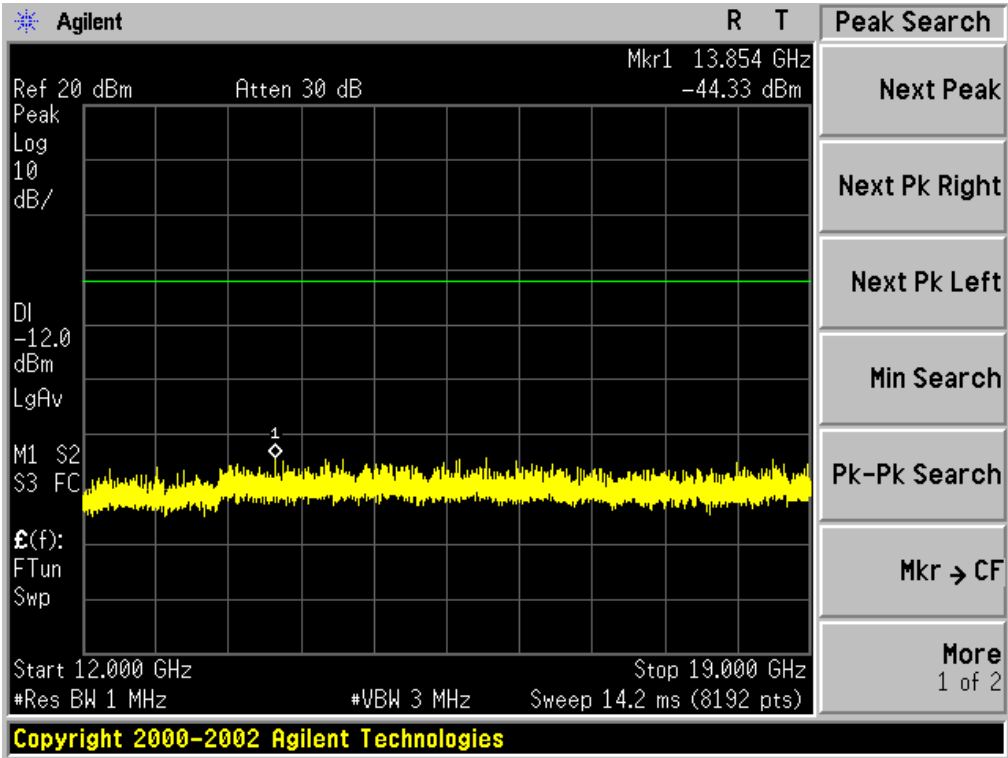

## 10. MAXIMUM CONDUCTED OUTPUT PEAK POWER SPECTRAL DENSITY

### 10.1 MEASUREMENT PROCEDURE

- (1). Connect EUT RF output port to the Spectrum Analyzer through an RF attenuator
- (2). Set the EUT Work on the top, the middle and the bottom operation frequency individually.
- (3). Set SPA Trace 1 Max hold, then View.

Note: The method of PKPSD in the KDB 558074 item 10.2 was used in this testing.

### 10.2 TEST SET-UP (BLOCK DIAGRAM OF CONFIGURATION)

Refer To Section 8.2.

### 10.3 MEASUREMENT EQUIPMENT USED

Refer To Section 6.

### 10.4 LIMITS AND MEASUREMENT RESULT

<b>TEST ITEM</b>	POWER PECTRAL DENSITY
<b>TEST MODE</b>	802.11b with data rate 1

Channel No.	PSD (dBm)	Limit (dBm)	Result
Low Channel	-10.48	8	Pass
Middle Channel	-10.92	8	Pass
High Channel	-10.28	8	Pass

<b>TEST ITEM</b>	POWER PECTRAL DENSITY
<b>TEST MODE</b>	802.11g with data rate 6

Channel No.	PSD (dBm)	Limit (dBm)	Result
Low Channel	-16.86	8	Pass
Middle Channel	-14.69	8	Pass
High Channel	-16.63	8	Pass



<b>TEST ITEM</b>	POWER PECTRAL DENSITY
<b>TEST MODE</b>	802.11n 20 with data rate 6.5

Channel No.	PSD (dBm)	Limit (dBm)	Result
Low Channel	-15.03	8	Pass
Middle Channel	-14.56	8	Pass
High Channel	-14.7	8	Pass

<b>TEST ITEM</b>	POWER PECTRAL DENSITY
<b>TEST MODE</b>	802.11n 40 with data rate 13.5

Channel No.	PSD (dBm)	Limit (dBm)	Result
Low Channel	-20.24	8	Pass
Middle Channel	-18.45	8	Pass
High Channel	-19.6	8	Pass

**802.11b TEST RESULT**  
**TEST PLOT OF SPECTRAL DENSITY FOR LOW CHANNEL**

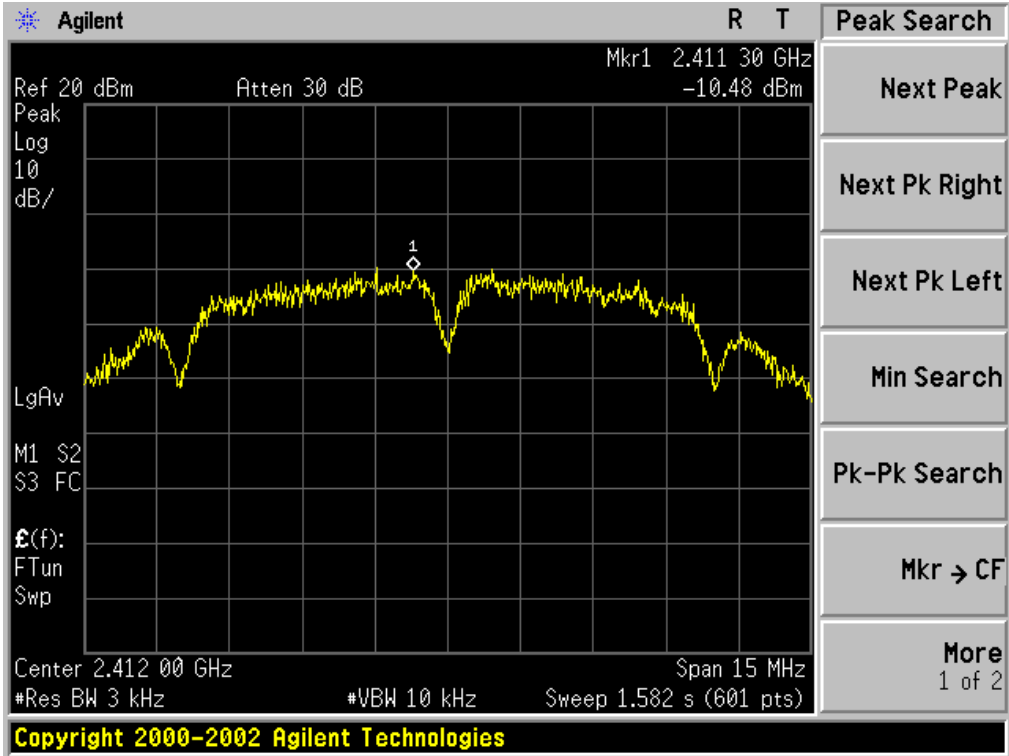

**TEST PLOT OF SPECTRAL DENSITY FOR MIDDLE CHANNEL**

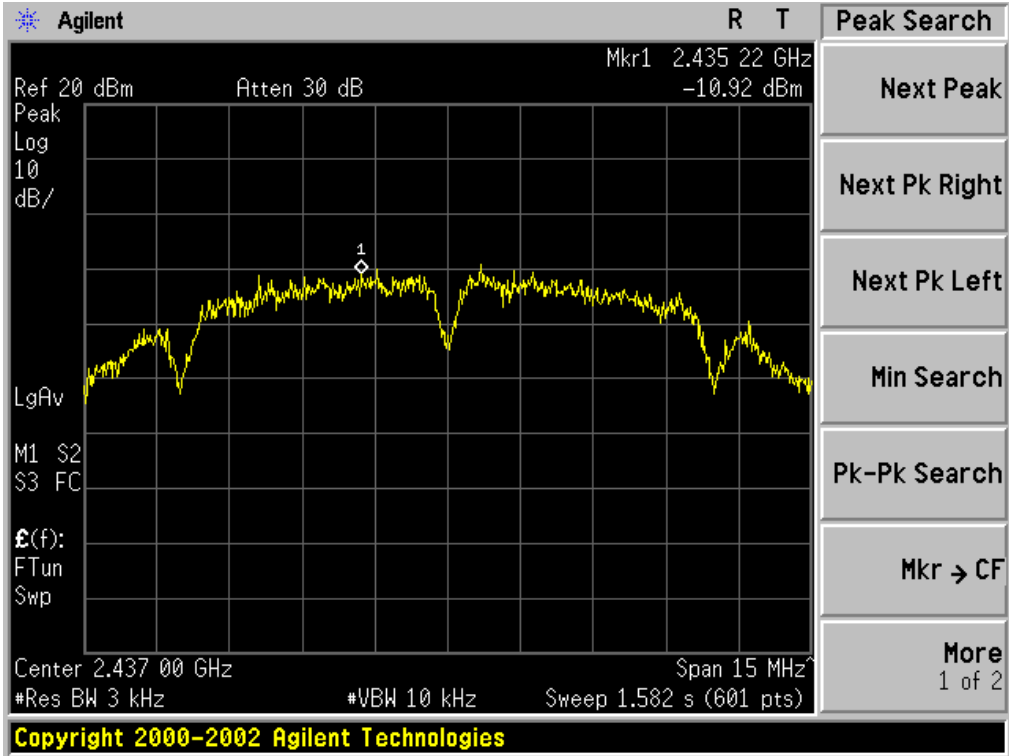

TEST PLOT OF SPECTRAL DENSITY FOR HIGH CHANNEL

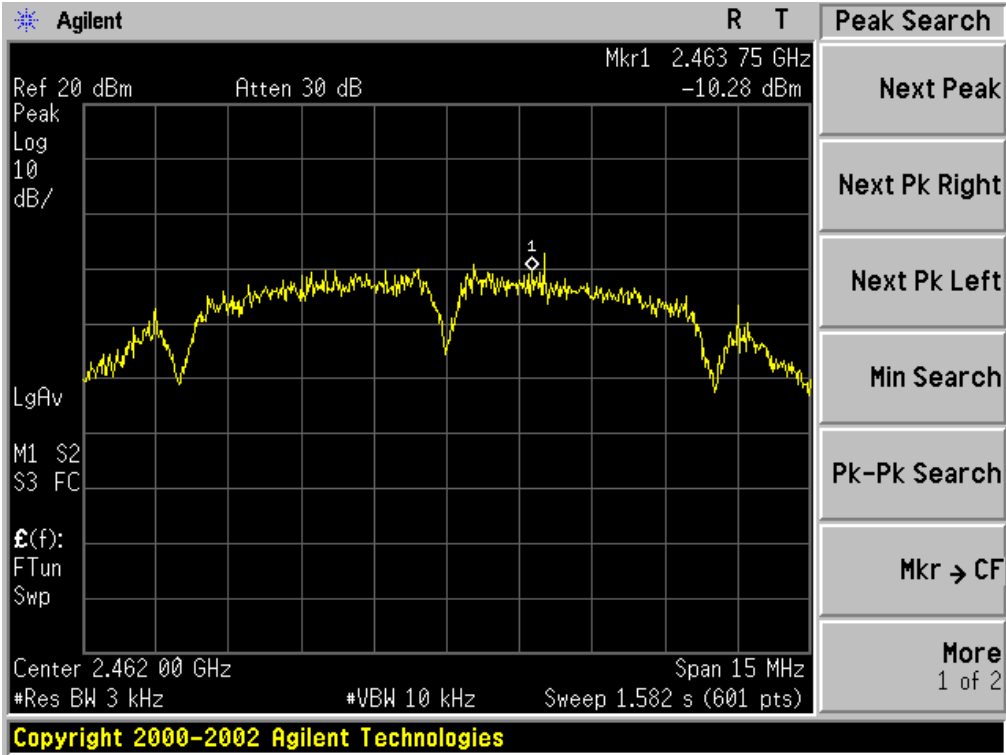

802.11g TEST RESULT

TEST PLOT OF SPECTRAL DENSITY FOR LOW CHANNEL

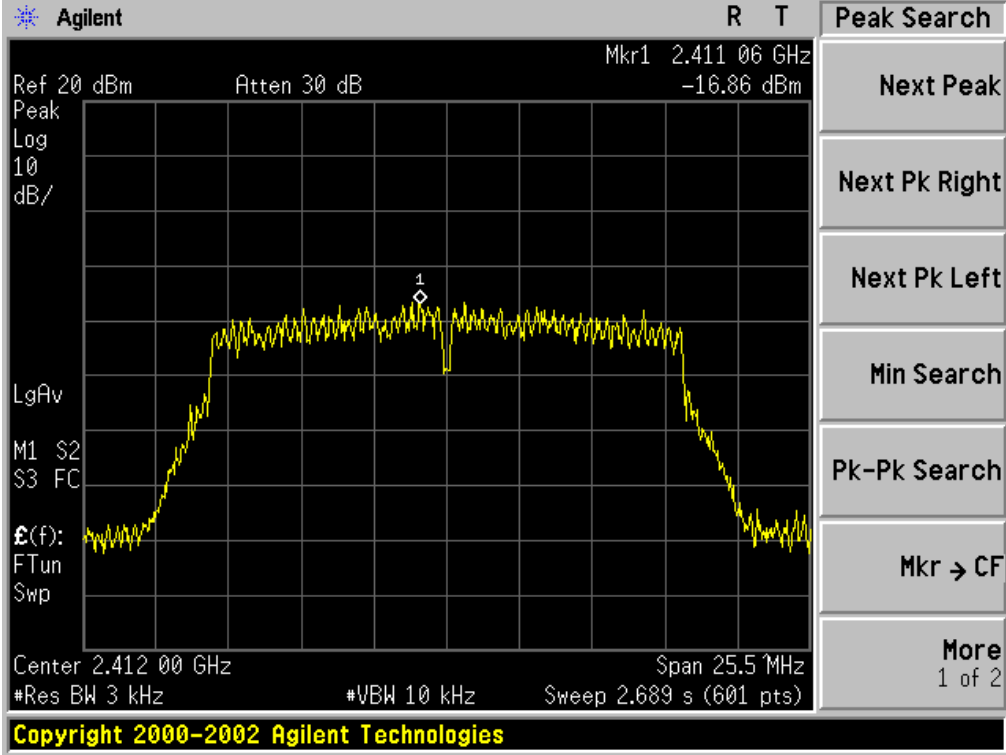

TEST PLOT OF SPECTRAL DENSITY FOR MIDDLE CHANNEL

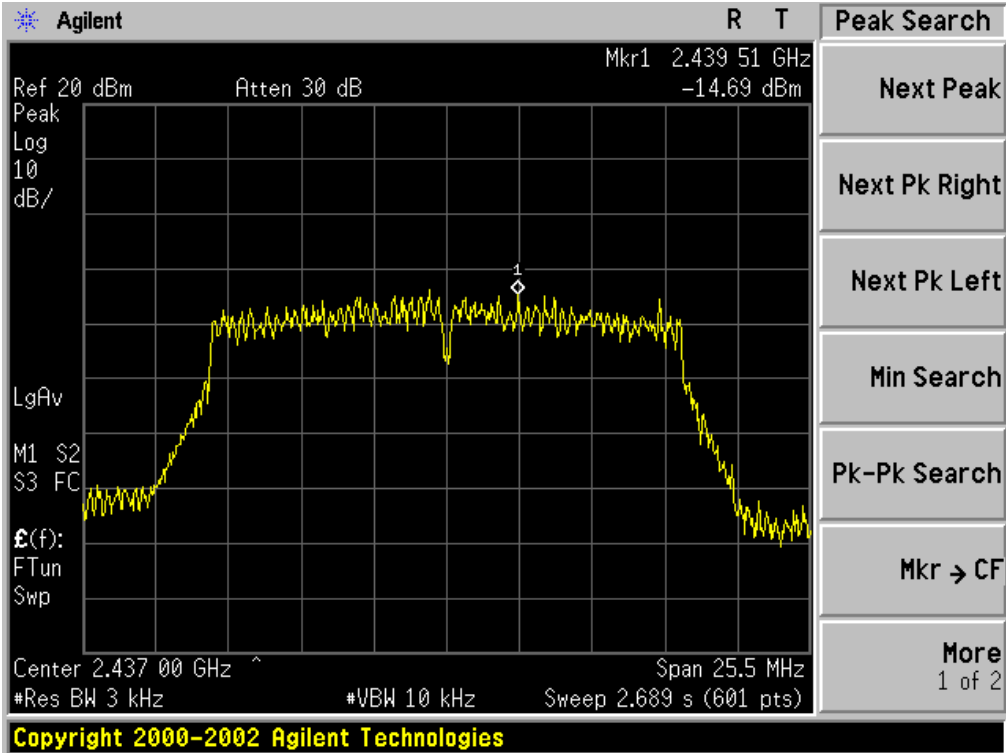

TEST PLOT OF SPECTRAL DENSITY FOR HIGH CHANNEL

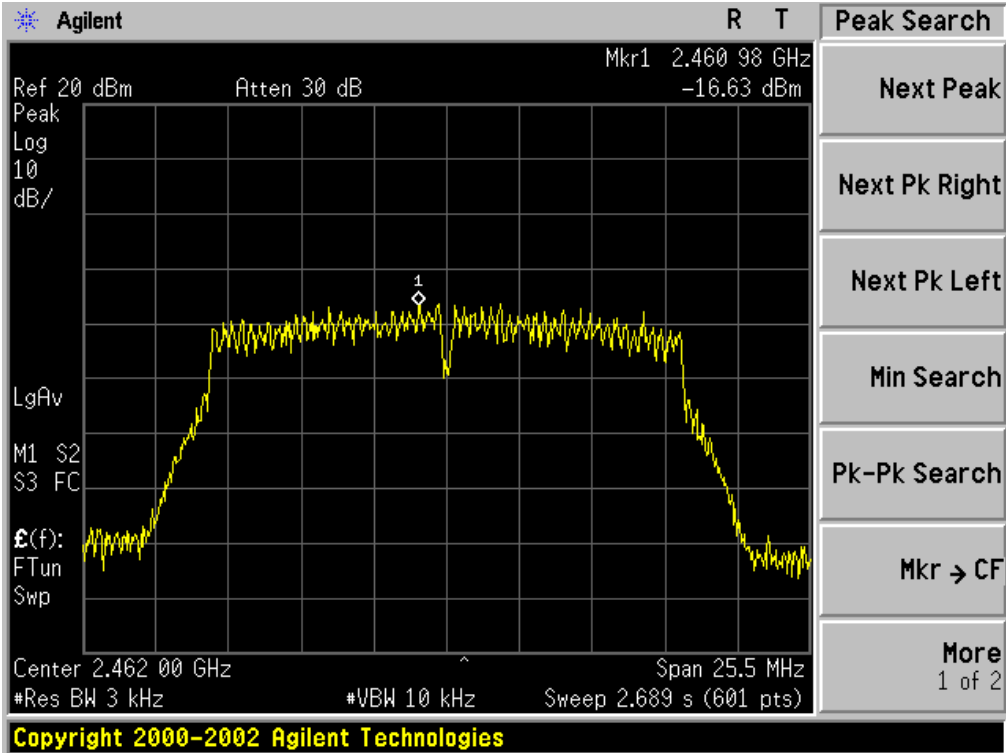

**802.11n 20 TEST RESULT**  
**TEST PLOT OF SPECTRAL DENSITY FOR LOW CHANNEL**

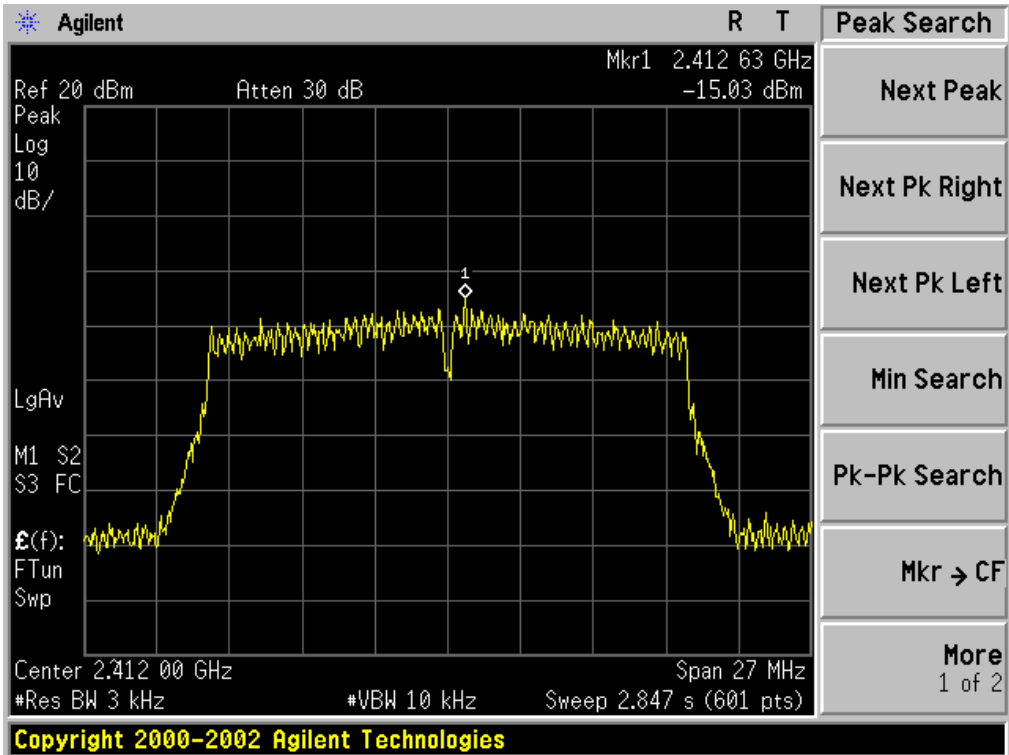

**TEST PLOT OF SPECTRAL DENSITY FOR MIDDLE CHANNEL**

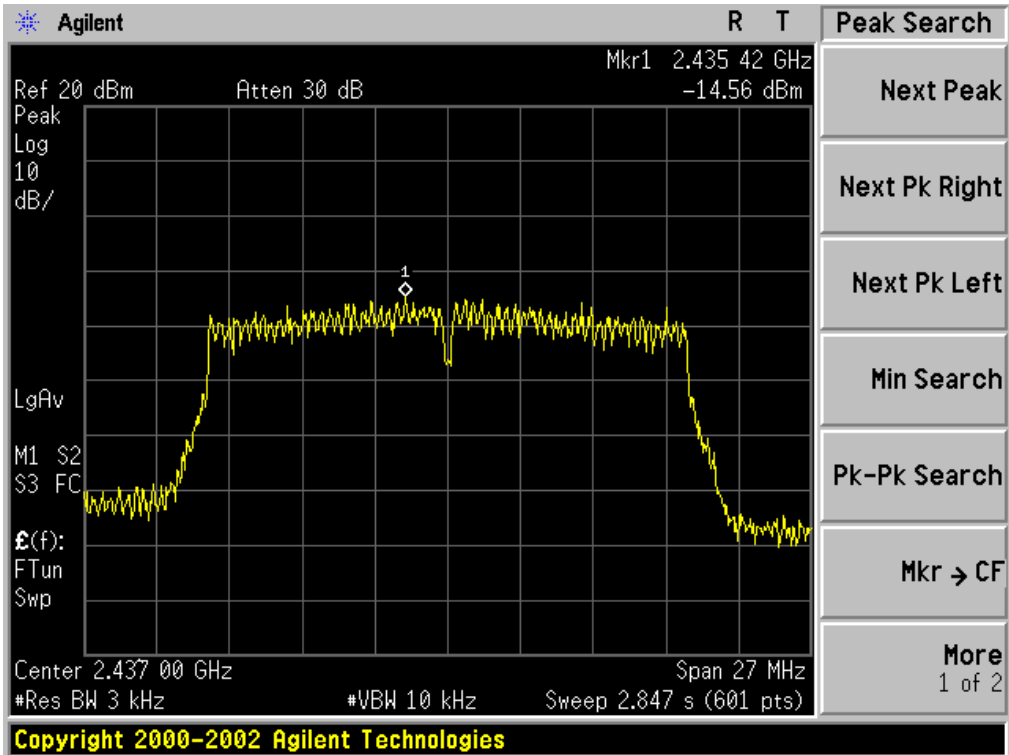

TEST PLOT OF SPECTRAL DENSITY FOR HIGH CHANNEL

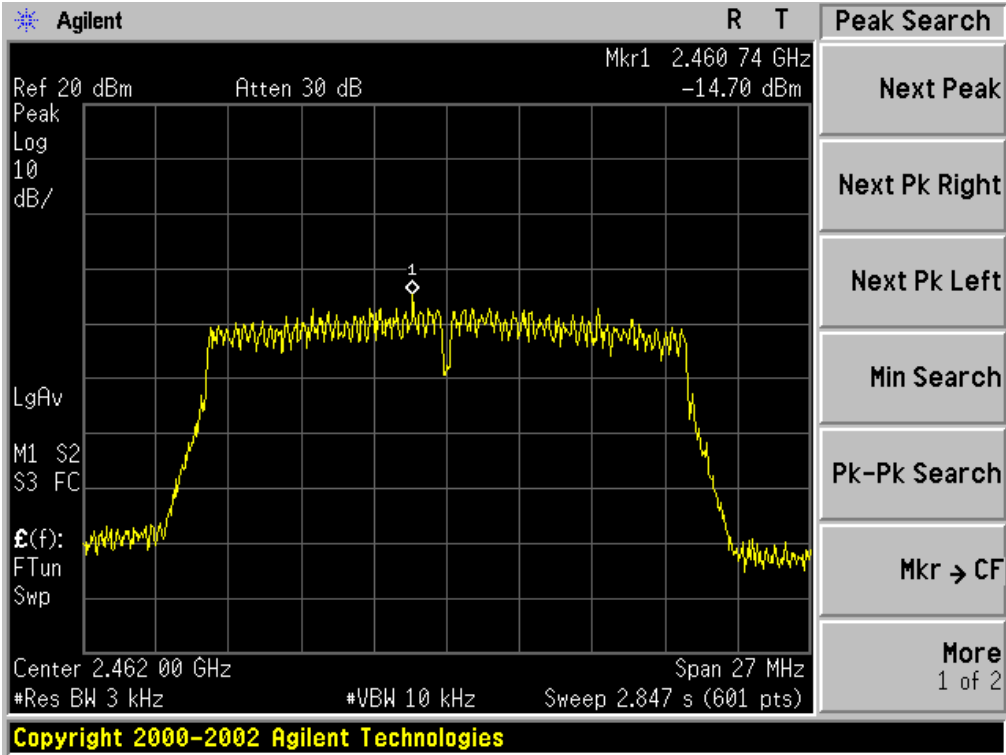

802.11n 40 TEST RESULT

TEST PLOT OF SPECTRAL DENSITY FOR LOW CHANNEL

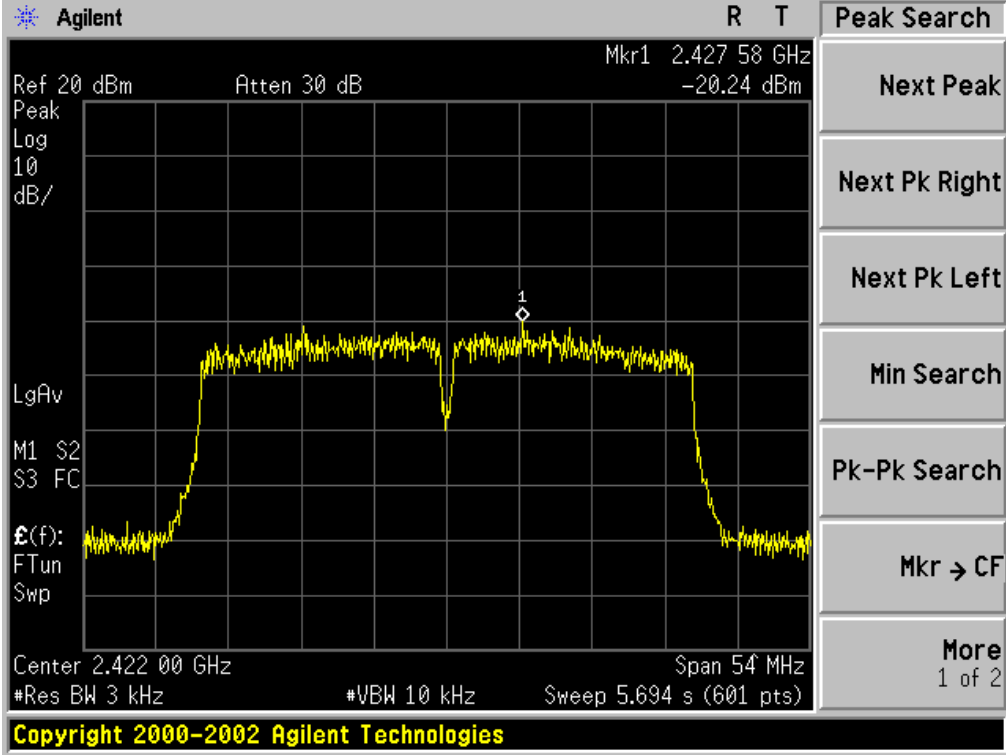

TEST PLOT OF SPECTRAL DENSITY FOR MIDDLE CHANNEL

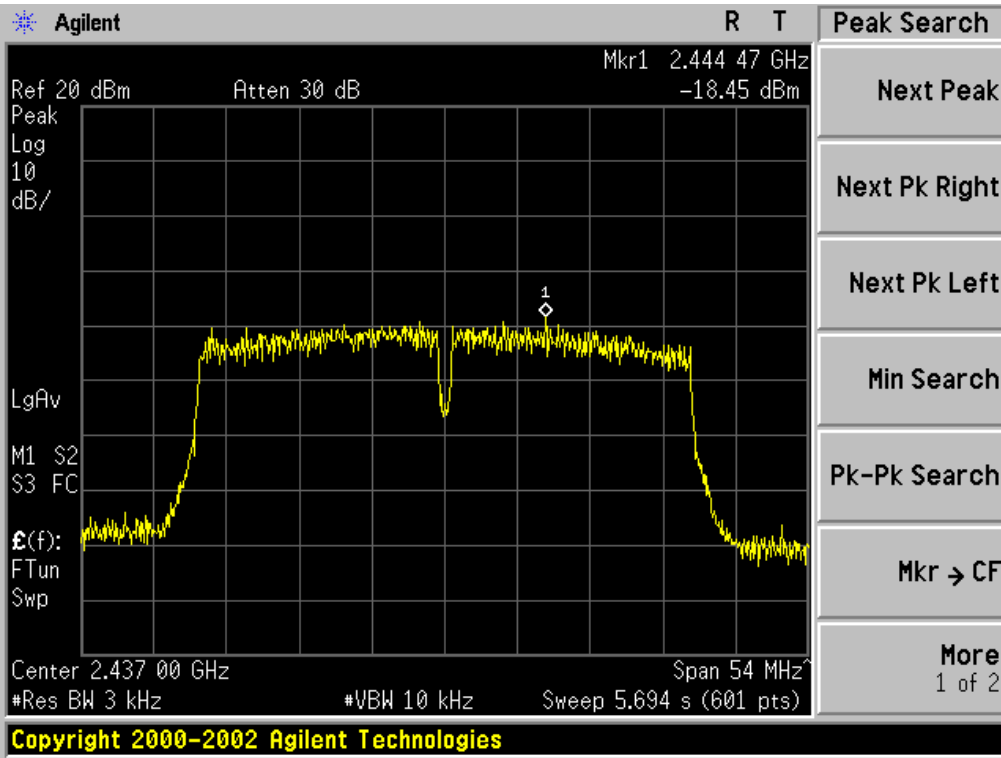

TEST PLOT OF SPECTRAL DENSITY FOR HIGH CHANNEL

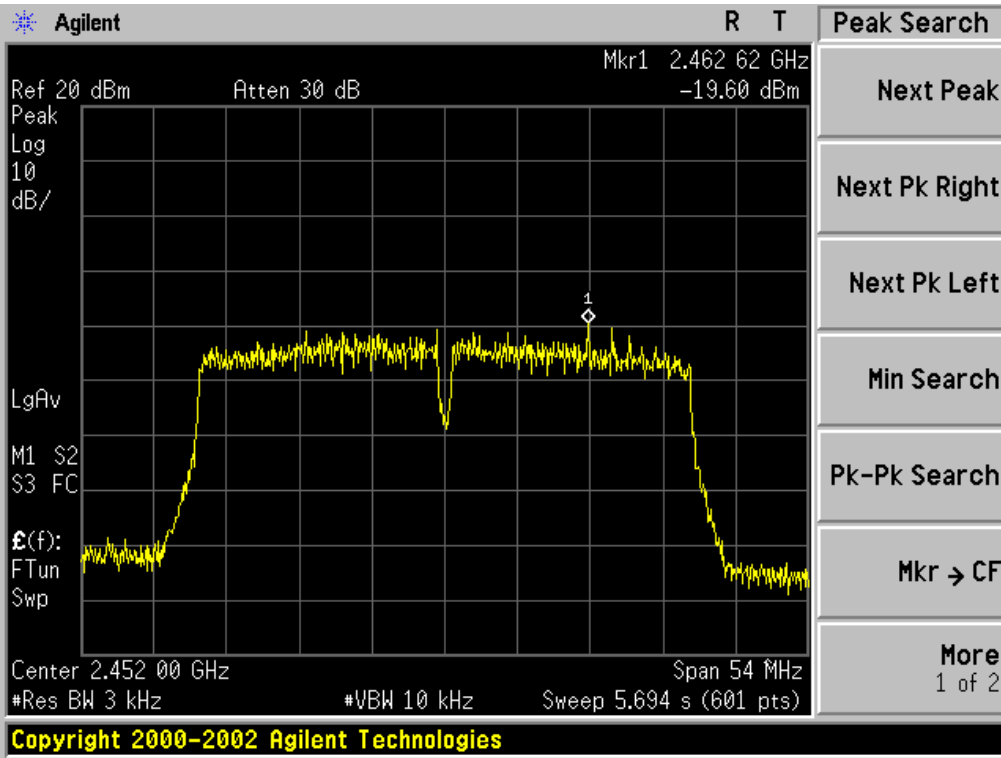

## 11. RADIATED EMISSION

### 11.1. MEASUREMENT PROCEDURE

1. Configure the EUT according to ANSI C63.4. The EUT was placed on the top of the turntable 0.8 meter above ground. The phase center of the receiving antenna mounted on the top of a height-variable antenna tower was placed 3 meters far away from the turntable.
2. Power on the EUT and all the supporting units. The turntable was rotated by 360 degrees to determine the position of the highest radiation.
3. The height of the broadband receiving antenna was varied between one meter and four meters above ground to find the maximum emissions field strength of both horizontal and vertical polarization.
4. For each suspected emissions, the antenna tower was scan (from 1 M to 4 M) and then the turntable was rotated (from 0 degree to 360 degrees) to find the maximum reading.
5. Set the test-receiver system to Peak or CISPR quasi-peak Detect Function with specified bandwidth under Maximum Hold Mode.
6. For emissions above 1GHz, use 1MHz VBW and RBW for peak reading. Then 1MHz RBW and 10Hz VBW for average reading in spectrum analyzer.
7. When the radiated emissions limits are expressed in terms of the average value of the emissions, and pulsed operation is employed, the measurement field strength shall be determined by averaging over one complete pulse train, including blanking intervals, as long as the pulse train does not exceed 0.1 seconds. As an alternative (provided the transmitter operates for longer than 0.1 seconds) or in cases where the pulse train exceeds 0.1 seconds, the measured field strength shall be determined from the average absolute voltage during a 0.1 second interval during which the field strength is at its maximum values.
8. If the emissions level of the EUT in peak mode was 3 dB lower than the average limit specified, then testing will be stopped and peak values of EUT will be reported, otherwise, the emissions which do not have 3 dB margin will be repeated one by one using the quasi-peak method for below 1GHz.
9. For testing above 1GHz, the emissions level of the EUT in peak mode was lower than average limit (that means the emissions level in peak mode also complies with the limit in average mode), then testing will be stopped and peak values of EUT will be reported, otherwise, the emissions will be measured in average mode again and reported.
10. In case the emission is lower than 30MHz, loop antenna has to be used for measurement and the recorded data should be QP measured by receiver. High - Low scan is not required in this case.



11.2. TEST SETUP

RADIATED EMISSION TEST SETUP 30MHz-1000MHz

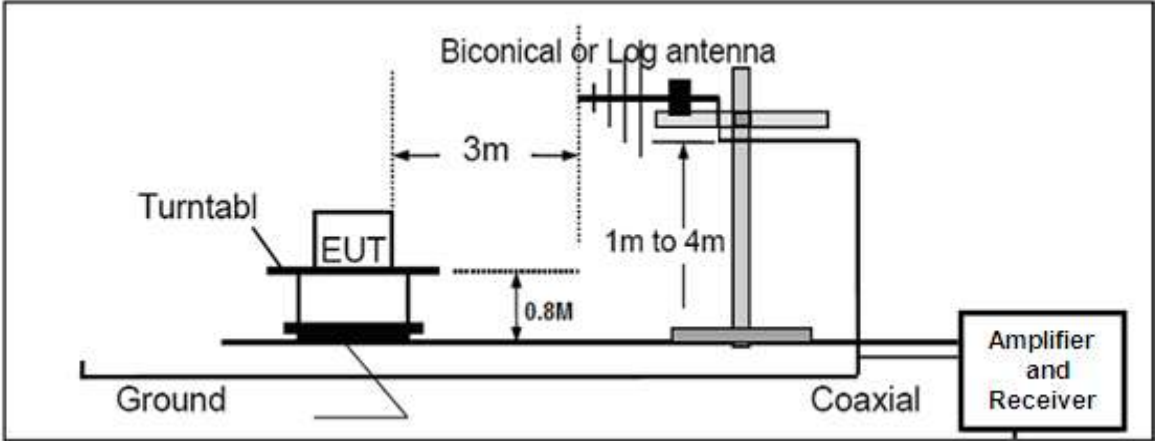

RADIATED EMISSION TEST SETUP ABOVE 1000MHz

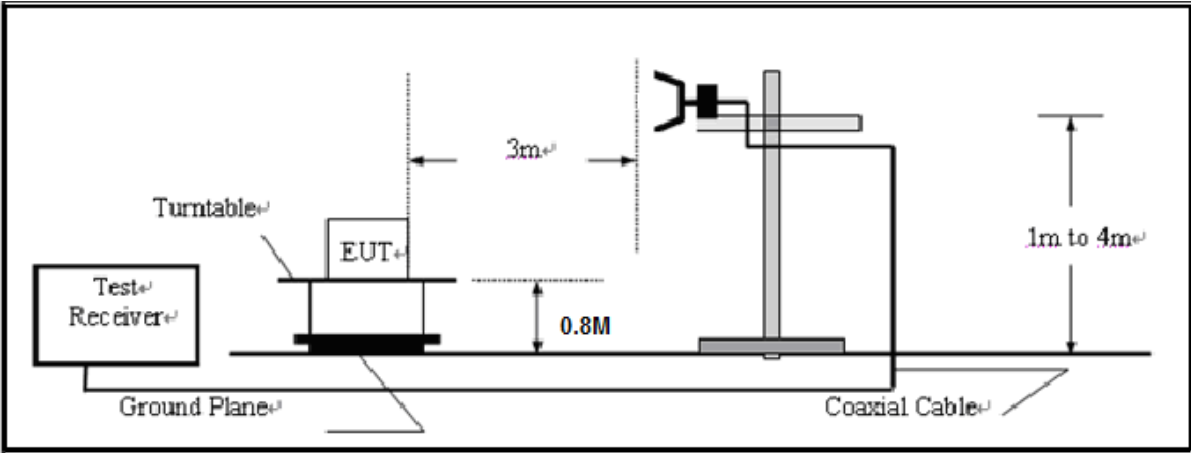

### 11.3. LIMITS AND MEASUREMENT RESULT

15.209(a) Limit in the below table has to be followed

<b>Frequencies (MHz)</b>	<b>Field Strength (micorvolts/meter)</b>	<b>Measurement Distance (meters)</b>
0.009~0.490	2400/F(KHz)	300
0.490~1.705	24000/F(KHz)	30
1.705~30.0	30	30
30~88	100	3
88~216	150	3
216~960	200	3
Above 960	500	3

Note: All modes were tested For restricted band radiated emission,  
the test records reported below are the worst result compared to other modes.

### 11.4. TEST RESULT

#### **RADIATED EMISSION BELOW 30MHZ**

No emission found between lowest internal used/generated frequencies to 30MHz.

**RADIATED EMISSION BELOW 1GHZ**

<b>EUT</b>	mobile phone	<b>Model Name</b>	AM513
<b>Temperature</b>	25°C	<b>Relative Humidity</b>	55.4%
<b>Pressure</b>	960hPa	<b>Test Voltage</b>	Normal Voltage
<b>Test Mode</b>	802.11b with data rate 1 2412MHZ	<b>Antenna</b>	Horizontal

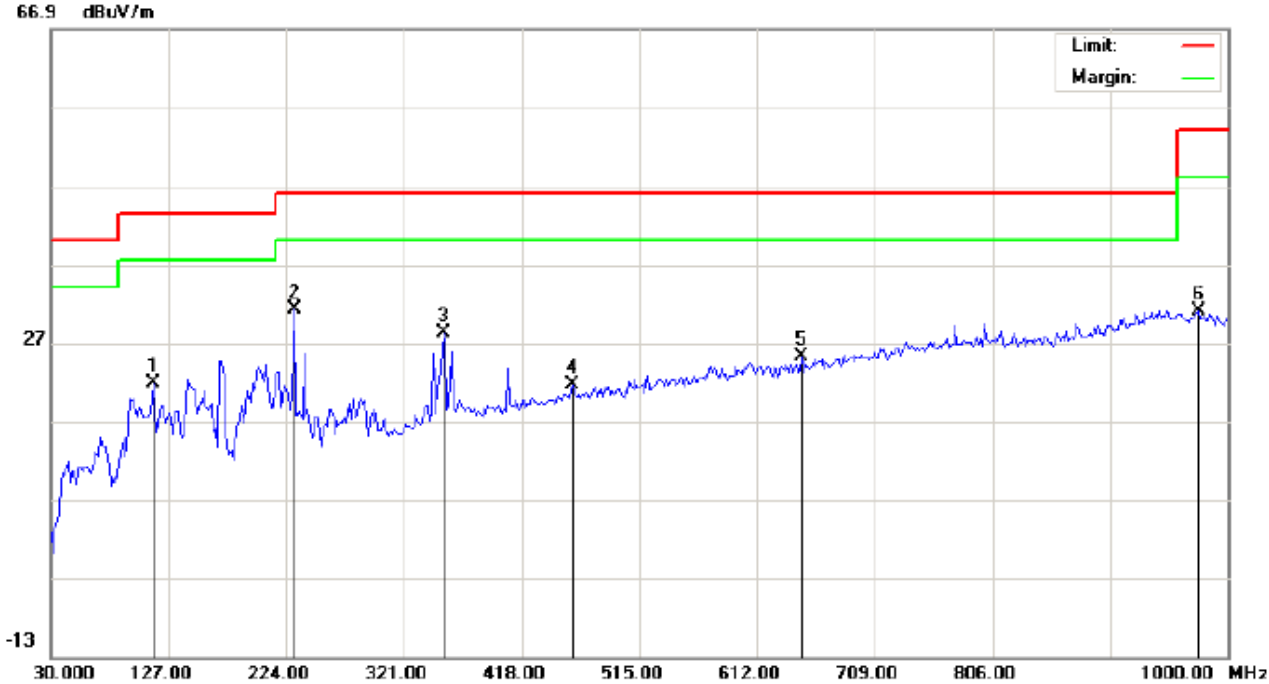

Site: site #1  
 Limit: FCC Class B 3M Radiation  
 EUT: Mobile Phone  
 M/N: AM513  
 Mode: Low Channel TX  
 Note:

Polarization: *Horizontal*  
 Power: AC 120V/60Hz  
 Distance: 3m

Temperature: 26  
 Humidity: 60 %

No.	Mk	Freq.	Reading	Factor	Measurement	Limit	Over	Detector	Antenna Height	Table Degree	Comment
		MHz	dBuV	dB/m	dBuV/m	dBuV/m	dB		cm	degree	
1		114.0667	10.36	11.45	21.81	43.50	-21.69	peak			
2	*	230.4667	18.08	13.16	31.24	46.00	-14.76	peak			
3		353.3333	9.43	18.76	28.19	46.00	-17.81	peak			
4		460.0333	0.99	20.70	21.69	46.00	-24.31	peak			
5		649.1833	1.26	23.85	25.11	46.00	-20.89	peak			
6		975.7500	1.34	29.75	31.09	54.00	-22.91	peak			

**RESULT: PASS**

<b>EUT</b>	mobile phone	<b>Model Name</b>	AM513
<b>Temperature</b>	25°C	<b>Relative Humidity</b>	55.4%
<b>Pressure</b>	960hPa	<b>Test Voltage</b>	Normal Voltage
<b>Test Mode</b>	802.11b with data rate 1 2412MHZ	<b>Antenna</b>	Vertical

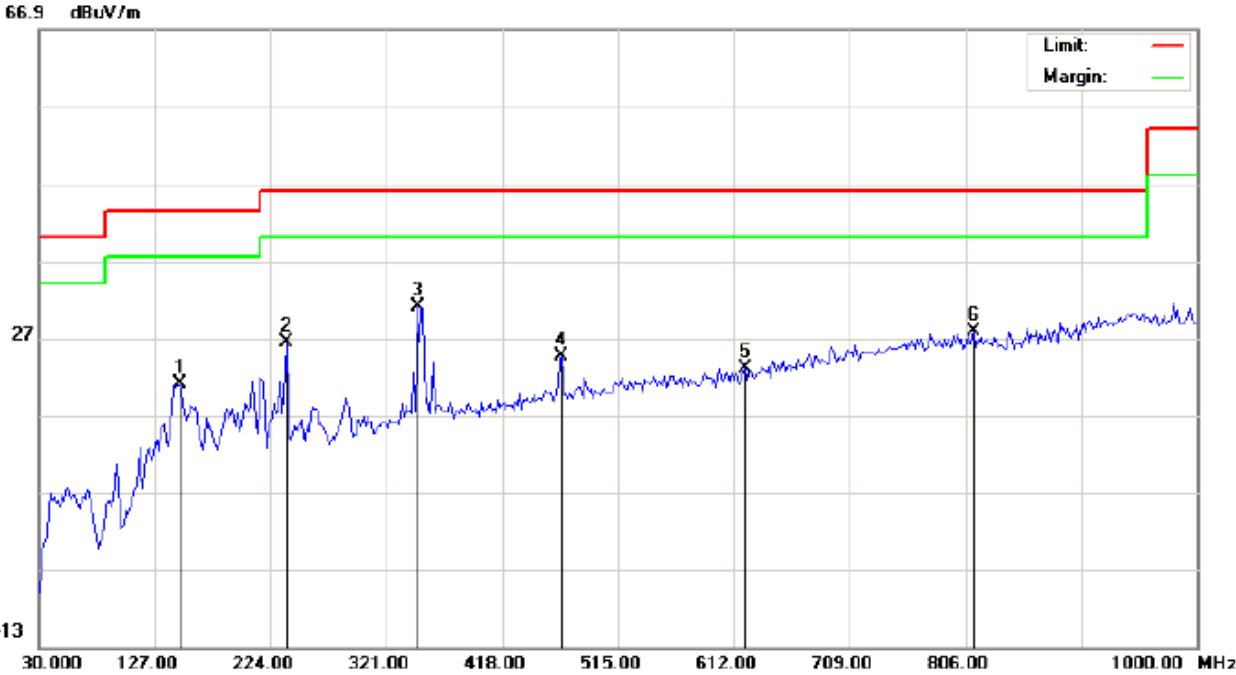

Site: site #1  
 Limit: FCC Class B 3M Radiation  
 EUT: Mobile Phone  
 M/N: AM513  
 Mode: Low Channel TX  
 Note:

Polarization: *Vertical*  
 Power: AC 120V/60Hz  
 Distance: 3m

Temperature: 26  
 Humidity: 60 %

No.	Mk	Freq.	Reading	Factor	Measurement	Limit	Over	Detector	Antenna Height	Table Degree	Comment
		MHz	dBuV	dB/m	dBuV/m	dBuV/m	dB		cm	degree	
1		148.0167	5.70	15.25	20.95	43.50	-22.55	peak			
2		236.9333	13.86	12.62	26.48	46.00	-19.52	peak			
3	*	346.8667	12.57	18.53	31.10	46.00	-14.90	peak			
4		468.1167	3.87	20.79	24.66	46.00	-21.34	peak			
5		621.7000	-0.12	23.22	23.10	46.00	-22.90	peak			
6		812.4667	0.48	27.32	27.80	46.00	-18.20	peak			

**RESULT: PASS**



<b>EUT</b>	mobile phone	<b>Model Name</b>	AM513
<b>Temperature</b>	25°C	<b>Relative Humidity</b>	55.4%
<b>Pressure</b>	960hPa	<b>Test Voltage</b>	Normal Voltage
<b>Test Mode</b>	802.11b with data rate 1 2437MHZ	<b>Antenna</b>	Vertical

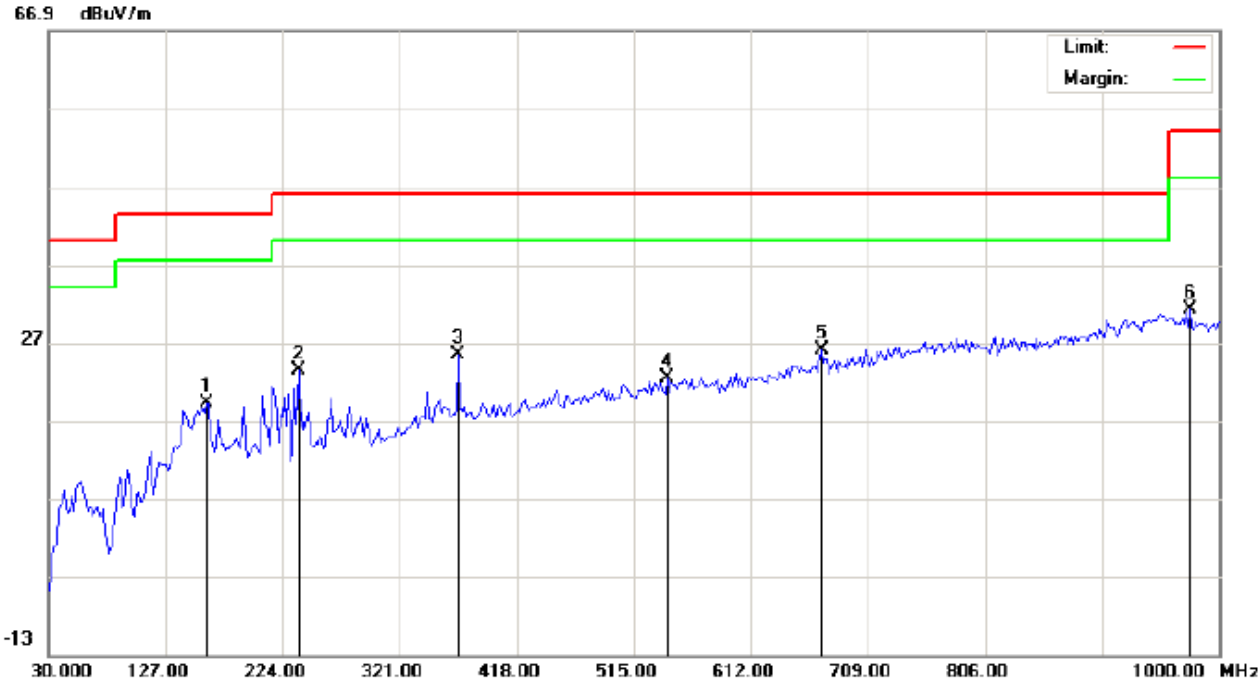

Site: site #1  
 Limit: FCC Class B 3M Radiation  
 EUT: Mobile Phone  
 M/N: AM513  
 Mode: Middle Channel TX  
 Note:

Polarization: *Vertical*  
 Power: AC 120V/60Hz  
 Distance: 3m

Temperature: 26  
 Humidity: 60 %

No.	Mk	Freq.	Reading	Factor	Measurement	Limit	Over	Detector	Antenna Height	Table Degree	Comment
		MHz	dBuV	dB/m	dBuV/m	dBuV/m	dB		cm	degree	
1		160.9500	3.96	15.27	19.23	43.50	-24.27	peak			
2		236.9333	10.81	12.62	23.43	46.00	-22.57	peak			
3		369.5000	6.58	18.87	25.45	46.00	-20.55	peak			
4		542.4833	0.15	22.28	22.43	46.00	-23.57	peak			
5	*	670.2000	1.60	24.39	25.99	46.00	-20.01	peak			
6		975.7500	1.54	29.75	31.29	54.00	-22.71	peak			

**RESULT: PASS**

<b>EUT</b>	mobile phone	<b>Model Name</b>	AM513
<b>Temperature</b>	25°C	<b>Relative Humidity</b>	55.4%
<b>Pressure</b>	960hPa	<b>Test Voltage</b>	Normal Voltage
<b>Test Mode</b>	802.11b with data rate 1 2462MHZ	<b>Antenna</b>	Horizontal

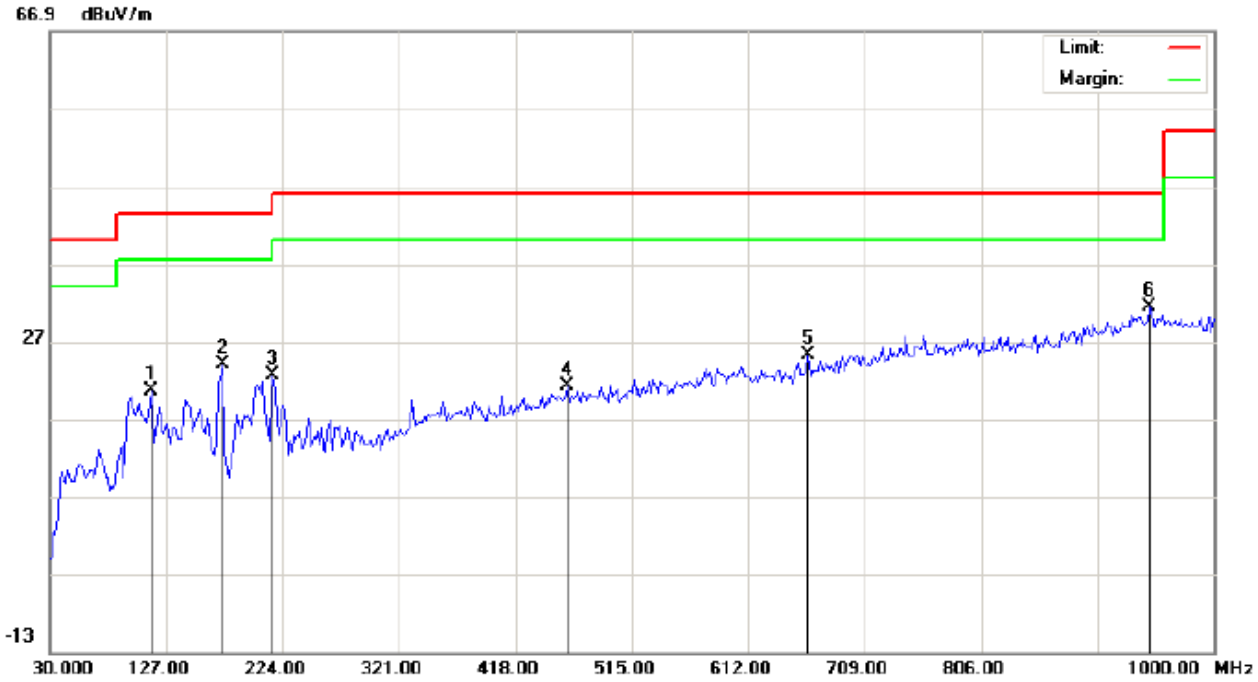

Site: site #1  
 Limit: FCC Class B 3M Radiation  
 EUT: Mobile Phone  
 M/N: AM513  
 Mode: High Channel TX  
 Note:

Polarization: *Horizontal*  
 Power: AC 120V/60Hz  
 Distance: 3m

Temperature: 26  
 Humidity: 60 %

No.	Mk	Freq.	Reading	Factor	Measurement	Limit	Over	Detector	Antenna Height	Table Degree	Comment
		MHz	dBuV	dB/m	dBuV/m	dBuV/m	dB		cm	degree	
1		114.0667	9.18	11.45	20.63	43.50	-22.87	peak			
2		173.8833	11.66	12.37	24.03	43.50	-19.47	peak			
3		215.9167	10.05	12.60	22.65	43.50	-20.85	peak			
4		461.6500	0.39	20.72	21.11	46.00	-24.89	peak			
5		662.1167	1.02	24.17	25.19	46.00	-20.81	peak			
6	*	946.6500	1.56	29.91	31.47	46.00	-14.53	peak			

**RESULT: PASS**

<b>EUT</b>	mobile phone	<b>Model Name</b>	AM513
<b>Temperature</b>	25°C	<b>Relative Humidity</b>	55.4%
<b>Pressure</b>	960hPa	<b>Test Voltage</b>	Normal Voltage
<b>Test Mode</b>	802.11b with date rate 1 2462MHZ	<b>Antenna</b>	Vertical

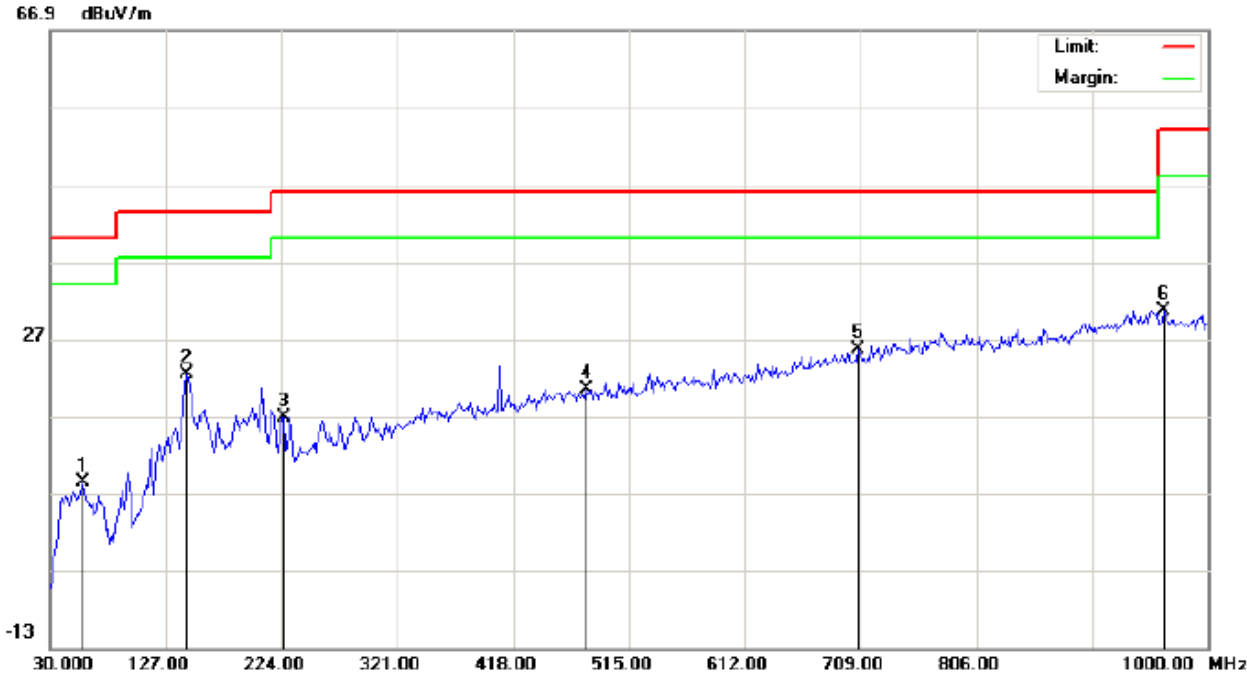

Site: site #1  
 Limit: FCC Class B 3M Radiation  
 EUT: Mobile Phone  
 M/N: AM513  
 Mode: High Channel TX  
 Note:

Polarization: **Vertical**  
 Power: AC 120V/60Hz  
 Distance: 3m

Temperature: 26  
 Humidity: 60 %

No.	Mk	Freq.	Reading	Factor	Measurement	Limit	Over	Detector	Antenna Height	Table Degree	Comment
		MHz	dBuV	dB/m	dBuV/m	dBuV/m	dB		cm	degree	
1		57.4833	0.16	8.17	8.33	40.00	-31.67	peak			
2		144.7833	7.27	15.23	22.50	43.50	-21.00	peak			
3		225.6167	5.37	11.51	16.88	46.00	-29.12	peak			
4		479.4333	-0.41	20.91	20.50	46.00	-25.50	peak			
5	*	707.3832	0.23	25.40	25.63	46.00	-20.37	peak			
6		962.8167	0.79	29.88	30.67	54.00	-23.33	peak			

**RESULT: PASS**

- Note:** 1. Factor=Antenna Factor + Cable loss, Margin=Measurement-Limit.  
 2. The "Factor" value can be calculated automatically by software of measurement system.







## 12. BAND EDGE EMISSION

### 12.1. MEASUREMENT PROCEDURE

1) Radiated restricted band edge measurements

The radiated restricted band edge measurements are measured with an EMI test receiver connected to the receive antenna while the EUT is transmitting

2) Conducted Emissions at the bang edge

a) The transmitter output was connected to the spectrum analyzer

b) Set RBW=100kHz, VBW=300kHz

c) Suitable frequency span including 100kHz bandwidth from band edge

### 12.2. TEST SET-UP

Radiated same as 11.2

Conducted set up

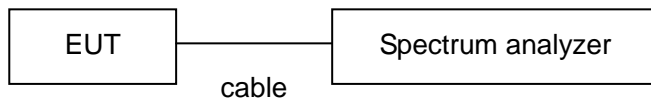









12.4. Conducted Test Result

802.11b-CH1

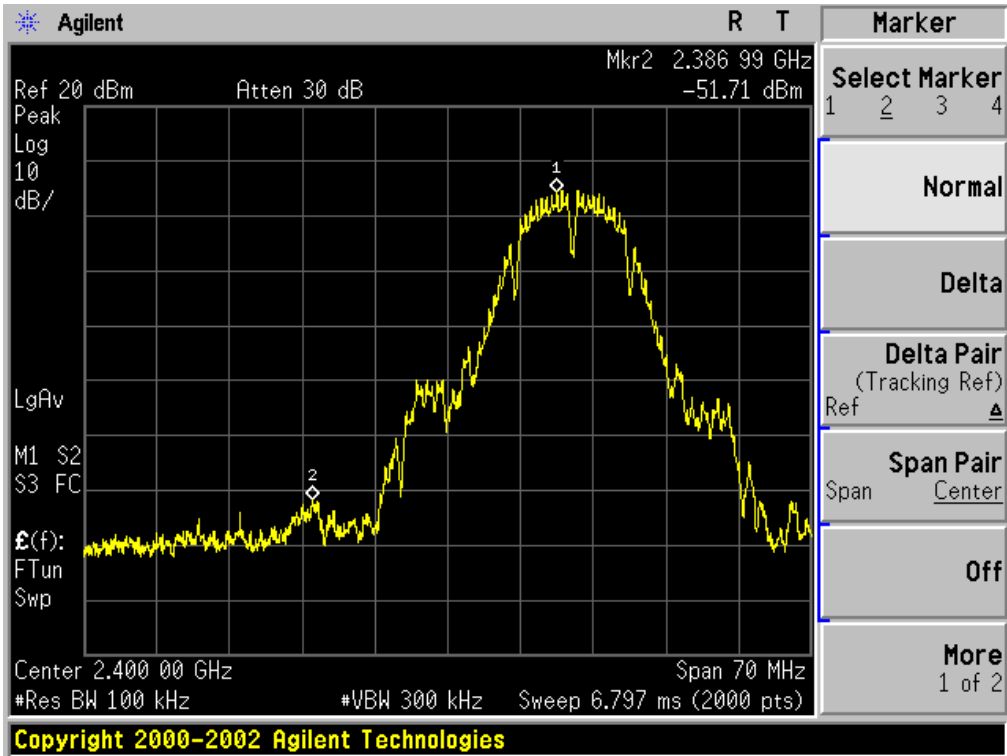

802.11b-CH11

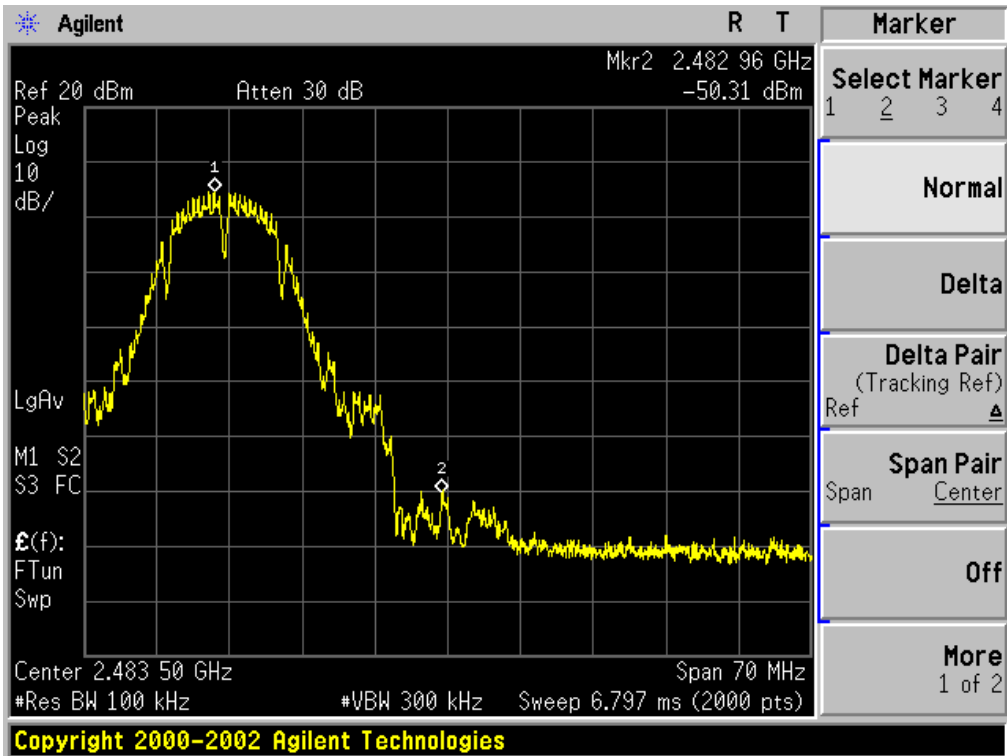



802.11g- CH1

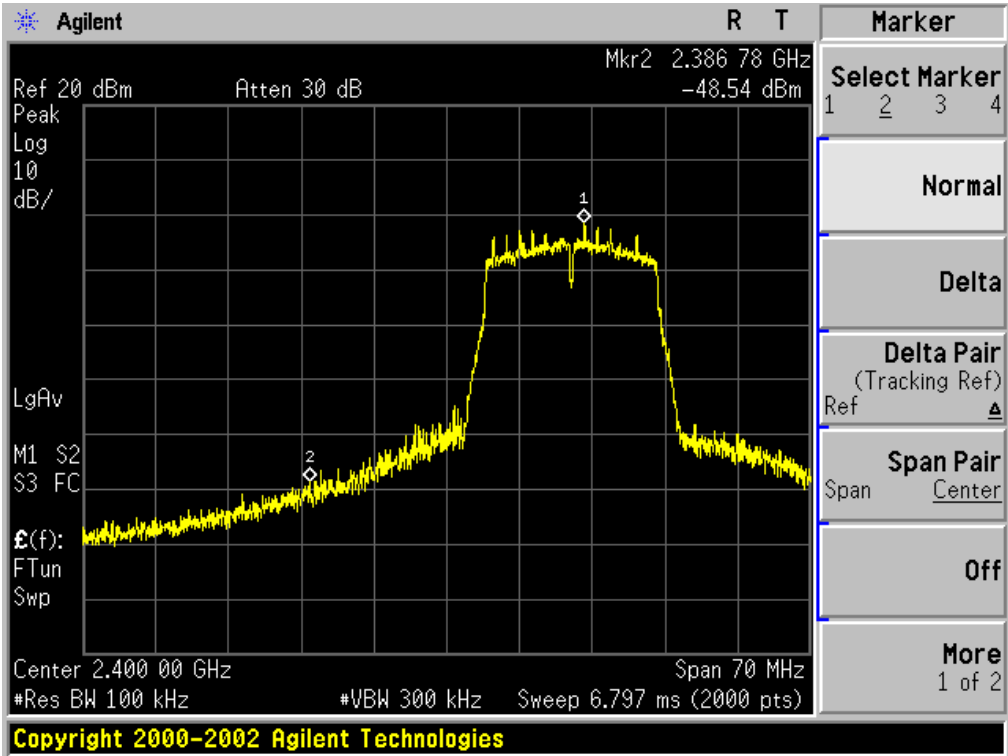

802.11g- CH11

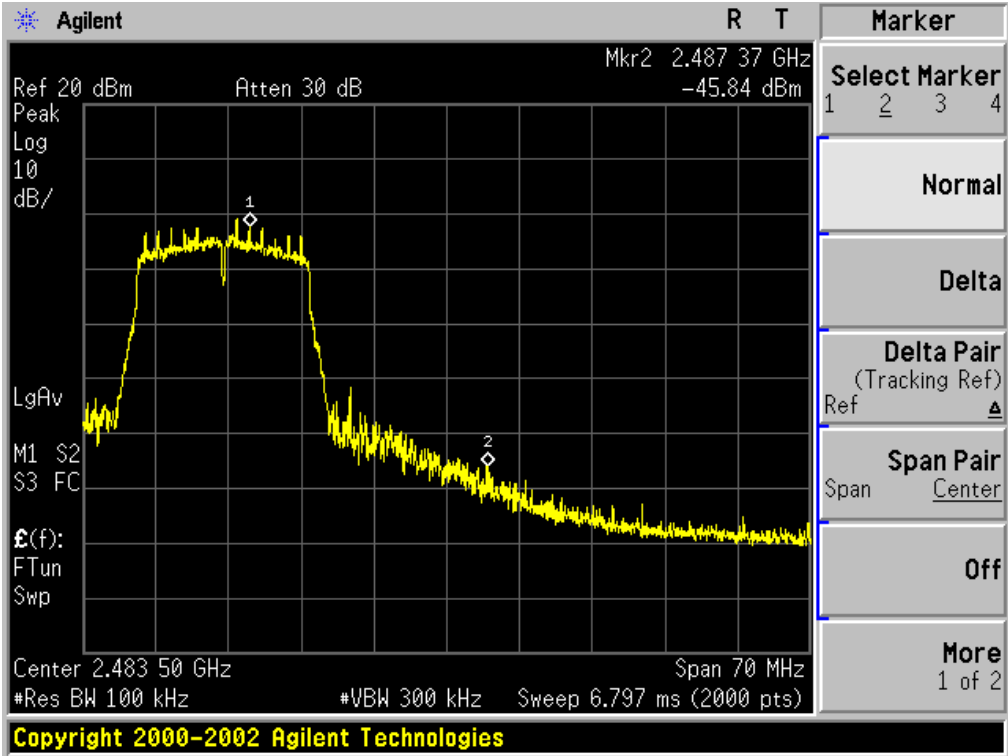

802.11n-CH1

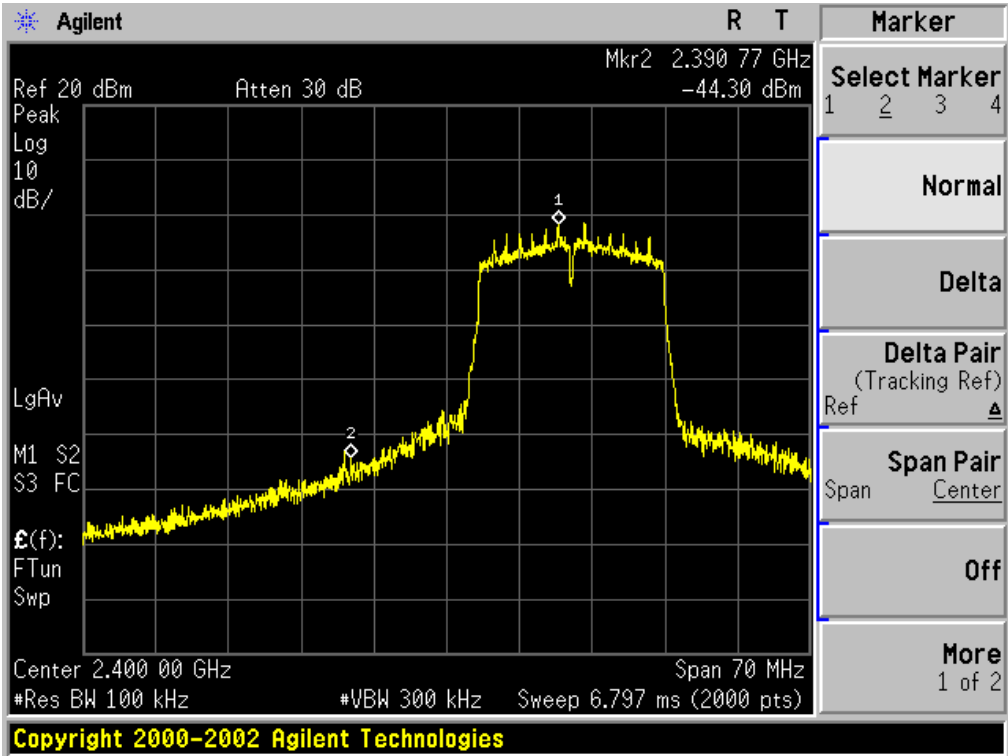

802.11n-CH11

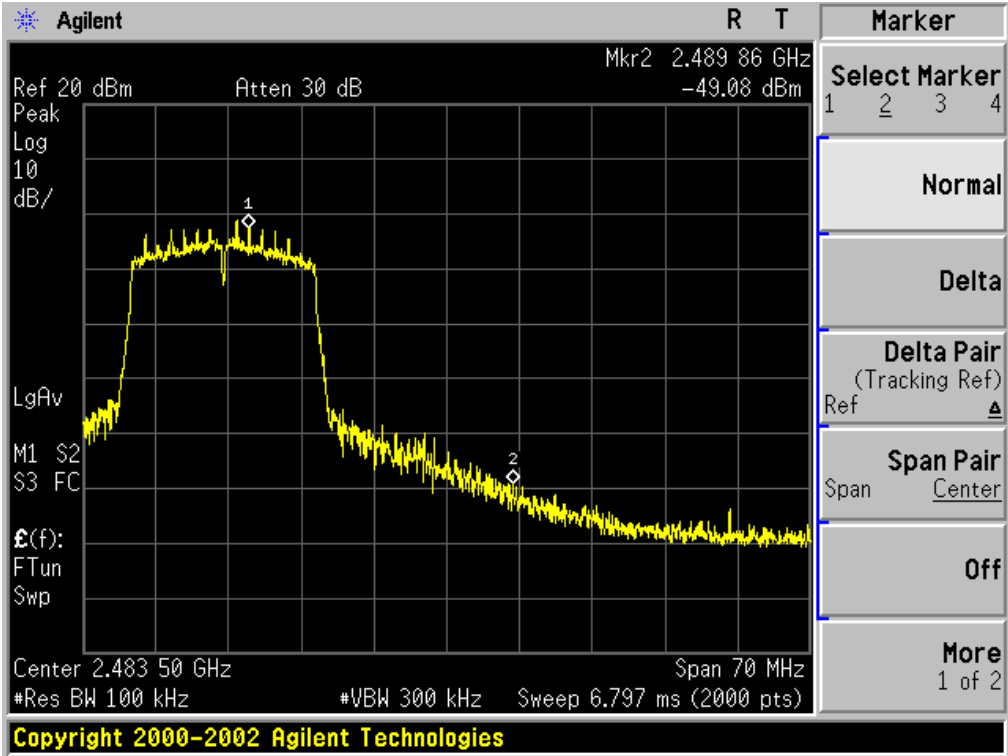

**13. FCC LINE CONDUCTED EMISSION TEST**

**13.1. LIMITS OF LINE CONDUCTED EMISSION TEST**

Frequency	Maximum RF Line Voltage	
	Q.P.( dBuV)	Average( dBuV)
150kHz~500kHz	66-56	56-46
500kHz~5MHz	56	46
5MHz~30MHz	60	50

Note:

1. The lower limit shall apply at the transition frequency.
2. The limit decreases linearly with the logarithm of the frequency in the range 0.15 MHz to 0.50 MHz.

**13.2. BLOCK DIAGRAM OF LINE CONDUCTED EMISSION TEST**

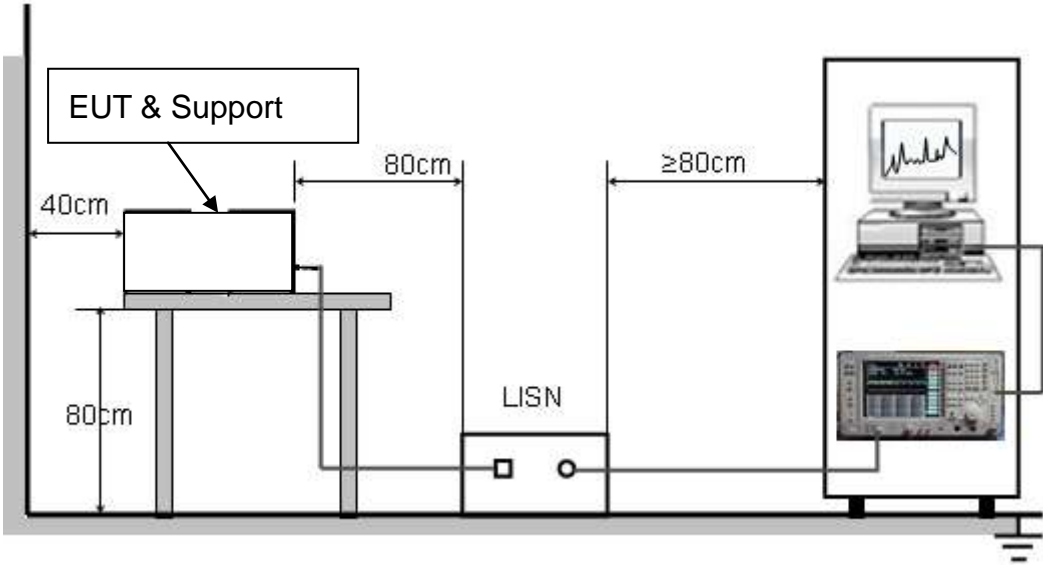

### **13.3. PRELIMINARY PROCEDURE OF LINE CONDUCTED EMISSION TEST**

1. The equipment was set up as per the test configuration to simulate typical actual usage per the user's manual. When the EUT is a tabletop system, a wooden table with a height of 0.8 meters is used and is placed on the ground plane as per ANSI C63.4 (see Test Facility for the dimensions of the ground plane used). When the EUT is a floor-standing equipment, it is placed on the ground plane which has a 3-12 mm non-conductive covering to insulate the EUT from the ground plane.
2. Support equipment, if needed, was placed as per ANSI C63.4.
3. All I/O cables were positioned to simulate typical actual usage as per ANSI C63.4.
4. All support equipments received AC120V/60Hz power from a LISN, if any.
5. The EUT received charging voltage by adapter which received 120V/60Hz power by a LISN..
6. The test program was started. Emissions were measured on each current carrying line of the EUT using a spectrum Analyzer / Receiver connected to the LISN powering the EUT. The LISN has two monitoring points: Line 1 (Hot Side) and Line 2 (Neutral Side). Two scans were taken: one with Line 1 connected to Analyzer / Receiver and Line 2 connected to a 50 ohm load; the second scan had Line 1 connected to a 50 ohm load and Line 2 connected to the Analyzer / Receiver.
7. Analyzer / Receiver scanned from 150 kHz to 30MHz for emissions in each of the test modes.
8. During the above scans, the emissions were maximized by cable manipulation.
9. The test mode(s) were scanned during the preliminary test.

Then, the EUT configuration and cable configuration of the above highest emission level were recorded for reference of final testing.

### **13.4. FINAL PROCEDURE OF LINE CONDUCTED EMISSION TEST**

1. EUT and support equipment was set up on the test bench as per step 2 of the preliminary test.
2. A scan was taken on both power lines, Line 1 and Line 2, recording at least the six highest emissions. Emission frequency and amplitude were recorded into a computer in which correction factors were used to calculate the emission level and compare reading to the applicable limit. If EUT emission level was less -2dB to the A.V. limit in Peak mode, then the emission signal was re-checked using Q.P and Average detector.
3. The test data of the worst case condition(s) was reported on the Summary Data page.

13.5. TEST RESULT OF LINE CONDUCTED EMISSION TEST

LINE CONDUCTED EMISSION TEST LINE 1-L

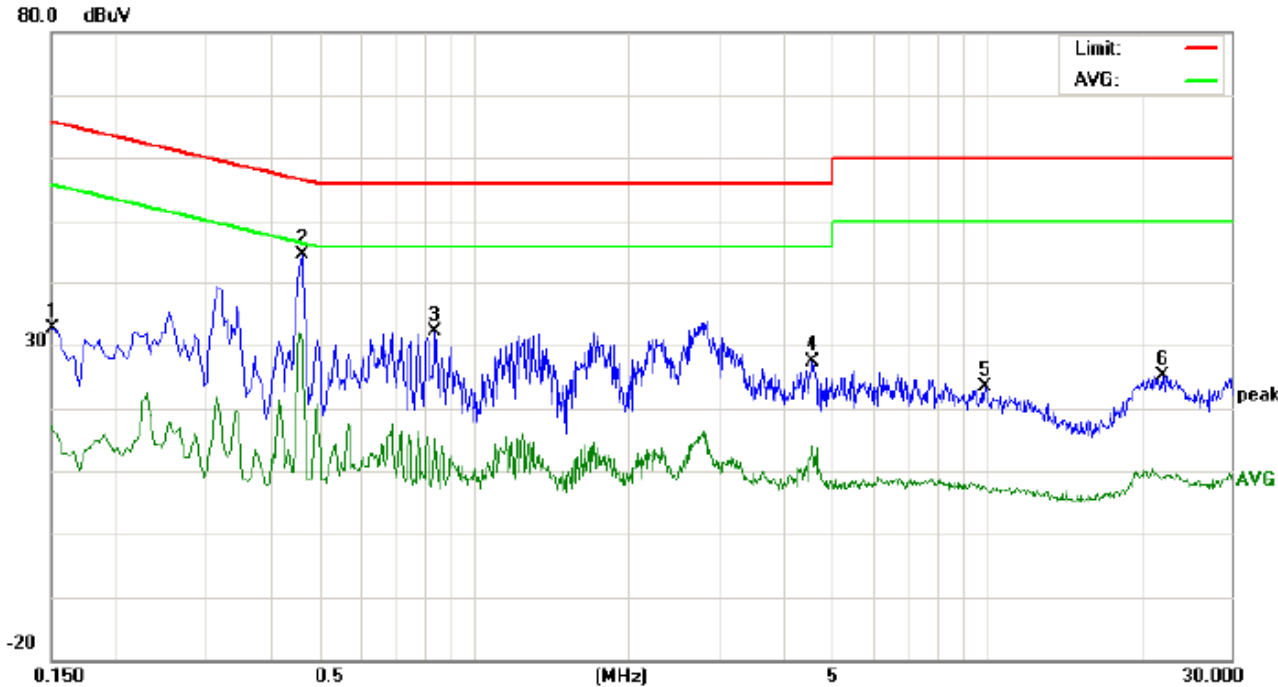

Site: Conduction Phase: **L1** Temperature: 26  
 Limit: FCC Class B Conduction(QP) Power: AC 120V/60Hz Humidity: 60 %  
 EUT: Mobile Phone  
 M/N: AM513  
 Mode: Normal Operating(WIFI)  
 Note:

No.	Freq. (MHz)	Reading_Level (dBuV)			Correct Factor (dB)	Measurement (dBuV)			Limit (dBuV)		Margin (dB)		P/F	Comment
		Peak	QP	AVG		Peak	QP	AVG	QP	AVG	QP	AVG		
1	0.1500	22.56		6.91	10.16	32.72		17.07	65.99	55.99	-33.27	-38.92	P	
2	0.4620	34.33		20.17	10.37	44.70		30.54	56.66	46.66	-11.96	-16.12	P	
3	0.8420	21.85		4.81	10.33	32.18		15.14	56.00	46.00	-23.82	-30.86	P	
4	4.5860	17.06		3.69	10.22	27.28		13.91	56.00	46.00	-28.72	-32.09	P	
5	9.9620	13.19		-2.63	10.11	23.30		7.48	60.00	50.00	-36.70	-42.52	P	
6	22.1700	15.09		-0.89	10.12	25.21		9.23	60.00	50.00	-34.79	-40.77	P	

Line Conducted Emission Test Line 2-N

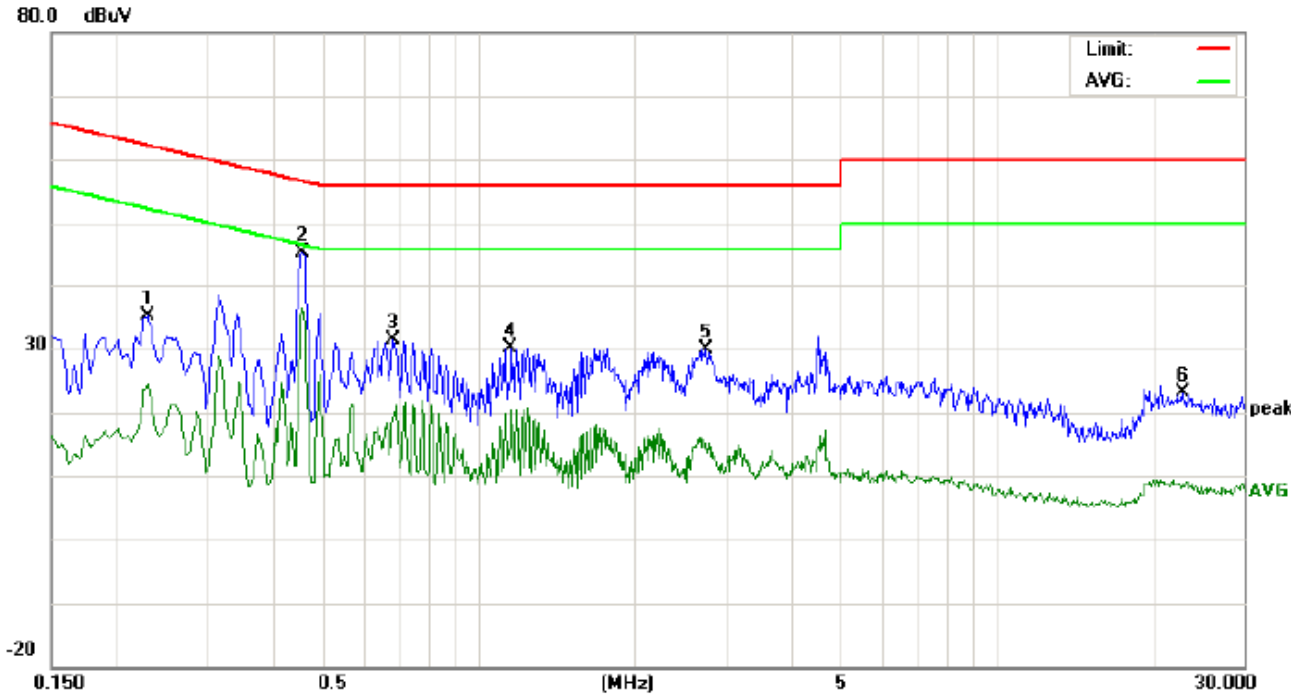

Site: Conduction Phase: **N** Temperature: 26  
 Limit: FCC Class B Conduction(QP) Power: AC 120V/60Hz Humidity: 60 %  
 EUT: Mobile Phone  
 M/N: AM513  
 Mode: Normal Operating(WIFI)  
 Note:

No.	Freq. (MHz)	Reading_Level (dBuV)			Correct Factor dB	Measurement (dBuV)			Limit (dBuV)		Margin (dB)		P/F	Comment
		Peak	QP	AVG		Peak	QP	AVG	QP	AVG	QP	AVG		
1	0.2260	24.45		13.31	10.24	34.69		23.55	62.59	52.59	-27.90	-29.04	P	
2	0.4580	35.04		26.07	10.37	45.41		36.44	56.73	46.73	-11.32	-10.29	P	
3	0.6860	20.95		8.89	10.34	31.29		19.23	56.00	46.00	-24.71	-26.77	P	
4	1.1580	19.88		10.05	10.37	30.25		20.42	56.00	46.00	-25.75	-25.58	P	
5	2.7540	21.43		5.99	10.49	31.92		16.48	56.00	46.00	-24.08	-29.52	P	
6	22.8700	12.96		-1.71	10.11	23.07		8.40	60.00	50.00	-36.93	-41.60	P	

**APPENDIX A: PHOTOGRAPHS OF TEST SETUP**  
FCC LINE CONDUCTED EMISSION TEST SETUP



FCC RADIATED EMISSION TEST SETUP

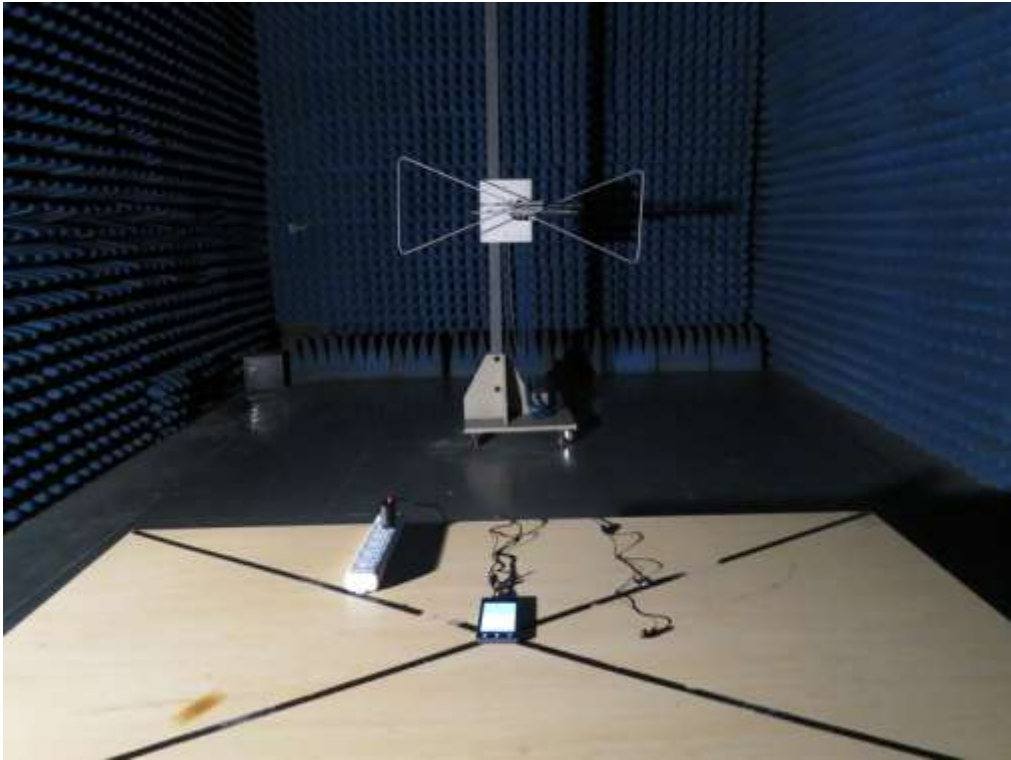

**APPENDIX B: PHOTOGRAPHS OF EUT**  
TOTAL VIEW OF EUT



TOP VIEW OF EUT





BOTTOM VIEW OF EUT



FRONT VIEW OF EUT



BACK VIEW OF EUT



LEFT VIEW OF EUT



RIGHT VIEW OF EUT



OPEN VIEW OF EUT-1





OPEN VIEW OF EUT-2



OPEN VIEW OF EUT-3



INTERNAL VIEW OF EUT-1



INTERNAL VIEW OF EUT-2



----END OF REPORT----