

---

# SAR Test Report

---

Report No.: AGC00688140803FH01

**FCC ID** : UOSAM503  
**APPLICATION PURPOSE** : Original Equipment  
**PRODUCT DESIGNATION** : mobile phone  
**BRAND NAME** : AMGOO  
**MODEL NAME** : AM503  
**CLIENT** : Amgoo Telecom(Shenzhen) Co., Ltd.  
**DATE OF ISSUE** : Oct. 16,2014  
**STANDARD(S)** : IEEE Std. 1528:2003  
: 47CFR § 2.1093  
: IEEE/ANSI C95.1  
**REPORT VERSION** : V1.0

Attestation of Global Compliance(Shenzhen) Co., Ltd.

**CAUTION:**

This report shall not be reproduced except in full without the written permission of the test laboratory and shall not be quoted out of context.



### Report Revise Record

Report Version	Revise Time	Issued Date	Valid Version	Notes
V1.0	/	Oct. 16,2014	Valid	Original Report

The test plans were performed in accordance with IEEE Std. 1528:2003; 47CFR § 2.1093; IEEE/ANSI C95.1 and the following specific FCC Test Procedures:

- KDB 447498 D01 General RF Exposure Guidance v05r02
- KDB 648474 D04 SAR Handsets Multi Xmitter and Ant v01
- KDB 865664 D01 SAR measurement 100 MHz to 6 GHz v01r03
- KDB 941225 D01 SAR test for 3G devices v02
- KDB 941225 D02 Guidance for 3GPP R6 and R7 HSPA v02r02
- KDB 941225 D03 SAR Test Reduction GSM GPRS EDGE v01
- KDB 941225 D06 Hot Spot SAR v01
- KDB 248227 D01 SAR meas for 802 11 a b g v01r02

## Test Report Certification

Applicant Name	Amgoo Telecom(Shenzhen) Co., Ltd.
Applicant Address	3/F, Block R2-A(North), Gaoxin S. Ave. 4th, Hi-Tech Industrial Park, Nanshan District, Shenzhen, China
Manufacturer Name	Amgoo Telecom(Shenzhen) Co., Ltd.
Manufacturer Address	3/F, Block R2-A(North), Gaoxin S. Ave. 4th, Hi-Tech Industrial Park, Nanshan District, Shenzhen, China
Product Designation	mobile phone
Brand Name	AMGOO
Model Name	AM503
Different Description	N/A
EUT Voltage	DC3.7V by battery
Applicable Standard	IEEE Std. 1528:2003 47CFR § 2.1093 IEEE/ANSI C95.1
Test Date	Oct.16,2014
Performed Location	Attestation of Global Compliance(Shenzhen) Co., Ltd.
	2 F, Building 2, No.1-No.4, Chaxi Sanwei Technical Industrial Park, Gushu, Xixiang Street, Bao'an District, Shenzhen, China
Report Template	AGCRT-US-3G3/SAR (2014-04-01)

Tested By

*Eric Zhou*

Eric Zhou      Oct. 16,2014

Checked By

*Angela Li*

Angela Li      Oct. 16,2014

Authorized By

*Solger Zhang*

Solger Zhang      Oct. 16,2014

## TABLE OF CONTENTS

<b>1. SUMMARY OF MAXIMUM SAR VALUE .....</b>	<b>5</b>
<b>2. GENERAL INFORMATION.....</b>	<b>6</b>
2.1. EUT DESCRIPTION.....	6
2.2. TEST PROCEDURE .....	7
2.3. TEST ENVIRONMENT.....	7
2.4. TEST CONFIGURATION AND SETTING .....	8
<b>3. SAR MEASUREMENT SYSTEM.....</b>	<b>9</b>
3.1. SPECIFIC ABSORPTION RATE (SAR) .....	9
3.2. SAR MEASUREMENT PROCEDURE .....	10
3.3. COMOSAR SYSTEM DESCRIPTION.....	11
3.4. COMOSAR E-FIELD PROBE .....	13
3.5. ISOTROPIC E-FIELD PROBE SPECIFICATION .....	13
3.6. ROBOT.....	13
3.7. VIDEO POSITIONING SYSTEM .....	14
3.8. DEVICE HOLDER .....	14
3.9. SAM TWIN PHANTOM.....	15
<b>4. TISSUE SIMULATING LIQUID .....</b>	<b>16</b>
4.1. THE COMPOSITION OF THE TISSUE SIMULATING LIQUID.....	16
4.2. TISSUE CALIBRATION RESULT.....	17
4.3. TISSUE DIELECTRIC PARAMETERS FOR HEAD AND BODY PHANTOMS.....	18
<b>5. SAR MEASUREMENT PROCEDURE .....</b>	<b>19</b>
5.1. SAR SYSTEM VALIDATION PROCEDURES .....	19
5.2. SAR SYSTEM VALIDATION.....	20
<b>6. EUT TEST POSITION.....</b>	<b>22</b>
6.1. DEFINE TWO IMAGINARY LINES ON THE HANDSET.....	22
6.2. CHEEK POSITION .....	23
6.3. TITLE POSITION .....	23
6.4. BODY WORN POSITION.....	24
<b>7. SAR EXPOSURE LIMITS .....</b>	<b>25</b>
<b>8. TEST EQUIPMENT LIST .....</b>	<b>26</b>
<b>9. MEASUREMENT UNCERTAINTY .....</b>	<b>27</b>
<b>10. CONDUCTED POWER MEASUREMENT .....</b>	<b>28</b>
<b>11. TEST RESULTS .....</b>	<b>33</b>
11.1. SAR TEST RESULTS SUMMARY .....	33
<b>APPENDIX A. SAR SYSTEM VALIDATION DATA .....</b>	<b>41</b>
<b>APPENDIX B. SAR MEASUREMENT DATA.....</b>	<b>51</b>
<b>APPENDIX C. TEST SETUP PHOTOGRAPHS &amp;EUT PHOTOGRAPHS .....</b>	<b>125</b>
<b>APPENDIX D. PROBE CALIBRATION DATA .....</b>	<b>135</b>
<b>APPENDIX E. DIPOLE CALIBRATION DATA.....</b>	<b>145</b>

## 1. SUMMARY OF MAXIMUM SAR VALUE

The maximum results of Specific Absorption Rate (SAR) found during testing for EUT are as follows:

### Highest tested and scaled SAR Summary

Exposure Position	Frequency Band	Highest Tested 1g-SAR(W/Kg)	Highest Scaled Maximum SAR(W/Kg)
Head	GSM 850	0.378	0.400
	PCS 1900	0.248	0.273
	WCDMA Band II	0.726	0.750
	WCDMA Band V	0.770	0.803
Body- worn	GSM 850	1.193	1.287
	PCS 1900	0.285	0.313
	WCDMA Band II	0.908	0.946
	WCDMA Band V	1.024	1.080

Exposure Position	Test Mode	Highest Tested 1g-SAR(W/Kg)	Highest Scaled Maximum SAR(W/Kg)
Body	HOTSPOT	0.242	0.260

### Highest Simultaneous transmission SAR Summary

Exposure Position	Frequency Band	Highest Simultaneous SAR(W/Kg)
Head	GSM 850+ WLAN	0.814
	PCS 1900+ WLAN	0.687
	WCDMA Band II + WLAN	1.164
	WCDMA Band V + WLAN	1.217
Body- worn	GSM 850+ HOTSPOT	1.547
	PCS 1900+ HOTSPOT	0.573
	WCDMA Band II + HOTSPOT	1.206
	WCDMA Band V + HOTSPOT	1.340

This device is compliance with Specific Absorption Rate (SAR) for general population/uncontrolled exposure limits (1.6W/Kg) specified in FCC 47 CFR part 2 (2.1093) and ANSI/IEEE C95.1, and had been tested in accordance with measurement methods and procedures specified in IEEE 1528-2003 and the relevant KDB files like KDB 941225 D01 , KDB 941225 D03 ,KDB 865664 D02....etc.

## 2. GENERAL INFORMATION

### 2.1. EUT Description

General Information	
Product Designation	mobile phone
Test Model	AM503
Hardware Version	T1-V2.0
Software Version	AM503-ES_band125_V08_2014_09_20
Device Category	Portable
RF Exposure Environment	Uncontrolled
Antenna Type	Internal
GSM and GPRS	
Support Band	<input checked="" type="checkbox"/> GSM 850 <input checked="" type="checkbox"/> PCS 1900 (U.S. Bands) <input checked="" type="checkbox"/> GSM 900 <input checked="" type="checkbox"/> DCS 1800 (Non-U.S. Bands)
GPRS Type	Class B
GPRS Class	Class 12(1Tx+4Rx, 2Tx+3Rx, 3Tx+2Rx, 4Tx+1Rx)
TX Frequency Range	GSM 850 : 824.2~848.8MHz; PCS 1900: 1850.2~1909.8MHz;
RX Frequency Range	GSM 850 : 869~894MHz PCS 1900: 1930~1990MHz
Release Version	R99
Type of modulation	GMSK for GSM/GPRS
Antenna Gain	-1.0dBi(GSM 850), -0.8dBi (PCS1900)
Max. Average Power (Max. Peak Power)	GSM850: 31.89dBm(32.62dBm- Peak Power) PCS1900: 28.65dBm(29.33dBm-Peak Power)
WCDMA	
Support Band	U.S. Bands: <input checked="" type="checkbox"/> UMTS FDD Band II <input checked="" type="checkbox"/> UMTS FDD Band V Non-U.S. Bands: <input type="checkbox"/> UMTS FDD Band I <input type="checkbox"/> UMTS FDD Band VIII
HS Type	HSPA(HSUPA/HSDPA)
TX Frequency Range	WCDMA FDD Band II: 1852.4 -1907.6MHz WCDMA FDD Band V: 826.4-846.6MHz
RX Frequency Range	WCDMA FDD Band II: 1930-1990MHz WCDMA FDD Band V: 869-894MHz
Release Version	Rel-6
Type of modulation	QPSK
Antenna Gain	-1.0dBi(WCDMA 850), -0.8dBi (WCDMA 1900)
Max. Average Power (Max. Peak Power)	Band II: 22.91dBm (23.56dBm- Peak Power) Band V: 22.86dBm (23.44dBm- Peak Power)

**EUT Description( Continue)**

<b>Bluetooth</b>	
Bluetooth Version	<input type="checkbox"/> V2.0 <input type="checkbox"/> V2.1 <input type="checkbox"/> V2.1+EDR <input checked="" type="checkbox"/> V3.0 <input type="checkbox"/> V3.0+HS <input checked="" type="checkbox"/> V4.0
Operation Frequency	2402~2480MHz
Type of modulation	<input checked="" type="checkbox"/> GFSK <input checked="" type="checkbox"/> π/4-DQPSK <input checked="" type="checkbox"/> 8-DPSK
Avg. Burst Power	0.03dBm
Antenna Gain	0.8dBi
<b>WIFI</b>	
WIFI Specification	<input type="checkbox"/> 802.11a <input checked="" type="checkbox"/> 802.11b <input checked="" type="checkbox"/> 802.11g <input checked="" type="checkbox"/> 802.11n(20) <input checked="" type="checkbox"/> 802.11n(40)
Operation Frequency	2412~2462MHz
Avg. Burst Power	11b: 9.86dBm, 11g: 7.88dBm, 11n(20): 7.74dBm, 11n(40): 4.79dBm
Antenna Gain	0.8dBi
<b>Accessories</b>	
Battery	Brand name: AMG00 Model No. : AM503 Voltage and Capacitance: 3.7 V & 1200mAh
Adapter	Brand name: AMGOO Model No. : CH4 Input: AC 100-240V, 50/60Hz, 0.15A    Output: DC 5V, 500mA
Earphone	Brand name: N/A Model No. : N/A
Note:CMU200 can measure the average power and Peak power at the same time	
Product	Type
	<input checked="" type="checkbox"/> Production unit <input type="checkbox"/> Identical Prototype

**2.2. Test Procedure**

1	Setup the EUT and simulators as shown on above.
2	Turn on the power of all equipment.
3	EUT Communicate with 8960, and test them respectively at U.S. bands

**2.3. Test Environment**

Ambient conditions in the laboratory:

Items	Required	Actual
Temperature (°C)	18-25	21± 2
Humidity (%RH)	30-70	55±2

## 2.4. Test Configuration and setting

The EUT is a model of GSM Portable Mobile Station (MS). It supports GSM/GPRS, WCDMA/HSPA, BT, WIFI, and support hot spot mode.

For WWAN SAR testing, the device was controlled by using a base station emulator. Communication between the device and the emulator were established by air link. The distance between the EUT and the antenna is larger than 50cm, and the output power radiated from the emulator antenna is at least 30db smaller than the output power of EUT.

For WLAN testing, the EUT is configured with the WLAN continuous TX tool through engineering command.

### Antenna Location:

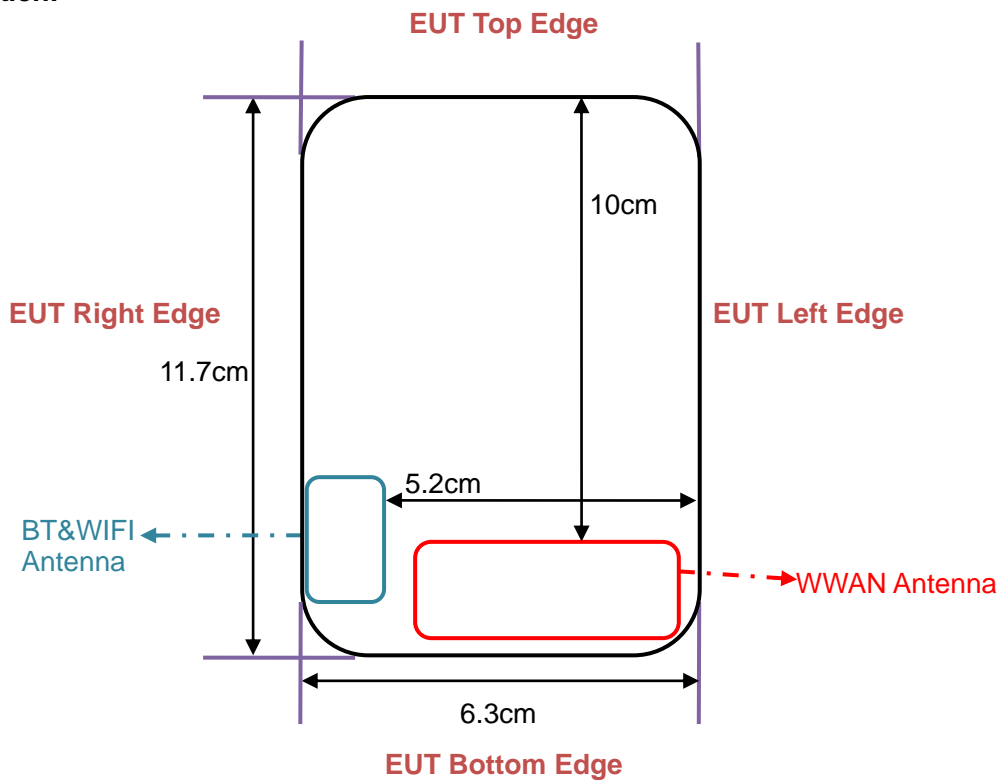

The separation distance for antenna to edge:

Antenna	To Top Side(cm)	To Bottom Side(cm)	To Left Side(cm)	To Right Side(cm)
WWAN	10	0.2	0.2	1.0
BT/WIFI	7.1	0.6	5.2	0.1

The simultaneous transmission possibilities are listed as below:

Simultaneous TX Combination	Configuration	Head	Body	Hotspot
1	GSM850(Voice)+WLAN/BT	Yes	Yes	Yes
2	PCS 1900(Voice)+WLAN/BT	Yes	Yes	Yes
3	WCDMA Band II+WLAN/BT	Yes	Yes	Yes
4	WCDMA Band V +WLAN/BT	Yes	Yes	Yes



### 3. SAR MEASUREMENT SYSTEM

#### 3.1. Specific Absorption Rate (SAR)

SAR is related to the rate at which energy is absorbed per unit mass in object exposed to a radio field. The SAR distribution in a biological body is complicated and is usually carried out by experimental techniques or numerical modeling. The standard recommends limits for two tiers of groups, occupational/controlled and occupational/uncontrolled, based on a person's awareness and ability to exercise control over his or her exposure. In general, occupational/controlled exposure limits are higher than the limits for general population/uncontrolled.

The SAR definition is the time derivative (rate) of the incremental energy (dW) absorbed by (dissipated in) an incremental mass (dm) contained in a volume (dv) of given mass density ( $\rho$ ). The equation description is as below:

$$SAR = \frac{d}{dt} \left( \frac{dW}{dm} \right) = \frac{d}{dt} \left( \frac{dW}{\rho dV} \right)$$

SAR is expressed in units of Watts per kilogram (W/Kg)

SAR can be obtained using either of the following equations:

$$SAR = \frac{\sigma E^2}{\rho}$$

$$SAR = c_h \left. \frac{dT}{dt} \right|_{t=0}$$

Where

SAR	is the specific absorption rate in watts per kilogram;
E	is the r.m.s. value of the electric field strength in the tissue in volts per meter;
$\sigma$	is the conductivity of the tissue in siemens per metre;
$\rho$	is the density of the tissue in kilograms per cubic metre;
$c_h$	is the heat capacity of the tissue in joules per kilogram and Kelvin;

$\left. \frac{dT}{dt} \right|_{t=0}$  is the initial time derivative of temperature in the tissue in kelvins per second

### **3.2. SAR Measurement Procedure**

The EUT is set to transmit at the required power in line with product specification, at each frequency relating to the LOW, MID, and HIGH channel settings.

Pre-scans are made on the device to establish the location for the transmitting antenna, using a large area scan in either air or tissue simulation fluid.

The EUT is placed against the Universal Phantom where the maximum area scan dimensions are larger than the physical size of the resonating antenna. When the scan size is not large enough to cover the peak SAR distribution, it is modified by either extending the area scan size in both the X and Y directions, or the device is shifted within the predefined area.

The area scan is then run to establish the peak SAR location (interpolated resolution set at  $1\text{mm}^2$ ) which is then used to orient the center of the zoom scan. The zoom scan is then executed and the 1g and 10g averages are derived from the zoom scan volume (interpolated resolution set at  $1\text{mm}^3$ ).

When multiple peak SAR location were found during the same configuration or test mode, Zoom scan shall performed on each peak SAR location, only the peak point with maximum SAR value will be reported for the configuration or test mode.

### 3.3. COMOSAR System Description

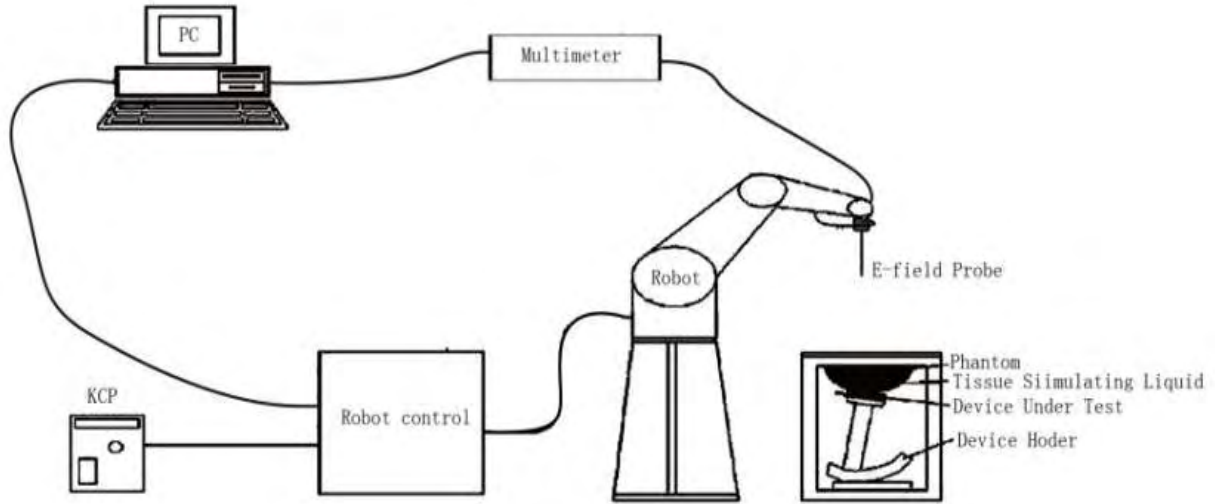

The COMOSAR system for performing compliance tests consists of the following items:

- The PC. It controls most of the bench devices and stores measurement data. A computer running WinXP and the Opensar software.
- The E-Field probe. The probe is a 3-axis system made of 3 distinct dipoles. Each dipole returns a voltage in function of the ambient electric field.
- The Keithley multimeter measures each probe dipole voltages.
- The SAM phantom simulates a human head. The measurement of the electric field is made inside the phantom.
- The liquids simulate the dielectric properties of the human head tissues.
- The network emulator controls the mobile phone under test.
- The validation dipoles are used to measure a reference SAR. They are used to periodically check the bench to make sure that there is no drift of the system characteristics over time.
- The phantom, the device holder and other accessories according to the targeted measurement.

#### 3.3.1. Applications

Predefined procedures and evaluations for automated compliance testing with all worldwide standards, e.g., IEEE 1528, IEC 62209-1, IEC 62209-2, EN 50360, EN 50383 and others.

### 3.3.2. Area Scans

Area scans are defined prior to the measurement process being executed with a user defined variable spacing between each measurement point (integral) allowing low uncertainty measurements to be conducted. Scans defined for FCC applications utilize a 10mm<sup>2</sup> step integral, with 1mm interpolation used to locate the peak SAR area used for zoom scan assessments.

When an Area Scan has measured all reachable points, it computes the field maxima found in the scanned area, within a range of the global maximum. The range (in dB) is specified in the standards for compliance testing. For example, a 2 dB range is required in IEEE 1528-2003, EN 50361 and IEC 62209 standards, whereby 3 dB is a requirement when compliance is assessed in accordance with the ARIB standard (Japan).

### 3.3.3. Zoom Scan (Cube Scan Averaging)

Zoom Scans are used to assess the peak spatial SAR values within a cubic averaging volume containing 1 g and 10 g of simulated tissue. A density of 1000 kg/m<sup>3</sup> is used to represent the head and body tissue density and not the phantom liquid density, in order to be consistent with the definition of the liquid dielectric properties, i.e. the side length of the 1 g cube is 10mm, with the side length of the 10 g cube 21,5mm.

The zoom scan integer steps can be user defined so as to reduce uncertainty, but normal practice for typical test applications utilize a physical step of 7x7x7 (5mmx5mmx5mm) providing a volume of 30mm in the X & Y axis, and 30mm in the Z axis.

### 3.3.4. Uncertainty of Inter-/Extrapolation and Averaging

In order to evaluate the uncertainty of the interpolation, extrapolation and averaged SAR calculation algorithms of the Post processor, COMOSAR allows the generation of measurement grids which are artificially predefined by analytically based test functions. Therefore, the grids of area scans and zoom scans can be filled with uncertainty test data, according to the SAR benchmark functions of IEEE 1528. The three analytical functions shown in equations as below are used to describe the possible range of the expected SAR distributions for the tested handsets. The field gradients are covered by the spatially flat distribution f1, the spatially steep distribution f3 and f2 accounts for H-field cancellation on the phantom/tissue surface.

$$f_1(x, y, z) = Ae^{-\frac{z}{2a}} \cos^2 \left( \frac{\pi \sqrt{x'^2 + y'^2}}{2 \cdot 5a} \right)$$

$$f_2(x, y, z) = Ae^{-\frac{z}{a}} \frac{a^2}{a^2 + x'^2} \left( 3 - e^{-\frac{2z}{a}} \right) \cos^2 \left( \frac{\pi y'}{2 \cdot 3a} \right)$$

$$f_3(x, y, z) = A \frac{a^2}{\frac{a^2}{4} + x'^2 + y'^2} \left( e^{-\frac{2z}{a}} + \frac{a^2}{2(a + 2z)^2} \right)$$

### 3.4. COMOSAR E-Field Probe

The SAR measurement is conducted with the dissymmetric probe manufactured by SATIMO. The probe is specially designed and calibrated for use in liquid with high permittivity. The dissymmetric probe has special calibration in liquid at different frequency. SATIMO conducts the probe calibration in compliance with international and national standards (e.g. IEEE 1528, EN62209-1, IEC 62209, etc.) under ISO17025. The calibration data are in Appendix D.

### 3.5. Isotropic E-Field Probe Specification

<b>Model</b>	SSE5	
<b>Manufacture</b>	SATIMO	
<b>Frequency</b>	0.3GHz-3GHz Linearity:±0.09dB(300MHz-3GHz)	
<b>Dynamic Range</b>	0.01W/Kg-100W/Kg Linearity:±0.09dB	
<b>Dimensions</b>	Overall length:330mm Length of individual dipoles:4.5mm Maximum external diameter:8mm Probe Tip external diameter:5mm Distance between dipoles/ probe extremity:2.7mm	
<b>Application</b>	High precision dosimetric measurements in any exposure scenario (e.g., very strong gradient fields). Only probe which enables compliance testing for frequencies up to 3 GHz with precision of better 30%.	

### 3.6. Robot

<p>The COMOSAR system uses the KUKA robot from SATIMO SA (France).For the 6-axis controller COMOSAR system, the KUKA robot controller version from SATIMO is used.</p> <p>The XL robot series have many features that are important for our application:</p> <ul style="list-style-type: none"> <li><input type="checkbox"/> High precision (repeatability 0.02 mm)</li> <li><input type="checkbox"/> High reliability (industrial design)</li> <li><input type="checkbox"/> Jerk-free straight movements</li> <li><input type="checkbox"/> Low ELF interference (the closed metallic construction shields against motor control fields)</li> <li><input type="checkbox"/> 6-axis controller</li> </ul>	
---------------------------------------------------------------------------------------------------------------------------------------------------------------------------------------------------------------------------------------------------------------------------------------------------------------------------------------------------------------------------------------------------------------------------------------------------------------------------------------------------------------------------------------------------------------------------------------------------------------------------------------------------------------------------------------------------------	---------------------------------------------------------------------------------------

### 3.7. Video Positioning System

The video positioning system is used in OpenSAR to check the probe. Which is composed of a camera, LED, mirror and mechanical parts. The camera is piloted by the main computer with firewire link. During the process, the actual position of the probe tip with respect to the robot arm is measured, as well as the probe length and the horizontal probe offset. The software then corrects all movements, such that the robot coordinates are valid for the probe tip. The repeatability of this process is better than 0.1 mm. If a position has been taught with an aligned probe, the same position will be reached with another aligned probe within 0.1 mm, even if the other probe has different dimensions. During probe rotations, the probe tip will keep its actual position.

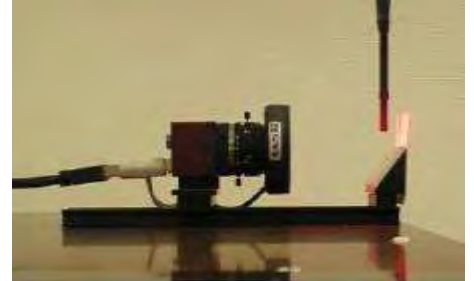

### 3.8. Device Holder

The COMOSAR device holder is designed to cope with different positions given in the standard. It has two scales for the device rotation (with respect to the body axis) and the device inclination (with respect to the line between the ear reference points). The rotation center for both scales is the ear reference point (EPR). Thus the device needs no repositioning when changing the angles. The COMOSAR device holder has been made out of low-loss POM material having the following dielectric parameters: relative permittivity  $\epsilon_r = 3$  and loss tangent  $\delta = 0.02$ . The amount of dielectric material has been reduced in the closest vicinity of the device, since measurements have suggested that the influence of the clamp on the test results could thus be lowered.

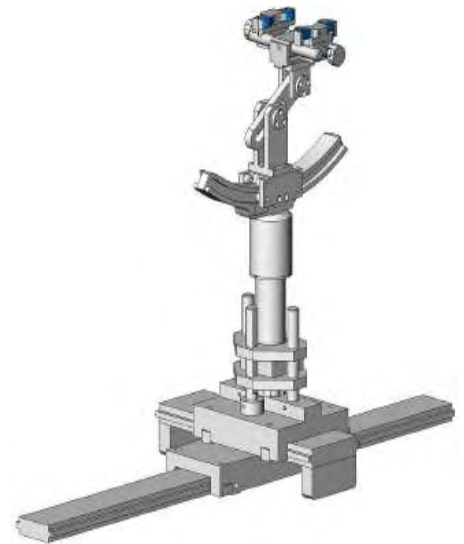

### 3.9. SAM Twin Phantom

The SAM twin phantom is a fiberglass shell phantom with 2mm shell thickness (except the ear region where shell thickness increases to 6mm). It has three measurement areas:

- Left head
- Right head
- Flat phantom

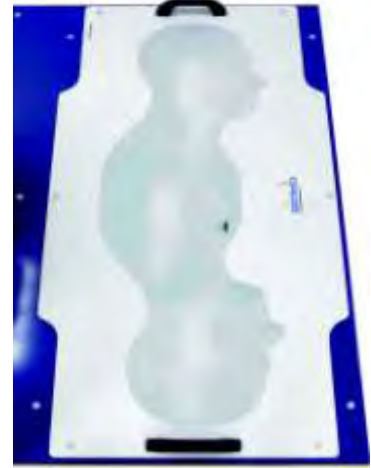

The bottom plate contains three pair of bolts for locking the device holder. The device holder positions are adjusted to the standard measurement positions in the three sections. A white cover is provided to tap the phantom during off-periods to prevent water evaporation and changes in the liquid parameters. On the phantom top, three reference markers are provided to identify the phantom position with respect to the robot.





## 4.2. Tissue Calibration Result

The dielectric parameters of the liquids were verified prior to the SAR evaluation using COMOSAR Dielectric Probe Kit and R&S Network Analyzer ZVL6 .

Tissue Stimulant Measurement for 835MHz							
Fr. (MHz)	Ch.	Dielectric Parameters ( $\pm 5\%$ )				Tissue Temp [°C]	Test time
		head		body			
		$\epsilon_r$ 41.5 39.425-43.575	$\delta$ [s/m] 0.90 0.855-0.945	$\epsilon_r$ 55.20 52.44-57.96	$\delta$ [s/m] 0.97 0.9215-1.0185		
835	Low	41.08	0.87	55.42	0.96	21	Oct.16,2014
835	Mid	41.22	0.91	55.10	0.98	21	Oct.16,2014
835	High	41.70	0.88	55.23	0.97	21	Oct.16,2014

Tissue Stimulant Measurement for 1900MHz							
Fr. (MHz)	Ch.	Dielectric Parameters ( $\pm 5\%$ )				Tissue Temp [°C]	Test time
		head		body			
		$\epsilon_r$ 40.00 38.00-42.00	$\delta$ [s/m] 1.40 1.33-1.47	$\epsilon_r$ 53.30 50.635-55.965	$\delta$ [s/m] 1.52 1.444-1.596		
1900	Low	40.19	1.40	53.58	1.53	21	Oct.16,2014
1900	Mid	40.46	1.42	53.21	1.49	21	Oct.16,2014
1900	High	40.71	1.37	53.08	1.50	21	Oct.16,2014

Tissue Stimulant Measurement for 2450MHz							
Fr. (MHz)	Ch.	Dielectric Parameters ( $\pm 5\%$ )				Tissue Temp [°C]	Test time
		body					
		$\epsilon_r$ 52.7 50.065-55.335		$\delta$ [s/m] 1.95 1.8525-2.0475			
2450	1	52.78		1.90		21	Oct.16,2014
2450	6	52.06		1.95		21	Oct.16,2014
2450	11	52.11		1.92		21	Oct.16,2014

### 4.3. Tissue Dielectric Parameters for Head and Body Phantoms

The head tissue dielectric parameters recommended by the IEEE SCC-34/SC-2 in P1528 have been incorporated in the following table. These head parameters are derived from planar layer models simulating the highest expected SAR for the dielectric properties and tissue thickness variations in a human head. Other head and body tissue parameters that have not been specified in P1528 are derived from the tissue dielectric parameters computed from the 4-Cole-Cole equations described in Reference [12] and extrapolated according to the head parameters specified in P1528.

Target Frequency (MHz)	head		body	
	$\epsilon_r$	$\sigma$ (S/m)	$\epsilon_r$	$\sigma$ (S/m)
300	45.3	0.87	58.2	0.92
450	43.5	0.87	56.7	0.94
<b>835</b>	<b>41.5</b>	<b>0.90</b>	<b>55.2</b>	<b>0.97</b>
900	41.5	0.97	55.0	1.05
915	41.5	1.01	55.0	1.06
1450	40.5	1.20	54.0	1.30
1610	40.3	1.29	53.8	1.40
<b>1800 – 2000</b>	<b>40.0</b>	<b>1.40</b>	<b>53.3</b>	<b>1.52</b>
<b>2450</b>	39.2	1.80	<b>52.7</b>	<b>1.95</b>
3000	38.5	2.40	52.0	2.73
5800	35.3	5.27	48.2	6.00

( $\epsilon_r$  = relative permittivity,  $\sigma$  = conductivity and  $\rho = 1000$  kg/m<sup>3</sup>)

## 5. SAR MEASUREMENT PROCEDURE

### 5.1. SAR System Validation Procedures

Each SATIMO system is equipped with one or more system validation kits. These units, together with the predefined measurement procedures within the SATIMO software, enable the user to conduct the system performance check and system validation. System kit includes a dipole, and dipole device holder.

The system check verifies that the system operates within its specifications. It's performed daily or before every SAR measurement. The system check uses normal SAR measurement in the flat section of the phantom with a matched dipole at a specified distance. The system validation setup is shown as below.

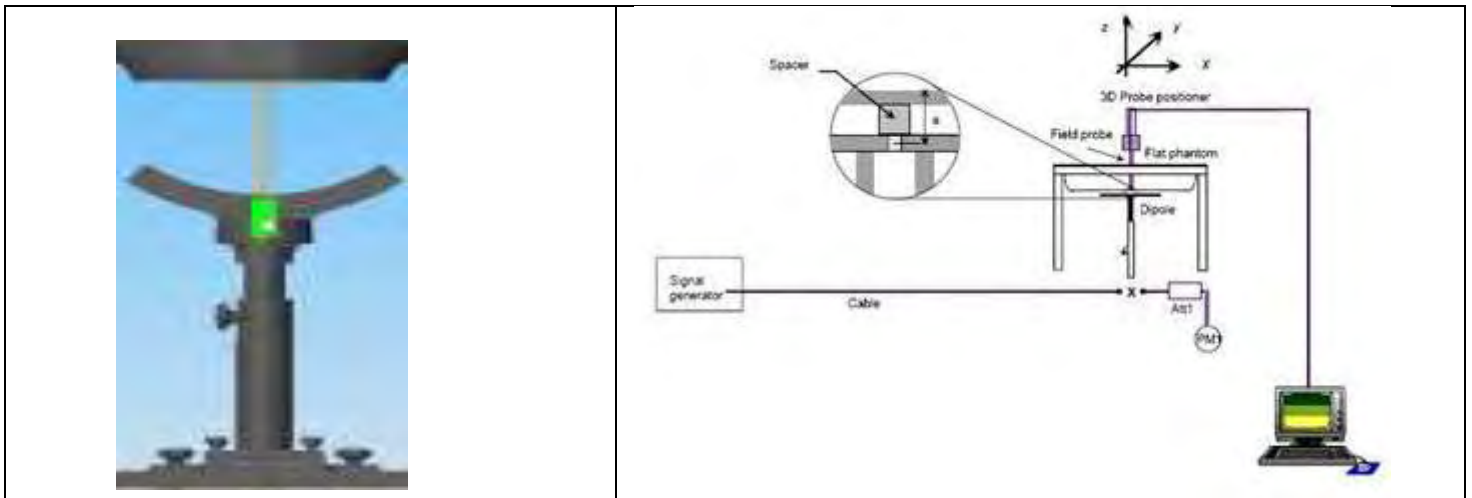

## 5.2. SAR System Validation

### 5.2.1. Validation Dipoles

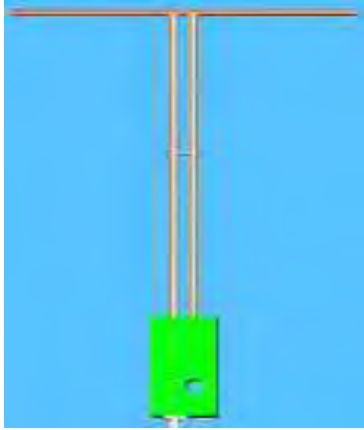

The dipoles used is based on the IEEE-1528 standard, and is complied with mechanical and electrical specifications in line with the requirements of both IEEE and FCC Supplement C. the table below provides details for the mechanical and electrical Specifications for the dipoles.

Frequency	L (mm)	h (mm)	d (mm)
835/900 MHz	149.0	83.3	3.6
1900MHz	68	39.5	3.6
2450MHz	51.5	30.4	3.6

### 5.2.2. Validation Result

System Performance Check at 835 MHz &1900MHz for Head								
Validation Kit: SN 46/11DIP 0G900-185 & SN 46/11DIP 1G900-187								
Frequency [MHz]	Target Value(W/Kg)		Reference Result ( $\pm 10\%$ )		Tested Value(W/Kg)		Tissue Temp. [°C]	Test time
	1g	10g	1g	10g	1g	10g		
835	10.70	6.72	9.63-11.77	6.048-7.392	10.66	6.73	21	Oct.16,2014
1900	39.65	20.24	35.685-43.615	18.216-22.264	40.32	20.36	21	Oct.16,2014

System Performance Check at 835 MHz &1900MHz & 2450MHz for Body								
Validation Kit: SN 46/11DIP 0G900-185 & SN 46/11DIP 1G900-187 &SN 46/11DIP 2G450-189								
Frequency [MHz]	Target Value(W/Kg)		Reference Result ( $\pm 10\%$ )		Tested Value(W/Kg)		Tissue Temp. [°C]	Test time
	1g	10g	1g	10g	1g	10g		
835	11.27	7.18	10.143-12.397	6.462-7.898	10.80	6.91	21	Oct.16,2014
1900	40.74	21.43	36.666-44.814	19.287-23.573	40.04	20.12	21	Oct.16,2014
2450	54.19	24.96	48.771-59.609	22.464-27.456	49.95	23.02	21	Oct.16,2014

## 6. EUT TEST POSITION

This EUT was tested in **Right Cheek, Right Titled, Left Cheek, Left Titled, Front Face and Rear Face.**

### 6.1. Define Two Imaginary Lines on the Handset

- (1)The vertical centerline passes through two points on the front side of the handset the midpoint of the width  $w_t$  of the handset at the level of the acoustic output, and the midpoint of the width  $w_b$  of the handset.
- (2)The horizontal line is perpendicular to the vertical centerline and passes through the center of the acoustic output. The horizontal line is also tangential to the face of the handset at point A.
- (3)The two lines intersect at point A. Note that for many handsets, point A coincides with the center of the acoustic output; however, the acoustic output may be located elsewhere on the horizontal line. Also note that the vertical centerline is not necessarily to the front face of the handset, especially for clamshell handsets, handsets with flip covers, and other irregularly shaped handsets.

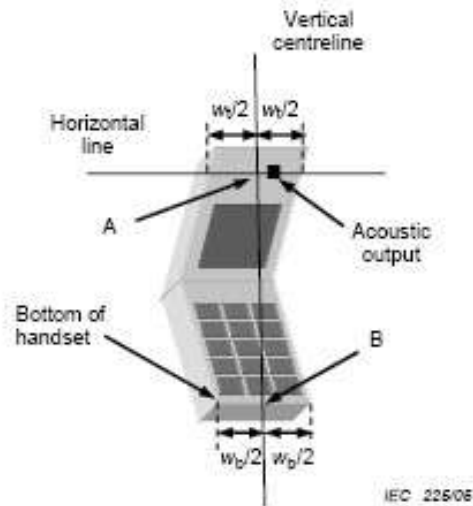
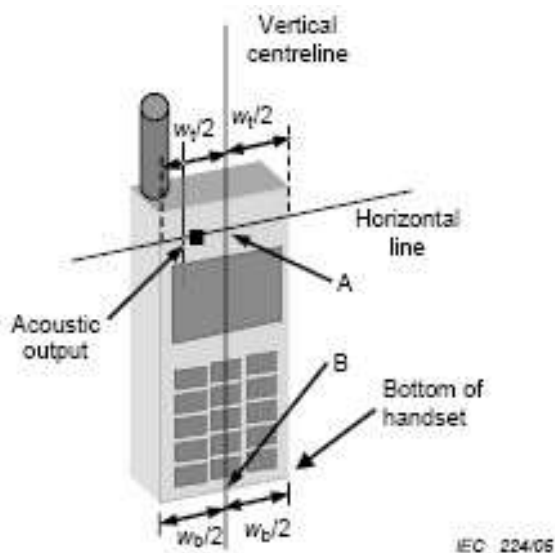

## 6.2. Cheek Position

- (1) To position the device with the vertical center line of the body of the device and the horizontal line crossing the center piece in a plane parallel to the sagittal plane of the phantom. While maintaining the device in this plane, align the vertical center line with the reference plane containing the ear and mouth reference point (M: Mouth, RE: Right Ear, and LE: Left Ear) and align the center of the ear piece with the line RE-LE.
- (2) To move the device towards the phantom with the ear piece aligned with the the line LE-RE until the phone touched the ear. While maintaining the device in the reference plane and maintaining the phone contact with ear, move the bottom of the phone until any point on the front side is in contact with the cheek of the phantom or until contact with the ear is lost



## 6.3. Title Position

- (1) To position the device in the “cheek” position described above.
- (2) While maintaining the device in the reference plane described above and pivoting against the ear, moves it outward away from the mouth by an angle of 15 degrees or until with the ear is lost.



#### 6.4. Body Worn Position

- (1) To position the EUT parallel to the phantom surface.
- (2) To adjust the EUT parallel to the flat phantom.
- (3) To adjust the distance between the EUT surface and the flat phantom to **10mm**. (Hotspot mode the distance of **10mm**).

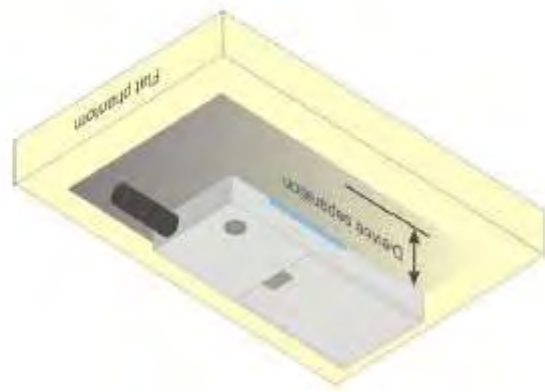



## 7. SAR EXPOSURE LIMITS

SAR assessments have been made in line with the requirements of IEEE-1528, FCC Supplement C, and comply with ANSI/IEEE C95.1-1992 "Uncontrolled Environments" limits. These limits apply to a location which is deemed as "Uncontrolled Environment" which can be described as a situation where the general public may be exposed to an RF source with no prior knowledge or control over their exposure.

### Limits for General Population/Uncontrolled Exposure (W/kg)

Type Exposure	Uncontrolled Environment Limit
Spatial Peak SAR (1g cube tissue for brain or body)	1.60 W/kg

## 8. TEST EQUIPMENT LIST

Equipment description	Manufacturer/ Model	Identification No.	Current calibration date	Next calibration date
SAR Probe	SATIMO	SN 22/12 EP159	01/12/2014	01/11/2015
TISSUE Probe	SATIMO	SN 45/11 OCPG45	11/14/2013	11/13/2015
Phantom	SATIMO	SN_4511_SAM90	Validated. No cal required.	Validated. No cal required.
Liquid	SATIMO	-	Validated. No cal required.	Validated. No cal required.
Comm Tester	R&S - CMU200	069Y7-158-13-712	02/17/2014	02/16/2015
Comm Tester	Agilent-8960	GB46310822	02/17/2014	02/16/2015
Multimeter	Keithley 2000	1188656	02/17/2014	02/16/2015
Dipole	SATIMO SID900	SN46/11 DIP 0G900-185	11/14/2013	11/13/2015
Dipole	SATIMO SID1900	SN46/11 DIP 1G900-187	11/14/2013	11/13/2015
Dipole	SATIMO SID2450	SN46/11 DIP 2G450-189	11/14/2013	11/13/2015
Signal Generator	Agilent-E4438C	MY44260051	02/23/2014	02/22/2015
Power Sensor	NRP-Z23	US38261498	02/17/2014	02/16/2015
SPECTRUM ANALYZER	Agilent/E4440A	MY44303916	10/22/2013	10/21/2014
Network Analyzer	Rhode & Schwarz ZVA	SN100132	02/17/2014	02/16/2015

Note: Per KDB 865664 Dipole SAR Validation Verification, AGC Lab has adopted 3 years calibration intervals. On annual basis, every measurement dipole has been evaluated and is in compliance with the following criteria:

1. There is no physical damage on the dipole;
2. System validation with specific dipole is within 10% of calibrated value;
3. Return-loss is within 20% of calibrated measurement;
4. Impedance is within 5Ω of calibrated measurement.

## 9. MEASUREMENT UNCERTAINTY

<b>SATIMO Uncertainty</b>									
Measurement uncertainty for 300MHz to 3GHz averaged over 1 gram / 10 gram.									
Error Description	Sec	Sec	Tol (±%)	Prob. Dist.	(Ci) 1g	(Ci) 10g	Std. Unc. (1g) (±%)	Std. Unc. (10g)(±%)	(Vi) Veff
<b>Measurement System</b>									
Probe Calibration	E.2.1	6	N	1	1	1	6	6	∞
Axial Isotropy	E.2.2	3	R	$\sqrt{3}$	$(1 - C_p)^{1/2}$	$(1 - C_p)^{1/2}$	1.22474	1.22474	∞
Hemispherical Isotropy	E.2.2	5	R	$\sqrt{3}$	$\sqrt{C_p}$	$\sqrt{C_p}$	2.04124	2.04124	∞
Boundary Effects	E.2.3	1	R	$\sqrt{3}$	1	1	0.57735	0.57735	∞
Linearity	E.2.4	5	R	$\sqrt{3}$	1	1	2.88675	2.88675	∞
System Detection Limits	E.2.5	1	R	$\sqrt{3}$	1	1	0.57735	0.57735	∞
Readout Electronics	E.2.6	0.5	N	1	1	1	0.5	0.5	∞
Response Time	E.2.7	0.2	R	$\sqrt{3}$	1	1	0.11547	0.11547	∞
Integration Time	E.2.8	2	R	$\sqrt{3}$	1	1	1.1547	1.1547	∞
RF Ambient Noise	E.6.1	3	R	$\sqrt{3}$	1	1	1.73205	1.73205	∞
Probe Positioner Mechanical Tolerance	E.6.2	2	R	$\sqrt{3}$	1	1	1.1547	1.1547	∞
Probe Positioning with Respect to Phantom Shell	E.6.3	1	R	$\sqrt{3}$	1	1	0.57735	0.57735	∞
Extrapolation, interpolation and Integration Algorithms for Max. SAR Evaluation	E.5.2	1.5	R	$\sqrt{3}$	1	1	0.86603	0.86603	∞
<b>Dipole</b>									
Device Positioning	8,E.4.2	1	N	$\sqrt{3}$	1	1	0.57735	0.57735	N-1
Power Drift	8.6.6.2	2	R	$\sqrt{3}$	1	1	1.1547	1.1547	∞
<b>Phantom and Tissue Parameters</b>									
Phantom Uncertainty	E.3.1	4	R	$\sqrt{3}$	1	1	2.3094	2.3094	∞
Liquid Conductivity (target)	E.3.2	5	R	$\sqrt{3}$	0.64	0.43	1.84752	1.2413	∞
Liquid Conductivity (meas.)	E.3.3	2.5	N	1	0.64	0.43	1.6	1.075	∞
Liquid Permittivity (target)	E.3.2	3	R	$\sqrt{3}$	0.6	0.49	1.03923	0.8487	∞
Liquid Permittivity (meas.)	E.3.3	2.5	N	1	0.6	0.49	1.5	1.225	M
Combined Standard Uncertainty			RSS				8.09272	7.9296	
Expanded Uncertainty (95%CONFIDENCE INTERVAL)			k				16.18544	15.8592	

## 10. CONDUCTED POWER MEASUREMENT

Mode	Frequency(MHz)	Avg. Burst Power(dBm)	Duty cycle Factor(dBm)	Frame Power(dBm)
Maximum Power <1>				
GSM 850	824.2	<b>31.89</b>	-9	22.89
	836.6	31.75	-9	22.75
	848.8	31.67	-9	22.67
GPRS 850 (1 Slot)	824.2	31.62	-9	22.62
	836.6	31.58	-9	22.58
	848.8	31.48	-9	22.48
GPRS 850 (2 Slot)	824.2	28.99	-6	22.99
	836.6	28.87	-6	22.87
	848.8	28.83	-6	22.83
GPRS 850 (3 Slot)	824.2	26.92	-4.26	22.66
	836.6	26.86	-4.26	22.6
	848.8	26.79	-4.26	22.53
GPRS 850 (4 Slot)	824.2	25.74	-3	22.74
	836.6	25.71	-3	22.71
	848.8	25.88	-3	22.88
PCS1900	1850.2	<b>28.65</b>	-9	19.65
	1880	28.59	-9	19.59
	1909.8	28.57	-9	19.57
GPRS1900 (1 Slot)	1850.2	28.54	-9	19.54
	1880	28.51	-9	19.51
	1909.8	28.43	-9	19.43
GPRS1900 (2 Slot)	1850.2	25.86	-6	19.86
	1880	25.77	-6	19.77
	1909.8	25.74	-6	19.74
GPRS1900 (3 Slot)	1850.2	23.92	-4.26	19.66
	1880	23.89	-4.26	19.63
	1909.8	23.83	-4.26	19.57
GPRS1900 (4 Slot)	1850.2	22.82	-3	19.82
	1880	22.87	-3	19.87
	1909.8	22.75	-3	19.75
Maximum Power <2>				
GSM850	824.2	31.56	-9	22.56
PCS1900	1850.2	28.16	-9	19.16

Note 1:

The Frame Power (Source-based time-averaged Power) is scaled the maximum burst average power based on time slots. The calculated methods are show as following:

Frame Power = Max burst power (1 Up Slot) – 9 dB

Frame Power = Max burst power (2 Up Slot) – 6 dB

Frame Power = Max burst power (3 Up Slot) – 4.26 dB

Frame Power = Max burst power (4 Up Slot) – 3 dB

**UMTS BAND II**

<b>Mode</b>	<b>Frequency (MHz)</b>	<b>Avg. Burst Power (dBm)</b>
WCDMA 1900 RMC	1852.4	<b>22.91</b>
	1880	22.86
	1907.6	22.82
WCDMA 1900 AMR	1852.4	22.36
	1880	22.38
	1907.6	22.26
HSDPA Subtest 1	1852.4	22.32
	1880	22.27
	1907.6	22.26
HSDPA Subtest 2	1852.4	22.24
	1880	22.36
	1907.6	22.17
HSDPA Subtest 3	1852.4	22.13
	1880	22.08
	1907.6	22.14
HSDPA Subtest 4	1852.4	22.16
	1880	22.15
	1907.6	22.18
HSUPA Subtest 1	1852.4	22.15
	1880	22.25
	1907.6	22.21
HSUPA Subtest 2	1852.4	22.26
	1880	22.33
	1907.6	22.06
HSUPA Subtest 3	1852.4	22.15
	1880	22.24
	1907.6	22.26
HSUPA Subtest 4	1852.4	22.33
	1880	22.42
	1907.6	22.14
HSUPA Subtest 5	1852.4	22.09
	1880	22.15
	1907.6	22.18

**UMTS BAND V**

<b>Mode</b>	<b>Frequency (MHz)</b>	<b>Avg. Burst Power (dBm)</b>
WCDMA 850 RMC	826.4	<b>22.86</b>
	836.6	22.82
	846.6	22.77
WCDMA 850 AMR	826.4	22.13
	836.6	22.16
	846.6	22.25
HSDPA Subtest 1	826.4	22.27
	836.6	22.15
	846.6	22.12
HSDPA Subtest 2	826.4	22.26
	836.6	22.15
	846.6	22.11
HSDPA Subtest 3	826.4	22.28
	836.6	22.24
	846.6	22.26
HSDPA Subtest 4	826.4	22.33
	836.6	22.31
	846.6	22.28
HSUPA Subtest 1	826.4	22.16
	836.6	22.14
	846.6	22.11
HSUPA Subtest 2	826.4	22.18
	836.6	22.14
	846.6	22.29
HSUPA Subtest 3	826.4	22.32
	836.6	22.27
	846.6	22.21
HSUPA Subtest 4	826.4	22.16
	836.6	22.12
	846.6	22.23
HSUPA Subtest 5	826.4	22.29
	836.6	22.24
	846.6	22.21

**WIFI**

Mode	Data Rate (Mbps)	Channel	Frequency(MHz)	Avg. Burst Power(dBm)
802.11b	1	01	2412	<b>9.86</b>
		06	2437	9.69
		11	2462	9.54
802.11g	6	01	2412	7.88
		06	2437	7.48
		11	2462	7.39
802.11n(20)	6.5	01	2412	7.66
		06	2437	7.74
		11	2462	7.45
802.11n(40)	13.5	03	2422	4.79
		06	2437	4.7
		09	2452	4.54

**Bluetooth\_V3.0**

Modulation	Channel	Frequency(MHz)	Average Power (dBm)
GFSK	0	2402	-1.5
	39	2441	-0.5
	78	2480	<b>0.03</b>
$\pi$ /4-DQPSK	0	2402	-2.18
	39	2441	-1.23
	78	2480	-0.79
8-DPSK	0	2402	-2.17
	39	2441	-1.21
	78	2480	-0.79

According to 3GPP 25.101 sub-clause 6.2.2 , the maximum output power is allowed to be reduced by following the table.

Table 6.1aA: UE maximum output power with HS-DPCCH and E-DCH

UE Transmit Channel Configuration	CM(db)	MPR(db)
For all combinations of ,DPDCH,DPCCH HS-DPDCH,E-DPDCH and E-DPCCH	$0 \leq CM \leq 3.5$	$MAX(CM-1,0)$
Note: CM=1 for $\beta_c/\beta_d=12/15$ , $\beta_{hs}/\beta_c=24/15$ .For all other combinations of DPDCH, DPCCH, HS-DPCCH, E-DPDCH and E-DPCCH the MPR is based on the relative CM difference.		

The device supports MPR to solve linearity issues (ACLR or SEM) due to the higher peak-to average ratios (PAR) of the HSUPA signal. This prevents saturating the full range of the TX DAC inside of device and provides a reduced power output to the RF transceiver chip according to the Cubic Metric (a function of the combinations of DPDCH, DPCCH, HS-DPCCH, E-DPDCH and E-DPCCH).

When E-DPDCH channels are present the beta gains on those channels are reduced firsts to try to get the power under the allowed limit. If the beta gains are lowered as far as possible, then a hard limiting is applied at the maximum allowed level.

The SW currently recalculates the cubic metric every time the beta gains on the E-DPDCH are reduced. The cubic metric will likely get lower each time this is done .However, there is no reported reduction of maximum output power in the HSUPA mode since the device also provides a compensation for the power back-off by increasing the gain of TX\_AGC in the transceiver (PA) device.

The end effect is that the DUT output power is identical to the case where there is no MPR in the device.



## 11. TEST RESULTS

### 11.1. SAR Test Results Summary

#### 11.1.1. Test position and configuration

Head SAR was performed with the device configured in the positions according to IEEE1528, and Body SAR was performed with the device 10mm from the phantom; Body SAR was also performed with the headset attached and without. The overall device length and width(11.7cm×6.3cm) are >9cm×5cm, Hotspot mode with a test separation distance of 10mm.

#### 11.1.2. Operation Mode

- According to KDB 447498 D01 v05r01 ,for each exposure position, if the highest 1-g SAR is  $\leq 0.8$  W/kg, testing for low and high channel is optional.
- Per KDB 865664 D01 v01r01,for each frequency band, if the measured SAR is  $\geq 0.8$ W/Kg, testing for repeated SAR measurement is required , that the highest measured SAR is only to be tested. When the SAR results are near the limit, the following procedures are required for each device to verify these types of SAR measurement related variation concerns by repeating the highest measured SAR configuration in each frequency band.
  - (1) When the original highest measured SAR is  $\geq 0.8$ W/Kg, repeat that measurement once.
  - (2) Perform a second repeated measurement only if the ratio of largest to smallest SAR for the original and first repeated measurements is  $> 1.20$  or when the original or repeated measurement is  $\geq 1.45$  W/Kg.
  - (3) Perform a third repeated measurement only if the original, first and second repeated measurement is  $\geq 1.5$  W/Kg and ratio of largest to smallest SAR for the original, first and second measurement is  $\geq 1.20$ .
- Body-worn exposure conditions are intended to voice call operations, therefore GSM voice call mode is selected to be test.
- According to KDB 648474 D04 v01r01,when the reported SAR for a body-worn accessory measured without a headset connected to the handset is  $\leq 1.2$ W/Kg, SAR testing with a headset connected is not required.
- According to 941225 D06, when the overall device length and width are >9cm×5cm, Hotspot mode with a test separation distance of 10mm. For device with form factors smaller than 9cm×5cm, Hotspot mode with a test separation distance of 5mm. Body SAR was also performed with the headset attached and without.
- According to 248227 D01, SAR is not required for 802.11g channels when the maximum average output power is less than 1/4dB higher than measured on the corresponding 802.11b channels.
- Maximum Scaling SAR in order to calculate the Maximum SAR values to test under the standard Peak Power, Calculation method is as follows:  
Maximum Scaling SAR =tested SAR (Max.) × [maximum turn-up power (mw)/ maximum measurement output power(mw) ]

### 11.1.3. Test Result

SAR MEASUREMENT									
Ambient Temperature (°C) : 21 ± 2					Relative Humidity (%): 55				
Liquid Temperature (°C) : 21 ± 2					Depth of Liquid (cm):>15				
Product: mobile phone									
Test Mode: GSM850 with GMSK modulation									
Position	Mode	Ch.	Fr. (MHz)	Power Drift (<±5%)	SAR (1g) (W/kg)	Max. Turn-up Power (dBm)	Meas. output Power (dBm)	Scaled SAR (W/Kg)	Limit W/kg
<b>SIM 1 Card</b>									
Left Cheek	voice	190	836.6	0.26	0.308	32.00	31.75	0.326	1.6
Left Tilt	voice	190	836.6	0.14	0.167	32.00	31.75	0.177	1.6
Right Cheek	voice	190	836.6	1.02	<b>0.378</b>	32.00	31.75	<b>0.400</b>	1.6
Right Tilt	voice	190	836.6	0.35	0.205	32.00	31.75	0.217	1.6
Body back	voice	128	824.2	0.26	0.716	32.00	31.89	0.734	1.6
Body back	voice	190	836.6	0.96	0.996	32.00	31.75	1.055	1.6
Body back	voice	251	848.8	1.02	<b>1.193</b>	32.00	31.67	<b>1.287</b>	1.6
Body front	voice	190	836.6	0.36	0.333	32.00	31.75	0.353	1.6
<b>SIM 2 Card</b>									
Right Cheek	voice	190	836.6	0.25	0.360	32.00	31.75	0.381	1.6

Note:

- When the 1-g SAR is ≤ 0.8 W/kg, testing for low and high channel is optional. Refer to KDB 941225.
- The test separation for body is 10mm of all above table.
- The worst mode is voice mode.

SAR MEASUREMENT									
Ambient Temperature (°C) : 21 ± 2					Relative Humidity (%): 55				
Liquid Temperature (°C) : 21 ± 2					Depth of Liquid (cm):>15				
Product: mobile phone									
Test Mode: PCS1900 with GMSK modulation									
Position	Mode	Ch.	Fr. (MHz)	Power Drift (<±5%)	SAR (1g) (W/kg)	Max. Turn-up Power (dBm)	Meas. output Power (dBm)	Scaled SAR (W/Kg)	Limit W/kg
<b>SIM 1 Card</b>									
Left Cheek	voice	661	1880.0	0.58	0.154	29.00	28.59	0.169	1.6
Left Tilt	voice	661	1880.0	-1.26	0.022	29.00	28.59	0.024	1.6
Right Cheek	voice	661	1880.0	0.35	<b>0.248</b>	29.00	28.59	<b>0.273</b>	1.6
Right Tilt	voice	661	1880.0	-0.25	0.028	29.00	28.59	0.031	1.6
Body back	voice	661	1880.0	-0.96	<b>0.285</b>	29.00	28.59	<b>0.313</b>	1.6
Body front	voice	661	1880.0	0.45	0.123	29.00	28.59	0.135	1.6
<b>SIM 2 Card</b>									
Right Cheek	voice	661	1880.0	0.14	0.230	29.00	28.59	0.253	1.6

Note:

- When the 1-g SAR is ≤ 0.8 W/kg, testing for low and high channel is optional. Refer to KDB 941225.
- The test separation for body is 10mm of all above table.
- The worst mode is voice mode.

SAR MEASUREMENT									
Ambient Temperature (°C) : 21 ± 2					Relative Humidity (%): 55				
Liquid Temperature (°C) : 21 ± 2					Depth of Liquid (cm):>15				
Product: mobile phone									
Test Mode: WCDMA Band II with QPSK modulation									
Position	Mode	Ch.	Fr. (MHz)	Power Drift (<±5%)	SAR (1g) (W/kg)	Max. Turn-up Power (dBm)	Meas. output Power (dBm)	Scaled SAR (W/Kg)	Limit W/kg
<b>SIM 1 Card</b>									
Left Cheek	RMC 12.2kbps	9400	1880	-0.23	0.492	23.00	22.86	0.508	1.6
Left Tilt	RMC 12.2kbps	9400	1880	-0.14	0.068	23.00	22.86	0.070	1.6
Right Cheek	RMC 12.2kbps	9400	1880	0.25	<b>0.726</b>	23.00	22.86	<b>0.750</b>	1.6
Right Tilt	RMC 12.2kbps	9400	1880	-0.96	0.082	23.00	22.86	0.085	1.6
Body back	RMC 12.2kbps	9262	1852.4	0.22	0.554	23.00	22.91	0.566	1.6
Body back	RMC 12.2kbps	9400	1880	0.17	0.816	23.00	22.86	0.843	1.6
Body back	RMC 12.2kbps	9538	1907.6	-0.69	<b>0.908</b>	23.00	22.82	<b>0.946</b>	1.6
Body front	RMC 12.2kbps	9400	1880	0.52	0.395	23.00	22.86	0.408	1.6

Note:

- When the 1-g SAR is ≤ 0.8 W/kg, testing for low and high channel is optional. Refer to KDB 941225.
- The test separation for body is 10mm of all above table.
- The worst mode is voice mode.

SAR MEASUREMENT									
Ambient Temperature (°C) : 21 ± 2					Relative Humidity (%): 55				
Liquid Temperature (°C) : 21 ± 2					Depth of Liquid (cm):>15				
Product: mobile phone									
Test Mode: WCDMA Band V with QPSK modulation									
Position	Mode	Ch.	Fr. (MHz)	Power Drift (<±5%)	SAR (1g) (W/kg)	Max. Turn-up Power (dBm)	Meas. output Power (dBm)	Scaled SAR (W/Kg)	Limit W/kg
<b>SIM 1 Card</b>									
Left Cheek	RMC 12.2kbps	4183	836.6	0.36	0.594	23.00	22.82	0.619	1.6
Left Tilt	RMC 12.2kbps	4183	836.6	0.25	0.097	23.00	22.82	0.101	1.6
Right Cheek	RMC 12.2kbps	4183	836.6	-0.31	<b>0.770</b>	23.00	22.82	<b>0.803</b>	1.6
Right Tilt	RMC 12.2kbps	4183	836.6	-1.02	0.120	23.00	22.82	0.125	1.6
Body back	RMC 12.2kbps	4132	826.4	0.39	0.600	23.00	22.86	0.620	1.6
Body back	RMC 12.2kbps	4183	836.6	-0.25	0.924	23.00	22.82	0.963	1.6
Body back	RMC 12.2kbps	4233	846.6	-0.36	<b>1.024</b>	23.00	22.77	<b>1.080</b>	1.6
Body front	RMC 12.2kbps	4183	836.6	0.25	0.421	23.00	22.82	0.439	1.6

Note:

- When the 1-g SAR is ≤ 0.8 W/kg, testing for low and high channel is optional. Refer to KDB 941225.
- The test separation for body is 10mm of all above table.
- The worst mode is voice mode.

SAR MEASUREMENT									
Ambient Temperature (°C) : 21 ± 2					Relative Humidity (%): 55				
Liquid Temperature (°C) : 21 ± 2					Depth of Liquid (cm):>15				
Product: mobile phone									
Test Mode: Hotspot									
Position	Mode	Ch.	Fr. (MHz)	Power Drift (<±5%)	SAR (1g) (W/kg)	Max. Turn-up Power (dBm)	Meas. output Power (dBm)	Scaled SAR (W/Kg)	Limit W/kg
<b>SIM 1 Card</b>									
Body back	DTS	6	2437	-0.23	<b>0.242</b>	10.00	9.69	<b>0.260</b>	1.6
Body front	DTS	6	2437	0.14	0.162	10.00	9.69	0.174	1.6

Note:

- According to KDB248227, SAR is not required for 802.11n HT20/HT40 channels when the maximum average output power is less than 1/4 dB higher than that measured on the corresponding 802.11a/b channels.
- All of above "DTS" means data transmitters.
- The test separation of all above table for body part is 10mm.

Repeated SAR								
Ambient Temperature (°C) : 21 ± 2					Relative Humidity (%): 55			
Liquid Temperature (°C) : 21 ± 2					Depth of Liquid (cm):>15			
Product: mobile phone								
Test Mode: GSM850 with GMSK modulation & WCDMA Band II & WCDMA Band V with QPSK modulation								
Position	Mode	Ch.	Fr. (MHz)	Power Drift (<±5%)	Once SAR (1g) (W/kg)	Twice SAR (1g) (W/kg)	Third SAR (1g) (W/kg)	Limit W/kg
Body back	voice	251	848.8	1.12	1.191	--	--	1.6
Body back	RMC 12.2kbps	9538	1907.6	-0.65	0.905	--	--	1.6
Body back	RMC 12.2kbps	4233	846.6	-0.35	1.022	--	--	1.6

**Simultaneous Multi-band Transmission Evaluation:**  
**Application Simultaneous Transmission information:**

		Head	Body-worn	Hotspot	
1	GSM(voice)+WLAN 2.4GHz (data)	Yes	Yes	-	-
2	WCDMA(voice)+WLAN 2.4GHz (data)	Yes	Yes	-	-
3	GSM(voice)+Bluetooth(data)	Yes	Yes	-	-
4	WCDMA(voice)+Bluetooth(data)	Yes	Yes	-	-
5	GSM(voice)+WLAN 2.4GHz (data)	-	Yes	Yes	2.4GHz Hotspot
6	WCDMA(voice)+WLAN 2.4GHz (data)	-	Yes	Yes	2.4GHz Hotspot

**NOTE:**

- WLAN and BT share the same antenna, and cannot transmit simultaneously.
- Simultaneous with every transmitter must be the same test position.
- Based upon KDB 447498 D01 v05, BT SAR is excluded as below table.
- Based upon KDB 447498 D01 v05, for handsets the test separation distance is determined by the smallest distance between the outer surface of the device and the user; which is 0mm for head SAR AND 10mm for body-worn SAR.
- If the test separation distance is <5mm, 5mm is used for excluded SAR calculation.
- For minimum test separation distance  $\cong 50\text{mm}$ , Bluetooth standalone SAR is excluded according to  $[(\text{max. power of channel, including tune-up tolerance, mW}) / (\text{min. test separation distance, mm}) \cdot \sqrt{f \text{ (GHz)}} / x] \cong 3.0$  for 1-g SAR and  $\cong 7.5$  for 10-g extremity SAR
- KDB 447498 / 4.3.2 (2) when standalone SAR test exclusion applies to an antenna that transmits simultaneously with other antennas, the standalone SAR must be estimated according to following to determine simultaneous transmission SAR test exclusion:
  - $(\text{max. power of channel, including tune-up tolerance, mW}) / (\text{min. test separation distance, mm}) \cdot \sqrt{f \text{ (GHz)}} / x$  W/kg for test separation distances  $\leq 50$  mm; Where  $x = 7.5$  for 1-g SAR, and  $x = 18.75$  for 10-g SAR.
  - 0.4W/Kg for 1-g SAR and 1.0W/Kg for 10-g SAR, when the separation distance is >50mm.

Estimated SAR		Maximum Average Power		Antenna to user (mm)	SAR exclusion threshold (mW)	SAR testing required (Yes/No)	Head (0mm gap)	Body (10mm gap)
		dBm	mW					
BT	Head	1	1.259	0	10	NO	0.053 W/kg	0.026 W/kg
	Body			10				
WIFI	Head	10	10	0	10	NO	0.414 W/kg	0.207 W/kg
	Body			10				

**Maximum test results (WWAN) with BT and WIFI/ HOTSPOT SAR:**

**BT:** Head (0 cm gap): 0.053W/kg and Body (1.0cm gap): 0.026 W/kg  
**WIFI:** Head (0 cm gap): 0. 414 W/kg and Body (1.0cm gap): 0. 207 W/kg  
**HOTSPOT:** Body (1.0 cm gap): 0.260W/kg

**WIFI**

Position	Max. WWAN SAR (W/Kg)	Max. WLAN SAR (W/Kg)	SAR Summation	Limit (W/kg)	SPLSR $\leq 0.04$ (Yes/No)
<b>GSM850+WLAN 2.4G-DTS</b>					
Left Cheek	0.326	0.414	0.740	1.6	No
Left Tilt	0.177	0.414	0.591	1.6	No
Right Cheek	0.400	0.414	<b>0.814</b>	1.6	No
Right Tilt	0.217	0.414	0.631	1.6	No
Body back	1.287	0.207	<b>1.494</b>	1.6	No
Body front	0.353	0.207	0.560	1.6	No
<b>PCS1900+WLAN 2.4G-DTS</b>					
Left Cheek	0.169	0.414	0.583	1.6	No
Left Tilt	0.024	0.414	0.438	1.6	No
Right Cheek	0.273	0.414	<b>0.687</b>	1.6	No
Right Tilt	0.031	0.414	0.445	1.6	No
Body back	0.313	0.207	<b>0.520</b>	1.6	No
Body front	0.135	0.207	0.342	1.6	No
<b>WCDMA Band II+WLAN 2.4G-DTS</b>					
Left Cheek	0.508	0.414	0.922	1.6	No
Left Tilt	0.070	0.414	0.484	1.6	No
Right Cheek	0.750	0.414	<b>1.164</b>	1.6	No
Right Tilt	0.085	0.414	0.499	1.6	No
Body back	0.946	0.207	<b>1.153</b>	1.6	No
Body front	0.408	0.207	0.615	1.6	No
<b>WCDMA Band V+WLAN 2.4G-DTS</b>					
Left Cheek	0.619	0.414	1.033	1.6	No
Left Tilt	0.101	0.414	0.515	1.6	No
Right Cheek	0.803	0.414	<b>1.217</b>	1.6	No
Right Tilt	0.125	0.414	0.539	1.6	No
Body back	1.080	0.207	<b>1.287</b>	1.6	No
Body front	0.439	0.207	0.646	1.6	No

**Note:**

- According to KDB 447498 D01 General RF Exposure Guidance v05, when the simultaneous transmission SAR is less than 1.6 W/Kg, SPLSR assessment is not required.
- SPLSR mean is “The SAR to Peak Location Separation Ratio “

**Hotspot**

Position	Max. WWAN SAR (W/Kg)	Max. Hotspot SAR (W/Kg)	SAR Summation	Limit (W/kg)	SPLSR $\leq 0.04$ (Yes/No)
<b>GSM850+Hotspot 2.4G-DTS</b>					
Body back	1.287	0.260	<b>1.547</b>	1.6	No
Body front	0.353	0.174	0.527	1.6	No
<b>PCS1900+Hotspot 2.4G-DTS</b>					
Body back	0.313	0.260	<b>0.573</b>	1.6	No
Body front	0.135	0.174	0.309	1.6	No
<b>WCDMA Band II+ Hotspot 2.4G-DTS</b>					
Body back	0.946	0.260	<b>1.206</b>	1.6	No
Body front	0.408	0.174	0.582	1.6	No
<b>WCDMA Band V+ Hotspot 2.4G-DTS</b>					
Body back	1.080	0.260	<b>1.340</b>	1.6	No
Body front	0.439	0.174	0.613	1.6	No

**Note:**

- According to KDB 447498 D01 General RF Exposure Guidance v05, when the simultaneous transmission SAR is less than 1.6 W/Kg, SPLSR assessment is not required.
- SPLSR mean is "The SAR to Peak Location Separation Ratio "

**BT**

Position	Max. WWAN SAR (W/Kg)	Estimated SAR (W/Kg)	SAR Summation	Limit (W/kg)	SPLSR $\leq 0.04$ (Yes/No)
<b>GSM850+Bluetooth-DSS</b>					
Left Cheek	0.326	0.053	0.379	1.6	No
Left Tilt	0.177	0.053	0.230	1.6	No
Right Cheek	0.400	0.053	<b>0.453</b>	1.6	No
Right Tilt	0.217	0.053	0.270	1.6	No
Body back	1.287	0.026	<b>1.313</b>	1.6	No
Body front	0.353	0.026	0.379	1.6	No
<b>PCS1900+ Bluetooth-DSS</b>					
Left Cheek	0.169	0.053	0.222	1.6	No
Left Tilt	0.024	0.053	0.077	1.6	No
Right Cheek	0.273	0.053	<b>0.326</b>	1.6	No
Right Tilt	0.031	0.053	0.084	1.6	No
Body back	0.313	0.026	<b>0.339</b>	1.6	No
Body front	0.135	0.026	0.161	1.6	No
<b>WCDMA Band II+ Bluetooth-DSS</b>					
Left Cheek	0.508	0.053	0.561	1.6	No
Left Tilt	0.070	0.053	0.123	1.6	No
Right Cheek	0.750	0.053	<b>0.803</b>	1.6	No
Right Tilt	0.085	0.053	0.138	1.6	No
Body back	0.946	0.026	<b>0.972</b>	1.6	No
Body front	0.408	0.026	0.434	1.6	No
<b>WCDMA Band V+ Bluetooth-DSS</b>					
Left Cheek	0.619	0.053	0.672	1.6	No
Left Tilt	0.101	0.053	0.154	1.6	No
Right Cheek	0.803	0.053	<b>0.856</b>	1.6	No
Right Tilt	0.125	0.053	0.178	1.6	No
Body back	1.080	0.026	<b>1.106</b>	1.6	No
Body front	0.439	0.026	0.465	1.6	No

**Note:**

- According to KDB 447498 D01 General RF Exposure Guidance v05, when the Sum of the simultaneous transmission SAR is lesser than 1.6 W/Kg, SPLSR assessment is not required.
- SPLSR mean is "The SAR to Peak Location Ratio " .



## APPENDIX A. SAR SYSTEM VALIDATION DATA

Test Laboratory: AGC Lab

Date: Oct.16,2014

System Check Head 835 MHz

DUT: Dipole 900 MHz Type: SID 900

Communication System CW; Communication System Band: D835 (835.0 MHz); Duty Cycle: 1:1; Conv.F=5.27

Frequency: 835 MHz; Medium parameters used:  $f = 835$  MHz;  $\sigma=0.91$  mho/m;  $\epsilon_r = 41.22$ ;  $\rho = 1000$  kg/m<sup>3</sup> ;

Phantom section: Flat Section; Input Power=10dBm

Ambient temperature (°C): 21, Liquid temperature (°C): 21

SATIMO Configuration:

- Probe: SSE5; Calibrated: 01/12/2014; Serial No.:SN 22/12 EP159
- Sensor-Surface: 4mm (Mechanical Surface Detection)
- Phantom: Flat Phantom; Type: Elliptical Phantom
- Measurement SW: OpenSAR V4\_02\_01

Configuration/System Check GSM 835 Head/Area Scan: Measurement grid: dx=8mm, dy=8mm

Configuration/System Check GSM 835 Head/Zoom Scan: Measurement grid: dx=8mm,dy=8mm, dz=5mm

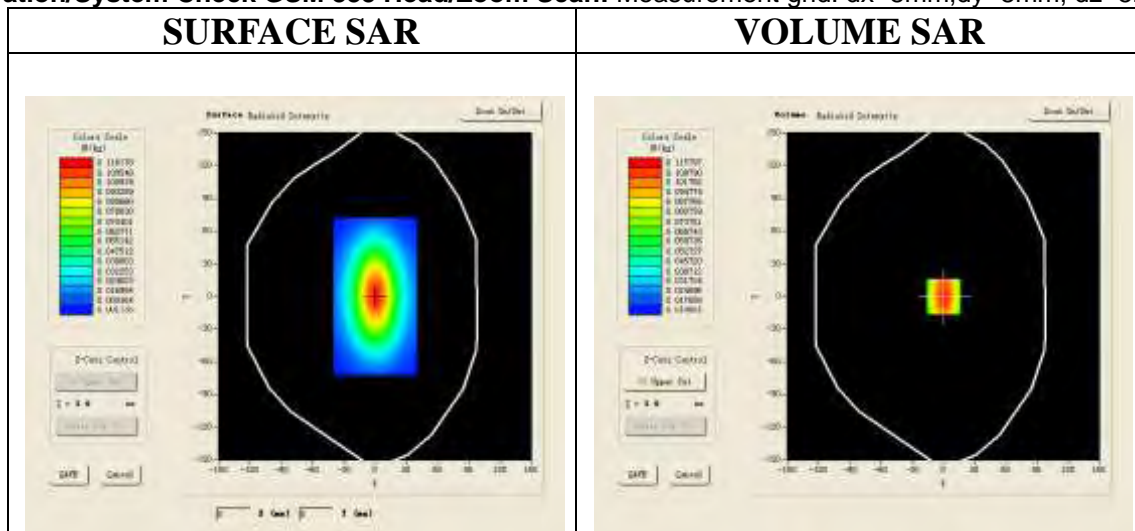

**Maximum location: X=0.00, Y=0.00**

<b>SAR 10g (W/Kg)</b>	0.067321
<b>SAR 1g (W/Kg)</b>	0.106566

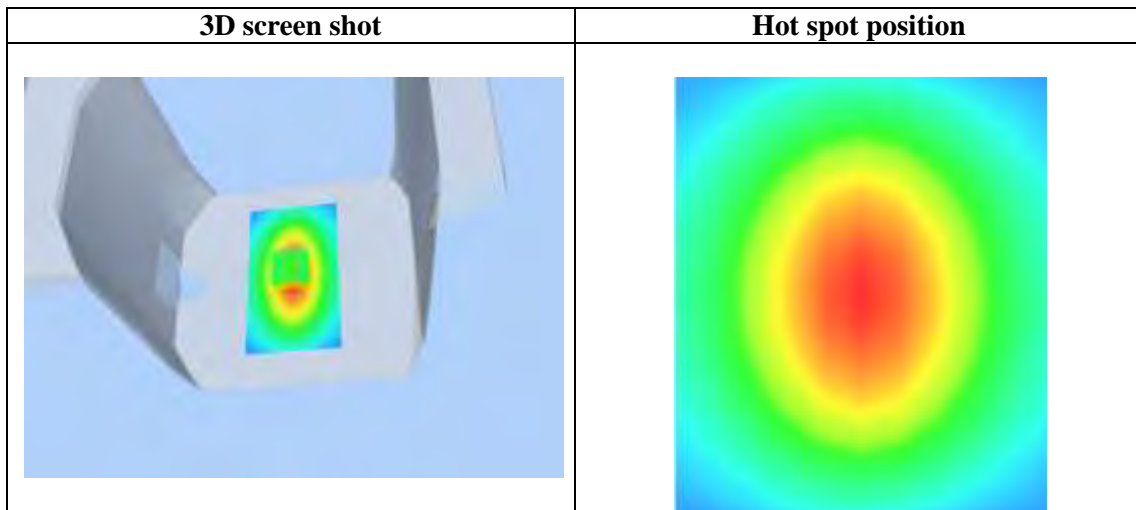
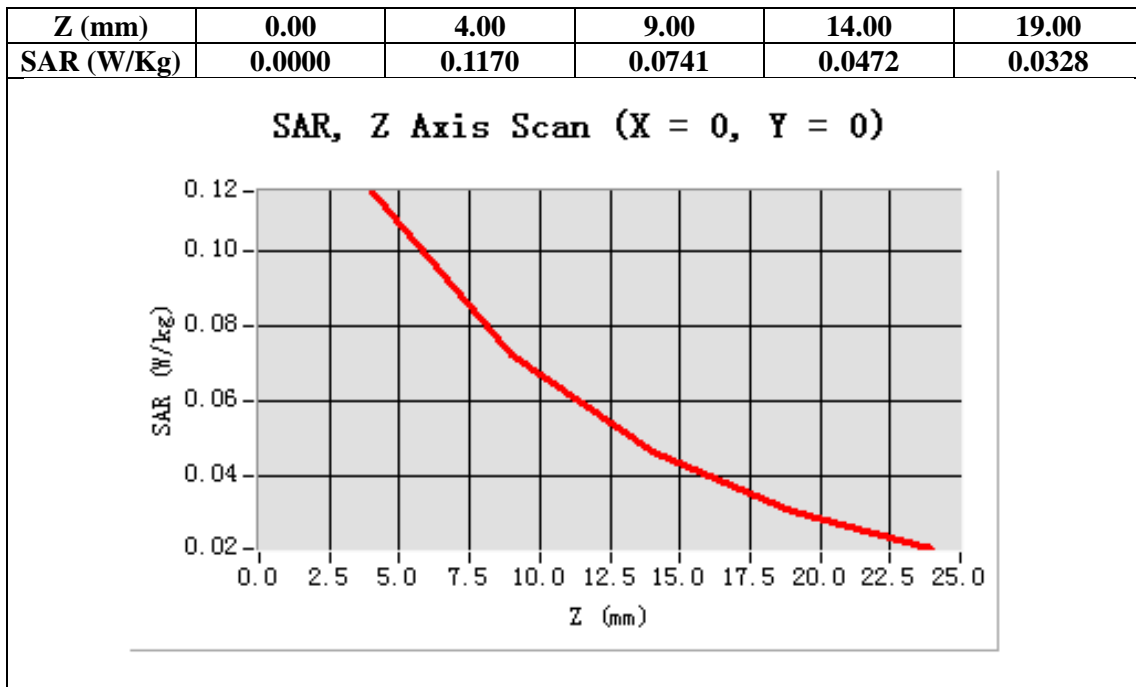

**Test Laboratory: AGC Lab**  
**System Check Body 835 MHz**  
**DUT: Dipole 900 MHz Type: SID 900**

**Date: Oct.16,2014**

Communication System CW; Communication System Band: D835 (835.0 MHz); Duty Cycle: 1:1; Conv.F=5.48  
Frequency: 835 MHz; Medium parameters used:  $f = 835 \text{ MHz}$ ;  $\sigma=0.98 \text{ mho/m}$ ;  $\epsilon_r = 55.10$ ;  $\rho= 1000 \text{ kg/m}^3$  ;  
Phantom section: Flat Section; Input Power=10dBm  
Ambient temperature ( $^{\circ}\text{C}$ ): 21, Liquid temperature ( $^{\circ}\text{C}$ ): 21

SATIMO Configuration:

- Probe: SSE5; Calibrated: 01/12/2014; Serial No.:SN 22/12 EP159
- Sensor-Surface: 4mm (Mechanical Surface Detection)
- Phantom: Flat Phantom; Type: Elliptical Phantom
- Measurement SW: OpenSAR V4\_02\_01

**Configuration/System Check GSM 835 Body/Area Scan:** Measurement grid: dx=8mm, dy=8mm

**Configuration/System Check GSM 835 Body/Zoom Scan:** Measurement grid: dx=8mm,dy=8mm, dz=5mm

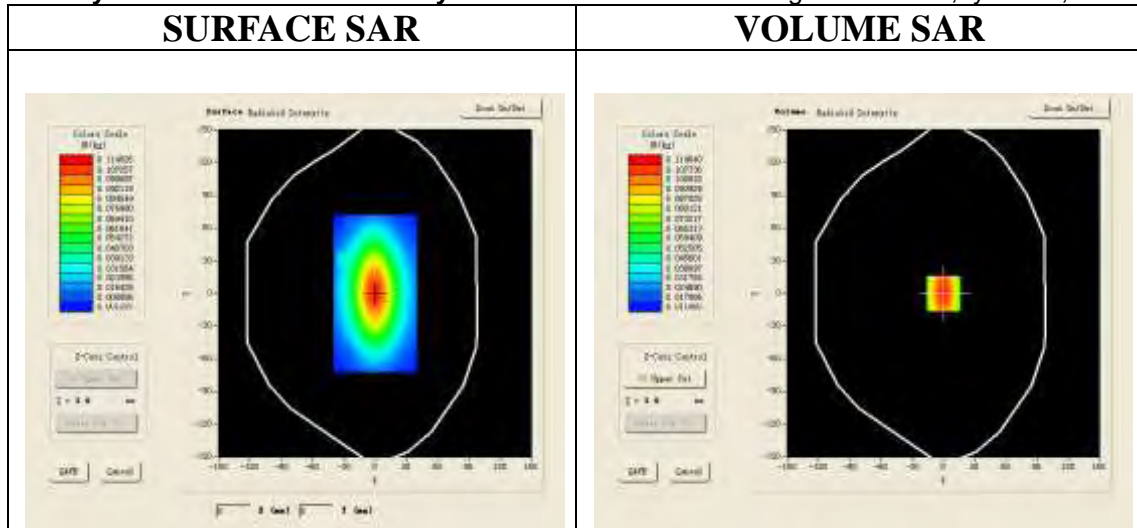

**Maximum location: X=0.00, Y=0.00**

<b>SAR 10g (W/Kg)</b>	0.069102
<b>SAR 1g (W/Kg)</b>	0.108021

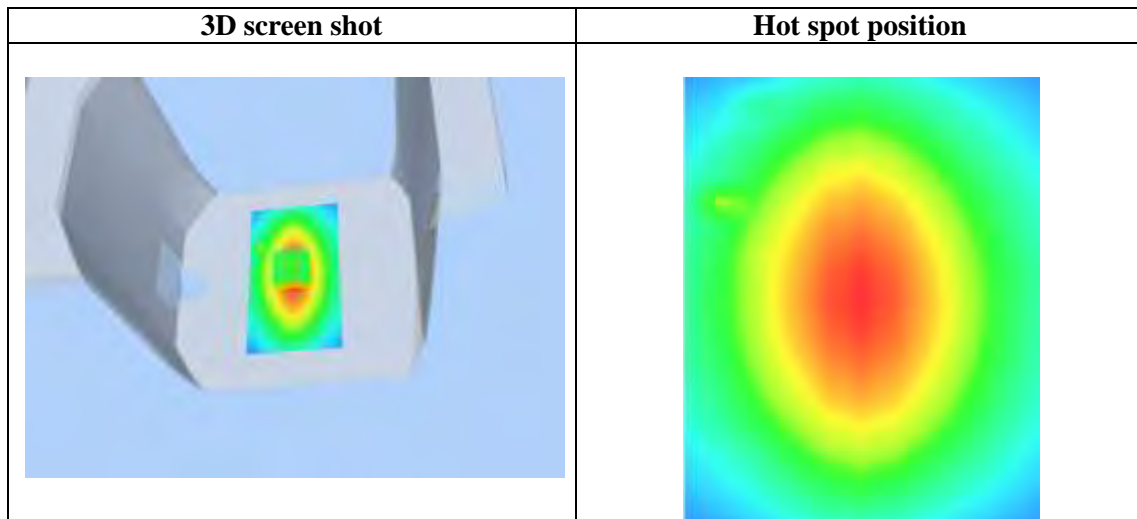
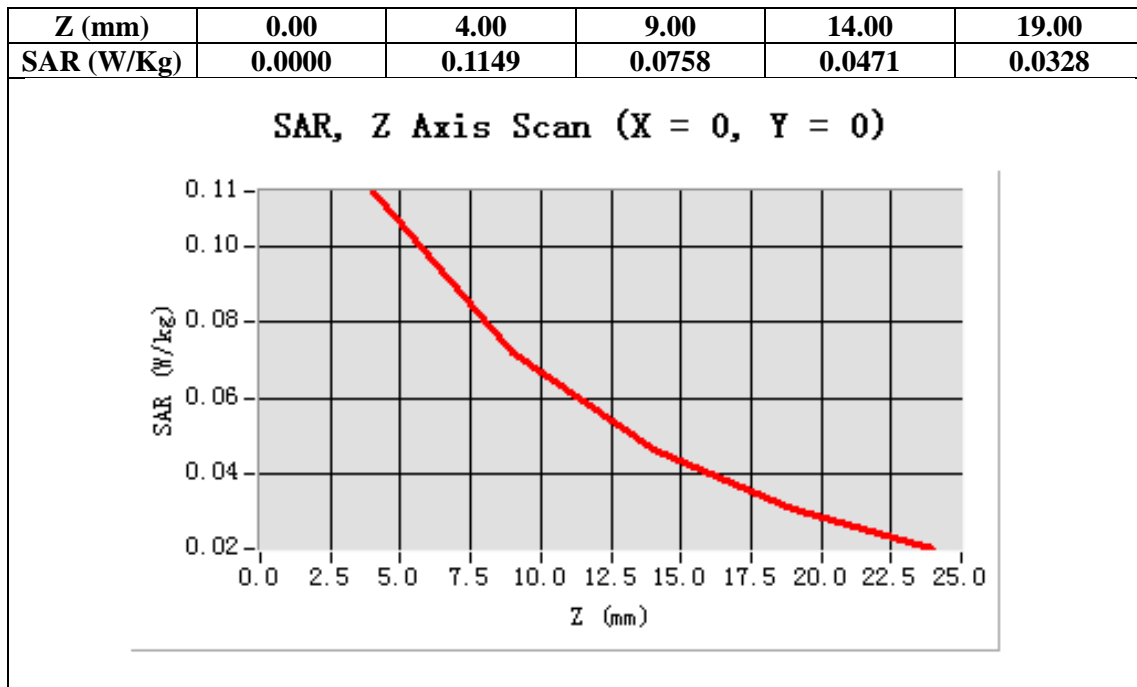

**Test Laboratory: AGC Lab**  
**System Check Head 1900MHz**  
**DUT: Dipole 1900 MHz; Type: SID 1900**

**Date: Oct.16,2014**

Communication System: CW; Communication System Band: D1900 (1900.0 MHz); Duty Cycle:1:1; Conv.F=4.51  
Frequency: 1900 MHz; Medium parameters used:  $f = 1900$  MHz;  $\sigma=1.42$  mho/m;  $\epsilon_r =40.46$ ;  $\rho= 1000$  kg/m<sup>3</sup> ;  
Phantom section: Flat Section; Input Power=10dBm  
Ambient temperature (°C): 21, Liquid temperature (°C): 21

SATIMO Configuration:

- Probe: SSE5; Calibrated: 01/12/2014; Serial No.:SN 22/12 EP159
- Sensor-Surface: 4mm (Mechanical Surface Detection)
- Phantom: Flat Phantom; Type: Elliptical Phantom
- Measurement SW: OpenSAR V4\_02\_01

**Configuration/System Check PCS1900 Head/Area Scan:** Measurement grid: dx=8mm,dy=8mm

**Configuration/System Check PCS1900 Head/Zoom Scan:** Measurement grid: dx=8mm,dy=8mm, dz=5mm

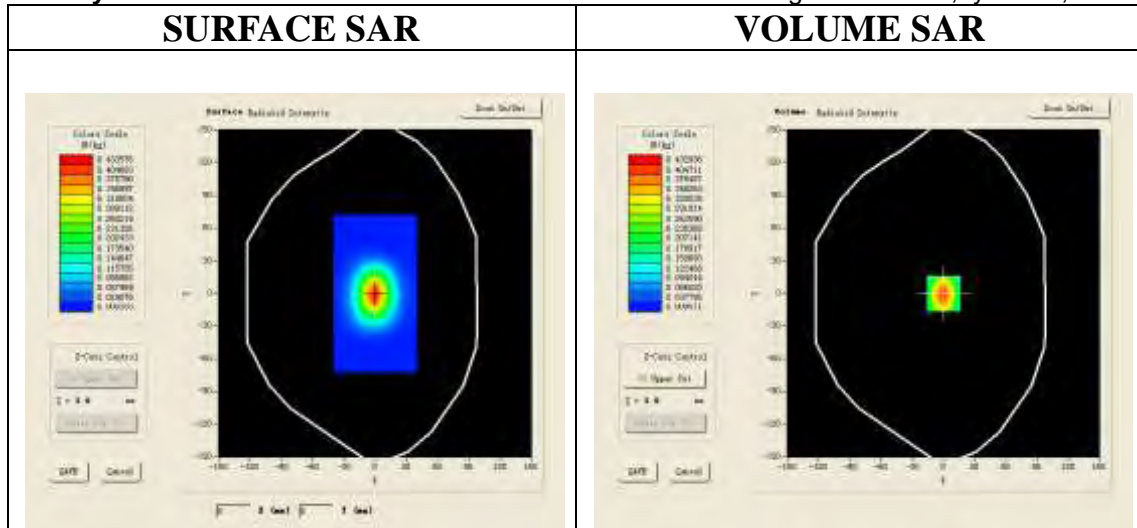

**Maximum location: X=0.00, Y=0.00**

<b>SAR 10g (W/Kg)</b>	0.203644
<b>SAR 1g (W/Kg)</b>	0.403206

Z (mm)	0.00	4.00	9.00	14.00	19.00
SAR (W/Kg)	0.0000	0.4335	0.2379	0.1307	0.0750

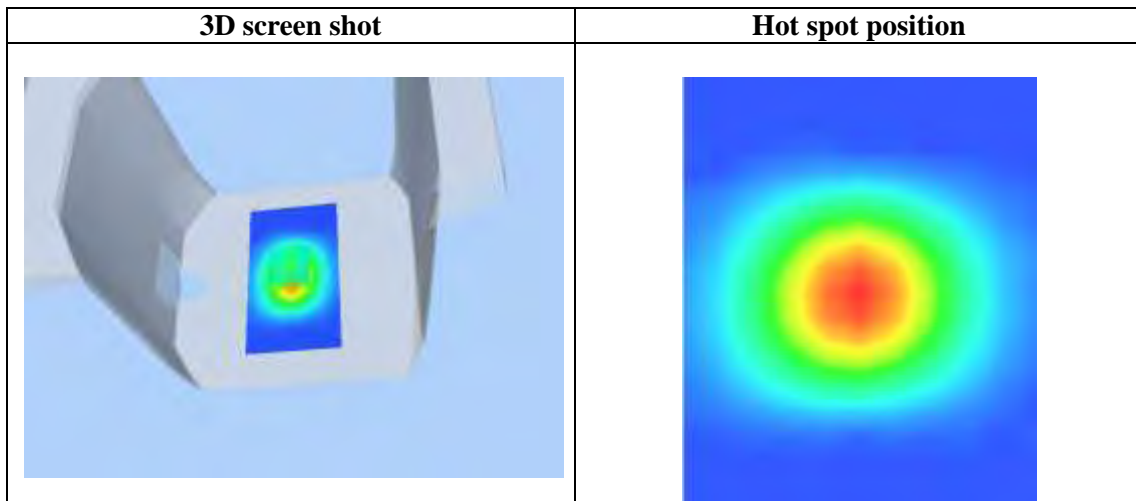
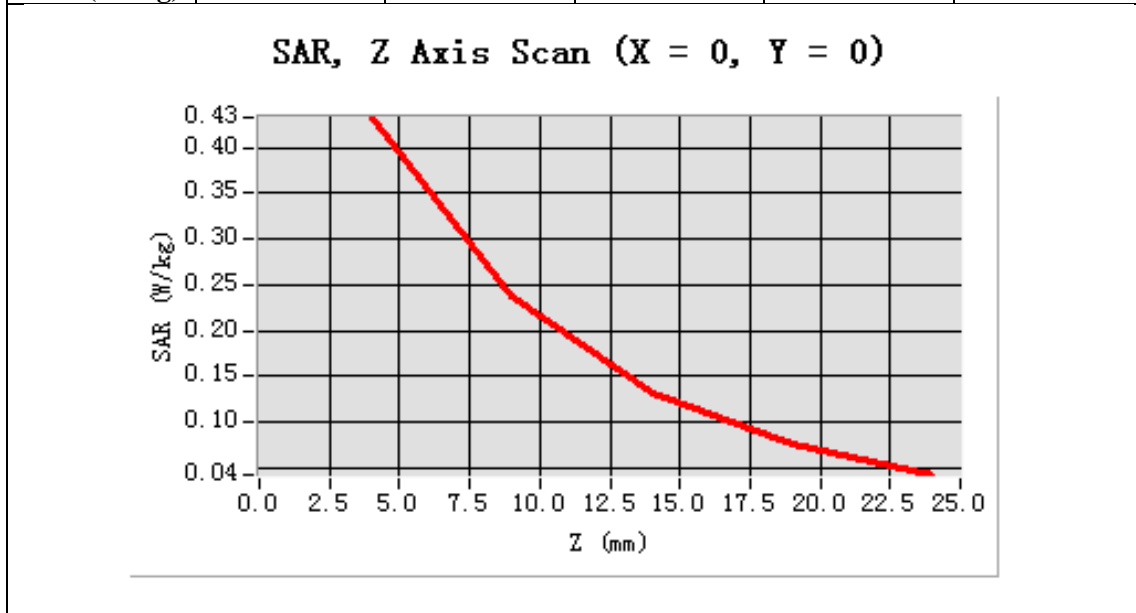

**Test Laboratory: AGC Lab**  
**System Check Body 1900MHz**  
**DUT: Dipole 1900 MHz; Type: SID 1900**

**Date: Oct.16,2014**

Communication System: CW; Communication System Band: D1900 (1900.0 MHz); Duty Cycle:1:1; Conv.F=4.45  
Frequency: 1900 MHz; Medium parameters used:  $f = 1900$  MHz;  $\sigma=1.49$  mho/m;  $\epsilon_r =53.21$ ;  $\rho= 1000$  kg/m<sup>3</sup> ;  
Phantom section: Flat Section; Input Power=10dBm  
Ambient temperature (°C): 21, Liquid temperature (°C): 21

SATIMO Configuration:

- Probe: SSE5; Calibrated: 01/12/2014; Serial No.:SN 22/12 EP159
- Sensor-Surface: 4mm (Mechanical Surface Detection)
- Phantom: Flat Phantom; Type: Elliptical Phantom
- Measurement SW: OpenSAR V4\_02\_01

**Configuration/System Check PCS1900 Body/Area Scan:** Measurement grid: dx=8mm,dy=8mm

**Configuration/System Check PCS1900 Body/Zoom Scan:** Measurement grid: dx=8mm,dy=8mm, dz=5mm

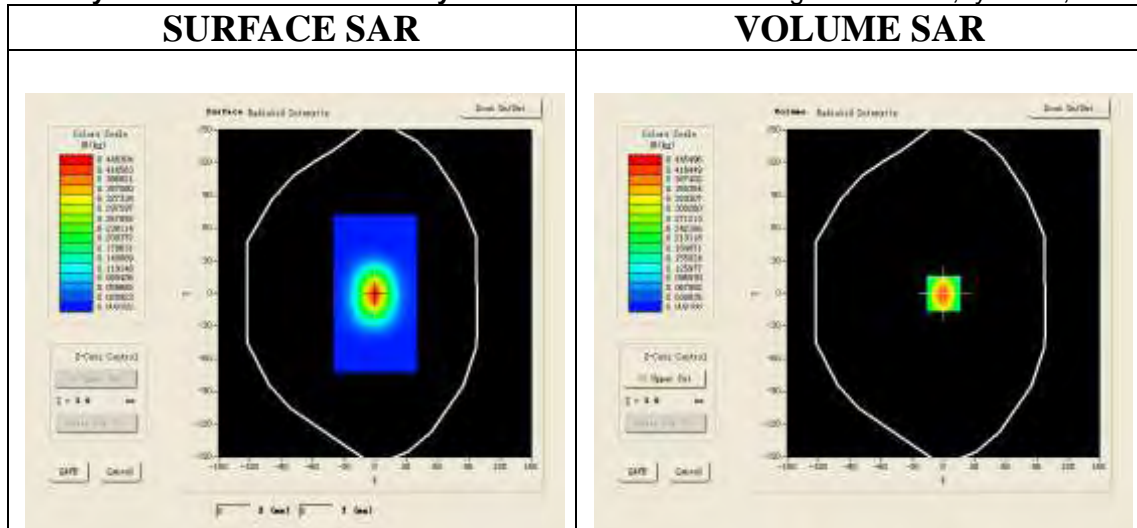

**Maximum location: X=0.00, Y=0.00**

<b>SAR 10g (W/Kg)</b>	0.201232
<b>SAR 1g (W/Kg)</b>	0.400407

Z (mm)	0.00	4.00	9.00	14.00	19.00
SAR (W/Kg)	0.0000	0.4443	0.2425	0.1341	0.0752

SAR, Z Axis Scan (X = 0, Y = 0)

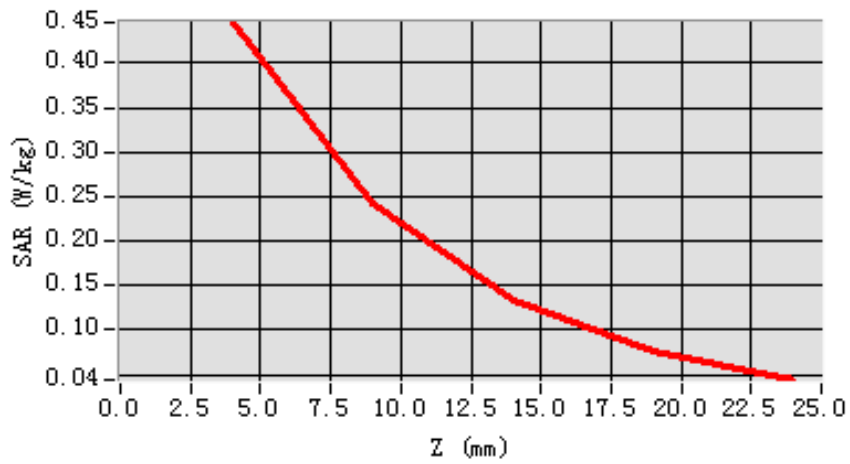

3D screen shot

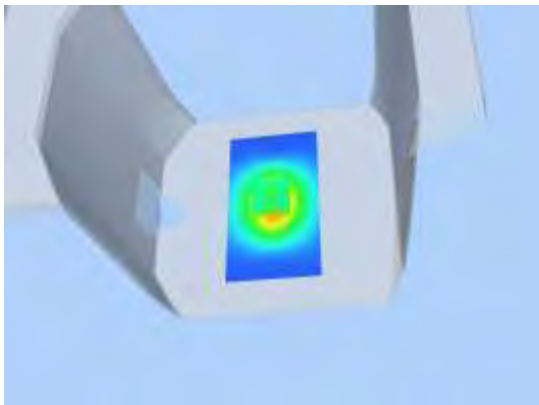

Hot spot position

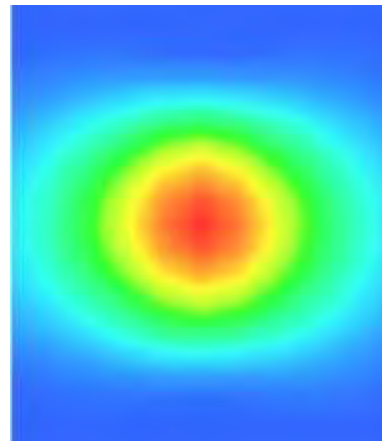



**Test Laboratory: AGC Lab**  
**System Check Body 2450 MHz**  
**DUT: Dipole 2450 MHz Type: SID 2450**

**Date: Oct.16,2014**

Communication System: CW; Communication System Band: D2450 (2450.0 MHz); Duty Cycle: 1:1; Conv.F=4.31  
Frequency: 2450 MHz; Medium parameters used:  $f = 2450$  MHz;  $\sigma = 1.95$  mho/m;  $\epsilon_r = 52.06$ ;  $\rho = 1000$  kg/m<sup>3</sup> ;  
Phantom section: Flat Section; Input Power=10dBm  
Ambient temperature (°C): 21, Liquid temperature (°C): 21

SATIMO Configuration:

- Probe: SSE5; Calibrated: 01/12/2014; Serial No.:SN 22/12 EP159
- Sensor-Surface: 4mm (Mechanical Surface Detection)
- Phantom: Flat Phantom; Type: Elliptical Phantom
- Measurement SW: OpenSAR V4\_02\_01

**Configuration/System Check 2450 MHz Body/Area Scan:** Measurement grid: dx=8mm,dy=8mm

**Configuration/System Check 2450 MHz Body/Zoom Scan:** Measurement grid: dx=8mm,dy=8mm, dz=5mm

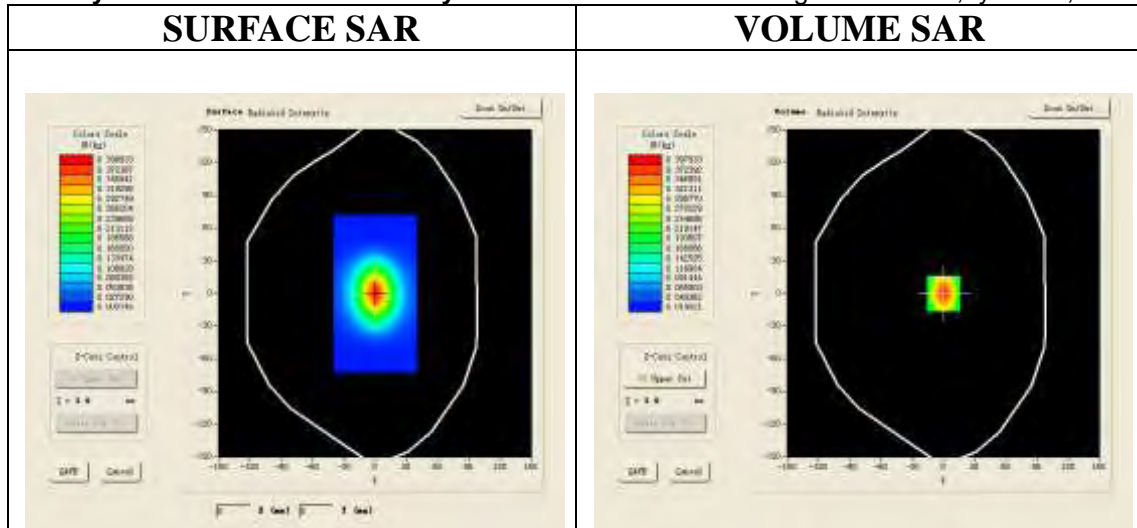

**Maximum location: X=0.00, Y=0.00**

<b>SAR 10g (W/Kg)</b>	0.230238
<b>SAR 1g (W/Kg)</b>	0.499512

Z (mm)	0.00	4.00	9.00	14.00	19.00
SAR (W/Kg)	0.0000	0.3972	0.2289	0.1249	0.0721

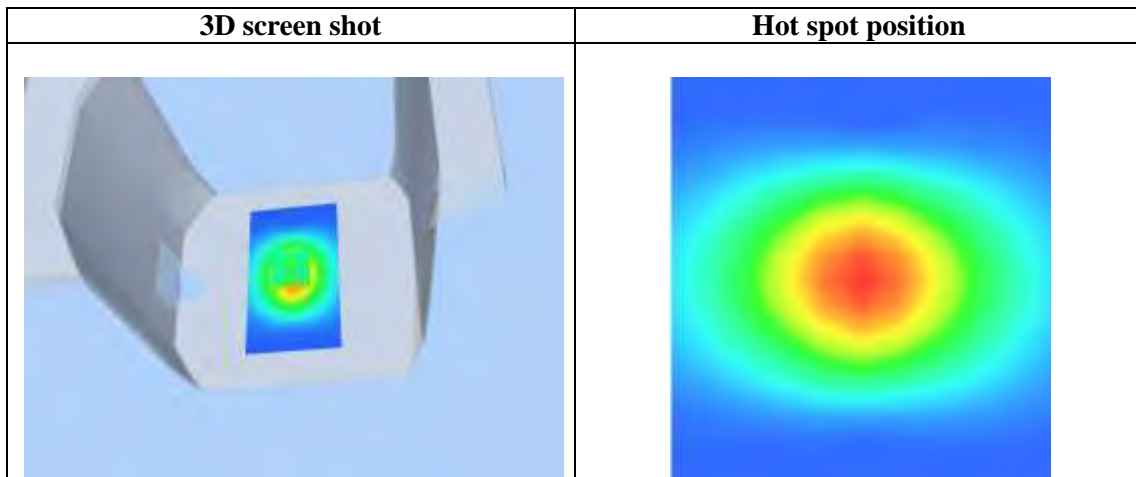
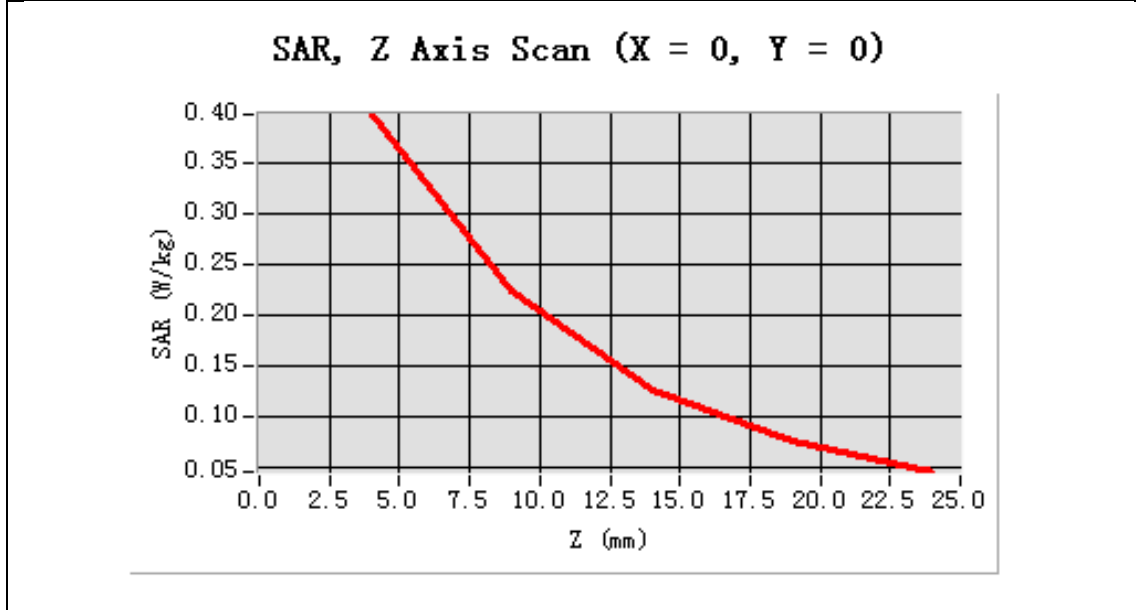

## APPENDIX B. SAR MEASUREMENT DATA

Test Laboratory: AGC Lab

Date: Oct.16,2014

GSM 850 Mid-Touch-Left <SIM 1>

DUT: mobile phone; Type: AM503

Communication System: Generic GSM; Communication System Band: GSM 835; Duty Cycle: 1:8.3; Conv.F=5.27  
Frequency: 836.6 MHz; Medium parameters used:  $f = 835$  MHz;  $\sigma = 0.91$  mho/m;  $\epsilon_r = 41.22$ ;  $\rho = 1000$  kg/m<sup>3</sup> ;  
Phantom section: Left Section  
Ambient temperature (°C): 21.0, Liquid temperature (°C): 21.0

SATIMO Configuration:

- Probe: SSE5; Calibrated: 01/12/2014; Serial No.:SN 22/12 EP159
- Sensor-Surface: 4mm (Mechanical Surface Detection)
- Phantom: Flat Phantom; Type: Elliptical Phantom
- Measurement SW: OpenSAR V4\_02\_01

Configuration/GSM 850 Mid-Touch-Left/Area Scan: Measurement grid: dx=8mm, dy=8mm

Configuration/GSM 850 Mid-Touch-Left/Zoom Scan: Measurement grid: dx=8mm,dy=8mm, dz=5mm

<b>Area Scan</b>	sam_direct_droit2_surf8mm.txt
<b>ZoomScan</b>	5x5x7,dx=8mm dy=8mm dz=5mm,Very fast
<b>Phantom</b>	Left head
<b>Device Position</b>	Cheek
<b>Band</b>	GSM 850
<b>Channels</b>	Middle
<b>Signal</b>	TDMA (Crest factor: 8.0)

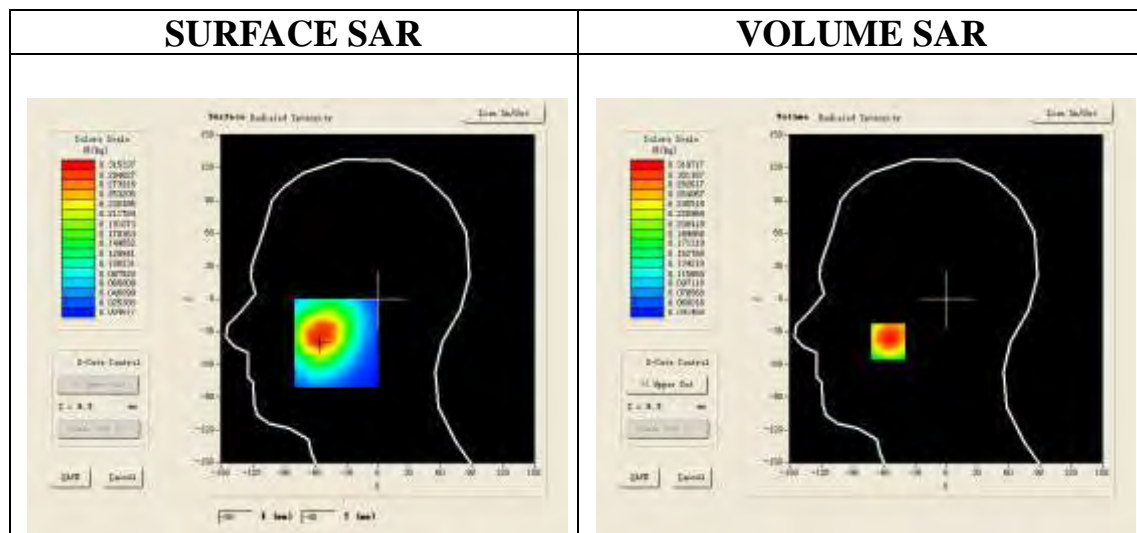

**Maximum location: X=-56.00, Y=-39.00**

<b>SAR 10g (W/Kg)</b>	0.211364
<b>SAR 1g (W/Kg)</b>	0.308492

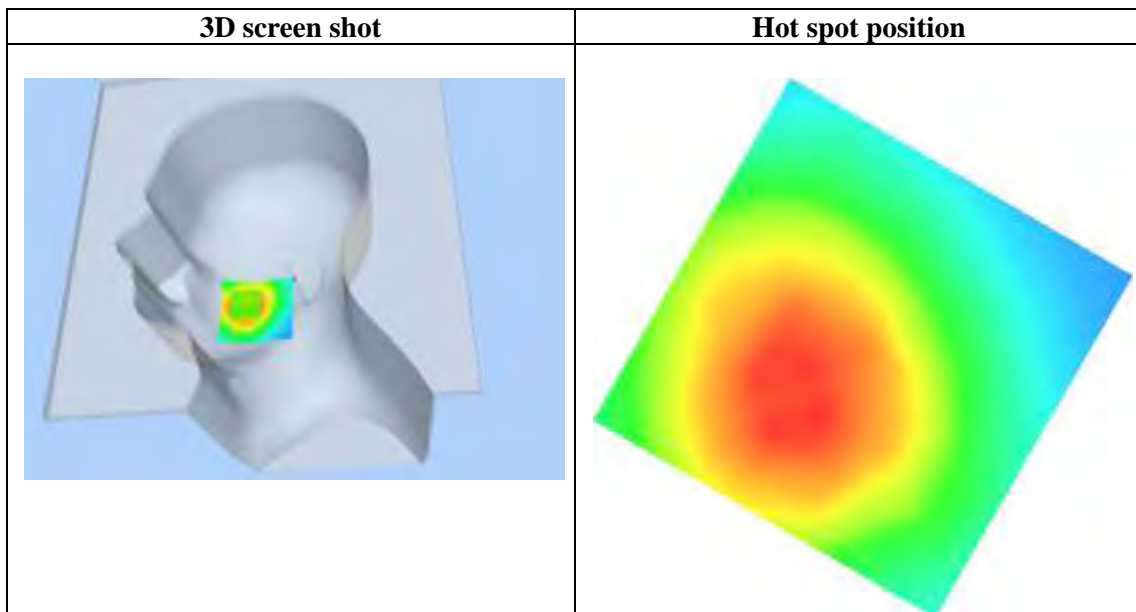
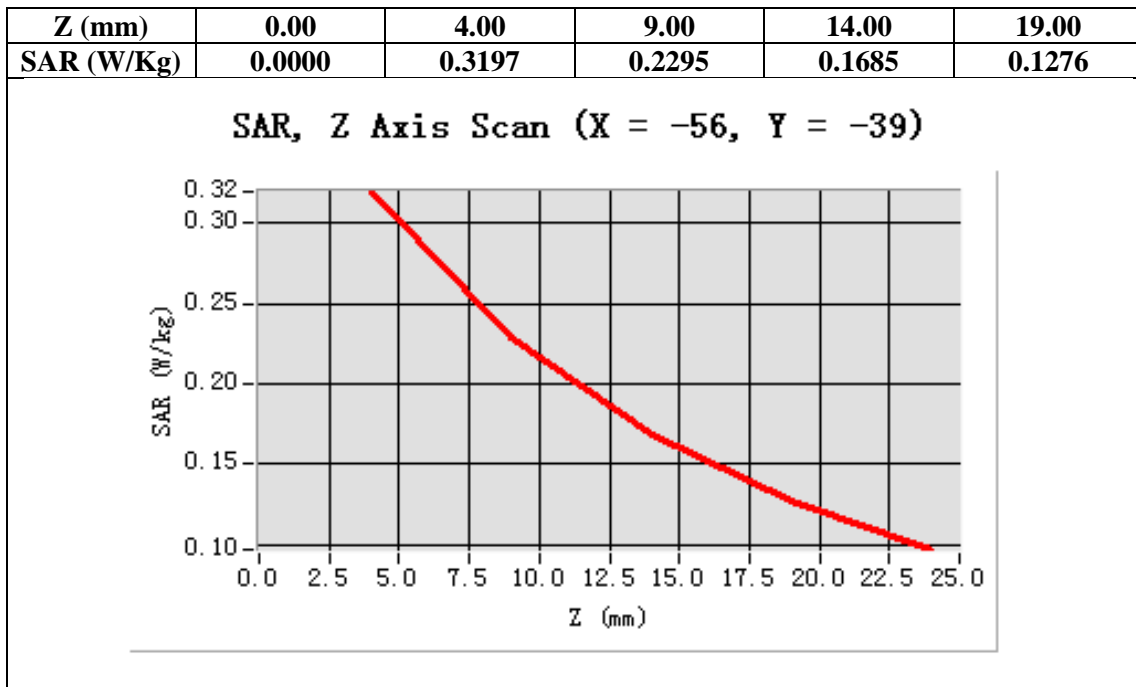

Test Laboratory: AGC Lab  
GSM 850 Mid-Tilt-Left <SIM 1>  
DUT: mobile phone; Type: AM503

Date: Oct.16,2014

Communication System: Generic GSM; Communication System Band: GSM 835; Duty Cycle: 1:8.3; Conv.F=5.27;  
Frequency: 836.6 MHz; Medium parameters used: f = 835 MHz;  $\sigma=0.91$  mho/m;  $\epsilon_r=41.22$  ;  $\rho= 1000$  kg/m<sup>3</sup> ;  
Phantom section: Left Section  
Ambient temperature (°C): 21.0, Liquid temperature(°C): 21.0

SATIMO Configuration:

- Probe: SSE5; Calibrated: 01/12/2014; Serial No.:SN 22/12 EP159
- Sensor-Surface: 4mm (Mechanical Surface Detection)
- Phantom: Flat Phantom; Type: Elliptical Phantom
- Measurement SW: OpenSAR V4\_02\_01

Configuration/GSM 850 Mid-Tilt-Left/Area Scan: Measurement grid: dx=8mm, dy=8mm

Configuration/GSM 850 Mid-Tilt-Left/Zoom Scan: Measurement grid: dx=8mm, dy=8mm,dz=5mm;

<b>Area Scan</b>	sam_direct_droit2_surf8mm.txt
<b>ZoomScan</b>	5x5x7,dx=8mm dy=8mm dz=5mm,Very fast
<b>Phantom</b>	Left head
<b>Device Position</b>	Tilt
<b>Band</b>	GSM 850
<b>Channels</b>	Middle
<b>Signal</b>	TDMA (Crest factor: 8.0)

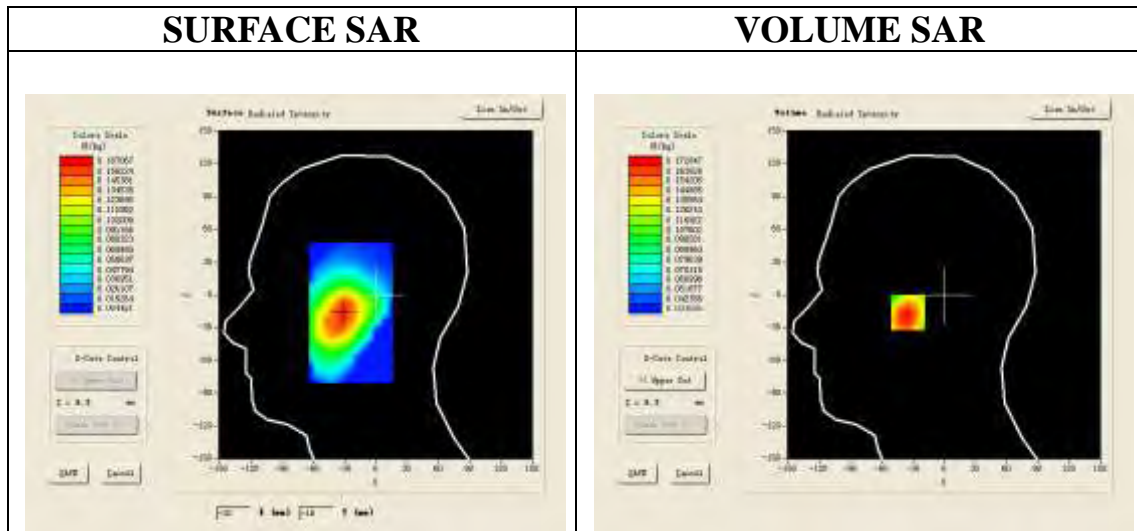

Maximum location: X=-32.00, Y=-16.00

<b>SAR 10g (W/Kg)</b>	0.118895
<b>SAR 1g (W/Kg)</b>	0.167253

Z (mm)	0.00	4.00	9.00	14.00	19.00
SAR (W/Kg)	0.0000	0.1728	0.1241	0.0940	0.0763

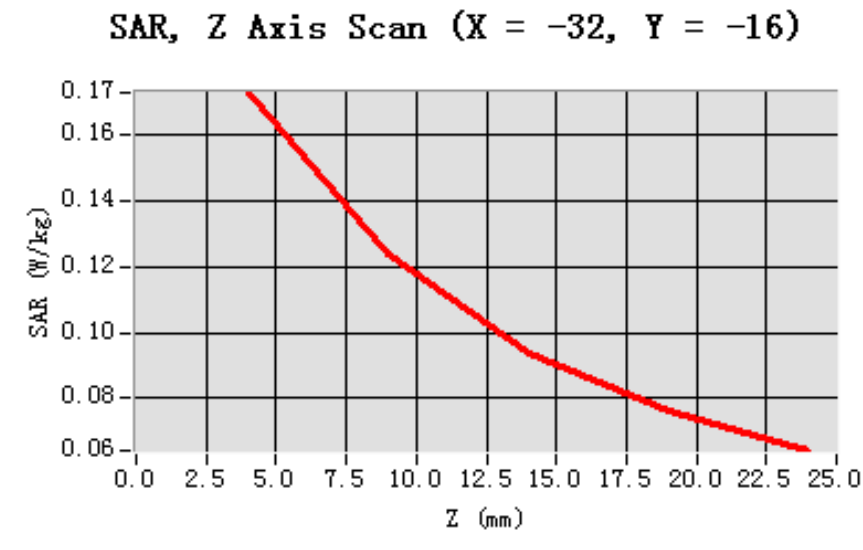

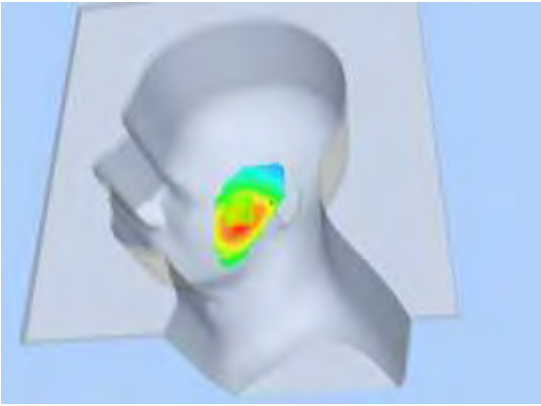
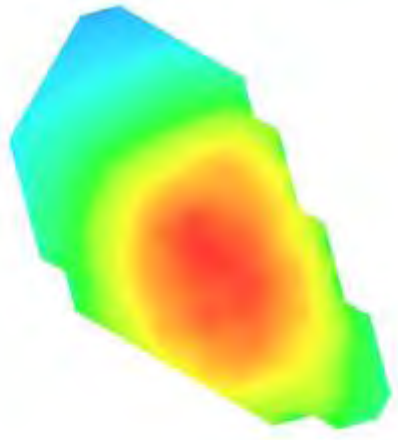
3D screen shot	Hot spot position
	

Test Laboratory: AGC Lab  
GSM 850 Mid-Touch-Right <SIM 1>  
DUT: mobile phone; Type: AM503

Date: Oct.16,2014

Communication System: Generic GSM; Communication System Band: GSM 835; Duty Cycle: 1:8.3; Conv.F=5.27;  
Frequency: 836.6 MHz; Medium parameters used:  $f = 835$  MHz;  $\sigma = 0.91$  mho/m;  $\epsilon_r = 41.22$ ;  $\rho = 1000$  kg/m<sup>3</sup> ;  
Phantom section: Right Section  
Ambient temperature (°C): 21.0, Liquid temperature (°C): 21.0

SATIMO Configuration:

- Probe: SSE5; Calibrated: 01/12/2014; Serial No.:SN 22/12 EP159
- Sensor-Surface: 4mm (Mechanical Surface Detection)
- Phantom: Flat Phantom; Type: Elliptical Phantom
- Measurement SW: OpenSAR V4\_02\_01

Configuration/GSM 850 Mid-Touch-Right/Area Scan: Measurement grid: dx=8mm, dy=8mm

Configuration/GSM 850 Mid-Touch-Right/Zoom Scan: Measurement grid: dx=8mm,dy=8mm, dz=5mm;

Area Scan	sam_direct_droit2_surf8mm.txt
ZoomScan	5x5x7,dx=8mm dy=8mm dz=5mm,Very fast
Phantom	Right head
Device Position	Cheek
Band	GSM 850
Channels	Middle
Signal	TDMA (Crest factor: 8.0)

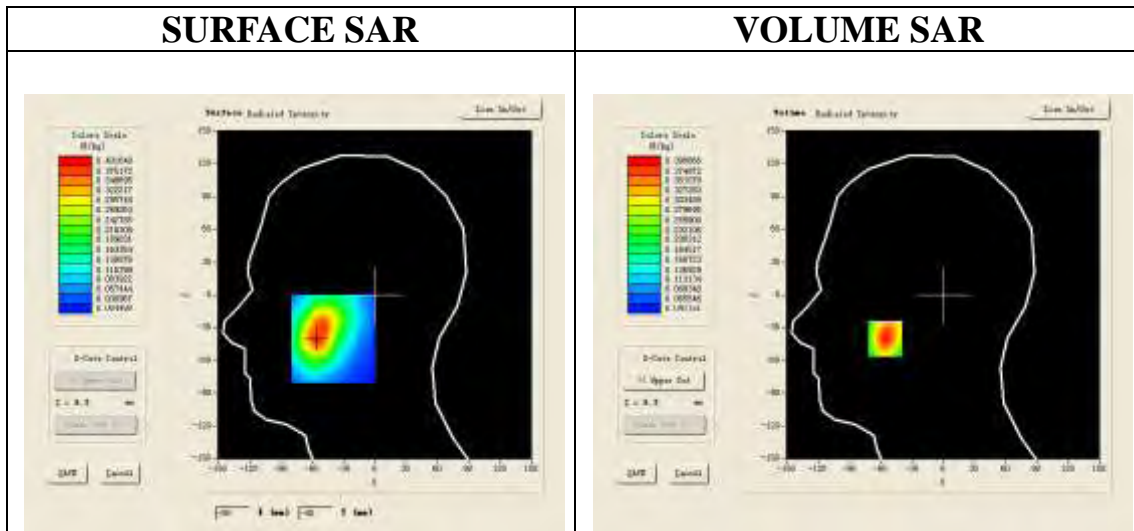

Maximum location: X=-56.00, Y=-40.00

<b>SAR 10g (W/Kg)</b>	0.247061
<b>SAR 1g (W/Kg)</b>	0.377559

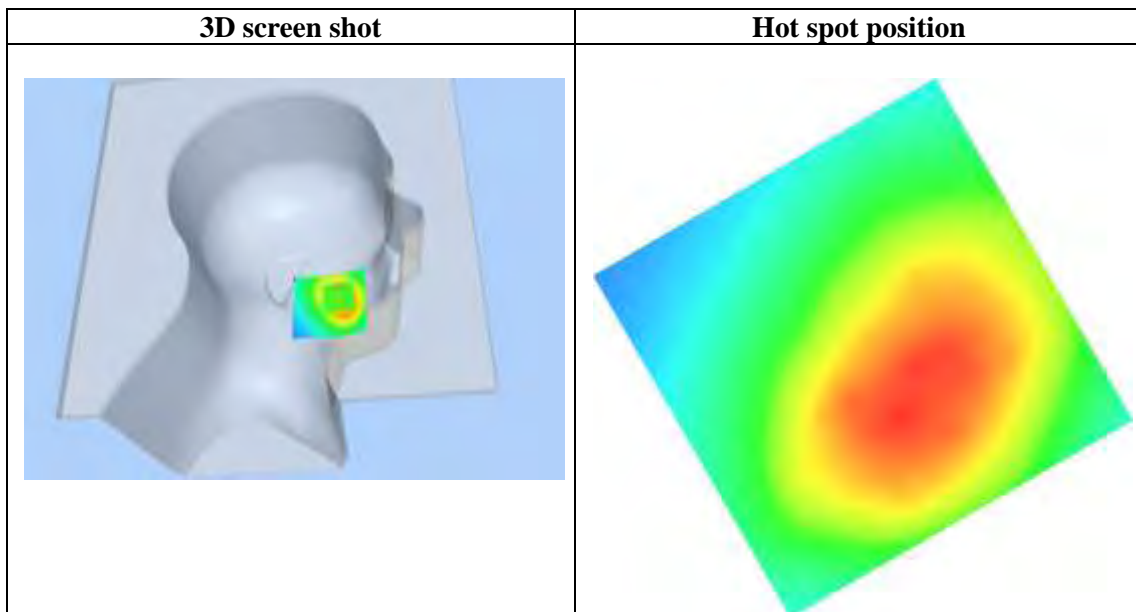
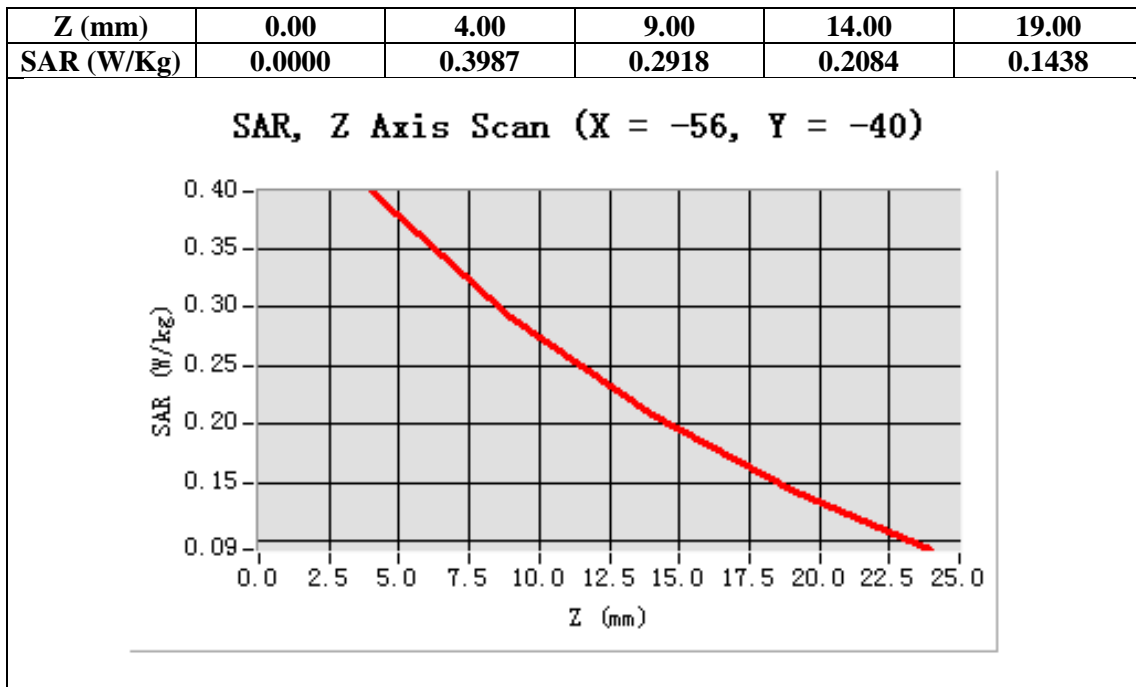



Test Laboratory: AGC Lab  
GSM 850 Mid-Tilt-Right <SIM 1>  
DUT: mobile phone; Type: AM503

Date: Oct.16,2014

Communication System: Generic GSM; Communication System Band: GSM 835; Duty Cycle: 1:8.3; Conv.F=5.27;  
Frequency: 836.6 MHz; Medium parameters used: f = 835 MHz;  $\sigma=0.91$  mho/m;  $\epsilon_r=41.22$  ;  $\rho= 1000$  kg/m<sup>3</sup> ;  
Phantom section: Right Section  
Ambient temperature (°C): 21.0, Liquid temperature (°C): 21.0

SATIMO Configuration:

- Probe: SSE5; Calibrated: 01/12/2014; Serial No.:SN 22/12 EP159
- Sensor-Surface: 4mm (Mechanical Surface Detection)
- Phantom: Flat Phantom; Type: Elliptical Phantom
- Measurement SW: OpenSAR V4\_02\_01

Configuration/GSM 850 Mid-Tilt-Right/Area Scan: Measurement grid: dx=8mm, dy=8mm  
Configuration/GSM 850 Mid-Tilt-Right/Zoom Scan: Measurement grid: dx=8mm,dy=8mm, dz=5mm;

Area Scan	sam_direct_droit2_surf8mm.txt
Zoom Scan	5x5x7,dx=8mm dy=8mm dz=5mm,Very fast
Phantom	Right head
Device Position	Tilt
Band	GSM 850
Channels	Middle
Signal	TDMA (Crest factor: 8.0)

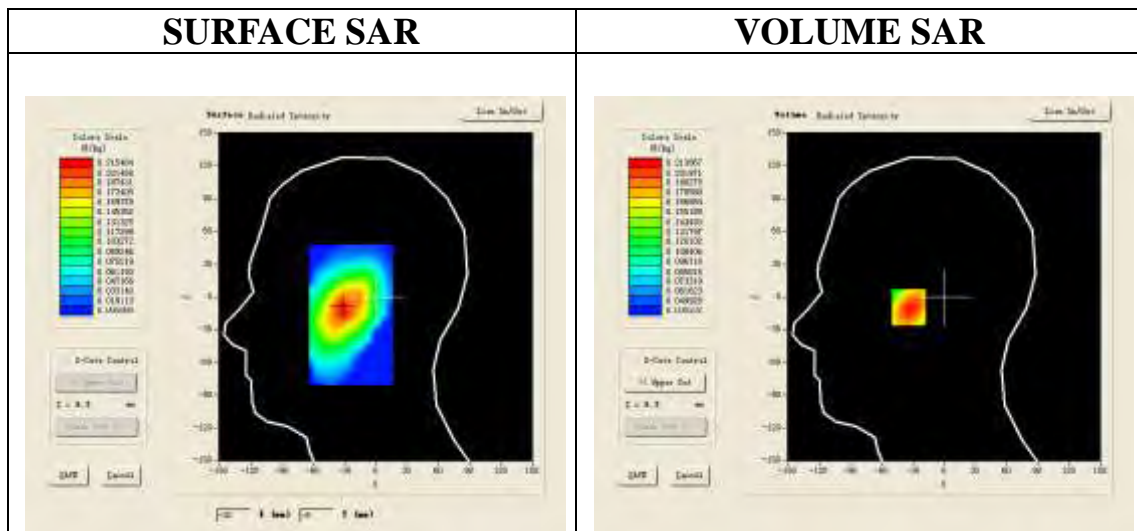

Maximum location: X=-32.00, Y=-9.00

SAR 10g (W/Kg)	0.146638
SAR 1g (W/Kg)	0.205423

Z (mm)	0.00	4.00	9.00	14.00	19.00
SAR (W/Kg)	0.0000	0.2137	0.1572	0.1202	0.0965

**SAR, Z Axis Scan (X = -32, Y = -9)**

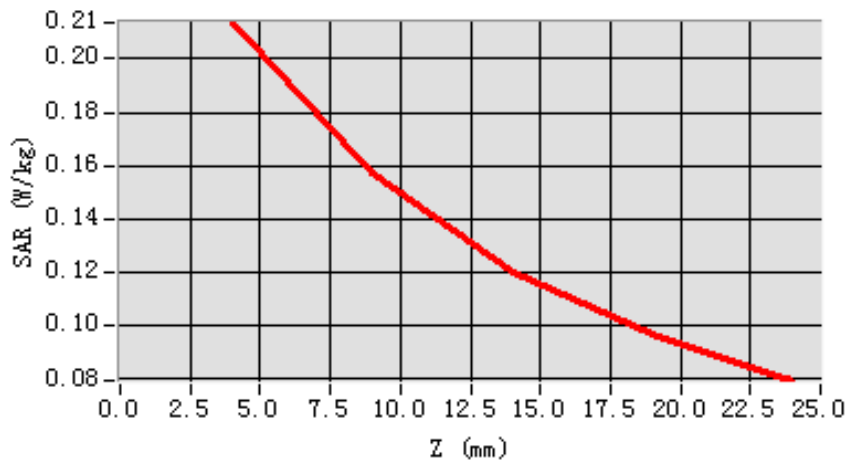

**3D screen shot**

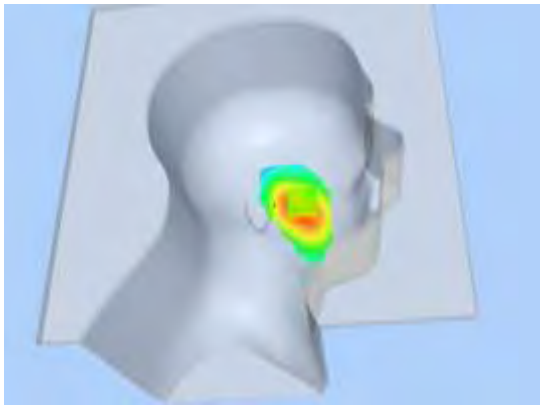

**Hot spot position**

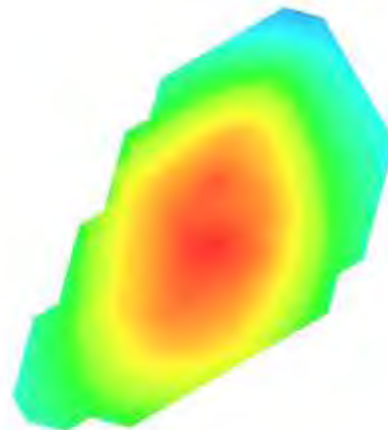

Test Laboratory: AGC Lab  
GSM 850 Mid-Touch-Right <SIM 2>  
DUT: mobile phone; Type: AM503

Date: Oct.16,2014

Communication System: Generic GSM; Communication System Band: GSM 835; Duty Cycle: 1:8.3; Conv.F=5.27;  
Frequency: 836.6 MHz; Medium parameters used: f = 835 MHz;  $\sigma = 0.91$  mho/m;  $\epsilon_r = 41.22$ ;  $\rho = 1000$  kg/m<sup>3</sup> ;  
Phantom section: Right Section  
Ambient temperature (°C): 21.0, Liquid temperature (°C): 21.0

SATIMO Configuration:

- Probe: SSE5; Calibrated: 01/12/2014; Serial No.:SN 22/12 EP159
- Sensor-Surface: 4mm (Mechanical Surface Detection)
- Phantom: Flat Phantom; Type: Elliptical Phantom
- Measurement SW: OpenSAR V4\_02\_01

Configuration/GSM 850 Mid-Touch-Right/Area Scan: Measurement grid: dx=8mm, dy=8mm

Configuration/GSM 850 Mid-Touch-Right/Zoom Scan: Measurement grid: dx=8mm,dy=8mm, dz=5mm;

Area Scan	sam_direct_droit2_surf8mm.txt
ZoomScan	5x5x7,dx=8mm dy=8mm dz=5mm,Very fast
Phantom	Right head
Device Position	Cheek
Band	GSM 850
Channels	Middle
Signal	TDMA (Crest factor: 8.0)

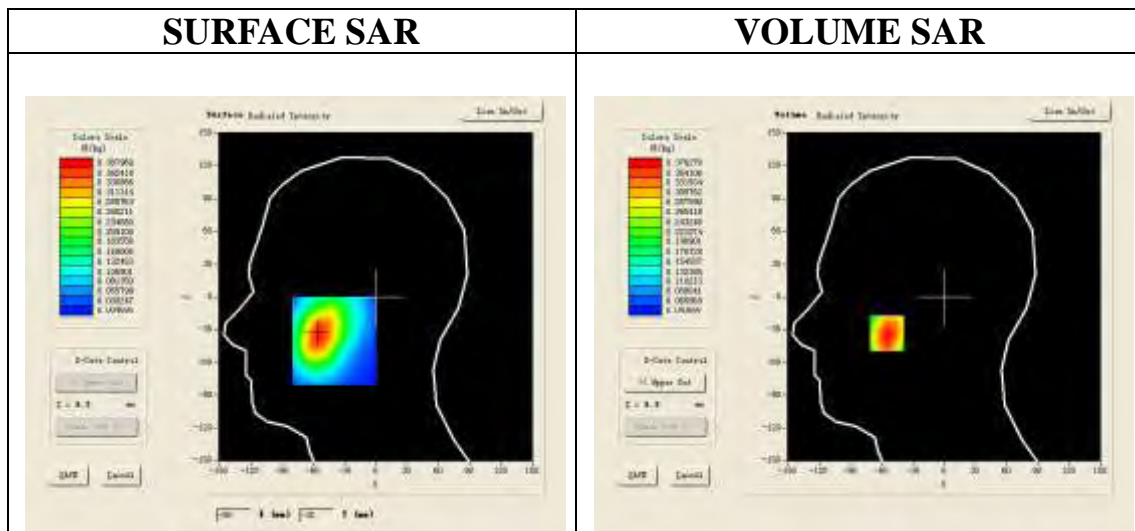

Maximum location: X=-55.00, Y=-33.00

SAR 10g (W/Kg)	0.247266
SAR 1g (W/Kg)	0.360253

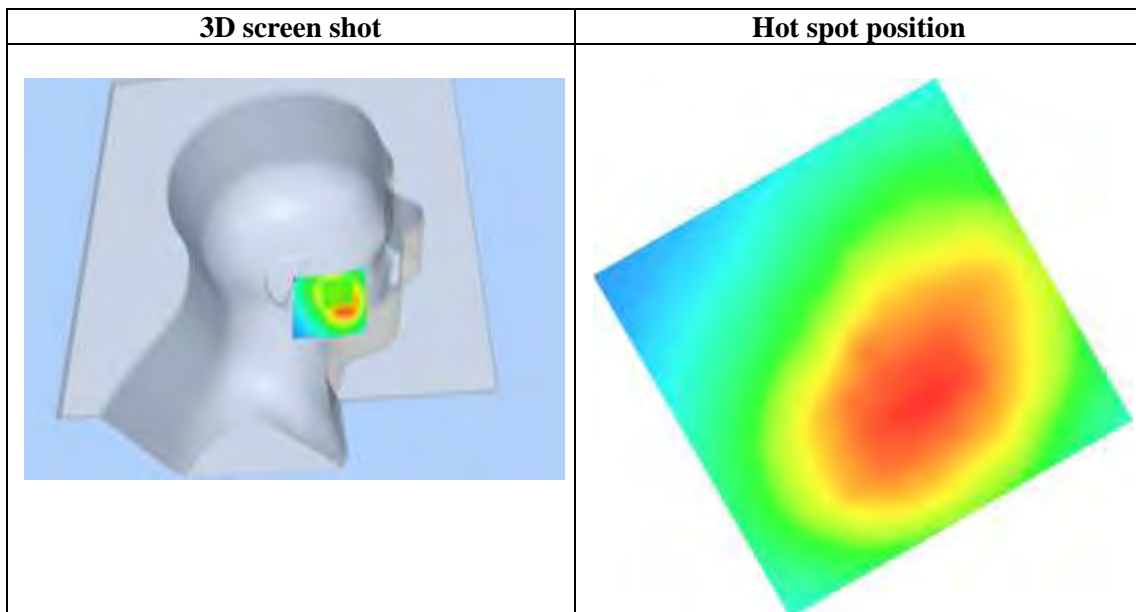
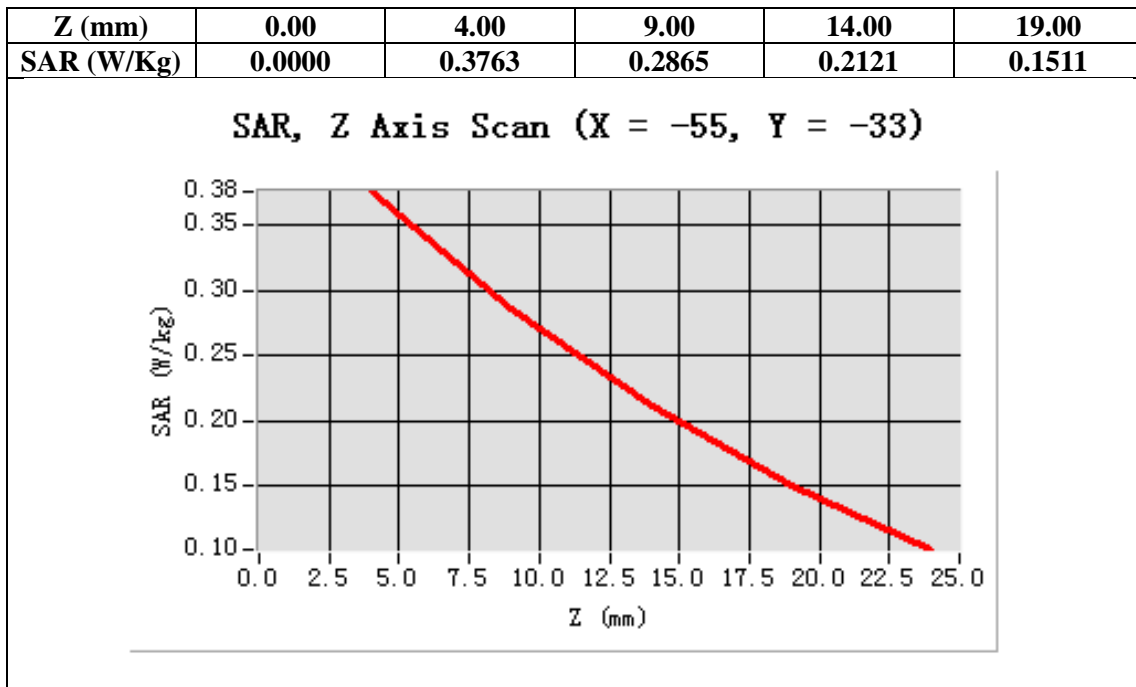

Test Laboratory: AGC Lab  
GSM 850 Low- Body- Back <SIM 1>  
DUT: mobile phone; Type: AM503

Date: Oct.16,2014

Communication System: Generic GSM; Communication System Band: GSM 835; Duty Cycle: 1:8.3; Conv.F=5.48;  
Frequency: 824.2MHz; Medium parameters used:  $f = 835$  MHz;  $\sigma = 0.96$ mho/m;  $\epsilon_r = 55.42$ ;  $\rho = 1000$  kg/m<sup>3</sup> ;  
Phantom section: Flat Section  
Ambient temperature (°C): 21.0, Liquid temperature (°C): 21.0

SATIMO Configuration:

- Probe: SSE5; Calibrated: 01/12/2014; Serial No.:SN 22/12 EP159
- Sensor-Surface: 4mm (Mechanical Surface Detection)
- Phantom: Flat Phantom; Type: Elliptical Phantom
- Measurement SW: OpenSAR V4\_02\_01

Configuration/GSM 850 Low -Body-Back/Area Scan: Measurement grid: dx=8mm, dy=8mm

Configuration/GSM 850 Low -Body-Back/Zoom Scan: Measurement grid: dx=8mm,dy=8mm, dz=5mm;

Area Scan	surf_sam_plan.txt
ZoomScan	5x5x7,dx=8mm dy=8mm dz=5mm,Very fast
Phantom	Validation plane
Device Position	Body Back
Band	GSM 850
Channels	Low
Signal	TDMA (Crest factor: 8.0)

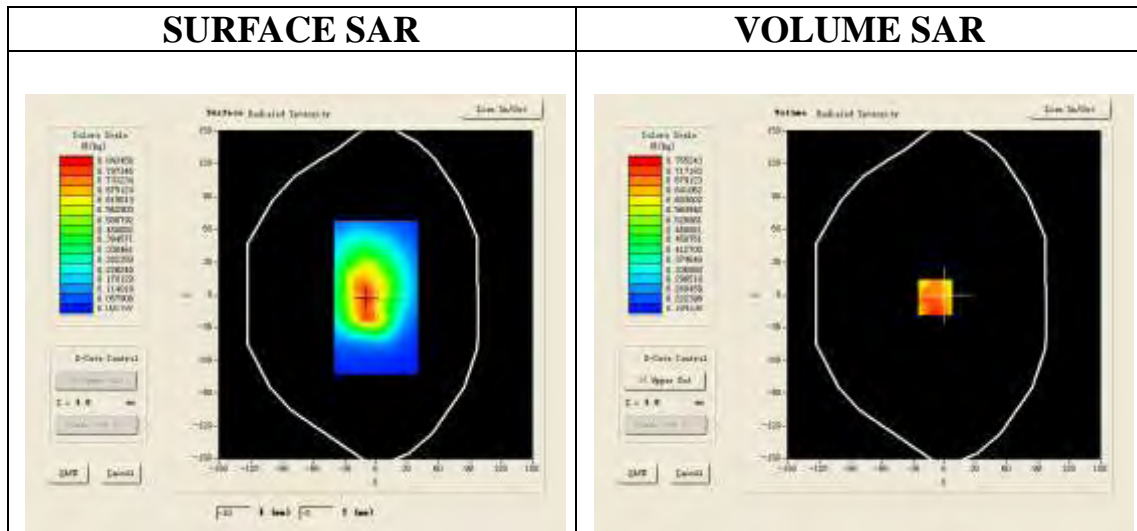

Maximum location: X=-9.00, Y=-2.00

SAR 10g (W/Kg)	0.548977
SAR 1g (W/Kg)	0.715618

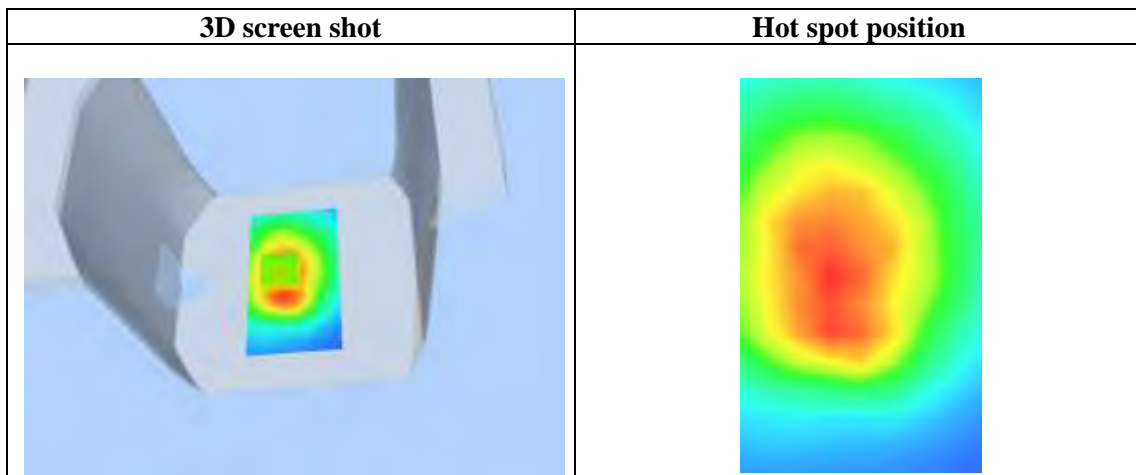
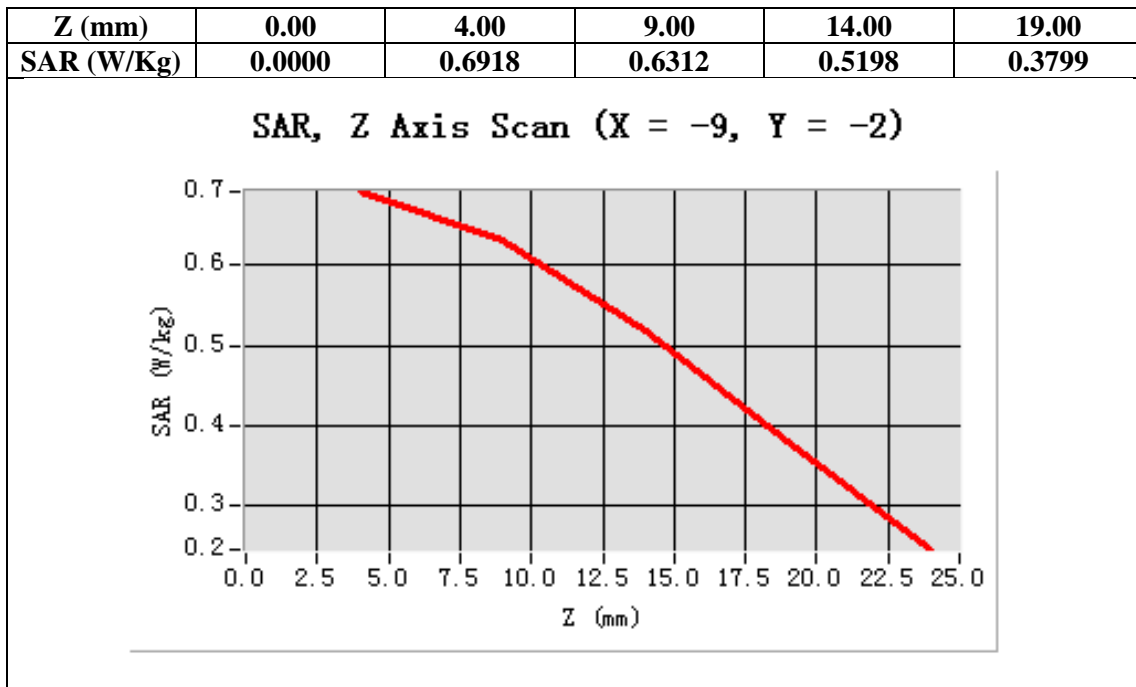

Test Laboratory: AGC Lab  
GSM 850 Mid- Body- Back <SIM 1>  
DUT: mobile phone; Type: AM503

Date: Oct.16,2014

Communication System: Generic GSM; Communication System Band: GSM 835; Duty Cycle: 1:8.3; Conv.F=5.48;  
Frequency: 836.6 MHz; Medium parameters used:  $f = 835$  MHz;  $\sigma = 0.98$ mho/m;  $\epsilon_r = 55.10$ ;  $\rho = 1000$  kg/m<sup>3</sup> ;  
Phantom section: Flat Section  
Ambient temperature (°C): 21.0, Liquid temperature (°C): 21.0

SATIMO Configuration:

- Probe: SSE5; Calibrated: 01/12/2014; Serial No.:SN 22/12 EP159
- Sensor-Surface: 4mm (Mechanical Surface Detection)
- Phantom: Flat Phantom; Type: Elliptical Phantom
- Measurement SW: OpenSAR V4\_02\_01

Configuration/GSM 850 Mid-Body-Back/Area Scan: Measurement grid: dx=8mm, dy=8mm  
Configuration/GSM 850 Mid-Body-Back/Zoom Scan: Measurement grid: dx=8mm,dy=8mm, dz=5mm;

Area Scan	surf_sam_plan.txt
ZoomScan	5x5x7,dx=8mm dy=8mm dz=5mm,Very fast
Phantom	Validation plane
Device Position	Body Back
Band	GSM 850
Channels	Middle
Signal	TDMA (Crest factor: 8.0)

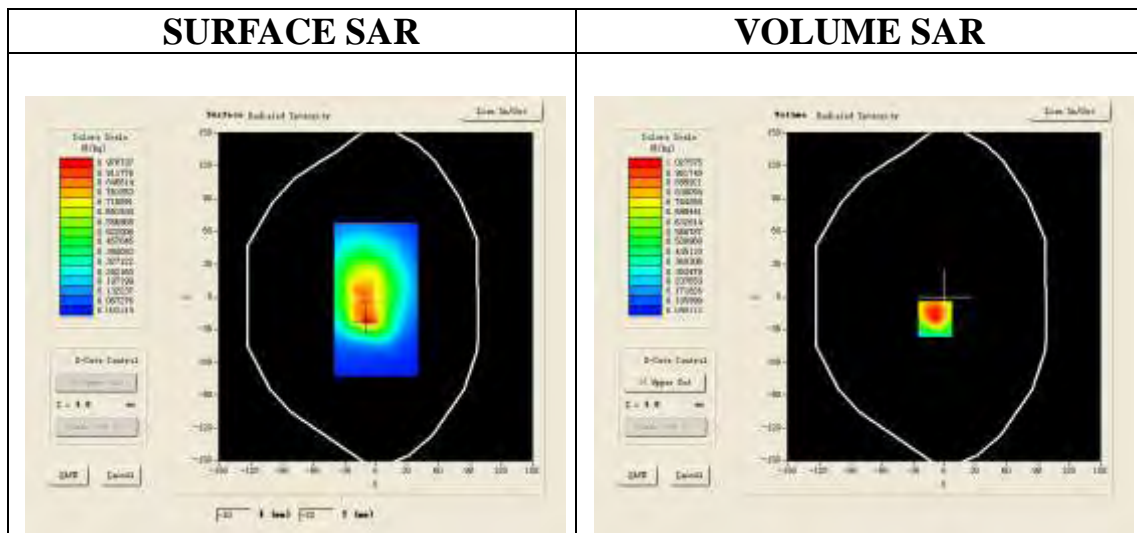

Maximum location: X=-9.00, Y=-20.00

SAR 10g (W/Kg)	0.591761
SAR 1g (W/Kg)	0.996403

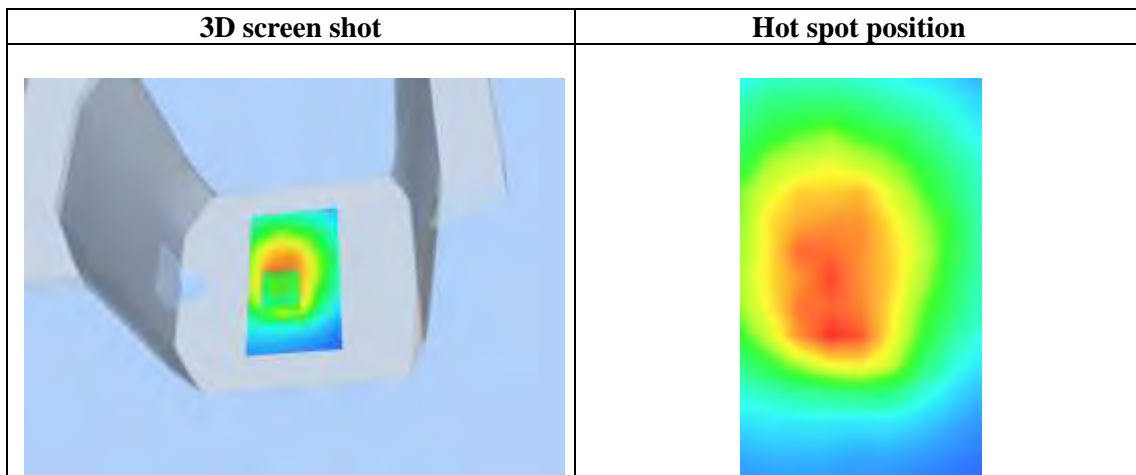
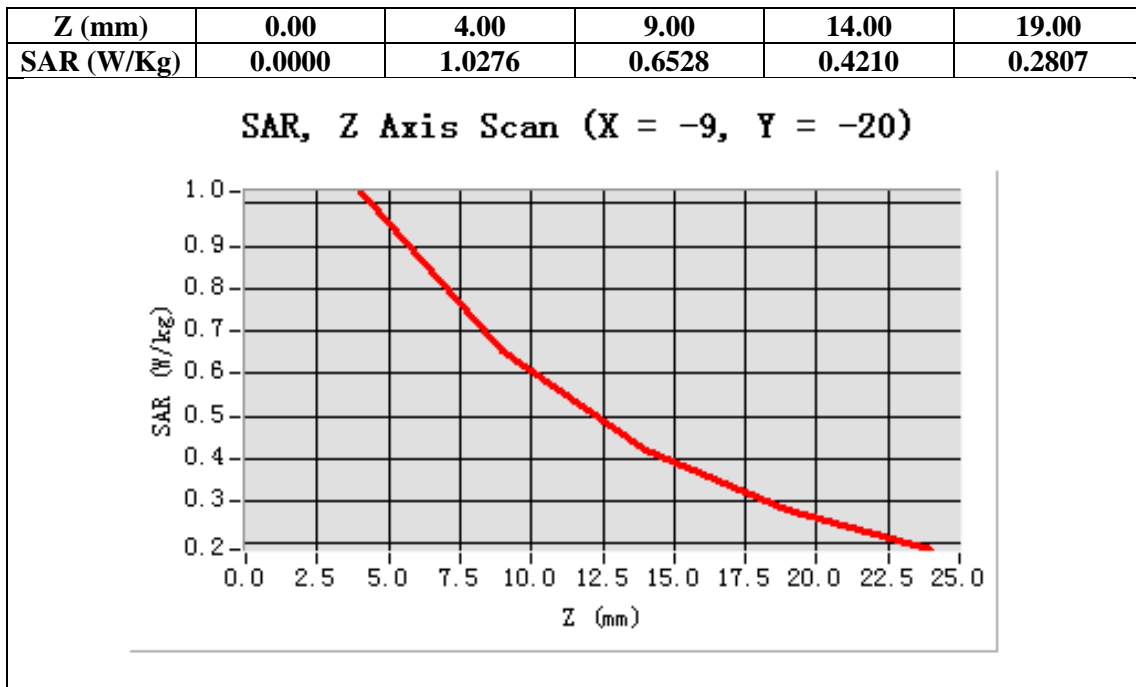



Test Laboratory: AGC Lab  
GSM 850 High- Body- Back <SIM 1>  
DUT: mobile phone; Type: AM503

Date: Oct.16,2014

Communication System: Generic GSM; Communication System Band: GSM 835; Duty Cycle: 1:8.3; Conv.F=5.48;  
Frequency: 848.8 MHz; Medium parameters used:  $f = 835$  MHz;  $\sigma = 0.97$ mho/m;  $\epsilon_r = 55.23$ ;  $\rho = 1000$  kg/m<sup>3</sup> ;  
Phantom section: Flat Section  
Ambient temperature (°C): 21.0, Liquid temperature (°C): 21.0

SATIMO Configuration:

- Probe: SSE5; Calibrated: 01/12/2014; Serial No.:SN 22/12 EP159
- Sensor-Surface: 4mm (Mechanical Surface Detection)
- Phantom: Flat Phantom; Type: Elliptical Phantom
- Measurement SW: OpenSAR V4\_02\_01

Configuration/GSM 850 High -Body-Back/Area Scan: Measurement grid: dx=8mm, dy=8mm  
Configuration/GSM 850 High -Body-Back/Zoom Scan: Measurement grid: dx=8mm,dy=8mm, dz=5mm;

Area Scan	surf_sam_plan.txt
ZoomScan	5x5x7,dx=8mm dy=8mm dz=5mm,Very fast
Phantom	Validation plane
Device Position	Body Back
Band	GSM 850
Channels	High
Signal	TDMA (Crest factor: 8.0)

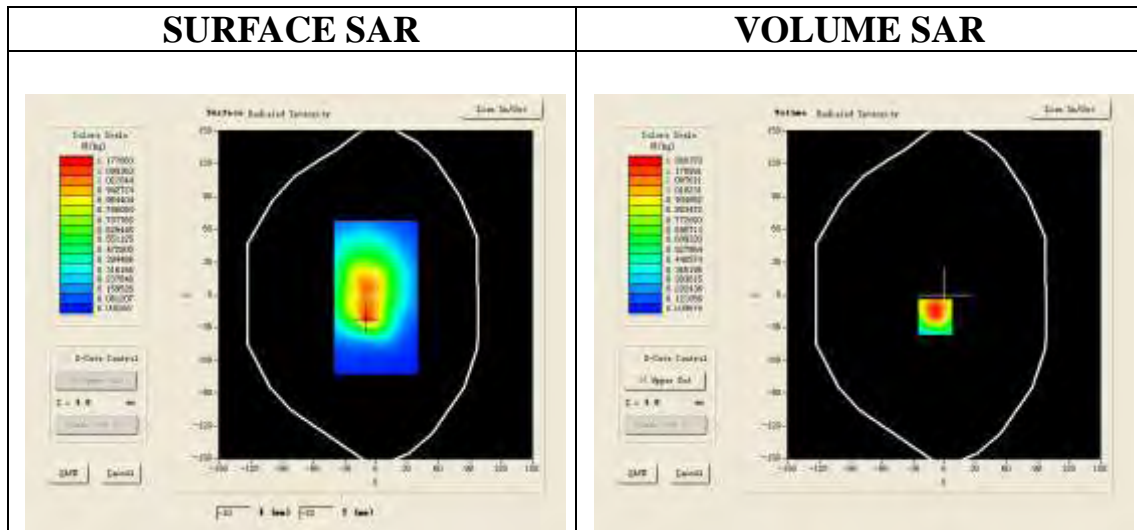

Maximum location: X=-9.00, Y=-20.00

SAR 10g (W/Kg)	0.701768
SAR 1g (W/Kg)	1.192712

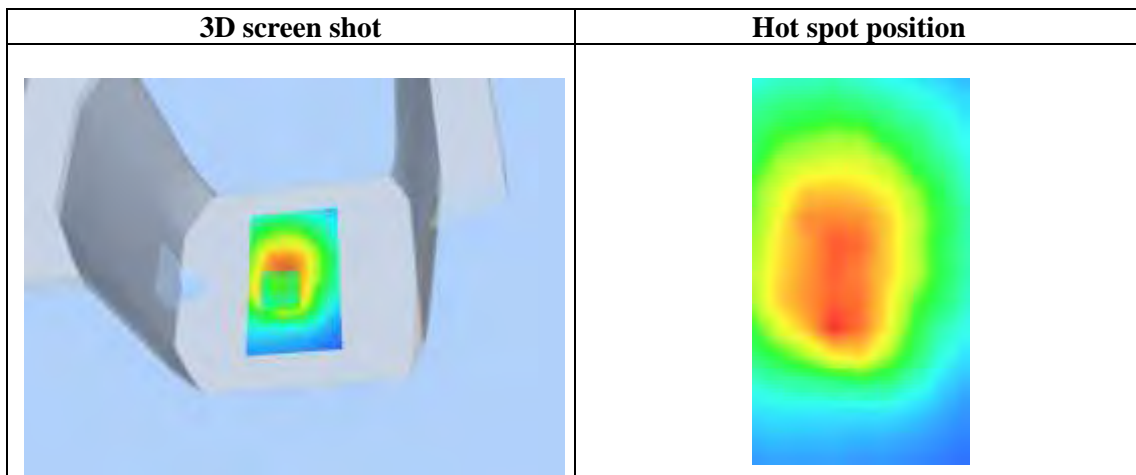
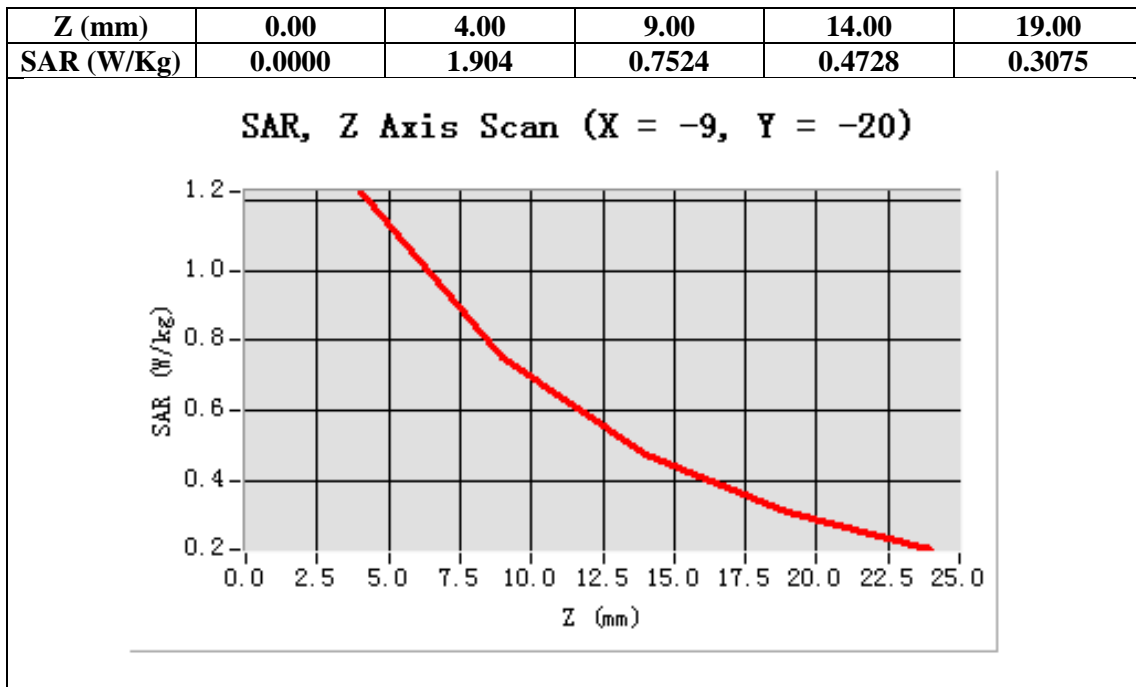

Test Laboratory: AGC Lab  
GSM 850 Mid- Body- Front (MS) <SIM 1>  
DUT: mobile phone; Type: AM503

Date: Oct.16,2014

Communication System: Generic GSM; Communication System Band: GSM 835; Duty Cycle: 1:8.3; Conv.F=5.48;  
Frequency: 836.6 MHz; Medium parameters used:  $f = 835$  MHz;  $\sigma = 0.98$ mho/m;  $\epsilon_r = 55.10$ ;  $\rho = 1000$  kg/m<sup>3</sup> ;  
Phantom section: Flat Section  
Ambient temperature (°C): 21.0, Liquid temperature (°C): 21.0

SATIMO Configuration:

- Probe: SSE5; Calibrated: 01/12/2014; Serial No.:SN 22/12 EP159
- Sensor-Surface: 4mm (Mechanical Surface Detection)
- Phantom: Flat Phantom; Type: Elliptical Phantom
- Measurement SW: OpenSAR V4\_02\_01

Configuration/GSM 850 Mid-Body- Front /Area Scan: Measurement grid: dx=8mm, dy=8mm  
Configuration/GSM 850 Mid-Body- Front Zoom Scan: Measurement grid: dx=8mm,dy=8mm, dz=5mm;

Area Scan	surf_sam_plan.txt
ZoomScan	5x5x7,dx=8mm dy=8mm dz=5mm,Very fast
Phantom	Validation plane
Device Position	Body Front
Band	GSM 850
Channels	Middle
Signal	TDMA (Crest factor: 8.0)

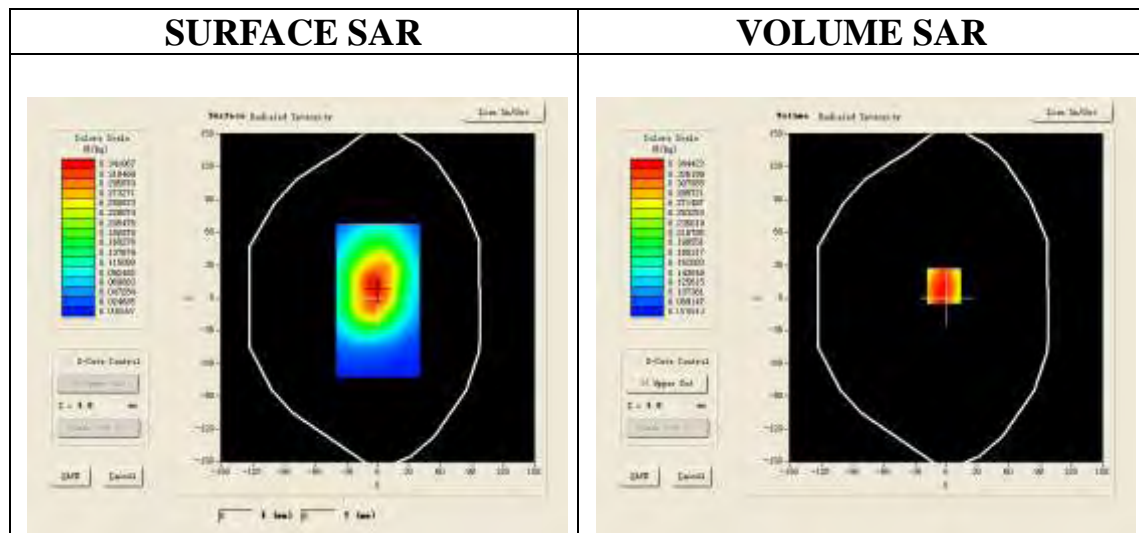

Maximum location: X=-2.00, Y=11.00

SAR 10g (W/Kg)	0.241004
SAR 1g (W/Kg)	0.332786

Z (mm)	0.00	4.00	9.00	14.00	19.00
SAR (W/Kg)	0.0000	0.3437	0.2600	0.1971	0.1496

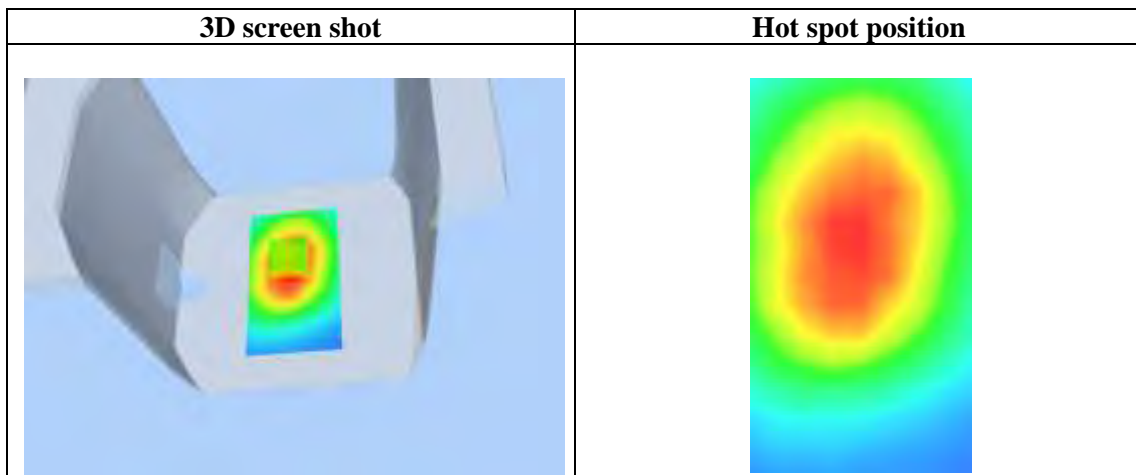
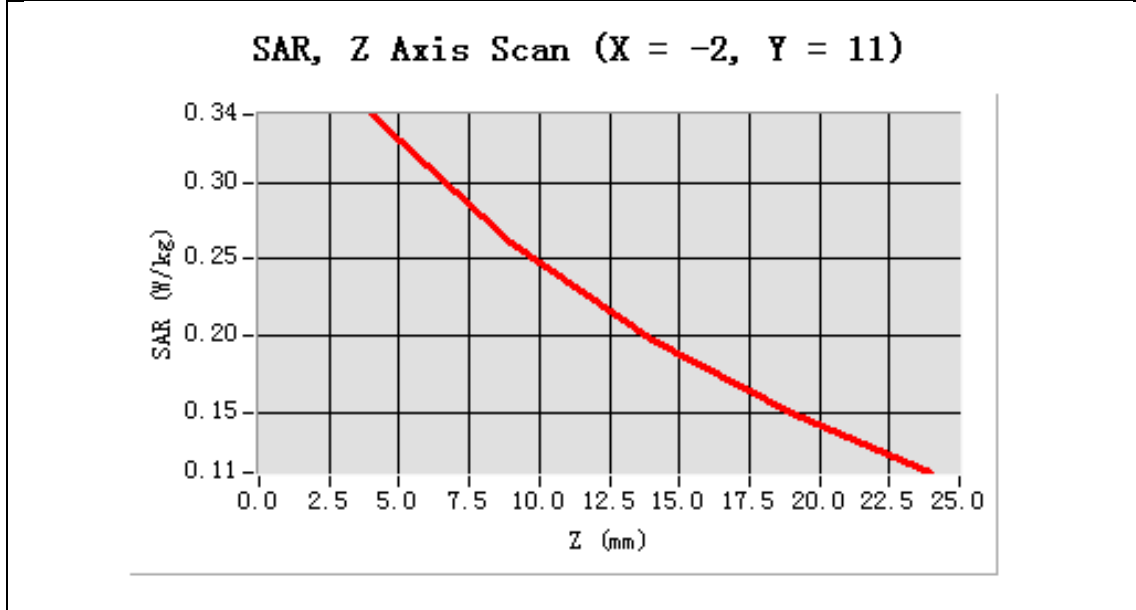

Test Laboratory: AGC Lab  
PCS 1900 Mid-Touch-Left <SIM 1>  
DUT: mobile phone; Type: AM503

Date: Oct.16,2014

Communication System: Generic GSM; Communication System Band: PCS 1900; Duty Cycle: 1:8.3; Conv.F=4.51;  
Frequency: 1880 MHz; Medium parameters used:  $f = 1900$  MHz;  $\sigma = 1.42$  mho/m;  $\epsilon_r = 40.46$ ;  $\rho = 1000$  kg/m<sup>3</sup> ;  
Phantom section: Left Section  
Ambient temperature (°C): 21.0, Liquid temperature (°C): 21.0

SATIMO Configuration:

- Probe: SSE5; Calibrated: 01/12/2014; Serial No.:SN 22/12 EP159
- Sensor-Surface: 4mm (Mechanical Surface Detection)
- Phantom: Flat Phantom; Type: Elliptical Phantom
- Measurement SW: OpenSAR V4\_02\_01

Configuration/PCS1900 Mid-Touch-Left/Area Scan: Measurement grid: dx=8mm, dy=8mm  
Configuration/PCS1900 Mid-Touch-Left/Zoom Scan: Measurement grid: dx=8mm,dy=8mm, dz=5mm;

Area Scan	sam_direct_droit2_surf8mm.txt
ZoomScan	5x5x7,dx=8mm dy=8mm dz=5mm,Very fast
Phantom	Left head
Device Position	Cheek
Band	PCS 1900
Channels	Middle
Signal	TDMA (Crest factor: 8.0)

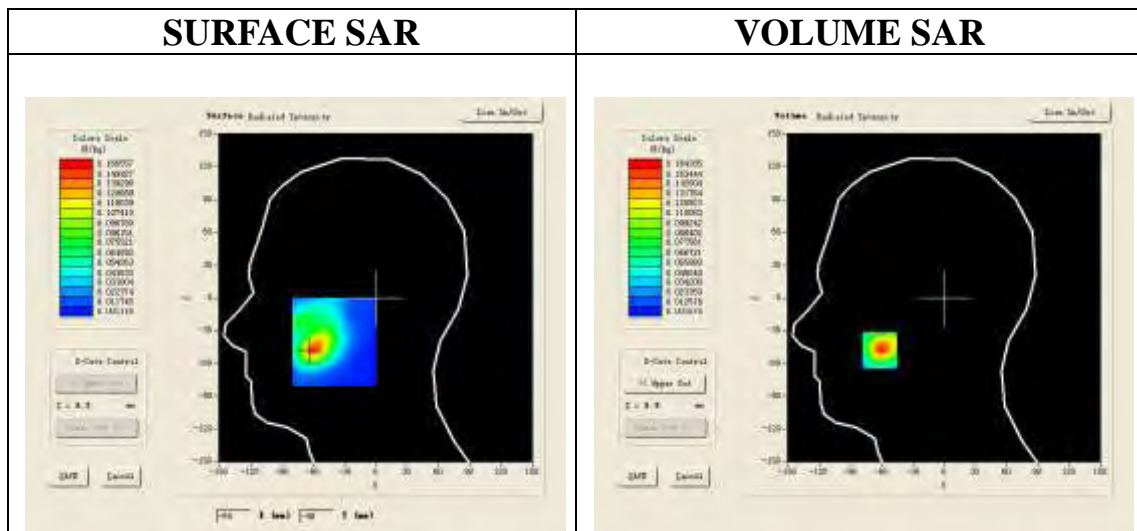

Maximum location: X=-62.00, Y=-48.00

SAR 10g (W/Kg)	0.076784
SAR 1g (W/Kg)	0.153708

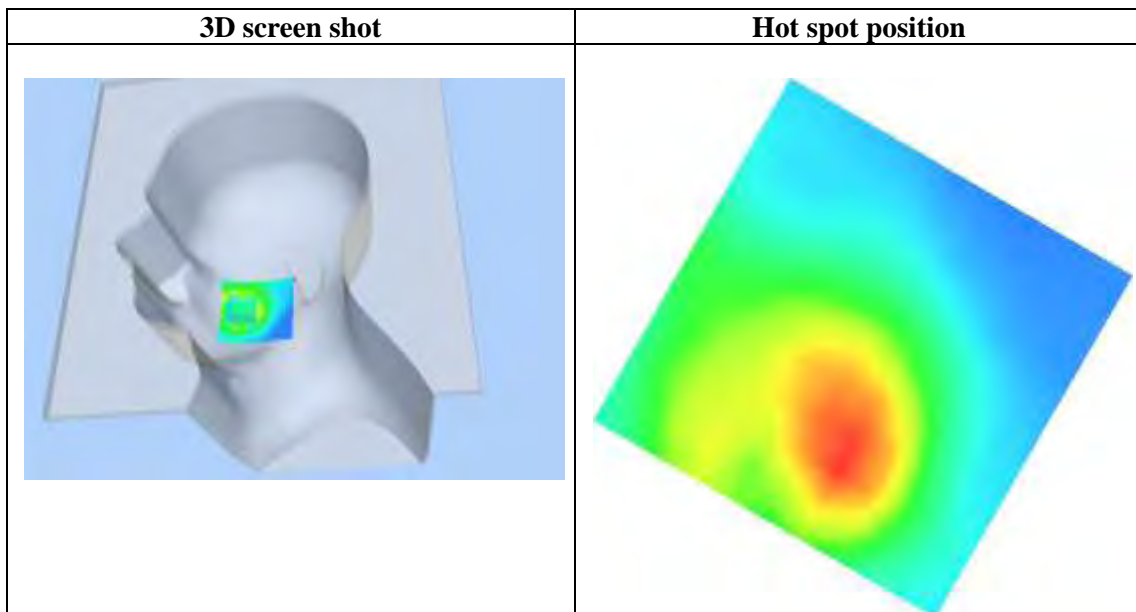
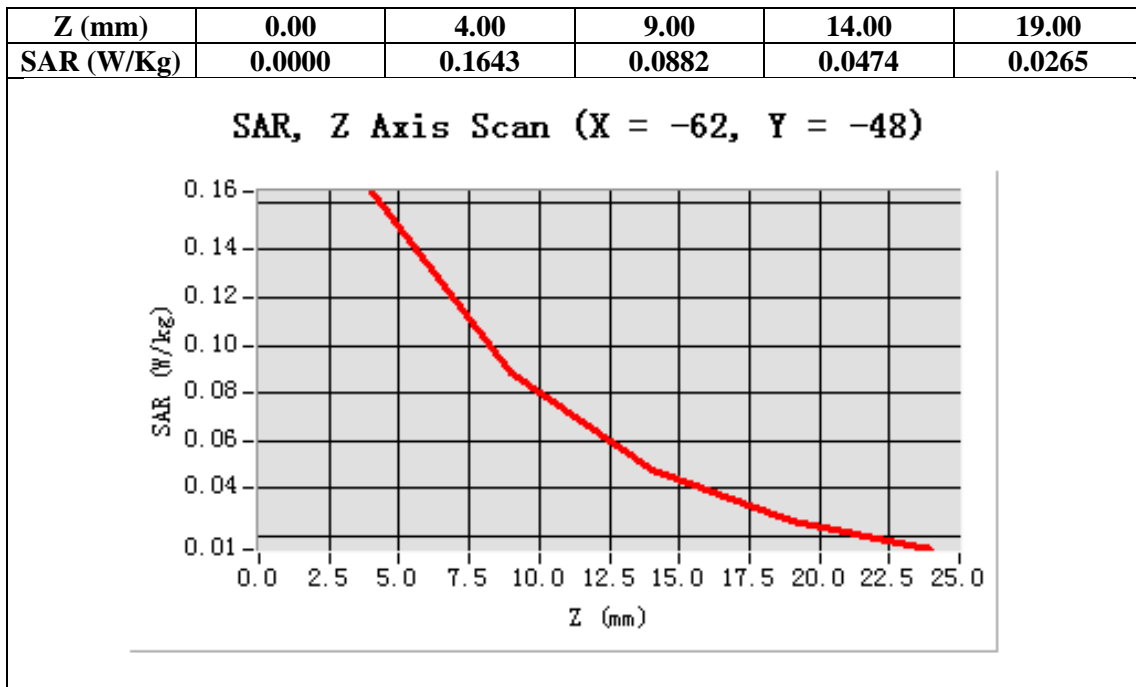

Test Laboratory: AGC Lab  
PCS 1900 Mid-Tilt-Left <SIM 1>  
DUT: mobile phone; Type: AM503

Date: Oct.16,2014

Communication System: Generic GSM; Communication System Band: PCS 1900; Duty Cycle: 1:8.3; Conv.F=4.51;  
Frequency: 1880 MHz; Medium parameters used:  $f = 1900$  MHz;  $\sigma = 1.42$  mho/m;  $\epsilon_r = 40.46$ ;  $\rho = 1000$  kg/m<sup>3</sup> ;  
Phantom section: Left Section  
Ambient temperature (°C): 21.0, Liquid temperature (°C): 21.0

SATIMO Configuration:

- Probe: SSE5; Calibrated: 01/12/2014; Serial No.:SN 22/12 EP159
- Sensor-Surface: 4mm (Mechanical Surface Detection)
- Phantom: Flat Phantom; Type: Elliptical Phantom
- Measurement SW: OpenSAR V4\_02\_01

Configuration/PCS1900 Mid-Tilt-Left/Area Scan: Measurement grid: dx=8mm, dy=8mm

Configuration/PCS1900 Mid-Tilt-Left/Zoom Scan: Measurement grid: dx=8mm,dy=8mm,dz=5mm;

Area Scan	sam_direct_droit2_surf8mm.txt
ZoomScan	5x5x7,dx=8mm dy=8mm dz=5mm,Very fast
Phantom	Left head
Device Position	Tilt
Band	PCS 1900
Channels	Middle
Signal	TDMA (Crest factor: 8.0)

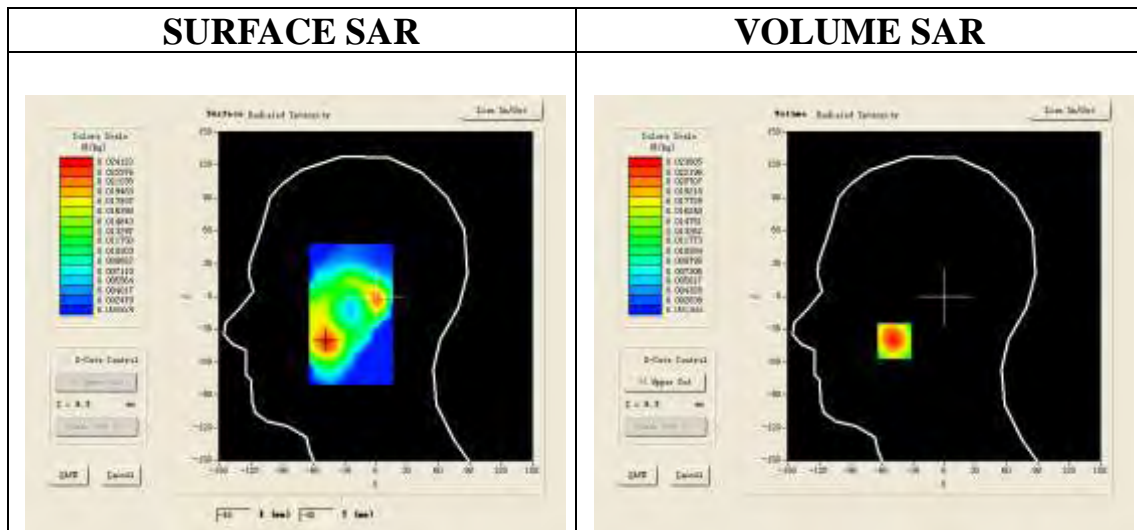

Maximum location: X=-48.00, Y=-41.00

SAR 10g (W/Kg)	0.012731
SAR 1g (W/Kg)	0.022499

Z (mm)	0.00	4.00	9.00	14.00	19.00
SAR (W/Kg)	0.0000	0.0237	0.0130	0.0074	0.0046

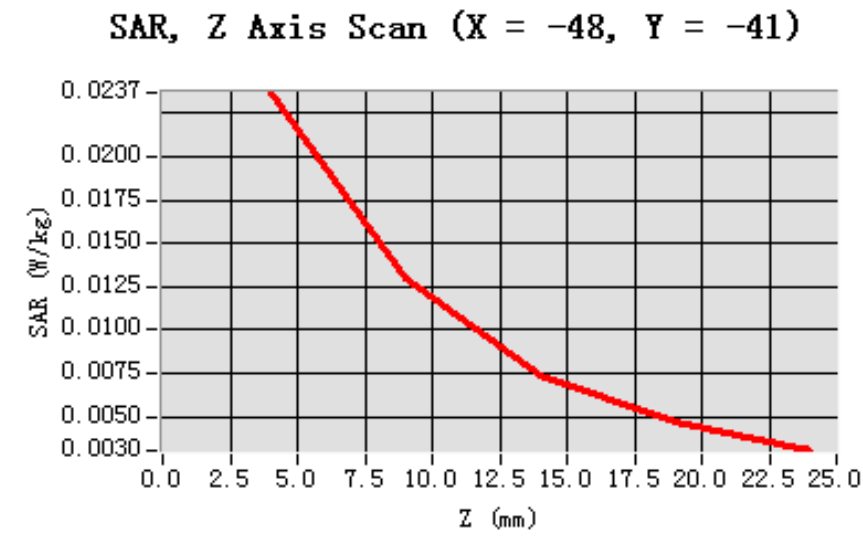

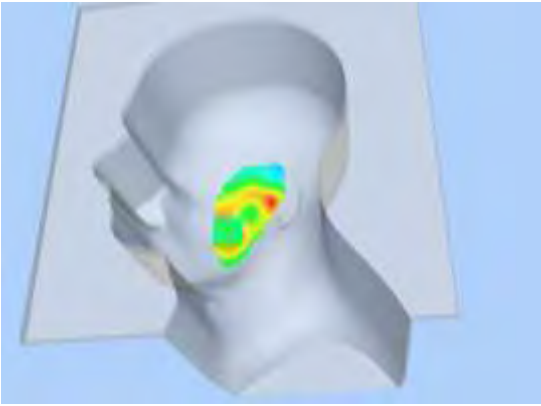
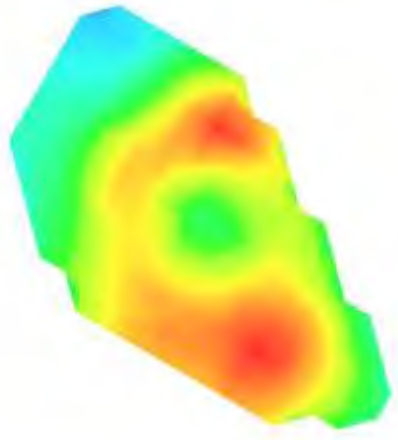
3D screen shot	Hot spot position
	



Test Laboratory: AGC Lab  
PCS 1900 Mid-Touch-Right <SIM 1>  
DUT: mobile phone; Type: AM503

Date: Oct.16,2014

Communication System: Generic GSM; Communication System Band: PCS 1900; Duty Cycle: 1:8.3; Conv.F=4.51;  
Frequency: 1880 MHz; Medium parameters used:  $f = 1900$  MHz;  $\sigma = 1.42$  mho/m;  $\epsilon_r = 40.46$ ;  $\rho = 1000$  kg/m<sup>3</sup> ;  
Phantom section: Right Section  
Ambient temperature (°C): 21.0, Liquid temperature (°C): 21.0

SATIMO Configuration:

- Probe: SSE5; Calibrated: 01/12/2014; Serial No.:SN 22/12 EP159
- Sensor-Surface: 4mm (Mechanical Surface Detection)
- Phantom: Flat Phantom; Type: Elliptical Phantom
- Measurement SW: OpenSAR V4\_02\_01

Configuration/PCS1900 Mid-Touch-Right/Area Scan: Measurement grid: dx=8mm, dy=8mm

Configuration/PCS1900 Mid-Touch-Right/Zoom Scan: Measurement grid: dx=8mm,dy=8mm, dz=5mm;

Area Scan	sam_direct_droit2_surf8mm.txt
ZoomScan	5x5x7,dx=8mm dy=8mm dz=5mm,Very fast
Phantom	Right head
Device Position	Cheek
Band	PCS 1900
Channels	Middle
Signal	TDMA (Crest factor: 8.0)

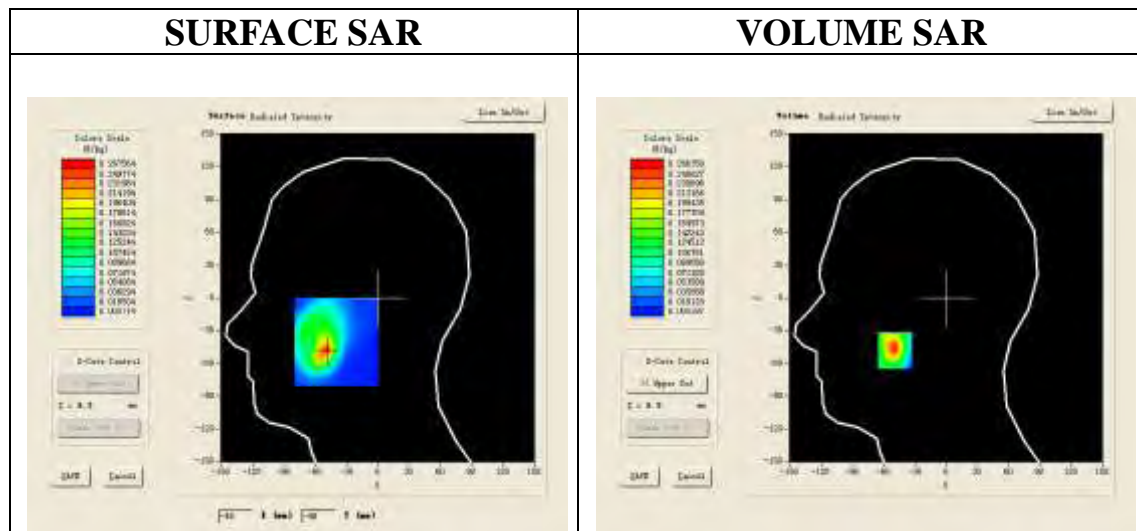

Maximum location: X=-49.00, Y=-48.00

SAR 10g (W/Kg)	0.112919
SAR 1g (W/Kg)	0.247793

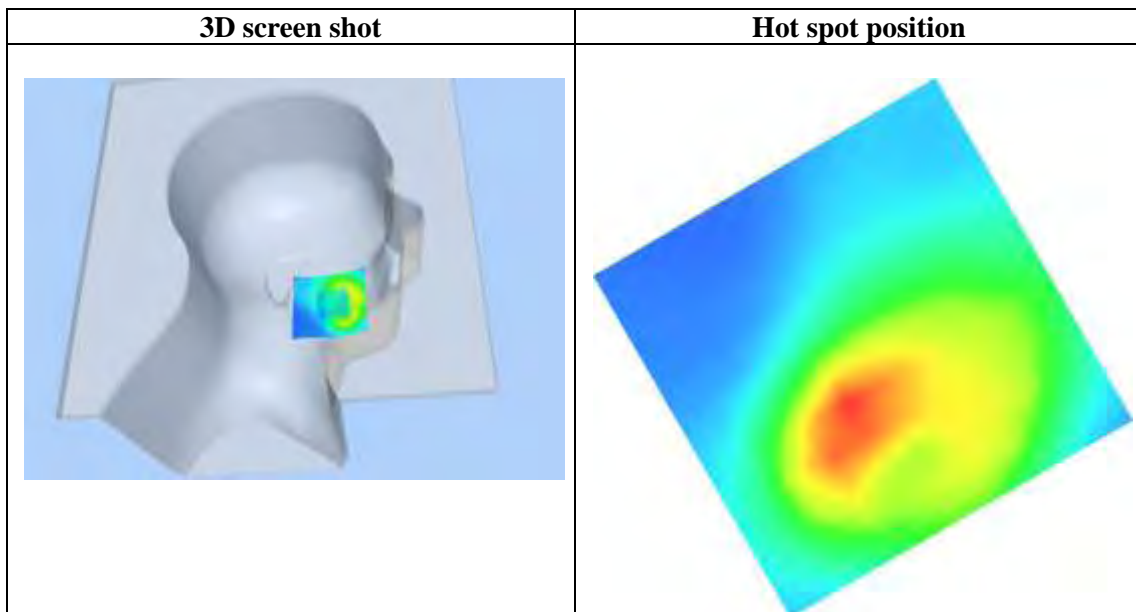
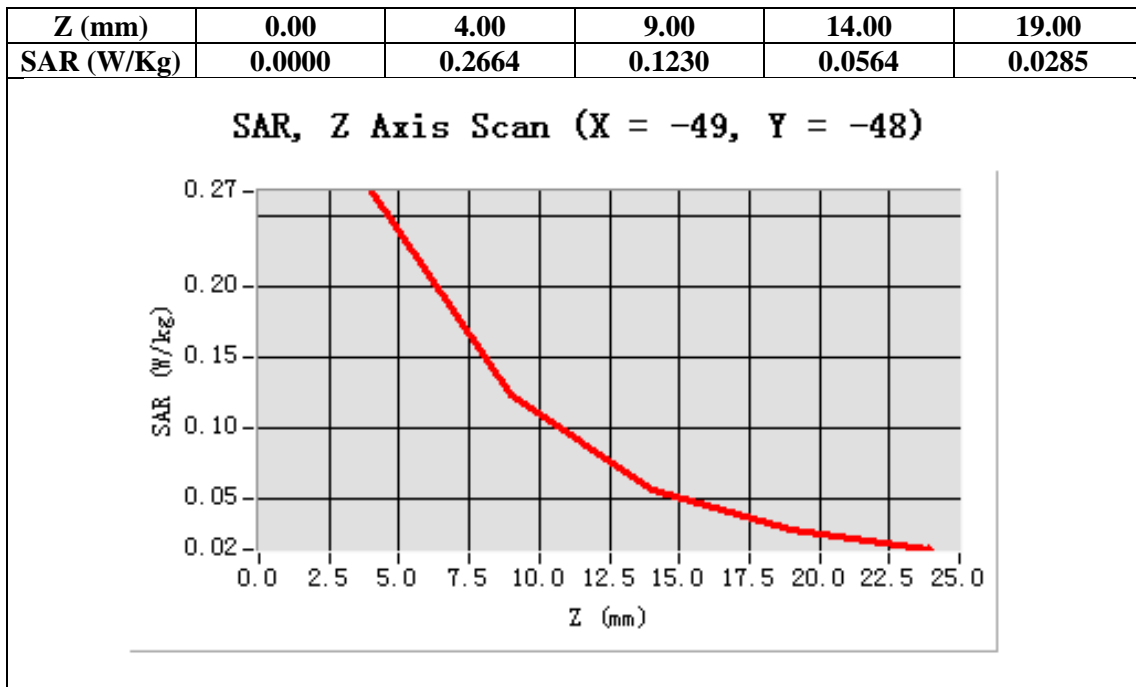

Test Laboratory: AGC Lab  
PCS 1900 Mid-Tilt-Right <SIM 1>  
DUT: mobile phone; Type: AM503

Date: Oct.16,2014

Communication System: Generic GSM; Communication System Band: PCS 1900; Duty Cycle: 1:8.3; Conv.F=4.51;  
Frequency: 1880 MHz; Medium parameters used:  $f = 1900$  MHz;  $\sigma = 1.42$  mho/m;  $\epsilon_r = 40.46$ ;  $\rho = 1000$  kg/m<sup>3</sup> ;  
Phantom section: Right Section  
Ambient temperature (°C): 21.0, Liquid temperature (°C): 21.0

SATIMO Configuration:

- Probe: SSE5; Calibrated: 01/12/2014; Serial No.:SN 22/12 EP159
- Sensor-Surface: 4mm (Mechanical Surface Detection)
- Phantom: Flat Phantom; Type: Elliptical Phantom
- Measurement SW: OpenSAR V4\_02\_01

Configuration/PCS1900 Mid-Tilt-Right/Area Scan: Measurement grid: dx=8mm, dy=8mm  
Configuration/PCS1900 Mid-Tilt-Right/Zoom Scan: Measurement grid: dx=8mm,dy=8mm, dz=5mm;

Area Scan	sam_direct_droit2_surf8mm.txt
ZoomScan	5x5x7,dx=8mm dy=8mm dz=5mm,Very fast
Phantom	Right head
Device Position	Tilt
Band	PCS 1900
Channels	Middle
Signal	TDMA (Crest factor: 8.0)

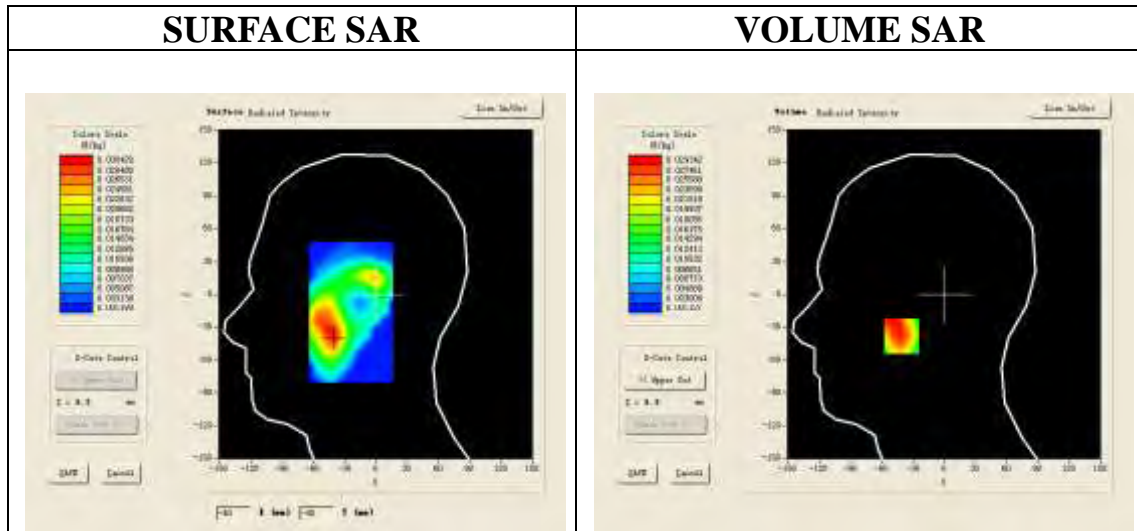

Maximum location: X=-41.00, Y=-38.00

SAR 10g (W/Kg)	0.016512
SAR 1g (W/Kg)	0.027981

Z (mm)	0.00	4.00	9.00	14.00	19.00
SAR (W/Kg)	0.0000	0.0289	0.0173	0.0101	0.0058

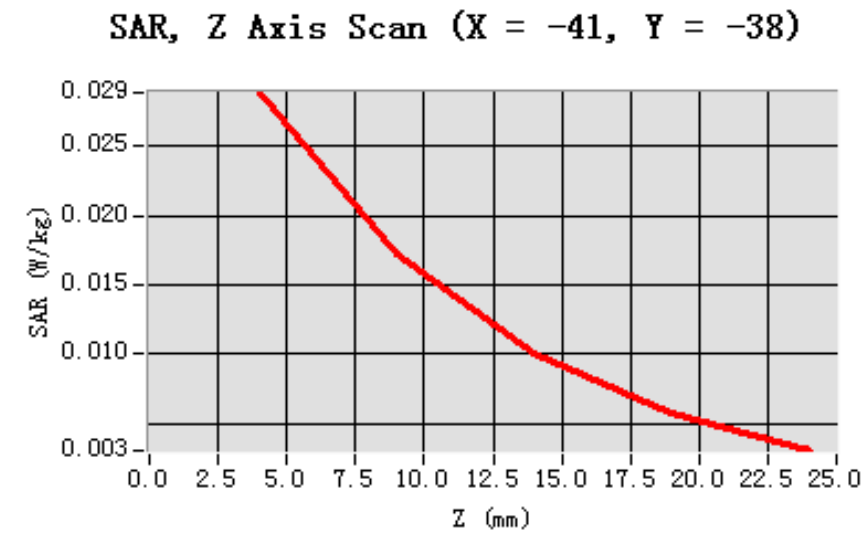

3D screen shot	Hot spot position

Test Laboratory: AGC Lab  
PCS 1900 Mid-Touch-Right <SIM 2>  
DUT: mobile phone; Type: AM503

Date: Oct.16,2014

Communication System: Generic GSM; Communication System Band: PCS 1900; Duty Cycle: 1:8.3; Conv.F=4.51;  
Frequency: 1880 MHz; Medium parameters used:  $f = 1900$  MHz;  $\sigma = 1.42$  mho/m;  $\epsilon_r = 40.46$ ;  $\rho = 1000$  kg/m<sup>3</sup> ;  
Phantom section: Right Section  
Ambient temperature (°C): 21.0, Liquid temperature (°C): 21.0

SATIMO Configuration:

- Probe: SSE5; Calibrated: 01/12/2014; Serial No.:SN 22/12 EP159
- Sensor-Surface: 4mm (Mechanical Surface Detection)
- Phantom: Flat Phantom; Type: Elliptical Phantom
- Measurement SW: OpenSAR V4\_02\_01

Configuration/PCS1900 Mid-Touch-Right/Area Scan: Measurement grid: dx=8mm, dy=8mm

Configuration/PCS1900 Mid-Touch-Right/Zoom Scan: Measurement grid: dx=8mm,dy=8mm, dz=5mm;

Area Scan	sam_direct_droit2_surf8mm.txt
ZoomScan	5x5x7,dx=8mm dy=8mm dz=5mm,Very fast
Phantom	Right head
Device Position	Cheek
Band	PCS 1900
Channels	Middle
Signal	TDMA (Crest factor: 8.0)

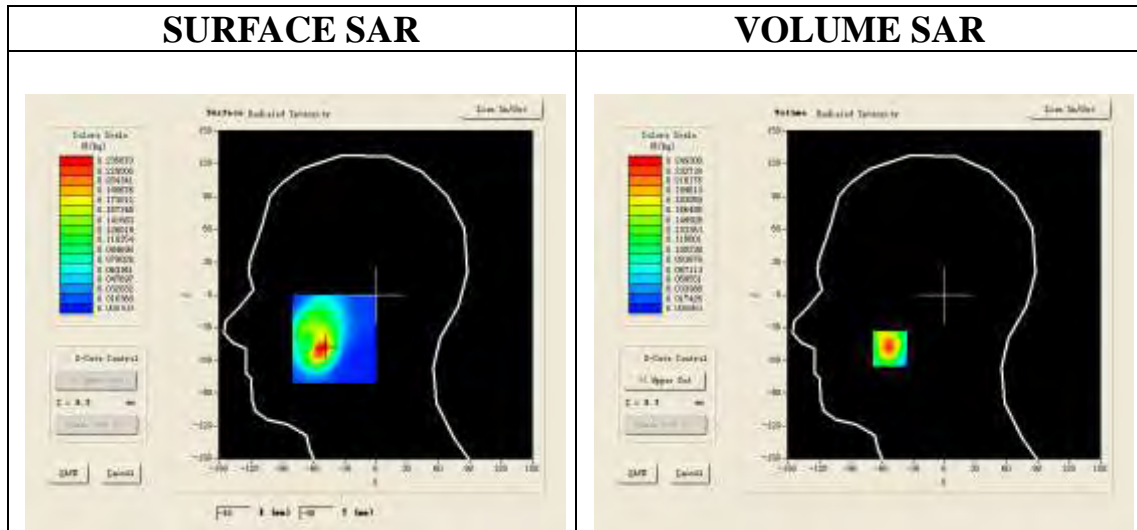

Maximum location: X=-52.00, Y=-49.00

SAR 10g (W/Kg)	0.111983
SAR 1g (W/Kg)	0.229618

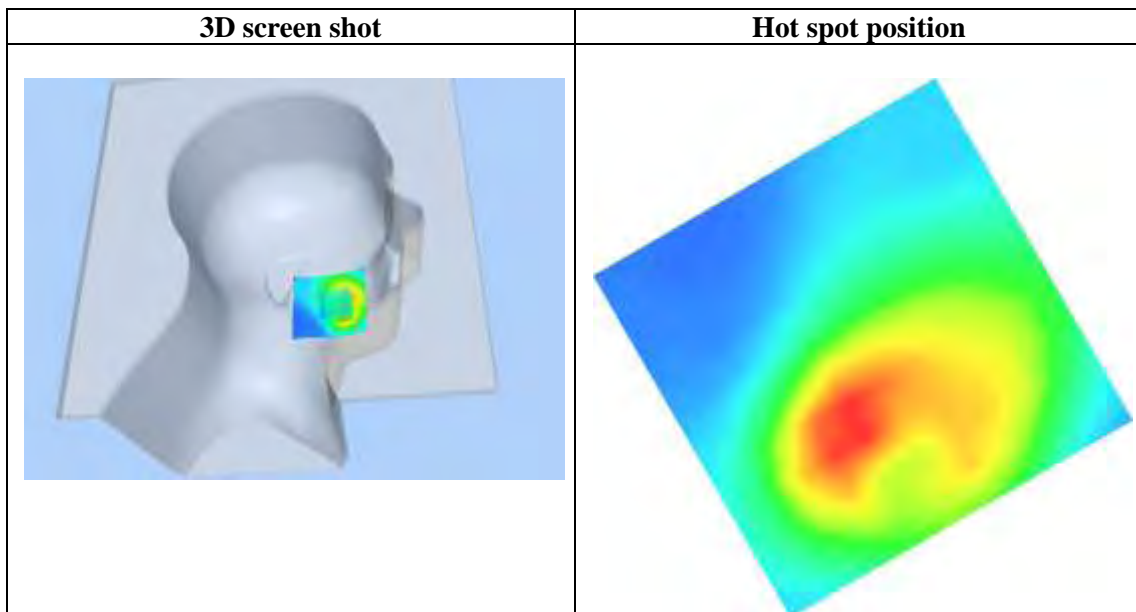
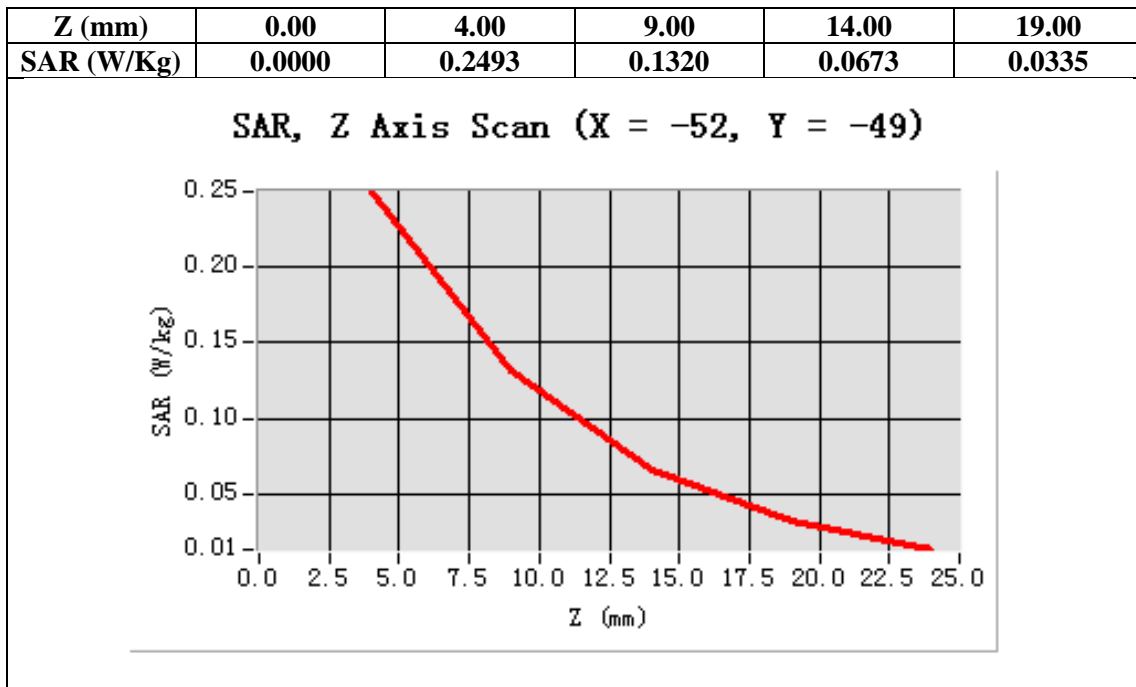

Test Laboratory: AGC Lab  
PCS 1900 Mid-Body- Back <SIM 1>  
DUT: mobile phone; Type: AM503

Date: Oct.16,2014

Communication System: Generic GSM; Communication System Band: PCS 1900; Duty Cycle: 1:8.3; Conv.F=4.45;  
Frequency: 1880 MHz; Medium parameters used:  $f = 1900$  MHz;  $\sigma = 1.49$  mho/m;  $\epsilon_r = 53.21$ ;  $\rho = 1000$  kg/m<sup>3</sup> ;  
Phantom section: Flat Section  
Ambient temperature (°C): 21.0, Liquid temperature (°C): 21.0

SATIMO Configuration:

- Probe: SSE5; Calibrated: 01/12/2014; Serial No.:SN 22/12 EP159
- Sensor-Surface: 4mm (Mechanical Surface Detection)
- Phantom: Flat Phantom; Type: Elliptical Phantom
- Measurement SW: OpenSAR V4\_02\_01

Configuration/PCS1900 Mid-Body-Back/Area Scan: Measurement grid: dx=8mm, dy=8mm  
Configuration/PCS1900 Mid-Body-Back/Zoom Scan: Measurement grid: dx=8mm,dy=8mm, dz=5mm;

Area Scan	surf_sam_plan.txt
ZoomScan	5x5x7,dx=8mm dy=8mm dz=5mm,Very fast
Phantom	Validation plane
Device Position	Body Back
Band	PCS 1900
Channels	Middle
Signal	TDMA (Crest factor: 8.0)

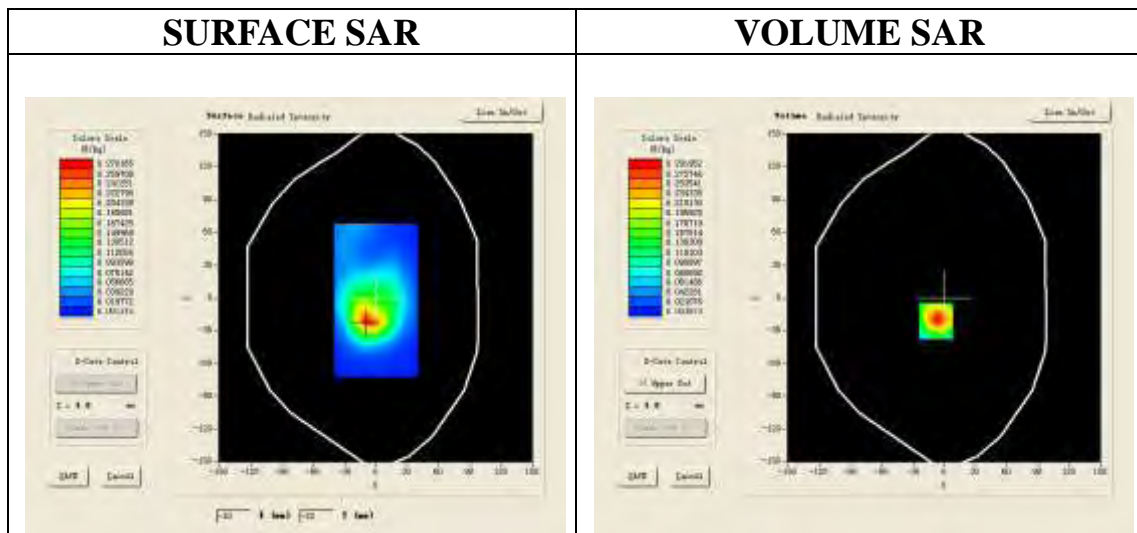

Maximum location: X=-8.00, Y=-21.00

SAR 10g (W/Kg)	0.146342
SAR 1g (W/Kg)	0.284653

Z (mm)	0.00	4.00	9.00	14.00	19.00
SAR (W/Kg)	0.0000	0.2920	0.1556	0.0820	0.0444

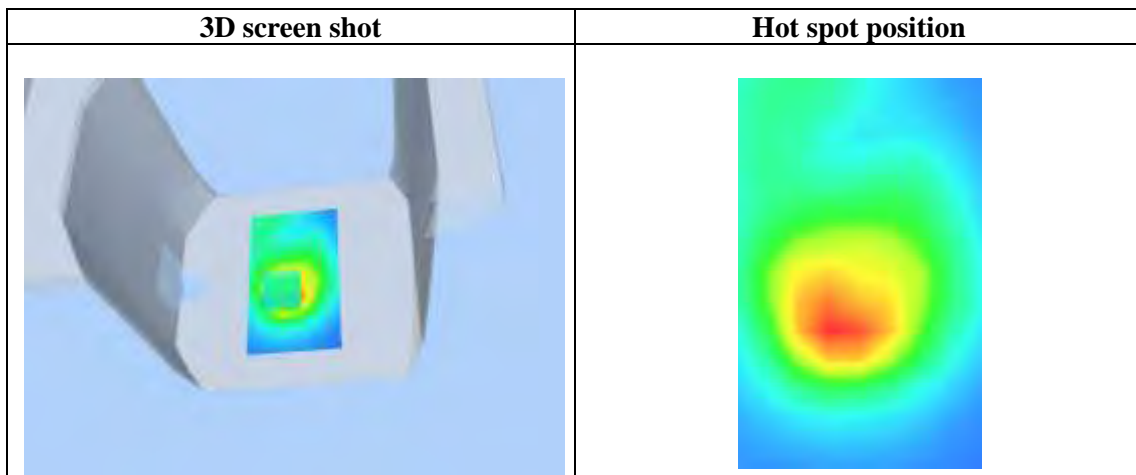
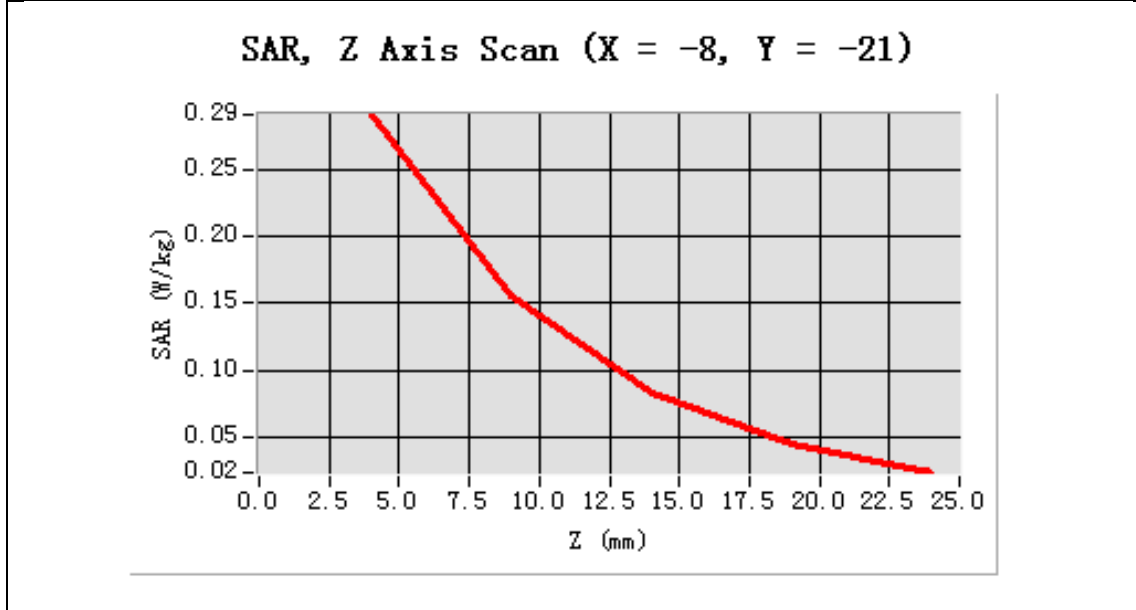



Test Laboratory: AGC Lab  
PCS 1900 Mid-Body -Front (MS) <SIM 1>  
DUT: mobile phone; Type: AM503

Date: Oct.16,2014

Communication System: Generic GSM; Communication System Band: PCS 1900; Duty Cycle: 1:8.3; Conv.F=4.45;  
Frequency: 1880 MHz; Medium parameters used:  $f = 1900$  MHz;  $\sigma = 1.49$  mho/m;  $\epsilon_r = 53.21$ ;  $\rho = 1000$  kg/m<sup>3</sup> ;  
Phantom section: Flat Section  
Ambient temperature (°C): 21.0, Liquid temperature (°C): 21.0

SATIMO Configuration:

- Probe: SSE5; Calibrated: 01/12/2014; Serial No.:SN 22/12 EP159
- Sensor-Surface: 4mm (Mechanical Surface Detection)
- Phantom: Flat Phantom; Type: Elliptical Phantom
- Measurement SW: OpenSAR V4\_02\_01

Configuration/PCS1900 Mid-Body- Front /Area Scan: Measurement grid: dx=8mm, dy=8mm  
Configuration/PCS1900 Mid-Body- Front /Zoom Scan: Measurement grid: dx=8mm,dy=8mm, dz=5mm;

Area Scan	surf_sam_plan.txt
ZoomScan	5x5x7,dx=8mm dy=8mm dz=5mm,Very fast
Phantom	Validation plane
Device Position	Body Front
Band	PCS 1900
Channels	Middle
Signal	TDMA (Crest factor: 8.0)

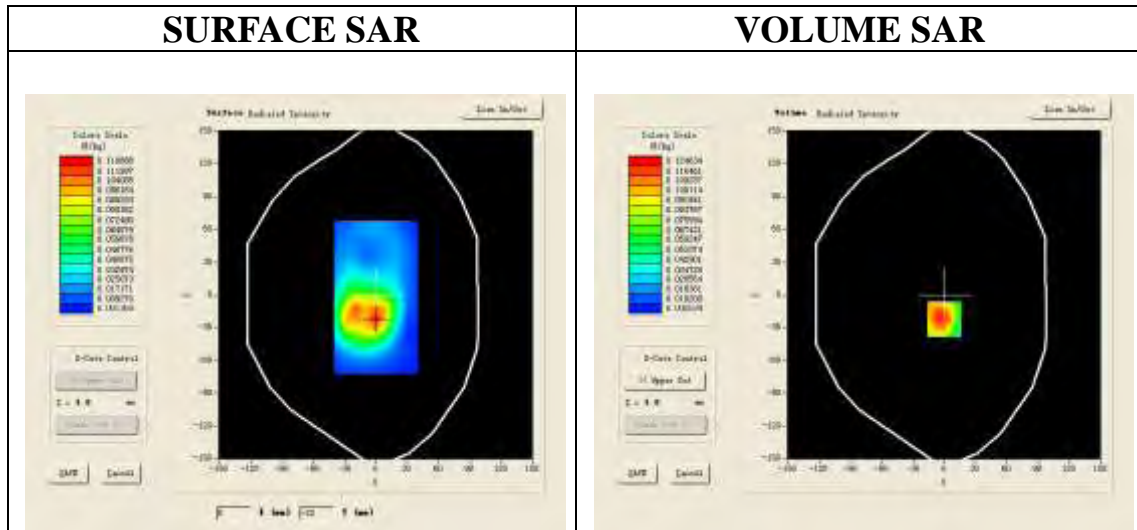

Maximum location: X=0.00, Y=-22.00

SAR 10g (W/Kg)	0.065002
SAR 1g (W/Kg)	0.122726

Z (mm)	0.00	4.00	9.00	14.00	19.00
SAR (W/Kg)	0.0000	0.1246	0.0654	0.0338	0.0179

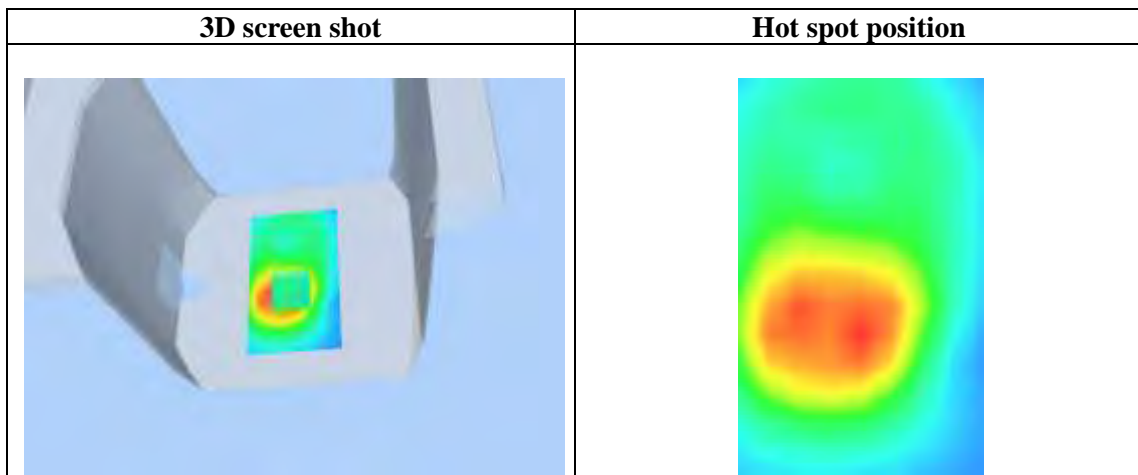
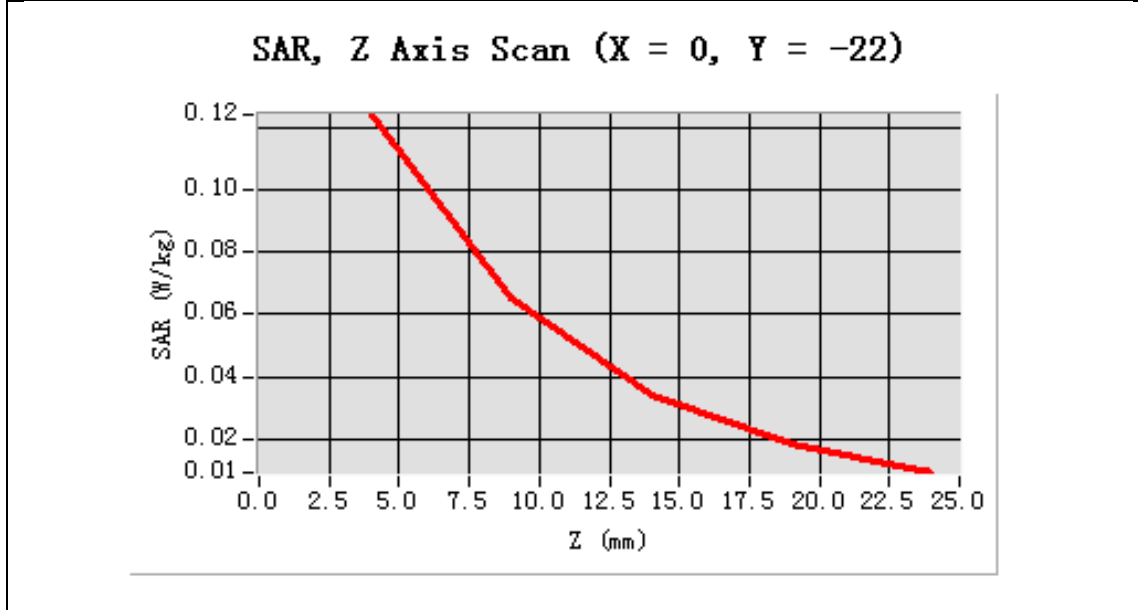

Test Laboratory: AGC Lab  
WCDMA Band II Mid-Touch-Left (RMC)  
DUT: mobile phone; Type: AM503

Date: Oct.16,2014

Communication System: UMTS; Communication System Band: Band II UTRA/FDD ;Duty Cycle:1:1;Conv.F=4.51  
Frequency: 1880 MHz; Medium parameters used:  $f = 1900$  MHz;  $\sigma = 1.42$  mho/m;  $\epsilon_r = 40.46$ ;  $\rho = 1000$  kg/m<sup>3</sup> ;  
Phantom section: Left Section  
Ambient temperature (°C):21, Liquid temperature (°C):21

SATIMO Configuration:

- Probe: SSE5; Calibrated: 01/12/2014; Serial No.:SN 22/12 EP159
- Sensor-Surface: 4mm (Mechanical Surface Detection)
- Phantom: Flat Phantom; Type: Elliptical Phantom
- Measurement SW: OpenSAR V4\_02\_01

Configuration/ WCDMA Band II Mid-Touch-Left/Area Scan: Measurement grid: dx=8mm, dy=8mm

Configuration/ WCDMA Band II Mid-Touch-Left/Zoom Scan: Measurement grid:dx=8mm,dy=8mm,dz=5mm;

Area Scan	sam_direct_droit2_surf8mm.txt
ZoomScan	5x5x7,dx=8mm dy=8mm dz=5mm,Very fast
Phantom	Left head
Device Position	Cheek
Band	WCDMA Band II
Channels	Middle
Signal	CDMA (Crest factor: 1.0)

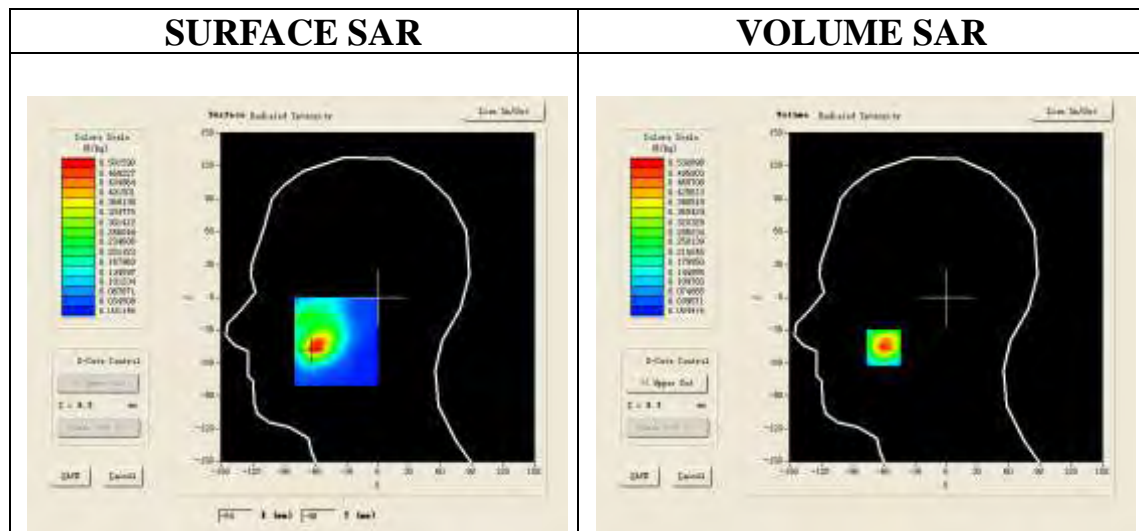

Maximum location: X=-60.00, Y=-46.00

<b>SAR 10g (W/Kg)</b>	0.244386
<b>SAR 1g (W/Kg)</b>	0.492359

Z (mm)	0.00	4.00	9.00	14.00	19.00
SAR (W/Kg)	0.0000	0.5309	0.2859	0.1529	0.0844

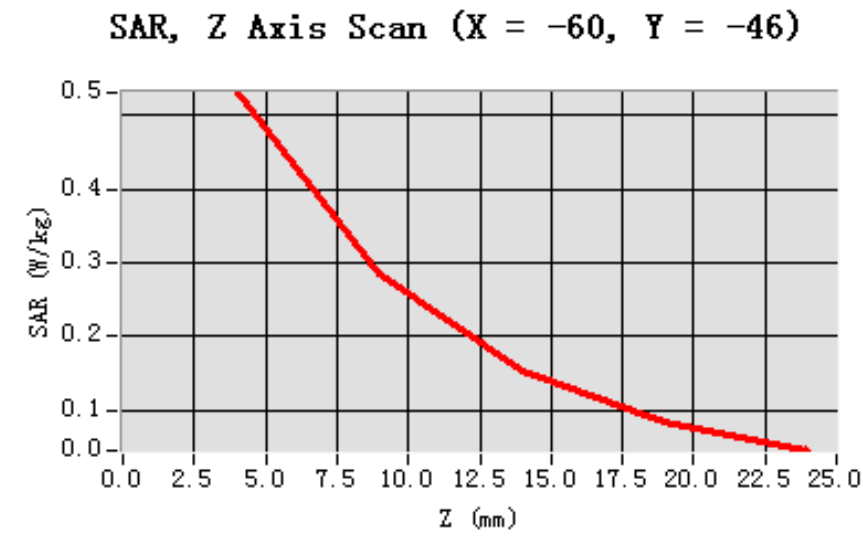

3D screen shot	Hot spot position

Test Laboratory: AGC Lab  
WCDMA Band II Mid-Tilt-Left (RMC)  
DUT: mobile phone; Type: AM503

Date: Oct.16,2014

Communication System: UMTS; Communication System Band: Band II UTRA/FDD ;Duty Cycle:1:1; Conv.F=4.51  
Frequency: 1880 MHz; Medium parameters used:  $f = 1900$  MHz;  $\sigma = 1.42$  mho/m;  $\epsilon_r = 40.46$ ;  $\rho = 1000$  kg/m<sup>3</sup> ;  
Phantom section: Left Section  
Ambient temperature (°C):21, Liquid temperature (°C):21

SATIMO Configuration:

- Probe: SSE5; Calibrated: 01/12/2014; Serial No.:SN 22/12 EP159
- Sensor-Surface: 4mm (Mechanical Surface Detection)
- Phantom: Flat Phantom; Type: Elliptical Phantom
- Measurement SW: OpenSAR V4\_02\_01

Configuration/ WCDMA Band II Mid-Tilt-Left/Area Scan: Measurement grid: dx=8mm, dy=8mm

Configuration/ WCDMA Band II Mid-Tilt-Left/Zoom Scan: Measurement grid: dx=8mm,dy=8mm, dz=5mm;

Area Scan	sam_direct_droit2_surf8mm.txt
ZoomScan	5x5x7,dx=8mm dy=8mm dz=5mm,Very fast
Phantom	Left head
Device Position	Tilt
Band	WCDMA Band II
Channels	Middle
Signal	CDMA (Crest factor: 1.0)

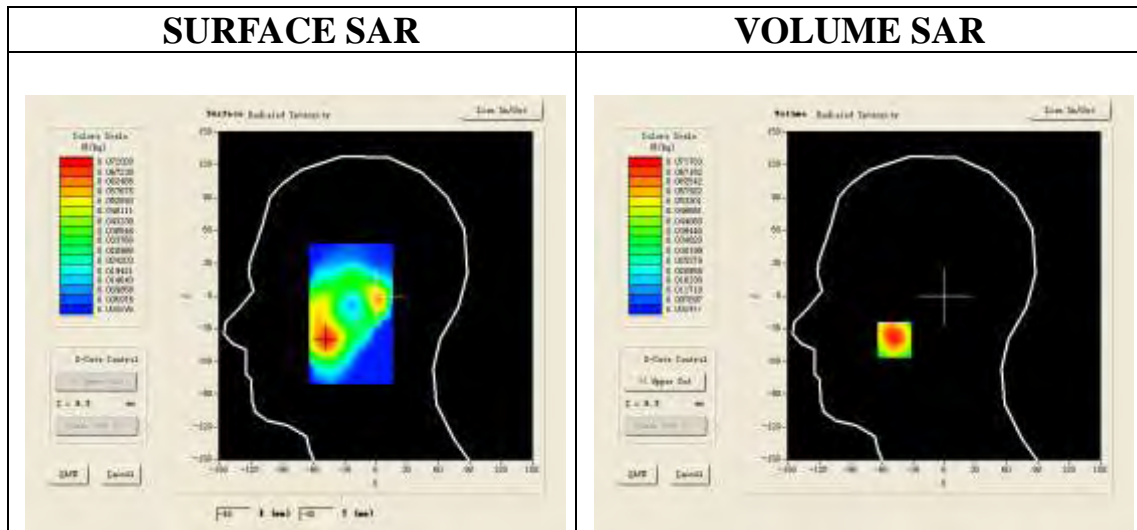

Maximum location: X=-48.00, Y=-40.00

SAR 10g (W/Kg)	0.037543
SAR 1g (W/Kg)	0.067934

Z (mm)	0.00	4.00	9.00	14.00	19.00
SAR (W/Kg)	0.0000	0.0718	0.0403	0.0221	0.0119

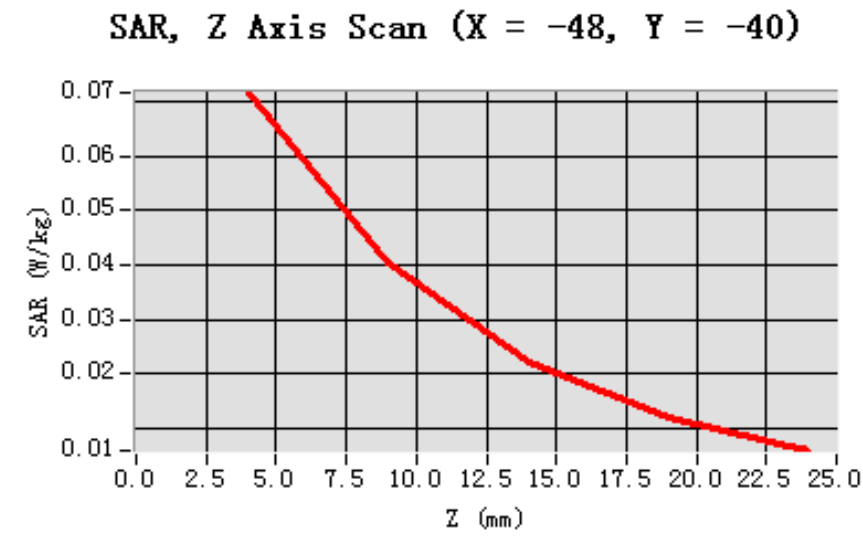

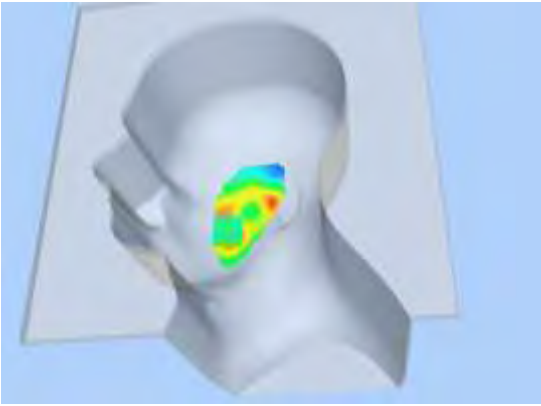
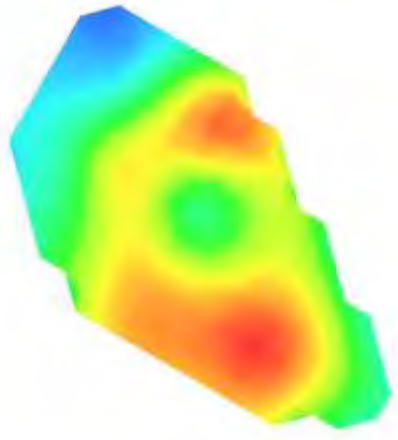
3D screen shot	Hot spot position
	

**Test Laboratory: AGC Lab**  
**WCDMA Band II Mid-Touch-Right (RMC)**  
**DUT: mobile phone; Type: AM503**

**Date: Oct.16,2014**

Communication System: UMTS; Communication System Band: Band II UTRA/FDD ;Duty Cycle:1:1; Conv.F=4.51  
Frequency: 1880 MHz; Medium parameters used:  $f = 1900$  MHz;  $\sigma = 1.42$  mho/m;  $\epsilon_r = 40.46$ ;  $\rho = 1000$  kg/m<sup>3</sup> ;  
Phantom section: Right Section  
Ambient temperature (°C):21, Liquid temperature (°C):21

SATIMO Configuration:

- Probe: SSE5; Calibrated: 01/12/2014; Serial No.:SN 22/12 EP159
- Sensor-Surface: 4mm (Mechanical Surface Detection)
- Phantom: Flat Phantom; Type: Elliptical Phantom
- Measurement SW: OpenSAR V4\_02\_01

**Configuration/WCDMA band II Mid-Touch-Right/Area Scan:** Measurement grid: dx=8mm, dy=8mm

**Configuration/WCDMA band II Mid-Touch-Right/Zoom Scan:** Measurement grid: dx=8mm,dy=8mm, dz=5mm;

<b>Area Scan</b>	sam_direct_droit2_surf8mm.txt
<b>ZoomScan</b>	5x5x7,dx=8mm dy=8mm dz=5mm,Very fast
<b>Phantom</b>	Right head
<b>Device Position</b>	Cheek
<b>Band</b>	WCDMA band II
<b>Channels</b>	Middle
<b>Signal</b>	CDMA (Crest factor: 1.0)

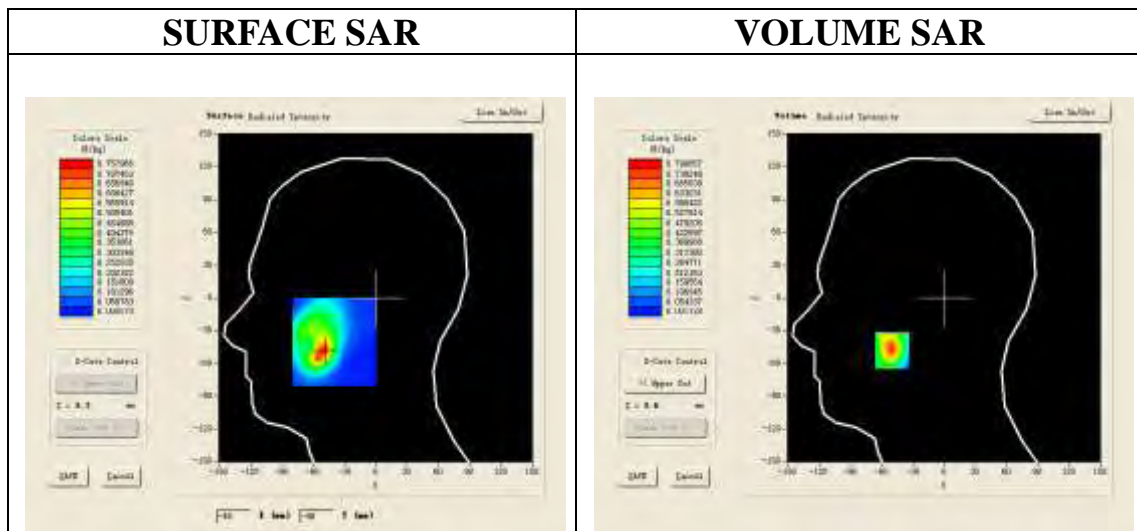

**Maximum location: X=-50.00, Y=-48.00**

<b>SAR 10g (W/Kg)</b>	0.342329
<b>SAR 1g (W/Kg)</b>	0.725534

Z (mm)	0.00	4.00	9.00	14.00	19.00
SAR (W/Kg)	0.0000	0.7909	0.3913	0.1897	0.0954

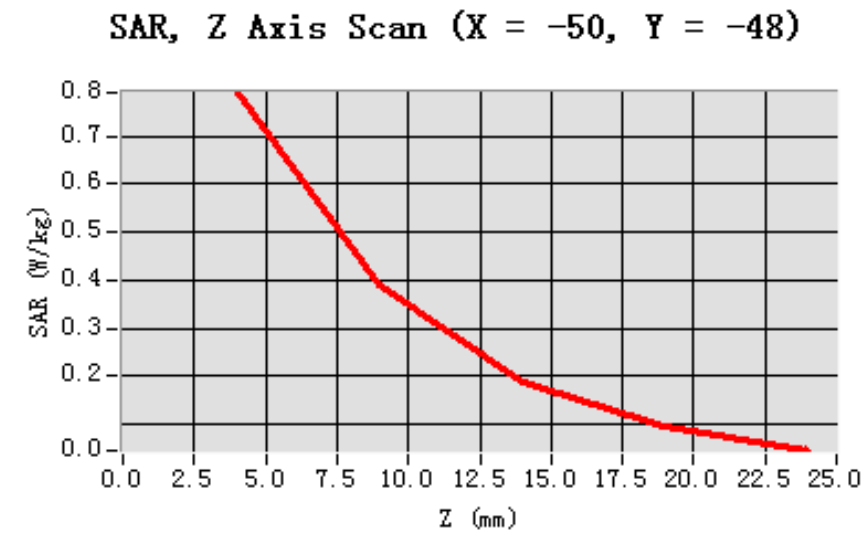

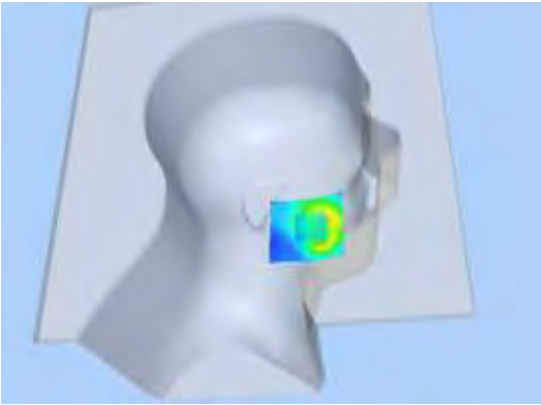
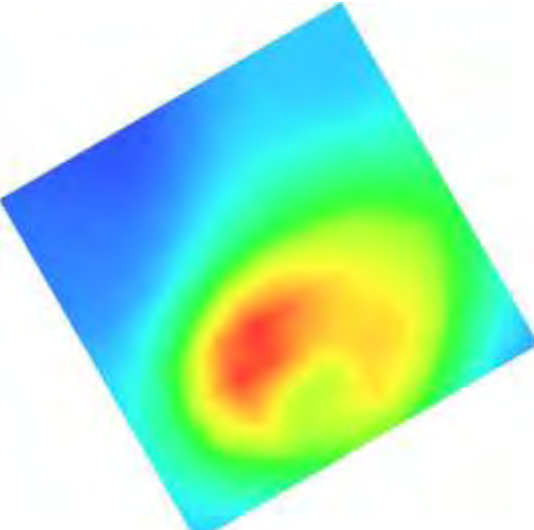
3D screen shot	Hot spot position
	



Test Laboratory: AGC Lab  
WCDMA Band II Mid-Tilt-Right <RMC>  
DUT: mobile phone; Type: AM503

Date: Oct.16,2014

Communication System: UMTS; Communication System Band: Band II UTRA/FDD ;Duty Cycle:1:1; Conv.F=4.51  
Frequency: 1880 MHz; Medium parameters used:  $f = 1900$  MHz;  $\sigma = 1.42$  mho/m;  $\epsilon_r = 40.46$ ;  $\rho = 1000$  kg/m<sup>3</sup> ;  
Phantom section: Right Section  
Ambient temperature (°C):21, Liquid temperature (°C):21

SATIMO Configuration:

- Probe: SSE5; Calibrated: 01/12/2014; Serial No.:SN 22/12 EP159
- Sensor-Surface: 4mm (Mechanical Surface Detection)
- Phantom: Flat Phantom; Type: Elliptical Phantom
- Measurement SW: OpenSAR V4\_02\_01

Configuration/WCDMA Band II Mid-Tilt-Right/Area Scan: Measurement grid: dx=8mm, dy=8mm  
Configuration/WCDMA Band II Mid-Tilt-Right/Zoom Scan: Measurement grid: dx=8mm,dy=8mm, dz=5mm;

Area Scan	sam_direct_droit2_surf8mm.txt
ZoomScan	5x5x7,dx=8mm dy=8mm dz=5mm,Very fast
Phantom	Right head
Device Position	Tilt
Band	WCDMA band II
Channels	Middle
Signal	CDMA (Crest factor: 1.0)

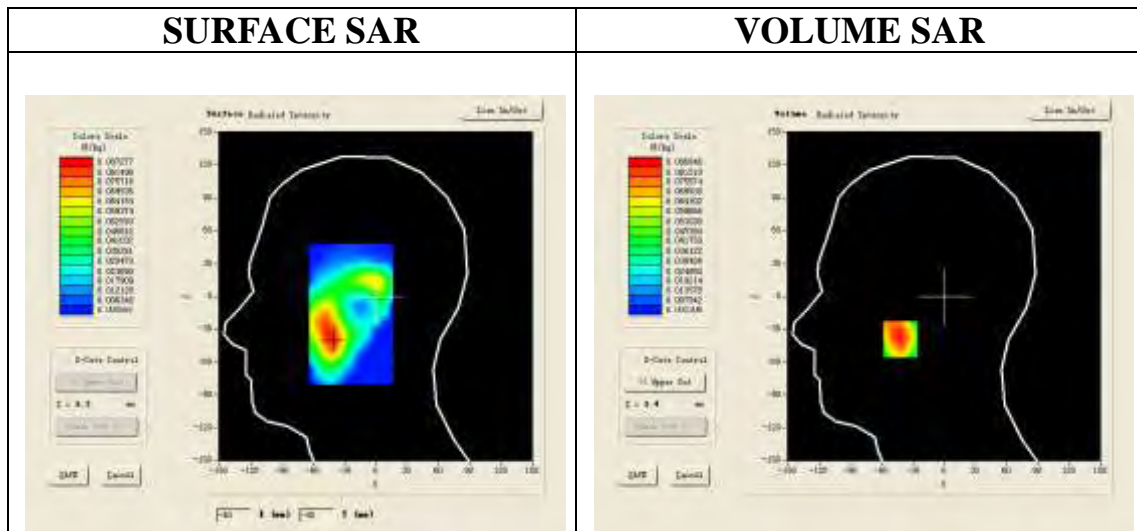

Maximum location: X=-42.00, Y=-39.00

SAR 10g (W/Kg)	0.045338
SAR 1g (W/Kg)	0.082336

Z (mm)	0.00	4.00	9.00	14.00	19.00
SAR (W/Kg)	0.0000	0.0868	0.0478	0.0256	0.0137

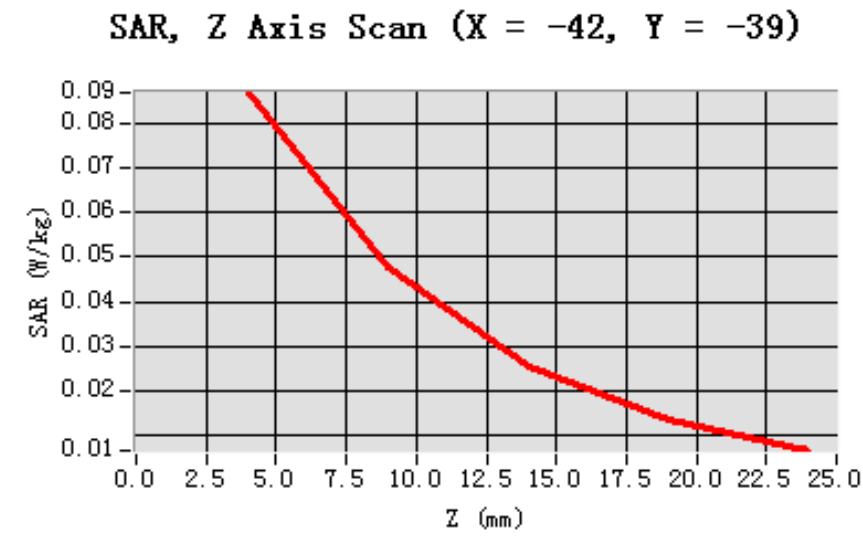

3D screen shot	Hot spot position

**Test Laboratory: AGC Lab**  
**WCDMA Band II Low-Body-Towards Grounds (RMC 12.2kbps)**  
**DUT: mobile phone; Type: AM503**

**Date: Oct.16,2014**

Communication System: UMTS; Communication System Band: Band II UTRA/FDD ;Duty Cycle:1:1; Conv.F=4.45  
Frequency: 1852.4 MHz; Medium parameters used:  $f = 1900$  MHz;  $\sigma=1.53$  mho/m;  $\epsilon_r =53.58$ ;  $\rho= 1000$  kg/m<sup>3</sup> ;  
Phantom section: Flat Section  
Ambient temperature (°C):21, Liquid temperature (°C):21

SATIMO Configuration:

- Probe: SSE5; Calibrated: 01/12/2014; Serial No.:SN 22/12 EP159
- Sensor-Surface: 4mm (Mechanical Surface Detection)
- Phantom: Flat Phantom; Type: Elliptical Phantom
- Measurement SW: OpenSAR V4\_02\_01

**Configuration/ WCDMA band II Low -Body-back/Area Scan:** Measurement grid: dx=8mm, dy=8mm

**Configuration/ WCDMA band II Low -Body-back/Zoom Scan:** Measurement grid: dx=8mm,dy=8mm, dz=5mm;

<b>Area Scan</b>	surf_sam_plan.txt
<b>ZoomScan</b>	5x5x7,dx=8mm dy=8mm dz=5mm,Very fast
<b>Phantom</b>	Validation plane
<b>Device Position</b>	Body Back
<b>Band</b>	WCDMA band II
<b>Channels</b>	Low
<b>Signal</b>	CDMA (Crest factor: 1.0)

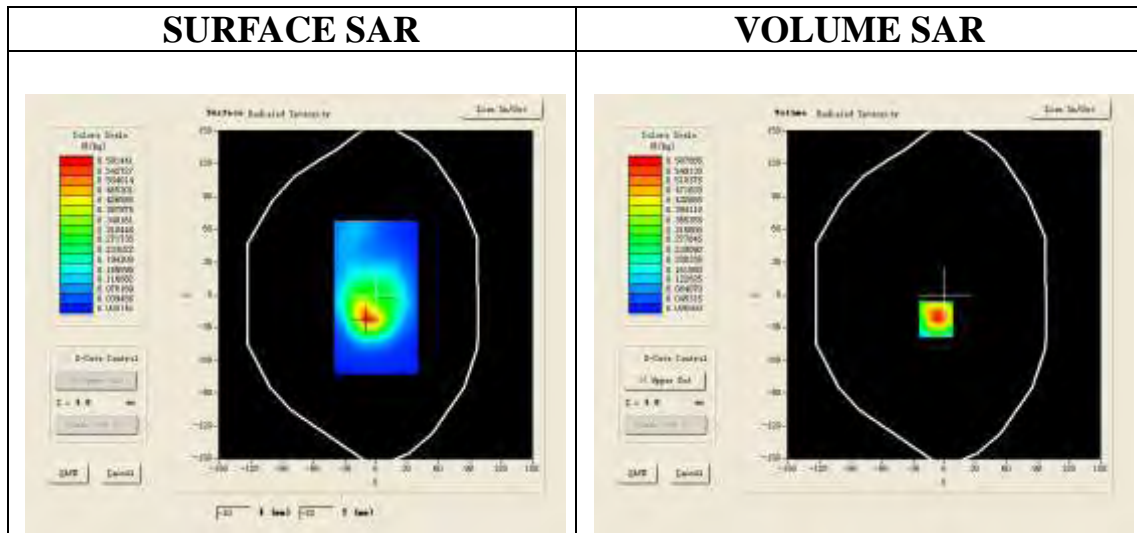

**Maximum location: X=-8.00, Y=-22.00**

<b>SAR 10g (W/Kg)</b>	0.282912
<b>SAR 1g (W/Kg)</b>	0.553936

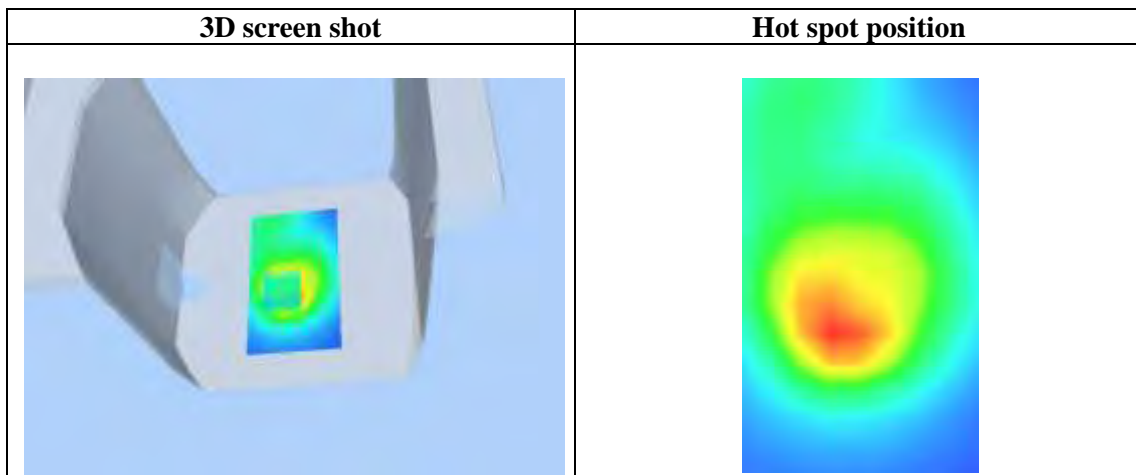
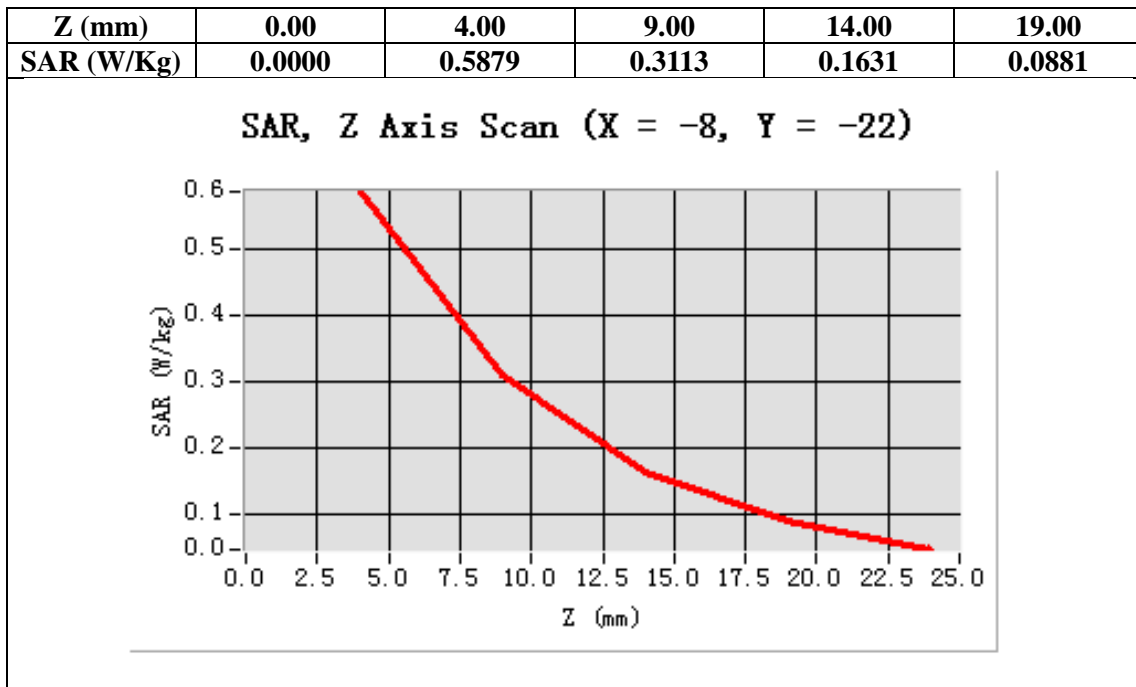

**Test Laboratory: AGC Lab**  
**WCDMA Band II Mid-Body-Towards Grounds (RMC 12.2kbps)**  
**DUT: mobile phone; Type: AM503**

**Date: Oct.16,2014**

Communication System: UMTS; Communication System Band: Band II UTRA/FDD ;Duty Cycle:1:1; Conv.F=4.45  
Frequency: 1880 MHz; Medium parameters used:  $f = 1900$  MHz;  $\sigma=1.49$  mho/m;  $\epsilon_r =53.21$ ;  $\rho= 1000$  kg/m<sup>3</sup> ;  
Phantom section: Flat Section  
Ambient temperature (°C):21, Liquid temperature (°C):21

SATIMO Configuration:

- Probe: SSE5; Calibrated: 01/12/2014; Serial No.:SN 22/12 EP159
- Sensor-Surface: 4mm (Mechanical Surface Detection)
- Phantom: Flat Phantom; Type: Elliptical Phantom
- Measurement SW: OpenSAR V4\_02\_01

**Configuration/ WCDMA band II Mid-Body-back/Area Scan:** Measurement grid: dx=8mm, dy=8mm  
**Configuration/ WCDMA band II Mid-Body-back/Zoom Scan:** Measurement grid: dx=8mm,dy=8mm, dz=5mm;

<b>Area Scan</b>	surf_sam_plan.txt
<b>ZoomScan</b>	5x5x7,dx=8mm dy=8mm dz=5mm,Very fast
<b>Phantom</b>	Validation plane
<b>Device Position</b>	Body Back
<b>Band</b>	WCDMA band II
<b>Channels</b>	Middle
<b>Signal</b>	CDMA (Crest factor: 1.0)

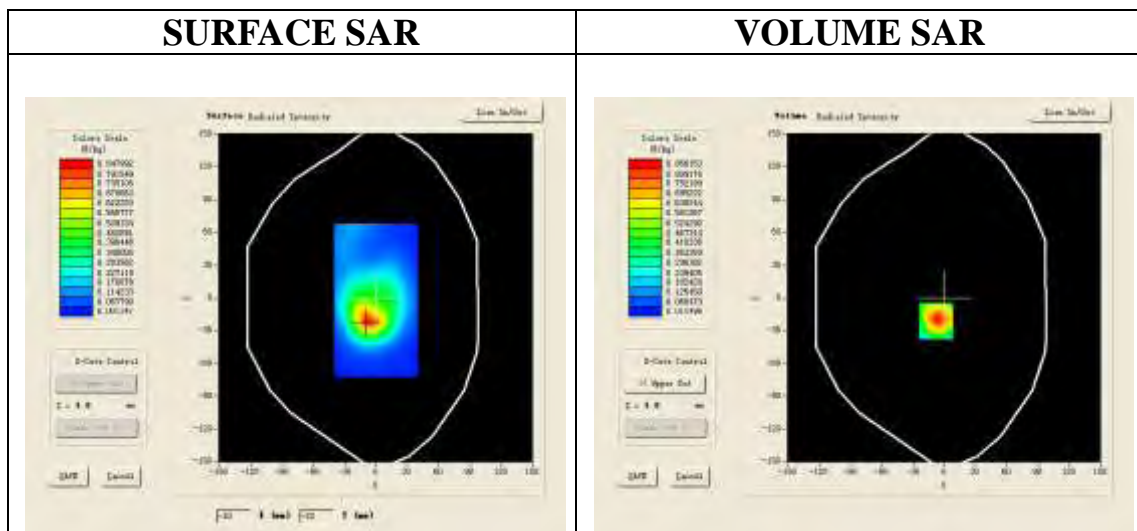

**Maximum location: X=-8.00, Y=-21.00**

<b>SAR 10g (W/Kg)</b>	0.420832
<b>SAR 1g (W/Kg)</b>	0.816174

Z (mm)	0.00	4.00	9.00	14.00	19.00
SAR (W/Kg)	0.0000	0.8662	0.4615	0.2425	0.1302

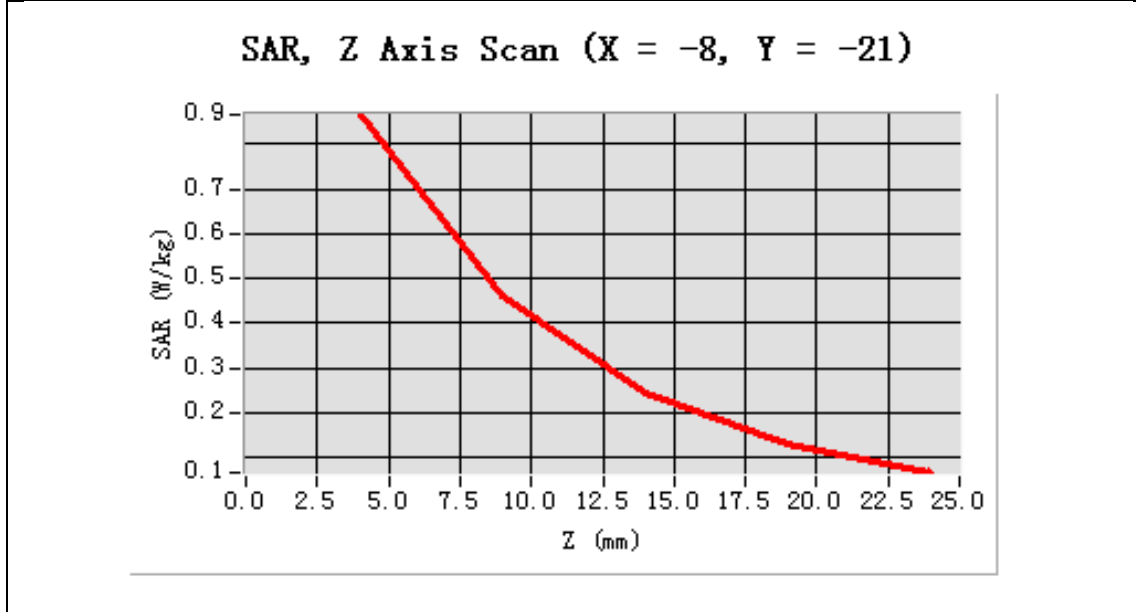

3D screen shot	Hot spot position

Test Laboratory: AGC Lab  
WCDMA Band II High-Body-Towards Grounds (RMC 12.2kbps)  
DUT: mobile phone; Type: AM503

Date: Oct.16,2014

Communication System: UMTS; Communication System Band: Band II UTRA/FDD ;Duty Cycle:1:1; Conv.F=4.45  
Frequency: 1907.6 MHz; Medium parameters used:  $f = 1900$  MHz;  $\sigma=1.50$ mho/m;  $\epsilon_r=53.08$ ;  $\rho= 1000$  kg/m<sup>3</sup> ;  
Phantom section: Flat Section  
Ambient temperature (°C):21, Liquid temperature (°C):21

SATIMO Configuration:

- Probe: SSE5; Calibrated: 01/12/2014; Serial No.:SN 22/12 EP159
- Sensor-Surface: 4mm (Mechanical Surface Detection)
- Phantom: Flat Phantom; Type: Elliptical Phantom
- Measurement SW: OpenSAR V4\_02\_01

Configuration/ WCDMA band II High -Body-back/Area Scan: Measurement grid: dx=8mm, dy=8mm  
Configuration/ WCDMA band II High -Body-back/Zoom Scan: Measurement grid: dx=8mm,dy=8mm, dz=5m;

Area Scan	surf_sam_plan.txt
ZoomScan	5x5x7,dx=8mm dy=8mm dz=5mm,Very fast
Phantom	Validation plane
Device Position	Body Back
Band	WCDMA band II
Channels	High
Signal	CDMA (Crest factor: 1.0)

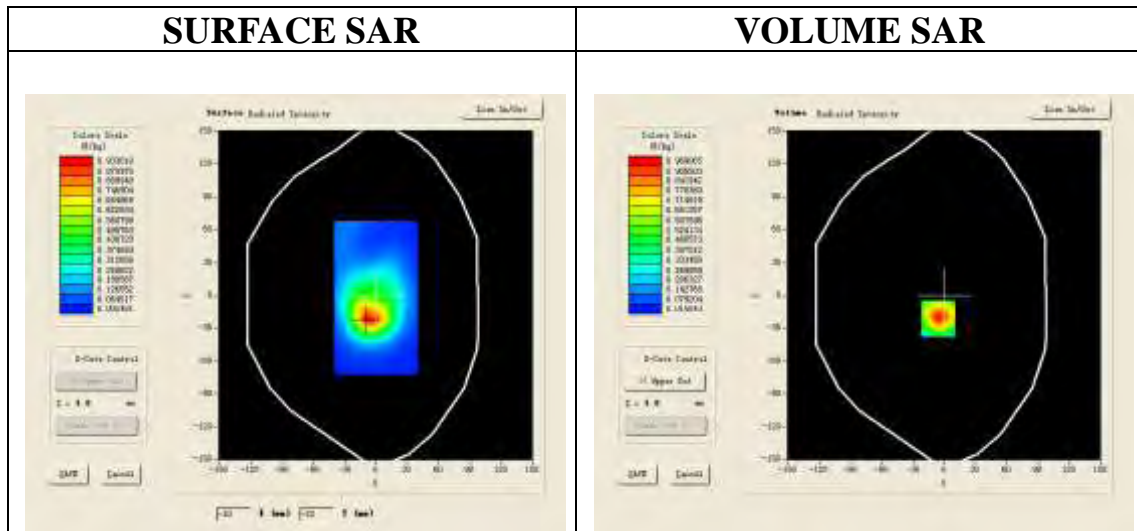

Maximum location: X=-6.00, Y=-21.00

SAR 10g (W/Kg)	0.467478
SAR 1g (W/Kg)	0.908385

Z (mm)	0.00	4.00	9.00	14.00	19.00
SAR (W/Kg)	0.0000	0.9691	0.5135	0.2677	0.1423

**SAR, Z Axis Scan (X = -6, Y = -21)**

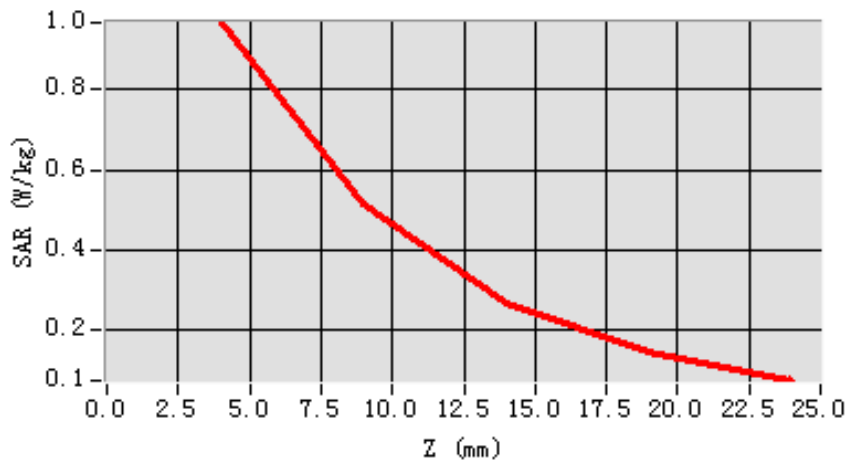

**3D screen shot**

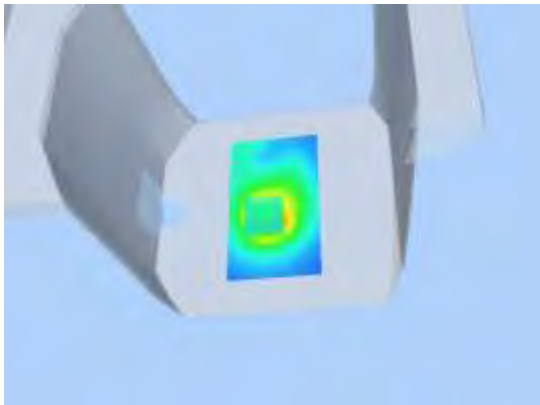

**Hot spot position**

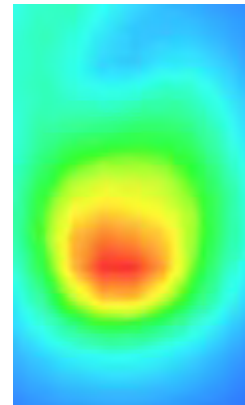



**Test Laboratory: AGC Lab**  
**WCDMA Band II Mid-Body-Towards Phantom (RMC 12.2kbps)**  
**DUT: mobile phone; Type: AM503**

**Date: Oct.16,2014**

Communication System: UMTS; Communication System Band: Band II UTRA/FDD ;Duty Cycle:1:1; Conv.F=4.45  
Frequency: 1880 MHz; Medium parameters used:  $f = 1900$  MHz;  $\sigma=1.49$  mho/m;  $\epsilon_r =53.21$ ;  $\rho= 1000$  kg/m<sup>3</sup> ;  
Phantom section: Flat Section  
Ambient temperature (°C):21, Liquid temperature (°C):21

**SATIMO Configuration:**

- Probe: SSE5; Calibrated: 01/12/2014; Serial No.:SN 22/12 EP159
- Sensor-Surface: 4mm (Mechanical Surface Detection)
- Phantom: Flat Phantom; Type: Elliptical Phantom
- Measurement SW: OpenSAR V4\_02\_01

**Configuration/ WCDMA band II Mid-Body-Front/Area Scan:** Measurement grid: dx=8mm, dy=8mm

**Configuration/ WCDMA band II Mid-Body-Front/Zoom Scan:** Measurement grid: dx=8mm,dy=8mm, dz=5mm;

<b>Area Scan</b>	surf_sam_plan.txt
<b>ZoomScan</b>	5x5x7,dx=8mm dy=8mm dz=5mm,Very fast
<b>Phantom</b>	Validation plane
<b>Device Position</b>	Body Front
<b>Band</b>	WCDMA band II
<b>Channels</b>	Middle
<b>Signal</b>	CDMA (Crest factor: 1.0)

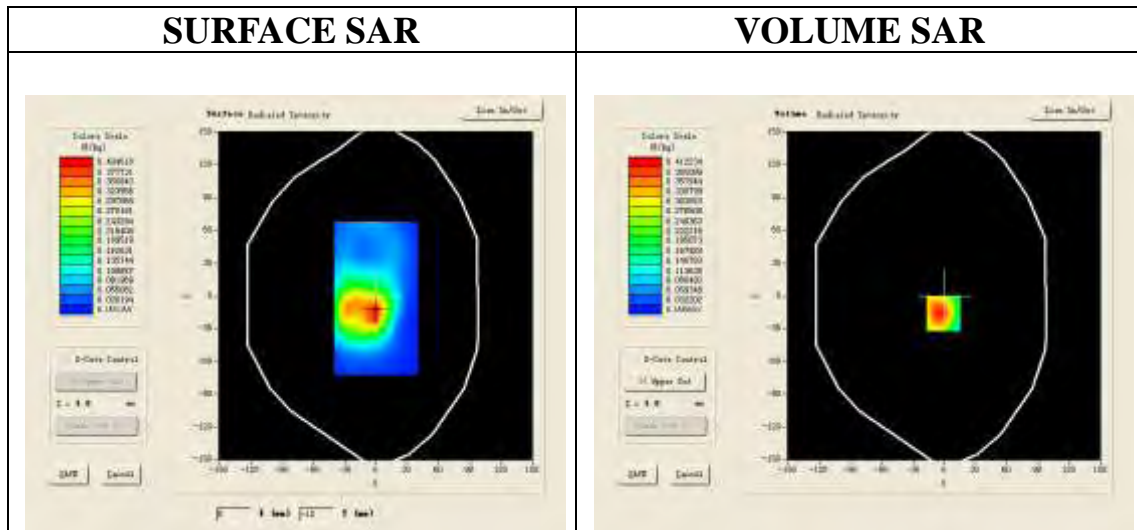

**Maximum location: X=-1.00, Y=-16.00**

<b>SAR 10g (W/Kg)</b>	0.206172
<b>SAR 1g (W/Kg)</b>	0.394602

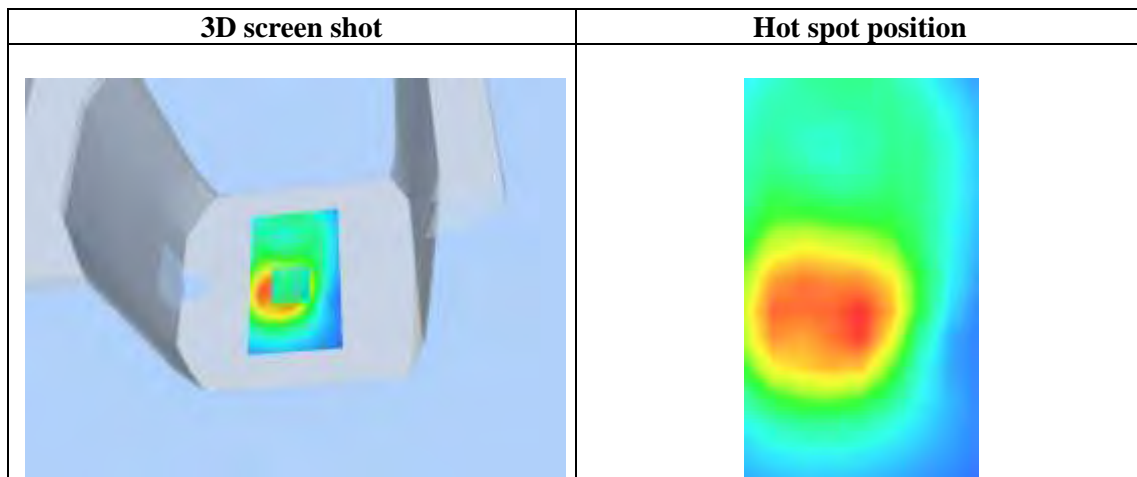
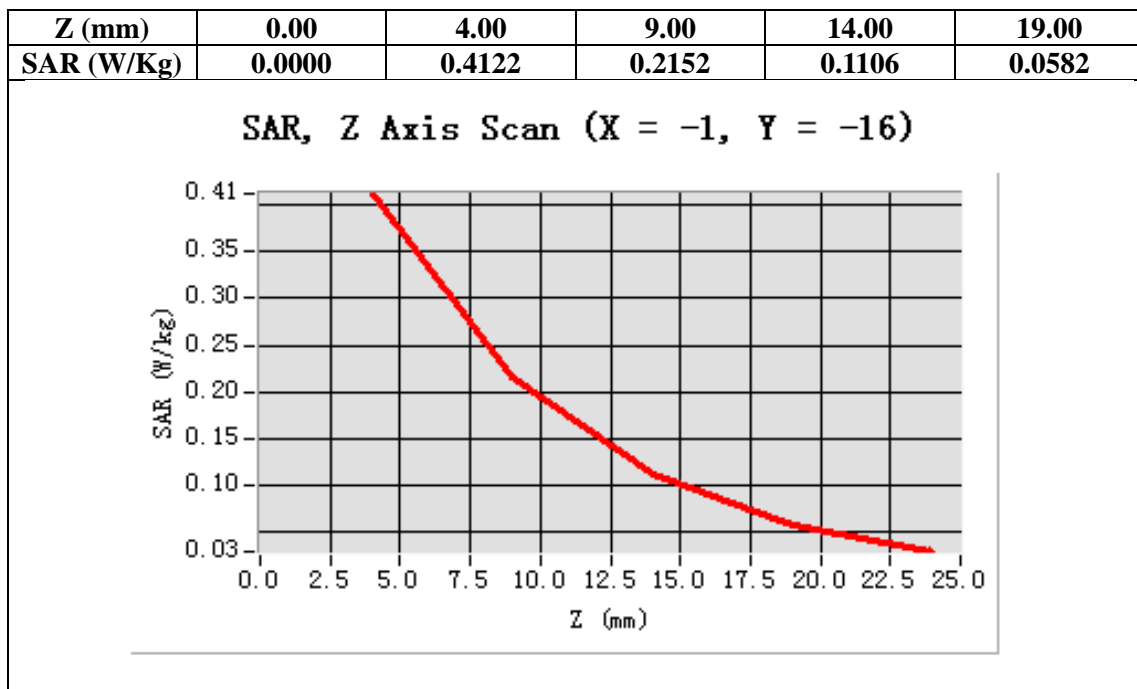

Test Laboratory: AGC Lab

Date: Oct.16,2014

WCDMA Band V Mid-Touch-Left (RMC )

DUT: mobile phone; Type: AM503

Communication System: UMTS; Communication System Band: BAND V UTRA/FDD ; Duty Cycle:1: 1; Conv.F=5.27  
Frequency: 836.6 MHz; Medium parameters used:  $f = 835\text{MHz}$ ;  $\sigma=0.91\text{ mho/m}$ ;  $\epsilon_r = 41.22$ ;  $\rho= 1000\text{ kg/m}^3$  ;  
Phantom section: Left Section  
Ambient temperature ( $^{\circ}\text{C}$ ): 21, Liquid temperature ( $^{\circ}\text{C}$ ): 21

SATIMO Configuration:

- Probe: SSE5; Calibrated: 01/12/2014; Serial No.:SN 22/12 EP159
- Sensor-Surface: 4mm (Mechanical Surface Detection)
- Phantom: Flat Phantom; Type: Elliptical Phantom
- Measurement SW: OpenSAR V4\_02\_01

Configuration/ WCDMA Band V Mid-Touch-Left/Area Scan: Measurement grid: dx=8mm, dy=8mm

Configuration/ WCDMA Band V Mid-Touch-Left/Zoom Scan: Measurement grid: dx=8mm, dy=8mm, dz=5mm

<b>Area Scan</b>	sam_direct_droit2_surf8mm.txt
<b>ZoomScan</b>	5x5x7,dx=8mm dy=8mm dz=5mm,Very fast
<b>Phantom</b>	Left head
<b>Device Position</b>	Cheek
<b>Band</b>	WCDMA Band V
<b>Channels</b>	Middle
<b>Signal</b>	CDMA (Crest factor: 1.0)

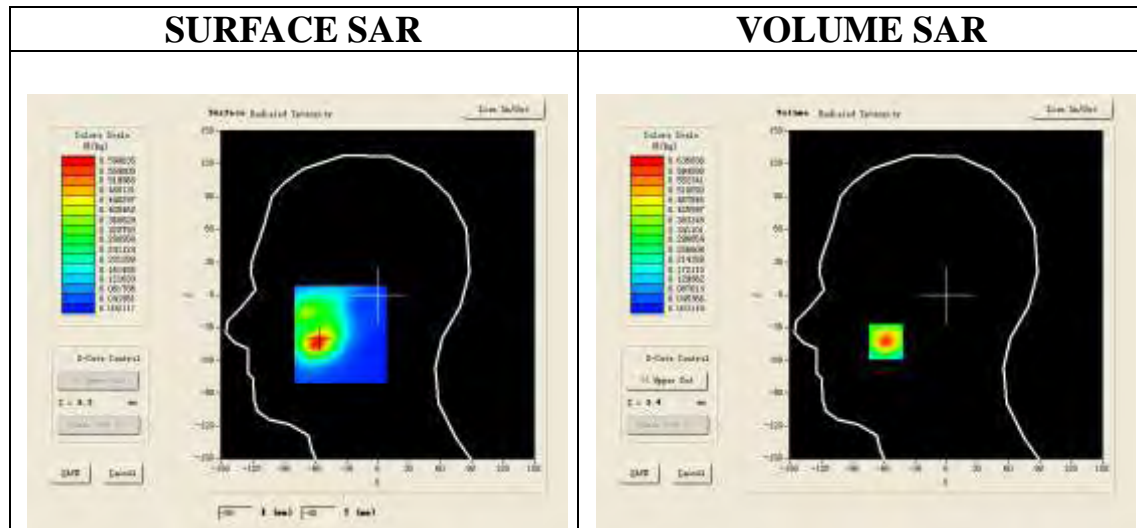

Maximum location: X=-58.00, Y=-43.00

<b>SAR 10g (W/Kg)</b>	0.273075
<b>SAR 1g (W/Kg)</b>	0.593575

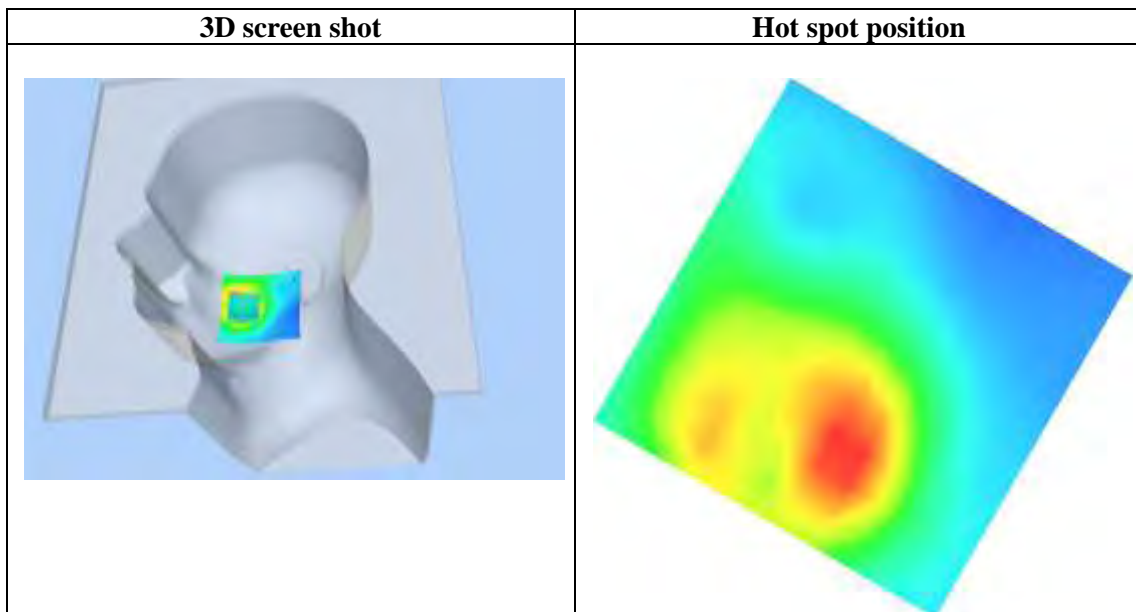
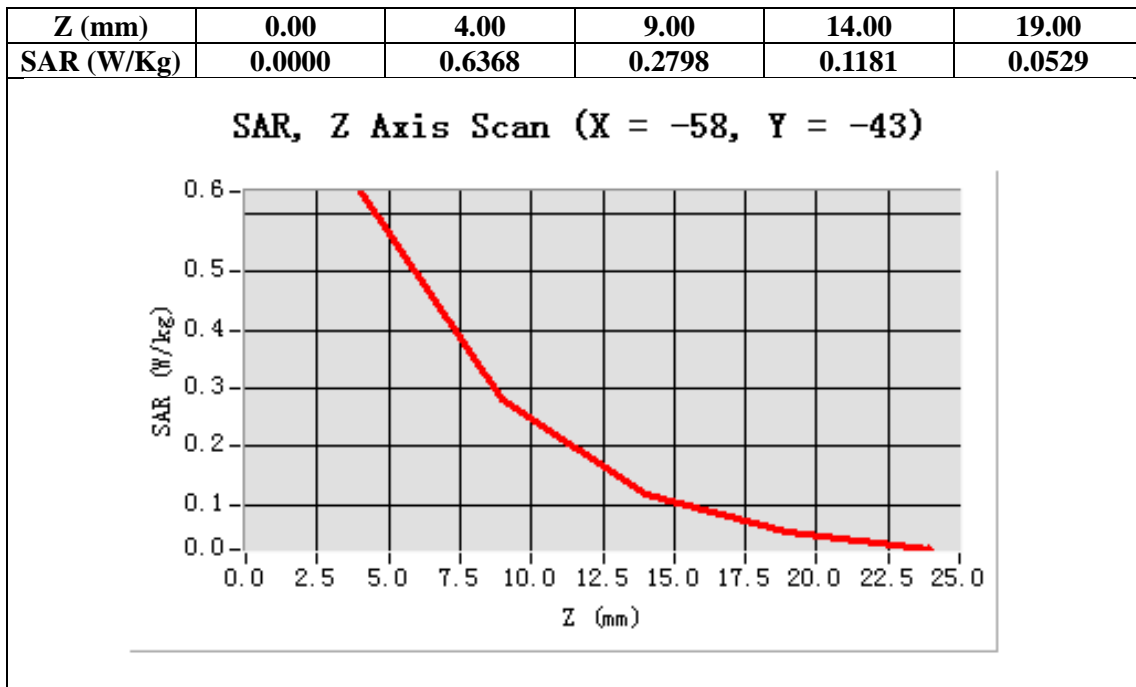

Test Laboratory: AGC Lab

Date: Oct.16,2014

WCDMA Band V Mid-Tilt-Left (RMC)

DUT: mobile phone; Type: AM503

Communication System: UMTS; Communication System Band: BAND V UTRA/FDD ; Duty Cycle:1: 1; Conv.F=5.27  
Frequency: 836.6 MHz; Medium parameters used:  $f = 835\text{MHz}$ ;  $\sigma = 0.91\text{ mho/m}$ ;  $\epsilon_r = 41.22$ ;  $\rho = 1000\text{ kg/m}^3$  ;  
Phantom section: Left Section  
Ambient temperature ( $^{\circ}\text{C}$ ): 21, Liquid temperature ( $^{\circ}\text{C}$ ): 21

SATIMO Configuration:

- Probe: SSE5; Calibrated: 01/12/2014; Serial No.:SN 22/12 EP159
- Sensor-Surface: 4mm (Mechanical Surface Detection)
- Phantom: Flat Phantom; Type: Elliptical Phantom
- Measurement SW: OpenSAR V4\_02\_01

Configuration/ WCDMA Band V Mid-Tilt-Left/Area Scan: Measurement grid:  $dx=8\text{mm}$ ,  $dy=8\text{mm}$

Configuration/ WCDMA Band V Mid-Tilt-Left/Zoom Scan: Measurement grid:  $dx=8\text{mm}$ ,  $dy=8\text{mm}$ ,  $dz=5\text{mm}$ ;

<b>Area Scan</b>	sam_direct_droit2_surf8mm.txt
<b>ZoomScan</b>	5x5x7,dx=8mm dy=8mm dz=5mm,Very fast
<b>Phantom</b>	Left head
<b>Device Position</b>	Tilt
<b>Band</b>	WCDMA Band V
<b>Channels</b>	Middle
<b>Signal</b>	CDMA (Crest factor: 1.0)

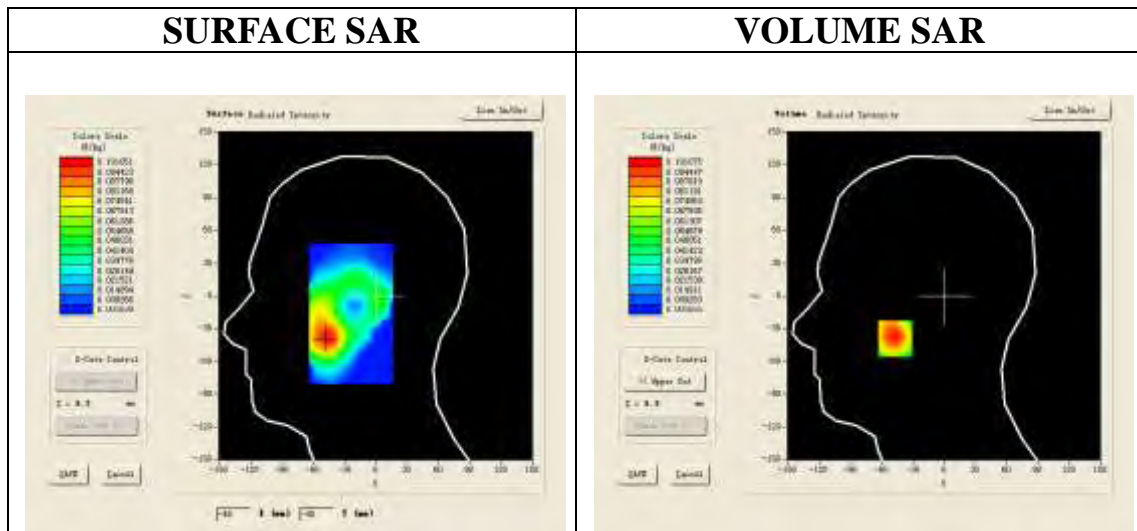

Maximum location: X=-47.00, Y=-39.00

<b>SAR 10g (W/Kg)</b>	0.049440
<b>SAR 1g (W/Kg)</b>	0.096563

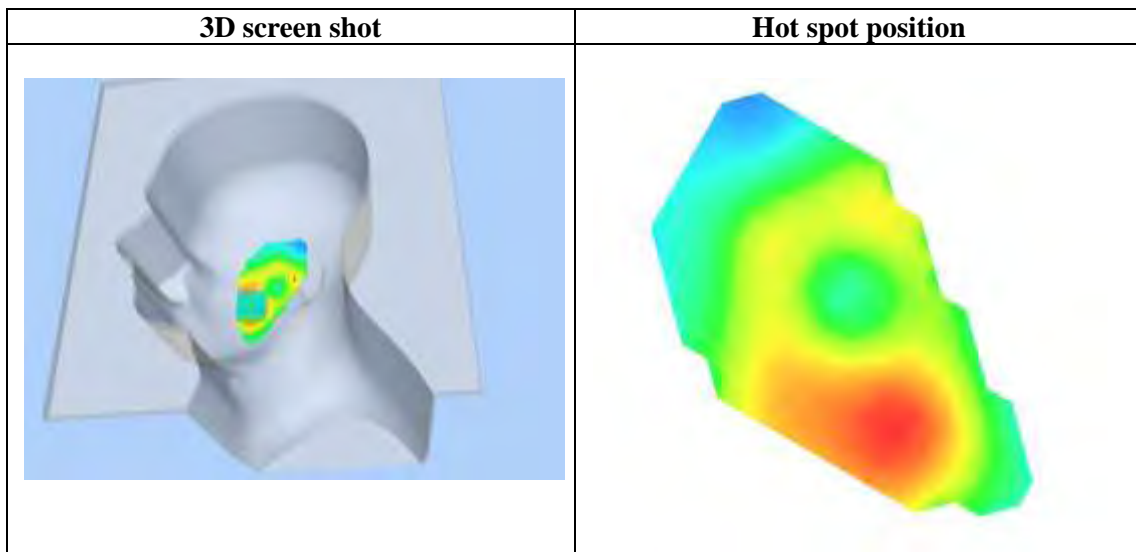
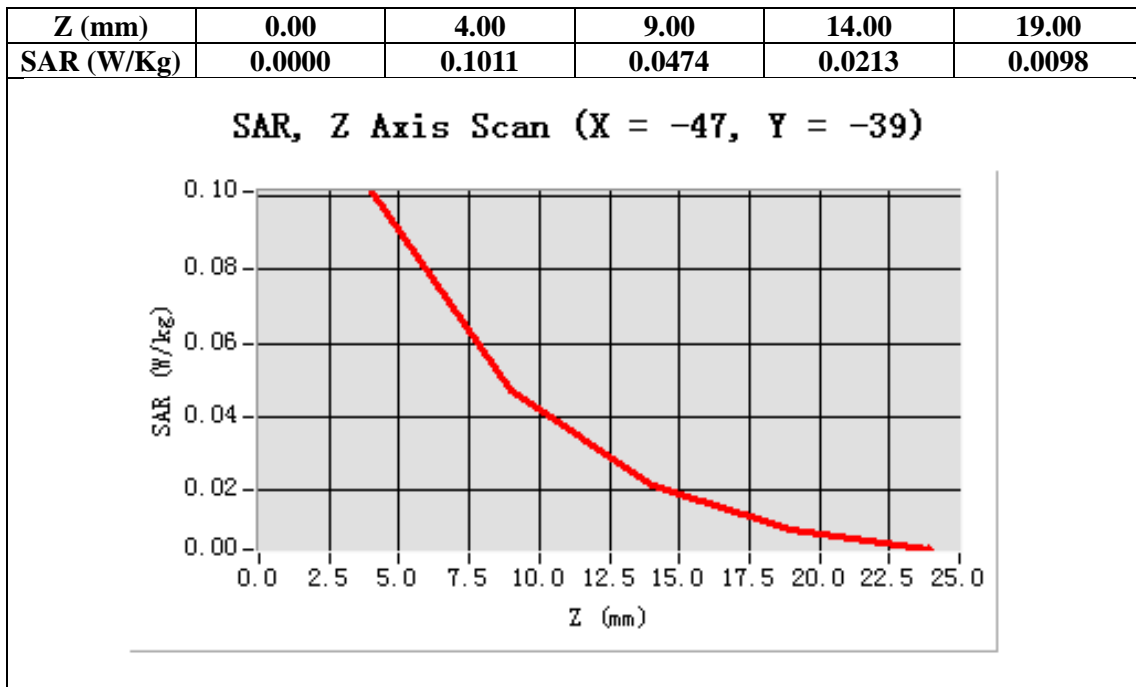

Test Laboratory: AGC Lab

Date: Oct.16,2014

WCDMA Band V Mid- Touch-Right (RMC)

DUT: mobile phone; Type: AM503

Communication System: UMTS; Communication System Band: BAND V UTRA/FDD ; Duty Cycle:1: 1; Conv.F=5.27  
Frequency: 836.6 MHz; Medium parameters used: f = 835MHz;  $\sigma=0.91$  mho/m;  $\epsilon_r=41.22$ ;  $\rho=1000$  kg/m<sup>3</sup> ;  
Phantom section: Right Section  
Ambient temperature (°C): 21, Liquid temperature (°C): 21

SATIMO Configuration:

- Probe: SSE5; Calibrated: 01/12/2014; Serial No.:SN 22/12 EP159
- Sensor-Surface: 4mm (Mechanical Surface Detection)
- Phantom: Flat Phantom; Type: Elliptical Phantom
- Measurement SW: OpenSAR V4\_02\_01

Configuration/ WCDMA Band V Mid-Touch-Right/Area Scan: Measurement grid: dx=8mm, dy=8mm

Configuration/ WCDMA Band V Mid-Touch-Right/Zoom Scan: Measurement grid: dx=8mm,dy=8mm, dz=5mm;

<b>Area Scan</b>	sam_direct_droit2_surf8mm.txt
<b>ZoomScan</b>	5x5x7,dx=8mm dy=8mm dz=5mm,Very fast
<b>Phantom</b>	Right head
<b>Device Position</b>	Cheek
<b>Band</b>	WCDMA Band V
<b>Channels</b>	Middle
<b>Signal</b>	CDMA (Crest factor: 1.0)

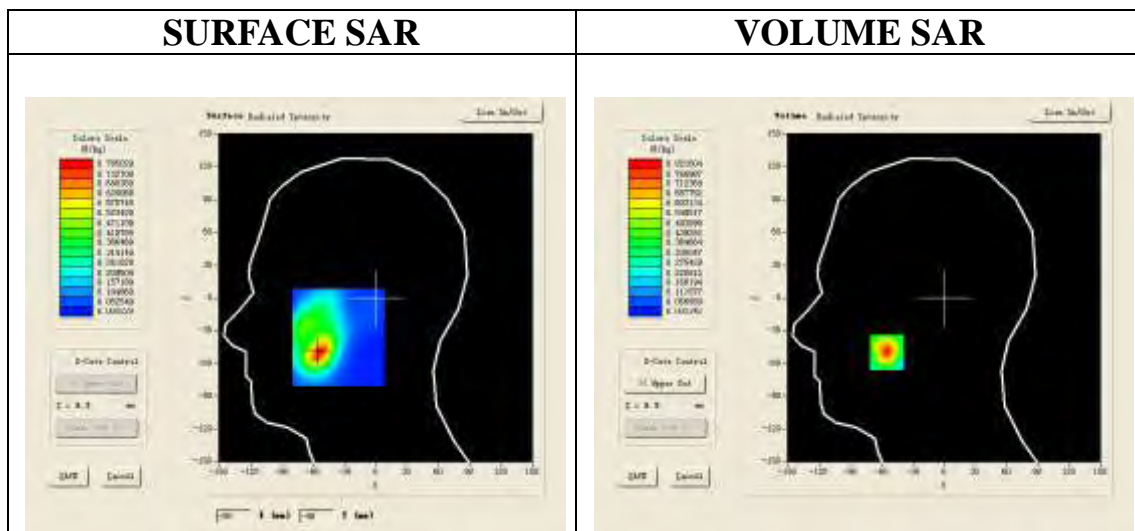

Maximum location: X=-55.00, Y=-50.00

<b>SAR 10g (W/Kg)</b>	0.340506
<b>SAR 1g (W/Kg)</b>	0.769613

Z (mm)	0.00	4.00	9.00	14.00	19.00
SAR (W/Kg)	0.0000	0.8216	0.3242	0.1198	0.0486

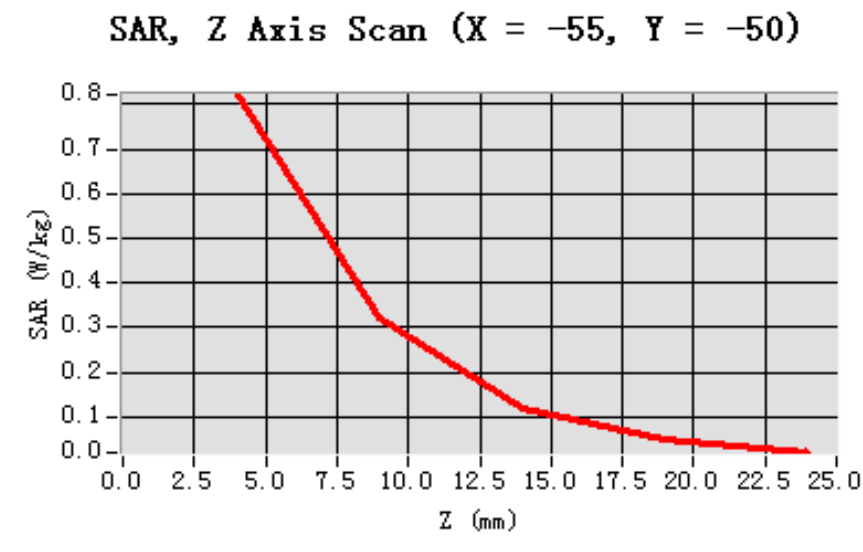

**3D screen shot**

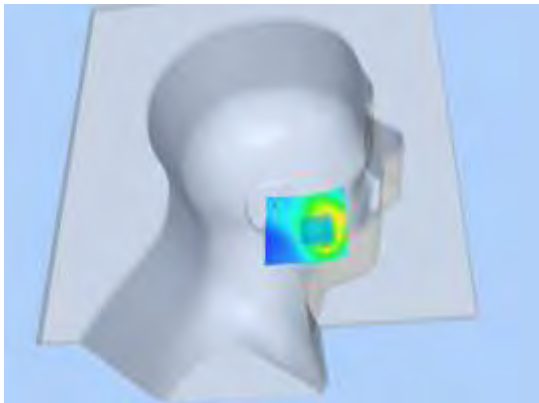

**Hot spot position**

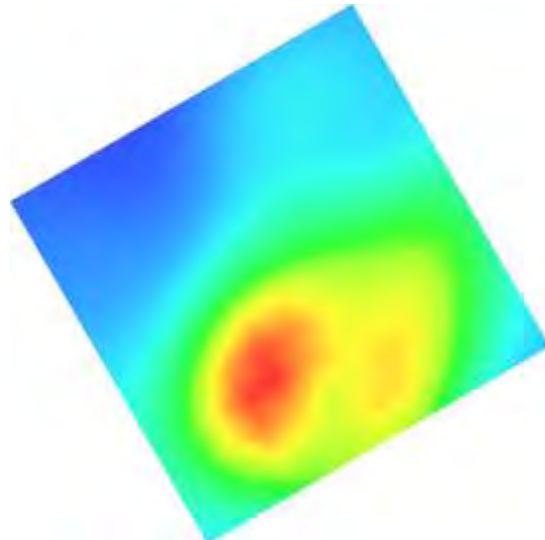



Test Laboratory: AGC Lab

Date: Oct.16,2014

WCDMA Band V Mid-Tilt-Right (RMC)

DUT: mobile phone; Type: AM503

Communication System: UMTS; Communication System Band: BAND V UTRA/FDD ; Duty Cycle:1: 1; Conv.F=5.27  
Frequency: 836.6 MHz; Medium parameters used:  $f = 835\text{MHz}$ ;  $\sigma = 0.91\text{ mho/m}$ ;  $\epsilon_r = 41.22$ ;  $\rho = 1000\text{ kg/m}^3$  ;  
Phantom section: Right Section  
Ambient temperature ( $^{\circ}\text{C}$ ): 21, Liquid temperature ( $^{\circ}\text{C}$ ): 21

SATIMO Configuration:

- Probe: SSE5; Calibrated: 01/12/2014; Serial No.:SN 22/12 EP159
- Sensor-Surface: 4mm (Mechanical Surface Detection)
- Phantom: Flat Phantom; Type: Elliptical Phantom
- Measurement SW: OpenSAR V4\_02\_01

Configuration/ WCDMA Band V Mid-Tilt-Right/Area Scan: Measurement grid:  $dx=8\text{mm}$ ,  $dy=8\text{mm}$

Configuration/ WCDMA Band V Mid-Tilt-Right/Zoom Scan: Measurement grid:  $dx=8\text{mm}$ ,  $dy=8\text{mm}$ ,  $dz=5\text{mm}$ ;

Area Scan	sam_direct_droit2_surf8mm.txt
Zoom Scan	5x5x7,dx=8mm dy=8mm dz=5mm,Very fast
Phantom	Right head
Device Position	Tilt
Band	WCDMA Band V
Channels	Middle
Signal	CDMA (Crest factor: 1.0)

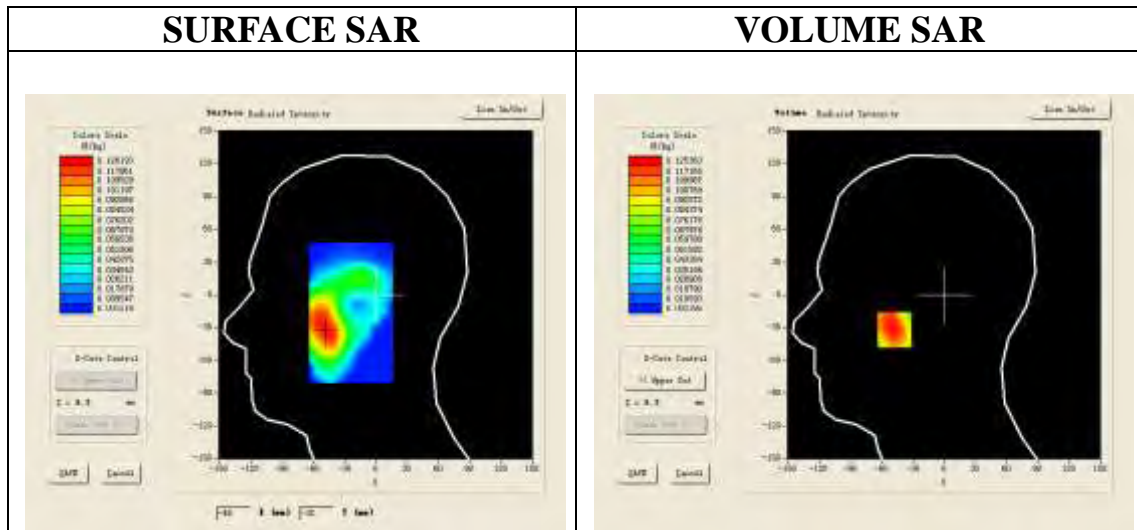

Maximum location: X=-48.00, Y=-32.00

SAR 10g (W/Kg)	0.063559
SAR 1g (W/Kg)	0.120447

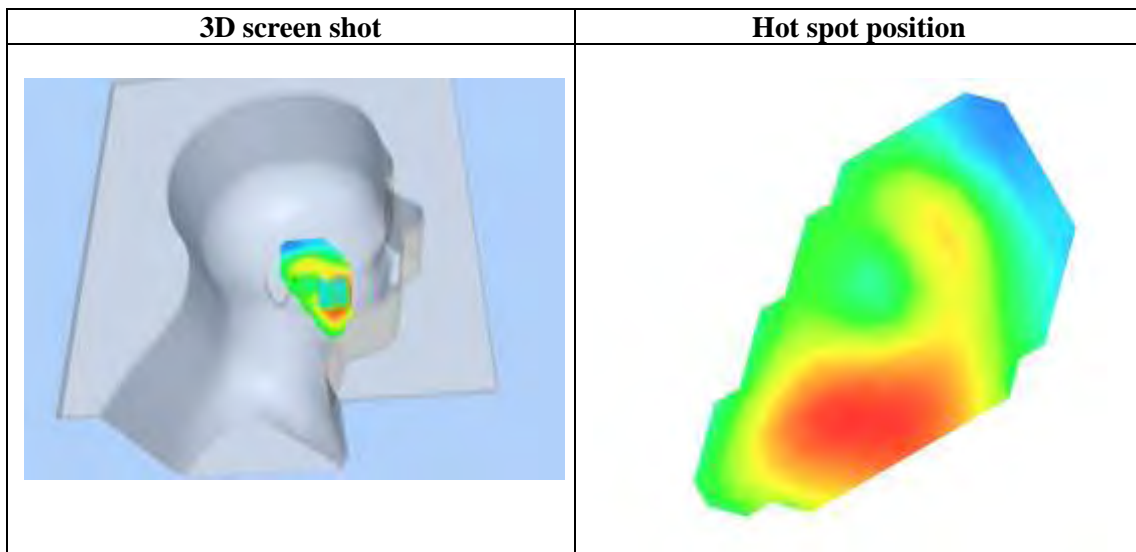
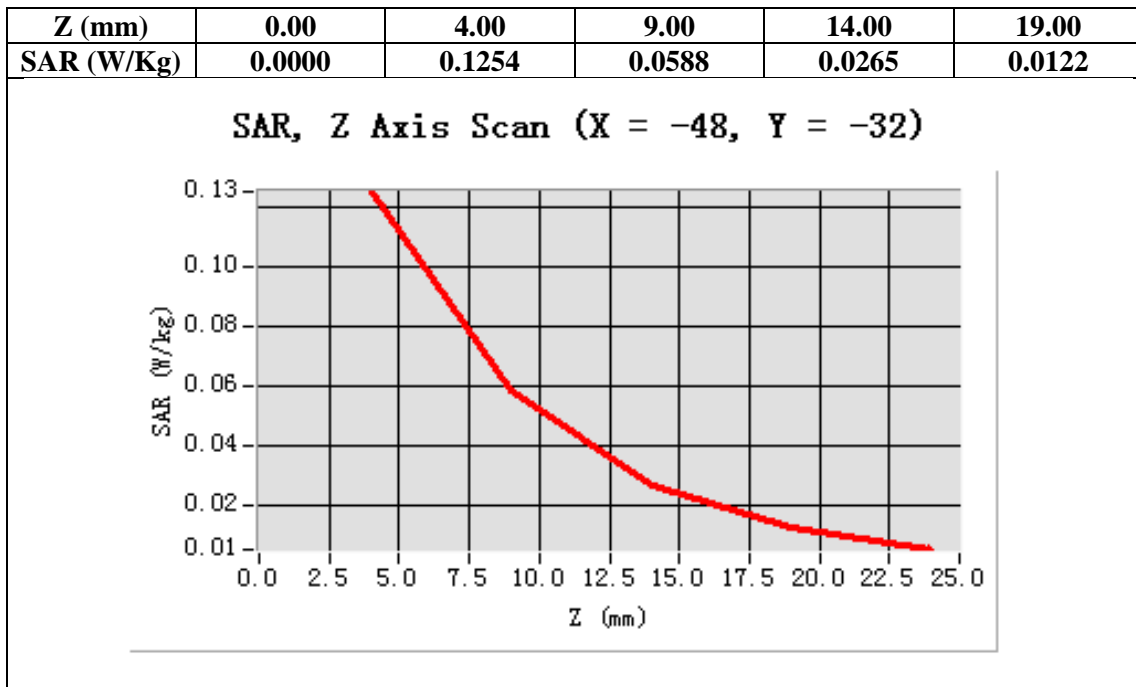

Test Laboratory: AGC Lab

Date: Oct.16,2014

WCDMA Band V Low-Body-Towards Grounds (RMC)

DUT: mobile phone; Type: AM503

Communication System: UMTS; Communication System Band: BAND V UTRA/FDD; Duty Cycle:1: 1; Conv.F=5.48  
Frequency: 826.4 MHz; Medium parameters used:  $f = 835\text{MHz}$ ;  $\sigma = 0.96\text{mho/m}$ ;  $\epsilon_r = 55.42$ ;  $\rho = 1000\text{ kg/m}^3$  ;  
Phantom section: Flat Section  
Ambient temperature ( $^{\circ}\text{C}$ ):21, Liquid temperature ( $^{\circ}\text{C}$ ):21

SATIMO Configuration:

- Probe: SSE5; Calibrated: 01/12/2014; Serial No.:SN 22/12 EP159
- Sensor-Surface: 4mm (Mechanical Surface Detection)
- Phantom: Flat Phantom; Type: Elliptical Phantom
- Measurement SW: OpenSAR V4\_02\_01

Configuration/ WCDMA Band V Low -Body-Back/Area Scan: Measurement grid: dx=8mm, dy=8mm

Configuration/ WCDMA Band V Low -Body-Back/Zoom Scan: Measurement grid: dx=8mm,dy=8mm, dz=5mm;

Area Scan	surf_sam_plan.txt
ZoomScan	5x5x7,dx=8mm dy=8mm dz=5mm,Very fast
Phantom	Validation plane
Device Position	Body Back
Band	WCDMA Band V
Channels	Low
Signal	CDMA (Crest factor: 1.0)

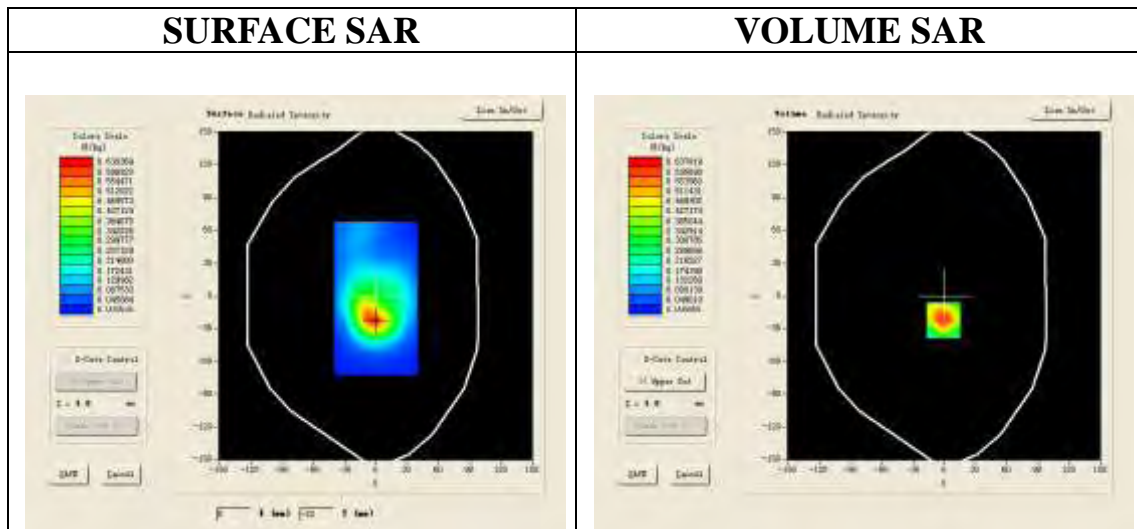

Maximum location: X=-1.00, Y=-22.00

SAR 10g (W/Kg)	0.288952
SAR 1g (W/Kg)	0.600257

Z (mm)	0.00	4.00	9.00	14.00	19.00
SAR (W/Kg)	0.0000	0.6378	0.2872	0.1247	0.0570

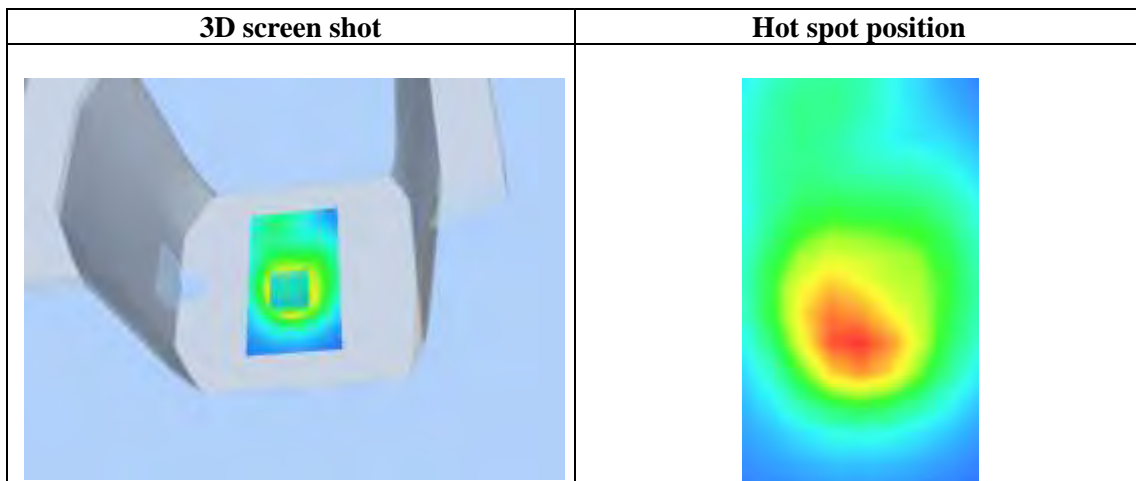
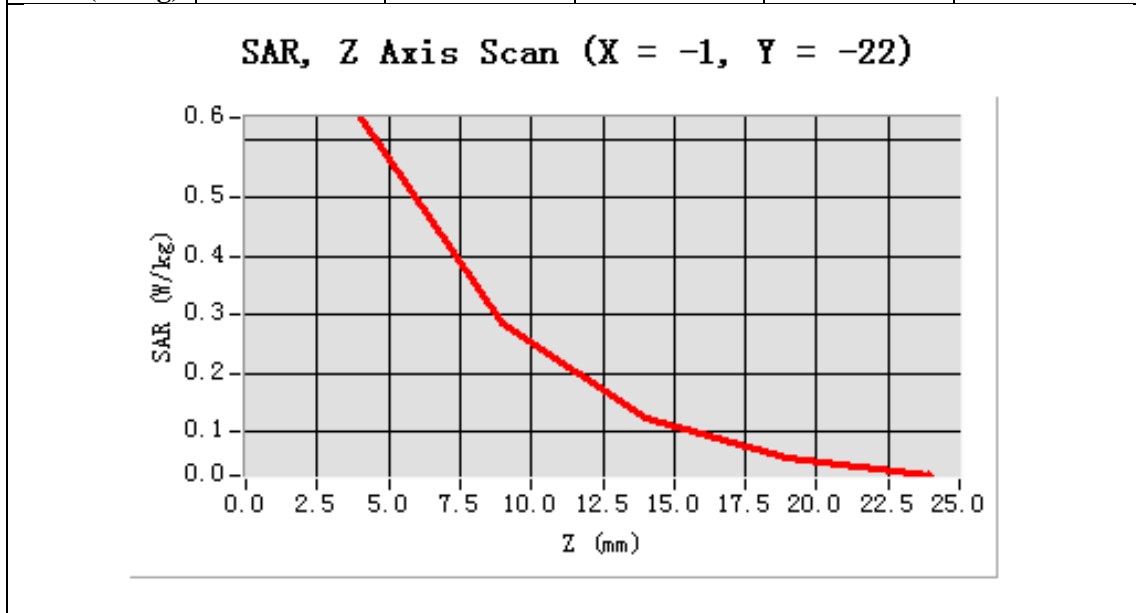

Test Laboratory: AGC Lab

Date: Oct.16,2014

WCDMA Band V Mid-Body-Towards Grounds (RMC)

DUT: mobile phone; Type: AM503

Communication System: UMTS; Communication System Band: BAND V UTRA/FDD; Duty Cycle:1: 1; Conv.F=5.48  
Frequency: 836.6 MHz; Medium parameters used:  $f = 835\text{MHz}$ ;  $\sigma = 0.98\text{ mho/m}$ ;  $\epsilon_r = 55.10$ ;  $\rho = 1000\text{ kg/m}^3$  ;  
Phantom section: Flat Section  
Ambient temperature ( $^{\circ}\text{C}$ ):21, Liquid temperature ( $^{\circ}\text{C}$ ):21

SATIMO Configuration:

- Probe: SSE5; Calibrated: 01/12/2014; Serial No.:SN 22/12 EP159
- Sensor-Surface: 4mm (Mechanical Surface Detection)
- Phantom: Flat Phantom; Type: Elliptical Phantom
- Measurement SW: OpenSAR V4\_02\_01

Configuration/ WCDMA Band V Mid-Body-Back/Area Scan: Measurement grid: dx=8mm, dy=8mm

Configuration/ WCDMA Band V Mid-Body-Back/Zoom Scan: Measurement grid: dx=8mm,dy=8mm, dz=5mm;

Area Scan	surf_sam_plan.txt
ZoomScan	5x5x7,dx=8mm dy=8mm dz=5mm,Very fast
Phantom	Validation plane
Device Position	Body Back
Band	WCDMA Band V
Channels	Middle
Signal	CDMA (Crest factor: 1.0)

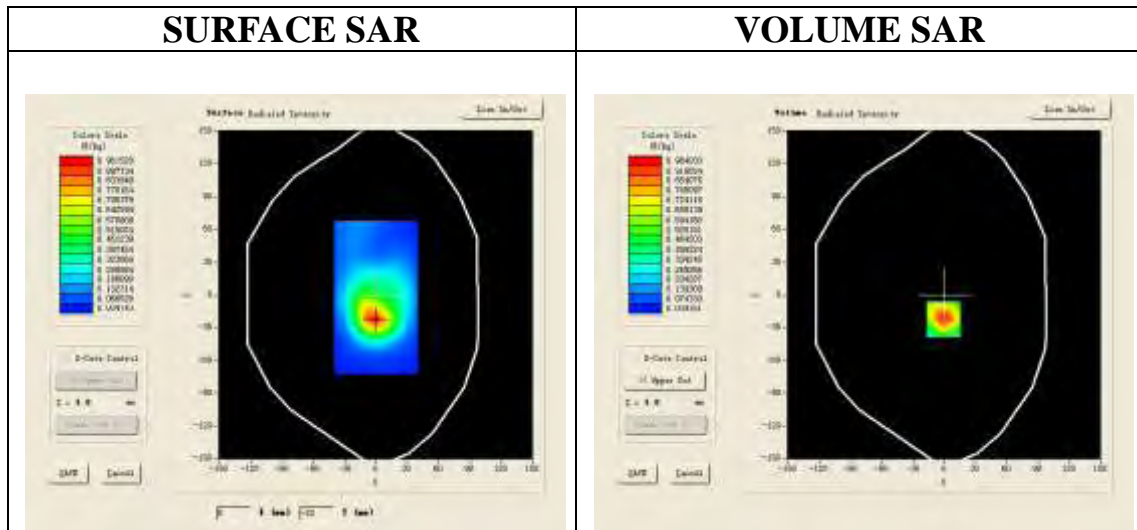

Maximum location: X=-1.00, Y=-22.00

SAR 10g (W/Kg)	0.445313
SAR 1g (W/Kg)	0.924276

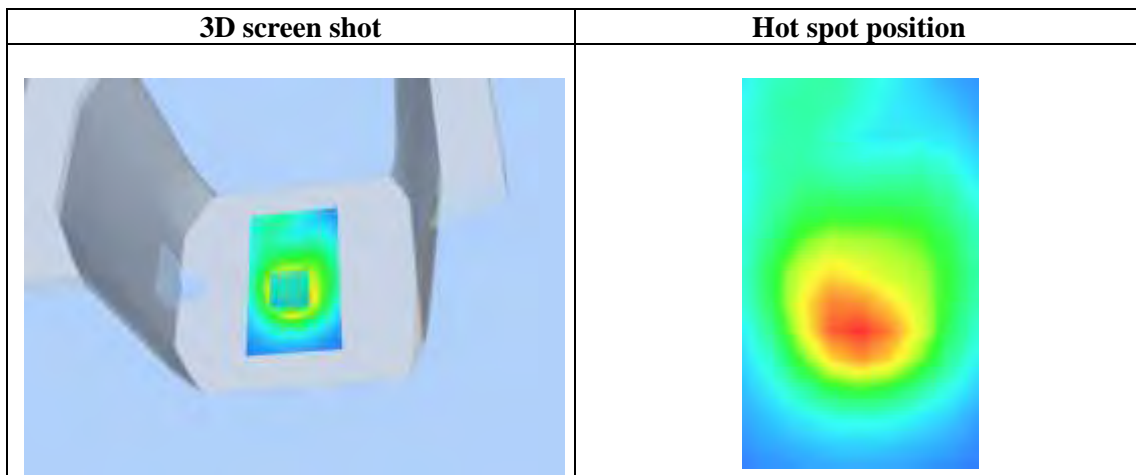
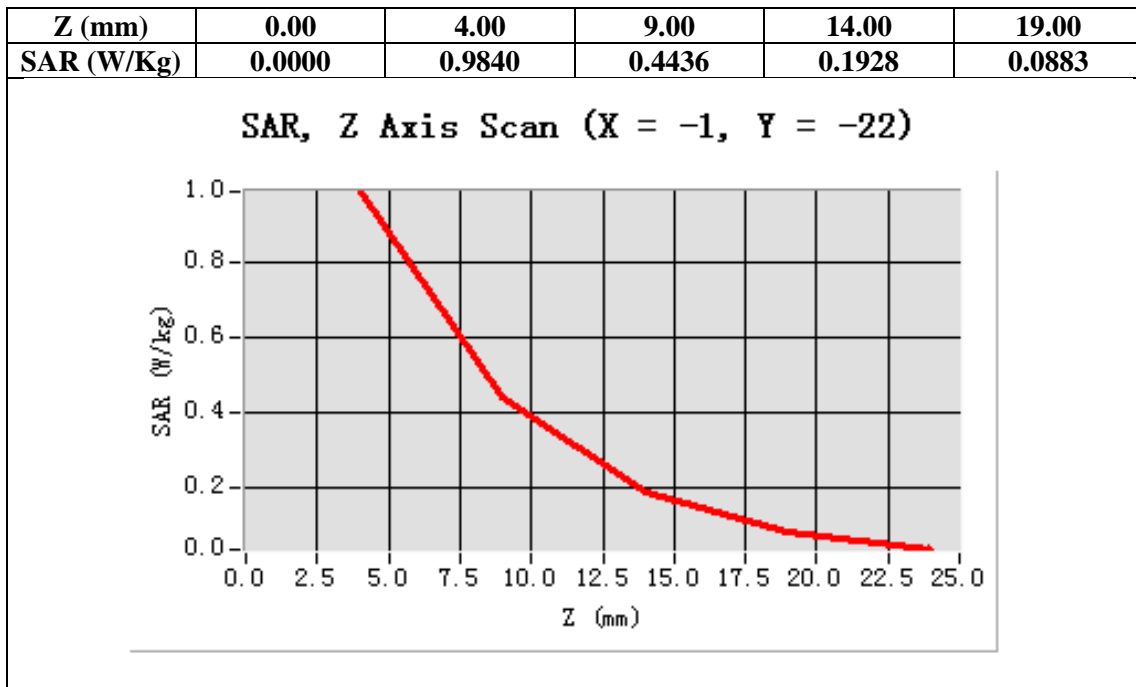

Test Laboratory: AGC Lab

Date: Oct.16,2014

WCDMA Band V High-Body-Towards Grounds (RMC)

DUT: mobile phone; Type: AM503

Communication System: UMTS; Communication System Band: BAND V UTRA/FDD; Duty Cycle:1: 1; Conv.F=5.48  
Frequency: 846.6 MHz; Medium parameters used:  $f = 835\text{MHz}$ ;  $\sigma = 0.97\text{ mho/m}$ ;  $\epsilon_r = 55.23$ ;  $\rho = 1000\text{ kg/m}^3$  ;  
Phantom section: Flat Section  
Ambient temperature ( $^{\circ}\text{C}$ ):21, Liquid temperature ( $^{\circ}\text{C}$ ):21

SATIMO Configuration:

- Probe: SSE5; Calibrated: 01/12/2014; Serial No.:SN 22/12 EP159
- Sensor-Surface: 4mm (Mechanical Surface Detection)
- Phantom: Flat Phantom; Type: Elliptical Phantom
- Measurement SW: OpenSAR V4\_02\_01

Configuration/ WCDMA Band V High -Body-Back/Area Scan: Measurement grid:  $dx=8\text{mm}$ ,  $dy=8\text{mm}$

Configuration/ WCDMA Band V High -Body-Back/Zoom Scan: Measurement grid:  $dx=8\text{mm}$ ,  $dy=8\text{mm}$ ,  $dz=5\text{mm}$ ;

Area Scan	surf_sam_plan.txt
ZoomScan	5x5x7,dx=8mm dy=8mm dz=5mm,Very fast
Phantom	Validation plane
Device Position	Body Back
Band	WCDMA Band V
Channels	High
Signal	CDMA (Crest factor: 1.0)

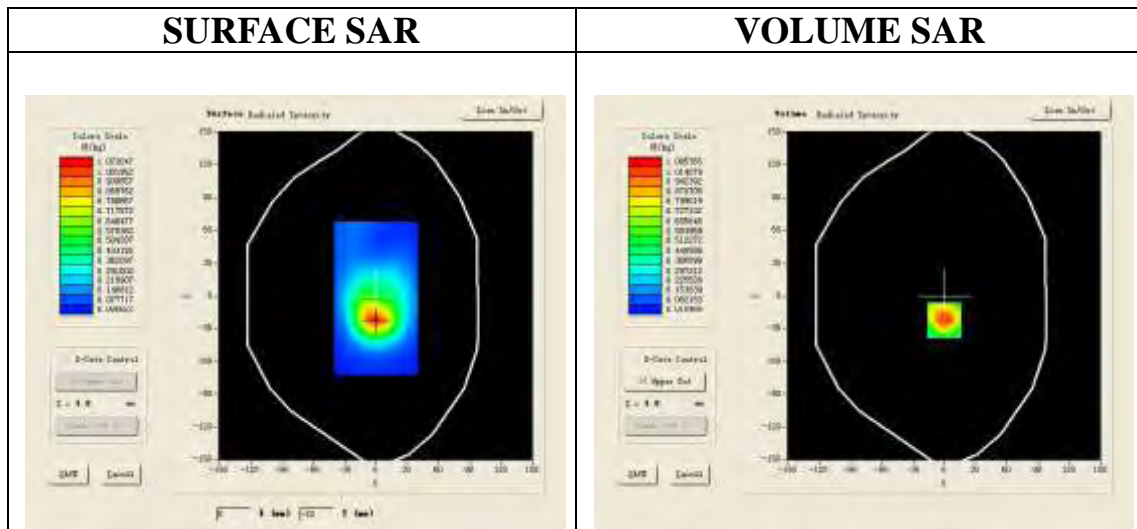

Maximum location: X=0.00, Y=-22.00

SAR 10g (W/Kg)	0.489719
SAR 1g (W/Kg)	1.024032

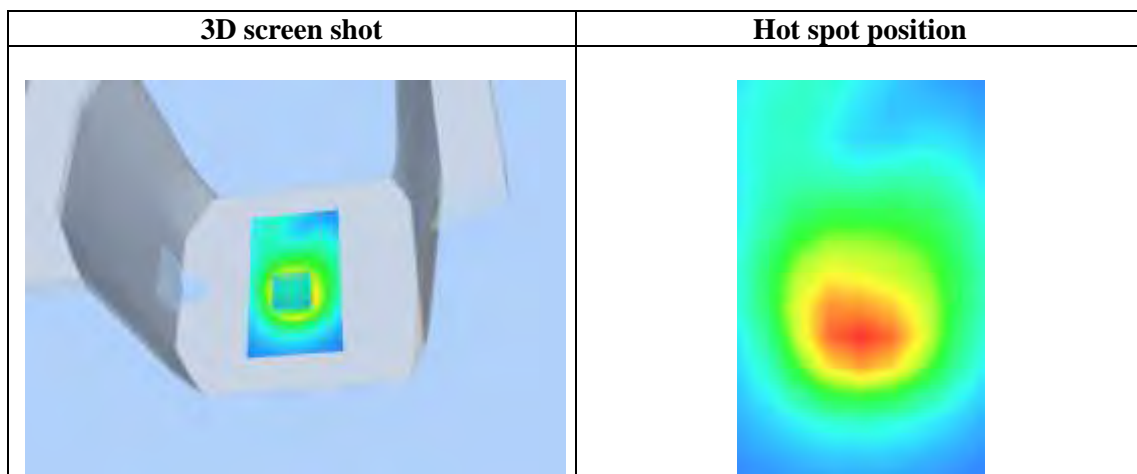
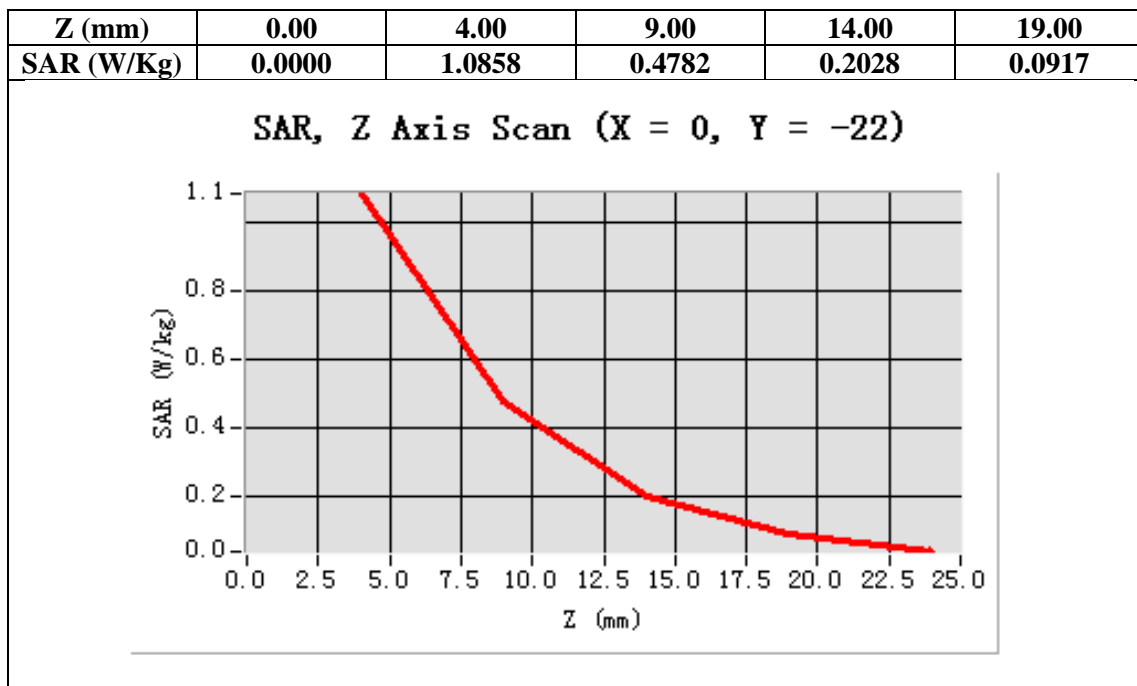



Test Laboratory: AGC Lab

Date: Oct.16,2014

WCDMA Band V Mid- Body - Towards Phantom (RMC)

DUT: mobile phone; Type: AM503

Communication System: UMTS; Communication System Band: BAND V UTRA/FDD ; Duty Cycle:1: 1; Conv.F=5.48  
Frequency: 836.6 MHz; Medium parameters used:  $f = 835\text{MHz}$ ;  $\sigma=0.98\text{ mho/m}$ ;  $\epsilon_r = 55.10$ ;  $\rho = 1000\text{kg/m}^3$  ;  
Phantom section: Flat Section  
Ambient temperature ( $^{\circ}\text{C}$ ):21, Liquid temperature ( $^{\circ}\text{C}$ ):21

SATIMO Configuration:

- Probe: SSE5; Calibrated: 01/12/2014; Serial No.:SN 22/12 EP159
- Sensor-Surface: 4mm (Mechanical Surface Detection)
- Phantom: Flat Phantom; Type: Elliptical Phantom
- Measurement SW: OpenSAR V4\_02\_01

Configuration/ WCDMA Band V Mid-Body-Front/Area Scan: Measurement grid: dx=8mm, dy=8mm

Configuration/ WCDMA Band V Mid-Body-Front/Zoom Scan: Measurement grid: dx=8mm, dy=8mm, dz=5mm;

Area Scan	surf_sam_plan.txt
ZoomScan	5x5x7,dx=8mm dy=8mm dz=5mm,Very fast
Phantom	Validation plane
Device Position	Body Front
Band	WCDMA Band V
Channels	Middle
Signal	CDMA (Crest factor: 1.0)

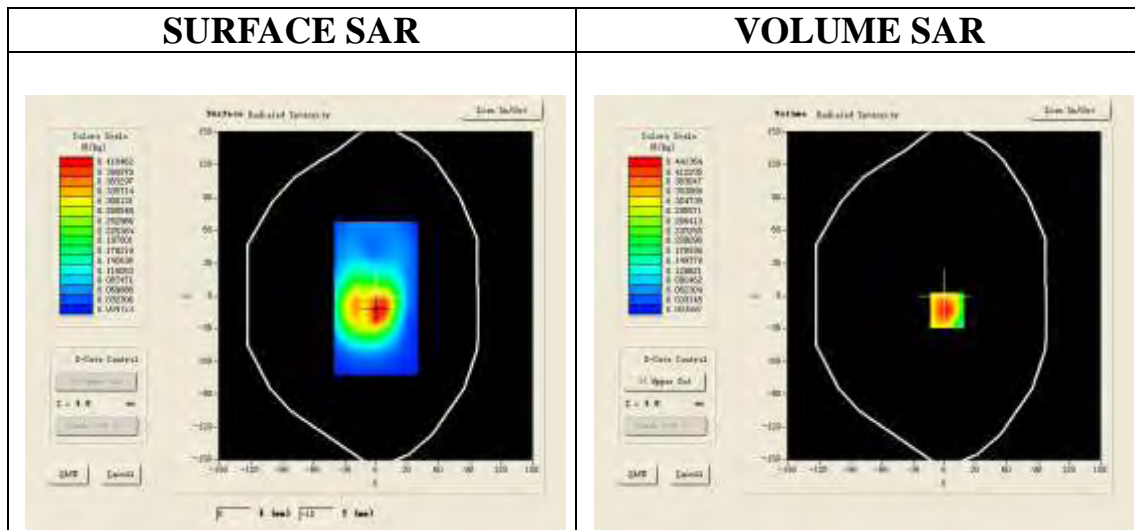

Maximum location: X=3.00, Y=-13.00

SAR 10g (W/Kg)	0.206885
SAR 1g (W/Kg)	0.421026

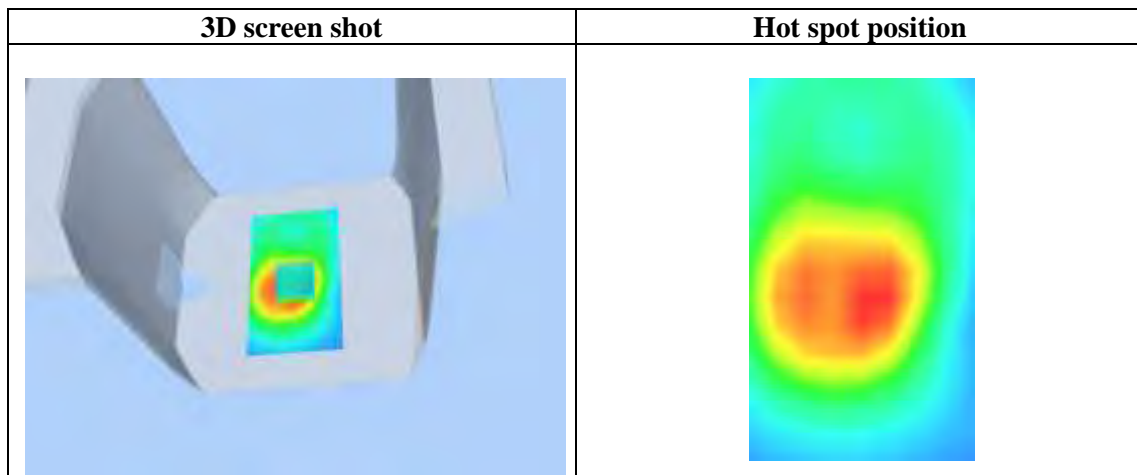
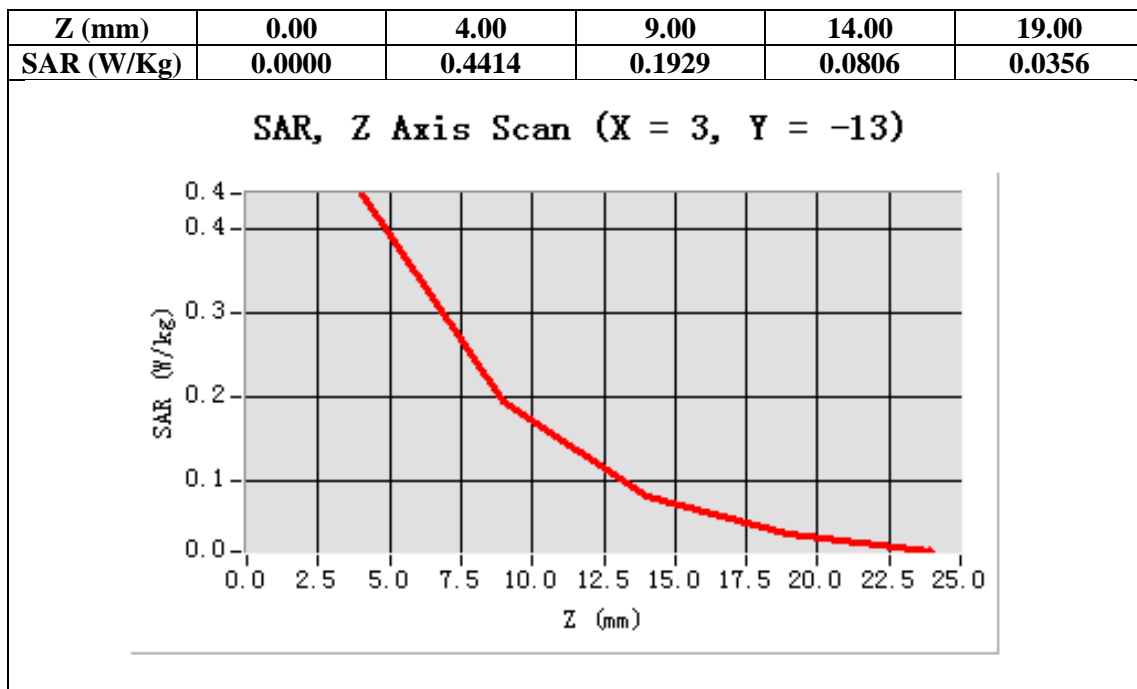

**HOTSPOT MODE**

Test Laboratory: AGC Lab  
Hotspot Mid-Body-Worn- Back (DTS)  
DUT: mobile phone; Type: AM503

Date: Oct.16,2014

Communication System: Wi-Fi; Communication System Band: Hotspot; Duty Cycle: 1:1; Conv.F=4.31;  
Frequency: 2437 MHz; Medium parameters used:  $f = 2450$  MHz;  $\sigma=1.95$  mho/m;  $\epsilon_r =52.06$ ;  $\rho= 1000$  kg/m<sup>3</sup> ;  
Phantom section: Flat Section  
Ambient temperature (°C):21, Liquid temperature (°C):21

SATIMO Configuration:

- Probe: SSE5; Calibrated: 01/12/2014; Serial No.:SN 22/12 EP159
- Sensor-Surface: 4mm (Mechanical Surface Detection)
- Phantom: Flat Phantom; Type: Elliptical Phantom
- Measurement SW: OpenSAR V4\_02\_01

Configuration/Hotspot Mid- Body- Back /Area Scan: Measurement grid: dx=8mm, dy=8mm  
Configuration/Hotspot Mid- Body- Back /Zoom Scan: Measurement grid: dx=8mm,dy=8mm, dz=5mm;

Area Scan	surf_sam_plan.txt
ZoomScan	5x5x7,dx=8mm dy=8mm dz=5mm,Very fast
Phantom	Validation plane
Device Position	Body Back
Band	2450MHz
Channels	Middle
Signal	Crest factor: 1.0

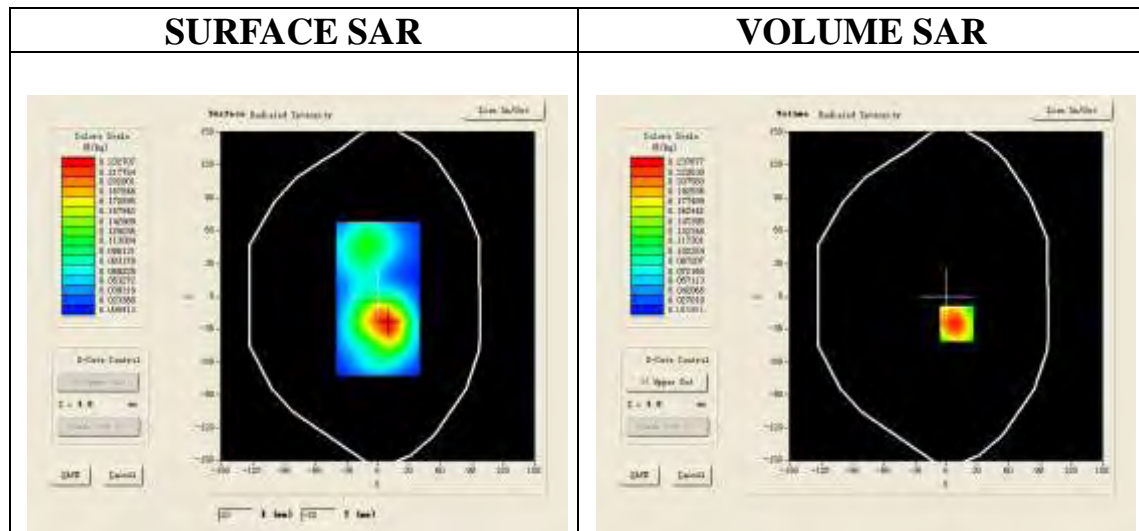

Maximum location: X=10.00, Y=-25.00

SAR 10g (W/Kg)	0.140395
SAR 1g (W/Kg)	0.242149

Z (mm)	0.00	4.00	9.00	14.00	19.00
SAR (W/Kg)	0.0000	0.2392	0.1352	0.0806	0.0482

**SAR, Z Axis Scan (X = 10, Y = -25)**

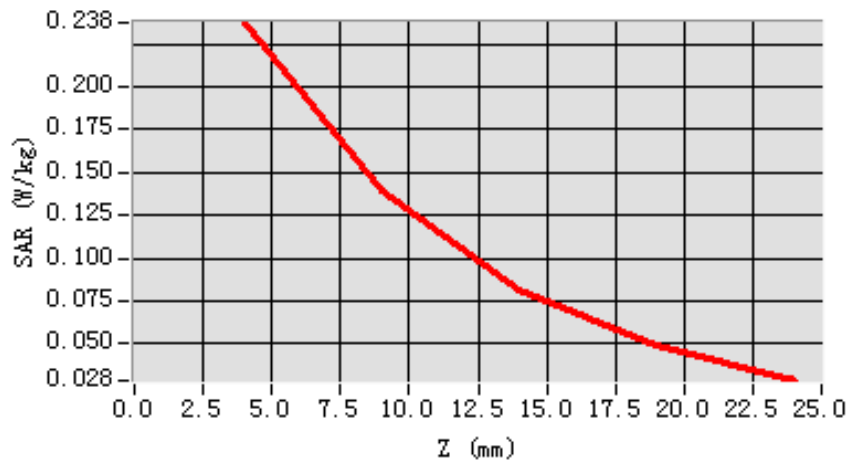

**3D screen shot**



**Hot spot position**

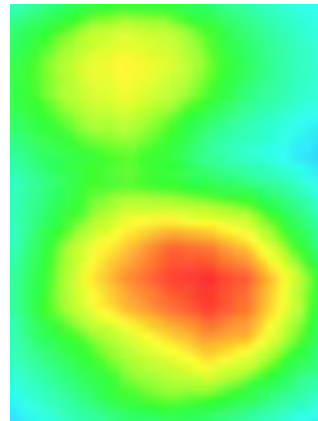

**Test Laboratory: AGC Lab**  
**Hotspot Mid-Body -Front (DTS)**  
**DUT: mobile phone; Type: AM503**

**Date: Oct.16,2014**

Communication System: Wi-Fi; Communication System Band: Hotspot; Duty Cycle: 1:1; Conv.F=4.31;  
Frequency: 2437 MHz; Medium parameters used:  $f = 2450$  MHz;  $\sigma = 1.95$  mho/m;  $\epsilon_r = 52.06$ ;  $\rho = 1000$  kg/m<sup>3</sup> ;  
Phantom section: Flat Section  
Ambient temperature (°C):21, Liquid temperature (°C):21

SATIMO Configuration:

- Probe: SSE5; Calibrated: 01/12/2014; Serial No.:SN 22/12 EP159
- Sensor-Surface: 4mm (Mechanical Surface Detection)
- Phantom: Flat Phantom; Type: Elliptical Phantom
- Measurement SW: OpenSAR V4\_02\_01

**Configuration/Hotspot Mid-Body- Front /Area Scan:** Measurement grid: dx=8mm, dy=8mm  
**Configuration/Hotspot Mid-Body- Front /Zoom Scan:** Measurement grid: dx=8mm,dy=8mm, dz=5mm;

<b>Area Scan</b>	surf_sam_plan.txt
<b>ZoomScan</b>	5x5x7,dx=8mm dy=8mm dz=5mm,Very fast
<b>Phantom</b>	Validation plane
<b>Device Position</b>	Body Front
<b>Band</b>	2450MHz
<b>Channels</b>	Middle
<b>Signal</b>	Crest factor: 1.0

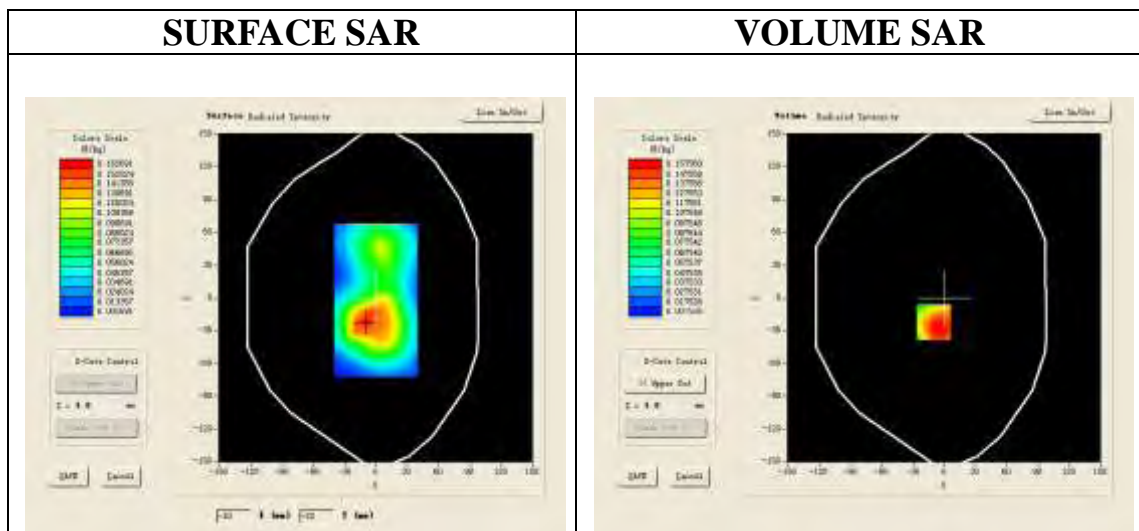

**Maximum location: X=-10.00, Y=-22.00**

<b>SAR 10g (W/Kg)</b>	0.097271
<b>SAR 1g (W/Kg)</b>	0.162125

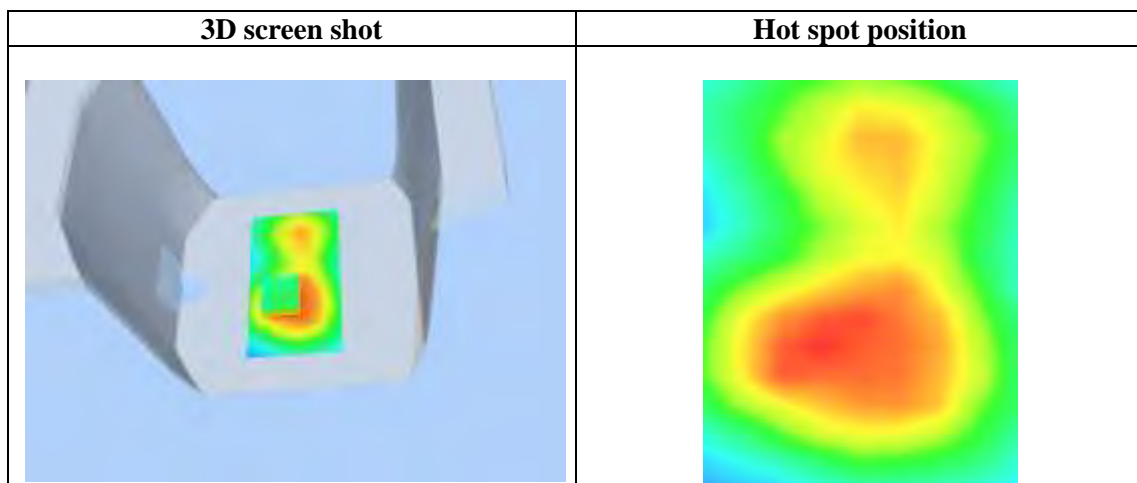
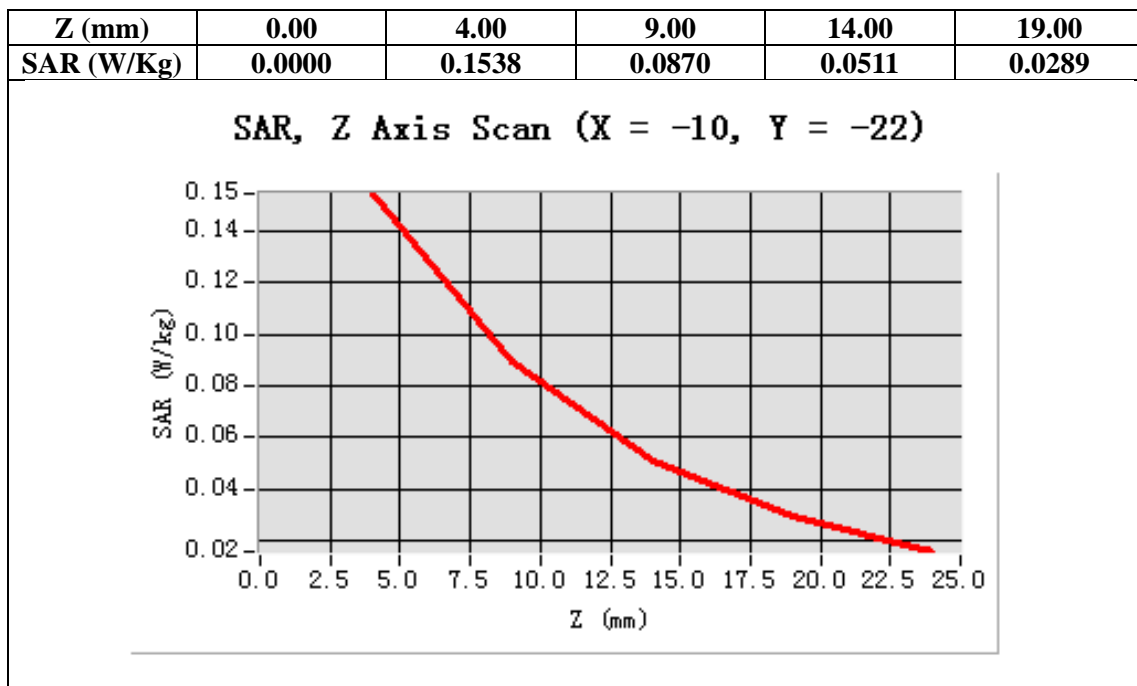

**Repeated SAR**

Test Laboratory: AGC Lab

Date: Oct.16,2014

GSM 850 High- Body- Back <SIM 1>

DUT: mobile phone; Type: AM503

Communication System: Generic GSM; Communication System Band: GSM 835; Duty Cycle: 1:8.3; Conv.F=5.48;  
Frequency: 848.8 MHz; Medium parameters used: f = 835 MHz;  $\sigma = 0.97\text{mho/m}$ ;  $\epsilon_r = 55.23$ ;  $\rho = 1000\text{ kg/m}^3$  ;  
Phantom section: Flat Section  
Ambient temperature (°C): 21.0, Liquid temperature (°C): 21.0

SATIMO Configuration:

- Probe: SSE5; Calibrated: 01/12/2014; Serial No.:SN 22/12 EP159
- Sensor-Surface: 4mm (Mechanical Surface Detection)
- Phantom: Flat Phantom; Type: Elliptical Phantom
- Measurement SW: OpenSAR V4\_02\_01

Configuration/GSM 850 High -Body-Back/Area Scan: Measurement grid: dx=8mm, dy=8mm

Configuration/GSM 850 High -Body-Back/Zoom Scan: Measurement grid: dx=8mm,dy=8mm, dz=5mm;

Area Scan	surf_sam_plan.txt
ZoomScan	5x5x7,dx=8mm dy=8mm dz=5mm,Very fast
Phantom	Validation plane
Device Position	Body Back
Band	GSM 850
Channels	High
Signal	TDMA (Crest factor: 8.0)

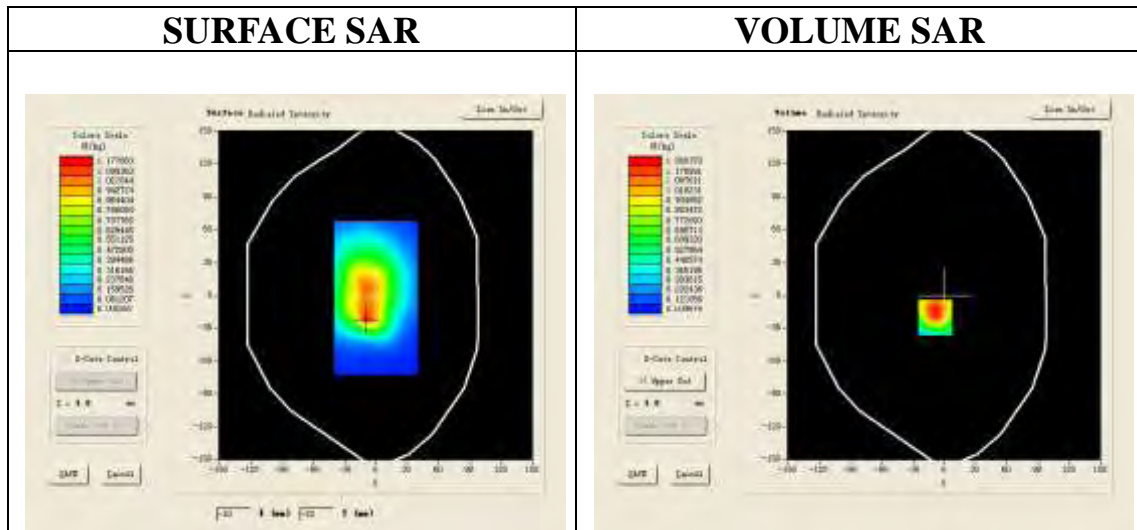

**Maximum location: X=-9.00, Y=-20.00**

<b>SAR 10g (W/Kg)</b>	0.701257
<b>SAR 1g (W/Kg)</b>	1.191233

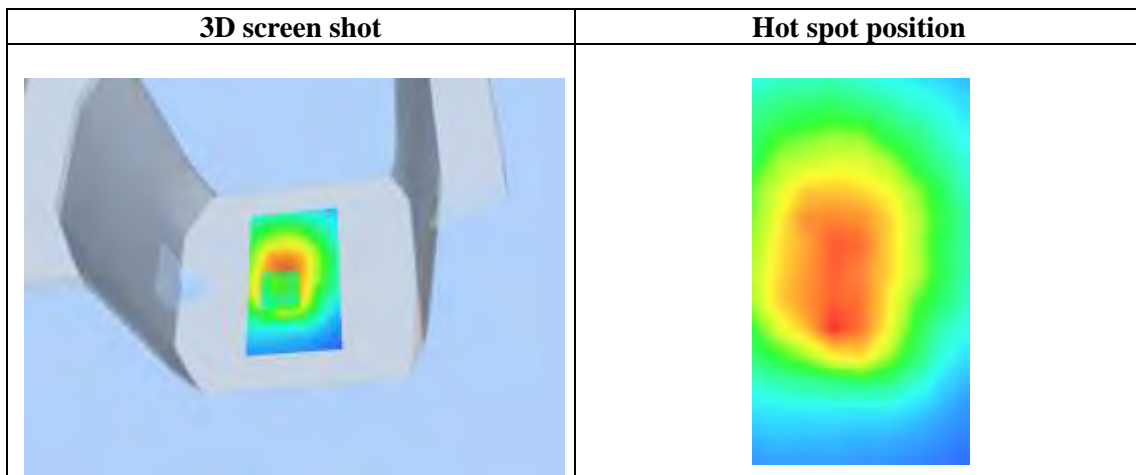
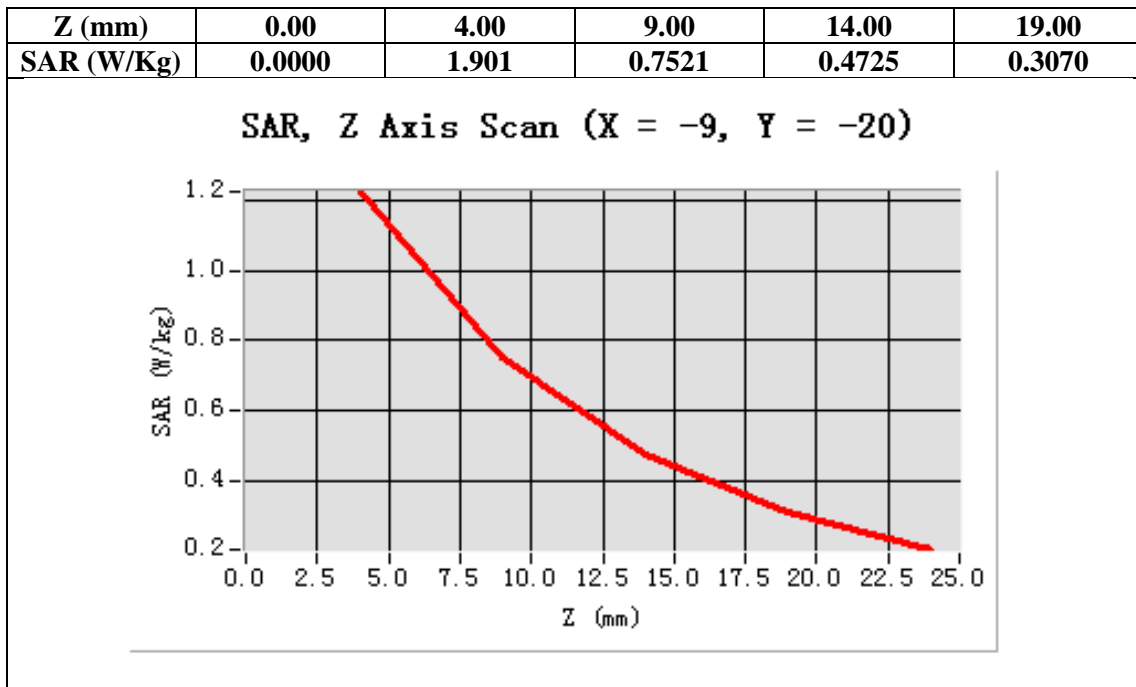



**Test Laboratory: AGC Lab**  
**WCDMA Band II High-Body-Towards Grounds (RMC 12.2kbps)**  
**DUT: mobile phone; Type: AM503**

**Date: Oct.16,2014**

Communication System: UMTS; Communication System Band: Band II UTRA/FDD ;Duty Cycle:1:1; Conv.F=4.45  
Frequency: 1907.6 MHz; Medium parameters used:  $f = 1900$  MHz;  $\sigma=1.50$ mho/m;  $\epsilon_r =53.08$ ;  $\rho= 1000$  kg/m<sup>3</sup> ;  
Phantom section: Flat Section  
Ambient temperature (°C):21, Liquid temperature (°C):21

SATIMO Configuration:

- Probe: SSE5; Calibrated: 01/12/2014; Serial No.:SN 22/12 EP159
- Sensor-Surface: 4mm (Mechanical Surface Detection)
- Phantom: Flat Phantom; Type: Elliptical Phantom
- Measurement SW: OpenSAR V4\_02\_01

**Configuration/ WCDMA band II High -Body-back/Area Scan:** Measurement grid: dx=8mm, dy=8mm  
**Configuration/ WCDMA band II High -Body-back/Zoom Scan:** Measurement grid: dx=8mm,dy=8mm, dz=5mm;

<b>Area Scan</b>	surf_sam_plan.txt
<b>ZoomScan</b>	5x5x7,dx=8mm dy=8mm dz=5mm,Very fast
<b>Phantom</b>	Validation plane
<b>Device Position</b>	Body Back
<b>Band</b>	WCDMA band II
<b>Channels</b>	High
<b>Signal</b>	CDMA (Crest factor: 1.0)

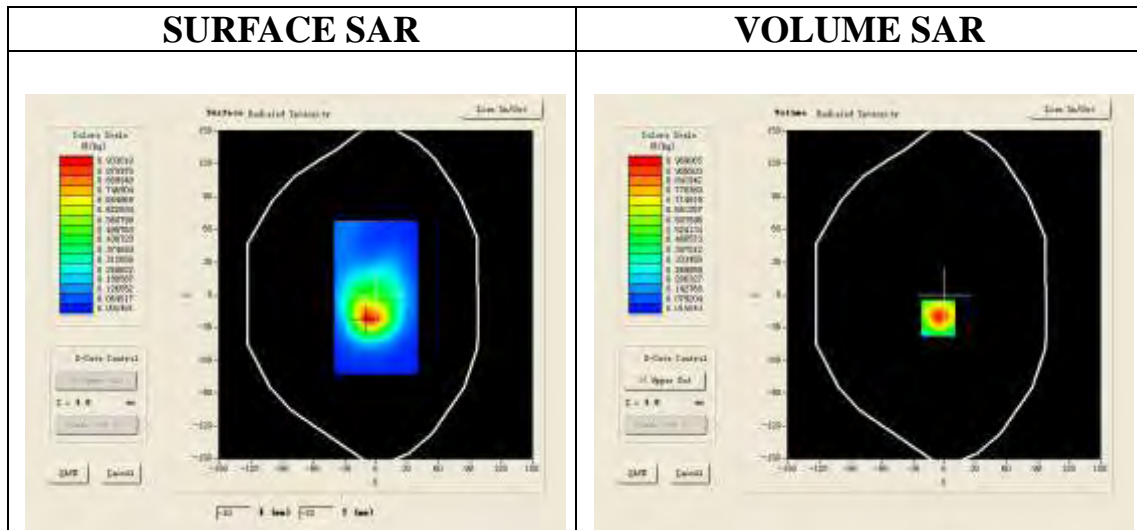

**Maximum location: X=-6.00, Y=-21.00**

<b>SAR 10g (W/Kg)</b>	0.466891
<b>SAR 1g (W/Kg)</b>	0.905233

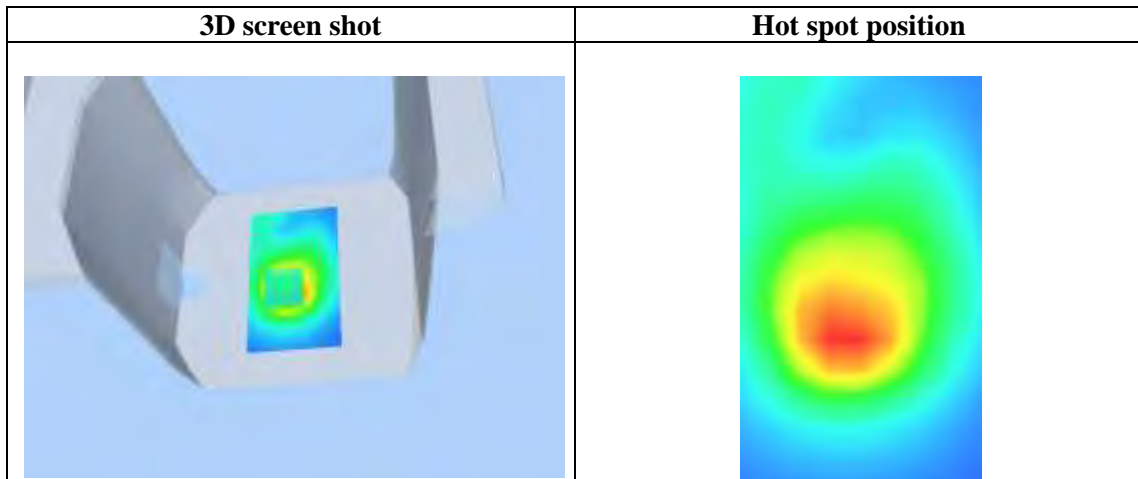
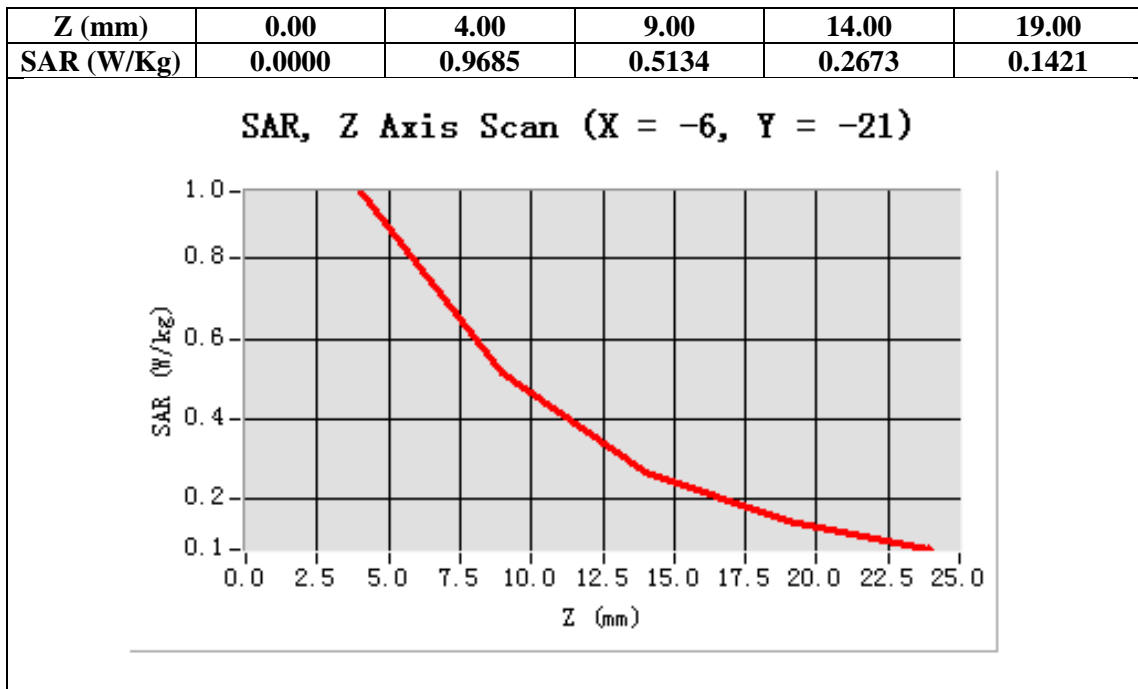

Test Laboratory: AGC Lab

Date: Oct.16,2014

WCDMA Band V High-Body-Towards Grounds (RMC)

DUT: mobile phone; Type: AM503

Communication System: UMTS; Communication System Band: BAND V UTRA/FDD; Duty Cycle:1: 1; Conv.F=5.48  
Frequency: 846.6 MHz; Medium parameters used:  $f = 835\text{MHz}$ ;  $\sigma = 0.97\text{ mho/m}$ ;  $\epsilon_r = 55.23$ ;  $\rho = 1000\text{ kg/m}^3$  ;  
Phantom section: Flat Section  
Ambient temperature ( $^{\circ}\text{C}$ ):21, Liquid temperature ( $^{\circ}\text{C}$ ):21

SATIMO Configuration:

- Probe: SSE5; Calibrated: 01/12/2014; Serial No.:SN 22/12 EP159
- Sensor-Surface: 4mm (Mechanical Surface Detection)
- Phantom: Flat Phantom; Type: Elliptical Phantom
- Measurement SW: OpenSAR V4\_02\_01

Configuration/ WCDMA Band V High -Body-Back/Area Scan: Measurement grid:  $dx=8\text{mm}$ ,  $dy=8\text{mm}$

Configuration/ WCDMA Band V High -Body-Back/Zoom Scan: Measurement grid:  $dx=8\text{mm}$ ,  $dy=8\text{mm}$ ,  $dz=5\text{mm}$ ;

Area Scan	surf_sam_plan.txt
ZoomScan	5x5x7,dx=8mm dy=8mm dz=5mm,Very fast
Phantom	Validation plane
Device Position	Body Back
Band	WCDMA Band V
Channels	High
Signal	CDMA (Crest factor: 1.0)

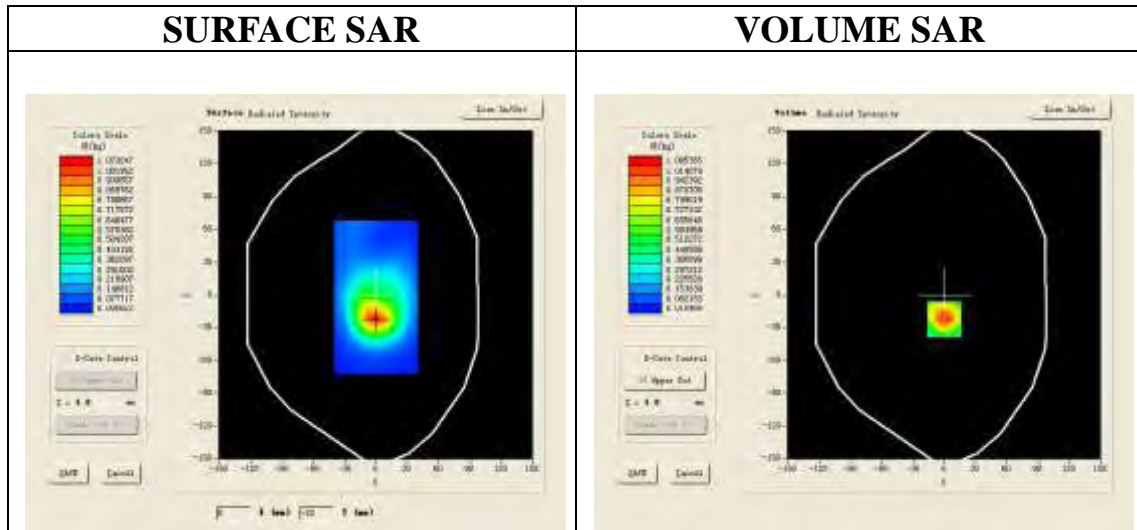

Maximum location: X=0.00, Y=-22.00

SAR 10g (W/Kg)	0.489687
SAR 1g (W/Kg)	1.022244

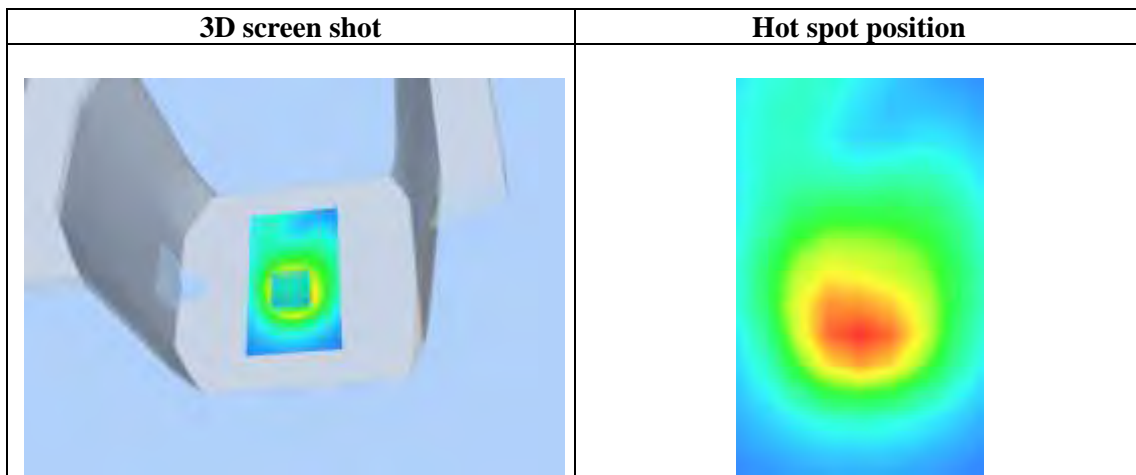
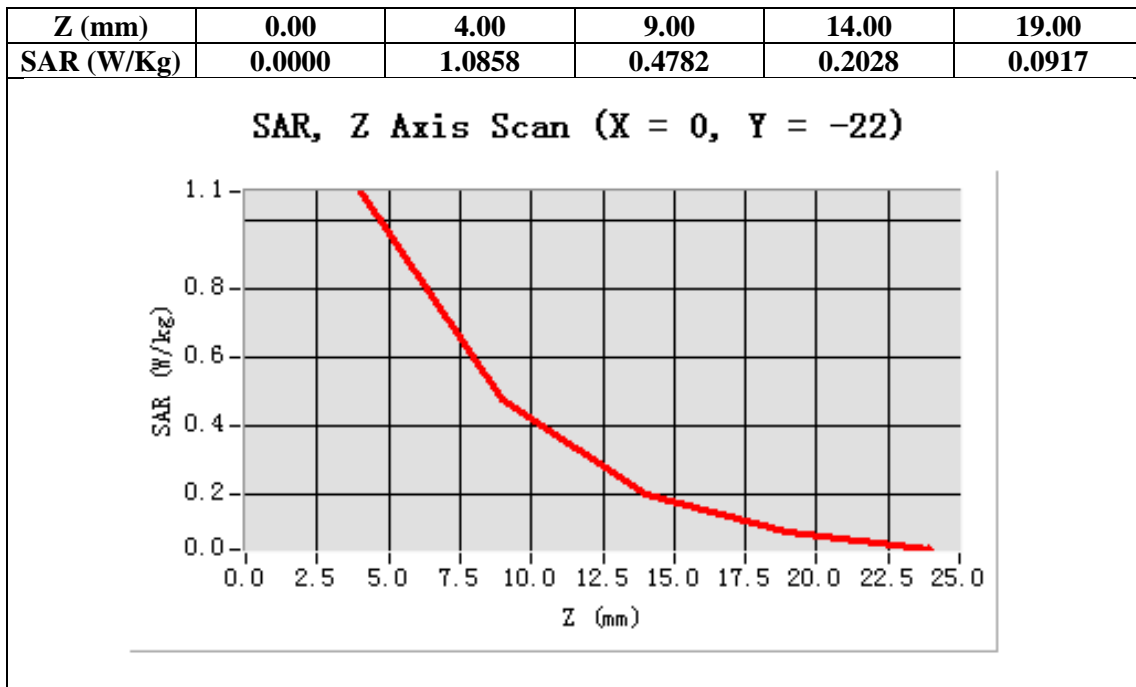

## APPENDIX C. TEST SETUP PHOTOGRAPHS & EUT PHOTOGRAPHS

### Test Setup Photographs

LEFT-CHECK TOUCH

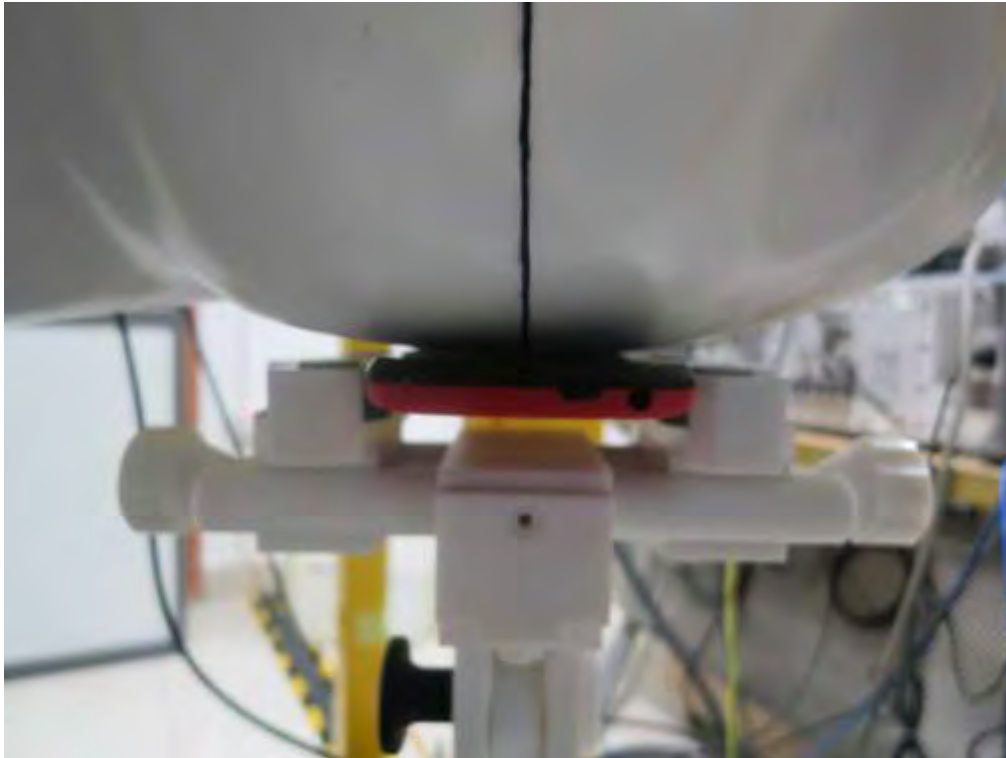

LEFT-TILT 15°

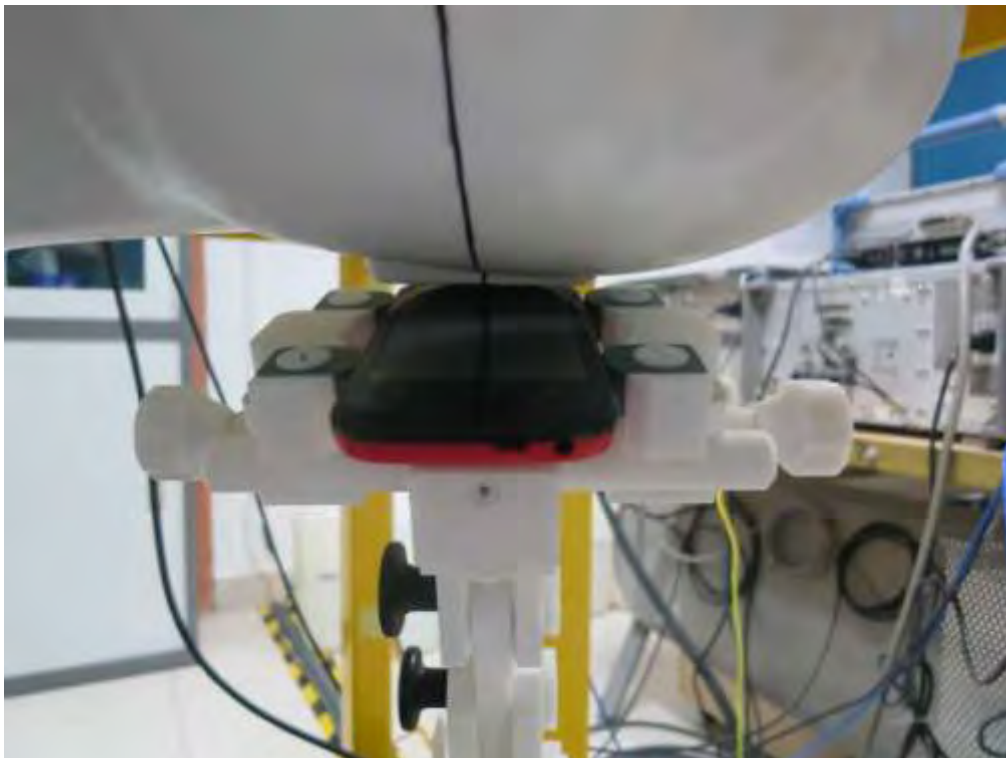

RIGHT-CHECK TOUCH

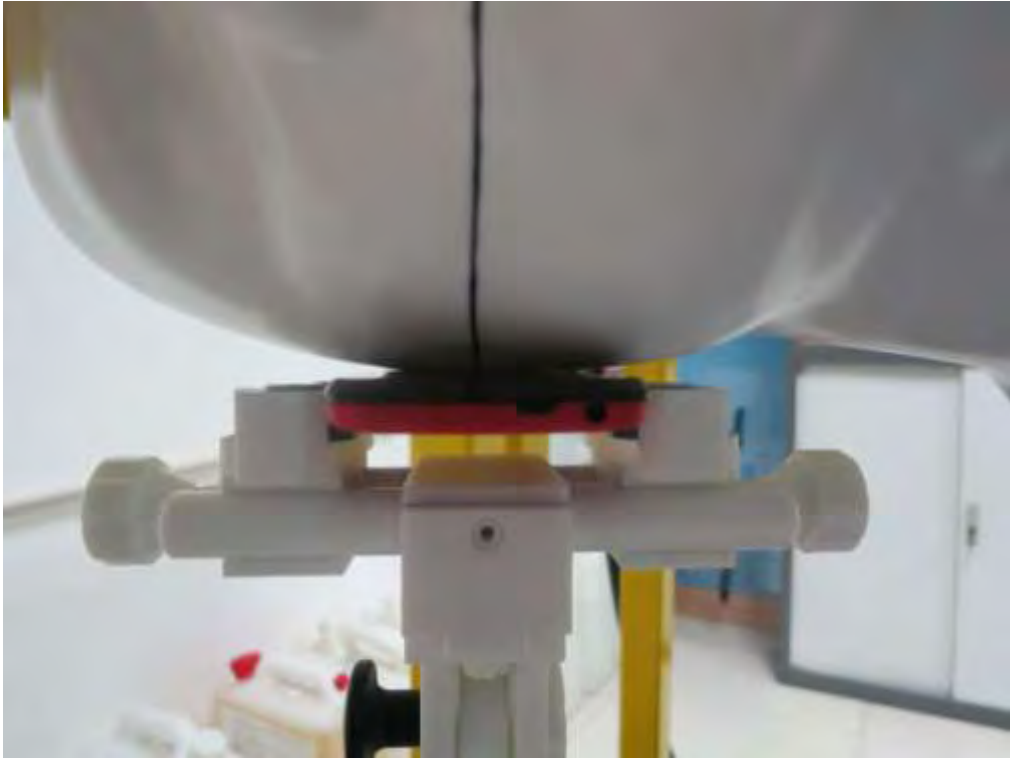

RIGHT-TILT 15°



Body Back 10mm



Body Front 10mm



### DEPTH OF THE LIQUID IN THE PHANTOM—ZOOM IN

Note : The position used in the measurement were according to IEEE 1528-2003





**EUT PHOTOGRAPHS**  
All VIEW OF EUT



TOP VIEW OF EUT



BOTTOM VIEW OF EUT



FRONT VIEW OF EUT



BACK VIEW OF EUT



LEFT VIEW OF EUT



RIGHT VIEW OF EUT



OPEN VIEW OF EUT-1



OPEN VIEW OF EUT-2



OPEN VIEW OF EUT-3



INTERNAL VIEW OF EUT-1

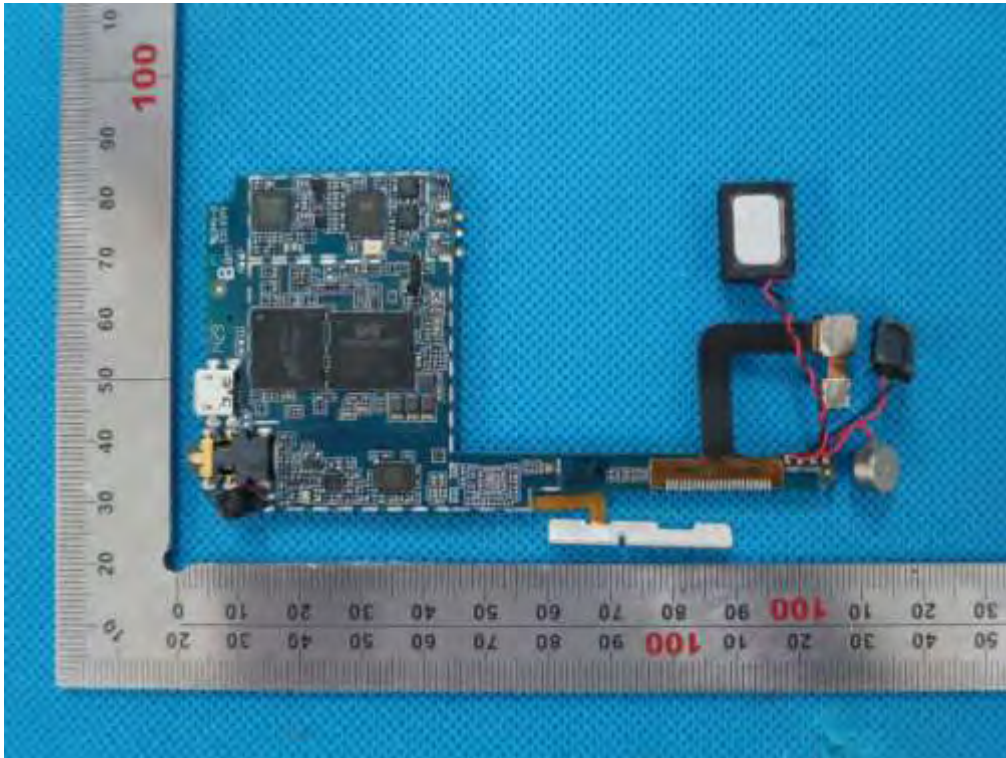

INTERNAL VIEW OF EUT-2

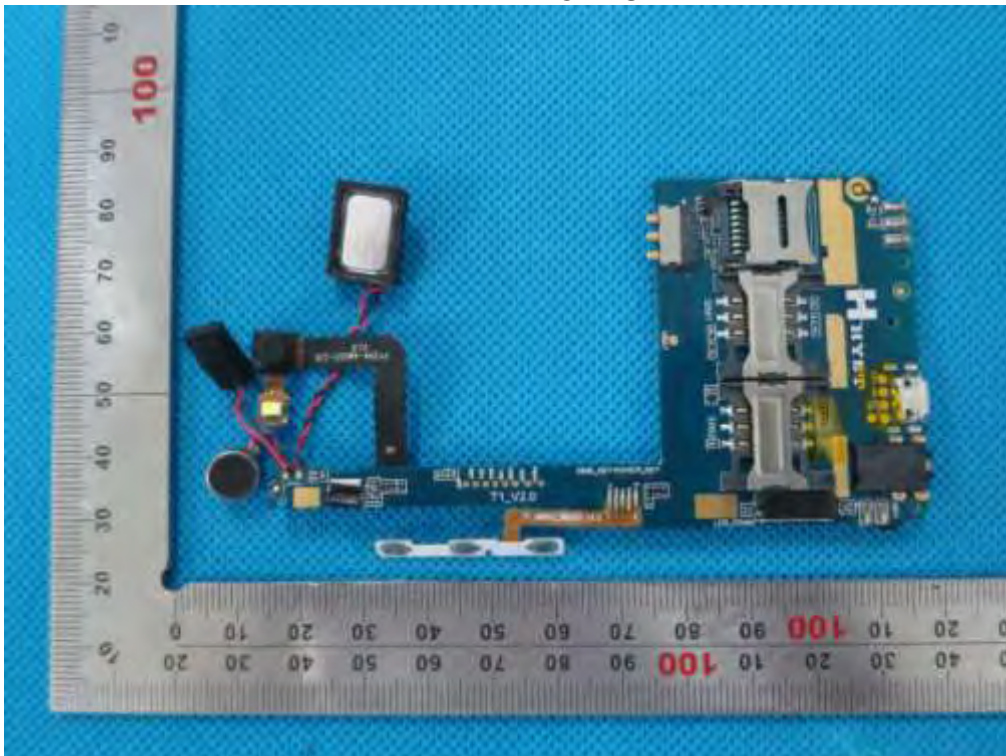

## APPENDIX D. PROBE CALIBRATION DATA



### COMOSAR E-Field Probe Calibration Report

Ref : ACR.351.1.14.SATU.A

**ATTESTATION OF GLOBAL COMPLIANCE CO.  
LTD.**

**1&2F, NO.2 BUILDING, HUAFENG NO.1 INDUSTRIAL  
PARK, GUSHU COMMUNITY XIXIANG STREET  
BAOAN DISTRICT, SHENZHEN, P.R. CHINA**

**SATIMO COMOSAR DOSIMETRIC E-FIELD PROBE**

**SERIAL NO.: SN 22/12 EP159**

**Calibrated at SATIMO US  
2105 Barrett Park Dr. - Kennesaw, GA 30144**



**01/12/14**

*Summary:*

This document presents the method and results from an accredited COMOSAR Dosimetric E-Field Probe calibration performed in SATIMO USA using the CALISAR / CALIBAIR test bench, for use with a SATIMO COMOSAR system only. All calibration results are traceable to national metrology institutions.



COMOSAR E-FIELD PROBE CALIBRATION REPORT

Ref ACR.351.1.14 SATU A

	<i>Name</i>	<i>Function</i>	<i>Date</i>	<i>Signature</i>
<i>Prepared by :</i>	Jérôme LUC	Product Manager	1/12/2014	<i>JS</i>
<i>Checked by :</i>	Jérôme LUC	Product Manager	1/12/2014	<i>JS</i>
<i>Approved by :</i>	Kim RUTKOWSKI	Quality Manager	1/12/2014	<i>Kim Rutkowski</i>

	<i>Customer Name</i>
<i>Distribution :</i>	ATTESTATION OF GLOBAL COMPLIANCE CO. LTD.

<i>Issue</i>	<i>Date</i>	<i>Modifications</i>
A	1/12/2014	Initial release





## TABLE OF CONTENTS

1	Device Under Test .....	4
2	Product Description.....	4
2.1	General Information .....	4
3	Measurement Method.....	4
3.1	Linearity .....	4
3.2	Sensitivity .....	5
3.3	Lower Detection Limit .....	5
3.4	Isotropy.....	5
3.5	Boundary Effect .....	5
4	Measurement Uncertainty .....	5
5	Calibration Measurement Results .....	6
5.1	Sensitivity in air .....	6
5.2	Linearity .....	7
5.3	Sensitivity in liquid.....	7
5.4	Isotropy.....	8
6	List of Equipment .....	10



**1 DEVICE UNDER TEST**

Device Under Test	
Device Type	COMOSAR DOSIMETRIC E FIELD PROBE
Manufacturer	Satimo
Model	SSE5
Serial Number	SN 22/12 EP159
Product Condition (new / used)	used
Frequency Range of Probe	0.3 GHz-3GHz
Resistance of Three Dipoles at Connector	Dipole 1: R1=0.230 MΩ Dipole 2: R2=0.226 MΩ Dipole 3: R3=0.231 MΩ

A yearly calibration interval is recommended.

**2 PRODUCT DESCRIPTION**

**2.1 GENERAL INFORMATION**

Satimo's COMOSAR E field Probes are built in accordance to the IEEE 1528, OET 65 Bulletin C and CEI/IEC 62209 standards.



**Figure 1 – Satimo COMOSAR Dosimetric E field Dipole**

Probe Length	330 mm
Length of Individual Dipoles	4.5 mm
Maximum external diameter	8 mm
Probe Tip External Diameter	5 mm
Distance between dipoles / probe extremity	2.7 mm

**3 MEASUREMENT METHOD**

The IEEE 1528, OET 65 Bulletin C, CENELEC EN50361 and CEI/IEC 62209 standards provide recommended practices for the probe calibrations, including the performance characteristics of interest and methods by which to assess their affect. All calibrations / measurements performed meet the fore mentioned standards.

**3.1 LINEARITY**

The evaluation of the linearity was done in free space using the waveguide, performing a power sweep to cover the SAR range 0.01W/kg to 100W/kg.



### 3.2 SENSITIVITY

The sensitivity factors of the three dipoles were determined using a two step calibration method (air and tissue simulating liquid) using waveguides as outlined in the standards.

### 3.3 LOWER DETECTION LIMIT

The lower detection limit was assessed using the same measurement set up as used for the linearity measurement. The required lower detection limit is 10 mW/kg.

### 3.4 ISOTROPY

The axial isotropy was evaluated by exposing the probe to a reference wave from a standard dipole with the dipole mounted under the flat phantom in the test configuration suggested for system validations and checks. The probe was rotated along its main axis from 0 - 360 degrees in 15 degree steps. The hemispherical isotropy is determined by inserting the probe in a thin plastic box filled with tissue-equivalent liquid, with the plastic box illuminated with the fields from a half wave dipole. The dipole is rotated about its axis (0°-180°) in 15° increments. At each step the probe is rotated about its axis (0°-360°).

### 3.5 BOUNDARY EFFECT

The boundary effect is defined as the deviation between the SAR measured data and the expected exponential decay in the liquid when the probe is oriented normal to the interface. To evaluate this effect, the liquid filled flat phantom is exposed to fields from either a reference dipole or waveguide. With the probe normal to the phantom surface, the peak spatial average SAR is measured and compared to the analytical value at the surface.

## 4 MEASUREMENT UNCERTAINTY

The guidelines outlined in the IEEE 1528, OET 65 Bulletin C, CENELEC EN50361 and CEI/IEC 62209 standards were followed to generate the measurement uncertainty associated with an E-field probe calibration using the waveguide technique. All uncertainties listed below represent an expanded uncertainty expressed at approximately the 95% confidence level using a coverage factor of k=2, traceable to the Internationally Accepted Guides to Measurement Uncertainty.

Uncertainty analysis of the probe calibration in waveguide					
ERROR SOURCES	Uncertainty value (%)	Probability Distribution	Divisor	ci	Standard Uncertainty (%)
Incident or forward power	3.00%	Rectangular	$\sqrt{3}$	1	1.732%
Reflected power	3.00%	Rectangular	$\sqrt{3}$	1	1.732%
Liquid conductivity	5.00%	Rectangular	$\sqrt{3}$	1	2.887%
Liquid permittivity	4.00%	Rectangular	$\sqrt{3}$	1	2.309%
Field homogeneity	3.00%	Rectangular	$\sqrt{3}$	1	1.732%
Field probe positioning	5.00%	Rectangular	$\sqrt{3}$	1	2.887%
Field probe linearity	3.00%	Rectangular	$\sqrt{3}$	1	1.732%



Combined standard uncertainty					5.831%
Expanded uncertainty 95 % confidence level k = 2					11.662%

## 5 CALIBRATION MEASUREMENT RESULTS

Calibration Parameters	
Liquid Temperature	21 °C
Lab Temperature	21 °C
Lab Humidity	45 %

### 5.1 SENSITIVITY IN AIR

Normx dipole 1 ( $\mu\text{V}/(\text{V}/\text{m})^2$ )	Normy dipole 2 ( $\mu\text{V}/(\text{V}/\text{m})^2$ )	Normz dipole 3 ( $\mu\text{V}/(\text{V}/\text{m})^2$ )
5.41	4.68	5.48

DCP dipole 1 (mV)	DCP dipole 2 (mV)	DCP dipole 3 (mV)
102	99	95

Calibration curves  $e_i=f(V)$  ( $i=1,2,3$ ) allow to obtain H-field value using the formula:

$$E = \sqrt{E_1^2 + E_2^2 + E_3^2}$$

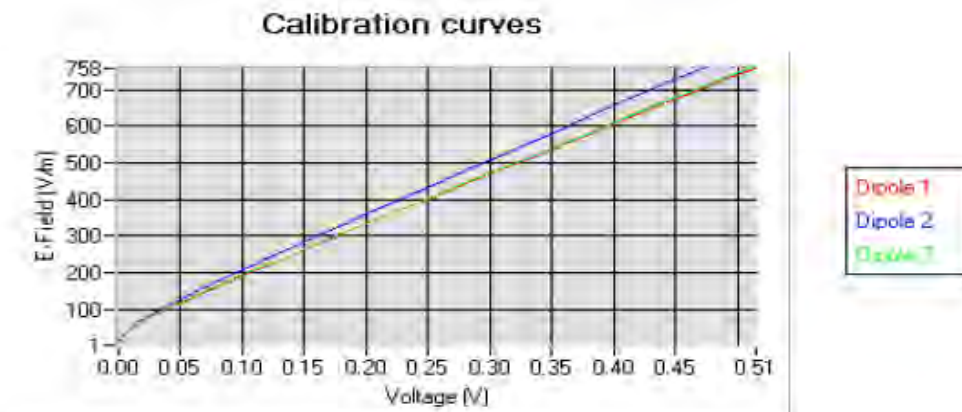



5.2 LINEARITY

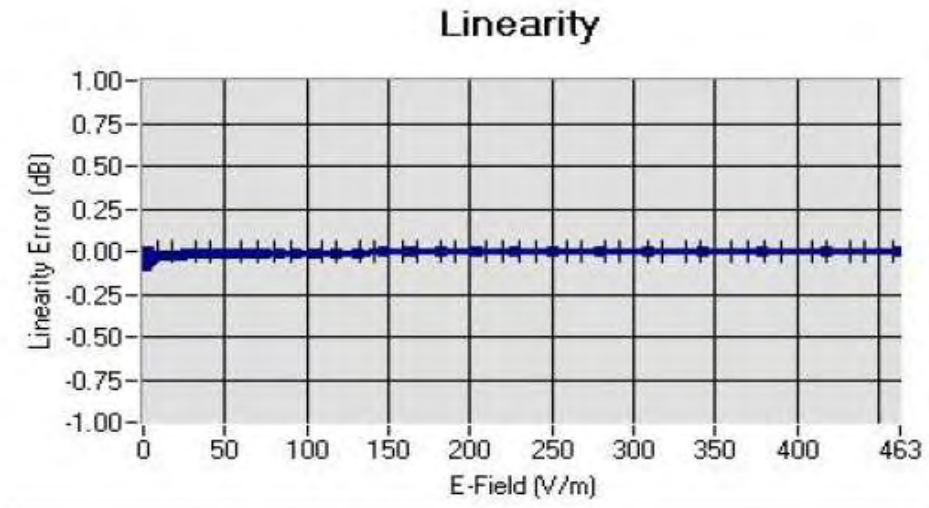

Linearity:  $\pm 1.97\%$  ( $\pm 0.09\text{dB}$ )

5.3 SENSITIVITY IN LIQUID

Liquid	Frequency (MHz +/- 100MHz)*	Permittivity	Epsilon (S/m)	ConvF
HL300	300	45.27	0.85	4.60
BL300	300	58.01	0.94	4.68
HL450	450	42.87	0.89	4.71
BL450	450	56.37	0.93	4.83
HL850	835	41.12	0.91	5.27
BL850	835	55.03	0.97	5.48
HL900	900	40.77	0.98	5.20
BL900	900	55.49	1.04	5.28
HL1800	1750	39.22	1.38	4.58
BL1800	1750	53.27	1.51	4.71
HL1900	1880	39.54	1.41	4.51
BL1900	1880	52.88	1.55	4.45
HL2000	1950	38.97	1.45	4.31
BL2000	1950	52.01	1.58	4.33
HL2450	2450	39.17	1.85	4.42
BL2450	2450	52.47	1.99	4.31

LOWER DETECTION LIMIT: 9mW/kg



#### 5.4 ISOTROPY

##### HL900 MHz

- Axial isotropy: 0.04 dB
- Hemispherical isotropy: 0.08 dB

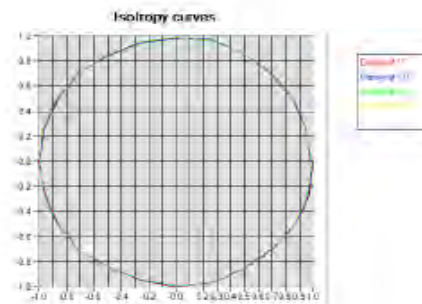

##### HL1800 MHz

- Axial isotropy: 0.07 dB
- Hemispherical isotropy: 0.12 dB

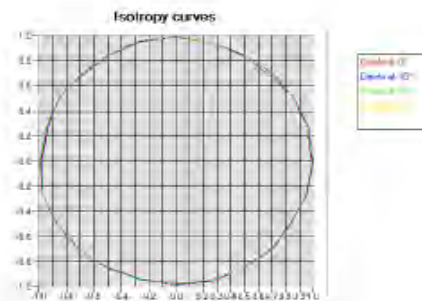



**HL 2450 MHz**

- Axial isotropy: 0.09 dB
- Hemispherical isotropy: 0.14 dB

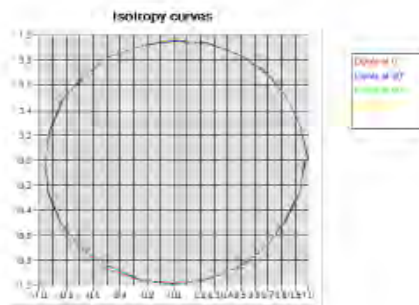



6 LIST OF EQUIPMENT

Equipment Summary Sheet				
Equipment Description	Manufacturer / Model	Identification No.	Current Calibration Date	Next Calibration Date
Flat Phantom	Satimo	SN-20/09-SAM71	Validated. No cal required.	Validated. No cal required.
COMOSAR Test Bench	Version 3	NA	Validated. No cal required.	Validated. No cal required.
Network Analyzer	Rhode & Schwarz ZVA	SN100132	02/2013	02/2016
Reference Probe	Satimo	EP 94 SN 37/08	Characterized prior to test. No cal required.	Characterized prior to test. No cal required.
Multimeter	Keithley 2000	1188656	11/2013	11/2016
Signal Generator	Agilent E4438C	MY49070581	12/2013	12/2016
Amplifier	Aethercomm	SN 046	Characterized prior to test. No cal required.	Characterized prior to test. No cal required.
Power Meter	HP E4416A	US38261498	11/2013	11/2016
Power Sensor	HP ECP-E26A	US37181460	11/2013	11/2016
Directional Coupler	Narda 4216-20	01386	Characterized prior to test. No cal required.	Characterized prior to test. No cal required.
Waveguide	Mega Industries	069Y7-158-13-712	Validated. No cal required.	Validated. No cal required.
Waveguide Transition	Mega Industries	069Y7-158-13-701	Validated. No cal required.	Validated. No cal required.
Waveguide Termination	Mega Industries	069Y7-158-13-701	Validated. No cal required.	Validated. No cal required.
Temperature / Humidity Sensor	Control Company	11-661-9	3/2012	3/2014



## APPENDIX E. DIPOLE CALIBRATION DATA



### SAR Reference Dipole Calibration Report

Ref: ACR.318.5.13.SATU.A

#### **ATTESTATION OF GLOBAL COMPLIANCE CO. LTD.**

**1&2F, NO.2 BUILDING, HUAFENG NO.1 INDUSTRIAL  
PARK, GUSHU COMMUNITY XIXIANG STREET  
BAOAN DISTRICT, SHENZHEN, P.R. CHINA**

**SATIMO COMOSAR REFERENCE DIPOLE**

**FREQUENCY: 900 MHZ**

**SERIAL NO.: SN 46/11 DIP 0G900-185**

**Calibrated at SATIMO US**

**2105 Barrett Park Dr. - Kennesaw, GA 30144**



**11/14/13**

#### *Summary:*

This document presents the method and results from an accredited SAR reference dipole calibration performed in SATIMO USA using the COMOSAR test bench. All calibration results are traceable to national metrology institutions.



	<i>Name</i>	<i>Function</i>	<i>Date</i>	<i>Signature</i>
<i>Prepared by :</i>	Jérôme LUC	Product Manager	11/14/2013	<i>JLS</i>
<i>Checked by :</i>	Jérôme LUC	Product Manager	11/14/2013	<i>JLS</i>
<i>Approved by :</i>	Kim RUTKOWSKI	Quality Manager	11/14/2013	<i>Kim Rutkowski</i>

	<i>Customer Name</i>
<i>Distribution :</i>	ATTESTATION OF GLOBAL COMPLIANCE CO. LTD.

<i>Issue</i>	<i>Date</i>	<i>Modifications</i>
A	11/14/2013	Initial release



**TABLE OF CONTENTS**

1	Introduction.....	4
2	Device Under Test.....	4
3	Product Description.....	4
3.1	General Information.....	4
4	Measurement Method.....	5
4.1	Return Loss Requirements.....	5
4.2	Mechanical Requirements.....	5
5	Measurement Uncertainty.....	5
5.1	Return Loss.....	5
5.2	Dimension Measurement.....	5
5.3	Validation Measurement.....	5
6	Calibration Measurement Results.....	6
6.1	Return Loss and Impedance.....	6
6.2	Mechanical Dimensions.....	6
7	Validation measurement.....	7
7.1	Measurement Condition.....	7
7.2	Head Liquid Measurement.....	7
7.3	Measurement Result.....	8
7.4	Body Measurement Result.....	9
8	List of Equipment.....	10



## 1 INTRODUCTION

This document contains a summary of the requirements set forth by the IEEE 1528, OET 65 Bulletin C and CEI/IEC 62209 standards for reference dipoles used for SAR measurement system validations and the measurements that were performed to verify that the product complies with the fore mentioned standards.

## 2 DEVICE UNDER TEST

Device Under Test	
Device Type	COMOSAR 900 MHz REFERENCE DIPOLE
Manufacturer	Satimo
Model	SID900
Serial Number	SN 46/11 DIP 0G900-185
Product Condition (new / used)	Used

A yearly calibration interval is recommended.

## 3 PRODUCT DESCRIPTION

### 3.1 GENERAL INFORMATION

Satimo's COMOSAR Validation Dipoles are built in accordance to the IEEE 1528, OET 65 Bulletin C and CEI/IEC 62209 standards. The product is designed for use with the COMOSAR test bench only.



**Figure 1** – Satimo COMOSAR Validation Dipole



#### 4 MEASUREMENT METHOD

The IEEE 1528, OET 65 Bulletin C and CEI/IEC 62209 standards provide requirements for reference dipoles used for system validation measurements. The following measurements were performed to verify that the product complies with the fore mentioned standards.

##### 4.1 RETURN LOSS REQUIREMENTS

The dipole used for SAR system validation measurements and checks must have a return loss of -20 dB or better. The return loss measurement shall be performed against a liquid filled flat phantom, with the phantom constructed as outlined in the fore mentioned standards.

##### 4.2 MECHANICAL REQUIREMENTS

The IEEE Std. 1528 and CEI/IEC 62209 standards specify the mechanical components and dimensions of the validation dipoles, with the dimensions frequency and phantom shell thickness dependent. The COMOSAR test bench employs a 2 mm phantom shell thickness therefore the dipoles sold for use with the COMOSAR test bench comply with the requirements set forth for a 2 mm phantom shell thickness.

#### 5 MEASUREMENT UNCERTAINTY

All uncertainties listed below represent an expanded uncertainty expressed at approximately the 95% confidence level using a coverage factor of k=2, traceable to the Internationally Accepted Guides to Measurement Uncertainty.

##### 5.1 RETURN LOSS

The following uncertainties apply to the return loss measurement:

Frequency band	Expanded Uncertainty on Return Loss
400-6000MHz	0.1 dB

##### 5.2 DIMENSION MEASUREMENT

The following uncertainties apply to the dimension measurements:

Length (mm)	Expanded Uncertainty on Length
3 - 300	0.05 mm

##### 5.3 VALIDATION MEASUREMENT

The guidelines outlined in the IEEE 1528, OET 65 Bulletin C, CENELEC EN50361 and CEI/IEC 62209 standards were followed to generate the measurement uncertainty for validation measurements.

Scan Volume	Expanded Uncertainty
1 g	20.3 %
10 g	20.1 %



## 6 CALIBRATION MEASUREMENT RESULTS

### 6.1 RETURN LOSS AND IMPEDANCE

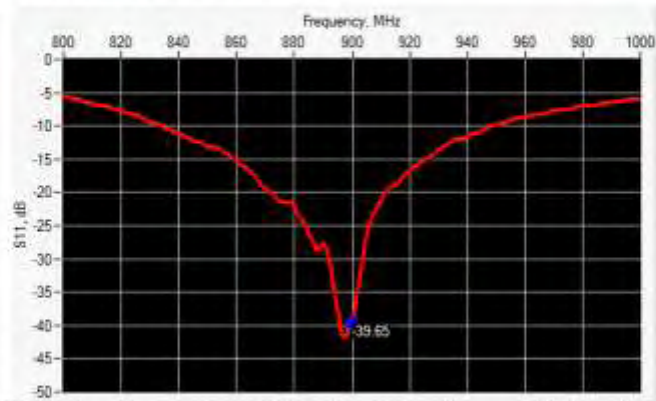

Frequency (MHz)	Return Loss (dB)	Requirement (dB)	Impedance
900	-39.65	-20	50.5 $\Omega$ - 1.1 j $\Omega$

### 6.2 MECHANICAL DIMENSIONS

Frequency MHz	L mm		h mm		d mm	
	required	measured	required	measured	required	measured
300	420.0 $\pm$ 1 %		250.0 $\pm$ 1 %		6.35 $\pm$ 1 %	
450	290.0 $\pm$ 1 %		166.7 $\pm$ 1 %		6.35 $\pm$ 1 %	
750	176.0 $\pm$ 1 %		100.0 $\pm$ 1 %		6.35 $\pm$ 1 %	
895	161.0 $\pm$ 1 %		89.8 $\pm$ 1 %		3.6 $\pm$ 1 %	
900	149.0 $\pm$ 1 %	PASS	83.3 $\pm$ 1 %	PASS	3.6 $\pm$ 1 %	PASS
1450	89.1 $\pm$ 1 %		51.7 $\pm$ 1 %		3.6 $\pm$ 1 %	
1500	80.5 $\pm$ 1 %		50.0 $\pm$ 1 %		3.6 $\pm$ 1 %	
1640	79.0 $\pm$ 1 %		45.7 $\pm$ 1 %		3.6 $\pm$ 1 %	
1750	75.2 $\pm$ 1 %		42.9 $\pm$ 1 %		3.6 $\pm$ 1 %	
1800	72.0 $\pm$ 1 %		41.7 $\pm$ 1 %		3.6 $\pm$ 1 %	
1900	68.0 $\pm$ 1 %		39.5 $\pm$ 1 %		3.6 $\pm$ 1 %	
1950	66.3 $\pm$ 1 %		38.5 $\pm$ 1 %		3.6 $\pm$ 1 %	
2000	64.5 $\pm$ 1 %		37.5 $\pm$ 1 %		3.6 $\pm$ 1 %	
2100	61.0 $\pm$ 1 %		35.7 $\pm$ 1 %		3.6 $\pm$ 1 %	
2300	55.5 $\pm$ 1 %		32.6 $\pm$ 1 %		3.6 $\pm$ 1 %	
2450	51.5 $\pm$ 1 %		30.4 $\pm$ 1 %		3.6 $\pm$ 1 %	
2600	48.5 $\pm$ 1 %		28.8 $\pm$ 1 %		3.6 $\pm$ 1 %	
3000	41.5 $\pm$ 1 %		25.0 $\pm$ 1 %		3.6 $\pm$ 1 %	
3500	37.0 $\pm$ 1 %		26.4 $\pm$ 1 %		3.6 $\pm$ 1 %	
3700	34.7 $\pm$ 1 %		26.4 $\pm$ 1 %		3.6 $\pm$ 1 %	



## 7 VALIDATION MEASUREMENT

The IEEE Std. 1528, OET 65 Bulletin C and CEI/IEC 62209 standards state that the system validation measurements must be performed using a reference dipole meeting the fore mentioned return loss and mechanical dimension requirements. The validation measurement must be performed against a liquid filled flat phantom, with the phantom constructed as outlined in the fore mentioned standards. Per the standards, the dipole shall be positioned below the bottom of the phantom, with the dipole length centered and parallel to the longest dimension of the flat phantom, with the top surface of the dipole at the described distance from the bottom surface of the phantom.

### 7.1 MEASUREMENT CONDITION

Software	OPENSAR V4
Phantom	SN 20/09 SAM71
Probe	SN 18/11 EP3122
Liquid	Head Liquid Values: $\epsilon_p \approx 41.8$ $\sigma_p \approx 0.96$
Distance between dipole center and liquid	15.0 mm
Area scan resolution	$dx=8mm/dy=8mm$
Zoon Scan Resolution	$dx=8mm/dy=8m/dz=5mm$
Frequency	900 MHz
Input power	20 dBm
Liquid Temperature	21 °C
Lab Temperature	21 °C
Lab Humidity	45 %

### 7.2 HEAD LIQUID MEASUREMENT

Frequency MHz	Relative permittivity ( $\epsilon_r$ )		Conductivity ( $\sigma$ ) S/m	
	required	measured	required	measured
300	45.3 ± 5 %		0.87 ± 5 %	
450	43.5 ± 5 %		0.87 ± 5 %	
750	41.9 ± 5 %		0.89 ± 5 %	
835	41.5 ± 5 %		0.90 ± 5 %	
900	41.5 ± 5 %	PASS	0.97 ± 5 %	PASS
1450	40.5 ± 5 %		1.20 ± 5 %	
1500	40.4 ± 5 %		1.23 ± 5 %	
1640	40.2 ± 5 %		1.31 ± 5 %	
1750	40.1 ± 5 %		1.37 ± 5 %	
1800	40.0 ± 5 %		1.40 ± 5 %	
1900	40.0 ± 5 %		1.40 ± 5 %	
1950	40.0 ± 5 %		1.40 ± 5 %	
2000	40.0 ± 5 %		1.40 ± 5 %	
2100	39.8 ± 5 %		1.49 ± 5 %	
2300	39.5 ± 5 %		1.67 ± 5 %	
2450	39.2 ± 5 %		1.80 ± 5 %	
2600	39.0 ± 5 %		1.96 ± 5 %	
3000	38.5 ± 5 %		2.40 ± 5 %	
3500	37.9 ± 5 %		2.91 ± 5 %	

Page: 7/10

*This document shall not be reproduced, except in full or in part, without the written approval of SATIMO. The information contained herein is to be used only for the purpose for which it is submitted and is not to be released in whole or part without written approval of SATIMO.*



**7.3 MEASUREMENT RESULT**

The IEEE Std. 1528 and CEI/IEC 62209 standards state that the system validation measurements should produce the SAR values shown below (for phantom thickness of 2 mm), within the uncertainty for the system validation. All SAR values are normalized to 1 W forward power. In bracket, the measured SAR is given with the used input power.

Frequency MHz	1 g SAR (W/kg/W)		10 g SAR (W/kg/W)	
	required	measured	required	measured
300	2.85		1.94	
450	4.58		3.06	
750	8.49		5.55	
835	9.56		6.22	
900	10.9	10.70 (1.07)	6.99	6.72 (0.67)
1450	29		16	
1500	30.5		16.8	
1640	34.2		18.4	
1750	36.4		19.3	
1800	38.4		20.1	
1900	39.7		20.5	
1950	40.5		20.9	
2000	41.1		21.1	
2100	43.6		21.9	
2300	48.7		23.3	
2450	52.4		24	
2600	55.3		24.6	
3000	63.8		25.7	
3500	67.1		25	

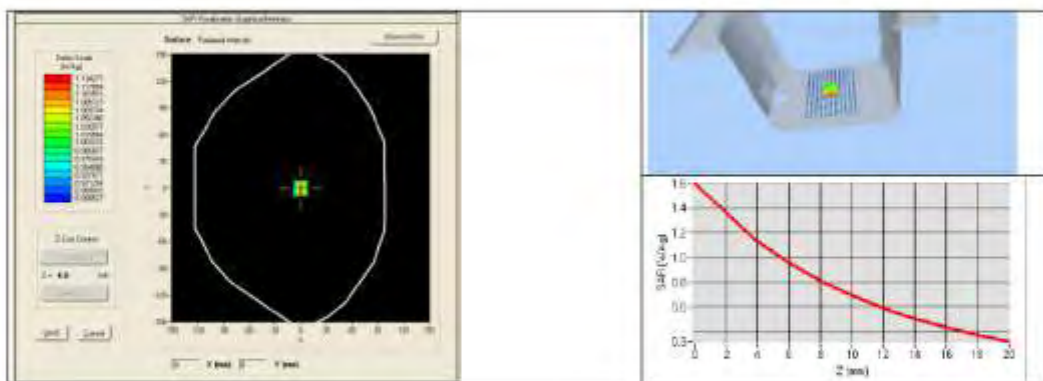





7.4 BODY MEASUREMENT RESULT

Software	OPENSAR V4
Phantom	SN 20/09 SAM71
Probe	SN 18/11 EPG122
Liquid	Body Liquid Values: $\epsilon_{ps}$ : 56.0 $\sigma$ : 1.04
Distance between dipole center and liquid	15.0 mm
Area scan resolution	$dx=8mm/dy=8mm$
Zoon Scan Resolution	$dx=8mm/dy=8mm/dz=5mm$
Frequency	900 MHz
Input power	20 dBm
Liquid Temperature	21 °C
Lab Temperature	21 °C
Lab Humidity	45 %

Frequency MHz	1 g SAR (W/kg/W)	10 g SAR (W/kg/W)
	measured	measured
900	11.27 (1.13)	7.18 (0.72)

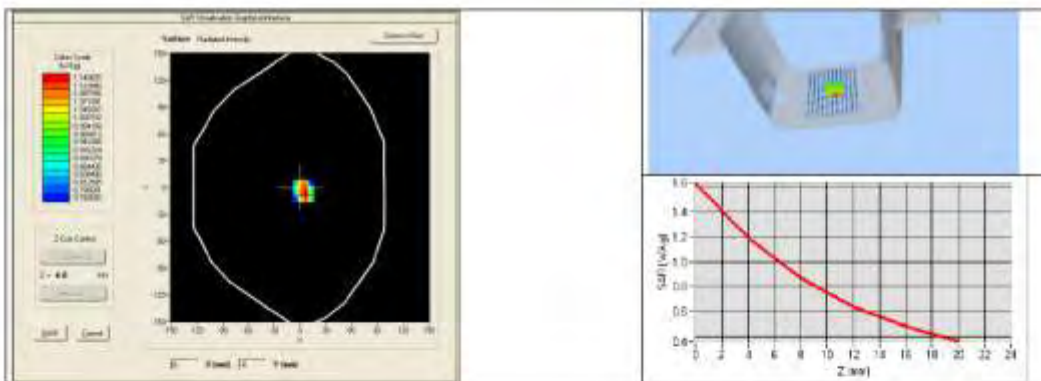



**8 LIST OF EQUIPMENT**

Equipment Summary Sheet				
Equipment Description	Manufacturer / Model	Identification No.	Current Calibration Date	Next Calibration Date
SAM Phantom	Satimo	SN-20/09-SAM71	Validated. No cal required.	Validated. No cal required.
CÓMÓ SAR Test Bench	Version 3	NA	Validated. No cal required.	Validated. No cal required.
Network Analyzer	Rhode & Schwarz ZVA	SN100132	02/2013	02/2016
Calipers	Camera	CALIPER-01	12/2010	12/2013
Reference Probe	Satimo	EPG122 SN 18/11	Characterized prior to test. No cal required.	Characterized prior to test. No cal required.
Multimeter	Keithley 2000	1188656	11/2010	11/2013
Signal Generator	Agilent E4438C	MY49070581	12/2010	12/2013
Amplifier	Aethercomm	SN 046	Characterized prior to test. No cal required.	Characterized prior to test. No cal required.
Power Meter	HP E4418A	US38261498	11/2010	11/2013
Power Sensor	HP ECP-E26A	US37181460	11/2010	11/2013
Directional Coupler	Narda 4216-20	01386	Characterized prior to test. No cal required.	Characterized prior to test. No cal required.
Temperature and Humidity Sensor	Control Company	11-661-9	3/2012	3/2014



## SAR Reference Dipole Calibration Report

Ref: ACR.318.7.13.SATU.A

### **ATTESTATION OF GLOBAL COMPLIANCE CO. LTD.**

**1&2F, NO.2 BUILDING, HUAFENG NO.1 INDUSTRIAL  
PARK, GUSHU COMMUNITY XIXIANG STREET  
BAOAN DISTRICT, SHENZHEN, P.R. CHINA  
SATIMO COMOSAR REFERENCE DIPOLE**

**FREQUENCY: 1900 MHZ**

**SERIAL NO.: SN 46/11 DIP 1G900-187**

**Calibrated at SATIMO US  
2105 Barrett Park Dr. - Kennesaw, GA 30144**



**11/14/13**

#### *Summary:*

This document presents the method and results from an accredited SAR reference dipole calibration performed in SATIMO USA using the COMOSAR test bench. All calibration results are traceable to national metrology institutions.



	<i>Name</i>	<i>Function</i>	<i>Date</i>	<i>Signature</i>
<i>Prepared by :</i>	Jérôme LUC	Product Manager	11/14/2013	<i>JS</i>
<i>Checked by :</i>	Jérôme LUC	Product Manager	11/14/2013	<i>JS</i>
<i>Approved by :</i>	Kim RUTKOWSKI	Quality Manager	11/14/2013	<i>Kim Rutkowski</i>

	<i>Customer Name</i>
<i>Distribution :</i>	ATTESTATION OF GLOBAL COMPLIANCE CO. LTD.

<i>Issue</i>	<i>Date</i>	<i>Modifications</i>
A	11/14/2013	Initial release



**TABLE OF CONTENTS**

1	Introduction.....	4
2	Device Under Test.....	4
3	Product Description .....	4
3.1	General Information .....	4
4	Measurement Method .....	5
4.1	Return Loss Requirements .....	5
4.2	Mechanical Requirements .....	5
5	Measurement Uncertainty.....	5
5.1	Return Loss .....	5
5.2	Dimension Measurement .....	5
5.3	Validation Measurement .....	5
6	Calibration Measurement Results.....	6
6.1	Return Loss and Impedance .....	6
6.2	Mechanical Dimensions .....	6
7	Validation measurement .....	7
7.1	Measurement Condition .....	7
7.2	Head Liquid Measurement .....	7
7.3	Measurement Result .....	8
7.4	Body Measurement Result .....	9
8	List of Equipment .....	10



## 1 INTRODUCTION

This document contains a summary of the requirements set forth by the IEEE 1528, OET 65 Bulletin C and CEI/IEC 62209 standards for reference dipoles used for SAR measurement system validations and the measurements that were performed to verify that the product complies with the fore mentioned standards.

## 2 DEVICE UNDER TEST

Device Under Test	
Device Type	COMOSAR 1900 MHz REFERENCE DIPOLE
Manufacturer	Satimo
Model	SID1900
Serial Number	SN 46/11 DIP 1G900-187
Product Condition (new / used)	Used

A yearly calibration interval is recommended.

## 3 PRODUCT DESCRIPTION

### 3.1 GENERAL INFORMATION

Satimo's COMOSAR Validation Dipoles are built in accordance to the IEEE 1528, OET 65 Bulletin C and CEI/IEC 62209 standards. The product is designed for use with the COMOSAR test bench only.



**Figure 1** – Satimo COMOSAR Validation Dipole



**4 MEASUREMENT METHOD**

The IEEE 1528, OET 65 Bulletin C and CEI/IEC 62209 standards provide requirements for reference dipoles used for system validation measurements. The following measurements were performed to verify that the product complies with the fore mentioned standards.

**4.1 RETURN LOSS REQUIREMENTS**

The dipole used for SAR system validation measurements and checks must have a return loss of -20 dB or better. The return loss measurement shall be performed against a liquid filled flat phantom, with the phantom constructed as outlined in the fore mentioned standards.

**4.2 MECHANICAL REQUIREMENTS**

The IEEE Std. 1528 and CEI/IEC 62209 standards specify the mechanical components and dimensions of the validation dipoles, with the dimensions frequency and phantom shell thickness dependent. The COMOSAR test bench employs a 2 mm phantom shell thickness therefore the dipoles sold for use with the COMOSAR test bench comply with the requirements set forth for a 2 mm phantom shell thickness.

**5 MEASUREMENT UNCERTAINTY**

All uncertainties listed below represent an expanded uncertainty expressed at approximately the 95% confidence level using a coverage factor of k=2, traceable to the Internationally Accepted Guides to Measurement Uncertainty.

**5.1 RETURN LOSS**

The following uncertainties apply to the return loss measurement:

Frequency band	Expanded Uncertainty on Return Loss
400-6000MHz	0.1 dB

**5.2 DIMENSION MEASUREMENT**

The following uncertainties apply to the dimension measurements:

Length (mm)	Expanded Uncertainty on Length
3 - 300	0.05 mm

**5.3 VALIDATION MEASUREMENT**

The guidelines outlined in the IEEE 1528, OET 65 Bulletin C, CENELEC EN50361 and CEI/IEC 62209 standards were followed to generate the measurement uncertainty for validation measurements.

Scan Volume	Expanded Uncertainty
1 g	20.3 %
10 g	20.1 %



## 6 CALIBRATION MEASUREMENT RESULTS

### 6.1 RETURN LOSS AND IMPEDANCE

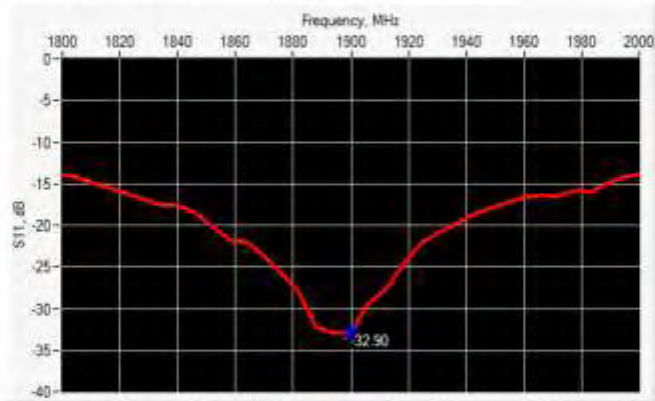

Frequency (MHz)	Return Loss (dB)	Requirement (dB)	Impedance
1900	-32.90	-20	$48.9 \Omega + 2.3 j\Omega$

### 6.2 MECHANICAL DIMENSIONS

Frequency MHz	L mm		h mm		d mm	
	required	measured	required	measured	required	measured
300	420.0 ±1 %		250.0 ±1 %		6.35 ±1 %	
450	290.0 ±1 %		166.7 ±1 %		6.35 ±1 %	
750	176.0 ±1 %		100.0 ±1 %		6.35 ±1 %	
835	161.0 ±1 %		89.0 ±1 %		3.6 ±1 %	
900	149.0 ±1 %		89.3 ±1 %		3.6 ±1 %	
1450	89.1 ±1 %		51.7 ±1 %		3.6 ±1 %	
1500	80.5 ±1 %		50.0 ±1 %		3.6 ±1 %	
1640	79.0 ±1 %		45.7 ±1 %		3.6 ±1 %	
1750	75.2 ±1 %		42.9 ±1 %		3.6 ±1 %	
1800	72.0 ±1 %		41.7 ±1 %		3.6 ±1 %	
1900	68.0 ±1 %	PASS	39.5 ±1 %	PASS	3.6 ±1 %	PASS
1950	66.3 ±1 %		38.5 ±1 %		3.6 ±1 %	
2000	64.5 ±1 %		37.5 ±1 %		3.6 ±1 %	
2100	61.0 ±1 %		35.7 ±1 %		3.6 ±1 %	
2300	55.5 ±1 %		32.6 ±1 %		3.6 ±1 %	
2450	51.5 ±1 %		30.4 ±1 %		3.6 ±1 %	
2600	48.5 ±1 %		28.8 ±1 %		3.6 ±1 %	
3000	41.5 ±1 %		25.0 ±1 %		3.6 ±1 %	
3500	37.0 ±1 %		26.4 ±1 %		3.6 ±1 %	
3700	34.7 ±1 %		26.4 ±1 %		3.6 ±1 %	





## 7 VALIDATION MEASUREMENT

The IEEE Std. 1528, OET 65 Bulletin C and CEI/IEC 62209 standards state that the system validation measurements must be performed using a reference dipole meeting the fore mentioned return loss and mechanical dimension requirements. The validation measurement must be performed against a liquid filled flat phantom, with the phantom constructed as outlined in the fore mentioned standards. Per the standards, the dipole shall be positioned below the bottom of the phantom, with the dipole length centered and parallel to the longest dimension of the flat phantom, with the top surface of the dipole at the described distance from the bottom surface of the phantom.

### 7.1 MEASUREMENT CONDITION

Software	OPENSAR V4
Phantom	SN 20/09 SAM71
Probe	SN 18/11 EPG122
Liquid	Head Liquid Values: $\epsilon_{ps}' : 39.8$ $\epsilon_{ps}'' : 1.43$
Distance between dipole center and liquid	10.0 mm
Area scan resolution	$dx=8mm/dy=8mm$
Zoon Scan Resolution	$dx=8mm/dy=8mm/dz=5mm$
Frequency	1900 MHz
Input power	20 dBm
Liquid Temperature	21 °C
Lab Temperature	21 °C
Lab Humidity	45 %

### 7.2 HEAD LIQUID MEASUREMENT

Frequency MHz	Relative permittivity ( $\epsilon_r'$ )		Conductivity ( $\sigma$ ) S/m	
	required	measured	required	measured
300	45.3 ±5 %		0.87 ±5 %	
450	43.5 ±5 %		0.87 ±5 %	
750	41.9 ±5 %		0.89 ±5 %	
835	41.5 ±5 %		0.90 ±5 %	
900	41.5 ±5 %		0.97 ±5 %	
1450	40.5 ±5 %		1.20 ±5 %	
1500	40.4 ±5 %		1.23 ±5 %	
1640	40.2 ±5 %		1.31 ±5 %	
1750	40.1 ±5 %		1.37 ±5 %	
1800	40.0 ±5 %		1.40 ±5 %	
1900	40.0 ±5 %	PASS	1.40 ±5 %	PASS
1950	40.0 ±5 %		1.40 ±5 %	
2000	40.0 ±5 %		1.40 ±5 %	
2100	39.8 ±5 %		1.49 ±5 %	
2300	39.5 ±5 %		1.67 ±5 %	
2450	39.2 ±5 %		1.80 ±5 %	
2600	39.0 ±5 %		1.96 ±5 %	
3000	38.5 ±5 %		2.40 ±5 %	
3500	37.9 ±5 %		2.91 ±5 %	

Page: 7/10

*This document shall not be reproduced, except in full or in part, without the written approval of SATIMO. The information contained herein is to be used only for the purpose for which it is submitted and is not to be released in whole or part without written approval of SATIMO.*



7.3 MEASUREMENT RESULT

The IEEE Std. 1528 and CEI/IEC 62209 standards state that the system validation measurements should produce the SAR values shown below (for phantom thickness of 2 mm), within the uncertainty for the system validation. All SAR values are normalized to 1 W forward power. In bracket, the measured SAR is given with the used input power.

Frequency MHz	1 g SAR (W/kg/W)		10 g SAR (W/kg/W)	
	required	measured	required	measured
300	2.85		1.94	
450	4.58		3.06	
750	8.49		5.55	
835	9.56		6.22	
900	10.9		6.99	
1450	29		16	
1500	30.5		16.8	
1640	34.2		18.4	
1750	36.4		19.3	
1800	38.4		20.1	
1900	39.7	39.65 (3.96)	20.5	20.24 (2.02)
1950	40.5		20.9	
2000	41.1		21.1	
2100	43.6		21.9	
2300	48.7		23.3	
2450	52.4		24	
2600	55.3		24.6	
3000	63.8		25.7	
3500	67.1		25	

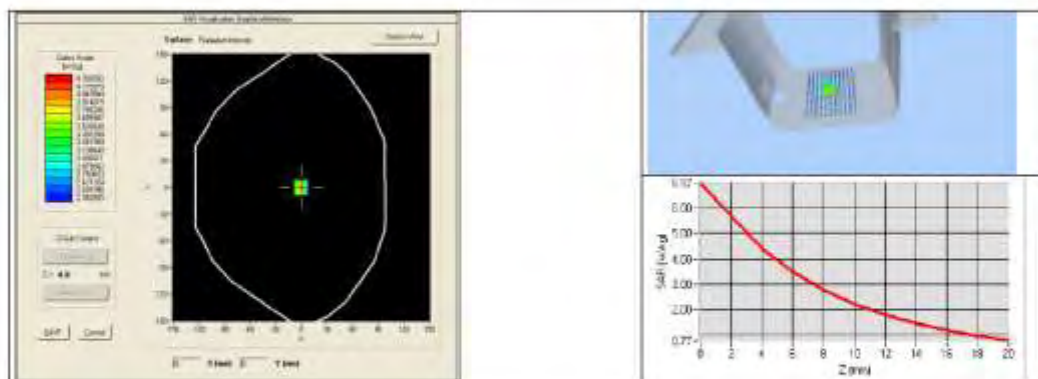



7.4 BODY MEASUREMENT RESULT

Software	OPENSAR V4
Phantom	SN 20/09 SAM71
Probe	SN 18/11 EPG122
Liquid	Body Liquid Values: $\epsilon_p \approx 52.5$ $\sigma_p \approx 1.50$
Distance between dipole center and liquid	10.0 mm
Area scan resolution	$dx=8mm/dy=8mm$
Zoon Scan Resolution	$dx=8mm/dy=8m/dz=5mm$
Frequency	1900 MHz
Input power	20 dBm
Liquid Temperature	21 °C
Lab Temperature	21 °C
Lab Humidity	45 %

Frequency MHz	1 g SAR (W/kg/W)	10 g SAR (W/kg/W)
	measured	measured
1900	40.74 (4.07)	21.43 (2.14)

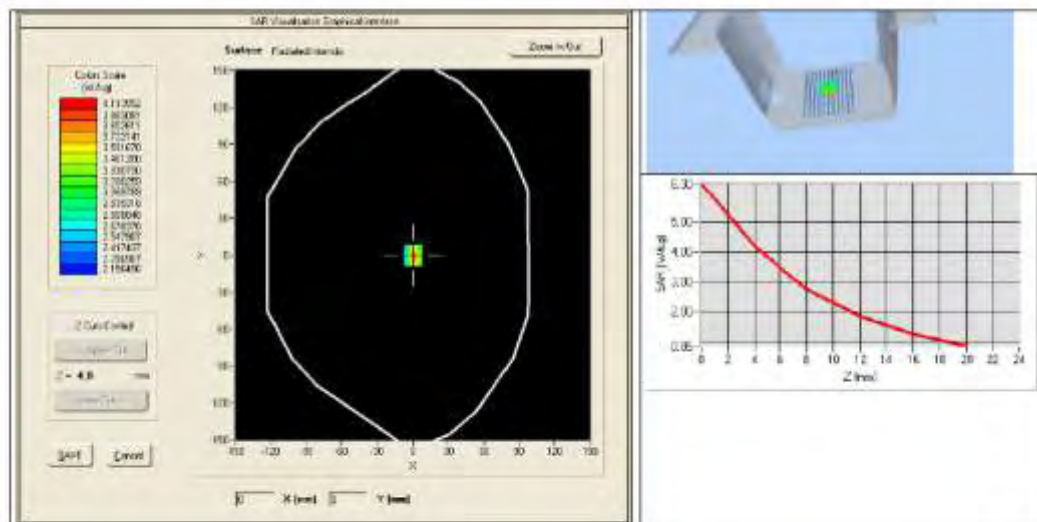



**8 LIST OF EQUIPMENT**

Equipment Summary Sheet				
Equipment Description	Manufacturer / Model	Identification No.	Current Calibration Date	Next Calibration Date
SAM Phantom	Satimo	SN-20/09-SAM71	Validated. No cal required.	Validated. No cal required.
COMOSAR Test Bench	Version 3	NA	Validated. No cal required.	Validated. No cal required.
Network Analyzer	Rhode & Schwarz ZVA	SN100132	02/2013	02/2016
Calipers	Carrera	CALIPER-01	12/2010	12/2013
Reference Probe	Satimo	EPG122 SN 18/11	Characterized prior to test. No cal required.	Characterized prior to test. No cal required.
Multimeter	Keithley 2000	1188656	11/2010	11/2013
Signal Generator	Agilent E4438C	MY49070581	12/2010	12/2013
Amplifier	Aethercomm	SN 046	Characterized prior to test. No cal required.	Characterized prior to test. No cal required.
Power Meter	HP E4418A	US38261498	11/2010	11/2013
Power Sensor	HP ECP-E26A	US37181460	11/2010	11/2013
Directional Coupler	Narda 4216-20	01386	Characterized prior to test. No cal required.	Characterized prior to test. No cal required.
Temperature and Humidity Sensor	Control Company	11-661-9	3/2012	3/2014



## SAR Reference Dipole Calibration Report

Ref: ACR.318.9.13.SATU.A

### **ATTESTATION OF GLOBAL COMPLIANCE CO. LTD.**

**1&2F, NO.2 BUILDING, HUA FENG NO.1 INDUSTRIAL  
PARK, GUSHU COMMUNITY XIXIANG STREET  
BAOAN DISTRICT, SHENZHEN, P.R. CHINA  
SATIMO COMOSAR REFERENCE DIPOLE  
FREQUENCY: 2450 MHZ  
SERIAL NO.: SN 46/11 DIP 2G450-189**

**Calibrated at SATIMO US  
2105 Barrett Park Dr. - Kennesaw, GA 30144**



**11/14/13**

#### *Summary:*

This document presents the method and results from an accredited SAR reference dipole calibration performed in SATIMO USA using the COMOSAR test bench. All calibration results are traceable to national metrology institutions.



	<i>Name</i>	<i>Function</i>	<i>Date</i>	<i>Signature</i>
<i>Prepared by :</i>	Jérôme LUC	Product Manager	11/14/2013	<i>JS</i>
<i>Checked by :</i>	Jérôme LUC	Product Manager	11/14/2013	<i>JS</i>
<i>Approved by :</i>	Kim RUTKOWSKI	Quality Manager	11/14/2013	<i>Kim Rutkowski</i>

	<i>Customer Name</i>
<i>Distribution :</i>	ATTESTATION OF GLOBAL COMPLIANCE CO. LTD.

<i>Issue</i>	<i>Date</i>	<i>Modifications</i>
A	11/14/2013	Initial release



**TABLE OF CONTENTS**

1	Introduction.....	4
2	Device Under Test .....	4
3	Product Description .....	4
3.1	General Information .....	4
4	Measurement Method .....	5
4.1	Return Loss Requirements .....	5
4.2	Mechanical Requirements .....	5
5	Measurement Uncertainty.....	5
5.1	Return Loss .....	5
5.2	Dimension Measurement .....	5
5.3	Validation Measurement .....	5
6	Calibration Measurement Results.....	6
6.1	Return Loss and Impedance .....	6
6.2	Mechanical Dimensions .....	6
7	Validation measurement .....	7
7.1	Measurement Condition .....	7
7.2	Head Liquid Measurement .....	7
7.3	Measurement Result .....	8
7.4	Body Measurement Result .....	9
8	List of Equipment .....	10



## 1 INTRODUCTION

This document contains a summary of the requirements set forth by the IEEE 1528, OET 65 Bulletin C and CEI/IEC 62209 standards for reference dipoles used for SAR measurement system validations and the measurements that were performed to verify that the product complies with the fore mentioned standards.

## 2 DEVICE UNDER TEST

Device Under Test	
Device Type	COMOSAR 2450 MHz REFERENCE DIPOLE
Manufacturer	Satimo
Model	SID2450
Serial Number	SN 46/11 DIP 2G450-189
Product Condition (new / used)	Used

A yearly calibration interval is recommended.

## 3 PRODUCT DESCRIPTION

### 3.1 GENERAL INFORMATION

Satimo's COMOSAR Validation Dipoles are built in accordance to the IEEE 1528, OET 65 Bulletin C and CEI/IEC 62209 standards. The product is designed for use with the COMOSAR test bench only.



**Figure 1** – Satimo COMOSAR Validation Dipole





#### 4 MEASUREMENT METHOD

The IEEE 1528, OET 65 Bulletin C and CEI/IEC 62209 standards provide requirements for reference dipoles used for system validation measurements. The following measurements were performed to verify that the product complies with the fore mentioned standards.

##### 4.1 RETURN LOSS REQUIREMENTS

The dipole used for SAR system validation measurements and checks must have a return loss of -20 dB or better. The return loss measurement shall be performed against a liquid filled flat phantom, with the phantom constructed as outlined in the fore mentioned standards.

##### 4.2 MECHANICAL REQUIREMENTS

The IEEE Std. 1528 and CEI/IEC 62209 standards specify the mechanical components and dimensions of the validation dipoles, with the dimensions frequency and phantom shell thickness dependent. The COMOSAR test bench employs a 2 mm phantom shell thickness therefore the dipoles sold for use with the COMOSAR test bench comply with the requirements set forth for a 2 mm phantom shell thickness.

#### 5 MEASUREMENT UNCERTAINTY

All uncertainties listed below represent an expanded uncertainty expressed at approximately the 95% confidence level using a coverage factor of k=2, traceable to the Internationally Accepted Guides to Measurement Uncertainty.

##### 5.1 RETURN LOSS

The following uncertainties apply to the return loss measurement:

Frequency band	Expanded Uncertainty on Return Loss
400-6000MHz	0.1 dB

##### 5.2 DIMENSION MEASUREMENT

The following uncertainties apply to the dimension measurements:

Length (mm)	Expanded Uncertainty on Length
3 - 300	0.05 mm

##### 5.3 VALIDATION MEASUREMENT

The guidelines outlined in the IEEE 1528, OET 65 Bulletin C, CENELEC EN50361 and CEI/IEC 62209 standards were followed to generate the measurement uncertainty for validation measurements.

Scan Volume	Expanded Uncertainty
1 g	20.3 %
10 g	20.1 %



## 6 CALIBRATION MEASUREMENT RESULTS

### 6.1 RETURN LOSS AND IMPEDANCE

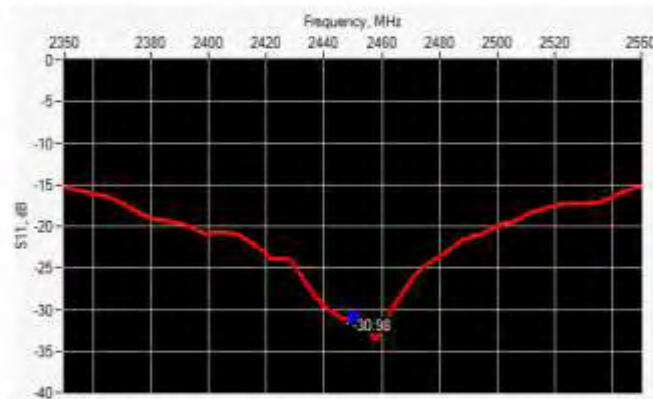

Frequency (MHz)	Return Loss (dB)	Requirement (dB)	Impedance
2450	-30.98	-20	$47.3 \Omega + 0.1 j\Omega$

### 6.2 MECHANICAL DIMENSIONS

Frequency MHz	L mm		h mm		d mm	
	required	measured	required	measured	required	measured
300	420.0 ± 1 %		250.0 ± 1 %		6.35 ± 1 %	
450	290.0 ± 1 %		166.7 ± 1 %		6.35 ± 1 %	
750	176.0 ± 1 %		100.0 ± 1 %		6.35 ± 1 %	
835	161.0 ± 1 %		89.8 ± 1 %		3.6 ± 1 %	
900	149.0 ± 1 %		83.3 ± 1 %		3.6 ± 1 %	
1450	89.1 ± 1 %		51.7 ± 1 %		3.6 ± 1 %	
1500	80.5 ± 1 %		50.0 ± 1 %		3.6 ± 1 %	
1640	79.0 ± 1 %		45.7 ± 1 %		3.6 ± 1 %	
1750	75.2 ± 1 %		42.9 ± 1 %		3.6 ± 1 %	
1800	72.0 ± 1 %		41.7 ± 1 %		3.6 ± 1 %	
1900	68.0 ± 1 %		39.5 ± 1 %		3.6 ± 1 %	
1950	66.3 ± 1 %		38.5 ± 1 %		3.6 ± 1 %	
2000	64.5 ± 1 %		37.5 ± 1 %		3.6 ± 1 %	
2100	61.0 ± 1 %		35.7 ± 1 %		3.6 ± 1 %	
2300	55.5 ± 1 %		32.6 ± 1 %		3.6 ± 1 %	
2450	51.5 ± 1 %	PASS	30.4 ± 1 %	PASS	3.6 ± 1 %	PASS
2600	48.5 ± 1 %		28.8 ± 1 %		3.6 ± 1 %	
3000	41.5 ± 1 %		25.0 ± 1 %		3.6 ± 1 %	
3500	37.0 ± 1 %		26.4 ± 1 %		3.6 ± 1 %	
3700	34.7 ± 1 %		26.4 ± 1 %		3.6 ± 1 %	



## 7 VALIDATION MEASUREMENT

The IEEE Std. 1528, OET 65 Bulletin C and CEI/IEC 62209 standards state that the system validation measurements must be performed using a reference dipole meeting the fore mentioned return loss and mechanical dimension requirements. The validation measurement must be performed against a liquid filled flat phantom, with the phantom constructed as outlined in the fore mentioned standards. Per the standards, the dipole shall be positioned below the bottom of the phantom, with the dipole length centered and parallel to the longest dimension of the flat phantom, with the top surface of the dipole at the described distance from the bottom surface of the phantom.

### 7.1 MEASUREMENT CONDITION

Software	OPENSAR V4
Phantom	SN 20/09 SAM71
Probe	SN 18/11 EPG122
Liquid	Head Liquid Values: $\epsilon_r' = 38.6$ $\sigma = 1.82$
Distance between dipole center and liquid	10.0 mm
Area scan resolution	$dx=8mm/dy=8mm$
Zoon Scan Resolution	$dx=8mm/dy=8m/dz=5mm$
Frequency	2450 MHz
Input power	20 dBm
Liquid Temperature	21 °C
Lab Temperature	21 °C
Lab Humidity	45 %

### 7.2 HEAD LIQUID MEASUREMENT

Frequency MHz	Relative permittivity ( $\epsilon_r'$ )		Conductivity ( $\sigma$ ) S/m	
	required	measured	required	measured
300	45.3 ±5 %		0.87 ±5 %	
450	43.5 ±5 %		0.87 ±5 %	
750	41.9 ±5 %		0.89 ±5 %	
825	41.5 ±5 %		0.90 ±5 %	
900	41.5 ±5 %		0.97 ±5 %	
1450	40.5 ±5 %		1.20 ±5 %	
1500	40.4 ±5 %		1.23 ±5 %	
1640	40.2 ±5 %		1.31 ±5 %	
1750	40.1 ±5 %		1.37 ±5 %	
1800	40.0 ±5 %		1.40 ±5 %	
1900	40.0 ±5 %		1.40 ±5 %	
1950	40.0 ±5 %		1.40 ±5 %	
2000	40.0 ±5 %		1.40 ±5 %	
2100	39.8 ±5 %		1.49 ±5 %	
2300	39.5 ±5 %		1.67 ±5 %	
2450	39.2 ±5 %	PASS	1.80 ±5 %	PASS
2600	39.0 ±5 %		1.96 ±5 %	
3000	38.5 ±5 %		2.40 ±5 %	
3500	37.9 ±5 %		2.91 ±5 %	

Page: 7/10

*This document shall not be reproduced, except in full or in part, without the written approval of SATIMO.  
The information contained herein is to be used only for the purpose for which it is submitted and is not to be released in whole or part without written approval of SATIMO.*



7.3 MEASUREMENT RESULT

The IEEE Std. 1528 and CEI/IEC 62209 standards state that the system validation measurements should produce the SAR values shown below (for phantom thickness of 2 mm), within the uncertainty for the system validation. All SAR values are normalized to 1 W forward power. In bracket, the measured SAR is given with the used input power.

Frequency MHz	1 g SAR (W/kg/W)		10 g SAR (W/kg/W)	
	required	measured	required	measured
300	2.85		1.94	
450	4.58		3.06	
750	8.49		5.55	
835	9.56		6.22	
900	10.9		6.99	
1450	29		16	
1500	30.5		16.8	
1640	34.2		18.4	
1750	36.4		19.9	
1800	38.4		20.1	
1900	39.7		20.5	
1950	40.5		20.9	
2000	41.1		21.1	
2100	43.6		21.9	
2300	48.7		23.3	
2450	52.4	54.40 (5.44)	24	23.75 (2.38)
2600	55.3		24.6	
3000	63.8		25.7	
3500	67.1		25	

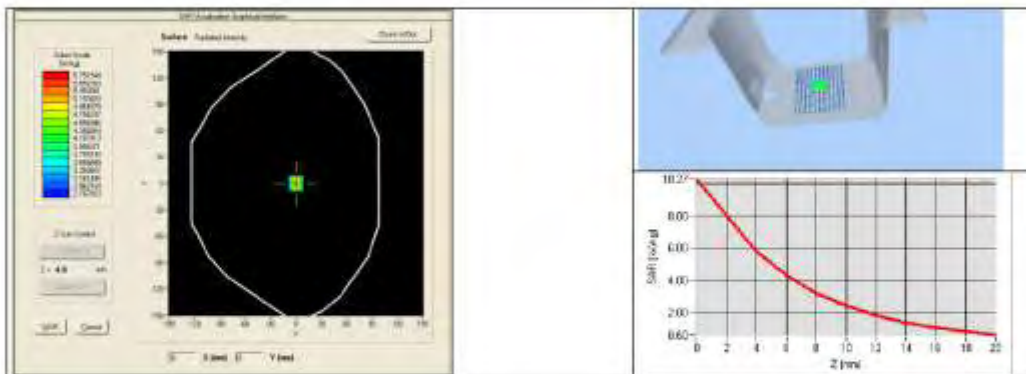



7.4 BODY MEASUREMENT RESULT

Software	OPENSAR V4
Phantom	SN 20/09 SAM71
Probe	SN 18/11 EPG122
Liquid	Body Liquid Values: $\epsilon_p' : 52.0$ $\sigma_{\text{p}} : 1.94$
Distance between dipole center and liquid	10.0 mm
Area scan resolution	$dx=8\text{mm}/dy=8\text{mm}$
Zoon Scan Resolution	$dx=8\text{mm}/dy=8\text{mm}/dz=5\text{mm}$
Frequency	2450 MHz
Input power	20 dBm
Liquid Temperature	21 °C
Lab Temperature	21 °C
Lab Humidity	45 %

Frequency MHz	1 g SAR (W/kg/W)	10 g SAR (W/kg/W)
	measured	measured
2450	54.19 (5.42)	24.96 (2.50)

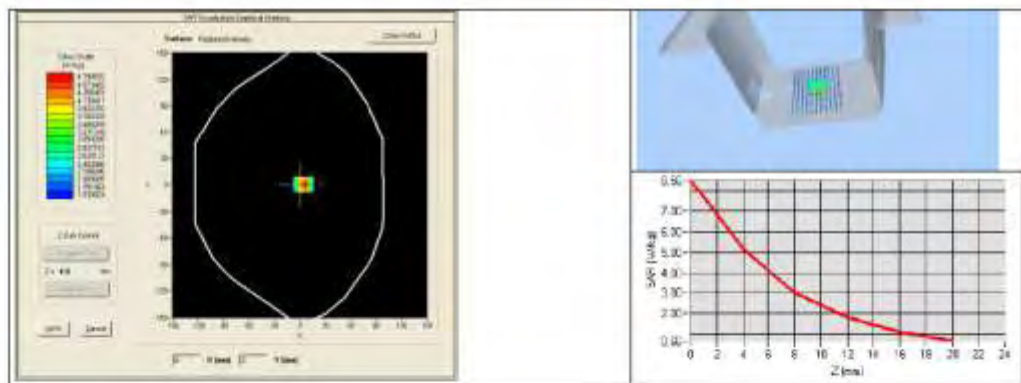



8 LIST OF EQUIPMENT

Equipment Summary Sheet				
Equipment Description	Manufacturer / Model	Identification No.	Current Calibration Date	Next Calibration Date
SAM Phantom	Satimo	SN-20/09-SAM71	Validated. No cal required.	Validated. No cal required.
COMOSAR Test Bench	Version 3	NA	Validated. No cal required.	Validated. No cal required.
Network Analyzer	Rhode & Schwarz ZVA	SN100132	02/2013	02/2016
Calipers	Carrera	CALIPER-01	12/2010	12/2013
Reference Probe	Satimo	EPG122 SN 18/11	Characterized prior to test. No cal required.	Characterized prior to test. No cal required.
Multimeter	Keithley 2000	1188656	11/2010	11/2013
Signal Generator	Agilent E4438C	MY49070581	12/2010	12/2013
Amplifier	Aethercomm	SN 046	Characterized prior to test. No cal required.	Characterized prior to test. No cal required.
Power Meter	HP E4418A	US38261498	11/2010	11/2013
Power Sensor	HP ECP-E26A	US37181460	11/2010	11/2013
Directional Coupler	Narda 4216-20	01388	Characterized prior to test. No cal required.	Characterized prior to test. No cal required.
Temperature and Humidity Sensor	Control Company	11-661-9	3/2012	3/2014