SAR Test Report

Report No.: AGC06P121101-3S1

FCC ID : UOSAM316
PRODUCT DESIGNATION : mobile phone
BRAND NAME : AMGOO
MODEL NAME : AM316
CLIENT : Amgoo Telecom Co., Ltd.
DATE OF ISSUE : Nov.19,2012
STANDARD(S) : FCC Oet65 Supplement C June 2001
: IEEE Std. 1528-2003,47CFR § 2.1093
REPORT VERSION : V1.0

Attestation of Global Compliance(Shenzhen) Co., Ltd.

CAUTION: This report shall not be reproduced except in full without the written permission of the test laboratory and shall not be quoted out of context.

Test Report Certification

Applicant Name	Amgoo Telecom Co., Ltd.
Applicant Address	6/F, Block 3, Tongjian Building, NO.2013, Middle Shennan Rd., Futian District, Shenzhen, China
Manufacturer Name	Amgoo Telecom Co., Ltd.
Manufacturer Address	6/F, Block 3, Tongjian Building, NO.2013, Middle Shennan Rd., Futian District, Shenzhen, China
Product Designation	mobile phone
Brand Name	AMGOO
Model Name	AM316
Different Description	N/A
EUT Voltage	DC3.7V by battery
Applicable Standard	FCC Oet65 Supplement C June 2001 IEEE Std. 1528-2003,47CFR § 2.1093
Test Date	Nov.19,2012
Test Results	MAX SAR MEASUREMENT(1g) Head: 0.930 W/Kg Body: 1.181 W/Kg (Scaling SAR= 1.203 W/Kg)
Performed Location	Attestation of Global Compliance(Shenzhen) Co., Ltd. 2 F, Building 2, No.1-No.4, Chaxi Sanwei Technical Industrial Park, Gushu, Xixiang Street, Bao'an District, Shenzhen, China

Vivi Zeng

Documented By _____
Vivi Zeng Nov.19,2012

Angela Li

Checked By _____
Angela Li Nov.19,2012

Solger Zhang

Authorized By _____
Solger Zhang Nov.19,2012

TABLE OF CONTENTS

1. GENERAL INFORMATION	3
1.1. EUT DESCRIPTION	3
1.2. TEST PROCEDURE	5
1.3. TEST ENVIRONMENT	5
2. SAR MEASUREMENT SYSTEM	6
2.1. COMOSAR SYSTEM DESCRIPTION	6
2.2. COMOSAR E-FIELD PROBE	8
2.3. ROBOT	8
2.4. VIDEO POSITIONING SYSTEM	9
2.5. DEVICE HOLDER	9
2.6. SAM TWIN PHANTOM	10
3. TISSUE SIMULATING LIQUID	11
3.1. THE COMPOSITION OF THE TISSUE SIMULATING LIQUID	11
3.2. TISSUE CALIBRATION RESULT	12
3.3. TISSUE DIELECTRIC PARAMETERS FOR HEAD AND BODY PHANTOMS	13
4. SAR MEASUREMENT PROCEDURE	14
4.1. SAR SYSTEM VALIDATION	14
4.2. SAR MEASUREMENT PROCEDURE	16
5. SAR EXPOSURE LIMITS	17
6. TEST EQUIPMENT LIST	18
7. MEASUREMENT UNCERTAINTY	19
8. CONDUCTED POWER MEASUREMENT	20
9. TEST RESULTS	21
9.1. SAR TEST RESULTS SUMMARY	21
APPENDIX A. SAR SYSTEM VALIDATION DATA	22
APPENDIX B. SAR MEASUREMENT DATA	30
APPENDIX C. TEST SETUP PHOTOGRAPHS & EUT PHOTOGRAPHS	98
APPENDIX D. PROBE CALIBRATION DATA	109
APPENDIX E. DIPOLE CALIBRATION DATA	118

1. General Information

1.1. EUT Description

General Information	
Product Designation	mobile phone
Test Model	AM316
Hardware Version	C909B-V1.01-PCB
Software Version	N/A
Device Category	Portable
RF Exposure Environment	Uncontrolled
Antenna Type	Internal
GSM and GPRS	
Support Band	<input checked="" type="checkbox"/> GSM 850 <input checked="" type="checkbox"/> PCS 1900 (U.S. Bands) <input checked="" type="checkbox"/> GSM 900 <input checked="" type="checkbox"/> DCS 1800 (Non-U.S. Bands)
GPRS Type	Class B
GPRS Class	Class 8,10 ,12(1Tx+4Rx, 2Tx+3Rx, 3Tx+2Rx, 4Tx+1Rx)
TX Frequency Range	GSM 850 : 824.2~848.8MHz; PCS 1900: 1850.2~1909.8MHz;
RX Frequency Range	GSM 850 : 869~894MHz PCS 1900: 1930~1990MHz
Release Version	R99
Type of modulation	GMSK for GSM/GPRS
Antenna Gain	1.0dBi
Max. Output Power (Avg. Burst Power)	GSM850: 31.63dBm(32.56dBm-Peak Power) PCS1900: 28.49dBm(29.45dBm-Peak Power)
Max. Output Power (Radiated)	GSM850: 30.49dBm- ERP PCS1900: 28.22dBm- EIRP
Bluetooth	
Bluetooth Version	<input type="checkbox"/> V2.0 <input type="checkbox"/> V2.1 <input checked="" type="checkbox"/> V2.1+EDR <input type="checkbox"/> V3.0 <input type="checkbox"/> V3.0+EDR

Operation Frequency	2402~2480MHz
Type of modulation	<input checked="" type="checkbox"/> GFSK <input checked="" type="checkbox"/> π/4-DQPSK <input checked="" type="checkbox"/> 8-DPSK
Max. Output Power (Peak Conducted)	3.79dBm
Antenna Gain	0.8dBi
Accessories	
Battery	Brand name: AMG00 Model No. : AM-4D Voltage and Capacitance: 3.7 V & 1100mA
Adapter	Brand name: AMG00 Model No. : CH4 Input: AC 100-240V Output: DC 5V
Earphone	Brand name: N/A Model No. : N/A

Note: The sample used for testing is end product.

1.2. Test Procedure

1	Setup the EUT and simulators as shown on above.
2	Turn on the power of all equipment.
3	EUT Communicate with CMU 200, and test them respectively at U.S. bands

1.3. Test Environment

Ambient conditions in the laboratory:

Items	Required	Actual
Temperature (°C)	18-25	21± 2
Humidity (%RH)	30-70	55±2

2. SAR Measurement System

2.1. COMOSAR System Description

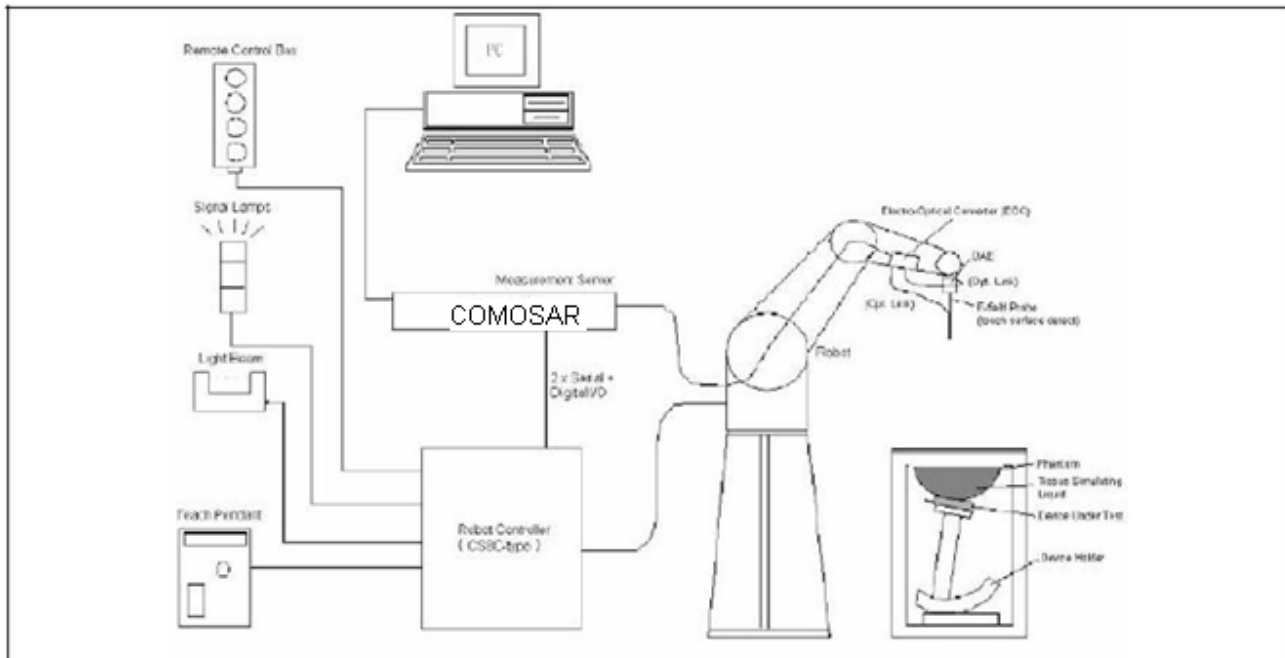

The COMOSAR system for performing compliance tests consists of the following items:

A standard high precision 6-axis robot with controller, teach pendant and software.

An arm extension for accommodating the data acquisition electronics (DAE).

A data acquisition electronics (DAE) which performs the signal amplification, signal multiplexing, AD-conversion, offset measurements, mechanical surface detection, collision detection, etc. The unit is battery powered with standard or rechargeable batteries. The signal is optically transmitted to the EOC.

The Electro-optical converter (EOC) performs the conversion from optical to electrical signals for the digital Communicate Mobile mobile phone to the DAE. To use optical surface detection, a special version of the EOC is required. The EOC signal is transmitted to the measurement server.

The Light Beam used is for probe alignment. This improves the (absolute) accuracy of the probe positioning.

A computer running WinXP and the Opensar software.

Remote control and teach pendant as well as additional circuitry for robot safety such as warning lamps, etc.

The phantom, the device holder and other accessories according to the targeted measurement.

2.1.1. Applications

Predefined procedures and evaluations for automated compliance testing with all worldwide standards, e.g., IEEE 1528, OET 65, IEC 62209-1, IEC 62209-2, EN 50360, EN 50383 and others.

2.1.2. Area Scans

Area scans are defined prior to the measurement process being executed with a user defined variable spacing between each measurement point (integral) allowing low uncertainty measurements to be conducted. Scans defined for FCC applications utilize a 10mm² step integral, with 1mm interpolation used to locate the peak SAR area used for zoom scan assessments.

When an Area Scan has measured all reachable points, it computes the field maxima found in the scanned area, within a range of the global maximum. The range (in dB) is specified in the standards for compliance testing. For example, a 2 dB range is required in IEEE 1528-2003, EN 50361 and IEC 62209 standards, whereby 3 dB is a requirement when compliance is assessed in accordance with the ARIB standard (Japan).

2.1.3. Zoom Scan (Cube Scan Averaging)

Zoom Scans are used to assess the peak spatial SAR values within a cubic averaging volume containing 1 g and 10 g of simulated tissue. A density of 1000 kg/m³ is used to represent the head and body tissue density and not the phantom liquid density, in order to be consistent with the definition of the liquid dielectric properties, i.e. the side length of the 1 g cube is 10mm, with the side length of the 10 g cube 21,5mm.

The zoom scan integer steps can be user defined so as to reduce uncertainty, but normal practice for typical test applications utilize a physical step of 7x7x7 (5mmx5mmx5mm) providing a volume of 30mm in the X & Y axis, and 30mm in the Z axis.

2.1.4. Uncertainty of Inter-/Extrapolation and Averaging

In order to evaluate the uncertainty of the interpolation, extrapolation and averaged SAR calculation algorithms of the Post processor, COMOSAR allows the generation of measurement grids which are artificially predefined by analytically based test functions. Therefore, the grids of area scans and zoom scans can be filled with uncertainty test data, according to the SAR benchmark functions of IEEE 1528. The three analytical functions shown in equations as below are used to describe the possible range of the expected SAR distributions for the tested handsets. The field gradients are covered by the spatially flat distribution f1, the spatially steep distribution f3 and f2 accounts for H-field cancellation on the phantom/tissue surface.

$$f_1(x, y, z) = A e^{-\frac{z}{2a}} \cos^2 \left(\frac{\pi \sqrt{x'^2 + y'^2}}{2 \cdot 5a} \right)$$

$$f_2(x, y, z) = A e^{-\frac{z}{a}} \frac{a^2}{a^2 + x'^2} \left(3 - e^{-\frac{2z}{a}} \right) \cos^2 \left(\frac{\pi y'}{2 \cdot 3a} \right)$$

$$f_3(x, y, z) = A \frac{a^2}{\frac{a^2}{4} + x'^2 + y'^2} \left(e^{-\frac{2z}{a}} + \frac{a^2}{2(a + 2z)^2} \right)$$

2.2. COMOSAR E-Field Probe

The SAR measurement is conducted with the dissymmetric probe manufactured by SPEAG.

The probe is specially designed and calibrated for use in liquid with high permittivity. The dissymmetric probe has special calibration in liquid at different frequency.

SPEAG conducts the probe calibration in compliance with international and national standards (e.g. IEEE 1528, EN62209-1, IEC 62209, etc.) Under ISO17025. The calibration data are in Appendix D.

2.2.1. Isotropic E-Field Probe Specification

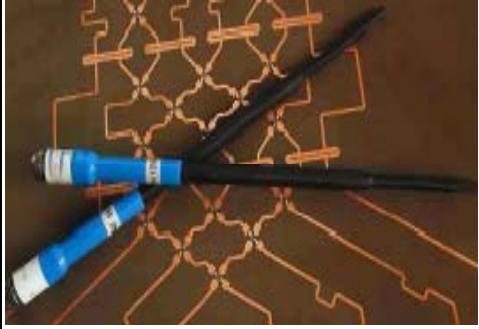
Model	SSE5	
Manufacture	Satimo	
frequency	0.3 GHz-6GHz Linearity:±0.2dB(300 MHz-6GHz)	
Dynamic Range	0.01W/Kg-100W/Kg Linearity:±0.2dB	
Dimensions	Overall length:330mm Length of individual dipoles:4.5mm Maximum external diameter:8mm Probe Tip external diameter:5mm Distance between dipoles/ probe extremity:2.7mm	
Appli-mobile phone	High precision dosimetric measurements in any exposure scenario (e.g., very strong gradient fields). Only probe which enables compliance testing for frequencies up to 3 GHz with precision of better 30%.	

2.3. Robot

The COMOSAR system uses the high precision robots TX90 XL type out of the newer series from Satimo SA (France). For the 6-axis controller COMOSAR system, the KUKA robot controller version from Satimo is used.

The XL robot series have many features that are important for our application:

- High precision (repeatability 0.02 mm)
- High reliability (industrial design)
- Jerk-free straight movements
- Low ELF interference (the closed metallic construction shields against motor control fields)
- 6-axis controller



2.4. Video Positioning System

The video positioning system is used in OpenSAR to check the probe. Which is composed of a camera, LED, mirror and mechanical parts. The camera is piloted by the main computer with firewire link.

During the process, the actual position of the probe tip with respect to the robot arm is measured, as well as the probe length and the horizontal probe offset. The software then corrects all movements, such that the robot coordinates are valid for the probe tip.

The repeatability of this process is better than 0.1 mm. If a position has been taught with an aligned probe, the same position will be reached with another aligned probe within 0.1 mm, even if the other probe has different dimensions. During probe rotations, the probe tip will keep its actual position.



2.5. Device Holder

The COMOSAR device holder is designed to cope with different positions given in the standard. It has two scales for the device rotation (with respect to the body axis) and the device inclination (with respect to the line between the ear reference points). The rotation center for both scales is the ear reference point (EPR).

Thus the device needs no repositioning when changing the angles.

The COMOSAR device holder has been made out of low-loss POM material having the following dielectric parameters: relative permittivity $\epsilon_r = 3$ and loss tangent $\delta = 0.02$. The amount of dielectric material has been reduced in the closest vicinity of the device, since measurements have suggested that the influence of the clamp on the test results could thus be lowered.

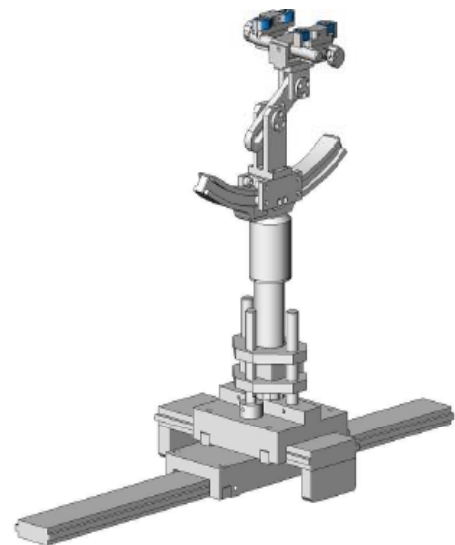

2.6. SAM Twin Phantom

The SAM twin phantom is a fiberglass shell phantom with 2mm shell thickness (except the ear region where shell thickness increases to 6mm). It has three measurement areas:

- Left head
- Right head
- Flat phantom



The bottom plate contains three pair of bolts for locking the device holder. The device holder positions are adjusted to the standard measurement positions in the three sections. A white cover is provided to tap the phantom during off-periods to prevent water evaporation and changes in the liquid parameters. On the phantom top, three reference markers are provided to identify the phantom position with respect to the robot.

3. Tissue Simulating Liquid

3.1. The composition of the tissue simulating liquid

Ingredient	850MHz	850MHz	1900MHz	1900MHz
(% Weight)	Head	Body	Head	Body
Water	40.45	52.4	54.90	40.5
Salt	1.42	1.40	0.18	0.50
Sugar	57.6	45.0	0.00	58.0
HEC	0.40	1.00	0.00	0.50
Preventol	0.10	0.20	0.00	0.50
DGBE	0.00	0.00	44.92	0.00

3.2. Tissue Calibration Result

The dielectric parameters of the liquids were verified prior to the SAR evaluation using COMOSAR Dielectric Probe Kit and R&S Network Analyzer ZVL6 .

Tissue Stimulant Measurement for GSM 850					
Frequency (MHz)	Parts	Description	Dielectric Parameters		Tissue Temp [°C]
850MHz	Head	Reference result ±5% window	ϵ_r 41.50 39.425-43.575	δ [s/m] 0.90 0.855-0.945	N/A
		Nov.19,2012	40.64	0.88	21
850MHz	Body	Reference result ±5% window	ϵ_r 55.20 52.44-57.96	δ [s/m] 0.97 0.92-1.02	N/A
		Nov.19,2012	54.19	0.97	21

Tissue Stimulant Measurement for PCS 1900					
Frequency (MHz)	Parts	Description	Dielectric Parameters		Tissue Temp [°C]
1900MHz	Head	Reference result ±5% window	ϵ_r 40.00 38.00-42.00	δ [s/m] 1.40 1.33-1.47	N/A
		Nov.19,2012	39.29	1.41	21
1900MHz	Body	Reference result ±5% window	ϵ_r 53.30 50.64-55.97	δ [s/m] 1.52 1.44-1.60	N/A
		Nov.19,2012	54.01	1.47	21

3.3. Tissue Dielectric Parameters for Head and Body Phantoms

The head tissue dielectric parameters recommended by the IEEE SCC-34/SC-2 in P1528 have been incorporated in the following table. These head parameters are derived from planar layer models simulating the highest expected SAR for the dielectric properties and tissue thickness variations in a human head. Other head and body tissue parameters that have not been specified in P1528 are derived from the tissue dielectric parameters computed from the 4-Cole-Cole equations described in Reference [12] and extrapolated according to the head parameters specified in P1528.

Target Frequency (MHz)	head		body	
	ϵ_r	σ (S/m)	ϵ_r	σ (S/m)
300	45.3	0.87	58.2	0.92
450	43.5	0.87	56.7	0.94
850	41.5	0.90	55.2	0.97
900	41.5	0.97	55.0	1.05
915	41.5	1.01	55.0	1.06
1450	40.5	1.20	54.0	1.30
1610	40.3	1.29	53.8	1.40
1800 – 2000	40.0	1.40	53.3	1.52
2450	39.2	1.80	52.7	1.95
3000	38.5	2.40	52.0	2.73
5800	35.3	5.27	48.2	6.00

(ϵ_r = relative permittivity, σ = conductivity and $\rho = 1000$ kg/m³)

4. SAR Measurement Procedure

4.1. SAR System Validation

4.1.1. Validation Dipoles

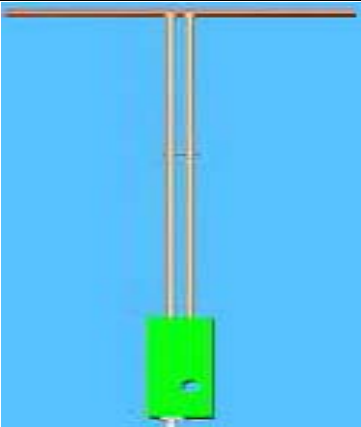
	<p>The dipoles used is based on the IEEE-1528 standard, and is complied with mechanical and electrical specifications in line with the requirements of both IEEE and FCC Supplement C. the table below provides details for the mechanical and electrical Specifications for the dipoles.</p>
---	---

Frequency	L (mm)	h (mm)	d (mm)
900 MHz	149.0	83.3	3.6
1900MHz	68	39.5	3.6

4.1.2. Validation Result

System Performance Check at 850 MHz &1900MHz for Head				
Validation Kit: SN 46/11DIP 0G900-185				
Frequency [MHz]	Description	SAR [w/kg] 1g	SAR [w/kg] 10g	Tissue Temp.[°C]
850 MHz	Reference result ± 10% window	10.9 9.81 to 11.99	6.99 6.29 to 7.69	N/A
	Nov.19,2012	11.56	6.85	21.0
Validation Kit: SN 46/11DIP 1G900-187				
Frequency [MHz]	Description	SAR [w/kg] 1g	SAR [w/kg] 10g	Tissue Temp.[°C]
1900 MHz	Reference result ± 10% window	39.7 35.73 to 43.67	20.5 18.45 to 22.55	N/A
	Nov.19,2012	41.02	21.26	21.0
Note: All SAR values are normalized to 1W forward power.				

4.2. SAR Measurement Procedure

The COMOSAR calculates SAR using the following equation,

$$SAR = \frac{\sigma |E|^2}{\rho}$$

σ : represents the simulated tissue conductivity

ρ : represents the tissue density

The EUT is set to transmit at the required power in line with product specification, at each frequency relating to the LOW, MID, and HIGH channel settings.

Pre-scans are made on the device to establish the location for the transmitting antenna, using a large area scan in either air or tissue simulation fluid.

The EUT is placed against the Universal Phantom where the maximum area scan dimensions are larger than the physical size of the resonating antenna. When the scan size is not large enough to cover the peak SAR distribution, it is modified by either extending the area scan size in both the X and Y directions, or the device is shifted within the predefined area.

The area scan is then run to establish the peak SAR location (interpolated resolution set at 1mm^2) which is then used to orient the center of the zoom scan. The zoom scan is then executed and the 1g and 10g averages are derived from the zoom scan volume (interpolated resolution set at 1mm^3).

When multiple peak SAR location were found during the same configuration or test mode, Zoom scan shall performed on each peak SAR location, only the peak point with maximum SAR value will be reported for the configuration or test mode.

5. SAR Exposure Limits

SAR assessments have been made in line with the requirements of IEEE-1528, FCC Supplement C, and comply with ANSI/IEEE C95.1-1992 “Uncontrolled Environments” limits. These limits apply to a location which is deemed as “Uncontrolled Environment” which can be described as a situation where the general public may be exposed to an RF source with no prior knowledge or control over their exposure.

Limits for General Population/Uncontrolled Exposure (W/kg)

Type Exposure	Uncontrolled Environment Limit
Spatial Peak SAR (1g cube tissue for brain or body)	1.60 W/kg

6. Test Equipment List

Equipment description	Manufacturer/Model	Identification No.	Current calibration date	Next calibration date
SAR Probe	Satimo	SN_3511_EP132	12/09/2011	12/08/2012
Phantom	Satimo	SN_4511_SAM90	Validated. No cal required.	Validated. No cal required.
Liquid	Satimo	-	Validated. No cal required.	Validated. No cal required.
Comm Tester	R&S - CMU200	069Y7-158-13-712	12/09/2011	12/08/2012
Multimeter	Keithley 2000	1188656	12/09/2011	12/08/2012
Dipole	Satimo SID900	SN46/11 DIP 0G900-185	12/09/2011	12/08/2014
Dipole	Satimo SID1900	SN46/11 DIP 1G900-187	12/09/2011	12/08/2014
Amplifier	Aethercomm	SN 046	12/09/2011	12/08/2012
Power Meter	HP E4418A	US38261498	03/30/2012	03/29/2013
Network Analyzer	Rhode & Schwarz ZVA	SN100132	02/07/2012	02/06/2013

Note: Per KDB 50824 Dipole SAR Validation Verification, AGC Lab has adopted 3 years calibration intervals. On annual basis, every measurement dipole has been evaluated and is in compliance with the following criteria:

1. There is no physical damage on the dipole;
2. System validation with specific dipole is within 10% of calibrated value;
3. Return-loss is within 20% of calibrated measurement;
4. Impedance is within 5Ω of calibrated measurement.

7. Measurement Uncertainty

Satimo Uncertainty

Measurement uncertainty for 300 MHz to 6 GHz averaged over 1 gram / 10 gram.

Error Description	Sec	Tol (±%)	Prob. Dist.	Div.	(Ci) 1g	(Ci) 10g	Std. Unc. (1g) (±%)	Std. Unc. (10g)(±%)	(Vi) Veff
Measurement System									
Probe Calibration	E.2.1	6	N	1	1	1	6	6	∞
Axial Isotropy	E.2.2	3	R	$\sqrt{3}$	$(1-c_p)^{1/2}$	$(1-c_p)^{1/2}$	1.22474	1.22474	∞
Hemispherical Isotropy	E.2.2	5	R	$\sqrt{3}$	$\sqrt{C_p}$	$\sqrt{C_p}$	2.04124	2.04124	∞
Boundary Effects	E.2.3	1	R	$\sqrt{3}$	1	1	0.57735	0.57735	∞
Linearity	E.2.4	5	R	$\sqrt{3}$	1	1	2.88675	2.88675	∞
System Detection Limits	E.2.5	1	R	$\sqrt{3}$	1	1	0.57735	0.57735	∞
Readout Electronics	E.2.6	0.5	N	1	1	1	0.5	0.5	∞
Response Time	E.2.7	0.2	R	$\sqrt{3}$	1	1	0.11547	0.11547	∞
Integration Time	E.2.8	2	R	$\sqrt{3}$	1	1	1.1547	1.1547	∞
RF Ambient Noise	E.6.1	3	R	$\sqrt{3}$	1	1	1.73205	1.73205	∞
Probe Positioner Mechanical Tolerance	E.6.2	2	R	$\sqrt{3}$	1	1	1.1547	1.1547	∞
Probe Positioning with Respect to Phantom Shell	E.6.3	1	R	$\sqrt{3}$	1	1	0.57735	0.57735	∞
Extrapolation, interpolation and Integration Algorithms for Max. SAR Evaluation	E.5.2	1.5	R	$\sqrt{3}$	1	1	0.86603	0.86603	∞
Dipole									
Device Positioning	8,E.4.2	1	N	$\sqrt{3}$	1	1	0.57735	0.57735	N-1
Power Drift	8.6.6.2	2	R	$\sqrt{3}$	1	1	1.1547	1.1547	∞
Phantom and Tissue Parameters									
Phantom Uncertainty	E.3.1	4	R	$\sqrt{3}$	1	1	2.3094	2.3094	∞
Liquid Conductivity (target)	E.3.2	5	R	$\sqrt{3}$	0.64	0.43	1.84752	1.2413	∞
Liquid Conductivity (meas.)	E.3.3	2.5	N	1	0.64	0.43	1.6	1.075	∞
Liquid Permittivity (target)	E.3.2	3	R	$\sqrt{3}$	0.6	0.49	1.03923	0.8487	∞
Liquid Permittivity (meas.)	E.3.3	2.5	N	1	0.6	0.49	1.5	1.225	M
Combined Standard Uncertainty			RSS				8.09272	7.9296	
Expanded Uncertainty (95%CONFIDENCE INTERVAL)			k				16.18544	15.8592	

8. Conducted Power Measurement

Mode	Frequency(MHz)	Peak Power(dBm)	Avg. Burst Power(dBm)	Duty cycle Factor(dBm)	Frame Power(dBm)
Maximum Power <1>					
GSM 850	824.2	32.56	31.63	-9	22.63
	836.6	32.51	31.60	-9	22.60
	848.8	32.46	31.56	-9	22.56
GPRS 850 (1 Slot)	824.2	32.48	31.49	-9	22.49
	836.6	32.45	31.47	-9	22.47
	848.8	32.47	31.38	-9	22.38
GPRS 850 (2 Slot)	824.2	29.62	28.43	-6	22.43
	836.6	29.53	28.41	-6	22.41
	848.8	29.49	28.35	-6	22.35
GPRS 850 (3 Slot)	824.2	27.56	26.49	-4.26	22.23
	836.6	27.48	26.44	-4.26	22.18
	848.8	27.41	26.35	-4.26	22.09
GPRS 850 (4 Slot)	824.2	26.57	25.48	-3	22.48
	836.6	26.52	25.36	-3	22.36
	848.8	26.47	25.31	-3	22.31
PCS1900	1850.2	29.37	28.43	-9	19.43
	1880	29.45	28.49	-9	19.49
	1909.8	29.42	28.45	-9	19.45
GPRS1900 (1 Slot)	1850.2	29.33	28.56	-9	19.56
	1880	29.51	28.58	-9	19.58
	1909.8	29.48	28.53	-9	19.53
GPRS1900 (2 Slot)	1850.2	26.61	25.69	-6	19.69
	1880	26.67	25.74	-6	19.74
	1909.8	26.65	25.71	-6	19.71
GPRS1900 (3 Slot)	1850.2	24.81	24.66	-4.26	20.40
	1880	24.92	24.72	-4.26	20.46
	1909.8	24.86	24.68	-4.26	20.42
GPRS1900 (4 Slot)	1850.2	23.62	22.55	-3	19.55
	1880	23.74	22.38	-3	19.38
	1909.8	23.69	22.52	-3	19.52
Maximum Power <2>					
GSM 850	824.2	32.47	31.54	-9	22.54
PCS1900	1880	29.33	28.37	-9	19.37

Note 1:

The Frame Power (Source-based time-averaged Power) is scaled the maximum burst average power based on time slots. The calculated methods are show as following:

Frame Power = Max burst power (1 Up Slot) – 9 dB

Frame Power = Max burst power (2 Up Slot) – 6 dB

Frame Power = Max burst power (3 Up Slot) -4.26dB

Frame Power = Max burst power (4 Up Slot) – 3 dB

9. Test Results

9.1. SAR Test Results Summary

9.1.1. Test position and configuration

Head SAR was performed with the device configured in the positions according to IEEE1528, and Body SAR was performed with the device 15mm from the phantom. Body SAR was also performed with the headset attached and without.

9.1.2. Body SAR with Headset

Testing with the headset was performed at the position and channels that resulted in the highest body SAR. This testing was performed with GPRS transmitting with 2/3/4 uplink timeslots. This operation mode represents the maximum SAR situation, when downloading data via GPRS and listening to music by headset. SAR without the headset attached was significantly higher than with the headset, and also was verified several times and confirmed, so the final test data shown were the worst case without headset. In the Body SAR test result table, body-worn means display of device down, body-front means display of device up.

9.1.3. Operation Mode

This is a multi-slot class 12 device capable of 4 uplink timeslots. During the head SAR test, the device was transmitting with maximum 1 uplink timeslot; during the body SAR test, it was transmitting with maximum 4 uplink timeslots. Additionally, this device doesn't support dual transfer mode (DTM).

9.1.4. Co-locate SAR

According to KDB 447498 and KDB 648474, due to the Max peak power for Bluetooth is less than Pref, the Maximum SAR for GSM part $< 1.2\text{W/Kg}$, thus, regardless the closest separation distance between the GSM antenna and Bluetooth Antenna(The distance between the GSM antenna and Bluetooth Antenna is 7.5cm;), stand-alone SAR and simultaneous transmission SAR is not required.

Other reference document: KDB 941225.

9.1.5. Test Result

SAR MEASUREMENT								
Ambient Temperature (°C) : 21 ± 2						Relative Humidity (%): 55		
Liquid Temperature (°C) : 21 ± 2						Depth of Liquid (cm):>15		
Product: mobile phone								
Test Mode: GSM850 with GMSK modulation								
Configuration			Antenna Position	Frequency		Power Drift (<±5%)	SAR (1g) (W/kg)	Limit (W/kg)
SIM	Position	Status		channel	MHz			
<1>	Left Head	Cheek	Fixed	128	824.2	--	--	--
				190	836.6	1.20	0.362	1.6
				251	848.8	--	--	--
		Tilted	Fixed	128	824.2	--	--	--
				190	836.6	0.89	0.242	1.6
				251	848.8	--	--	--
	Right Head	Cheek	Fixed	128	824.2	--	--	--
				190	836.6	1.35	0.297	1.6
				251	848.8	--	--	--
		Tilted	Fixed	128	824.2	--	--	--
				190	836.6	1.52	0.214	1.6
				251	848.8	--	--	--
<2>	Left	Cheek	Fixed	190	836.6	-1.64	0.339	1.6

Note: when the 1-g SAR is ≤ 0.8 W/kg, testing for low and high channel is optional. refer to KDB 941225.

SAR MEASUREMENT								
Ambient Temperature (°C) : 21 ± 2						Relative Humidity (%): 55		
Liquid Temperature (°C) : 21 ± 2						Depth of Liquid (cm):>15		
Product: mobile phone								
Test Mode: GSM850 with GMSK modulation								
Configuration			Antenna Position	Frequency		Power Drift (<±5%)	SAR (1g) (W/kg)	Limit (W/kg)
SIM	Position	Status		channel	MHz			
<1>	Body back	MS	Fixed	128	824.2	1.08	0.856	1.6
				190	836.6	1.11	0.893	1.6
				251	848.8	1.28	0.937	1.6
		GPRS 2 TS	Fixed	128	824.2	0.75	0.827	1.6
				190	836.6	1.64	0.882	1.6
				251	848.8	0.99	0.715	1.6
		GPRS 3 TS	Fixed	128	824.2	--	--	--
				190	836.6	2.11	0.683	1.6
				251	848.8	--	--	--
		GPRS 4 TS	Fixed	128	824.2	--	--	--
				190	836.6	1.08	0.717	1.6
				251	848.8	--	--	--
	Body Front	MS	Fixed	128	824.2	--	--	--
				190	836.6	0.73	0.358	1.6
				251	848.8	--	--	--
Body back	MS with Earphone	Fixed	128	824.2	--	--	--	
			190	836.6	--	--	--	
			251	848.8	-1.00	0.470	1.6	

Note: when the 1-g SAR is ≤ 0.8 W/kg, testing for low and high channel is optional. refer to KDB 941225.

SAR MEASUREMENT								
Ambient Temperature (°C) : 21 ± 2						Relative Humidity (%): 55		
Liquid Temperature (°C) : 21 ± 2						Depth of Liquid (cm):>15		
Product: mobile phone								
Test Mode: PCS1900 with GMSK modulation								
Configuration			Antenna Position	Frequency		Power Drift (<±5%)	SAR (1g) (W/kg)	Limit (W/kg)
SIM	Position	Status		channel	MHz			
<1>	Left Head	Cheek	Fixed	512	1850.2	--	--	--
				661	1880.0	0.71	0.365	1.6
				810	1909.8	--	--	--
		Tilted	Fixed	512	1850.2	--	--	--
				661	1880.0	0.86	0.154	1.6
				810	1909.8	--	--	--
	Right Head	Cheek	Fixed	512	1850.2	1.08	0.930	1.6
				661	1880.0	-1.52	0.881	1.6
				810	1909.8	1.33	0.856	1.6
		Tilted	Fixed	512	1850.2	--	--	--
				661	1880.0	1.08	0.239	1.6
				810	1909.8	--	--	--
<2>	Right	Cheek	Fixed	512	1850.2	1.62	0.856	1.6

Note: when the 1-g SAR is ≤ 0.8 W/kg, testing for low and high channel is optional. refer to KDB 941225.

SAR MEASUREMENT								
Ambient Temperature (°C) : 21 ± 2						Relative Humidity (%): 55		
Liquid Temperature (°C) : 21 ± 2						Depth of Liquid (cm):>15		
Product: mobile phone								
Test Mode: GSM1900 with GMSK modulation								
Configuration			Antenna Position	Frequency		Power Drift (<±5%)	SAR (1g) (W/kg)	Limit (W/kg)
SIM	Position	Status		channel	MHz			
<1>	Body Back	MS	Fixed	512	1850.2	--	--	--
				661	1880.0	1.05	0.696	1.6
				810	1909.8	--	--	--
		GPRS 2 TS	Fixed	512	1850.2	1.82	0.819	1.6
				661	1880.0	-0.75	0.874	1.6
				810	1909.8	-2.05	0.940	1.6
		GPRS 3 TS	Fixed	512	1850.2	1.63	0.841	1.6
				661	1880.0	1.34	0.925	1.6
				810	1909.8	1.25	0.683	1.6
		GPRS 4 TS	Fixed	512	1850.2	--	--	--
				661	1880.0	-0.45	0.668	1.6
				810	1909.8	--	--	--
	Body front	GPRS 2 TS	Fixed	512	1850.2	--	--	--
				661	1880.0	1.82	0.344	1.6
				810	1909.8	--	--	--
	Body Back	GPRS 2 TS with Earphone	Fixed	512	1850.2	0.99	1.148	1.6
				661	1880.0	-1.74	1.137	1.6
				810	1909.8	-1.05	1.181	1.6

Note: when the 1-g SAR is ≤ 0.8 W/kg, testing for low and high channel is optional. refer to KDB 941225.

Appendix A. SAR System Validation Data

Test Laboratory: AGC Lab

Date: Nov.19,2012

System Check Head 850 MHz

DUT: Dipole 900 MHz Type: SID 900

Communication System CW; Communication System Band: D850(850.0 MHz); Duty Cycle: 1:1; Conv.F=6.79

Frequency: 850 MHz; Medium parameters used: $f = 850$ MHz; $\sigma = 0.88$ mho/m; $\epsilon_r = 40.64$; $\rho = 1000$ kg/m³ ;

Phantom section: Flat Section ; Input Power=10dBm

Ambient temperature (°C): 21, Liquid temperature (°C): 21

Satimo Configuration:

Probe:SSE5; Calibrated: 12/09/2011

- Sensor-Surface: 4mm (Mechanical Surface Detection)

- Phantom: SAM1; Type: SAM

- Measurement SW: OpenSAR V4_02_01

Configuration/System Check GSM850 Head/Area Scan: Measurement grid: dx=8mm, dy=8mm

Configuration/System Check GSM850 Head/Zoom Scan : Measurement grid: dx=8mm, dy=8mm, dz=5mm

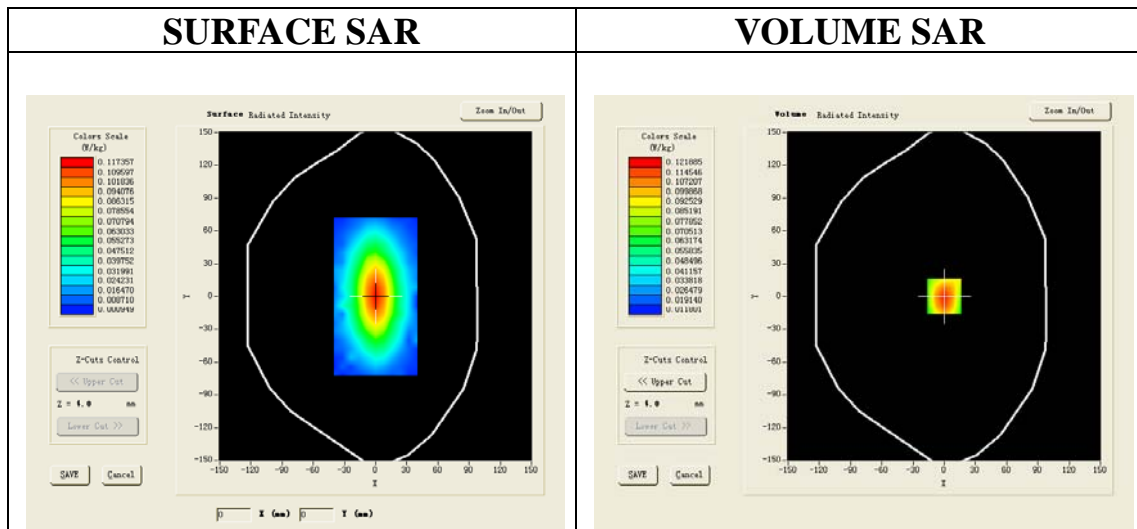

Maximum location: X=0.00, Y=0.00

SAR 10g (W/Kg)	0.068511
SAR 1g (W/Kg)	0.115564

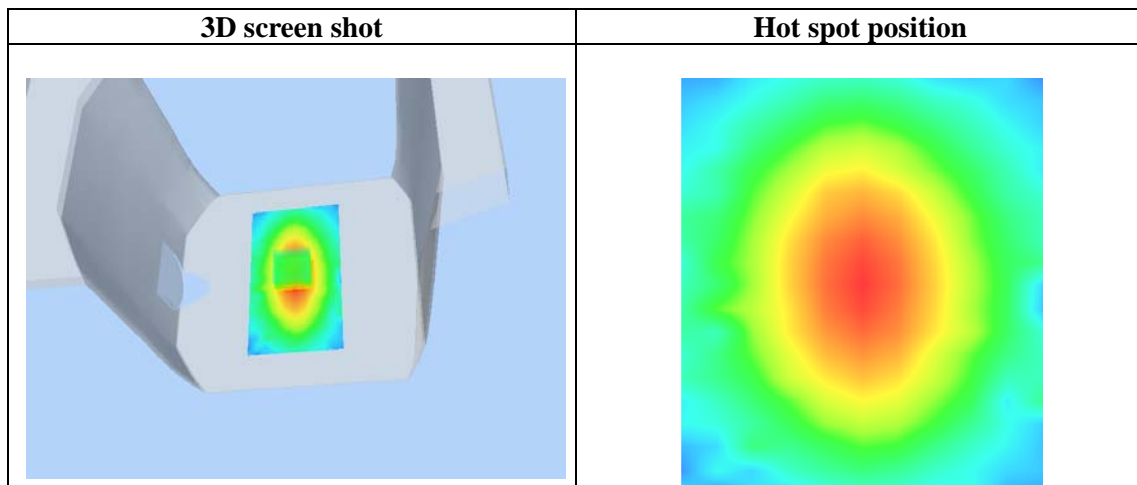
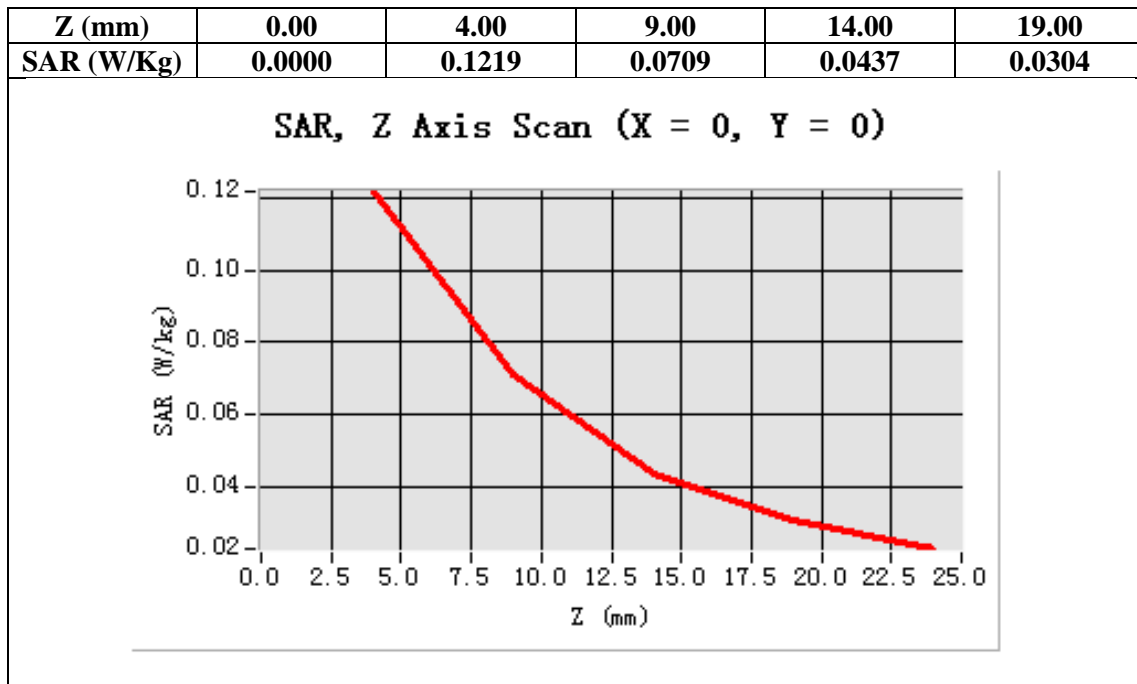

Test Laboratory: AGC Lab
System Check Head 1900MHz

Date: Nov.19,2012

DUT: Dipole 1900 MHz ; Type: SID 1900

Communication System: CW; Communication System Band: D1900 (1900.0 MHz); Duty Cycle:1:1;
Conv.F=6.42Frequency: 1900 MHz; Medium parameters used: $f = 1900$ MHz; $\sigma = 1.41$ mho/m; $\epsilon_r = 39.29$;
 $\rho = 1000$ kg/m³ ;

Phantom section: Flat Section ; Input Power=10dBm
Ambient temperature (°C): 21, Liquid temperature (°C): 21

Satimo Configuration:

Probe:SSE5; Calibrated: 12/09/2011

- Sensor-Surface: 4mm (Mechanical Surface Detection)
- Phantom: SAM1; Type: SAM
- Measurement SW: OpenSAR V4_02_01

Configuration/System Check PCS1900 Head/Area Scan: Measurement grid: dx=8mm,dy=8mm

Configuration/System Check PCS1900 Head/Zoom Scan: Measurement grid: dx=8mm,
dy=8mm, dz=5mm

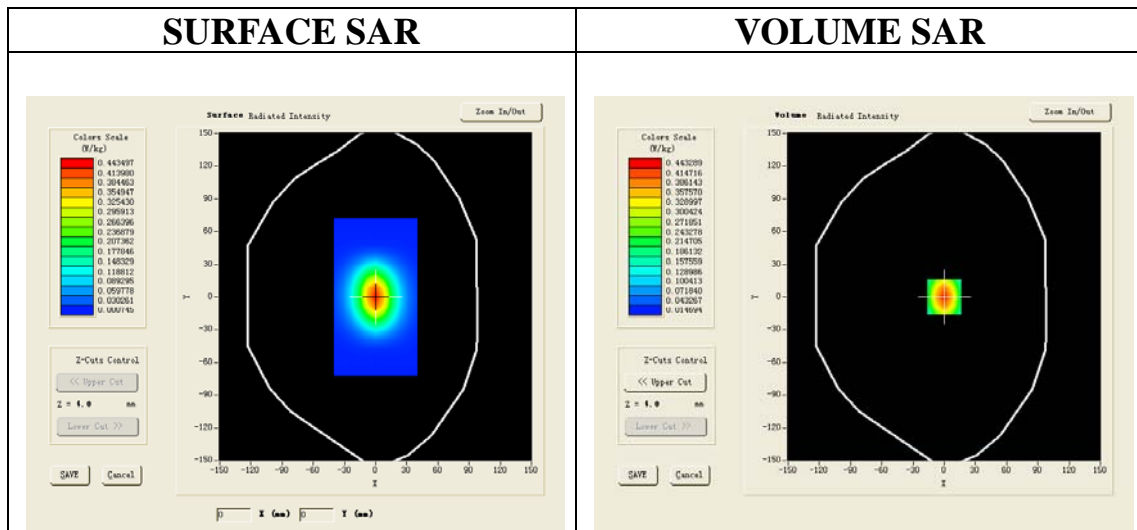

Maximum location: X=0.00, Y=0.00

SAR 10g (W/Kg)	0.212561
SAR 1g (W/Kg)	0.410233

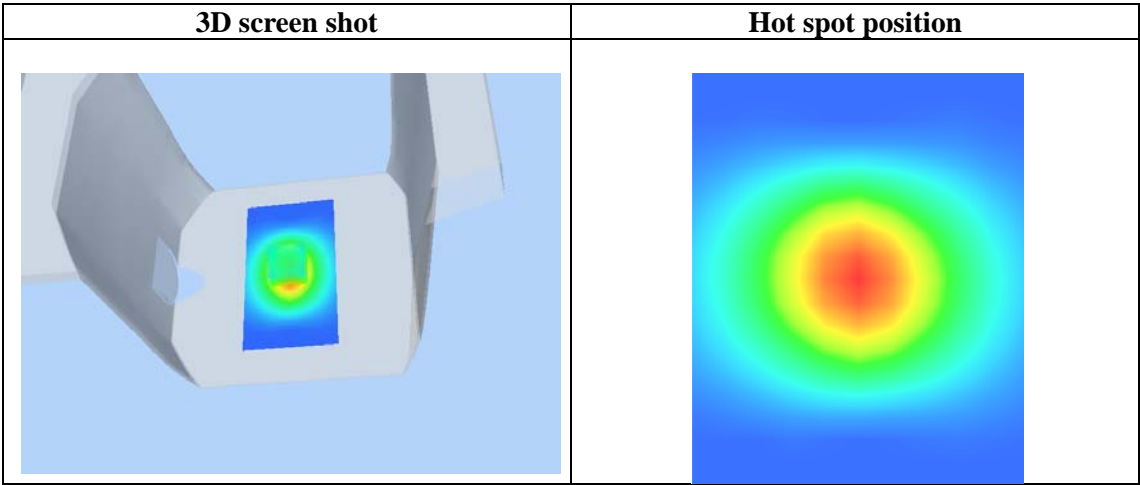
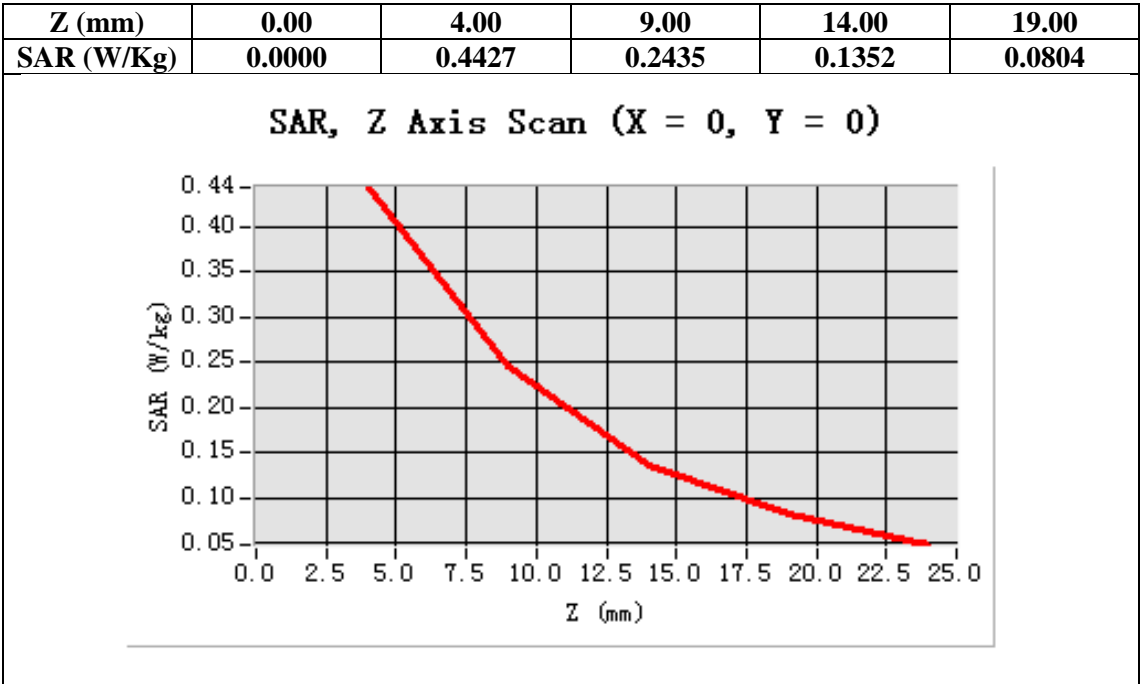

Appendix B. SAR measurement Data

Test Laboratory: AGC Lab

GSM 850 Mid-touch-Left <SIM 1>

DUT: mobile phone ; Type: AM316

Communication System: Generic GSM; Communication System Band: GSM 850; Duty Cycle: 1:8.3; Conv.F=6.79

Frequency: 836.6 MHz; Medium parameters used: $f = 850$ MHz; $\sigma = 0.88$ mho/m; $\epsilon_r = 40.64$;

$\rho = 1000$ kg/m³ ;

Phantom section: Left Section

Ambient temperature (°C): 21.0, Liquid temperature (°C): 21.0

Date: Nov.19,2012

Satimo Configuration:

Probe:SSE5; Calibrated: 12/09/2011

- Sensor-Surface: 4mm (Mechanical Surface Detection)
- Phantom: SAM1; Type: SAM
- Measurement SW: OpenSAR V4_02_01

Configuration/GSM850 Mid-Touch-Left/Area Scan (6x8x1): Measurement grid: dx=20mm, dy=20mm

Configuration/GSM850 Mid-Touch-Left/Zoom Scan (5x5x7)/Cube 0: Measurement grid: dx=8mm, dy=8mm, dz=5mm

Area Scan	sam_direct_droit2_surf8mm.txt
ZoomScan	5x5x7,dx=8mm dy=8mm dz=5mm,Very fast
Phantom	Left head
Device Position	Cheek
Band	GSM850
Channels	Middle
Signal	TDMA (Crest factor: 8.0)

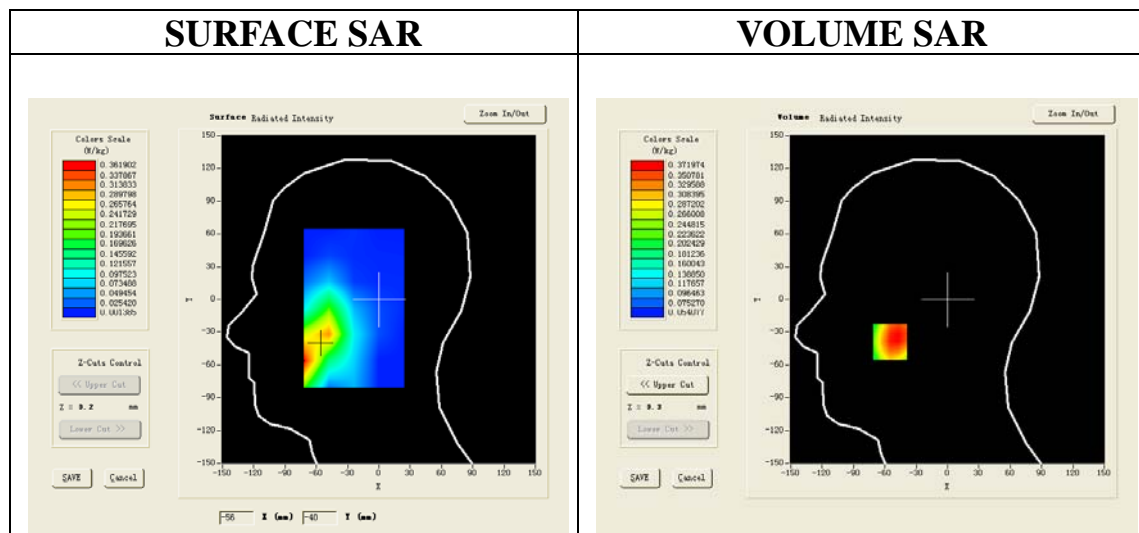

Maximum location: X=-55.00, Y=-39.00

SAR 10g (W/Kg)	0.250560
SAR 1g (W/Kg)	0.362278

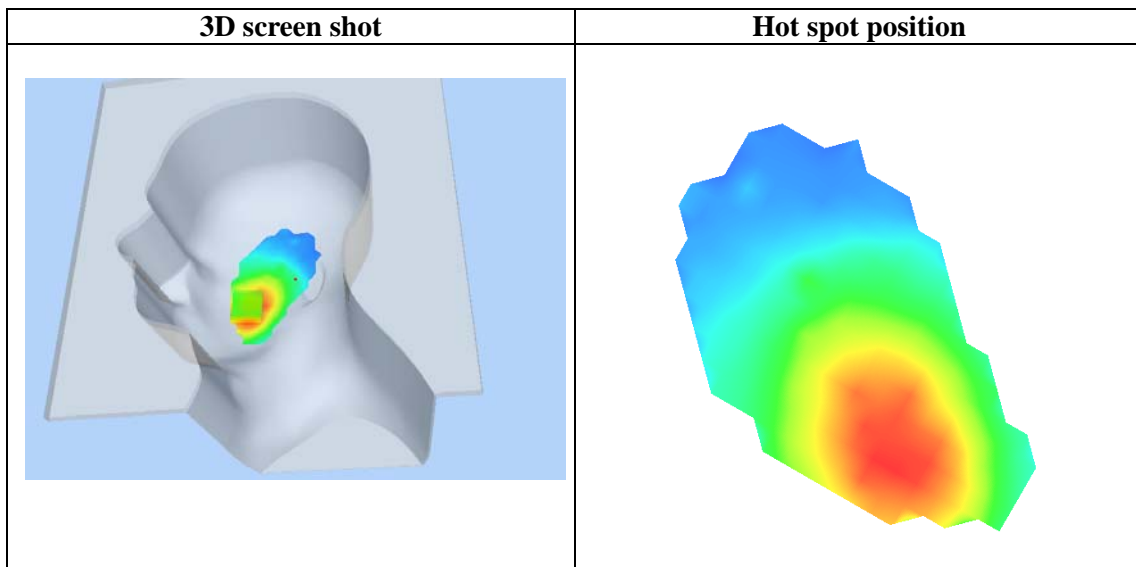
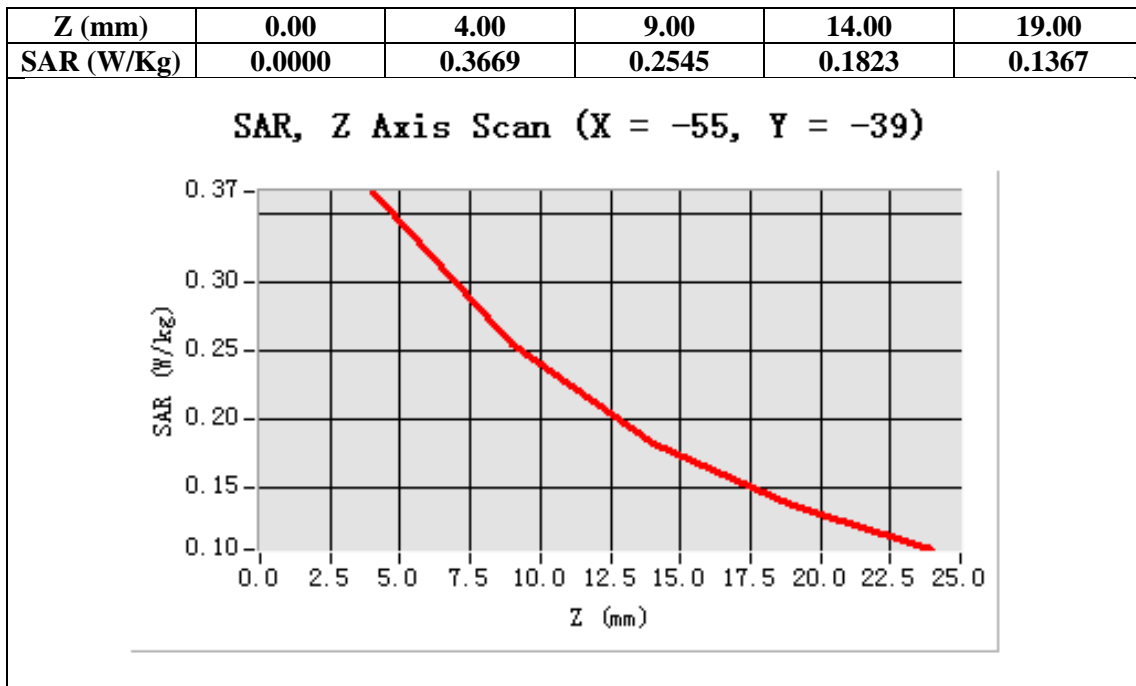

Test Laboratory: AGC Lab

Date: Nov.19,2012

GSM 850 Mid-Tilt-left <SIM 1>

DUT: mobile phone ; Type: AM316

Communication System: Generic GSM; Communication System Band: GSM 850; Duty

Cycle: 1:8.3; Conv.F=6.79;Frequency: 836.6 MHz; Medium parameters used: f = 850 MHz; $\sigma = 0.88$ mho/m;

$\epsilon_r = 40.64$; $\rho = 1000$ kg/m³ ;

Phantom section: Left Section

Ambient temperature (°C): 21.0, Liquid temperature(°C): 21.0

Satimo Configuration:

Probe:SSE5; Calibrated: 12/09/2011

- Sensor-Surface: 4mm (Mechanical Surface Detection)
- Phantom: SAM1; Type: SAM
- Measurement SW: OpenSAR V4_02_01

Configuration/GSM850 Mid-Tilt-Left/Area Scan (6x8x1): Measurement grid: dx=20mm, dy=20mm

Configuration/GSM850 Mid-Tilt-Left/Zoom Scan (5x5x7)/Cube 0: Measurement grid: dx=8mm, dy=8mm,dz=5mm;

Area Scan	sam_direct droit2_surf8mm.txt
ZoomScan	5x5x7,dx=8mm dy=8mm dz=5mm,Very fast
Phantom	Left head
Device Position	Tilt
Band	GSM850
Channels	Middle
Signal	TDMA (Crest factor: 8.0)

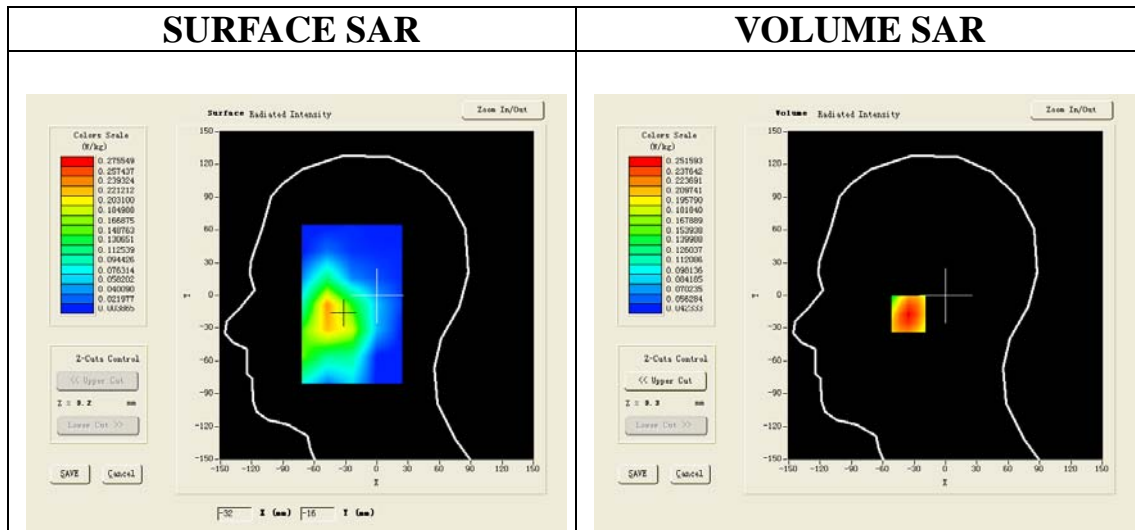

Maximum location: X=-33.00, Y=-17.00

SAR 10g (W/Kg)	0.176682
SAR 1g (W/Kg)	0.241833

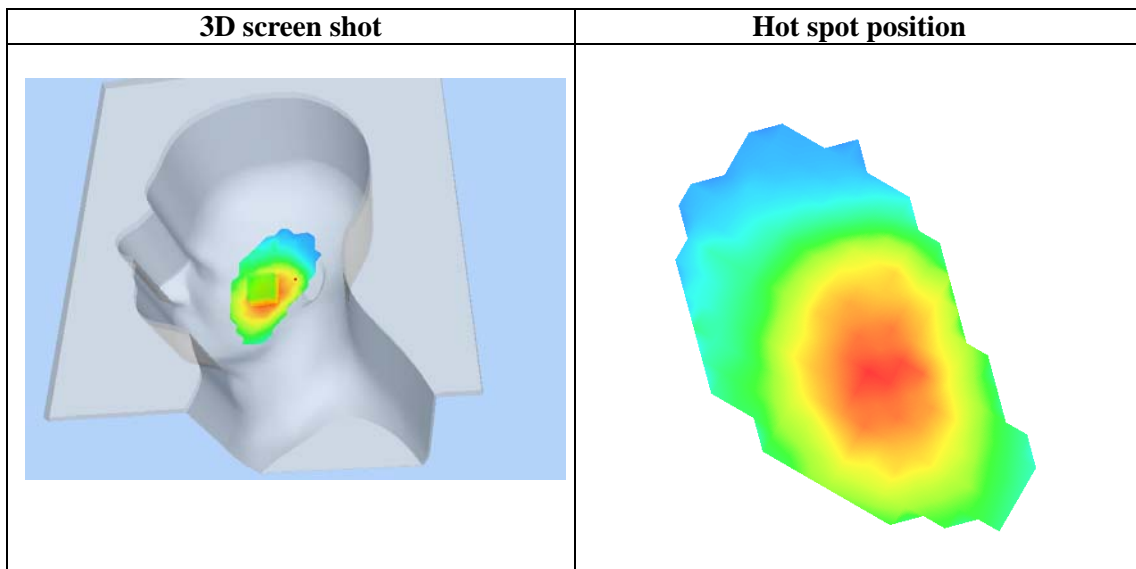
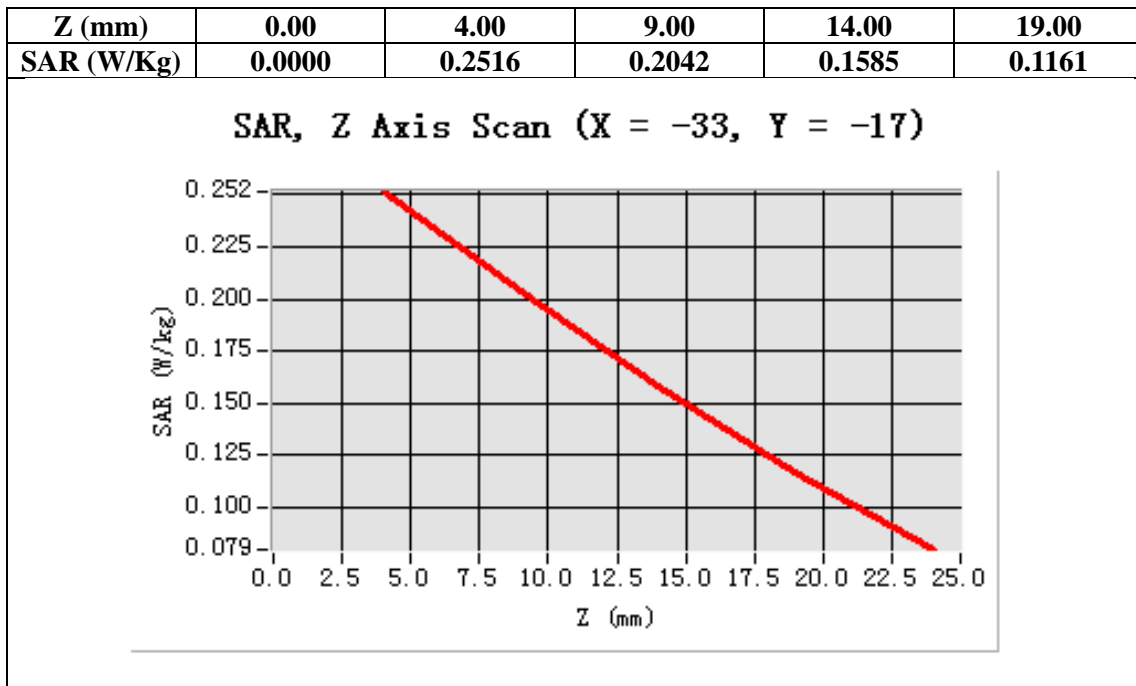

Test Laboratory: AGC Lab

Date: Nov.19,2012

GSM 850 Mid- touch-Right <SIM 1>

DUT: mobile phone ; Type: AM316

Communication System: Generic GSM; Communication System Band: GSM 850; Duty Cycle: 1:8.3;

Conv.F=6.79;Frequency: 836.6 MHz; Medium parameters used: f = 850 MHz; $\sigma = 0.88$ mho/m;

$\epsilon_r = 40.64$; $\rho = 1000$ kg/m³ ;

Phantom section: Right Section

Ambient temperature (°C): 21.0, Liquid temperature (°C): 21.0

Satimo Configuration:

Probe:SSE5; Calibrated: 12/09/2011

- Sensor-Surface: 4mm (Mechanical Surface Detection)
- Phantom: SAM1; Type: SAM
- Measurement SW: OpenSAR V4_02_01

Configuration/GSM850 Mid-Touch-Right/Area Scan: Measurement grid: dx=20mm, dy=20mm

Configuration/GSM850 Mid-Touch-Right/Zoom Scan: Measurement grid: dx=8mm, dy=8mm, dz=5mm;

Area Scan	sam_direct_droit2_surf8mm.txt
ZoomScan	5x5x7,dx=8mm dy=8mm dz=5mm,Very fast
Phantom	Right head
Device Position	Cheek
Band	GSM850
Channels	Middle
Signal	TDMA (Crest factor: 8.0)

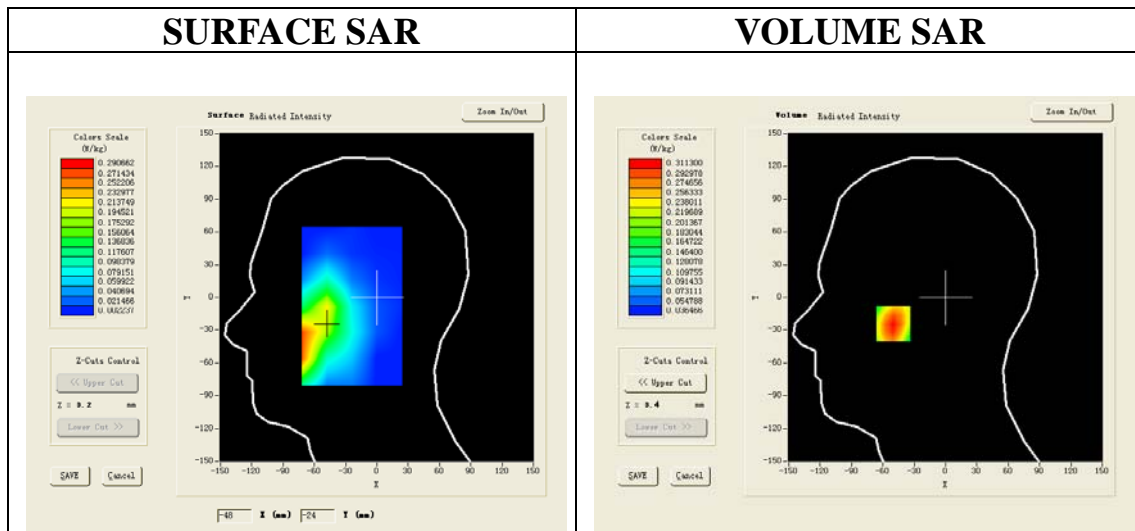

Maximum location: X=-50.00, Y=-24.00

SAR 10g (W/Kg)	0.197159
SAR 1g (W/Kg)	0.296573

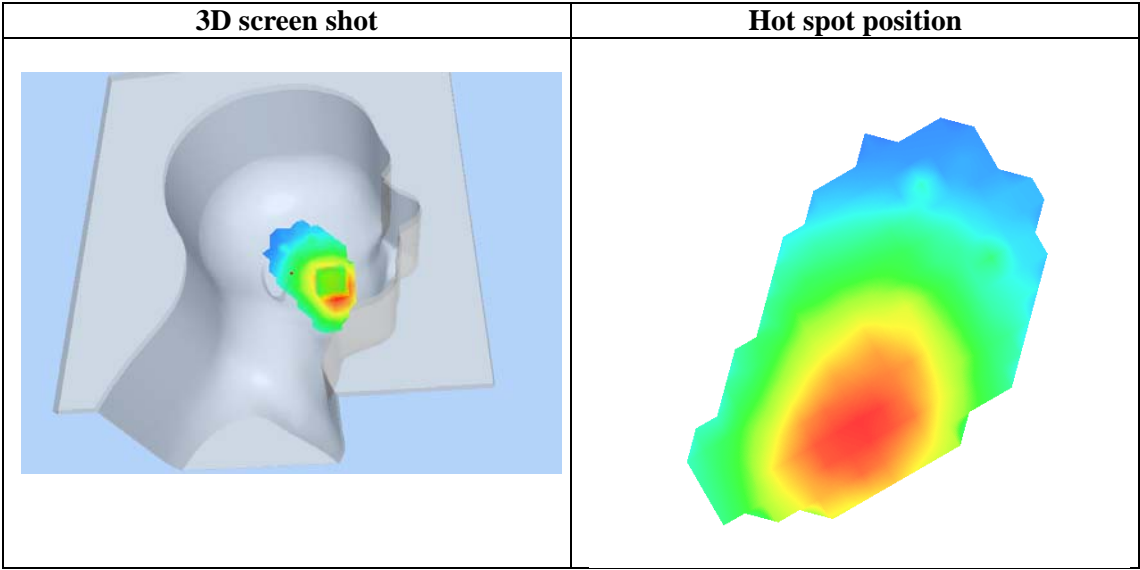
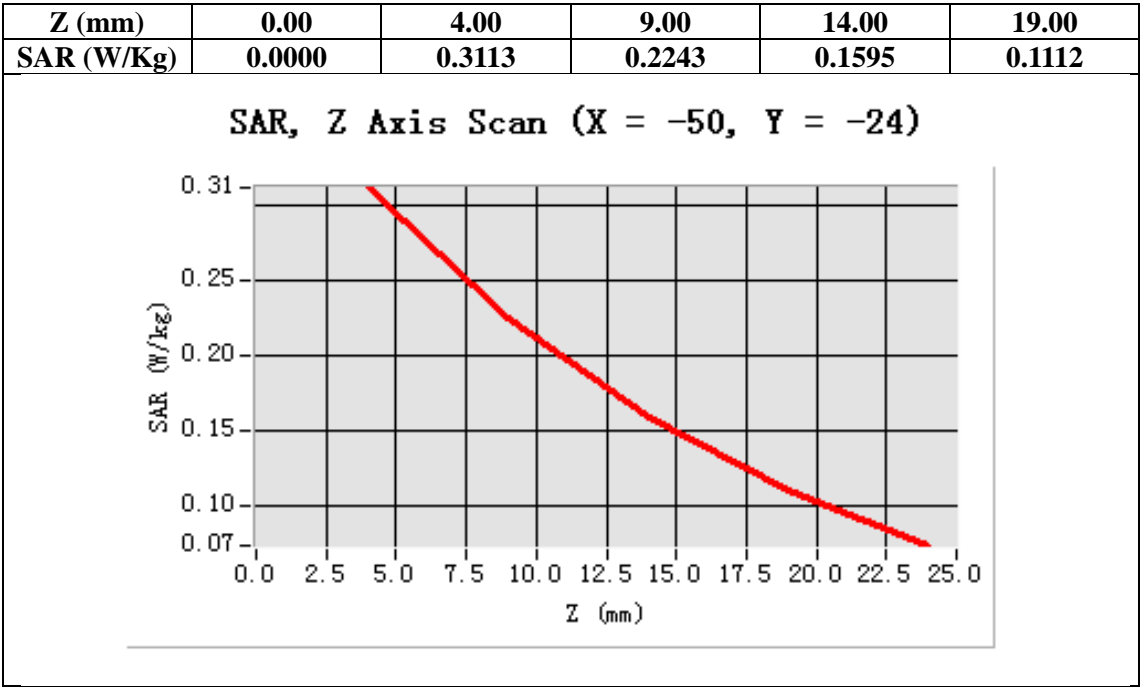

Test Laboratory: AGC Lab

Date: Nov.19,2012

GSM 850 Mid-tilt-Right <SIM 1>

DUT: mobile phone ; Type: AM316

Communication System: Generic GSM; Communication System Band: GSM 850; Duty Cycle: 1:8.3;
Conv.F=6.79;Frequency: 836.6 MHz; Medium parameters used: $f = 850$ MHz; $\sigma = 0.88$ mho/m; $\epsilon_r = 40.64$;
 $\rho = 1000$ kg/m³ ;

Phantom section: Right Section

Ambient temperature (°C): 21.0, Liquid temperature (°C): 21.0

Satimo Configuration:

Probe:SSE5; Calibrated: 12/09/2011

- Sensor-Surface: 4mm (Mechanical Surface Detection)
- Phantom: SAM1; Type: SAM
- Measurement SW: OpenSAR V4_02_01

Configuration/GSM850 Mid-Tilt-Right/Area Scan: Measurement grid: dx=20mm, dy=20mm

Configuration/GSM850 Mid-Tilt-Right/Zoom Scan: Measurement grid: dx=8mm, dy=8mm, dz=5mm;

Area Scan	sam_direct_droit2_surf8mm.txt
Zoom Scan	5x5x7,dx=8mm dy=8mm dz=5mm,Very fast
Phantom	Right head
Device Position	Tilt
Band	GSM850
Channels	Middle
Signal	TDMA (Crest factor: 8.0)

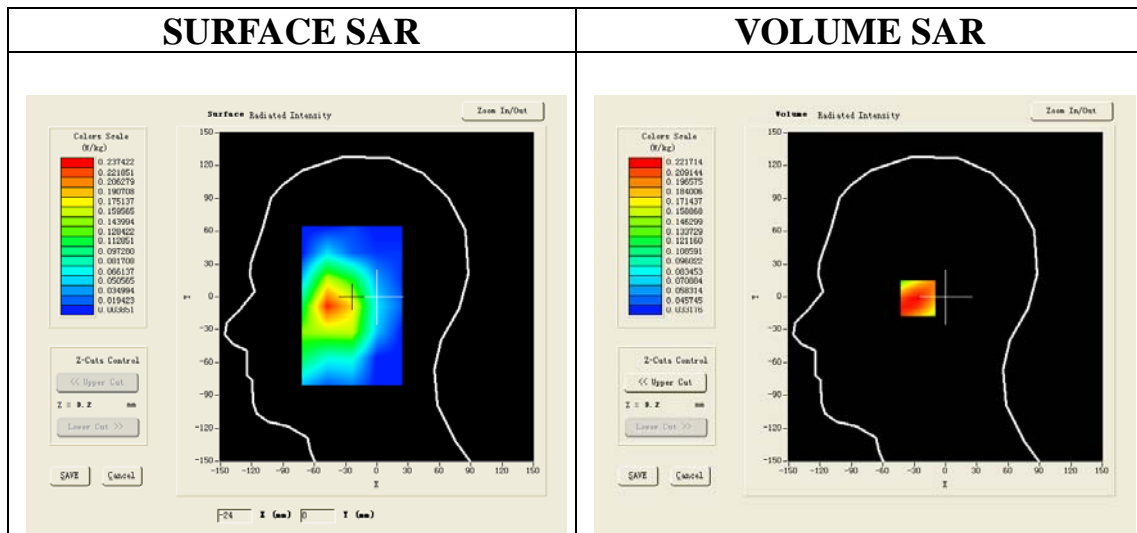

Maximum location: X=-24.00, Y=-1.00

SAR 10g (W/Kg)	0.148309
SAR 1g (W/Kg)	0.214344

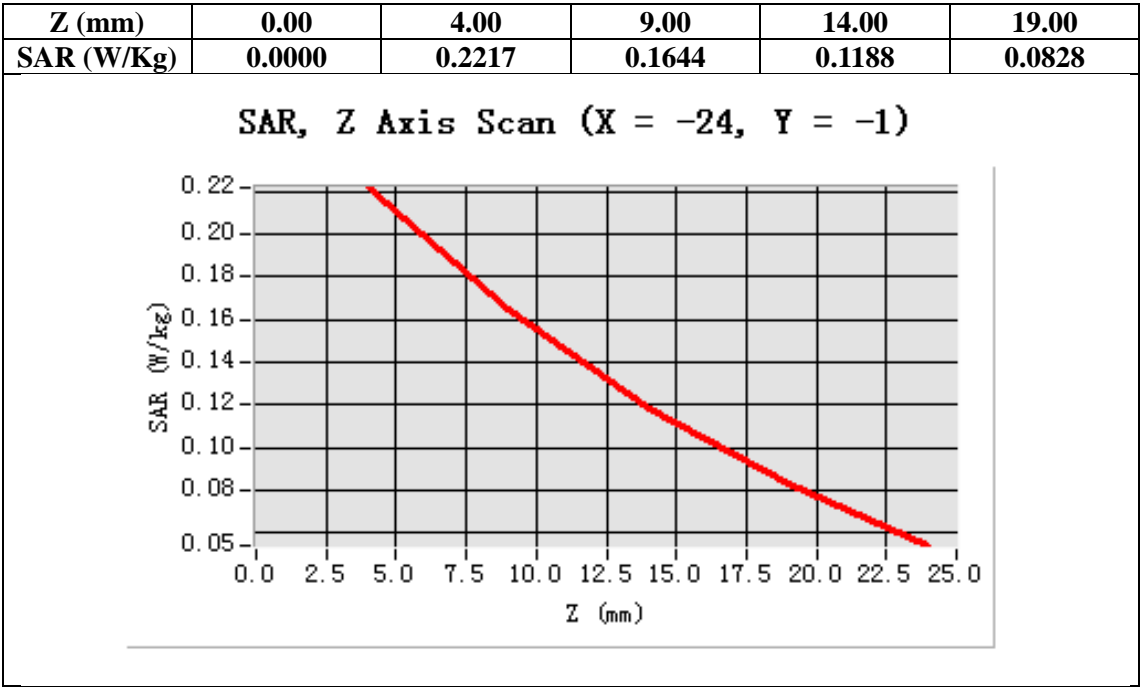

Test Laboratory: AGC Lab

Date: Nov.19,2012

GSM 850 Mid-touch-Left <SIM 2>

DUT: mobile phone ; Type: AM316

Communication System: Generic GSM; Communication System Band: GSM 850; Duty Cycle: 1:8.3; Conv.F=6.79
Frequency: 836.6 MHz; Medium parameters used: f = 850 MHz; $\sigma = 0.88$ mho/m; $\epsilon_r = 40.64$;

$\rho = 1000$ kg/m³ ;

Phantom section: Left Section

Ambient temperature (°C): 21.0, Liquid temperature (°C): 21.0

Satimo Configuration:

Probe:SSE5; Calibrated: 12/09/2011

- Sensor-Surface: 4mm (Mechanical Surface Detection)
- Phantom: SAM1; Type: SAM
- Measurement SW: OpenSAR V4_02_01

Configuration/GSM850 Mid-Touch-Left/Area Scan (6x8x1): Measurement grid: dx=20mm, dy=20mm

Configuration/GSM850 Mid-Touch-Left/Zoom Scan (5x5x7)/Cube 0: Measurement grid: dx=8mm, dy=8mm, dz=5mm

Area Scan	sam_direct_droit2_surf8mm.txt
ZoomScan	5x5x7,dx=8mm dy=8mm dz=5mm,Very fast
Phantom	Left head
Device Position	Cheek
Band	GSM850
Channels	Middle
Signal	TDMA (Crest factor: 8.0)

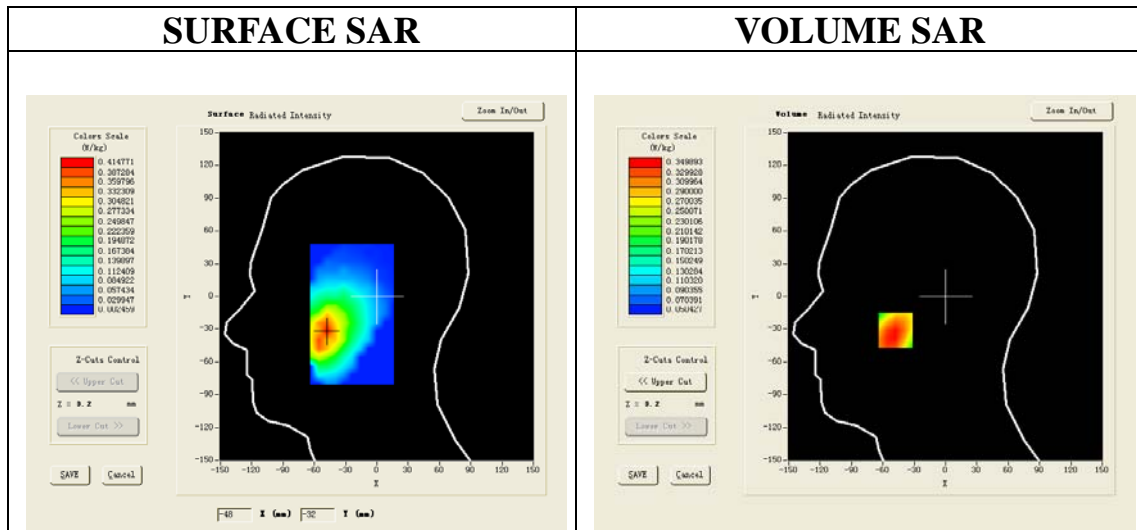

Maximum location: X=-48.00, Y=-31.00

SAR 10g (W/Kg)	0.233708
SAR 1g (W/Kg)	0.338805

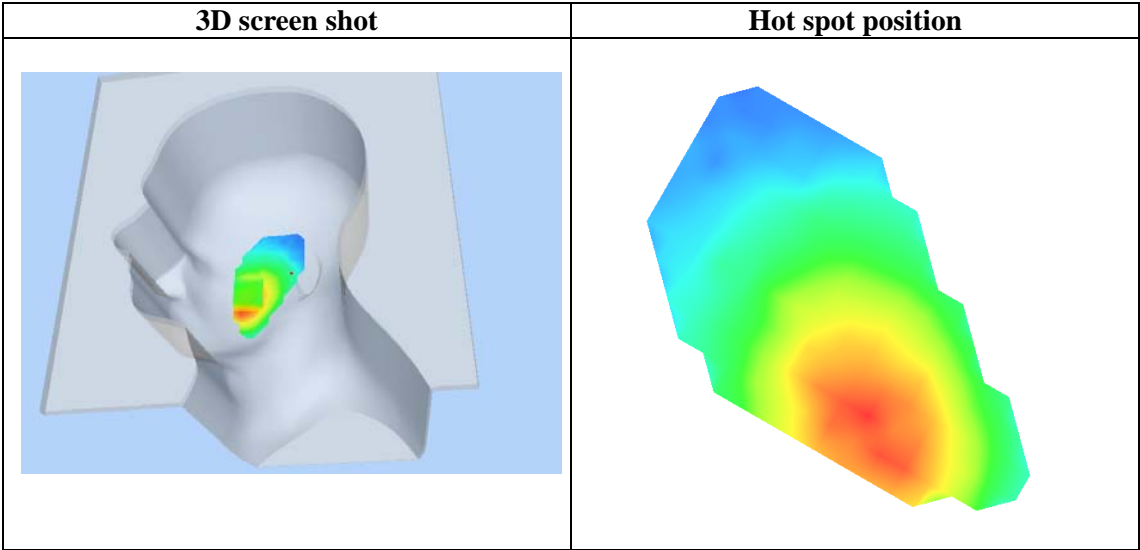
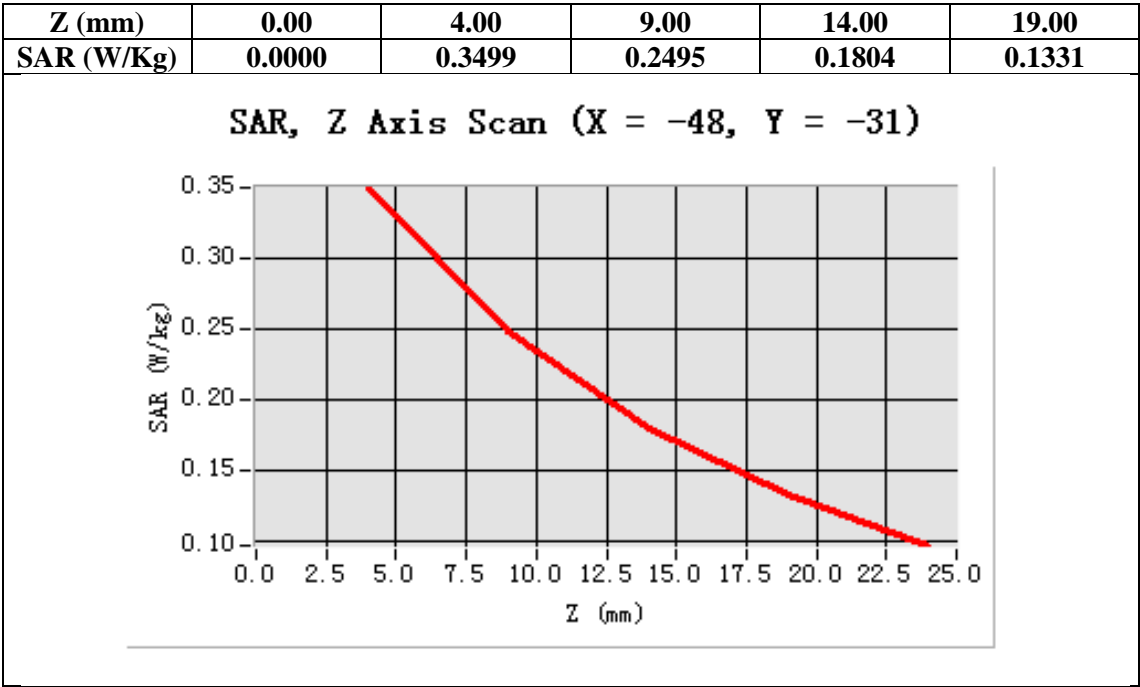

Test Laboratory: AGC Lab
GSM 850 Low- Body-Back <SIM 1>

Date: Nov.19,2012

DUT: mobile phone; Type: AM316

Communication System: Generic GSM; Communication System Band: GSM 850; Duty Cycle: 1:8.3;
Conv.F=6.79; Frequency: 824.2 MHz; Medium parameters used: $f = 850$ MHz; $\sigma = 0.97$ mho/m; $\epsilon_r = 54.19$;
 $\rho = 1000$ kg/m³ ;

Phantom section: Flat Section

Ambient temperature (°C): 21.0, Liquid temperature (°C): 21.0

Satimo Configuration:

Probe:SSE5; Calibrated: 12/09/2011

- Sensor-Surface: 4mm (Mechanical Surface Detection)
- Phantom: SAM1; Type: SAM
- Measurement SW: OpenSAR V4_02_01

Configuration/GSM850 Low-Body-Back/Area Scan (6x8x1): Measurement grid: dx=20mm, dy=20mm

Configuration/GSM850 Low-Body-Back/Zoom Scan (5x5x7)/Cube 0: Measurement grid: dx=8mm, dy=8mm, dz=5mm;

Area Scan	surf_sam_plan.txt
ZoomScan	5x5x7,dx=8mm dy=8mm dz=5mm,Very fast
Phantom	Validation plane
Device Position	Body
Band	GSM850
Channels	Low
Signal	TDMA (Crest factor: 8.0)

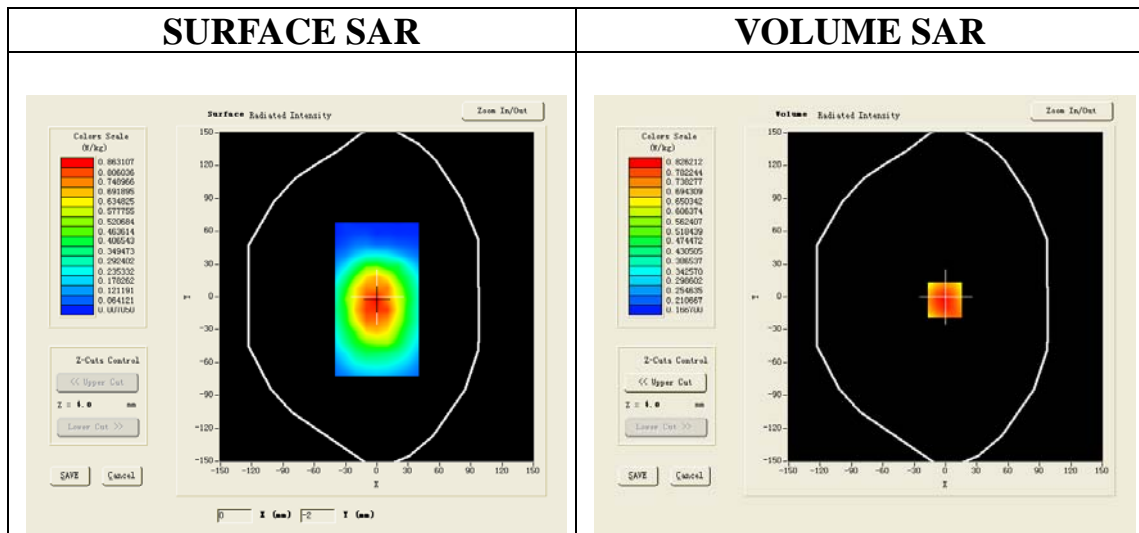

Maximum location: X=-1.00, Y=-3.00

SAR 10g (W/Kg)	0.601654
SAR 1g (W/Kg)	0.856322

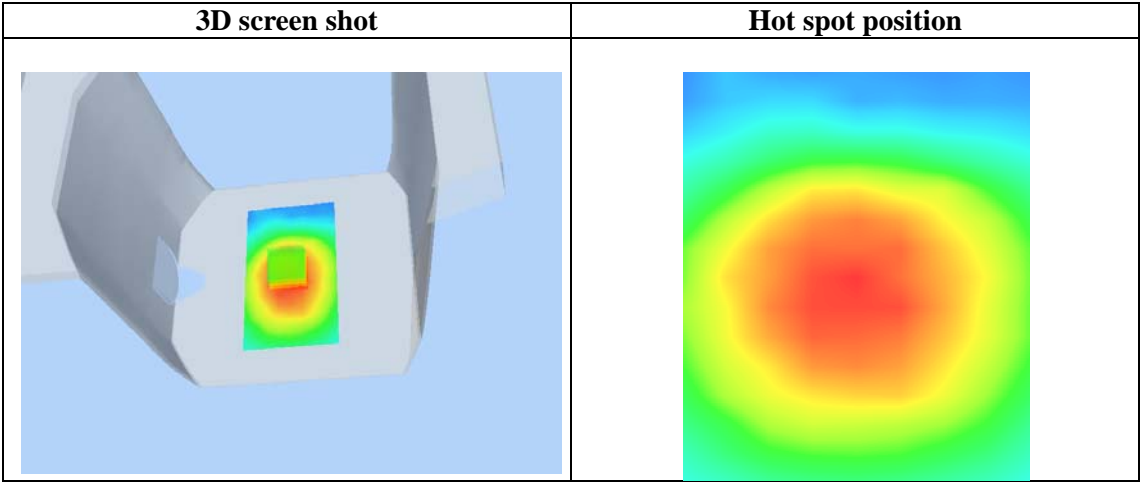
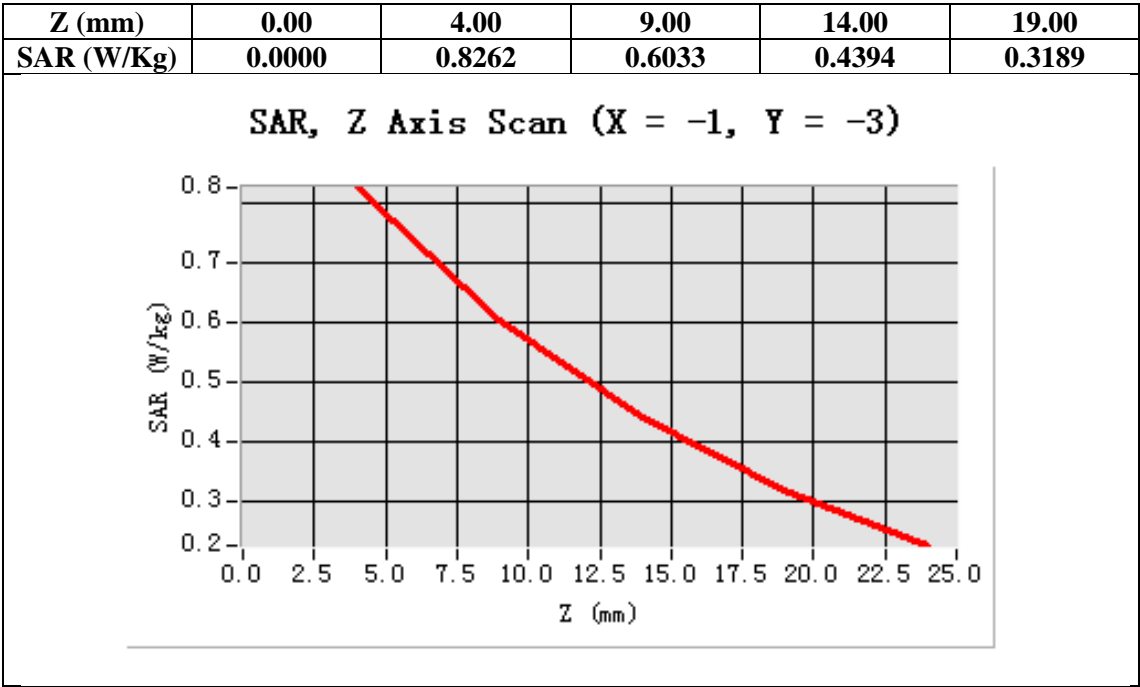

Test Laboratory: AGC Lab
GSM 850 Mid- Body-Back <SIM 1>

Date: Nov.19,2012

DUT: mobile phone; Type: AM316

Communication System: Generic GSM; Communication System Band: GSM 850; Duty Cycle: 1:8.3;
Conv.F=6.79; Frequency: 836.6 MHz; Medium parameters used: $f = 850$ MHz; $\sigma = 0.97$ mho/m; $\epsilon_r = 54.19$;
 $\rho = 1000$ kg/m³ ;

Phantom section: Flat Section

Ambient temperature (°C): 21.0, Liquid temperature (°C): 21.0

Satimo Configuration:

Probe:SSE5; Calibrated: 12/09/2011

- Sensor-Surface: 4mm (Mechanical Surface Detection)
- Phantom: SAM1; Type: SAM
- Measurement SW: OpenSAR V4_02_01

Configuration/GSM850 Mid-Body-Back/Area Scan (6x8x1): Measurement grid: dx=20mm, dy=20mm

Configuration/GSM850 Mid-Body-Back/Zoom Scan (5x5x7)/Cube 0: Measurement grid: dx=8mm, dy=8mm, dz=5mm;

Area Scan	surf_sam_plan.txt
ZoomScan	5x5x7,dx=8mm dy=8mm dz=5mm,Very fast
Phantom	Validation plane
Device Position	Body
Band	GSM850
Channels	Middle
Signal	TDMA (Crest factor: 8.0)

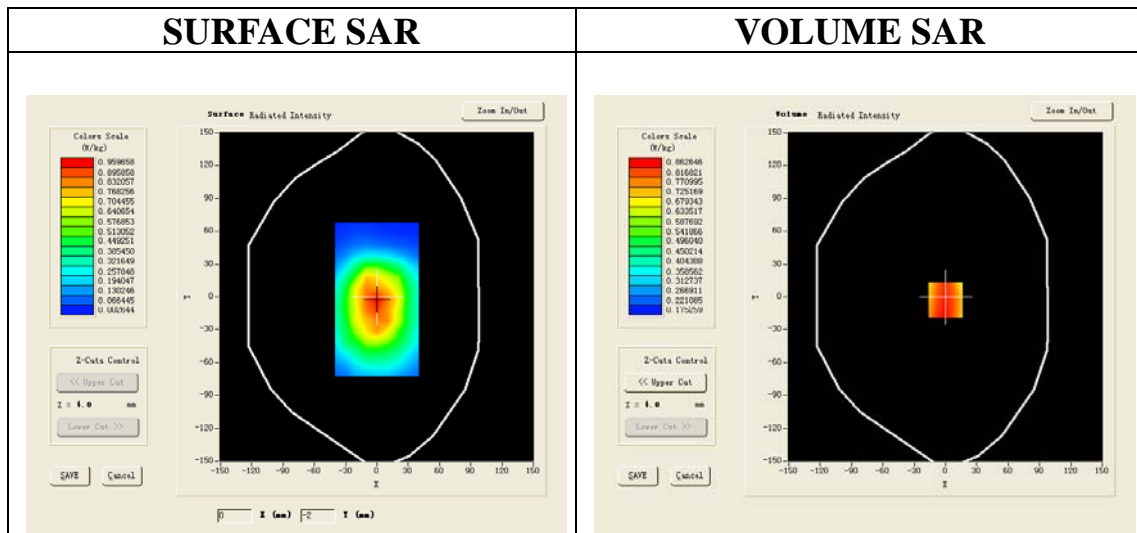

Maximum location: X=0.00, Y=-3.00

SAR 10g (W/Kg)	0.625783
SAR 1g (W/Kg)	0.892935

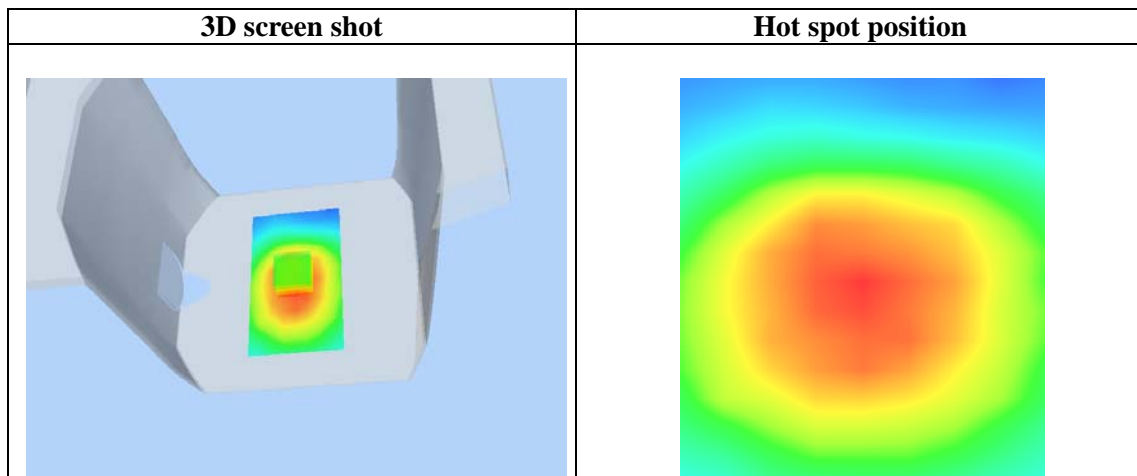
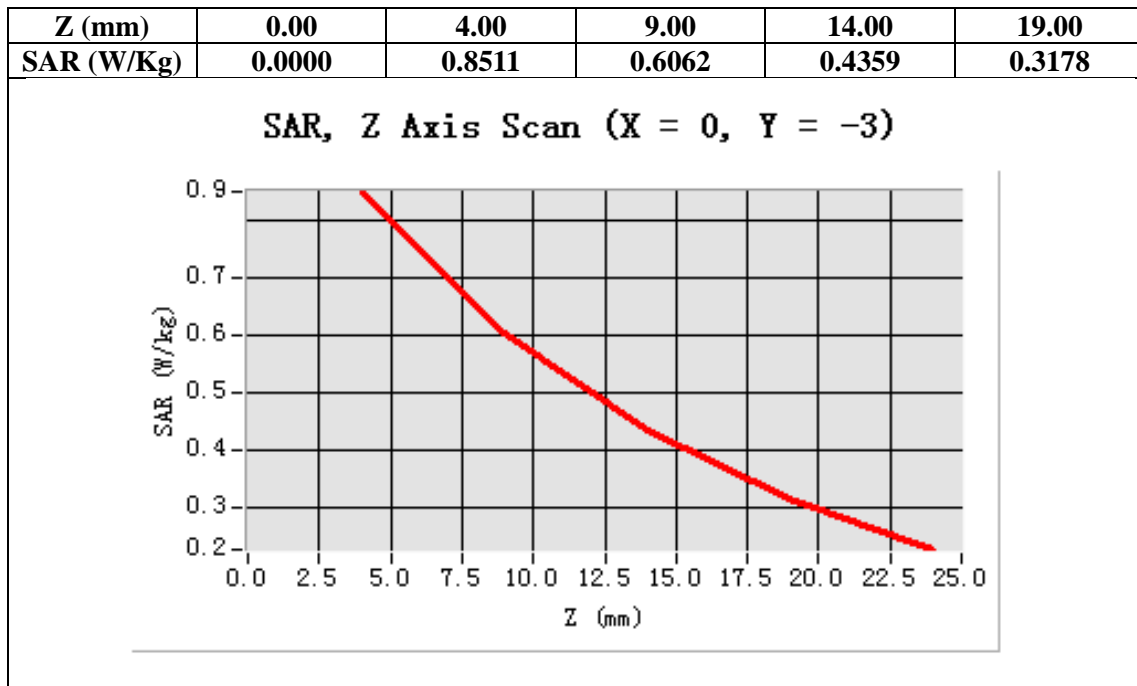

Test Laboratory: AGC Lab
GSM 850 High- Body-Back <SIM 1>

Date: Nov.19,2012

DUT: mobile phone; Type: AM316

Communication System: Generic GSM; Communication System Band: GSM 850; Duty Cycle: 1:8.3;
Conv.F=6.79; Frequency: 848.8 MHz; Medium parameters used: $f = 850$ MHz; $\sigma = 0.97$ mho/m; $\epsilon_r = 54.19$;
 $\rho = 1000$ kg/m³ ;

Phantom section: Flat Section

Ambient temperature (°C): 21.0, Liquid temperature (°C): 21.0

Satimo Configuration:

Probe:SSE5; Calibrated: 12/09/2011

- Sensor-Surface: 4mm (Mechanical Surface Detection)
- Phantom: SAM1; Type: SAM
- Measurement SW: OpenSAR V4_02_01

Configuration/GSM850 High-Body-Back/Area Scan (6x8x1): Measurement grid: dx=20mm, dy=20mm

Configuration/GSM850 High-Body-Back/Zoom Scan (5x5x7)/Cube 0: Measurement grid: dx=8mm, dy=8mm, dz=5mm;

Area Scan	surf_sam_plan.txt
ZoomScan	5x5x7,dx=8mm dy=8mm dz=5mm,Very fast
Phantom	Validation plane
Device Position	Body
Band	GSM850
Channels	High
Signal	TDMA (Crest factor: 8.0)

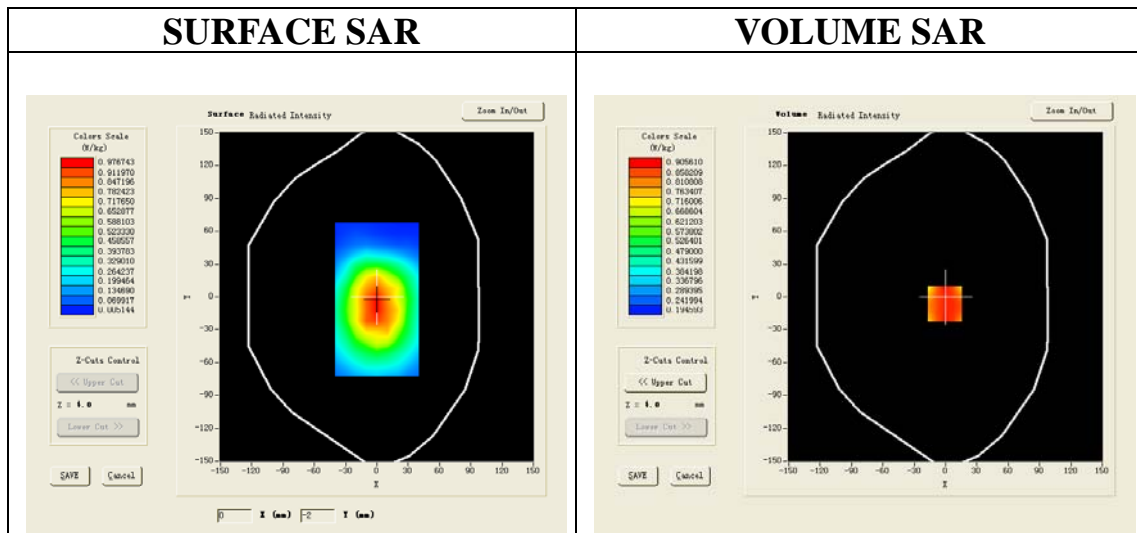

Maximum location: X=-1.00, Y=-6.00

SAR 10g (W/Kg)	0.676838
SAR 1g (W/Kg)	0.936516

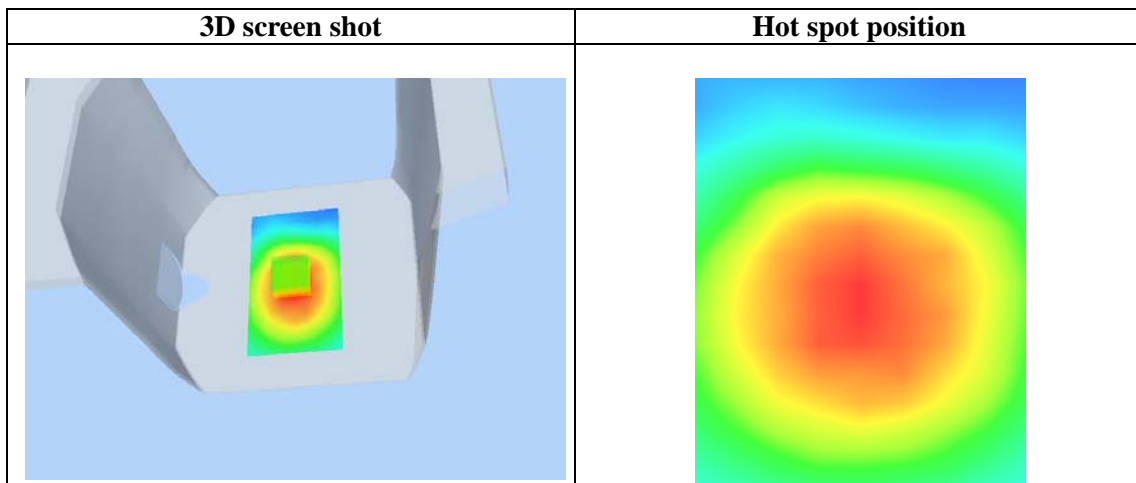
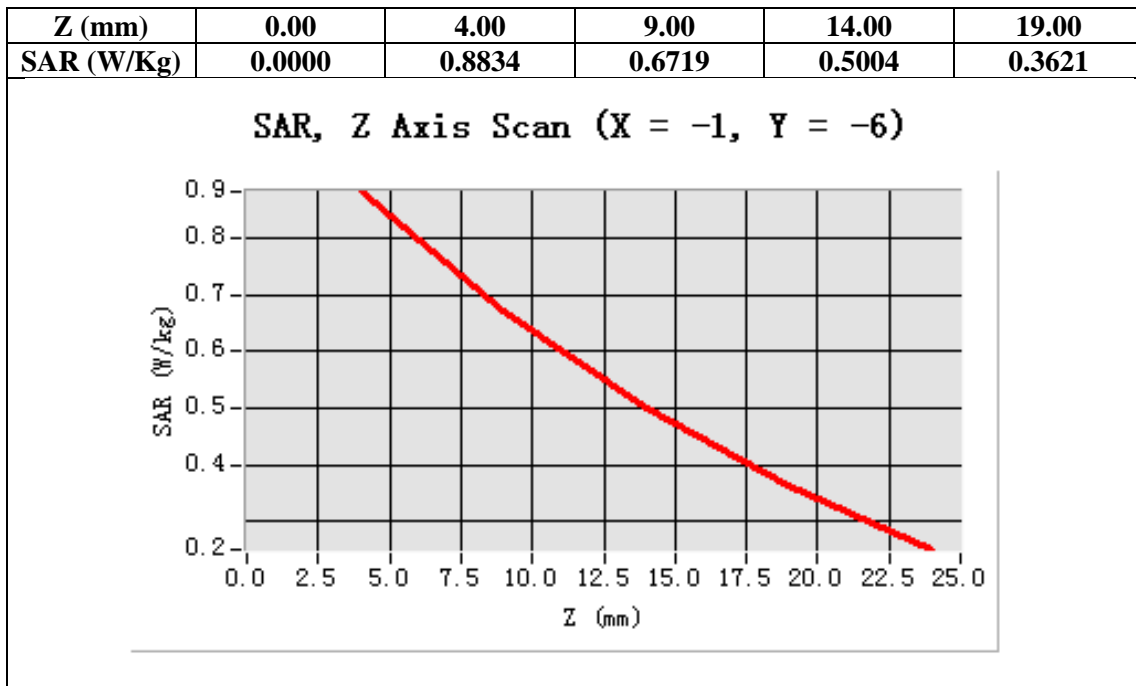

Test Laboratory: AGC Lab
GSM 850 Low- body- Back (2up) <SIM 1>
DUT: mobile phone; Type: AM316

Date: Nov.19,2012

Communication System: GPRS -2 Slot; Communication System Band: GSM850; Duty Cycle: 1:4.2 ;
Conv.F=6.79;Frequency: 824.2 MHz; Medium parameters used: f = 850 MHz; $\sigma = 0.97$ mho/m; $\epsilon_r = 54.19$;
 $\rho = 1000\text{kg/m}^3$;
Phantom section: Flat Section
Ambient temperature ($^{\circ}\text{C}$): 21.0, Liquid temperature ($^{\circ}\text{C}$): 21.0

Satimo Configuration:

Probe:SSE5; Calibrated: 12/09/2011

- Sensor-Surface: 4mm (Mechanical Surface Detection)
- Phantom: SAM1; Type: SAM
- Measurement SW: OpenSAR V4_02_01

Configuration/GPRS850 Low-Body-Back/Area Scan (6x8x1): Measurement grid: dx=20mm, dy=20mm
Configuration/GPRS850 Low-Body-Back/Zoom Scan (5x5x7)/Cube 0: Measurement grid: dx=8mm, dy=8mm, dz=5mm;

Area Scan	surf_sam_plan.txt
ZoomScan	5x5x7,dx=8mm dy=8mm dz=5mm,Very fast
Phantom	Validation plane
Device Position	Body
Band	GSM850
Channels	Low
Signal	TDMA (Crest factor: 4.0)

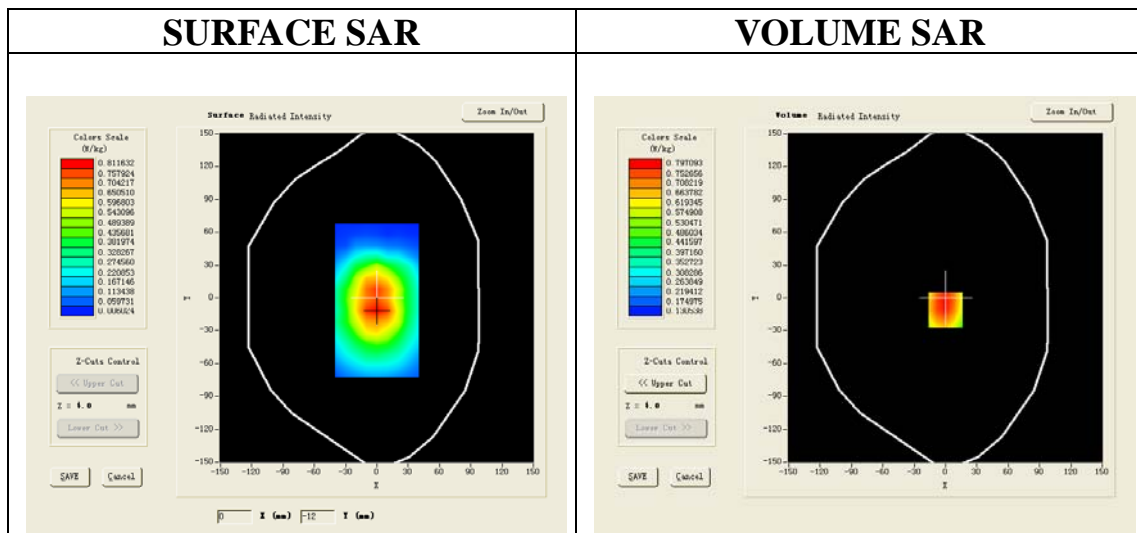

Maximum location: X=0.00, Y=-11.00

SAR 10g (W/Kg)	0.574752
SAR 1g (W/Kg)	0.826638

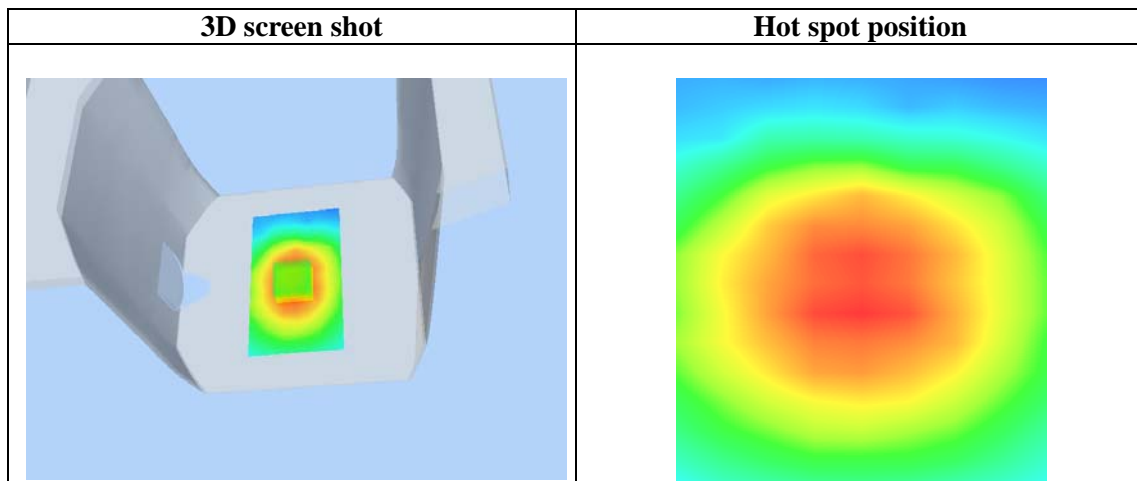
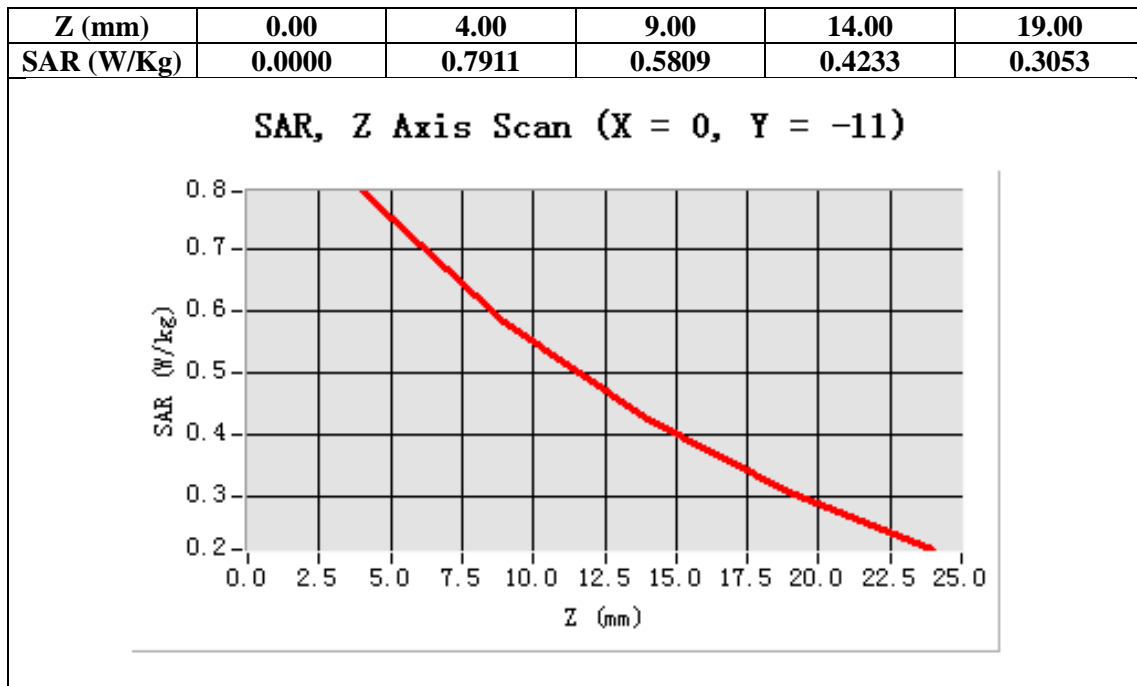

Test Laboratory: AGC Lab
GSM 850 Mid- body- Back (2up) <SIM 1>
DUT: mobile phone; Type: AM316

Date: Nov.19,2012

Communication System: GPRS -2 Slot; Communication System Band: GSM850; Duty Cycle: 1:4.2 ;
Conv.F=6.79;Frequency: 836.6 MHz; Medium parameters used: f = 850 MHz; $\sigma = 0.97$ mho/m; $\epsilon_r = 54.19$;
 $\rho = 1000\text{kg/m}^3$;
Phantom section: Flat Section
Ambient temperature ($^{\circ}\text{C}$): 21.0, Liquid temperature ($^{\circ}\text{C}$): 21.0

Satimo Configuration:

Probe:SSE5; Calibrated: 12/09/2011

- Sensor-Surface: 4mm (Mechanical Surface Detection)
- Phantom: SAM1; Type: SAM
- Measurement SW: OpenSAR V4_02_01

Configuration/GPRS850 Mid-Body-Back/Area Scan (6x8x1): Measurement grid: dx=20mm, dy=20mm
Configuration/GPRS850 Mid-Body-Back/Zoom Scan (5x5x7)/Cube 0: Measurement grid: dx=8mm, dy=8mm, dz=5mm;

Area Scan	surf_sam_plan.txt
ZoomScan	5x5x7,dx=8mm dy=8mm dz=5mm,Very fast
Phantom	Validation plane
Device Position	Body
Band	GSM850
Channels	Middle
Signal	TDMA (Crest factor: 4.0)

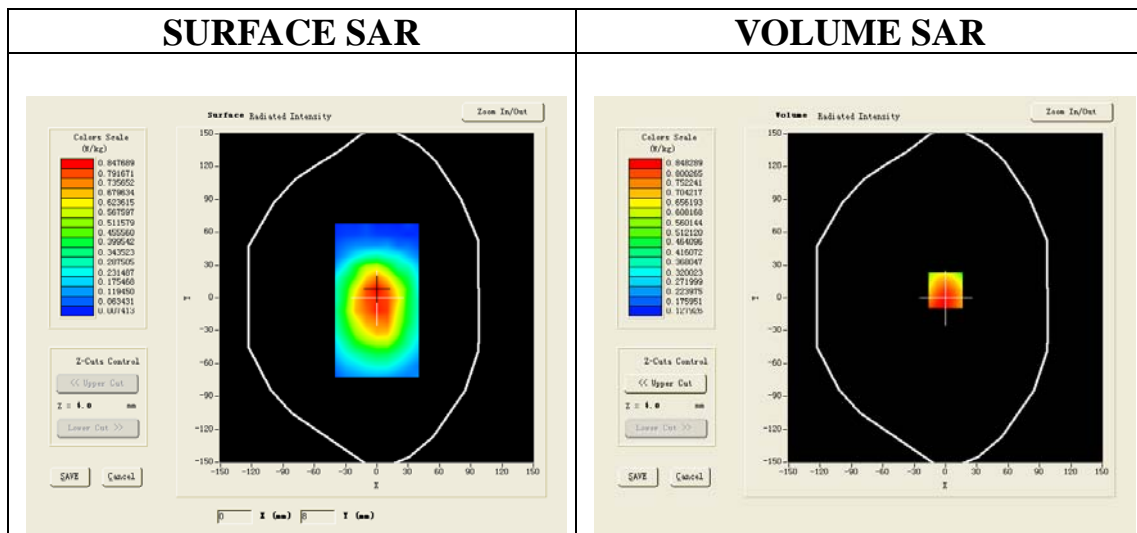

Maximum location: X=0.00, Y=7.00

SAR 10g (W/Kg)	0.602300
SAR 1g (W/Kg)	0.881591

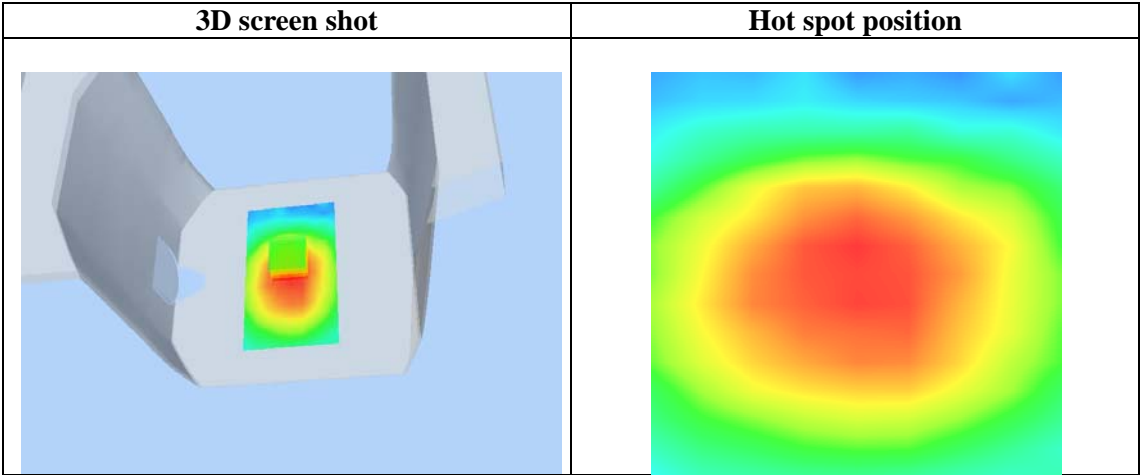
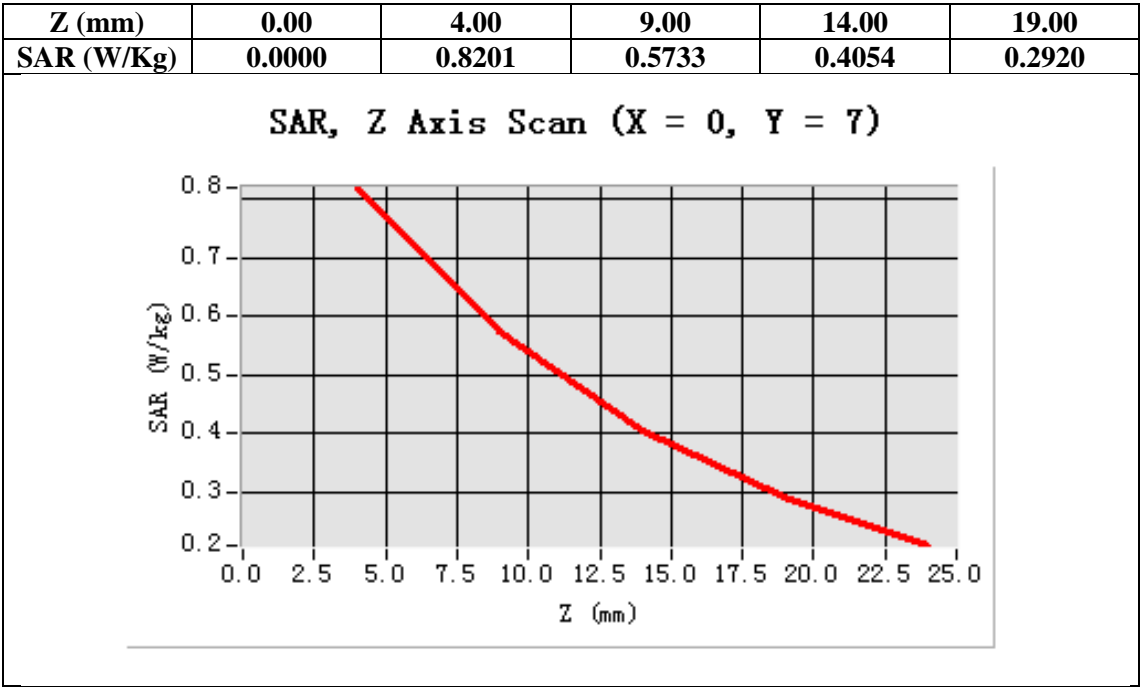

Test Laboratory: AGC Lab
GSM 850 High- body- Back (2up) <SIM 1>
DUT: mobile phone; Type: AM316

Date: Nov.19,2012

Communication System: GPRS -2 Slot; Communication System Band: GSM850; Duty Cycle: 1:4.2 ;
Conv.F=6.79;Frequency: 848.8 MHz; Medium parameters used: f = 850 MHz; $\sigma = 0.97$ mho/m; $\epsilon_r = 54.19$;
 $\rho = 1000\text{kg/m}^3$;
Phantom section: Flat Section
Ambient temperature ($^{\circ}\text{C}$): 21.0, Liquid temperature ($^{\circ}\text{C}$): 21.0

Satimo Configuration:

Probe:SSE5; Calibrated: 12/09/2011

- Sensor-Surface: 4mm (Mechanical Surface Detection)
- Phantom: SAM1; Type: SAM
- Measurement SW: OpenSAR V4_02_01

Configuration/GPRS850 High-Body-Back/Area Scan (6x8x1): Measurement grid: dx=20mm, dy=20mm
Configuration/GPRS850 High-Body-Back/Zoom Scan (5x5x7)/Cube 0: Measurement grid: dx=8mm, dy=8mm, dz=5mm;

Area Scan	surf_sam_plan.txt
ZoomScan	5x5x7,dx=8mm dy=8mm dz=5mm,Very fast
Phantom	Validation plane
Device Position	Body
Band	GSM850
Channels	High
Signal	TDMA (Crest factor: 4.0)

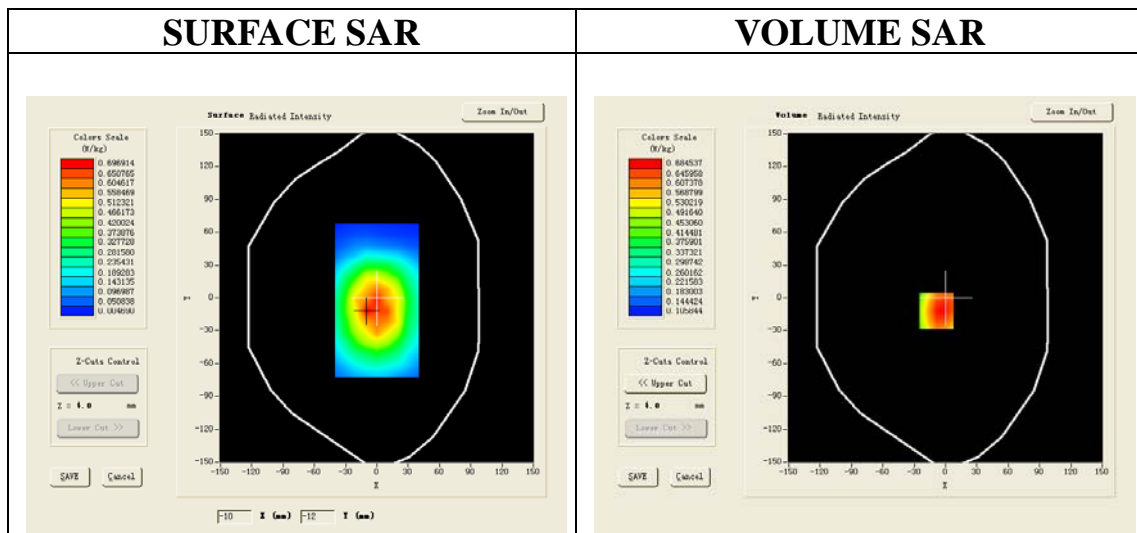

Maximum location: X=-9.00, Y=-12.00

SAR 10g (W/Kg)	0.483725
SAR 1g (W/Kg)	0.715300

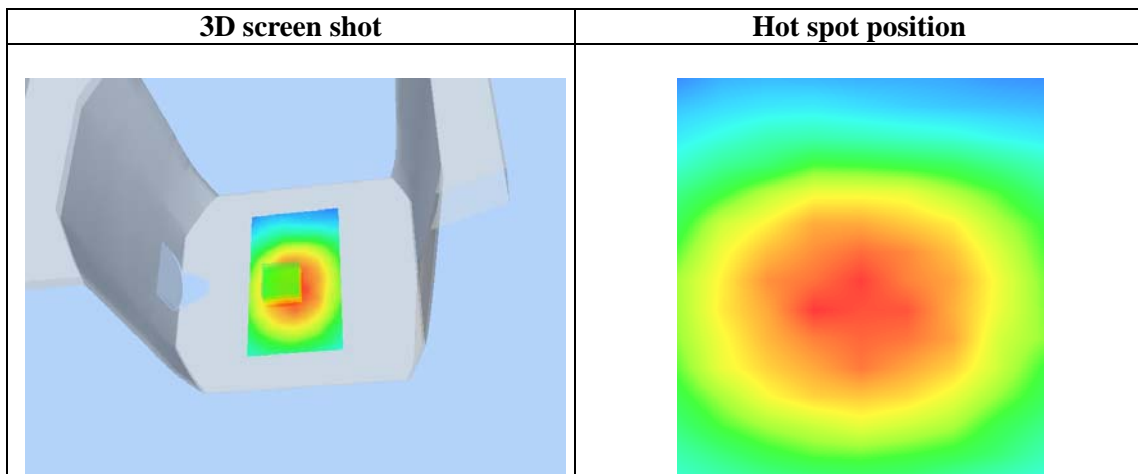
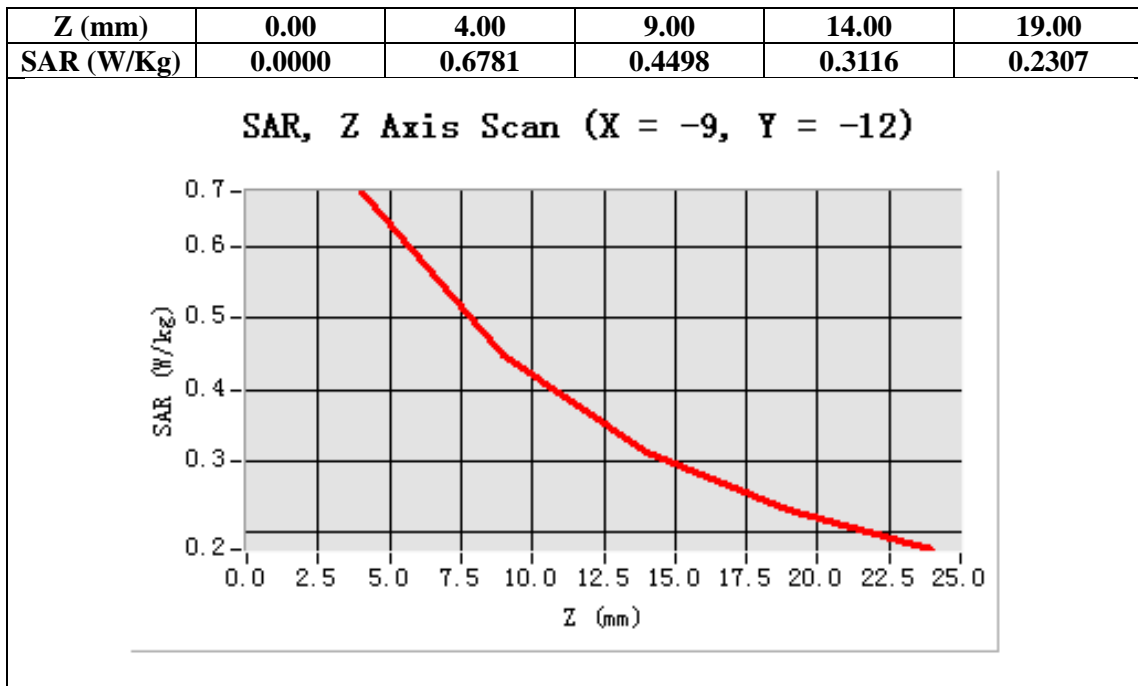

Test Laboratory: AGC Lab
GPRS 850 Mid-Body-back (3up) <SIM 1>
DUT: mobile phone; Type: AM316

Date: Nov.19,2012

Communication System: GPRS -3 Slot; Communication System Band: GSM 850; Duty Cycle: 1:2.8 ;
Conv.F=6.79;Frequency: 836.6 MHz; Medium parameters used: f = 850 MHz; $\sigma = 0.97$ mho/m; $\epsilon_r = 54.19$;
 $\rho = 1000\text{kg/m}^3$;
Phantom section: Flat Section
Ambient temperature (°C): 21.0, Liquid temperature (°C): 21.0

Satimo Configuration:

- Probe:SSE5; Calibrated: 12/09/2011
- Sensor-Surface: 4mm (Mechanical Surface Detection)
- Phantom: SAM1; Type: SAM
- Measurement SW: OpenSAR V4_02_01

Configuration/GPRS850 Mid-Body-Back/Area Scan (6x8x1): Measurement grid: dx=20mm, dy=20mm
Configuration/GPRS850 Mid-Body-Back/Zoom Scan (5x5x7)/Cube 0: Measurement grid: dx=8mm, dy=8mm, dz=5mm;

Area Scan	surf_sam_plan.txt
ZoomScan	5x5x7,dx=8mm dy=8mm dz=5mm,Very fast
Phantom	Validation plane
Device Position	Body
Band	GSM850
Channels	Middle
Signal	TDMA (Crest factor:2.7)

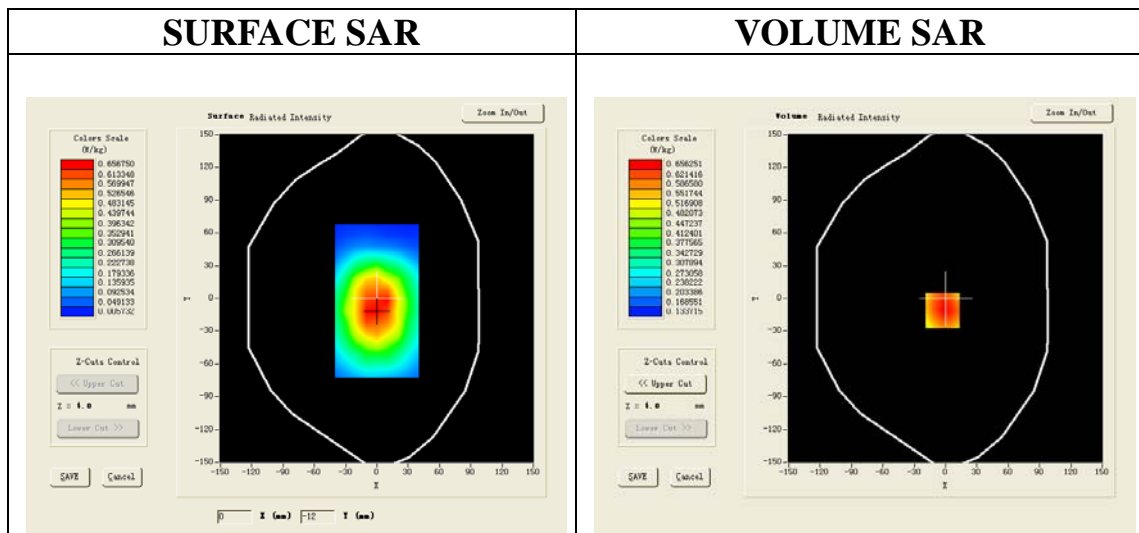

Maximum location: X=-3.00, Y=-11.00

SAR 10g (W/Kg)	0.490708
SAR 1g (W/Kg)	0.682951

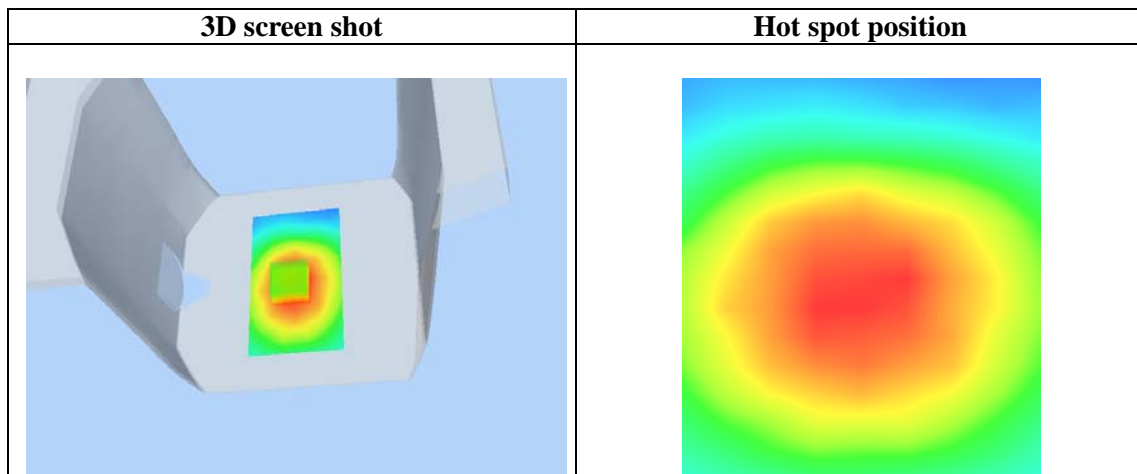
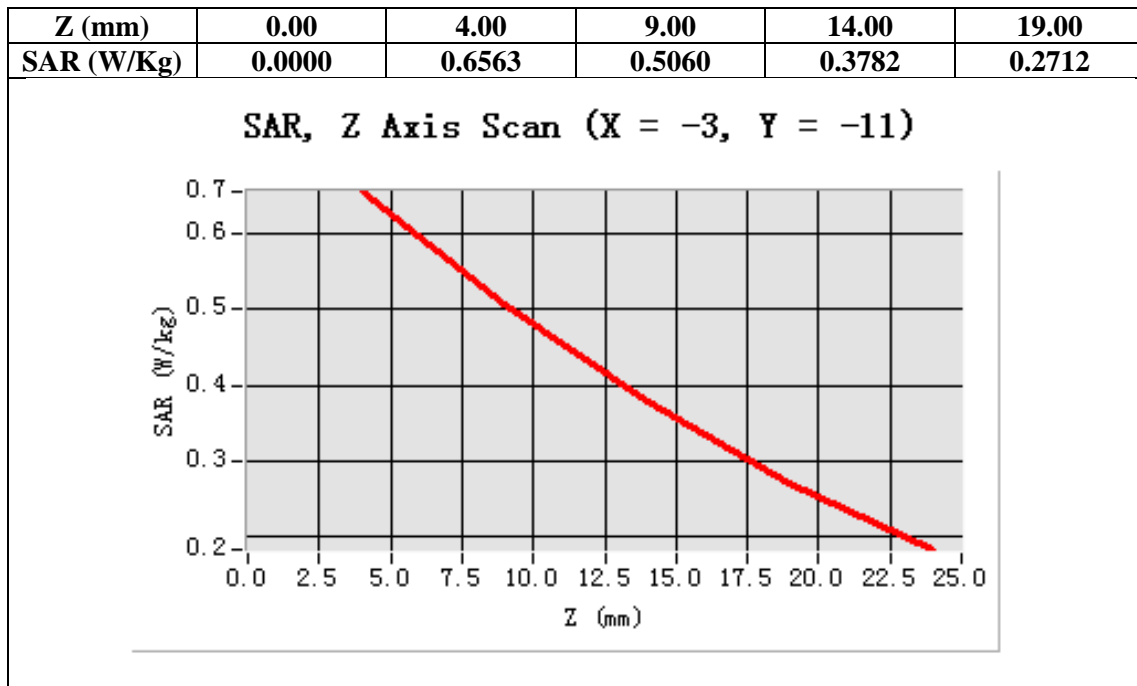

Test Laboratory: AGC Lab
GPRS 850 Mid-body-Back (4up) <SIM 1>

Date: Nov.19,2012

DUT: mobile phone; Type: AM316

Communication System: GPRS -4 Slot; Communication System Band: GSM 850; Duty Cycle: 1:2.1 ;
Conv.F=6.79;Frequency: 836.6 MHz; Medium parameters used: f = 850 MHz; $\sigma = 0.97$ mho/m; $\epsilon_r = 54.19$;
 $\rho = 1000\text{kg/m}^3$;
Phantom section: Flat Section
Ambient temperature ($^{\circ}\text{C}$): 21.0, Liquid temperature ($^{\circ}\text{C}$): 21.0

Satimo Configuration:

Probe:SSE5; Calibrated: 12/09/2011

- Sensor-Surface: 4mm (Mechanical Surface Detection)
- Phantom: SAM1; Type: SAM
- Measurement SW: OpenSAR V4_02_01

Configuration/GPRS850 Mid-Body-Back/Area Scan: Measurement grid: dx=20mm, dy=20mm

Configuration/GPRS850 Mid-Body-Back/Zoom Scan: Measurement grid: dx=8mm, dy=8mm, dz=5mm;

Area Scan	surf_sam_plan.txt
ZoomScan	5x5x7,dx=8mm dy=8mm dz=5mm,Very fast
Phantom	Validation plane
Device Position	Body
Band	GSM850
Channels	Middle
Signal	TDMA (Crest factor: 2.0)

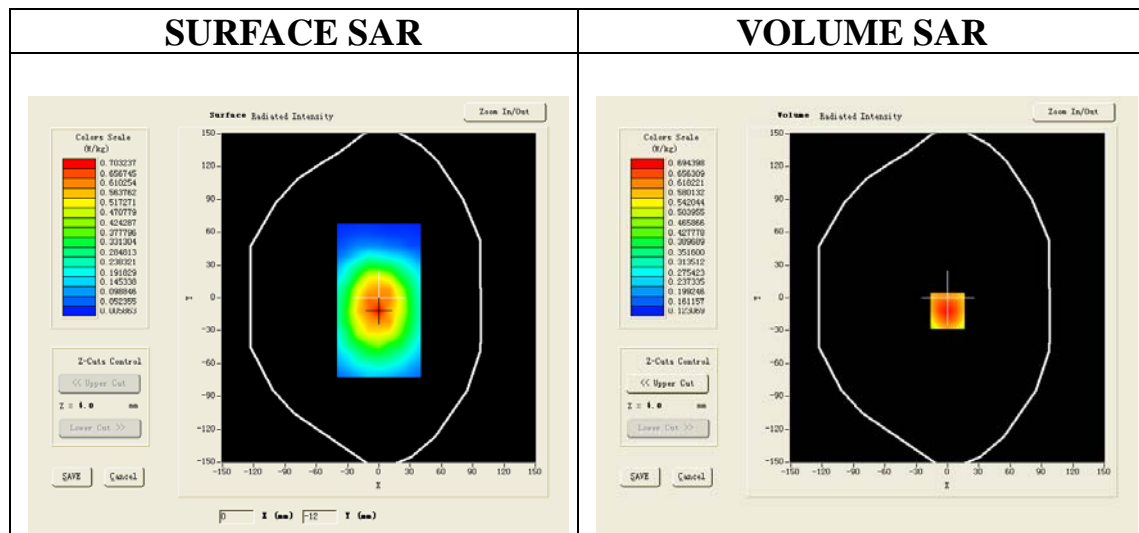

Maximum location: X=0.00, Y=-12.00

SAR 10g (W/Kg)	0.479038
SAR 1g (W/Kg)	0.717098

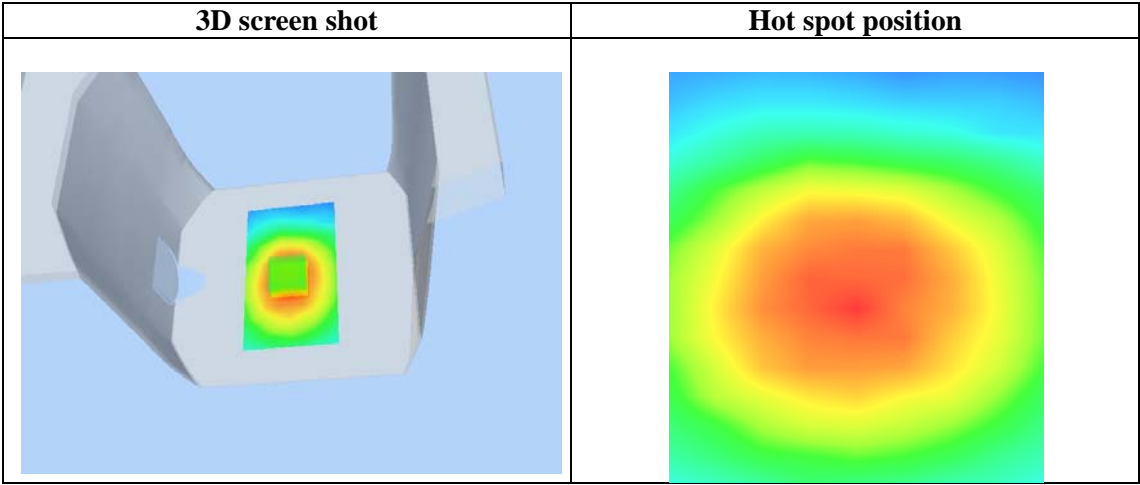
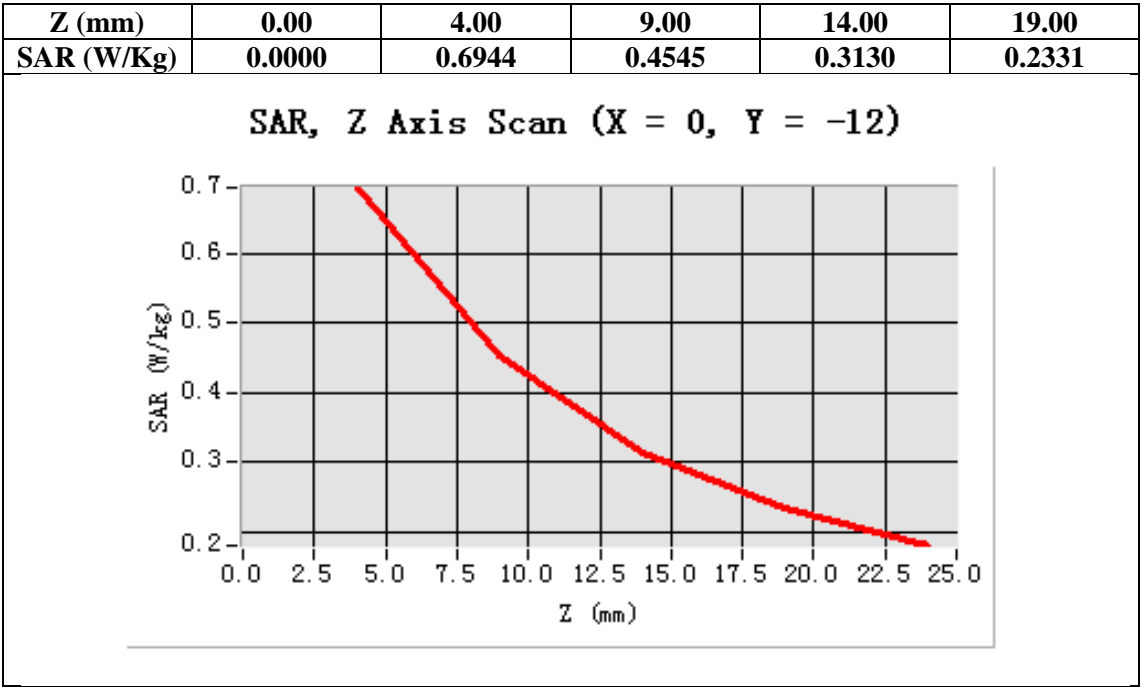

Test Laboratory: AGC Lab
GSM 850 Mid- Body- Front (MS) <SIM 1>

Date: Nov.19,2012

DUT: mobile phone; Type: AM316

Communication System: Generic GSM; Communication System Band: GSM 850; Duty Cycle: 1:8.3;
Conv.F=6.79; Frequency: 836.6 MHz; Medium parameters used: $f = 850$ MHz; $\sigma = 0.97$ mho/m; $\epsilon_r = 54.19$;
 $\rho = 1000$ kg/m³ ;

Phantom section: Flat Section

Ambient temperature (°C): 21.0, Liquid temperature (°C): 21.0

Satimo Configuration:

Probe:SSE5; Calibrated: 12/09/2011

- Sensor-Surface: 4mm (Mechanical Surface Detection)
- Phantom: SAM1; Type: SAM
- Measurement SW: OpenSAR V4_02_01

Configuration/GSM850 Mid-Body- Front /Area Scan (6x8x1): Measurement grid: dx=20mm, dy=20mm

Configuration/GSM850 Mid-Body- Front Zoom Scan (5x5x7)/Cube 0: Measurement grid: dx=8mm, dy=8mm, dz=5mm;

Area Scan	surf_sam_plan.txt
ZoomScan	5x5x7,dx=8mm dy=8mm dz=5mm,Very fast
Phantom	Validation plane
Device Position	Body
Band	GSM850
Channels	Middle
Signal	TDMA (Crest factor: 8.0)

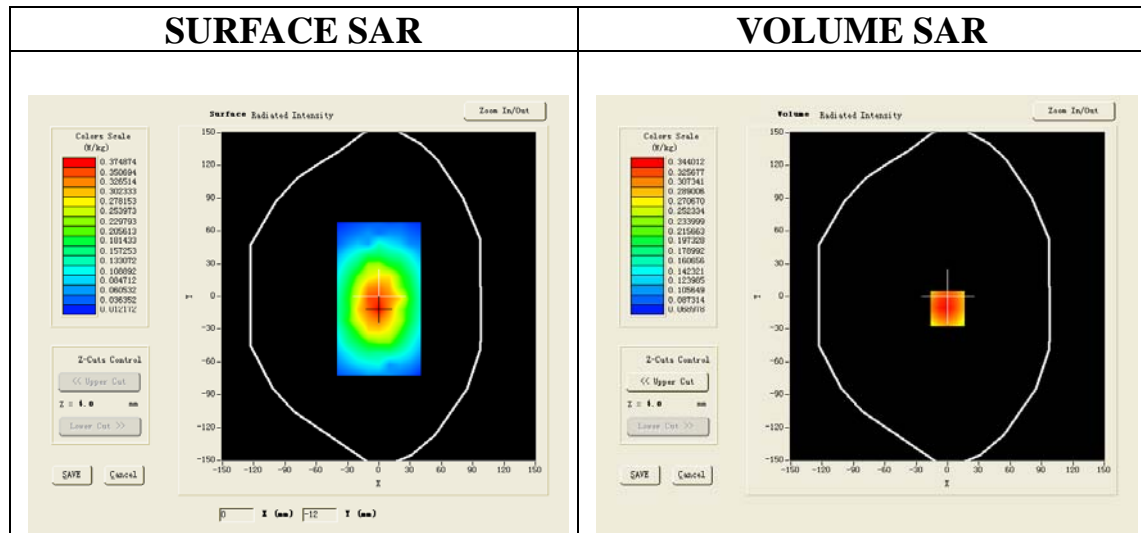

Maximum location: X=0.00, Y=-11.00

SAR 10g (W/Kg)	0.252775
SAR 1g (W/Kg)	0.357526

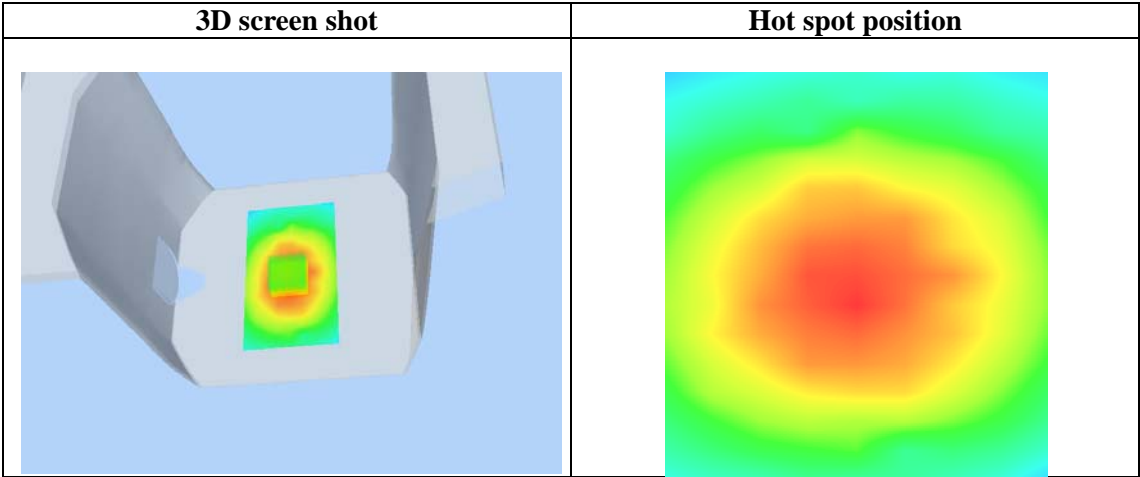
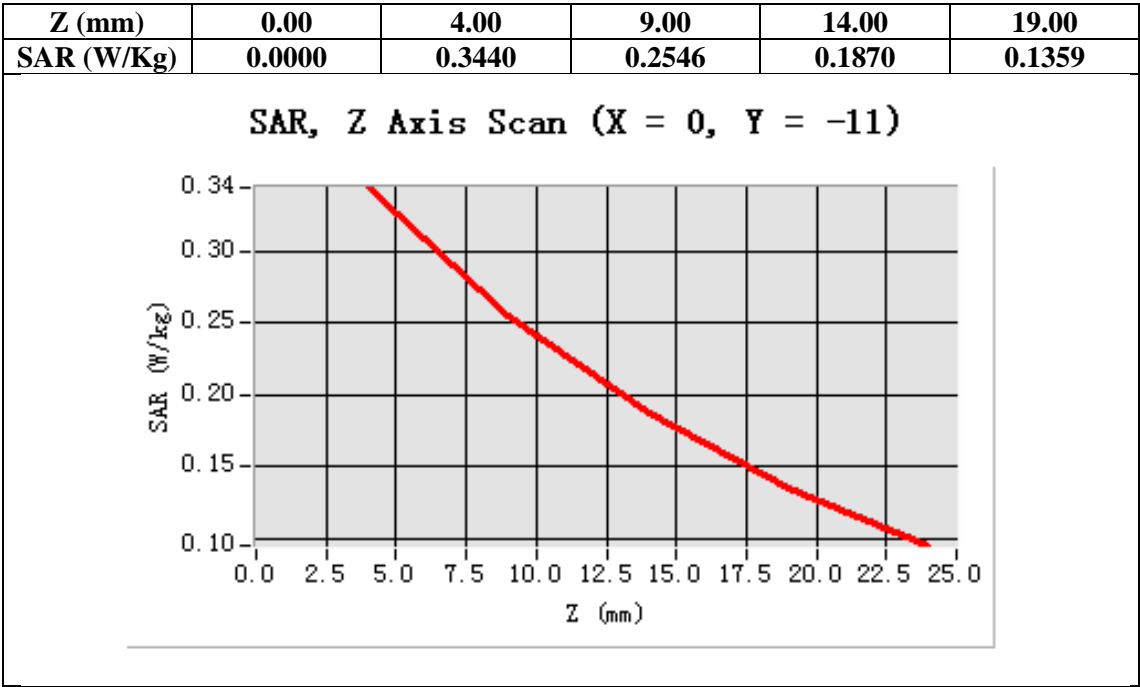

Test Laboratory: AGC Lab

Date: Nov.19,2012

GSM 850 High- Body- Back (MS with earphone) <SIM 1>

DUT: mobile phone; Type: AM316

Communication System: Generic GSM; Communication System Band: GSM 850; Duty Cycle: 1:8.3;
Conv.F=6.79;Frequency: 848.8 MHz; Medium parameters used: $f = 850$ MHz; $\sigma = 0.97$ mho/m; $\epsilon_r = 54.19$;
 $\rho = 1000$ kg/m³ ;

Phantom section: Flat Section

Ambient temperature (°C): 21.0, Liquid temperature (°C): 21.0

Satimo Configuration:

Probe:SSE5; Calibrated: 12/09/2011

- Sensor-Surface: 4mm (Mechanical Surface Detection)
- Phantom: SAM1; Type: SAM
- Measurement SW: OpenSAR V4_02_01

Configuration/GSM850 High-Body-Back/Area Scan (6x8x1): Measurement grid: dx=20mm, dy=20mm

Configuration/GSM850 High-Body-Back/Zoom Scan (5x5x7)/Cube 0: Measurement grid: dx=8mm, dy=8mm, dz=5mm;

Area Scan	surf_sam_plan.txt
ZoomScan	5x5x7,dx=8mm dy=8mm dz=5mm,Very fast
Phantom	Validation plane
Device Position	Body
Band	GSM850
Channels	High
Signal	TDMA (Crest factor: 8.0)

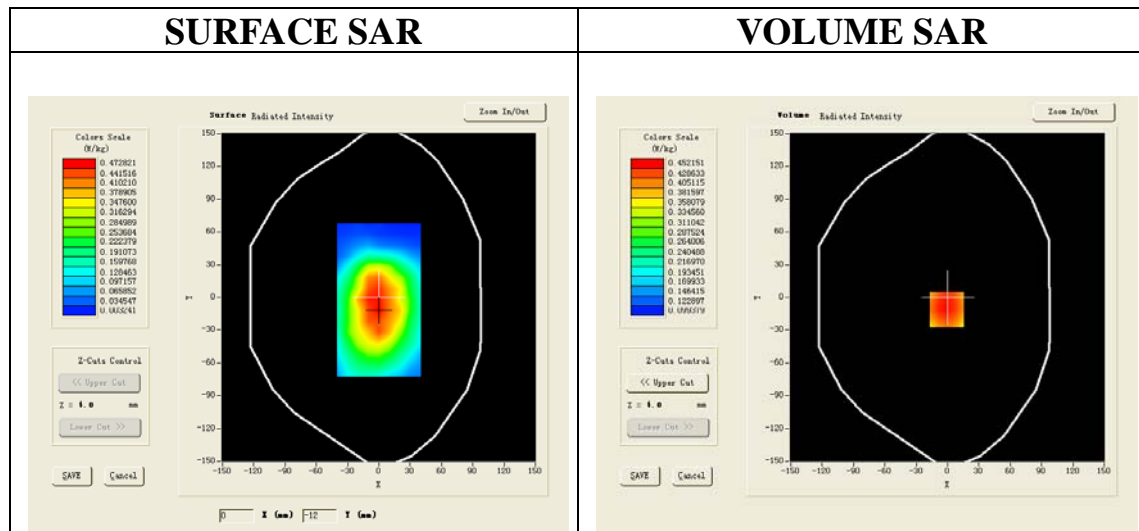

Maximum location: X=-1.00, Y=-11.00

SAR 10g (W/Kg)	0.334845
SAR 1g (W/Kg)	0.470451

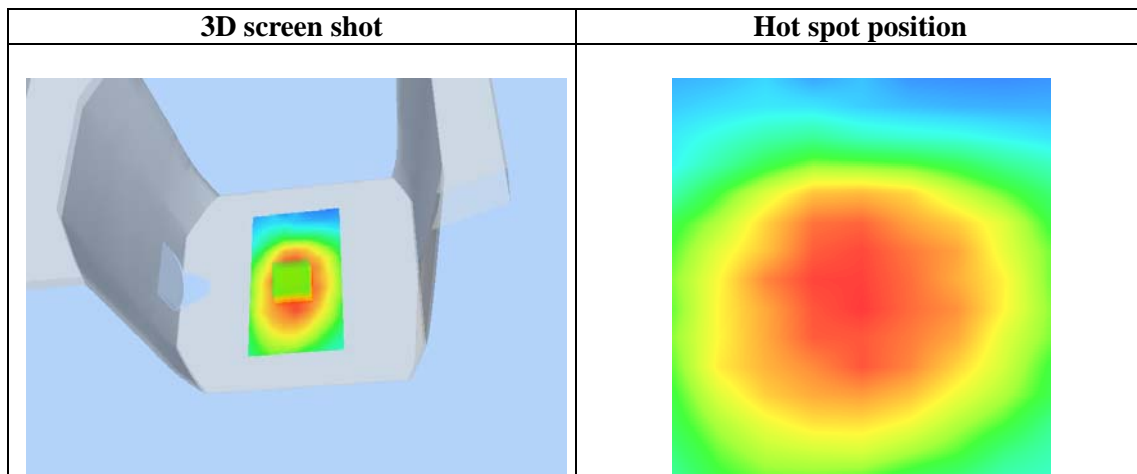
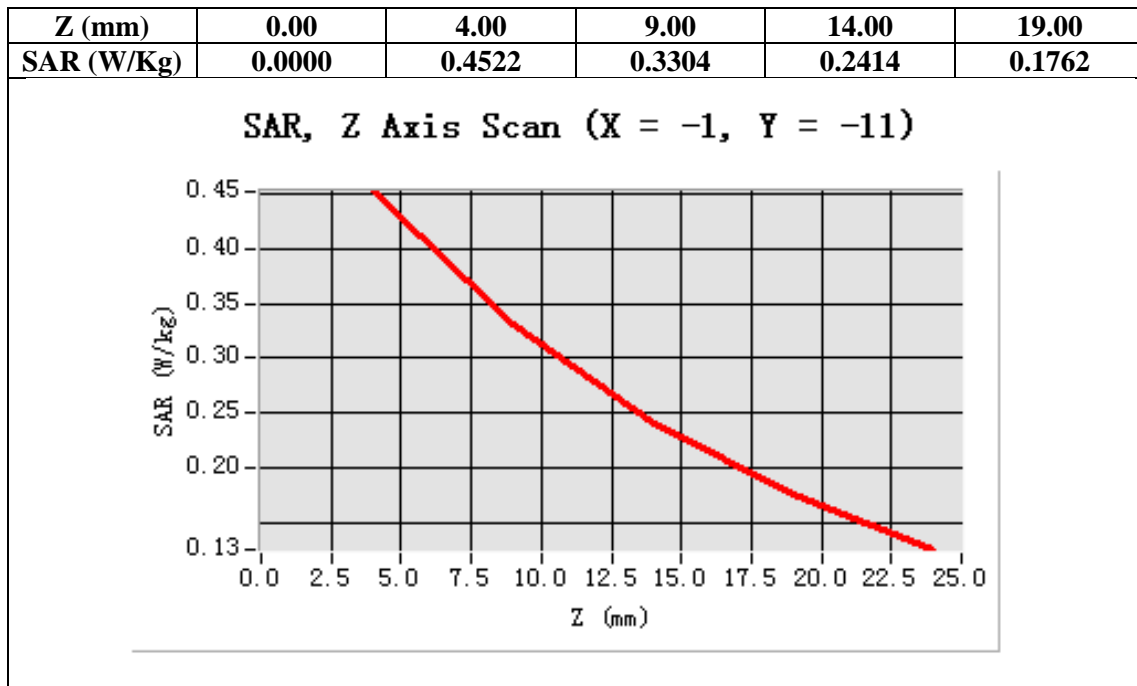

Test Laboratory: AGC Lab
PCS 1900 Mid-Touch- Left <SIM 1>

Date: Nov.19,2012

DUT: mobile phone; Type: AM316

Communication System: Generic GSM; Communication System Band: PCS 1900; Duty Cycle: 1:8.3;
Conv.F=6.42; Frequency: 1880 MHz; Medium parameters used: f = 1900 MHz; $\sigma = 1.41$ mho/m; $\epsilon_r = 39.29$;
 $\rho = 1000$ kg/m³ ;
Phantom section: Left Section
Ambient temperature (°C): 21.0, Liquid temperature (°C): 21.0

Satimo Configuration:

- Probe:SSE5; Calibrated: 12/09/2011
- Sensor-Surface: 4mm (Mechanical Surface Detection)
- Phantom: SAM1; Type: SAM
- Measurement SW: OpenSAR V4_02_01

Configuration/PCS1900 Mid-Touch-Left/Area Scan: Measurement grid: dx=20mm, dy=20mm

Configuration/PCS1900 Mid-Touch-Left/Zoom Scan: Measurement grid: dx=8mm, dy=8mm, dz=5mm;

Area Scan	sam_direct_droit2_surf8mm.txt
ZoomScan	5x5x7,dx=8mm dy=8mm dz=5mm,Very fast
Phantom	Left head
Device Position	Cheek
Band	GSM1900
Channels	Middle
Signal	TDMA (Crest factor: 8.0)

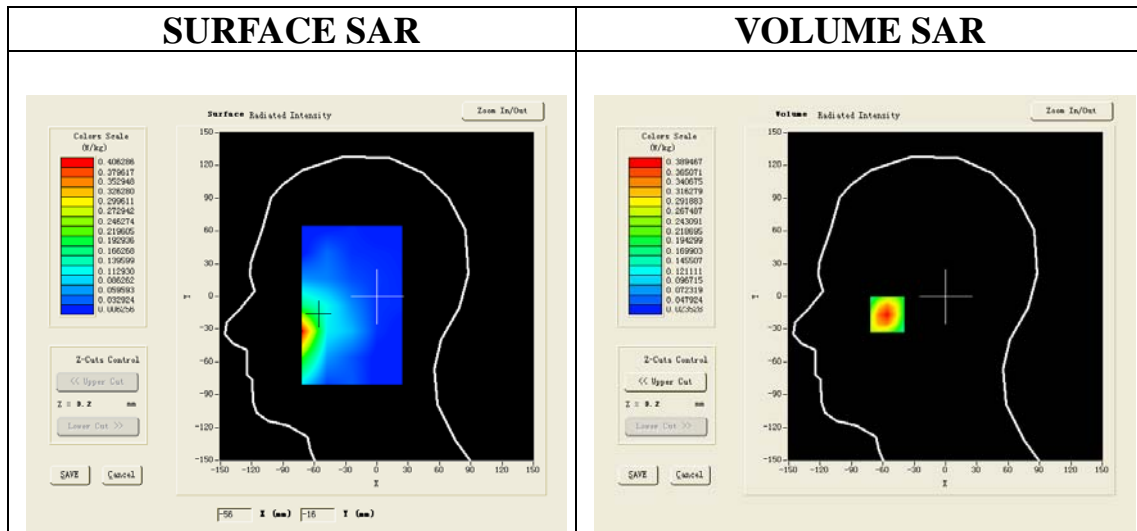

Maximum location: X=-56.00, Y=-16.00

SAR 10g (W/Kg)	0.215714
SAR 1g (W/Kg)	0.365370

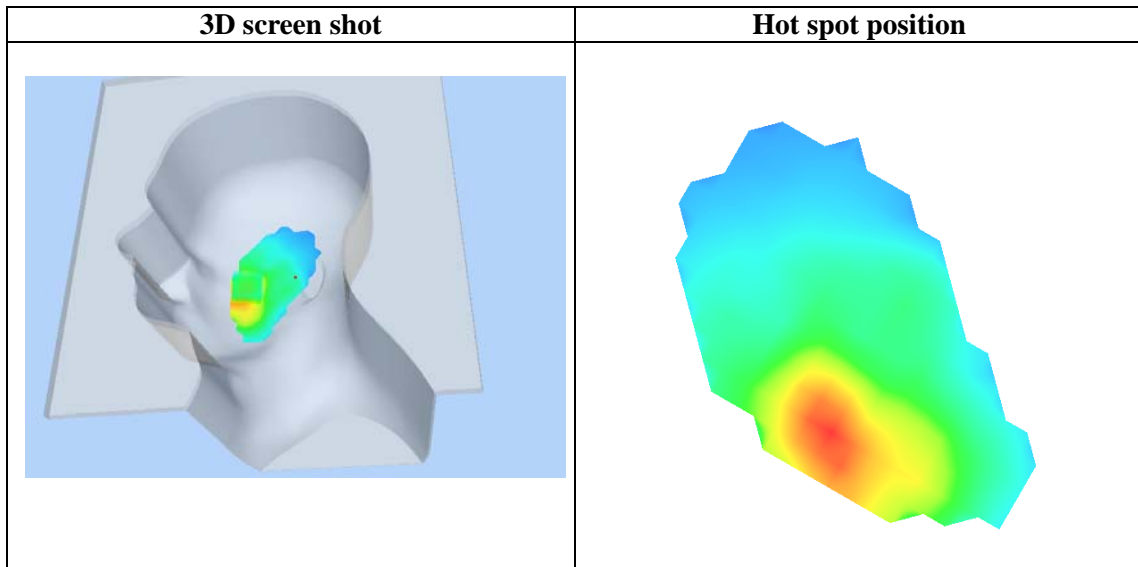
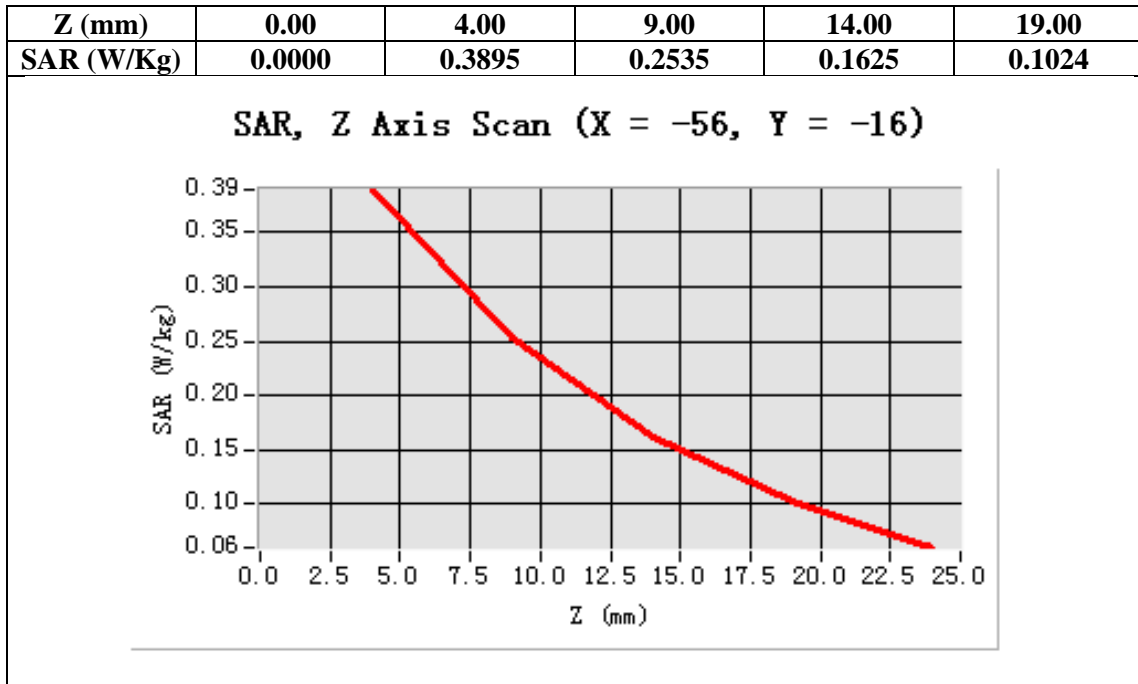

Test Laboratory: AGC Lab
PCS 1900 Mid-Tilt-Left <SIM 1>

Date: Nov.19,2012

DUT: mobile phone; Type: AM316

Communication System: Generic GSM; Communication System Band: PCS 1900; Duty Cycle: 1:8.3;
Conv.F=6.42; Frequency: 1880 MHz; Medium parameters used: $f = 1900$ MHz; $\sigma = 1.41$ mho/m; $\epsilon_r = 39.29$;
 $\rho = 1000$ kg/m³ ;
Phantom section: Left Section
Ambient temperature (°C): 21.0, Liquid temperature (°C): 21.0

Satimo Configuration:

- Probe:SSE5; Calibrated: 12/09/2011
- Sensor-Surface: 4mm (Mechanical Surface Detection)
- Phantom: SAM1; Type: SAM
- Measurement SW: OpenSAR V4_02_01

Configuration/PCS1900 Mid-Tilt-Left/Area Scan: Measurement grid: dx=20mm, dy=20mm
Configuration/PCS1900 Mid-Tilt-Left/Zoom Scan: Measurement grid: dx=8mm, dy=8mm, dz=5mm;

Area Scan	sam_direct_droit2_surf8mm.txt
ZoomScan	5x5x7,dx=8mm dy=8mm dz=5mm,Very fast
Phantom	Left head
Device Position	Tilt
Band	GSM1900
Channels	Middle
Signal	TDMA (Crest factor: 8.0)

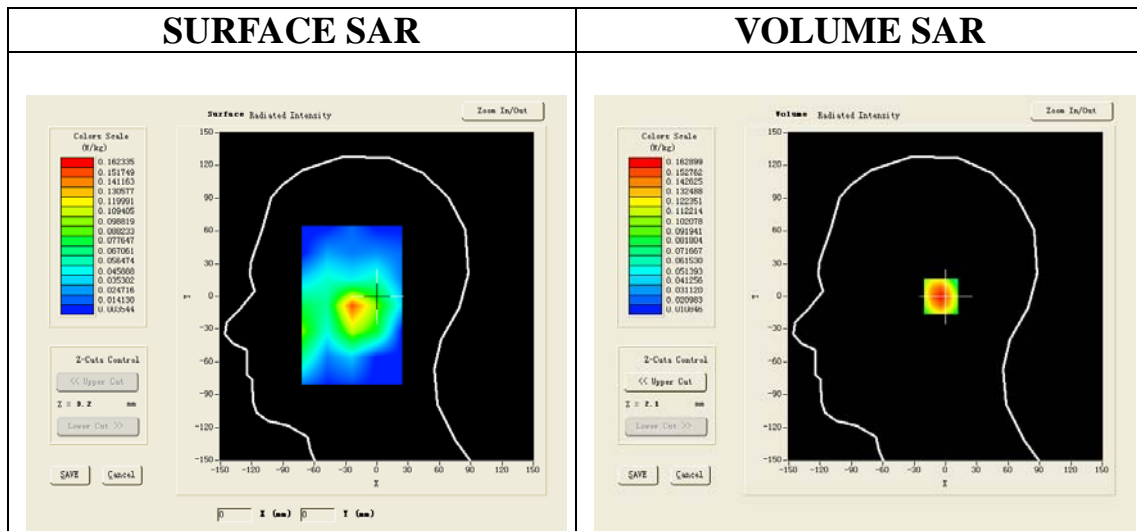

Maximum location: X=0.00, Y=0.00

SAR 10g (W/Kg)	0.095506
SAR 1g (W/Kg)	0.153625

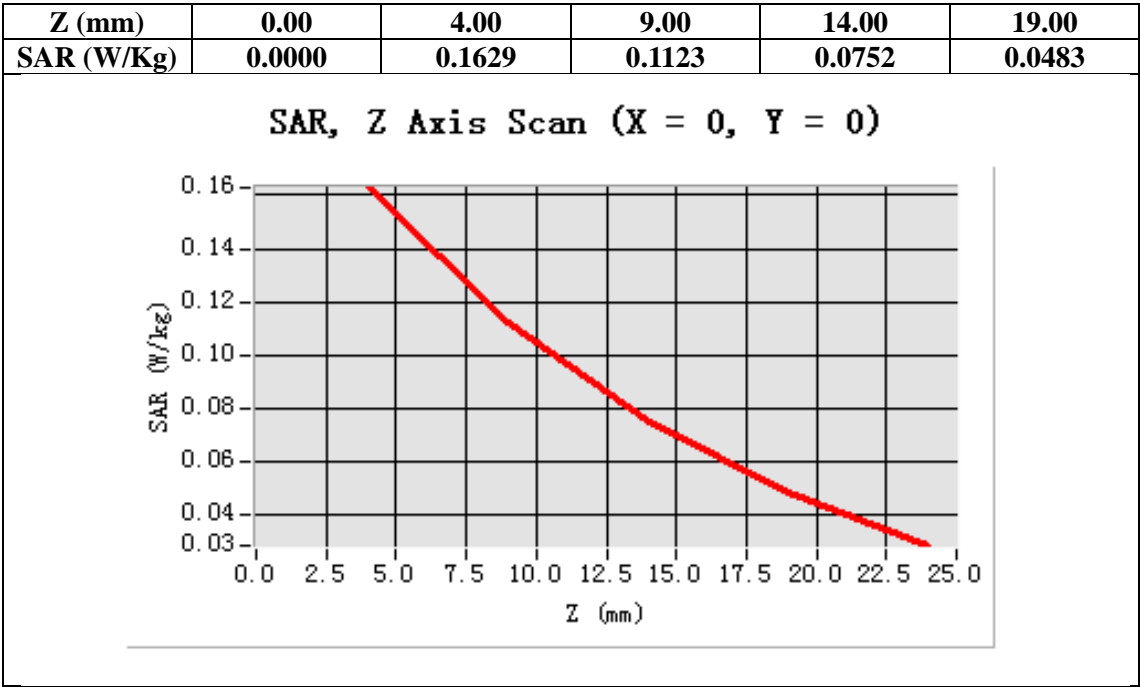

Test Laboratory: AGC Lab
PCS 1900 Low-Touch-Right <SIM 1>

Date: Nov.19,2012

DUT: mobile phone; Type: AM316

Communication System: Generic GSM; Communication System Band: PCS 1900; Duty Cycle: 1:8.3;
Conv.F=6.42; Frequency: 1850.2 MHz; Medium parameters used: $f = 1900$ MHz; $\sigma = 1.41$ mho/m; $\epsilon_r = 39.29$;
 $\rho = 1000$ kg/m³ ;

Phantom section: Right Section

Ambient temperature (°C): 21.0, Liquid temperature (°C): 21.0

Satimo Configuration:

- Probe:SSE5; Calibrated: 12/09/2011
- Sensor-Surface: 4mm (Mechanical Surface Detection)
- Phantom: SAM1; Type: SAM
- Measurement SW: OpenSAR V4_02_01

Configuration/PCS1900 Low-Touch-Right/Area Scan: Measurement grid: dx=20mm, dy=20mm

Configuration/PCS1900 Low-Touch-Right/Zoom Scan: Measurement grid: dx=8mm, dy=8mm, dz=5mm;

Area Scan	sam_direct droit2_surf8mm.txt
ZoomScan	5x5x7,dx=8mm dy=8mm dz=5mm,Very fast
Phantom	Right head
Device Position	Cheek
Band	GSM1900
Channels	Low
Signal	TDMA (Crest factor: 8.0)

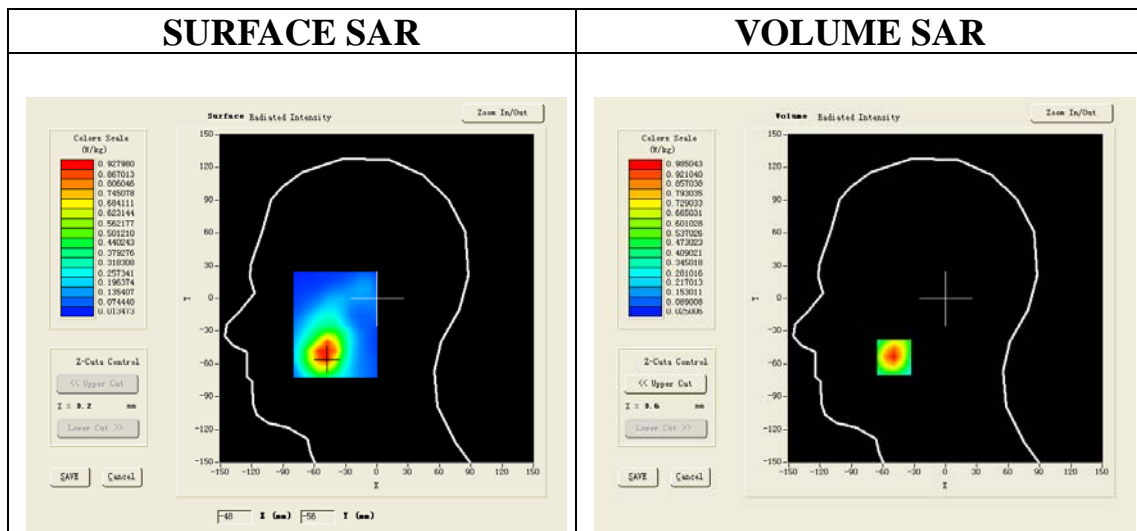

Maximum location: X=-49.00, Y=-54.00

SAR 10g (W/Kg)	0.471435
SAR 1g (W/Kg)	0.930295

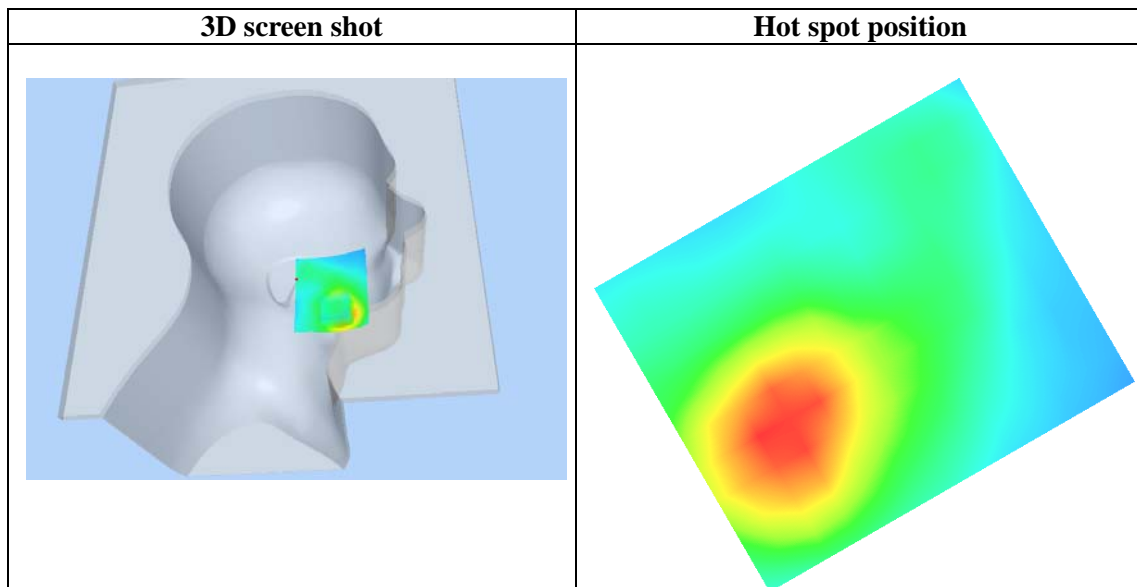
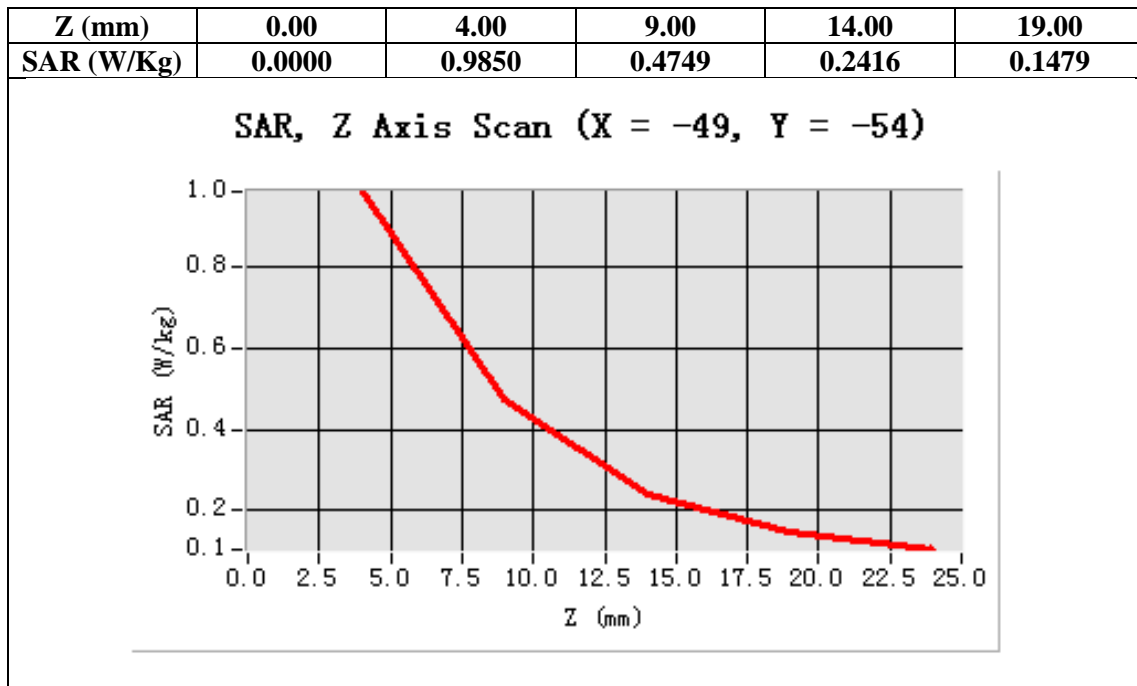

Test Laboratory: AGC Lab
PCS 1900 Mid-Touch-Right <SIM 1>

Date: Nov.19,2012

DUT: mobile phone; Type: AM316

Communication System: Generic GSM; Communication System Band: PCS 1900; Duty Cycle: 1:8.3;
Conv.F=6.42; Frequency: 1880 MHz; Medium parameters used: $f = 1900$ MHz; $\sigma = 1.41$ mho/m; $\epsilon_r = 39.29$;
 $\rho = 1000$ kg/m³ ;
Phantom section: Right Section
Ambient temperature (°C): 21.0, Liquid temperature (°C): 21.0

Satimo Configuration:

- Probe:SSE5; Calibrated: 12/09/2011
- Sensor-Surface: 4mm (Mechanical Surface Detection)
- Phantom: SAM1; Type: SAM
- Measurement SW: OpenSAR V4_02_01

Configuration/PCS1900 Mid-Touch-Right/Area Scan: Measurement grid: dx=20mm, dy=20mm

Configuration/PCS1900 Mid-Touch-Right/Zoom Scan: Measurement grid: dx=8mm, dy=8mm, dz=5mm;

Area Scan	sam_direct_droit2_surf8mm.txt
ZoomScan	5x5x7,dx=8mm dy=8mm dz=5mm,Very fast
Phantom	Right head
Device Position	Cheek
Band	GSM1900
Channels	Middle
Signal	TDMA (Crest factor: 8.0)

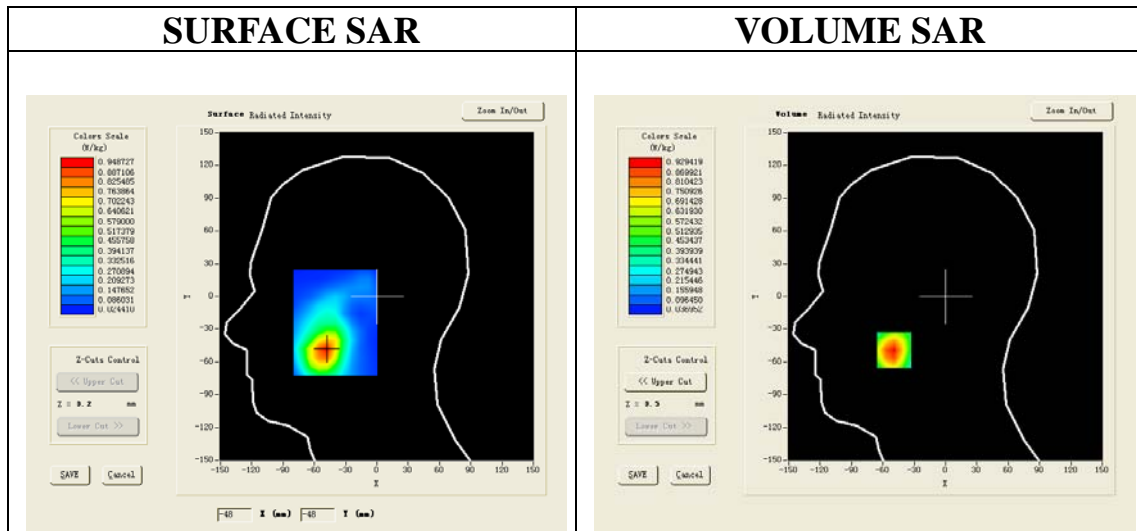

Maximum location: X=-49.00, Y=-49.00

SAR 10g (W/Kg)	0.493069
SAR 1g (W/Kg)	0.880544

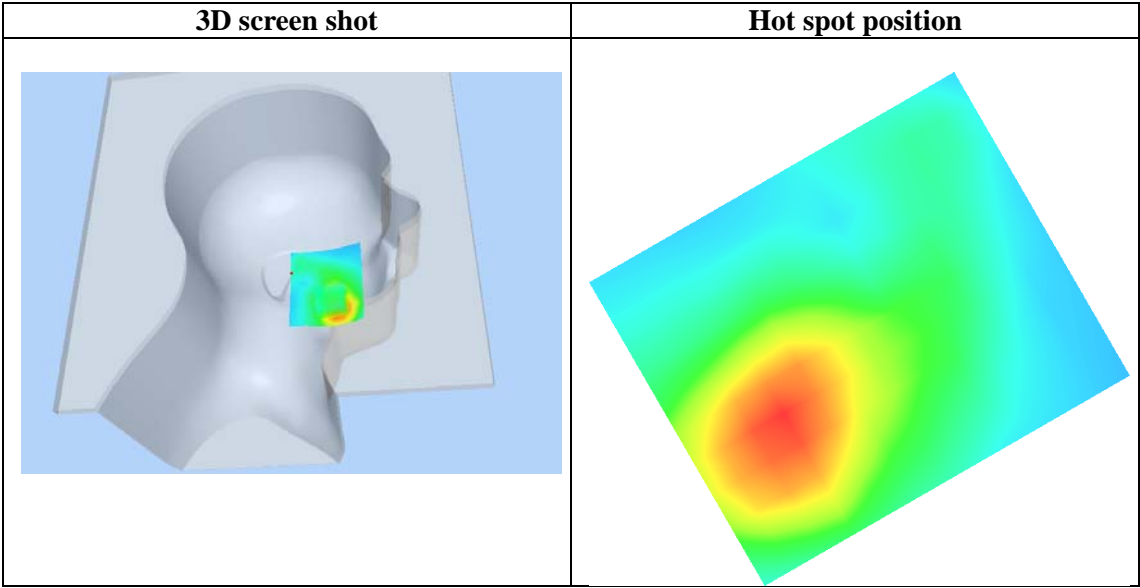
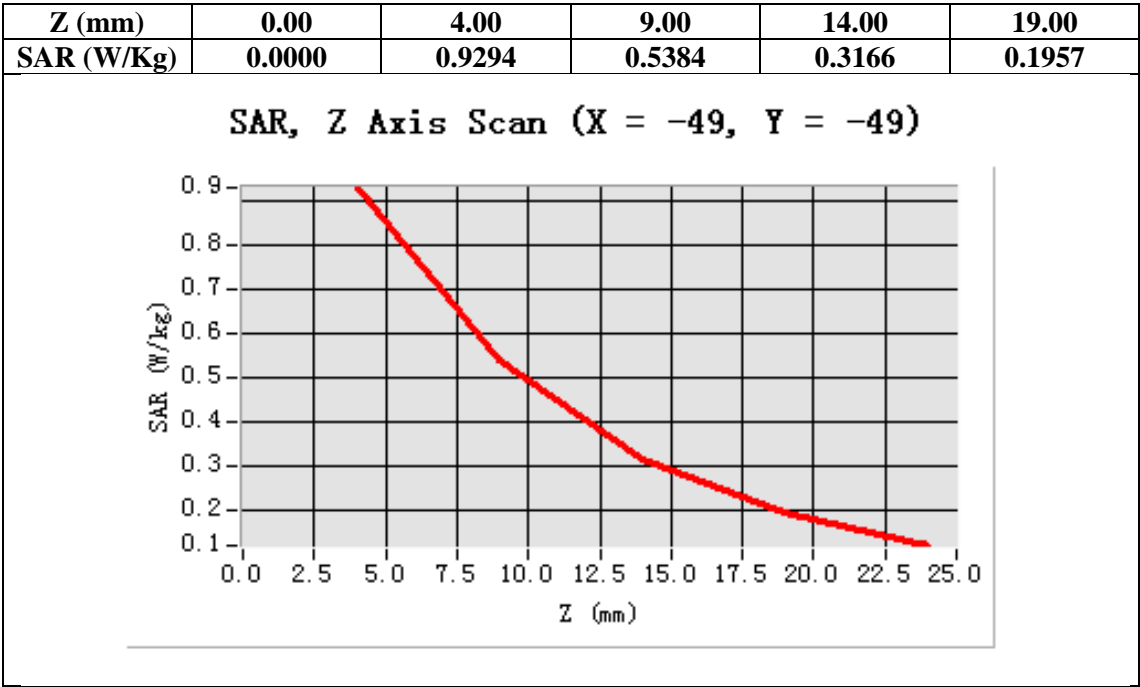

Test Laboratory: AGC Lab
PCS 1900 High-Touch-Right <SIM 1>

Date: Nov.19,2012

DUT: mobile phone; Type: AM316

Communication System: Generic GSM; Communication System Band: PCS 1900; Duty Cycle: 1:8.3;
Conv.F=6.42; Frequency: 1909.8 MHz; Medium parameters used: $f = 1900$ MHz; $\sigma = 1.41$ mho/m; $\epsilon_r = 39.29$;
 $\rho = 1000$ kg/m³ ;
Phantom section: Right Section
Ambient temperature (°C): 21.0, Liquid temperature (°C): 21.0

Satimo Configuration:

- Probe:SSE5; Calibrated: 12/09/2011
- Sensor-Surface: 4mm (Mechanical Surface Detection)
- Phantom: SAM1; Type: SAM
- Measurement SW: OpenSAR V4_02_01

Configuration/PCS1900 High-Touch-Right/Area Scan: Measurement grid: dx=20mm, dy=20mm

Configuration/PCS1900 High-Touch-Right/Zoom Scan: Measurement grid: dx=8mm, dy=8mm, dz=5mm;

Area Scan	sam_direct droit2_surf8mm.txt
ZoomScan	5x5x7,dx=8mm dy=8mm dz=5mm,Very fast
Phantom	Right head
Device Position	Cheek
Band	GSM1900
Channels	High
Signal	TDMA (Crest factor: 8.0)

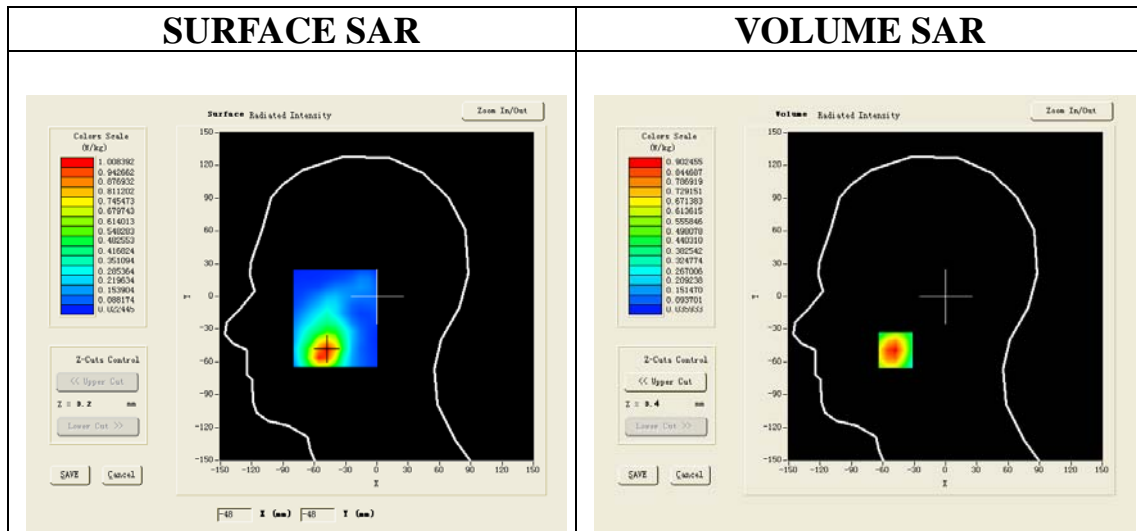

Maximum location: X=-48.00, Y=-49.00

SAR 10g (W/Kg)	0.490936
SAR 1g (W/Kg)	0.855531

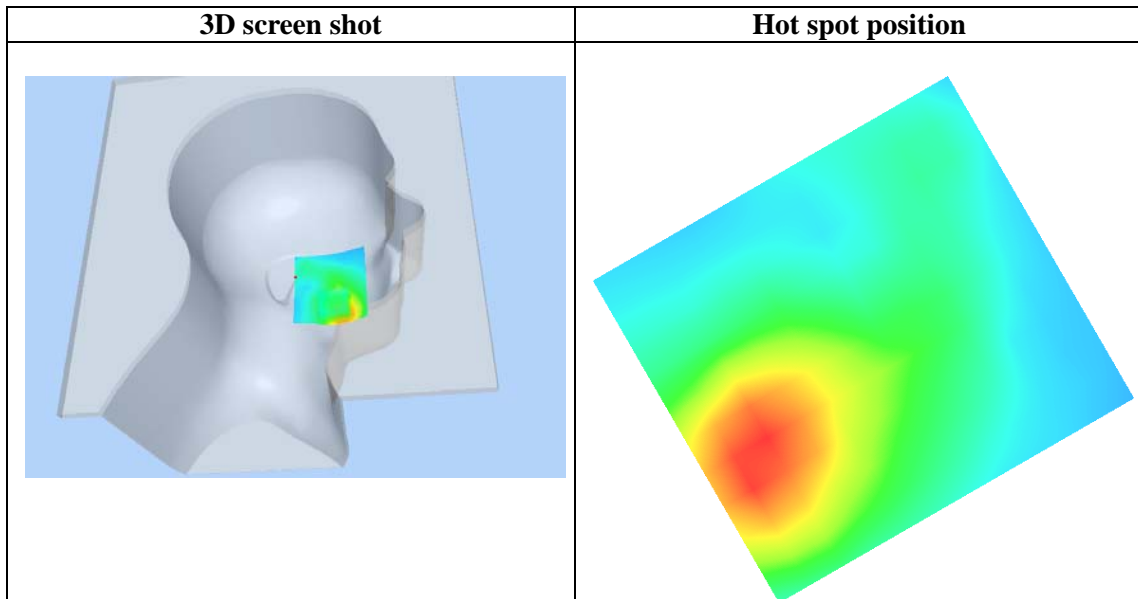
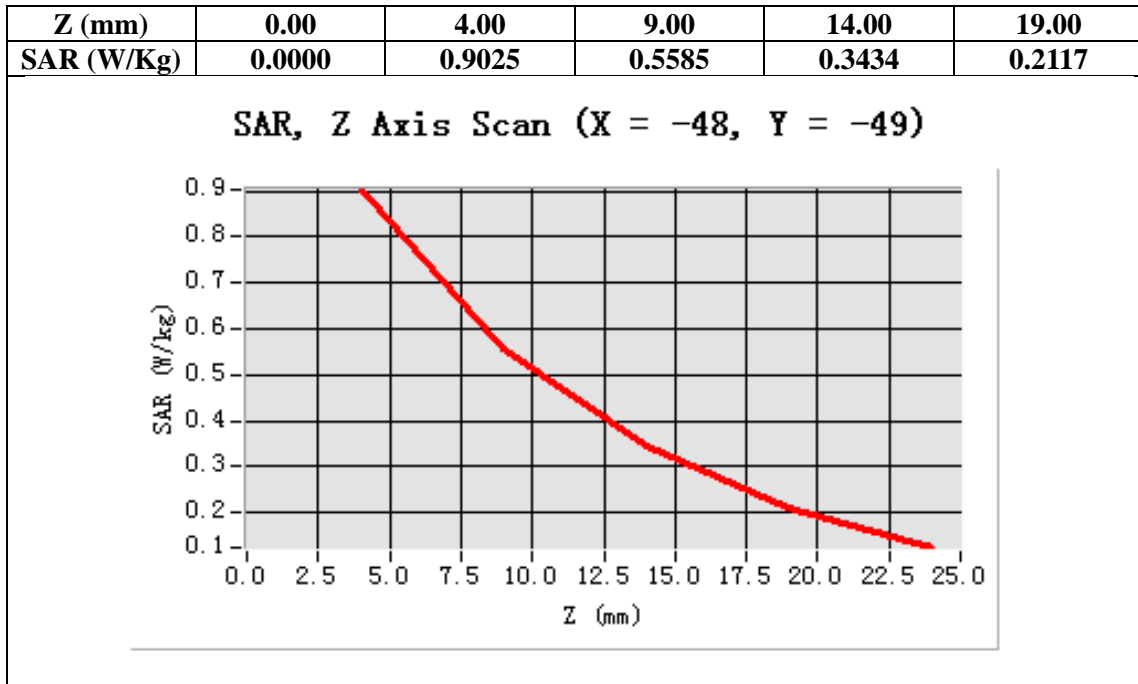

Test Laboratory: AGC Lab

Date: Nov.19,2012

PCS 1900 Mid-Tilt-Right <SIM 1>

DUT: mobile phone; Type: AM316

Communication System: Generic GSM; Communication System Band: PCS 1900; Duty Cycle: 1:8.3; Conv.F=6.42;
Frequency: 1880 MHz; Medium parameters used: $f = 1900$ MHz; $\sigma = 1.41$ mho/m; $\epsilon_r = 39.29$;

$\rho = 1000$ kg/m³ ;

Phantom section: Right Section

Ambient temperature (°C): 21.0, Liquid temperature (°C): 21.0

Satimo Configuration:

- Probe:SSE5; Calibrated: 12/09/2011
- Sensor-Surface: 4mm (Mechanical Surface Detection)
- Phantom: SAM1; Type: SAM
- Measurement SW: OpenSAR V4_02_01

Configuration/PCS1900 Mid-Tilt-Right/Area Scan: Measurement grid: dx=20mm, dy=20mm

Configuration/PCS1900 Mid-Tilt-Right/Zoom Scan: Measurement grid: dx=8mm, dy=8mm, dz=5mm;

Area Scan	sam_direct_droit2_surf8mm.txt
ZoomScan	5x5x7,dx=8mm dy=8mm dz=5mm,Very fast
Phantom	Right head
Device Position	Tilt
Band	GSM1900
Channels	Middle
Signal	TDMA (Crest factor: 8.0)

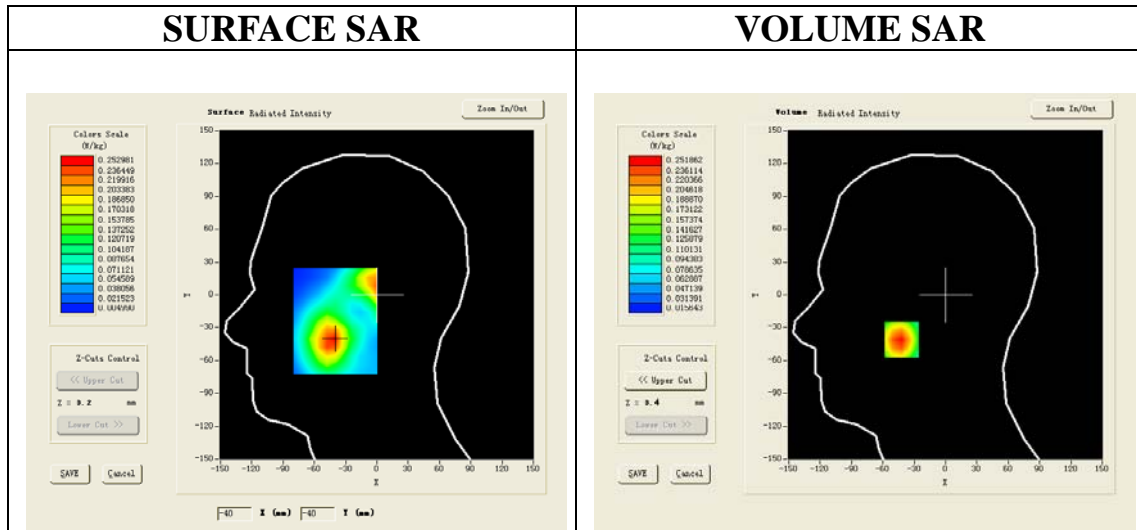

Maximum location: X=-42.00, Y=-41.00

SAR 10g (W/Kg)	0.141561
SAR 1g (W/Kg)	0.238643

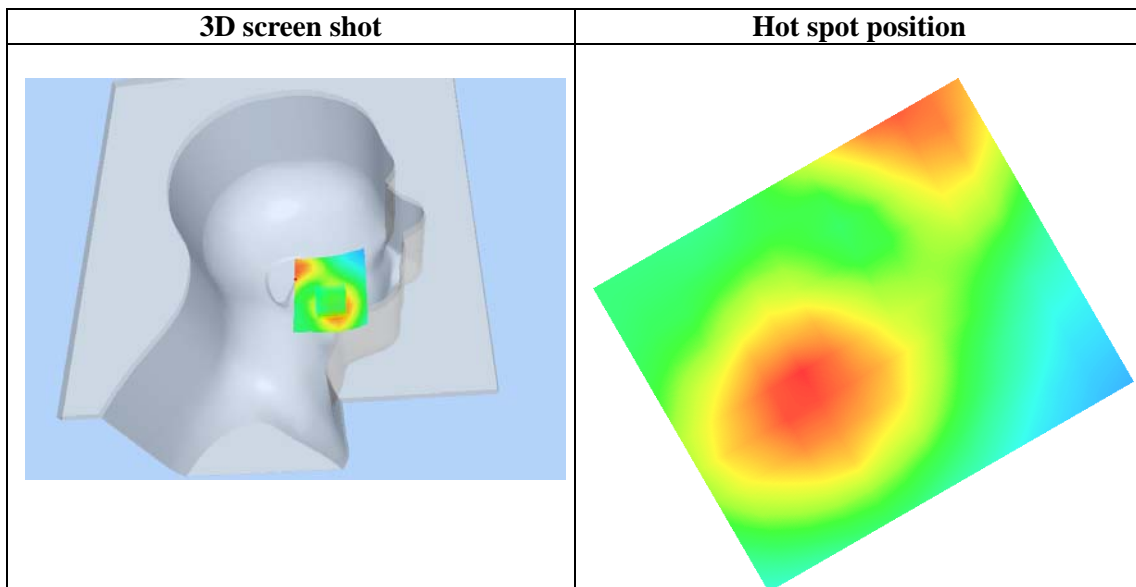
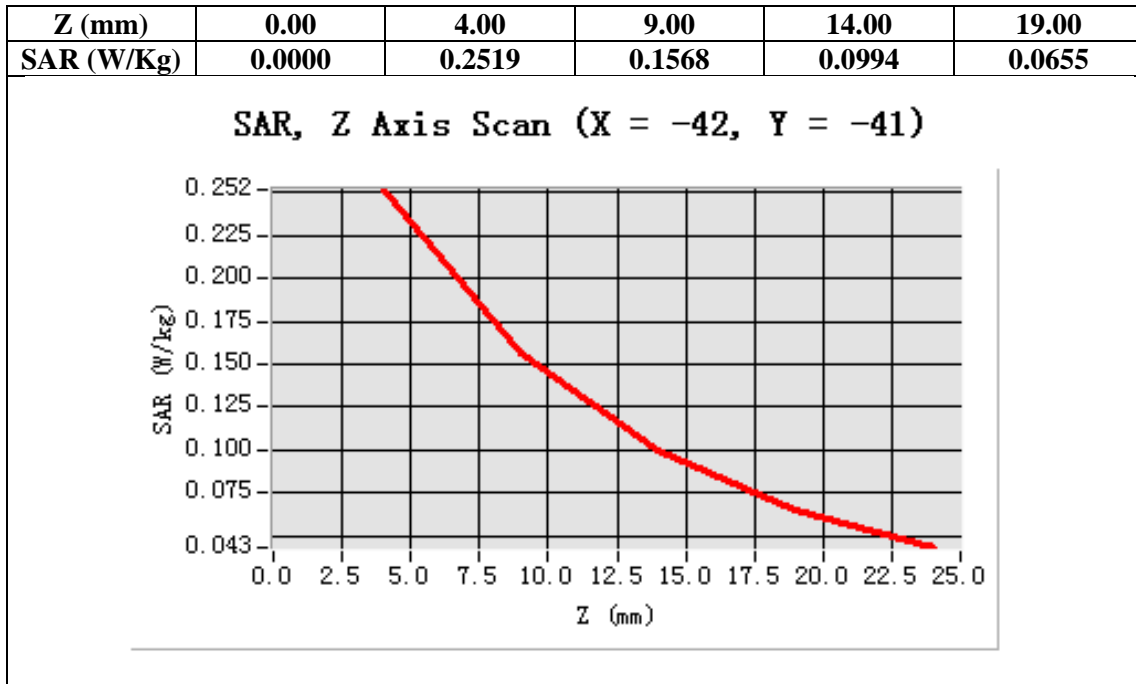

Test Laboratory: AGC Lab
PCS 1900 Low-Touch-Left <SIM 2>

Date: Nov.19,2012

DUT: mobile phone; Type: AM316

Communication System: Generic GSM; Communication System Band: PCS 1900; Duty Cycle: 1:8.3;
Conv.F=6.42; Frequency: 1850.2 MHz; Medium parameters used: $f = 1900$ MHz; $\sigma = 1.41$ mho/m; $\epsilon_r = 39.29$;
 $\rho = 1000$ kg/m³ ;

Phantom section: Right Section

Ambient temperature (°C): 21.0, Liquid temperature (°C): 21.0

Satimo Configuration:

- Probe:SSE5; Calibrated: 12/09/2011
- Sensor-Surface: 4mm (Mechanical Surface Detection)
- Phantom: SAM1; Type: SAM
- Measurement SW: OpenSAR V4_02_01

Configuration/PCS1900 Low-Touch-Right/Area Scan: Measurement grid: dx=20mm, dy=20mm

Configuration/PCS1900 Low-Touch-Right/Zoom Scan: Measurement grid: dx=8mm, dy=8mm, dz=5mm;

Area Scan	sam_direct_droit2_surf8mm.txt
ZoomScan	5x5x7,dx=8mm dy=8mm dz=5mm,Very fast
Phantom	Right head
Device Position	Cheek
Band	GSM1900
Channels	Low
Signal	TDMA (Crest factor: 8.0)

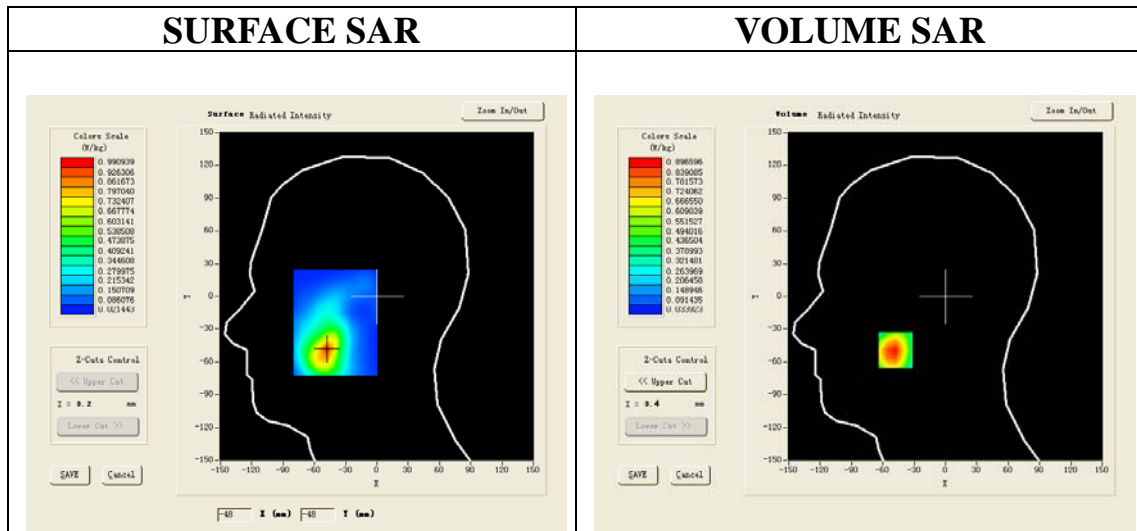

Maximum location: X=-48.00, Y=-49.00

SAR 10g (W/Kg)	0.471419
SAR 1g (W/Kg)	0.855797

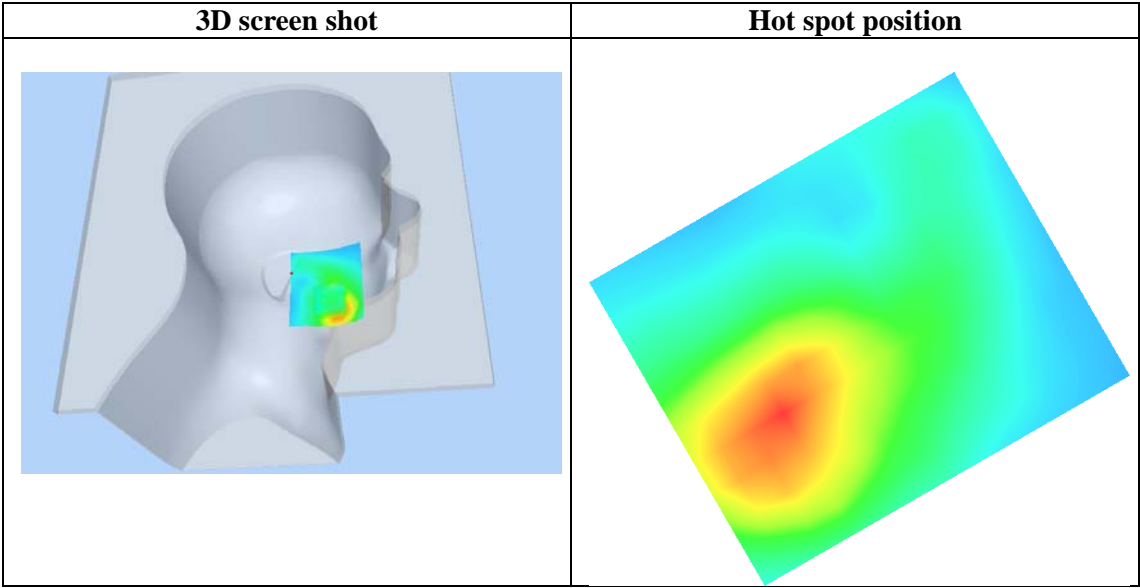
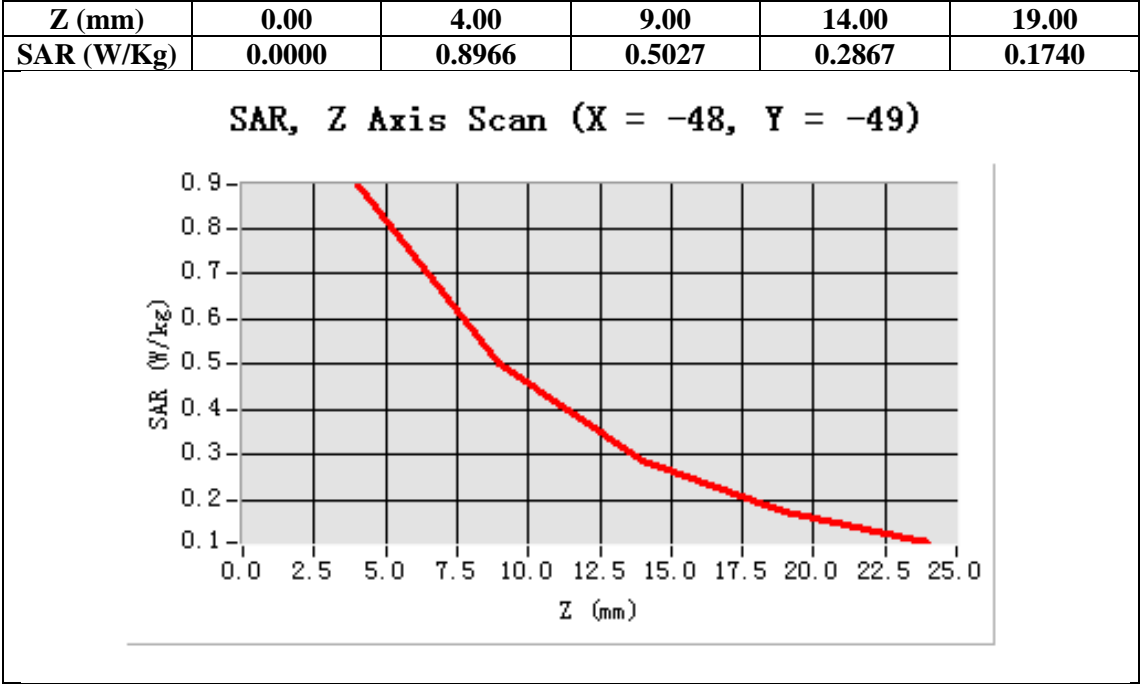

Test Laboratory: AGC Lab
PCS 1900 Mid-Body-Back <SIM 1>

Date: Nov.19,2012

DUT: mobile phone; Type: AM316

Communication System: Generic GSM; Communication System Band: PCS 1900; Duty Cycle: 1:8.3;
Conv.F=6.42; Frequency: 1880 MHz; Medium parameters used: $f = 1900$ MHz; $\sigma = 1.47$ mho/m; $\epsilon_r = 54.01$;
 $\rho = 1000$ kg/m³ ;
Phantom section: Flat Section
Ambient temperature (°C): 21.0, Liquid temperature (°C): 21.0

Satimo Configuration:

- Probe:SSE5; Calibrated: 12/09/2011
- Sensor-Surface: 4mm (Mechanical Surface Detection)
- Phantom: SAM1; Type: SAM
- Measurement SW: OpenSAR V4_02_01

Configuration/PCS1900 Mid-Body-Back/Area Scan: Measurement grid: dx=20mm, dy=20mm

Configuration/PCS1900 Mid-Body-Back/Zoom Scan: Measurement grid: dx=8mm, dy=8mm, dz=5mm;

Area Scan	surf_sam_plan.txt
ZoomScan	5x5x7,dx=8mm dy=8mm dz=5mm,Very fast
Phantom	Validation plane
Device Position	Body
Band	GSM1900
Channels	Middle
Signal	TDMA (Crest factor: 8.0)

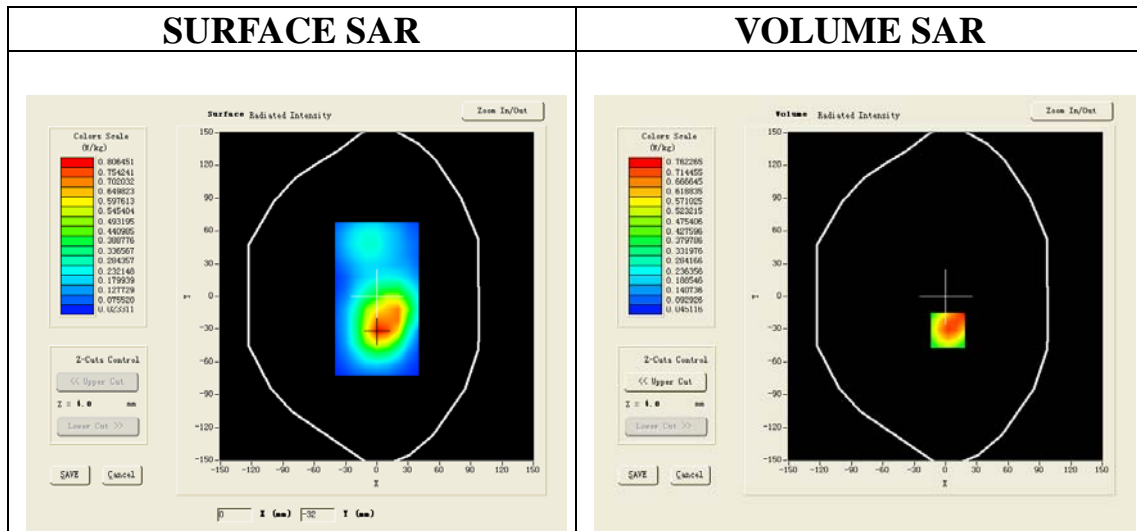

Maximum location: X=2.00, Y=-31.00

SAR 10g (W/Kg)	0.426330
SAR 1g (W/Kg)	0.696049

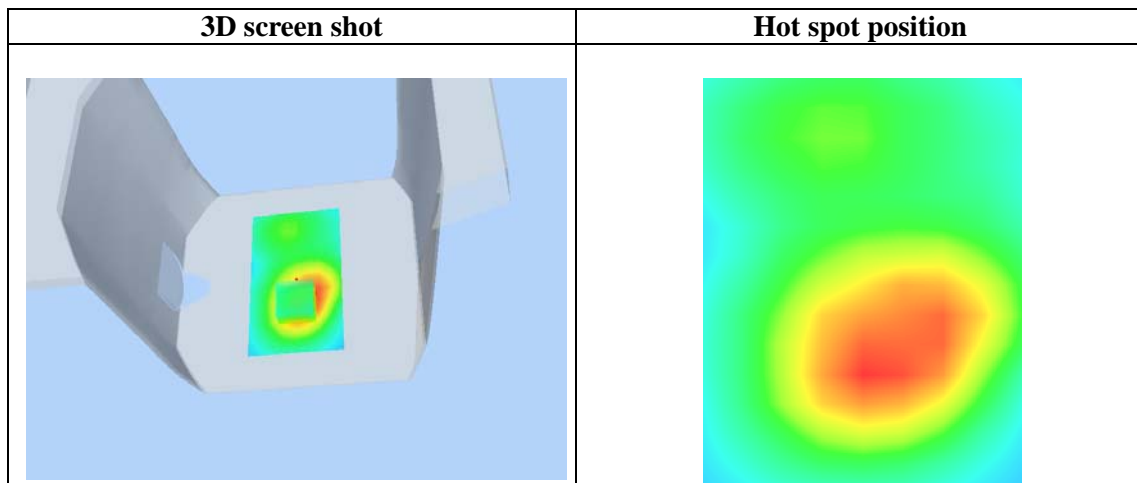
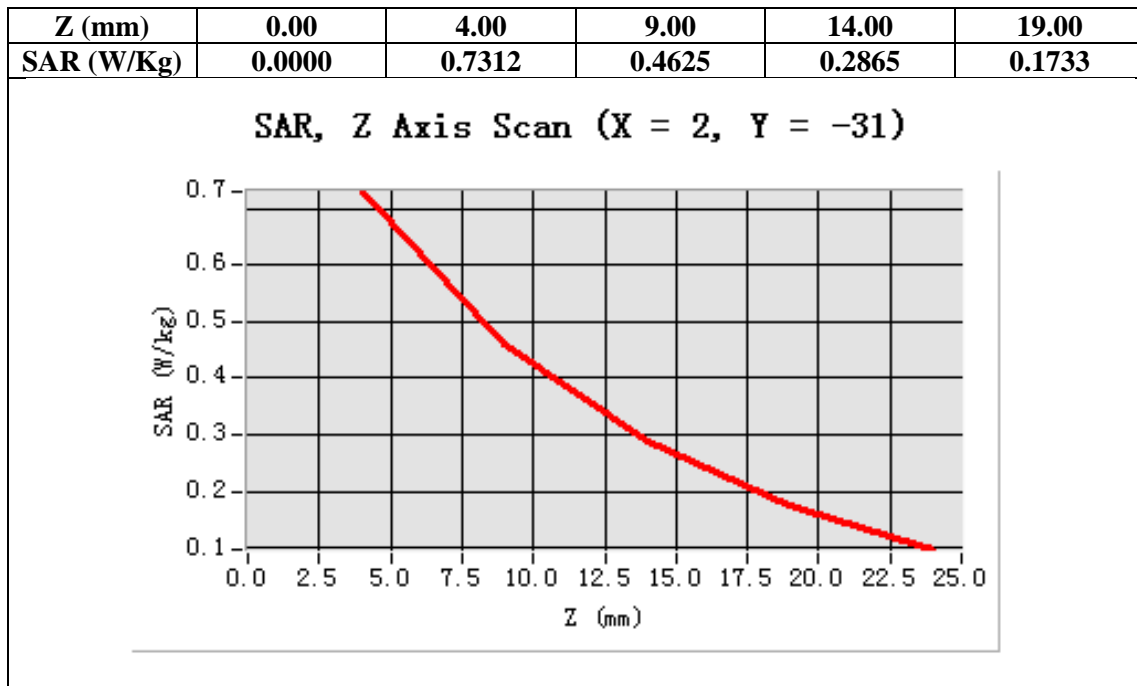

Test Laboratory: AGC Lab
PCS 1900 Low-Body-Back (2up) <SIM 1>

Date: Nov.19,2012

DUT: mobile phone; Type: AM316

Communication System: GPRS-2 Slot; Communication System Band: PCS1900; Duty Cycle: 1:4.2 ; Conv.F=6.42;
Frequency: 1850.2 MHz; Medium parameters used: $f = 1900$ MHz; $\sigma = 1.47$ mho/m; $\epsilon_r = 54.01$;

$\rho = 1000$ kg/m³ ;

Phantom section: Flat Section

Ambient temperature (°C): 21.0, Liquid temperature (°C): 21.0

Satimo Configuration:

- Probe:SSE5; Calibrated: 12/09/2011
- Sensor-Surface: 4mm (Mechanical Surface Detection)
- Phantom: SAM1; Type: SAM
- Measurement SW: OpenSAR V4_02_01

Configuration/GPRS1900 Low-Body-Back/Area Scan: Measurement grid: dx=20mm, dy=20mm

Configuration/GPRS1900 Low-Body-Back/Zoom Scan: Measurement grid: dx=8mm, dy=8mm, dz=5m;

Area Scan	surf_sam_plan.txt
ZoomScan	5x5x7,dx=8mm dy=8mm dz=5mm,Very fast
Phantom	Validation plane
Device Position	Body
Band	GSM1900
Channels	Low
Signal	TDMA (Crest factor: 4.0)

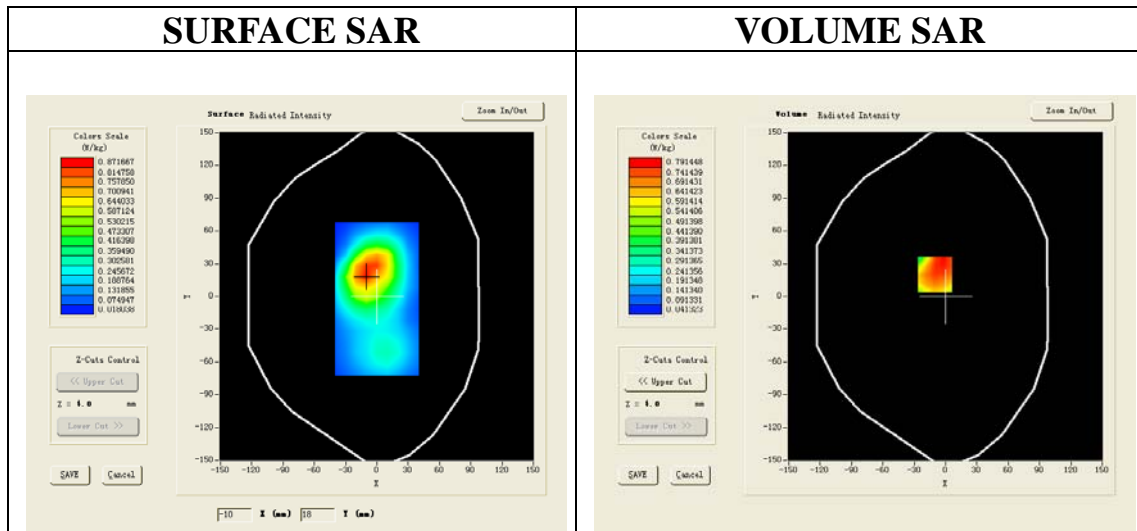

Maximum location: X=-10.00, Y=20.00

SAR 10g (W/Kg)	0.507160
SAR 1g (W/Kg)	0.818825

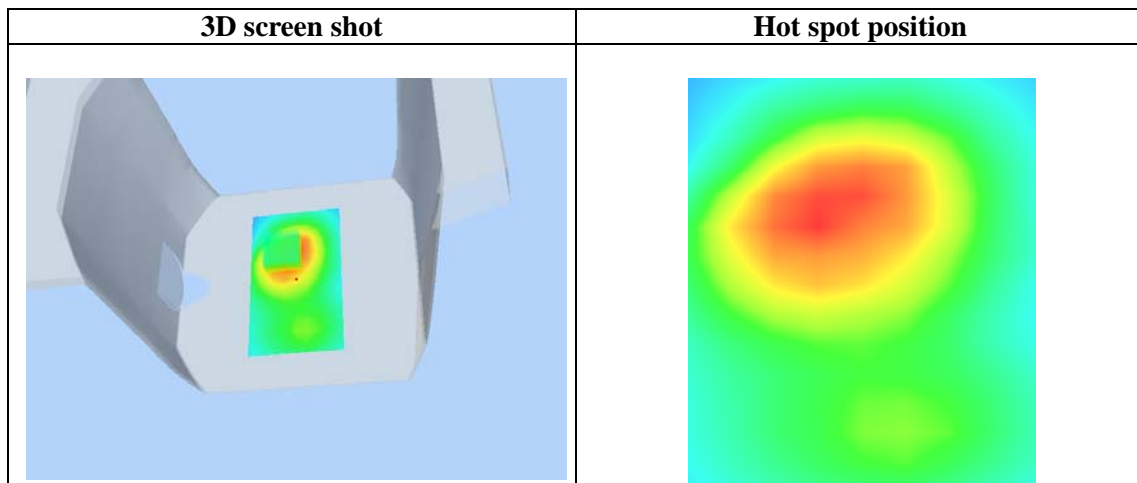
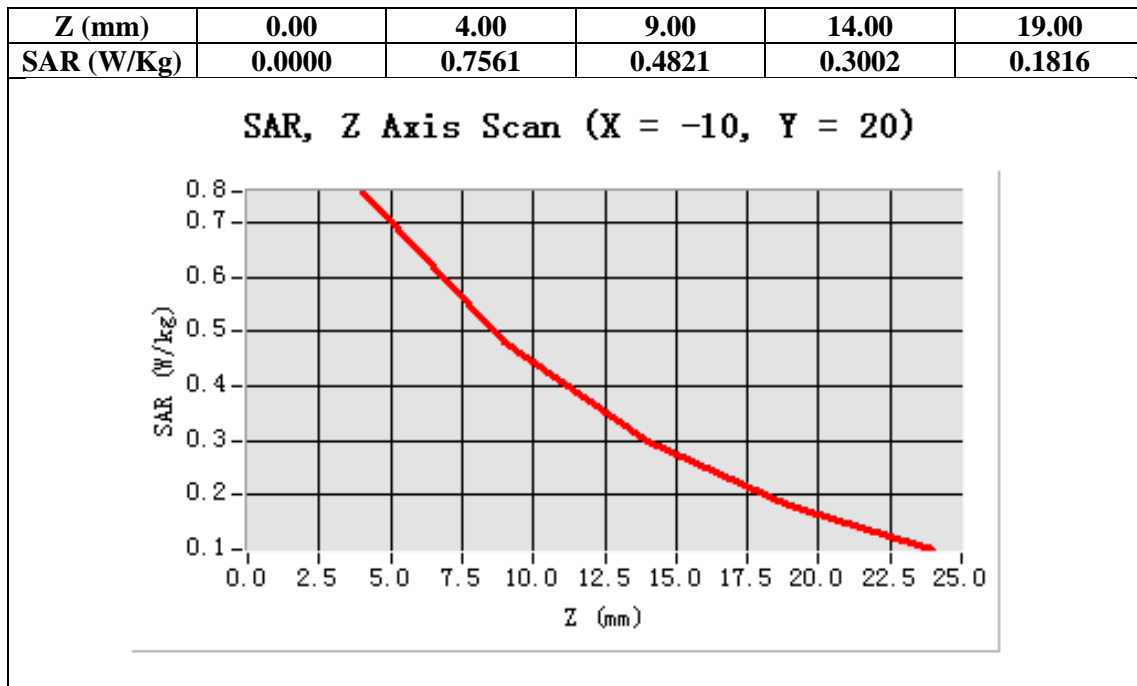

Test Laboratory: AGC Lab
PCS 1900 Mid-Body-Back (2up) <SIM 1>

Date: Nov.19,2012

DUT: mobile phone; Type: AM316

Communication System: GPRS-2 Slot; Communication System Band: PCS1900; Duty Cycle: 1:4.2 ; Conv.F=6.42;
Frequency: 1880 MHz; Medium parameters used: $f = 1900$ MHz; $\sigma = 1.47$ mho/m; $\epsilon_r = 54.01$;

$\rho = 1000$ kg/m³ ;

Phantom section: Flat Section

Ambient temperature (°C): 21.0, Liquid temperature (°C): 21.0

Satimo Configuration:

- Probe:SSE5; Calibrated: 12/09/2011
- Sensor-Surface: 4mm (Mechanical Surface Detection)
- Phantom: SAM1; Type: SAM
- Measurement SW: OpenSAR V4_02_01

Configuration/GPRS1900 Mid-Body-Back/Area Scan: Measurement grid: dx=20mm, dy=20mm

Configuration/GPRS1900 Mid-Body-Back/Zoom Scan: Measurement grid: dx=8mm, dy=8mm, dz=5m;

Area Scan	surf_sam_plan.txt
ZoomScan	5x5x7,dx=8mm dy=8mm dz=5mm,Very fast
Phantom	Validation plane
Device Position	Body
Band	GSM1900
Channels	Middle
Signal	TDMA (Crest factor: 4.0)

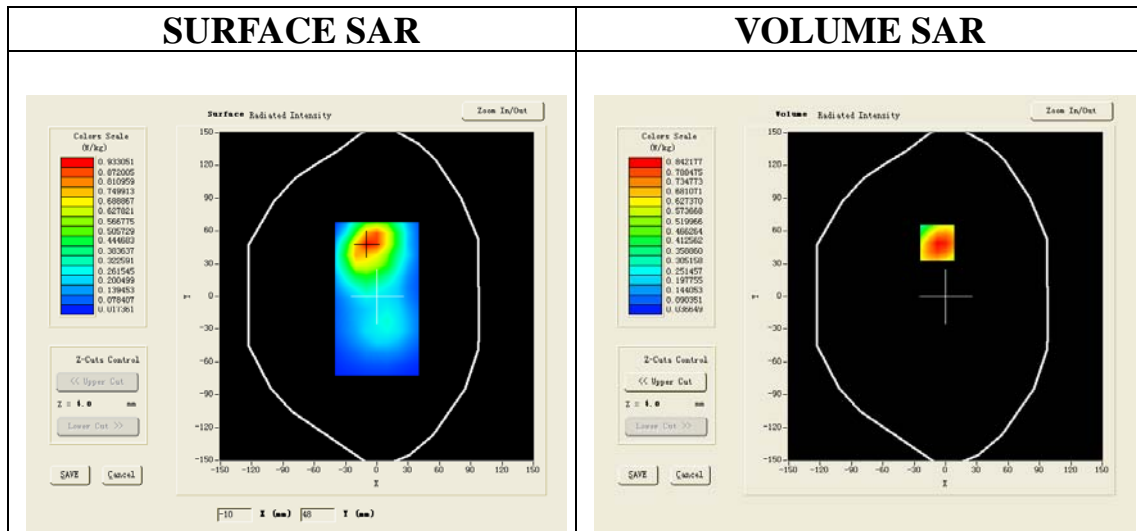

Maximum location: X=-8.00, Y=49.00

SAR 10g (W/Kg)	0.523341
SAR 1g (W/Kg)	0.874263

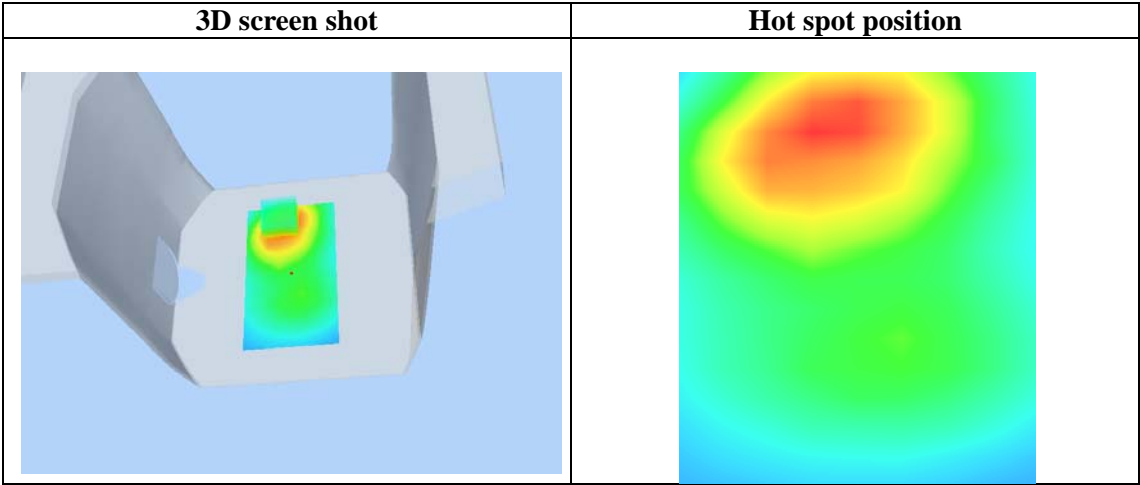
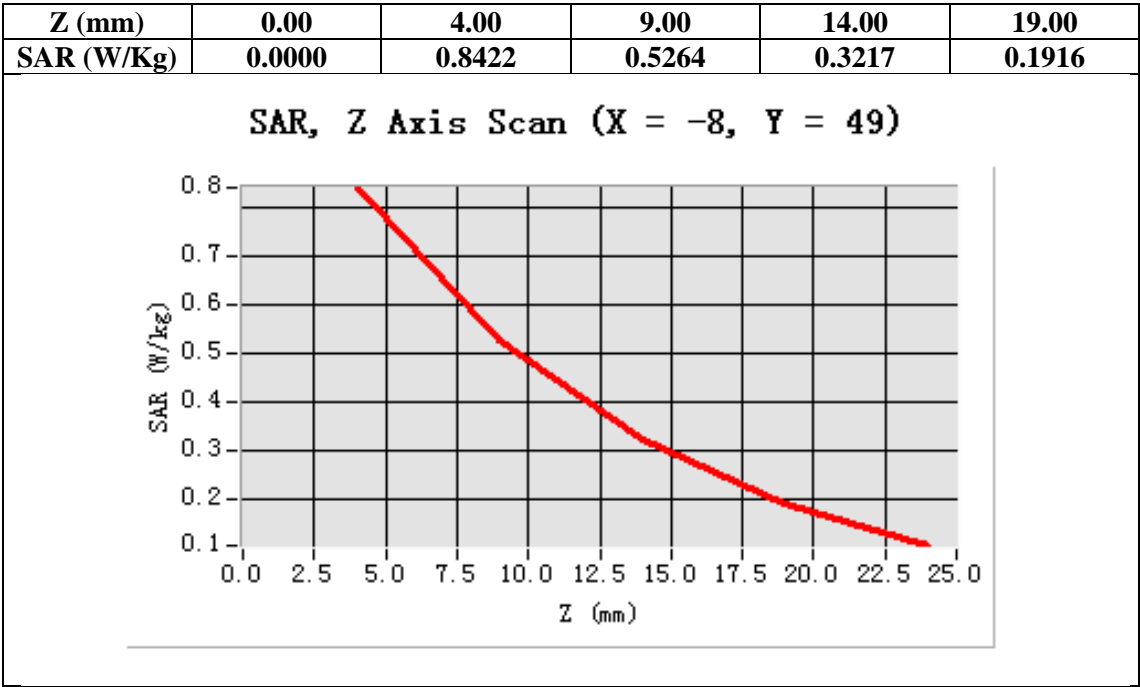

Test Laboratory: AGC Lab
PCS 1900 High-Body-Back (2up) <SIM 1>

Date: Nov.19,2012

DUT: mobile phone; Type: AM316

Communication System: GPRS-2 Slot; Communication System Band: PCS1900; Duty Cycle: 1:4.2 ; Conv.F=6.42;
Frequency: 1909.8 MHz; Medium parameters used: $f = 1900$ MHz; $\sigma = 1.47$ mho/m; $\epsilon_r = 54.01$;

$\rho = 1000$ kg/m³ ;

Phantom section: Flat Section

Ambient temperature (°C): 21.0, Liquid temperature (°C): 21.0

Satimo Configuration:

- Probe:SSE5; Calibrated: 12/09/2011
- Sensor-Surface: 4mm (Mechanical Surface Detection)
- Phantom: SAM1; Type: SAM
- Measurement SW: OpenSAR V4_02_01

Configuration/GPRS1900 High-Body-Back/Area Scan: Measurement grid: dx=20mm, dy=20mm

Configuration/GPRS1900 High-Body-Back/Zoom Scan: Measurement grid: dx=8mm, dy=8mm, dz=5m;

Area Scan	surf_sam_plan.txt
ZoomScan	5x5x7,dx=8mm dy=8mm dz=5mm,Very fast
Phantom	Validation plane
Device Position	Body
Band	GSM1900
Channels	High
Signal	TDMA (Crest factor: 4.0)

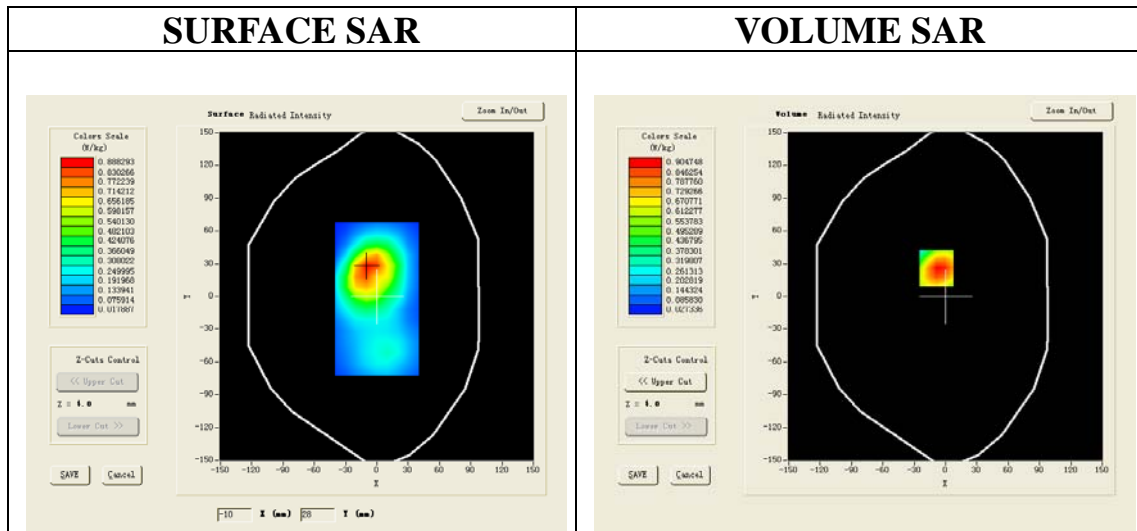

Maximum location: X=-9.00, Y=26.00

SAR 10g (W/Kg)	0.532145
SAR 1g (W/Kg)	0.939630

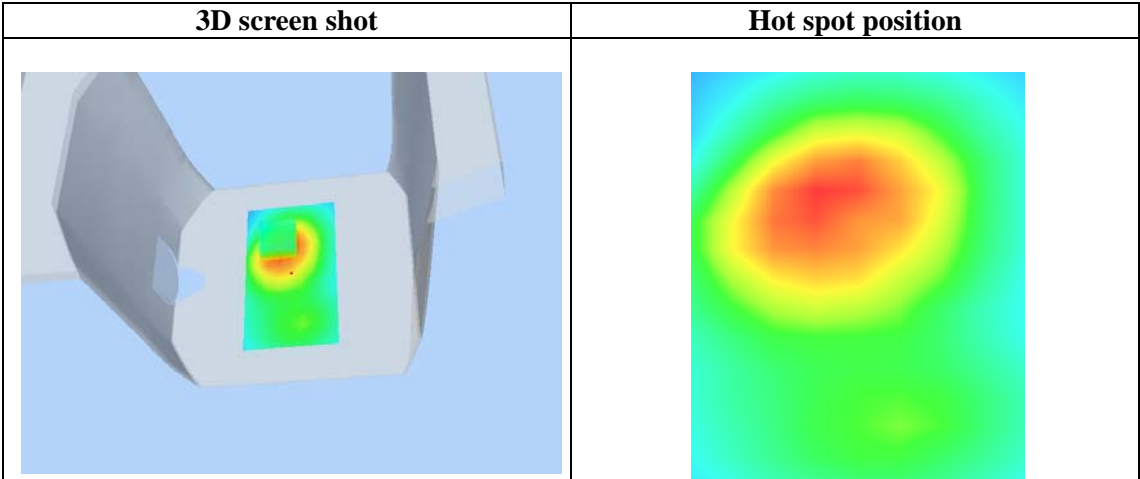
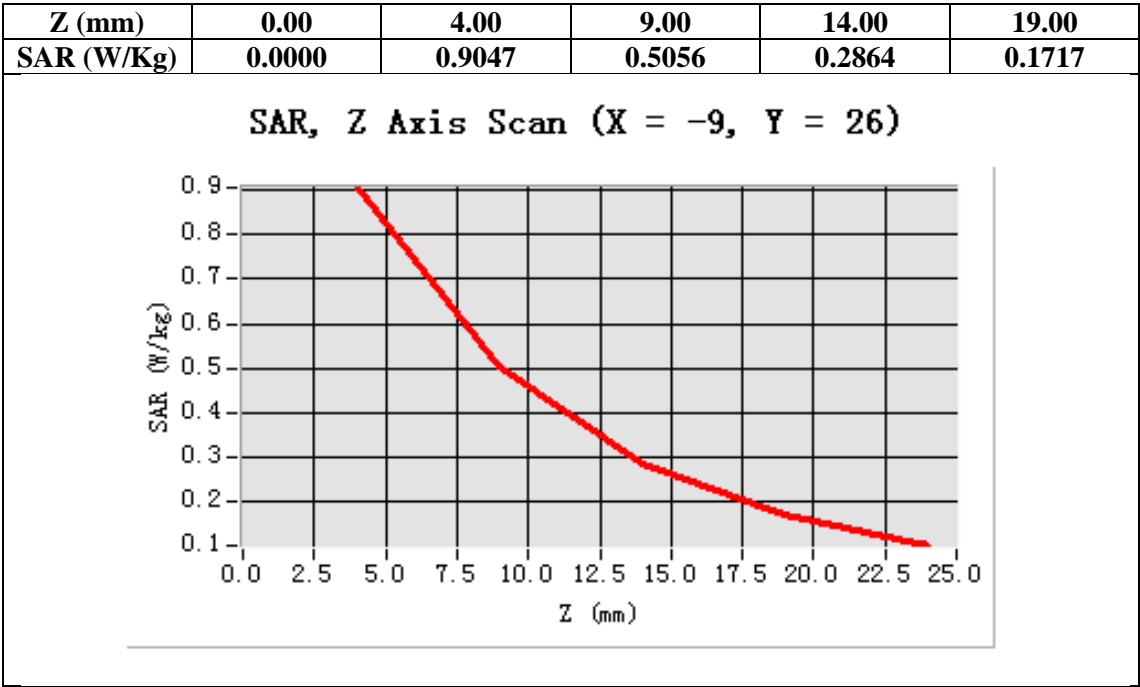

Test Laboratory: AGC Lab
PCS 1900 Low-Body-Back (3up) <SIM 1>

Date: Nov.19,2012

DUT: mobile phone; Type: AM316

Communication System: GPRS-3 Slot; Communication System Band: PCS 1900; Duty Cycle:1:2.8 ; Conv.F=6.42;
Frequency: 1850.2 MHz; Medium parameters used: $f = 1900$ MHz; $\sigma = 1.47$ mho/m; $\epsilon_r = 54.01$

$\rho = 1000$ kg/m³ ;

Phantom section: Flat Section

Ambient temperature (°C): 21.0, Liquid temperature (°C): 21.0

Satimo Configuration:

- Probe:SSE5; Calibrated: 12/09/2011
- Sensor-Surface: 4mm (Mechanical Surface Detection)
- Phantom: SAM1; Type: SAM
- Measurement SW: OpenSAR V4_02_01

Configuration/GPRS1900 Low-Body-Back/Area Scan: Measurement grid: dx=20mm, dy=20mm

Configuration/GPRS1900 Low-Body-Back/Zoom Scan: Measurement grid: dx=8mm, dy=8mm, dz=5mm;

Area Scan	surf_sam_plan.txt
ZoomScan	5x5x7,dx=8mm dy=8mm dz=5mm,Very fast
Phantom	Validation plane
Device Position	Body
Band	GSM1900
Channels	Low
Signal	TDMA (Crest factor: 2.7)

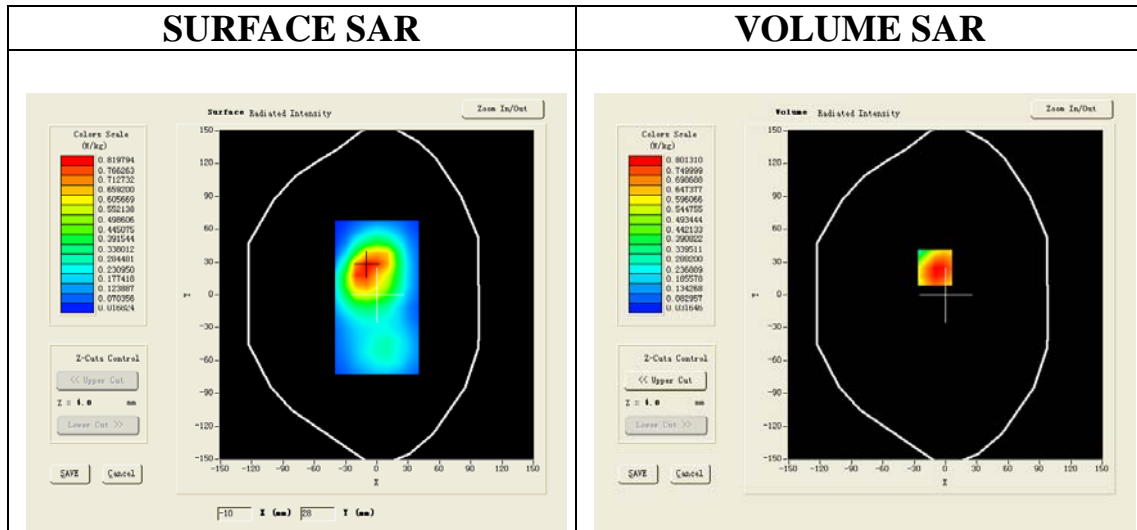

Maximum location: X=-10.00, Y=25.00

SAR 10g (W/Kg)	0.512496
SAR 1g (W/Kg)	0.841209

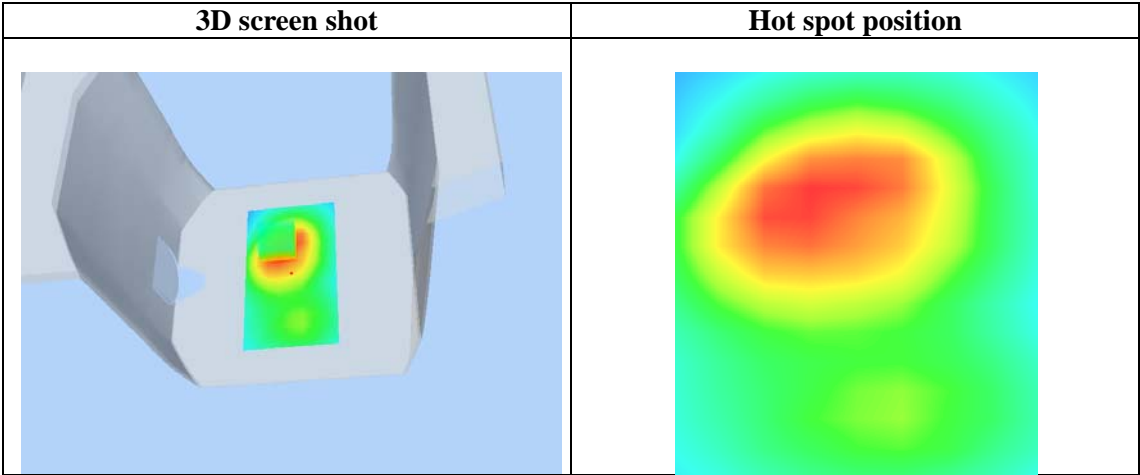
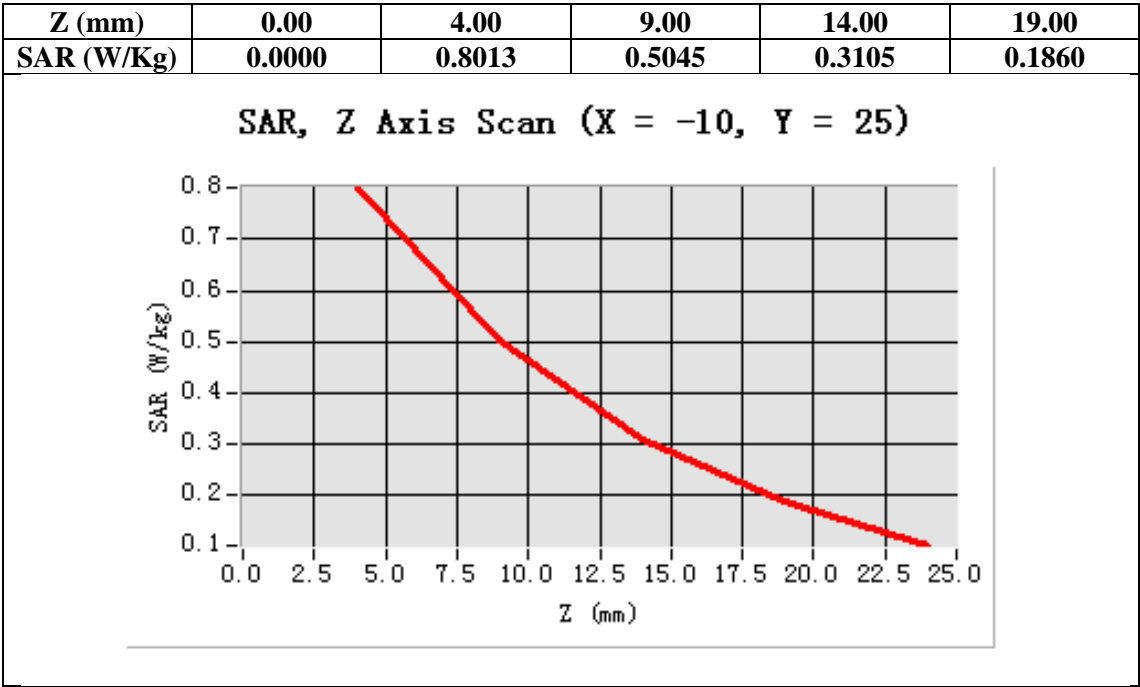

Test Laboratory: AGC Lab
PCS 1900 Mid-Body-Back (3up) <SIM 1>

Date: Nov.19,2012

DUT: mobile phone; Type: AM316

Communication System: GPRS-3 Slot; Communication System Band: PCS 1900; Duty Cycle:1:2.8 ; Conv.F=6.42;
Frequency: 1880 MHz; Medium parameters used: $f = 1900$ MHz; $\sigma = 1.47$ mho/m; $\epsilon_r = 54.01$

$\rho = 1000$ kg/m³ ;

Phantom section: Flat Section

Ambient temperature (°C): 21.0, Liquid temperature (°C): 21.0

Satimo Configuration:

- Probe:SSE5; Calibrated: 12/09/2011
- Sensor-Surface: 4mm (Mechanical Surface Detection)
- Phantom: SAM1; Type: SAM
- Measurement SW: OpenSAR V4_02_01

Configuration/GPRS1900 Mid-Body-Back/Area Scan: Measurement grid: dx=20mm, dy=20mm

Configuration/GPRS1900 Mid-Body-Back/Zoom Scan: Measurement grid: dx=8mm, dy=8mm, dz=5mm;

Area Scan	surf_sam_plan.txt
ZoomScan	5x5x7,dx=8mm dy=8mm dz=5mm,Very fast
Phantom	Validation plane
Device Position	Body
Band	GSM1900
Channels	Middle
Signal	TDMA (Crest factor: 2.7)

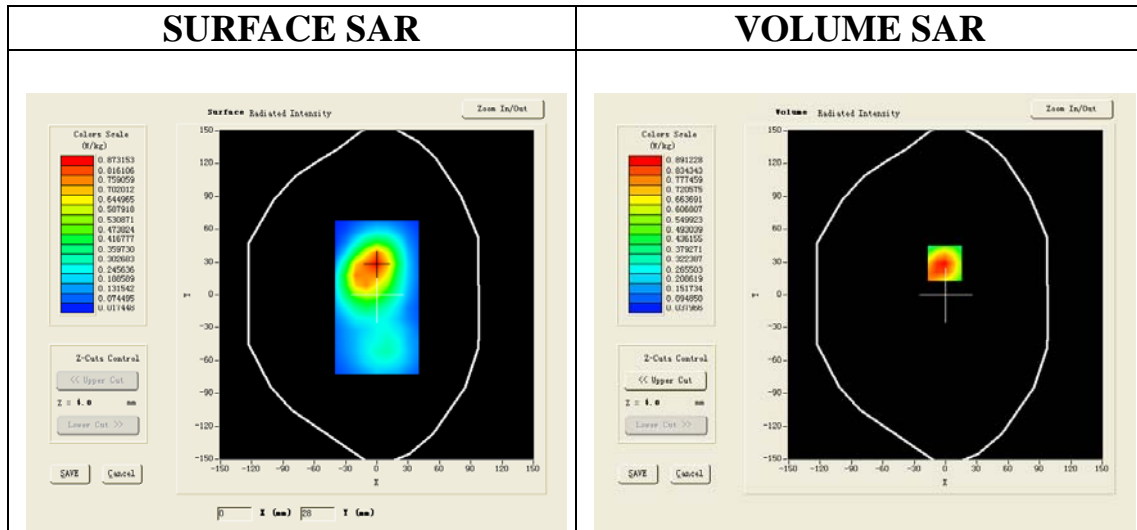

Maximum location: X=-1.00, Y=29.00

SAR 10g (W/Kg)	0.529496
SAR 1g (W/Kg)	0.924574

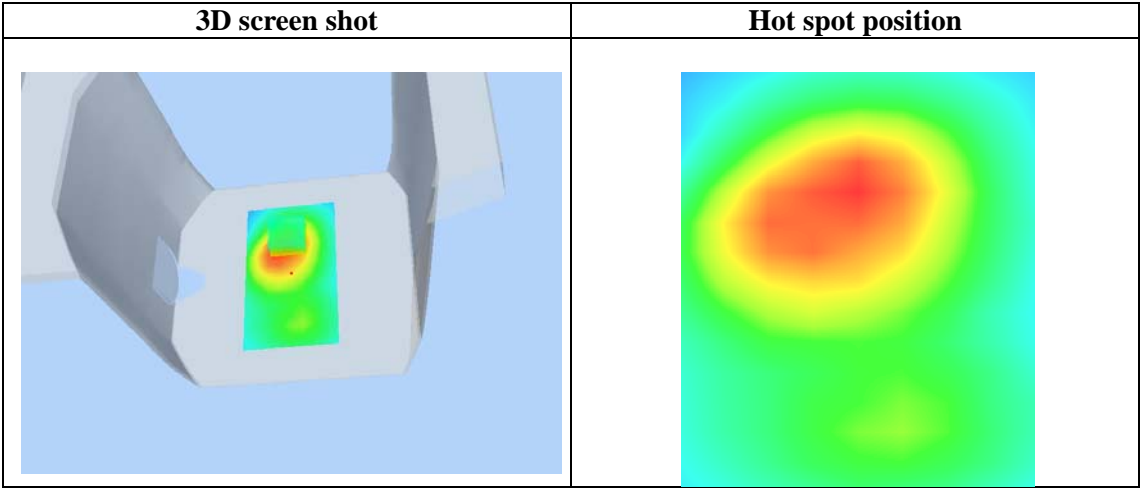
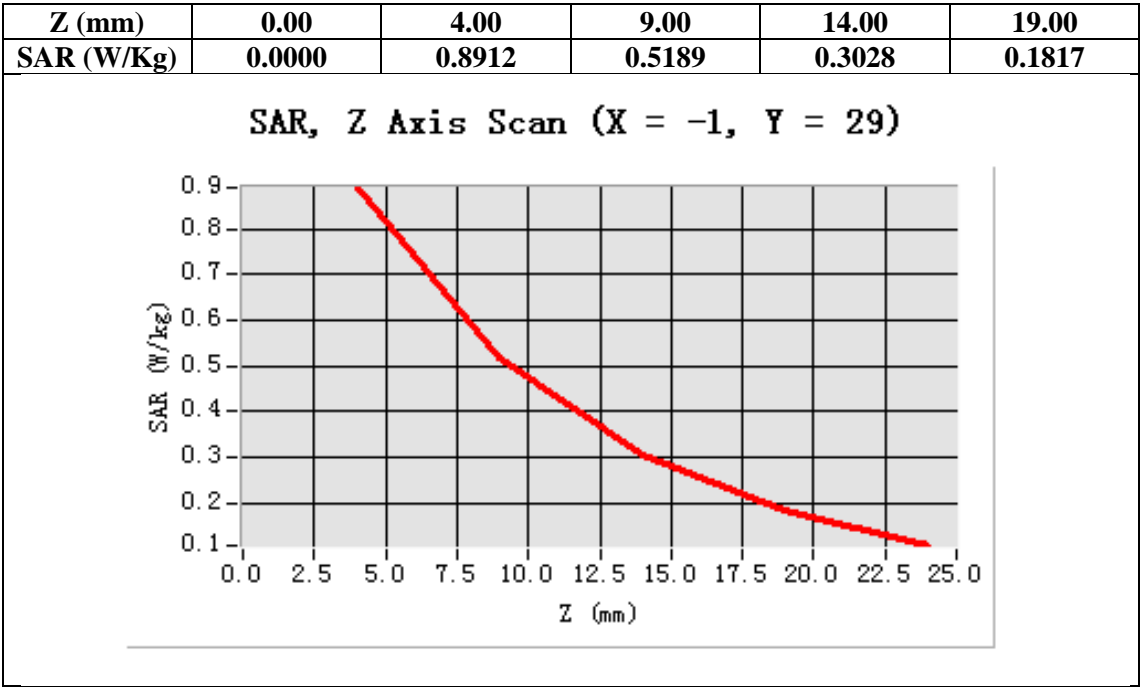

Test Laboratory: AGC Lab
PCS 1900 High-Body-Back (3up) <SIM 1>

Date: Nov.19,2012

DUT: mobile phone; Type: AM316

Communication System: GPRS-3 Slot; Communication System Band: PCS 1900; Duty Cycle:1:2.8 ; Conv.F=6.42;
Frequency: 1909.8 MHz; Medium parameters used: $f = 1900$ MHz; $\sigma = 1.47$ mho/m; $\epsilon_r = 54.01$

$\rho = 1000$ kg/m³ ;

Phantom section: Flat Section

Ambient temperature (°C): 21.0, Liquid temperature (°C): 21.0

Satimo Configuration:

- Probe:SSE5; Calibrated: 12/09/2011
- Sensor-Surface: 4mm (Mechanical Surface Detection)
- Phantom: SAM1; Type: SAM
- Measurement SW: OpenSAR V4_02_01

Configuration/GPRS1900 High-Body-Back/Area Scan: Measurement grid: dx=20mm, dy=20mm

Configuration/GPRS1900 High-Body-Back/Zoom Scan: Measurement grid: dx=8mm, dy=8mm, dz=5mm;

Area Scan	surf_sam_plan.txt
ZoomScan	5x5x7,dx=8mm dy=8mm dz=5mm,Very fast
Phantom	Validation plane
Device Position	Body
Band	GSM1900
Channels	High
Signal	TDMA (Crest factor: 2.7)

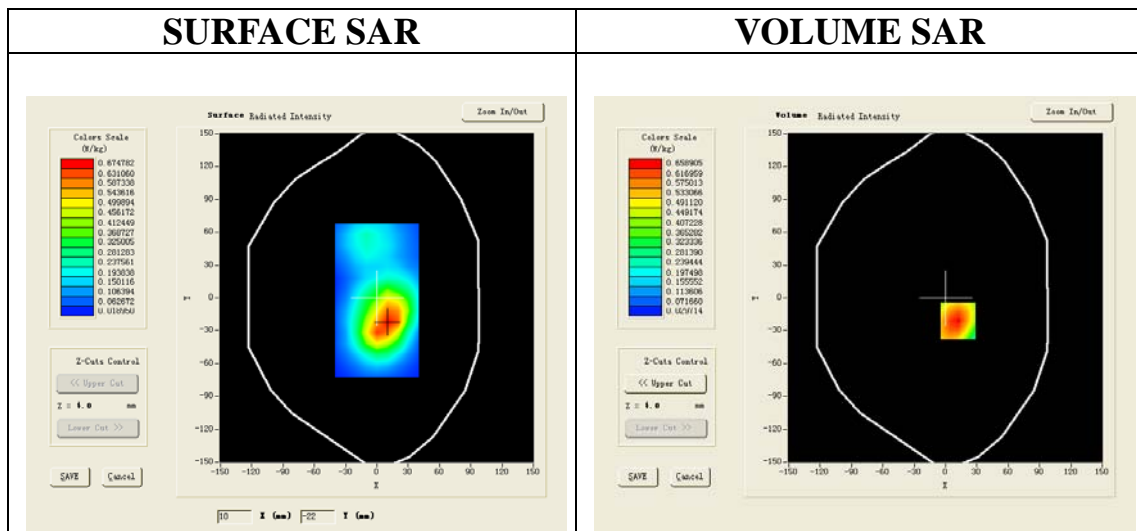

Maximum location: X=12.00, Y=-21.00

SAR 10g (W/Kg)	0.393741
SAR 1g (W/Kg)	0.683458

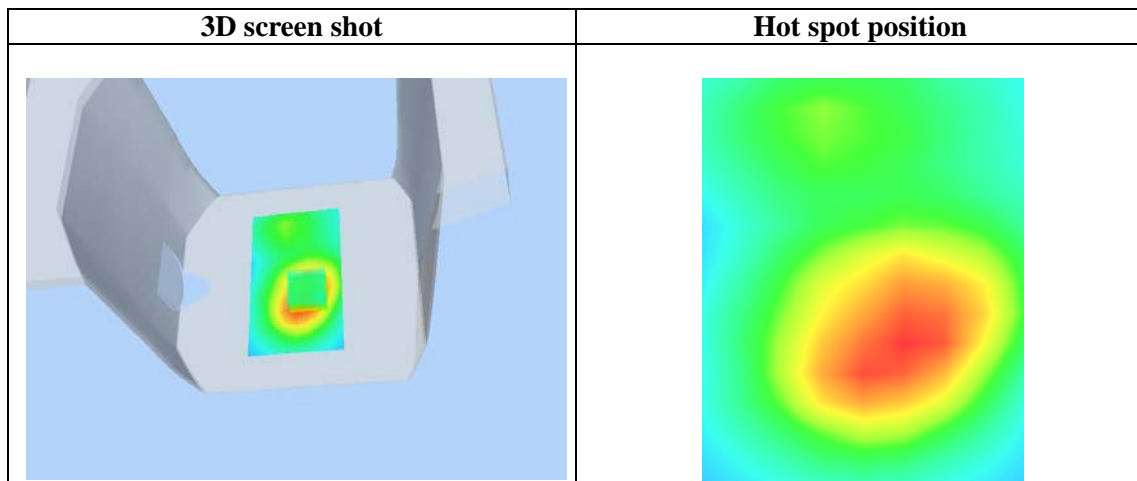
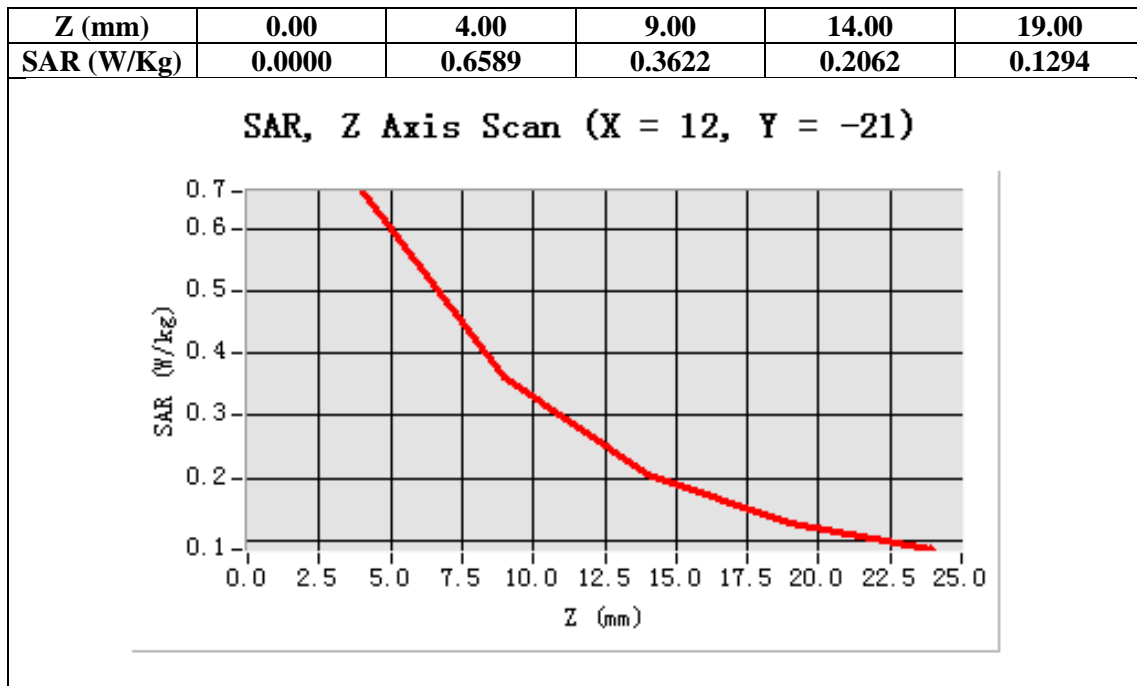

Test Laboratory: AGC Lab
PCS 1900 Mid-Body- Back (4up) <SIM 1>

Date: Nov.19,2012

DUT: mobile phone; Type: AM316

Communication System: GPRS-4 Slot; Communication System Band: PCS 1900; Duty Cycle:1:2.1 ;
Conv.F=6.42;Frequency: 1880 MHz; Medium parameters used: $f = 1900$ MHz; $\sigma = 1.47$ mho/m; $\epsilon_r = 54.01$;
 $\rho = 1000$ kg/m³ ;

Phantom section: Flat Section

Ambient temperature (°C): 21.0, Liquid temperature (°C): 21.0

Satimo Configuration:

- Probe:SSE5; Calibrated: 12/09/2011
- Sensor-Surface: 4mm (Mechanical Surface Detection)
- Phantom: SAM1; Type: SAM
- Measurement SW: OpenSAR V4_02_01

Configuration/GPRS1900 Mid-Body-Back/Area Scan: Measurement grid: dx=20mm, dy=20mm

Configuration/GPRS1900 Mid-Body-Back/Zoom Scan: Measurement grid: dx=8mm, dy=8mm, dz=5mm;

Area Scan	surf_sam_plan.txt
ZoomScan	5x5x7,dx=8mm dy=8mm dz=5mm,Very fast
Phantom	Validation plane
Device Position	Body
Band	GSM1900
Channels	Middle
Signal	TDMA (Crest factor: 2.0)

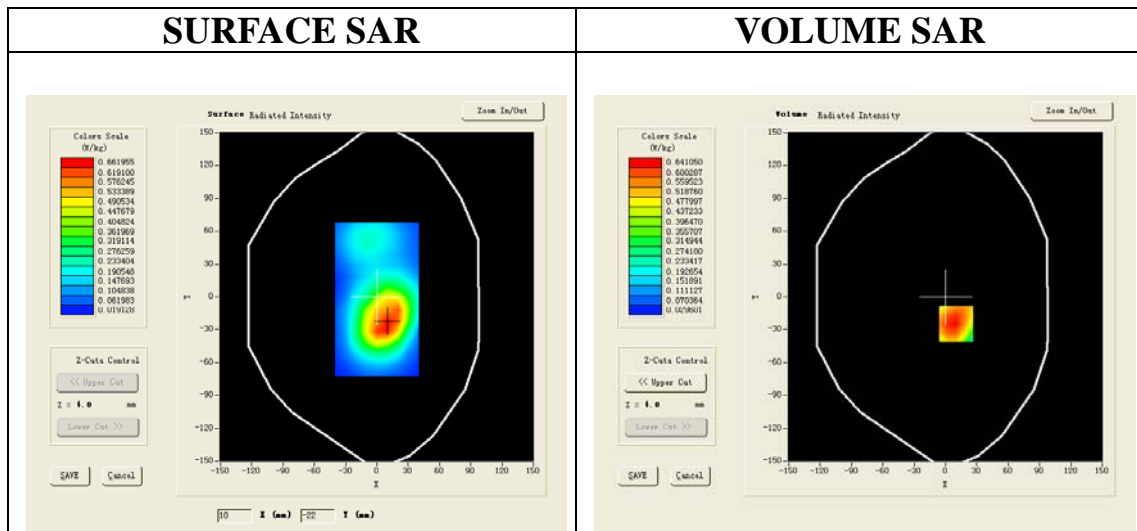

Maximum location: X=10.00, Y=-25.00

SAR 10g (W/Kg)	0.401576
SAR 1g (W/Kg)	0.667880

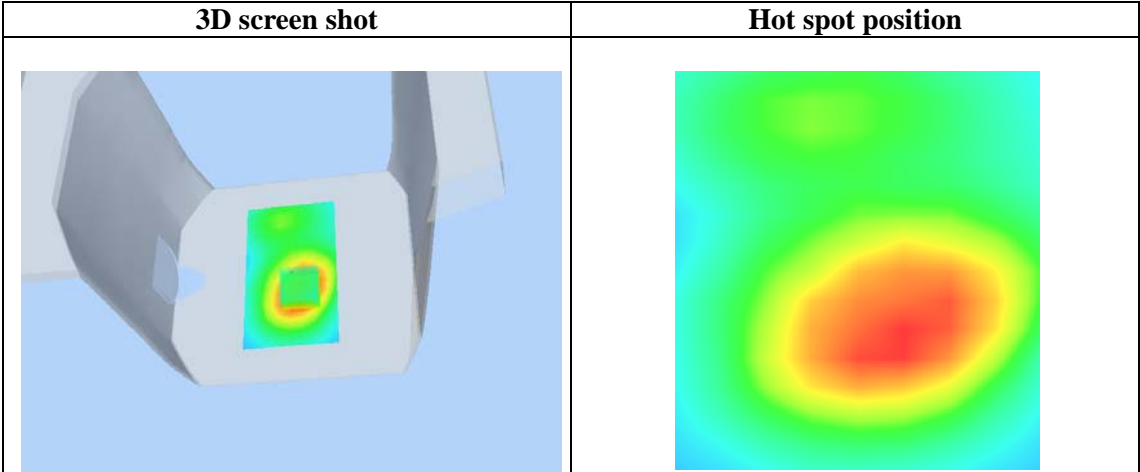
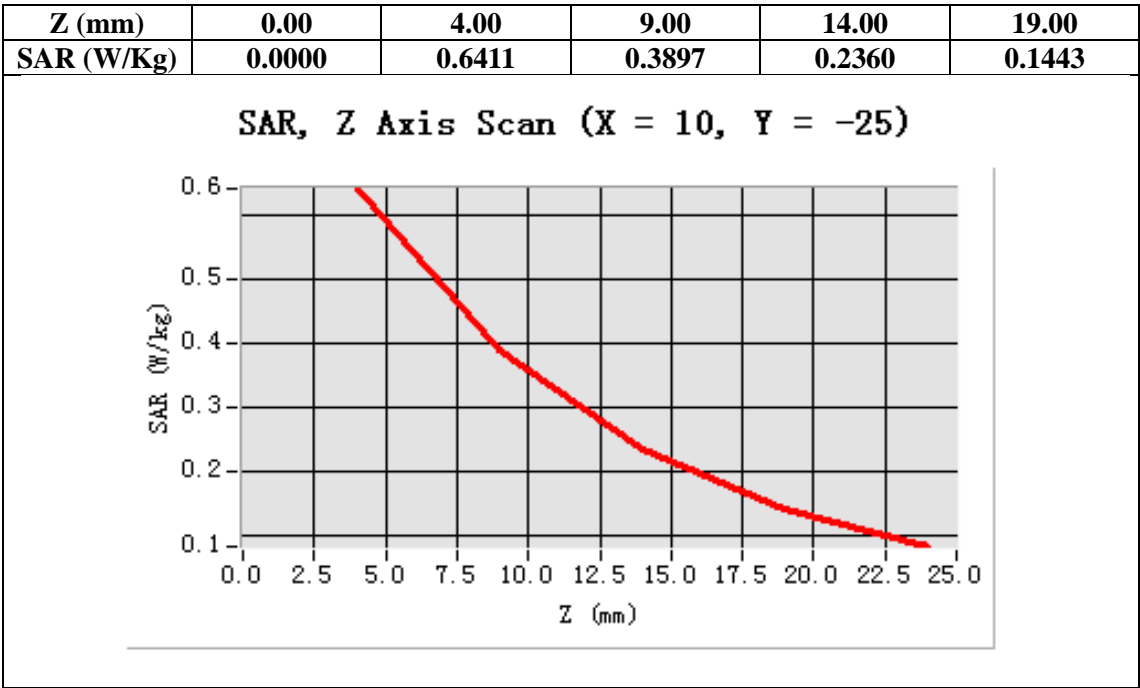

Test Laboratory: AGC Lab
PCS 1900 Mid-Body -Front (2up) <SIM 1>

Date: Nov.19,2012

DUT: mobile phone; Type: AM316

Communication System: GPRS-2 Slot; Communication System Band: PCS 1900; Duty Cycle: 1:4.2;
Conv.F=6.42; Frequency: 1880 MHz; Medium parameters used: $f = 1900$ MHz; $\sigma = 1.47$ mho/m; $\epsilon_r = 54.01$;
 $\rho = 1000$ kg/m³ ;
Phantom section: Flat Section
Ambient temperature (°C): 21.0, Liquid temperature (°C): 21.0

Satimo Configuration:

- Probe:SSE5; Calibrated: 12/09/2011
- Sensor-Surface: 4mm (Mechanical Surface Detection)
- Phantom: SAM1; Type: SAM
- Measurement SW: OpenSAR V4_02_01

Configuration/PCS1900 Mid-Body- Front /Area Scan: Measurement grid: dx=20mm, dy=20mm
Configuration/PCS1900 Mid-Body- Front /Zoom Scan: Measurement grid: dx=8mm,
dy=8mm, dz=5mm;

Area Scan	surf_sam_plan.txt
ZoomScan	5x5x7,dx=8mm dy=8mm dz=5mm,Very fast
Phantom	Validation plane
Device Position	Body
Band	GSM1900
Channels	Middle
Signal	TDMA (Crest factor: 4.0)

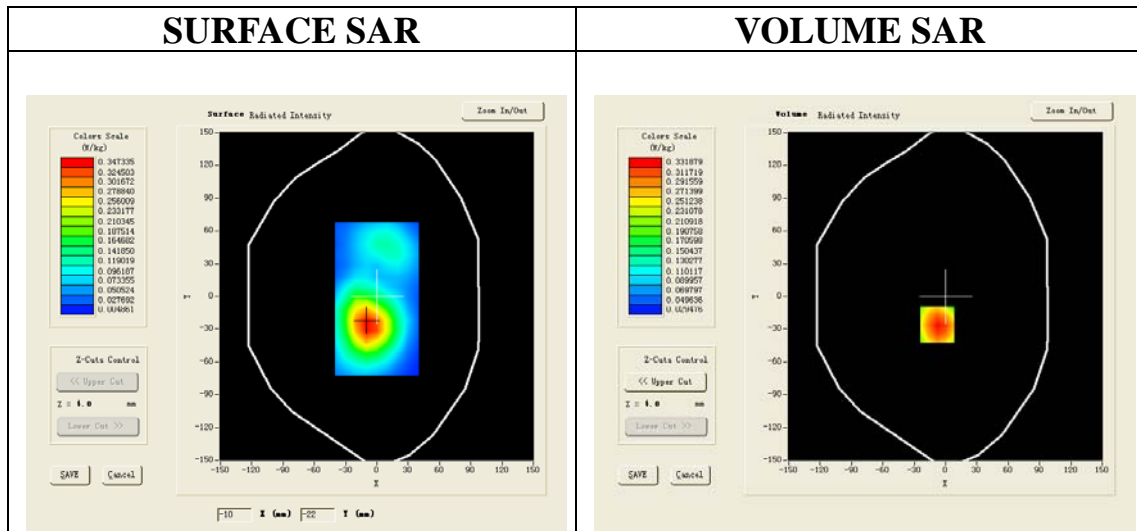

Maximum location: X=-8.00, Y=-26.00

SAR 10g (W/Kg)	0.210144
SAR 1g (W/Kg)	0.343501

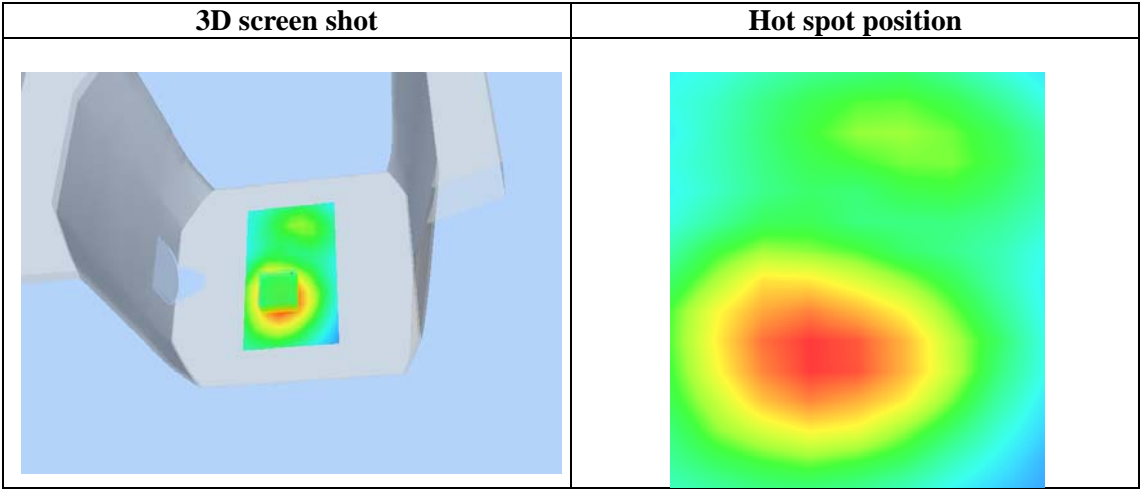
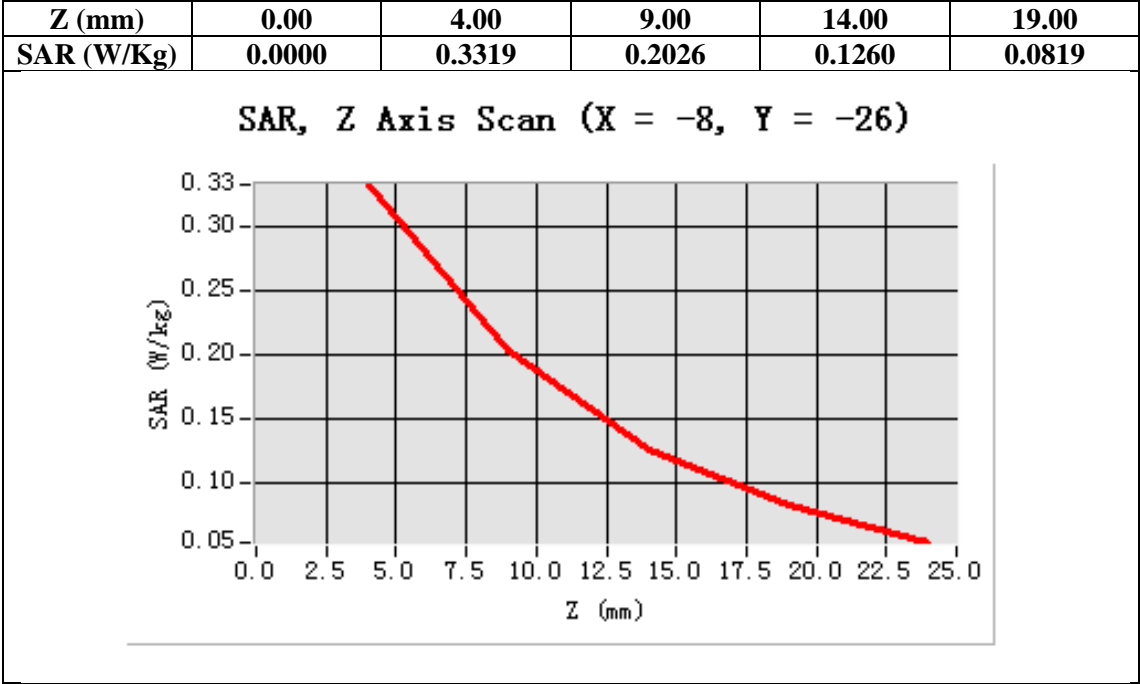

Test Laboratory: AGC Lab
PCS 1900 Low-Body- Back (2up) <SIM 1>

Date: Nov.19,2012

DUT: mobile phone; Type: AM316

Communication System: GPRS-2 Slot; Communication System Band: PCS 1900; Duty Cycle: 1:4.2;
Conv.F=6.42; Frequency: 1850.2 MHz; Medium parameters used: $f = 1900$ MHz; $\sigma = 1.47$ mho/m; $\epsilon_r = 54.01$;
 $\rho = 1000$ kg/m³ ;
Phantom section: Flat Section
Ambient temperature (°C): 21.0, Liquid temperature (°C): 21.0

Satimo Configuration:

- Probe:SSE5; Calibrated: 12/09/2011
- Sensor-Surface: 4mm (Mechanical Surface Detection)
- Phantom: SAM1; Type: SAM
- Measurement SW: OpenSAR V4_02_01

Configuration/PCS1900 Low-Body-Back/Area Scan: Measurement grid: dx=20mm, dy=20mm

Configuration/PCS1900 Low-Body-Back/Zoom Scan: Measurement grid: dx=8mm, dy=8mm, dz=5mm;

Area Scan	surf_sam_plan.txt
ZoomScan	5x5x7,dx=8mm dy=8mm dz=5mm,Very fast
Phantom	Validation plane
Device Position	Body
Band	GSM1900
Channels	Low
Signal	TDMA (Crest factor: 4.0)

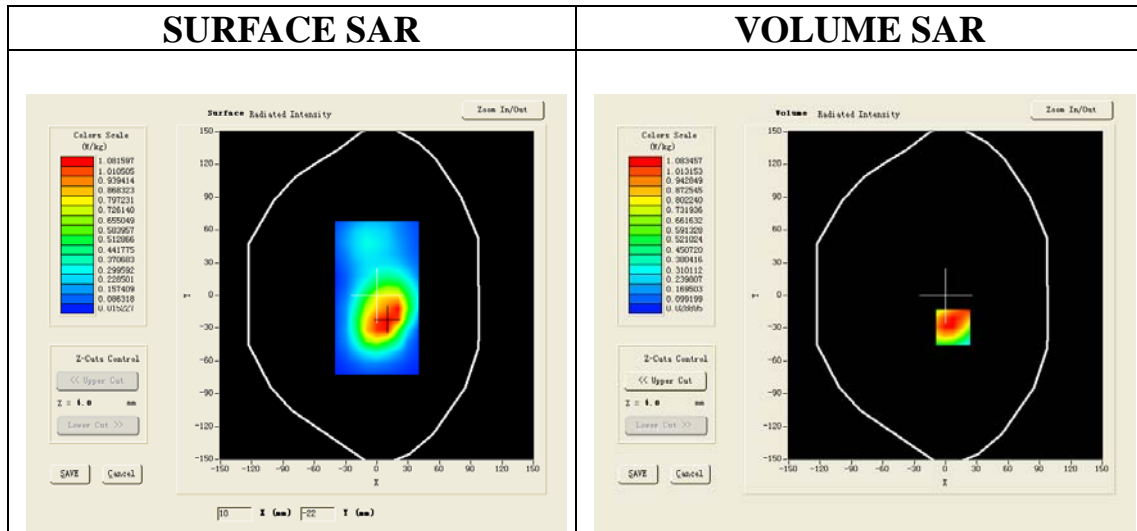

Maximum location: X=7.00, Y=-29.00

SAR 10g (W/Kg)	0.665801
SAR 1g (W/Kg)	1.147958

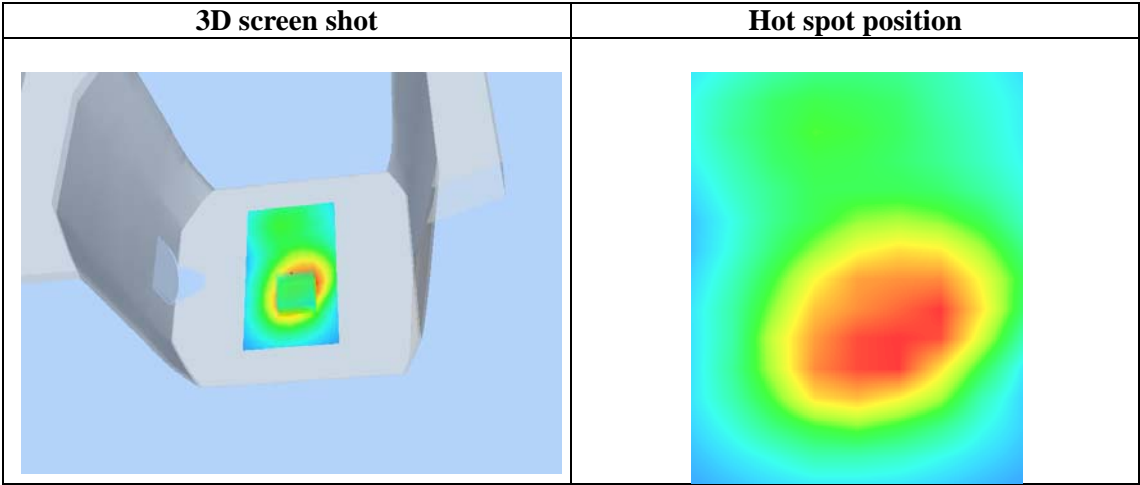
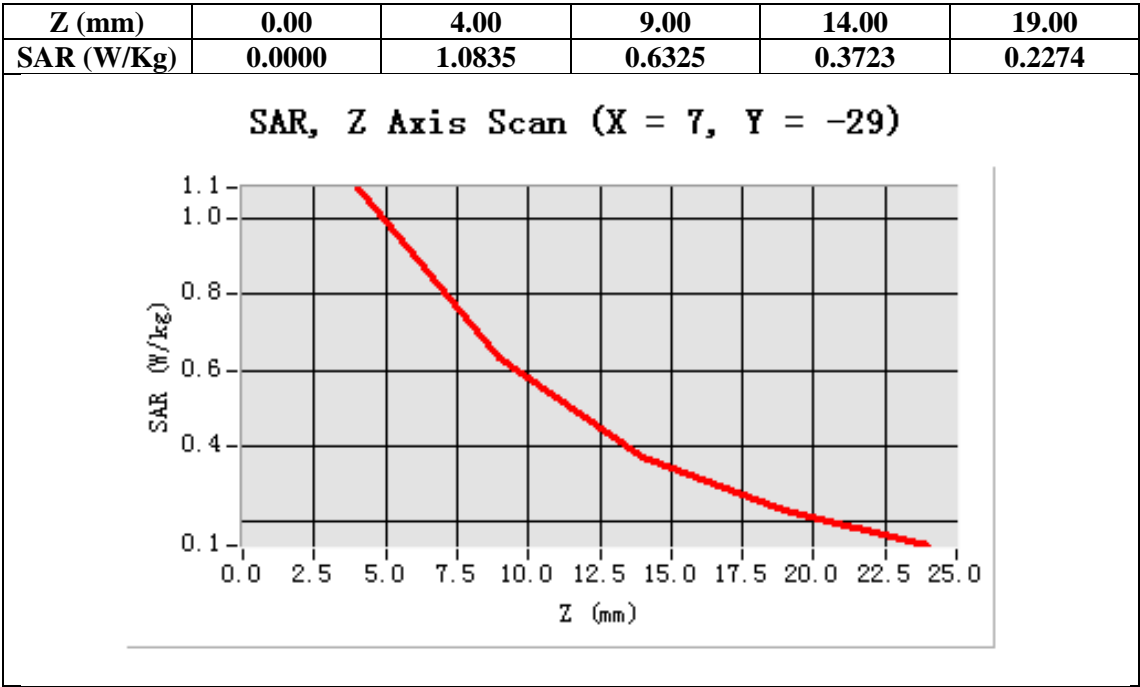

Test Laboratory: AGC Lab
PCS 1900 Mid-Body- Back (2up) <SIM 1>

Date: Nov.19,2012

DUT: mobile phone; Type: AM316

Communication System: GPRS-2 Slot; Communication System Band: PCS 1900; Duty Cycle: 1:4.2;
Conv.F=6.42; Frequency: 1880 MHz; Medium parameters used: $f = 1900$ MHz; $\sigma = 1.47$ mho/m; $\epsilon_r = 54.01$;
 $\rho = 1000$ kg/m³ ;
Phantom section: Flat Section
Ambient temperature (°C): 21.0, Liquid temperature (°C): 21.0

Satimo Configuration:

- Probe:SSE5; Calibrated: 12/09/2011
- Sensor-Surface: 4mm (Mechanical Surface Detection)
- Phantom: SAM1; Type: SAM
- Measurement SW: OpenSAR V4_02_01

Configuration/PCS1900 Mid-Body-Back/Area Scan: Measurement grid: dx=20mm, dy=20mm

Configuration/PCS1900 Mid-Body-Back/Zoom Scan: Measurement grid: dx=8mm, dy=8mm, dz=5mm;

Area Scan	surf_sam_plan.txt
ZoomScan	5x5x7,dx=8mm dy=8mm dz=5mm,Very fast
Phantom	Validation plane
Device Position	Body
Band	GSM1900
Channels	Middle
Signal	TDMA (Crest factor: 4.0)

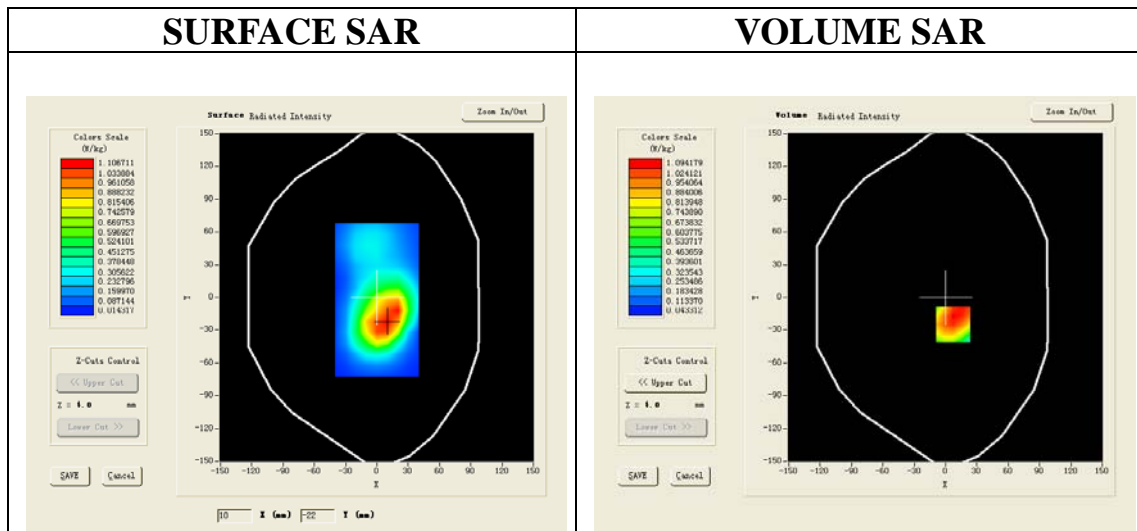

Maximum location: X=7.00, Y=-25.00

SAR 10g (W/Kg)	0.690972
SAR 1g (W/Kg)	1.137310

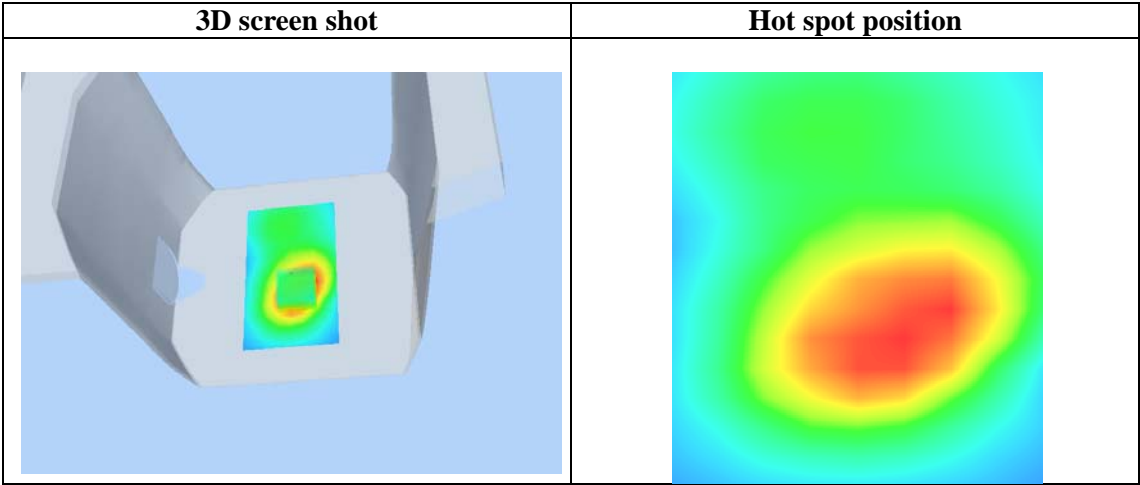
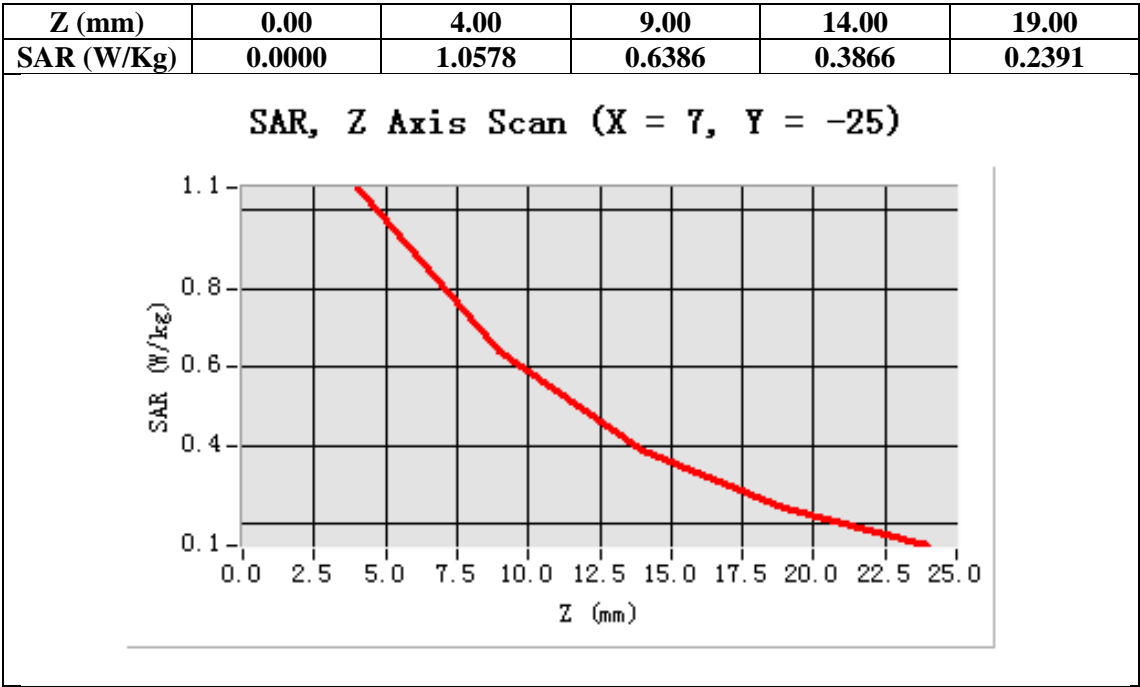

Test Laboratory: AGC Lab
PCS 1900 High-Body- Back (2up) <SIM 1>

Date: Nov.19,2012

DUT: mobile phone; Type: AM316

Communication System: GPRS-2 Slot; Communication System Band: PCS 1900; Duty Cycle: 1:4.2;
Conv.F=6.42; Frequency: 1909.8 MHz; Medium parameters used: $f = 1900$ MHz; $\sigma = 1.47$ mho/m; $\epsilon_r = 54.01$;
 $\rho = 1000$ kg/m³ ;
Phantom section: Flat Section
Ambient temperature (°C): 21.0, Liquid temperature (°C): 21.0

Satimo Configuration:

- Probe:SSE5; Calibrated: 12/09/2011
- Sensor-Surface: 4mm (Mechanical Surface Detection)
- Phantom: SAM1; Type: SAM
- Measurement SW: OpenSAR V4_02_01

Configuration/PCS1900 High-Body-Back/Area Scan: Measurement grid: dx=20mm, dy=20mm

Configuration/PCS1900 High-Body-Back/Zoom Scan: Measurement grid: dx=8mm, dy=8mm, dz=5mm;

Area Scan	surf_sam_plan.txt
ZoomScan	5x5x7,dx=8mm dy=8mm dz=5mm,Very fast
Phantom	Validation plane
Device Position	Body
Band	GSM1900
Channels	High
Signal	TDMA (Crest factor: 4.0)

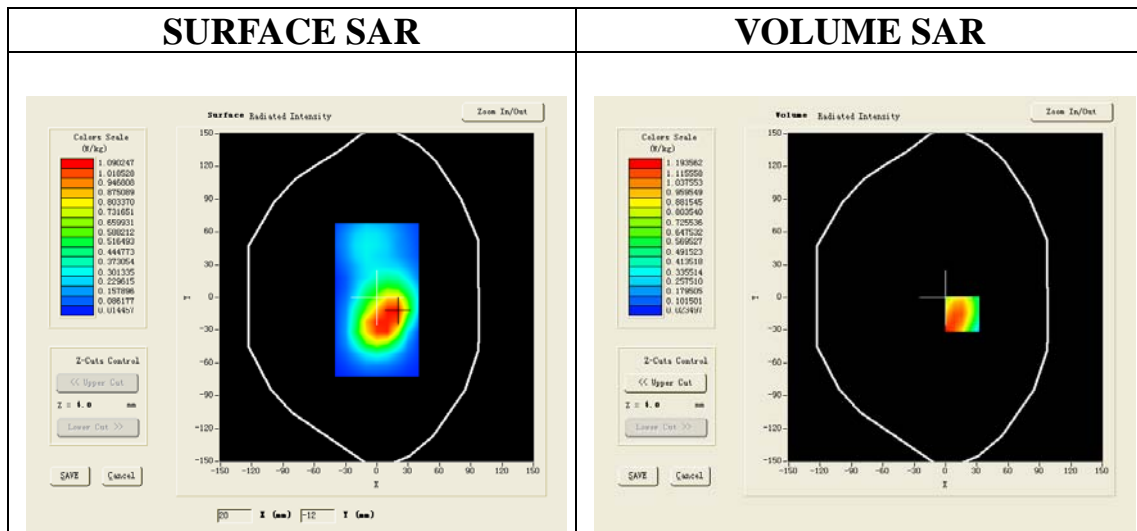

Maximum location: X=16.00, Y=-15.00

SAR 10g (W/Kg)	0.688106
SAR 1g (W/Kg)	1.180645

