

FCC REPORT

Applicant: AMGOO TELECOM (Shenzhen) CO.,LTD

Address of Applicant: 3/F, Block R2-A(North), Gaoxin S. Ave. 4th,Hi-Tech Industrial Park, Nanshan District, Shenzhen, China

Equipment Under Test (EUT)

Product Name: Mobile Phone

Model No.: AM102, AM102C

Trade mark AMGOO

FCC ID: UOS-AM102

Applicable standards: FCC CFR Title 47 Part 15 Subpart C Section 15.247

Date of sample receipt: 09 Jul., 2014

Date of Test: 09 Jul., to 01 Aug., 2014

Date of report issued: 31 Jul., 2014

Test Result: PASS *

* In the configuration tested, the EUT complied with the standards specified above.

Authorized Signature:



Bruce Zhang
Laboratory Manager

This report details the results of the testing carried out on one sample. The results contained in this test report do not relate to other samples of the same product and does not permit the use of the CCIS product certification mark. The manufacturer should ensure that all products in series production are in conformity with the product sample detailed in this report.

This report may only be reproduced and distributed in full. If the product in this report is used in any configuration other than that detailed in the report, the manufacturer must ensure the new system complies with all relevant standards.

This document cannot be reproduced except in full, without prior written approval of the Company. Any unauthorized alteration, forgery or falsification of the content or appearance of this document is unlawful and offenders may be prosecuted to the fullest extent of the law. Unless otherwise stated the results shown in this test report refer only to the sample(s) tested and such sample(s) are retained for 90 days only.

2 Version

Version No.	Date	Description
00	01 Aug., 2014	Original

Prepared by:

Sera Xiang

Report Clerk

Date:

01 Aug., 2014

Reviewed by:

Gaven Liu

Project Engineer

Date:

01 Aug., 2014

3 Contents

Page

1	COVER PAGE	1
2	VERSION	2
3	CONTENTS	3
4	TEST SUMMARY	4
5	GENERAL INFORMATION	5
5.1	CLIENT INFORMATION	5
5.2	GENERAL DESCRIPTION OF E.U.T.	5
5.3	TEST MODE	7
5.4	LABORATORY FACILITY	7
5.5	LABORATORY LOCATION	7
5.6	TEST INSTRUMENTS LIST.....	8
6	TEST RESULTS AND MEASUREMENT DATA	9
6.1	ANTENNA REQUIREMENT	9
6.2	CONDUCTED EMISSIONS	10
6.3	CONDUCTED OUTPUT POWER.....	13
6.4	20DB OCCUPY BANDWIDTH.....	17
6.5	CARRIER FREQUENCIES SEPARATION.....	21
6.6	HOPPING CHANNEL NUMBER	26
6.7	DWELL TIME.....	28
6.8	PSEUDORANDOM FREQUENCY HOPPING SEQUENCE	32
6.9	BAND EDGE.....	33
6.9.1	Conducted Emission Method.....	33
6.9.2	Radiated Emission Method.....	37
6.10	SPURIOUS EMISSION	50
6.10.1	Conducted Emission Method.....	50
6.10.2	Radiated Emission Method	54
7	TEST SETUP PHOTO	60
8	EUT CONSTRUCTIONAL DETAILS	61

4 Test Summary

Test Item	Section in CFR 47	Result
Antenna Requirement	15.203/15.247 (c)	Pass
AC Power Line Conducted Emission	15.207	Pass
Conducted Peak Output Power	15.247 (b)(1)	Pass
20dB Occupied Bandwidth	15.247 (a)(1)	Pass
Carrier Frequencies Separation	15.247 (a)(1)	Pass
Hopping Channel Number	15.247 (a)(1)	Pass
Dwell Time	15.247 (a)(1)	Pass
Radiated Emission	15.205/15.209	Pass
Band Edge	15.247(d)	Pass

Pass: The EUT complies with the essential requirements in the standard.

5 General Information

5.1 Client Information

Applicant:	AMGOO TELECOM (Shenzhen) CO.,LTD
Address of Applicant:	3/F, Block R2-A(North), Gaoxin S. Ave. 4th, Hi-Tech Industrial Park, Nanshan District, Shenzhen, China
Manufacturer :	AMGOO TELECOM (Shenzhen) CO.,LTD
Address of Manufacturer:	3/F, Block R2-A(North), Gaoxin S. Ave. 4th, Hi-Tech Industrial Park, Nanshan District, Shenzhen, China

5.2 General Description of E.U.T.

Product Name:	Mobile Phone
Model No.:	AM102, AM102C
Operation Frequency:	2402MHz~2480MHz
Transfer rate:	1/2/3 Mbits/s
Number of channel:	79
Modulation type:	GFSK, $\pi/4$ -DQPSK, 8DPSK
Modulation technology:	FHSS
Antenna Type:	Internal Antenna
Antenna gain:	-0.56 dBi
Power supply:	Rechargeable Li-ion Battery DC3.7V-450mAh
AC adapter:	Model: CH15 Input: AC 100-240V 50/60Hz 0.15A Output: DC 5V, 500mA
Remark:	Item No.:AM102, AM102C were identical inside, the electrical circuit design, layout, components used and internal wiring, with only difference being AM102C than AM102 arear camera.

Operation Frequency each of channel for GFSK, $\pi/4$ -DQPSK, 8DPSK							
Channel	Frequency	Channel	Frequency	Channel	Frequency	Channel	Frequency
0	2402MHz	20	2422MHz	40	2442MHz	60	2462MHz
1	2403MHz	21	2423MHz	41	2443MHz	61	2463MHz
2	2404MHz	22	2424MHz	42	2444MHz	62	2464MHz
3	2405MHz	23	2425MHz	43	2445MHz	63	2465MHz
4	2406MHz	24	2426MHz	44	2446MHz	64	2466MHz
5	2407MHz	25	2427MHz	45	2447MHz	65	2467MHz
6	2408MHz	26	2428MHz	46	2448MHz	66	2468MHz
7	2409MHz	27	2429MHz	47	2449MHz	67	2469MHz
8	2410MHz	28	2430MHz	48	2450MHz	68	2470MHz
9	2411MHz	29	2431MHz	49	2451MHz	69	2471MHz
10	2412MHz	30	2432MHz	50	2452MHz	70	2472MHz
11	2413MHz	31	2433MHz	51	2453MHz	71	2473MHz
12	2414MHz	32	2434MHz	52	2454MHz	72	2474MHz
13	2415MHz	33	2435MHz	53	2455MHz	73	2475MHz
14	2416MHz	34	2436MHz	54	2456MHz	74	2476MHz
15	2417MHz	35	2437MHz	55	2457MHz	75	2477MHz
16	2418MHz	36	2438MHz	56	2458MHz	76	2478MHz
17	2419MHz	37	2439MHz	57	2459MHz	77	2479MHz
18	2420MHz	38	2440MHz	58	2460MHz	78	2480MHz
19	2421MHz	39	2441MHz	59	2461MHz		

Remark: Channel 0, 39 & 78 selected for GFSK, $\pi/4$ -DQPSK and 8DPSK.

5.3 Test mode

Transmitting mode:	Keep the EUT in transmitting mode with worst case data rate.
Remark	GFSK (1 Mbps) is the worst case mode.
<p>The sample was placed 0.8m above the ground plane of 3m chamber*. Measurements in both horizontal and vertical polarities were performed. During the test, each emission was maximized by: having the EUT continuously working with a fresh battery, investigated all operating modes, rotated about all 3 axis (X, Y & Z) and considered typical configuration to obtain worst position, manipulating interconnecting cables, rotating the turntable, varying antenna height from 1m to 4m in both horizontal and vertical polarizations. The emissions worst-case are shown in Test Results of the following pages.</p>	

5.4 Laboratory Facility

<p>The test facility is recognized, certified, or accredited by the following organizations:</p> <ul style="list-style-type: none"> ● FCC - Registration No.: 817957 Shenzhen Zhongjian Nanfang Testing Co., Ltd. EMC Laboratory has been registered and fully described in a report filed with the (FCC) Federal Communications Commission. The acceptance letter from the FCC is maintained in our files. Registration 817957, February 27, 2012. ● IC - Registration No.: 10106A-1 The 3m Semi-anechoic chamber of Shenzhen Zhongjian Nanfang Testing Co., Ltd. has been Registered by Certification and Engineering Bureau of Industry Canada for radio equipment testing with Registration No.: 10106A-1. ● CNAS - Registration No.: CNAS L6048 Shenzhen Zhongjian Nanfang Testing Co., Ltd. is accredited to ISO/IEC 17025:2005 General Requirements for the Competence of Testing and Calibration laboratories for the competence of testing. The Registration No. is CNAS L6048.
--

5.5 Laboratory Location

<p>Shenzhen Zhongjian Nanfang Testing Co., Ltd. Address: No. B-C, 1/F., Building 2, Laodong No.2 Industrial Park, Xixiang Road, Bao'an District, Shenzhen, Guangdong, China Tel: +86-755-23118282 Fax: +86-755-23116366</p>

5.6 Test Instruments list

Radiated Emission:						
Item	Test Equipment	Manufacturer	Model No.	Inventory No.	Cal. Date (mm-dd-yy)	Cal. Due date (mm-dd-yy)
1	3m Semi- Anechoic Chamber	SAEMC	9(L)*6(W)* 6(H)	CCIS0001	July 09 2014	July 08 2015
2	BiConiLog Antenna	SCHWARZBECK MESS-ELEKTRONIK	VULB9163	CCIS0005	Jun., 25 2014	Jun., 24 2015
3	Double -ridged waveguide horn	SCHWARZBECK MESS-ELEKTRONIK	BBHA9120D	CCIS0006	Jun., 25 2014	Jun., 24 2015
4	EMI Test Software	AUDIX	E3	N/A	N/A	N/A
5	Coaxial Cable	CCIS	N/A	CCIS0016	Apr. 01 2014	Mar. 31 2015
6	Coaxial Cable	CCIS	N/A	CCIS0017	Apr. 01 2014	Mar. 31 2015
7	Coaxial cable	CCIS	N/A	CCIS0018	Apr. 01 2014	Mar. 31 2015
8	Coaxial Cable	CCIS	N/A	CCIS0019	Apr. 01 2014	Mar. 31 2015
9	Coaxial Cable	CCIS	N/A	CCIS0087	Apr. 01 2014	Mar. 31 2015
10	Amplifier(10kHz-1.3GHz)	HP	8447D	CCIS0003	Apr. 01 2014	Mar. 31 2015
11	Amplifier(1GHz-18GHz)	Compliance Direction Systems Inc.	PAP-1G18	CCIS0011	July 09 2014	July 08 2015
12	Pre-amplifier (18-26GHz)	Rohde & Schwarz	AFS33-18002 650-30-8P-44	GTS218	Apr. 01 2014	Mar. 31 2015
13	Horn Antenna	ETS-LINDGREN	3160	GTS217	Mar. 30 2014	Mar. 29 2015
14	Printer	HP	HP LaserJet P1007	N/A	N/A	N/A
15	Positioning Controller	UC	UC3000	CCIS0015	N/A	N/A
16	Spectrum analyzer 9k-30GHz	Rohde & Schwarz	FSP	CCIS0023	May. 25 2014	May. 24 2015
17	EMI Test Receiver	Rohde & Schwarz	ESPI	CCIS0022	Apr 01 2014	Mar. 31 2015
18	Loop antenna	Laplace instrument	RF300	EMC0701	Aug. 12 2013	Aug. 11 2014
19	Universal radio communication tester	Rhode & Schwarz	CMU200	CCIS0069	Jun., 25 2014	Jun., 24 2015
20	Signal Analyzer	Rohde & Schwarz	FSIQ3	CCIS0088	Jun., 25 2014	Jun., 24 2015

Conducted Emission:						
Item	Test Equipment	Manufacturer	Model No.	Inventory No.	Cal. Date (mm-dd-yy)	Cal. Due date (mm-dd-yy)
1	Shielding Room	ZhongShuo Electron	11.0(L)x4.0(W)x3.0(H)	CCIS0061	July 09 2014	July 08 2015
2	EMI Test Receiver	Rohde & Schwarz	ESCI	CCIS0002	Jun., 25 2014	Jun., 24 2015
3	LISN	CHASE	MN2050D	CCIS0074	Apr 01 2014	Mar. 31 2015
4	Coaxial Cable	CCIS	N/A	CCIS0086	Apr. 01 2014	Mar. 31 2015
5	EMI Test Software	AUDIX	E3	N/A	N/A	N/A

6 Test results and Measurement Data

6.1 Antenna requirement

Standard requirement:	FCC Part15 C Section 15.203 /247(c)
<p><i>15.203 requirement:</i> <i>An intentional radiator shall be designed to ensure that no antenna other than that furnished by the responsible party shall be used with the device. The use of a permanently attached antenna or of an antenna that uses a unique coupling to the intentional radiator, the manufacturer may design the unit so that a broken antenna can be replaced by the user, but the use of a standard antenna jack or electrical connector is prohibited.</i></p> <p><i>15.247(c) (1)(i) requirement:</i> <i>(i) Systems operating in the 2400-2483.5 MHz band that is used exclusively for fixed. Point-to-point operations may employ transmitting antennas with directional gain greater than 6dBi provided the maximum conducted output power of the intentional radiator is reduced by 1 dB for every 3 dB that the directional gain of the antenna exceeds 6dBi.</i></p>	
E.U.T Antenna:	
<p><i>The Bluetooth antenna is an integral antenna which permanently attached, and the best case gain of the antenna is -0.56 dBi.</i></p>	

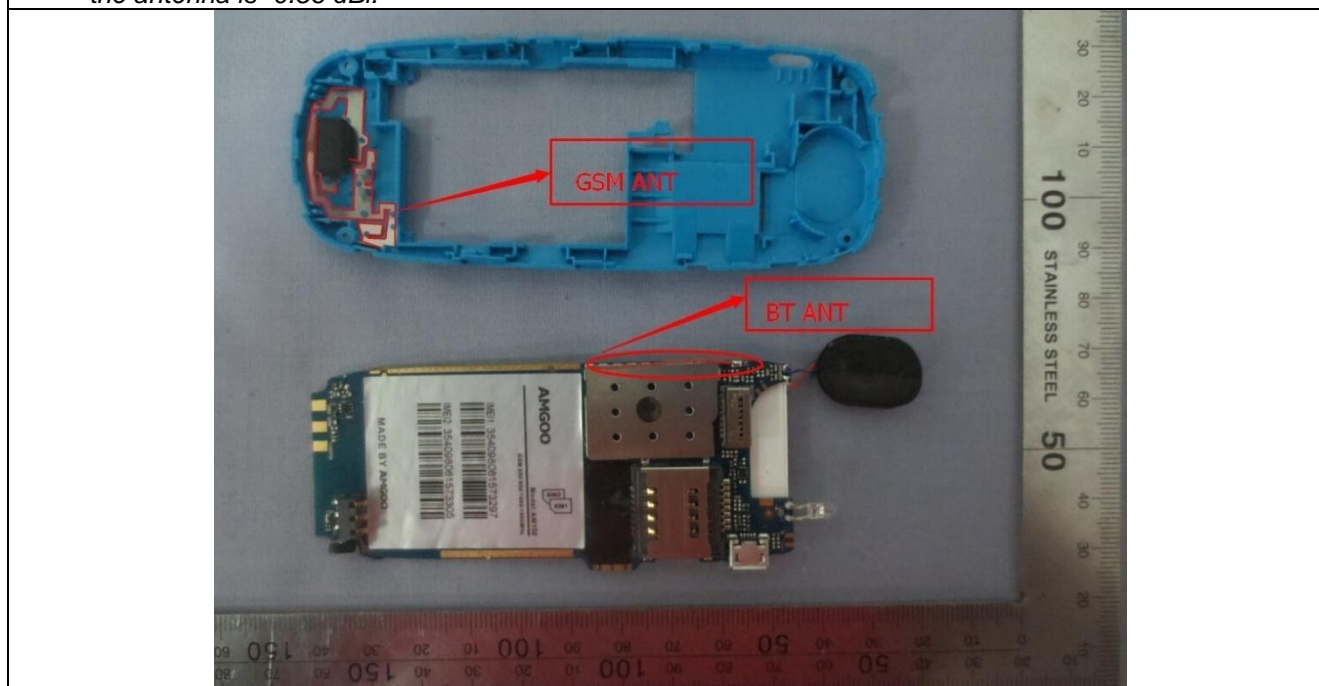

6.2 Conducted Emissions

Test Requirement:	FCC Part15 C Section 15.207														
Test Method:	ANSI C63.4:2003														
Test Frequency Range:	150 kHz to 30 MHz														
Class / Severity:	Class B														
Receiver setup:	RBW=9 kHz, VBW=30 kHz, Sweep time=auto														
Limit:	<table border="1"> <thead> <tr> <th rowspan="2">Frequency range (MHz)</th> <th colspan="2">Limit (dBuV)</th> </tr> <tr> <th>Quasi-peak</th> <th>Average</th> </tr> </thead> <tbody> <tr> <td>0.15-0.5</td> <td>66 to 56*</td> <td>56 to 46*</td> </tr> <tr> <td>0.5-5</td> <td>56</td> <td>46</td> </tr> <tr> <td>5-30</td> <td>60</td> <td>50</td> </tr> </tbody> </table> <p>* Decreases with the logarithm of the frequency.</p>	Frequency range (MHz)	Limit (dBuV)		Quasi-peak	Average	0.15-0.5	66 to 56*	56 to 46*	0.5-5	56	46	5-30	60	50
Frequency range (MHz)	Limit (dBuV)														
	Quasi-peak	Average													
0.15-0.5	66 to 56*	56 to 46*													
0.5-5	56	46													
5-30	60	50													
Test setup:	<p><i>Remark</i> E.U.T: Equipment Under Test LISN: Line Impedance Stabilization Network Test table height=0.8m</p>														
Test procedure:	<ol style="list-style-type: none"> 1. The E.U.T and simulators are connected to the main power through a line impedance stabilization network (L.I.S.N.). This provides a 50ohm/50uH coupling impedance for the measuring equipment. 2. The peripheral devices are also connected to the main power through a LISN that provides a 50ohm/50uH coupling impedance with 50ohm termination. (Please refer to the block diagram of the test setup and photographs). 3. Both sides of A.C. line are checked for maximum conducted interference. In order to find the maximum emission, the relative positions of equipment and all of the interface cables must be changed according to ANSI C63.4: 2003 on conducted measurement. 														
Test Instruments:	Refer to section 5.7 for details														
Test mode:	Bluetooth (Continuous transmitting) mode														
Test results:	Pass														

Measurement Data

Line:

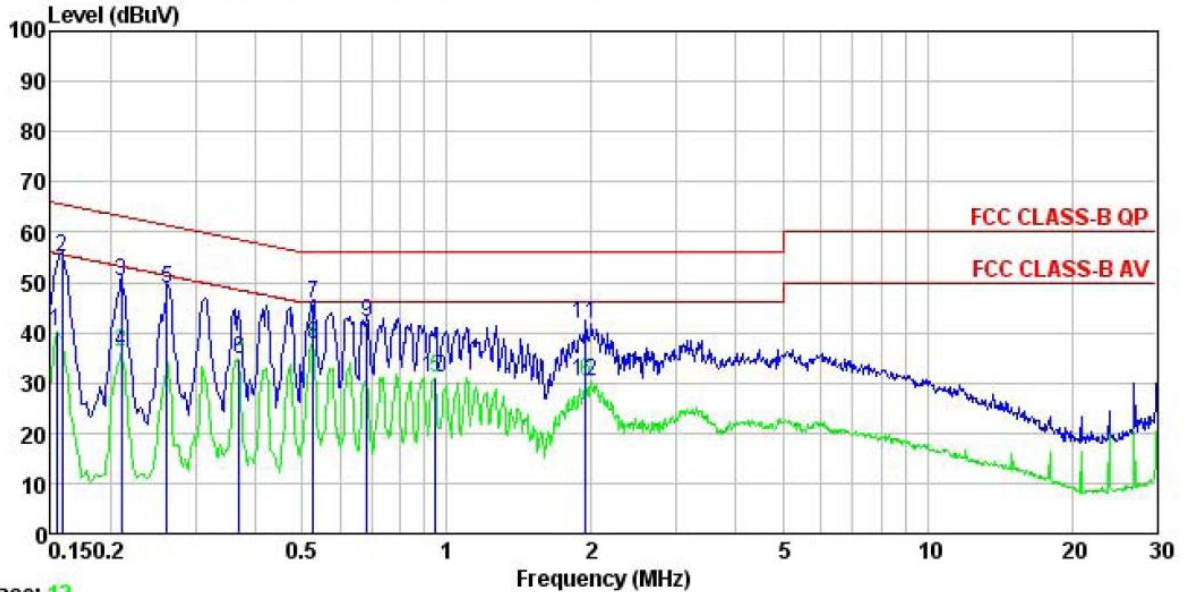

Trace: 12

Site : CCIS Shielding Room
 Condition : FCC CLASS-B QP LISN LINE
 EUT : Mobile Phone
 Model : AM102
 Test Mode : BT mode
 Power Rating : AC 120V/60Hz
 Environment : Temp: 23 °C Humi:56% Atmos:101KPa
 Test Engineer: Garen
 Remark :

	Read Freq	Level	LISN Factor	Cable Loss	Level	Limit Line	Over Limit	Remark
	MHz	dBuV	dB	dB	dBuV	dBuV	dB	
1	0.154	29.31	0.27	10.78	40.36	55.78	-15.42	Average
2	0.158	44.07	0.27	10.78	55.12	65.56	-10.44	QP
3	0.211	39.11	0.28	10.76	50.15	63.18	-13.03	QP
4	0.211	24.97	0.28	10.76	36.01	53.18	-17.17	Average
5	0.262	37.64	0.27	10.75	48.66	61.38	-12.72	QP
6	0.369	23.57	0.27	10.73	34.57	48.52	-13.95	Average
7	0.527	34.60	0.28	10.76	45.64	56.00	-10.36	QP
8	0.527	26.55	0.28	10.76	37.59	46.00	-8.41	Average
9	0.683	31.22	0.22	10.77	42.21	56.00	-13.79	QP
10	0.948	20.02	0.25	10.85	31.12	46.00	-14.88	Average
11	1.949	30.39	0.26	10.96	41.61	56.00	-14.39	QP
12	1.949	19.13	0.26	10.96	30.35	46.00	-15.65	Average

Neutral:

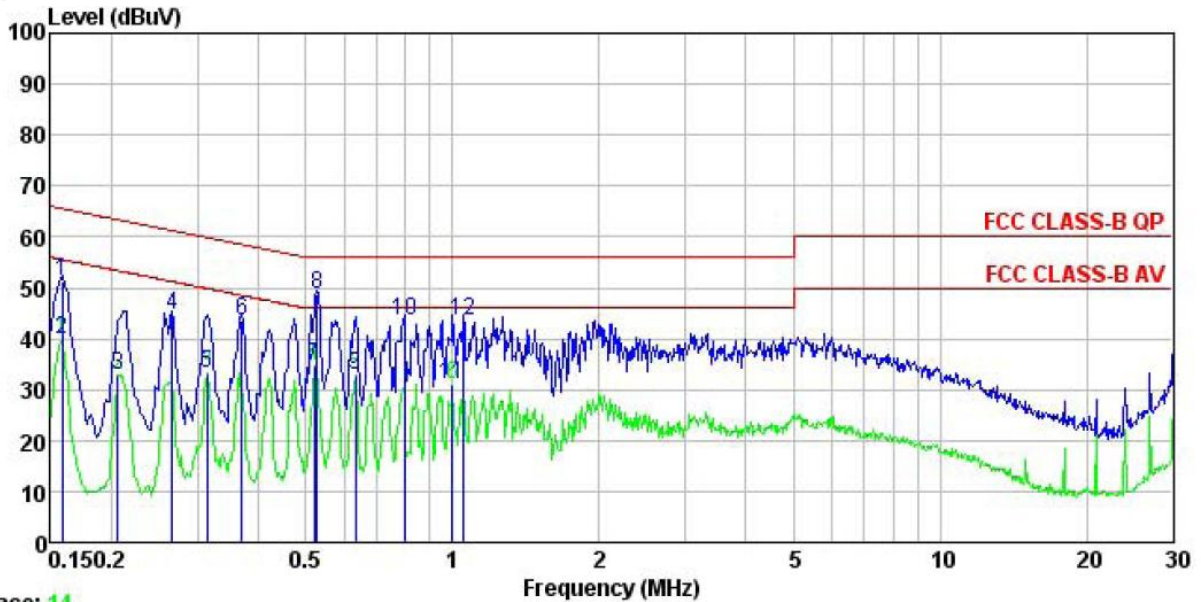

Trace: 14

Site : CCIS Shielding Room
 Condition : FCC CLASS-B QP LISN NEUTRAL
 EUT : Mobile Phone
 Model : AM102
 Test Mode : BT mode
 Power Rating : AC 120V/60Hz
 Environment : Temp: 23 °C Humi:56% Atmos:101KPa
 Test Engineer: Garen
 Remark :

	Read Freq	Level	LISN Factor	Cable Loss	Level	Limit Line	Over Limit	Remark
	MHz	dBuV	dB	dB	dBuV	dBuV	dB	
1	0.158	40.37	0.25	10.78	51.40	65.56	-14.16	QP
2	0.158	28.99	0.25	10.78	40.02	55.56	-15.54	Average
3	0.206	21.90	0.25	10.76	32.91	53.36	-20.45	Average
4	0.266	33.54	0.26	10.75	44.55	61.25	-16.70	QP
5	0.313	22.37	0.26	10.74	33.37	49.88	-16.51	Average
6	0.369	32.75	0.25	10.73	43.73	58.52	-14.79	QP
7	0.521	23.70	0.28	10.76	34.74	46.00	-11.26	Average
8	0.527	37.55	0.27	10.76	48.58	56.00	-7.42	QP
9	0.634	21.82	0.21	10.77	32.80	46.00	-13.20	Average
10	0.796	32.66	0.19	10.81	43.66	56.00	-12.34	QP
11	1.000	20.08	0.22	10.87	31.17	46.00	-14.83	Average
12	1.054	32.40	0.22	10.88	43.50	56.00	-12.50	QP

Notes:

1. An initial pre-scan was performed on the line and neutral lines with peak detector.
2. Quasi-Peak and Average measurement were performed at the frequencies with maximized peak emission.
3. Final Level = Receiver Read level + LISN Factor + Cable Loss

6.3 Conducted Output Power

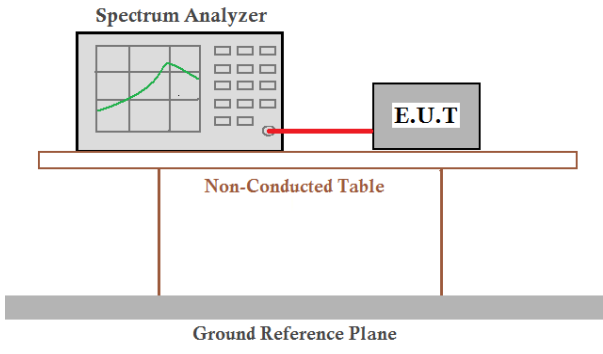
Test Requirement:	FCC Part15 C Section 15.247 (b)(3)
Test Method:	ANSI C63.4:2003 and DA00-705
Receiver setup:	RBW=1MHz, VBW=3MHz, Detector=Peak (If 20dB BW ≤ 1 MHz) RBW=3MHz, VBW=10MHz, Detector=Peak (If 20dB BW > 1 MHz and < 3MHz)
Limit:	125 mW(21 dBm)
Test setup:	 <p>The diagram illustrates the test setup. A Spectrum Analyzer is connected via a red cable to an E.U.T. (Equipment Under Test). Both are placed on a Non-Conducted Table. Below the table is a Ground Reference Plane.</p>
Test Instruments:	Refer to section 5.7 for details
Test mode:	Non-hopping mode
Test results:	Pass

Measurement Data

GFSK mode			
Test channel	Peak Output Power (dBm)	Limit (dBm)	Result
Lowest	1.34	21.00	Pass
Middle	1.84	21.00	Pass
Highest	1.15	21.00	Pass
π/4-DQPSK mode			
Test channel	Peak Output Power (dBm)	Limit (dBm)	Result
Lowest	0.45	21.00	Pass
Middle	1.22	21.00	Pass
Highest	0.70	21.00	Pass
8DPSK mode			
Test channel	Peak Output Power (dBm)	Limit (dBm)	Result
Lowest	0.45	21.00	Pass
Middle	1.09	21.00	Pass
Highest	0.45	21.00	Pass

Test plot as follows:

Modulation mode:	GFSK
------------------	------

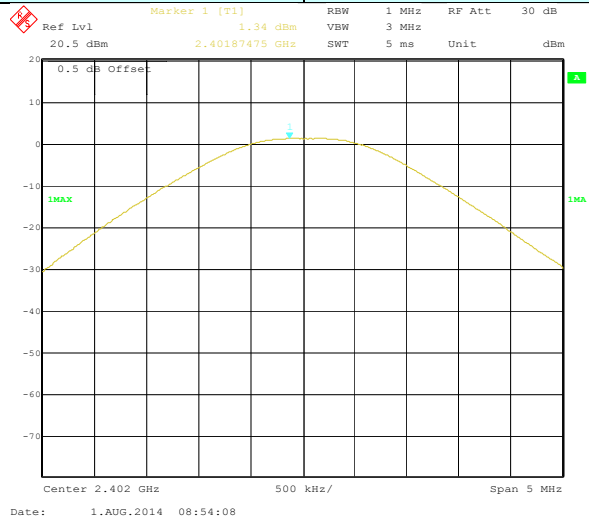

Lowest channel

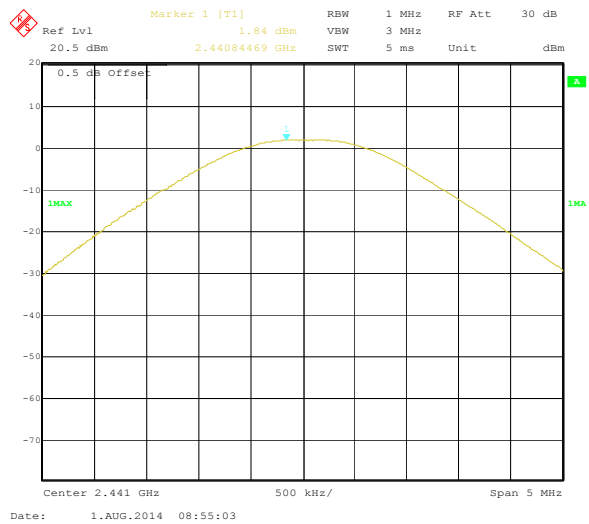

Middle channel

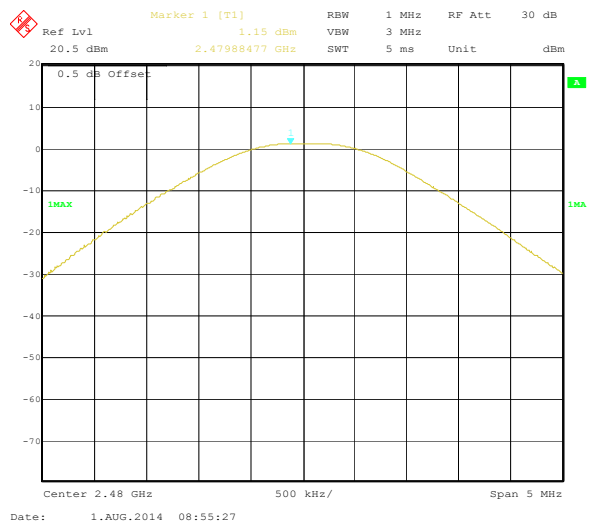

Highest channel

Modulation mode: π/4-DQPSK

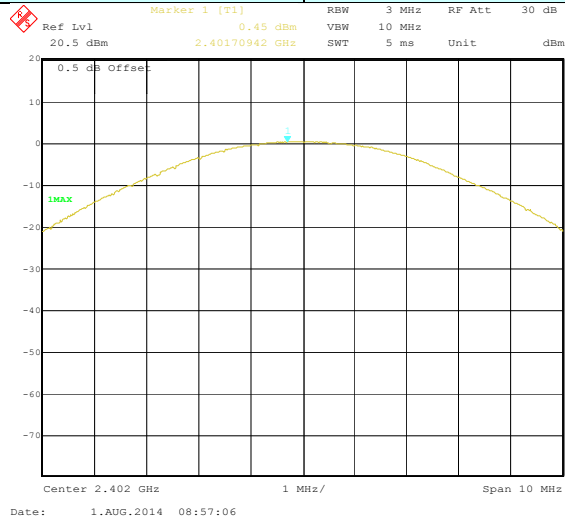

Lowest channel

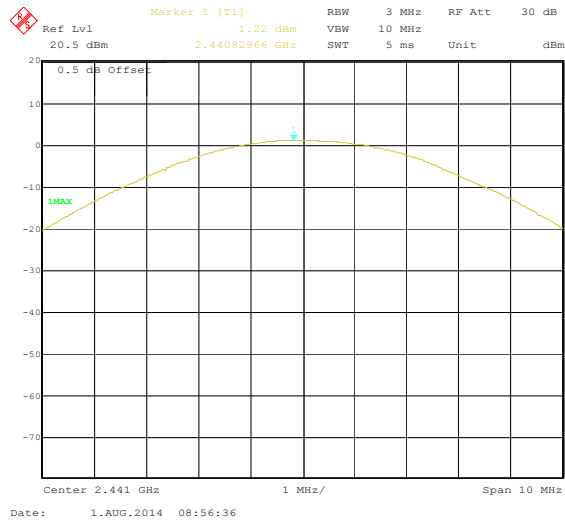

Middle channel

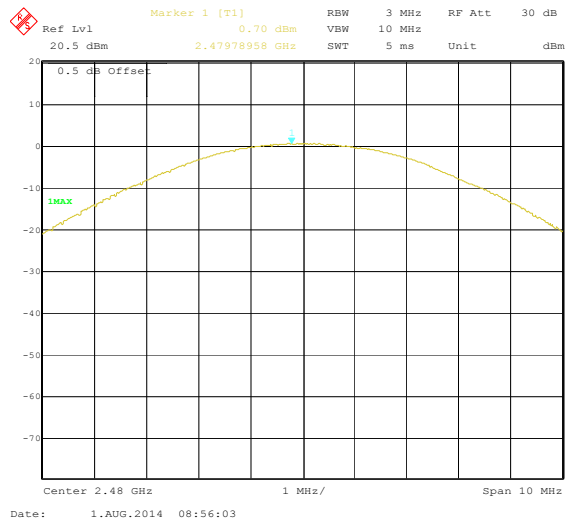

Highest channel

Modulation mode: **8DPSK**

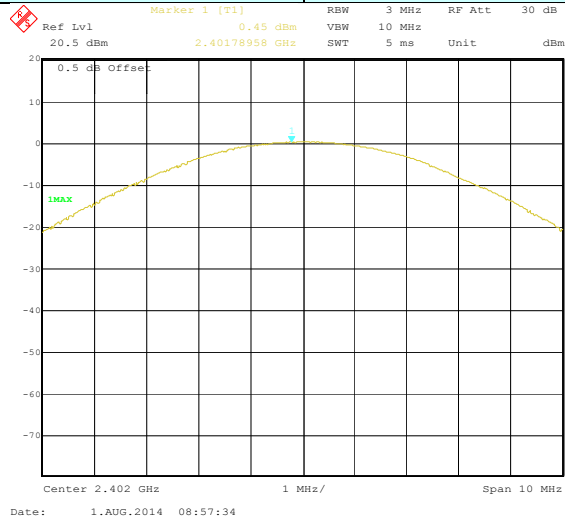

Lowest channel

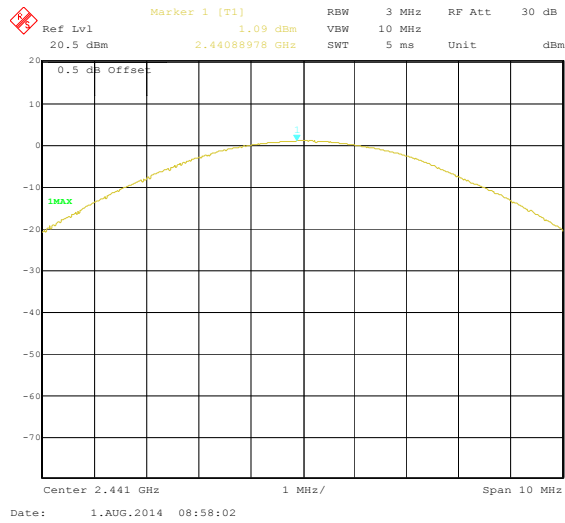

Middle channel

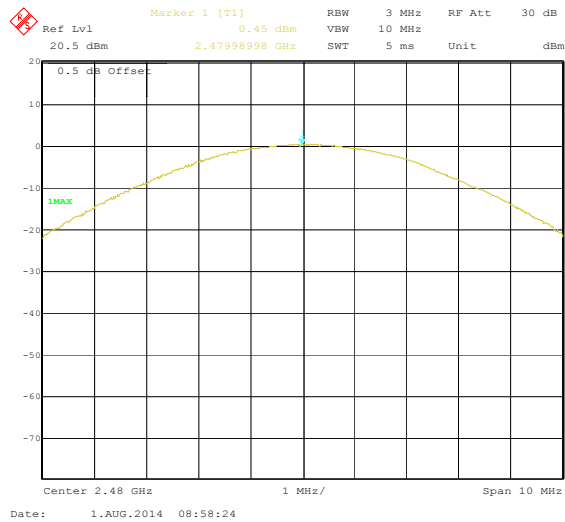

Highest channel

6.4 20dB Occupy Bandwidth

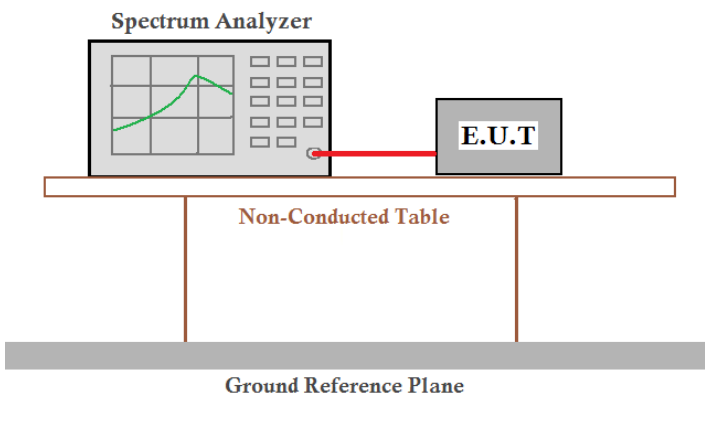
Test Requirement:	FCC Part15 C Section 15.247 (a)(1)
Test Method:	ANSI C63.4:2003 and DA00-705
Receiver setup:	RBW=30 kHz, VBW=100 kHz, detector=Peak
Limit:	NA
Test setup:	 <p>The diagram shows a Spectrum Analyzer and an E.U.T. (Equipment Under Test) connected by a red cable. They are positioned on a Non-Conducted Table, which is supported by a Ground Reference Plane.</p>
Test Instruments:	Refer to section 5.7 for details
Test mode:	Non-hopping mode
Test results:	Pass

Measurement Data

Test channel	20dB Occupy Bandwidth (kHz)		
	GFSK	$\pi/4$ -DQPSK	8DPSK
Lowest	845.69	1134.27	1178.36
Middle	845.69	1134.27	1178.36
Highest	845.69	1134.27	1178.36

Test plot as follows:

Modulation mode: **GFSK**

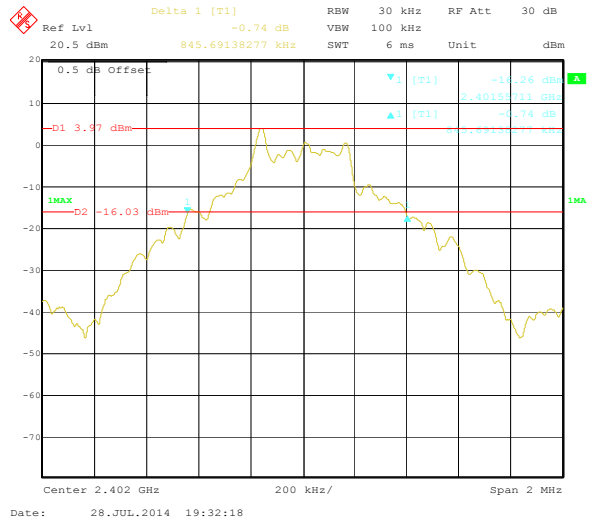

Lowest channel

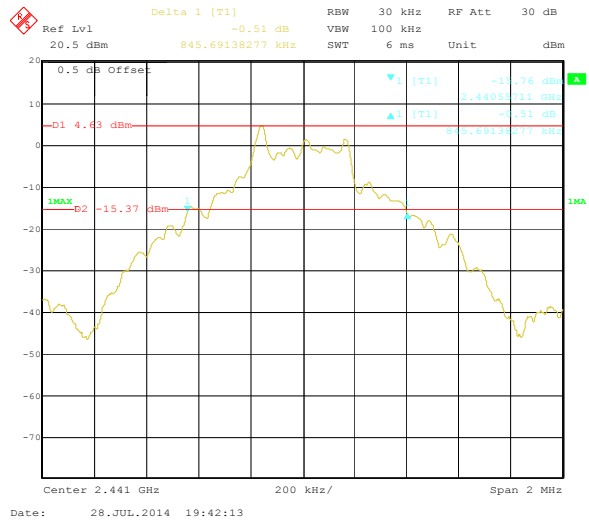

Middle channel

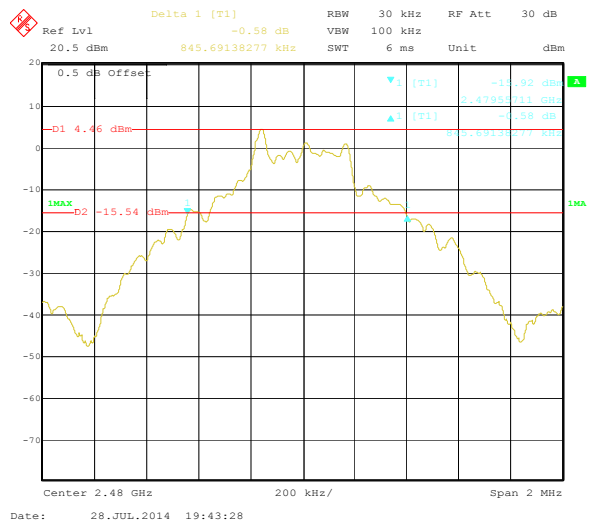

Highest channel

Modulation mode: $\pi/4$ -DQPSK

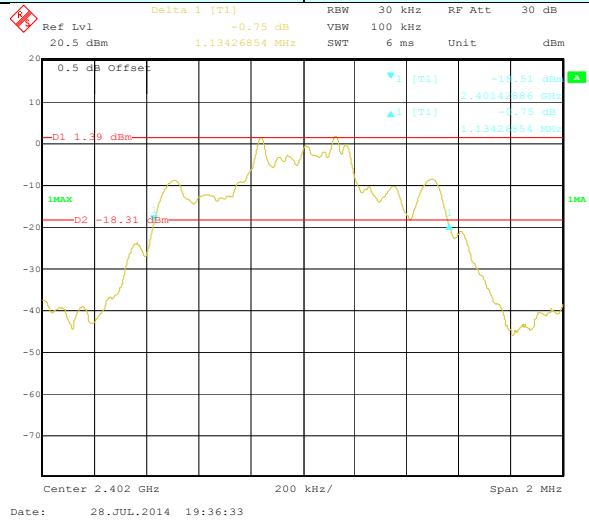

Lowest channel

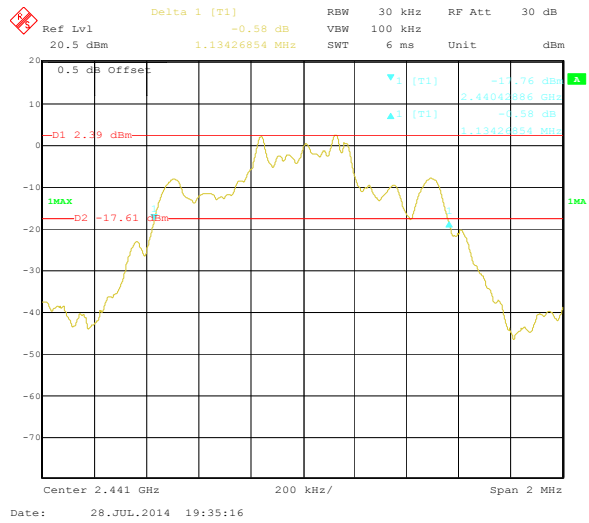

Middle channel

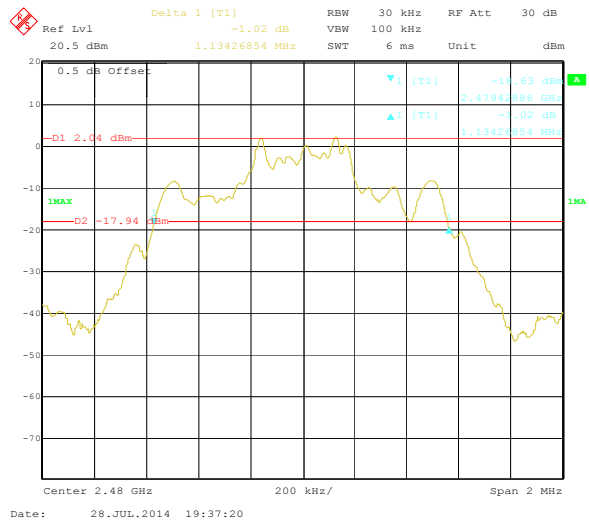

Highest channel

Modulation mode: **8DPSK**

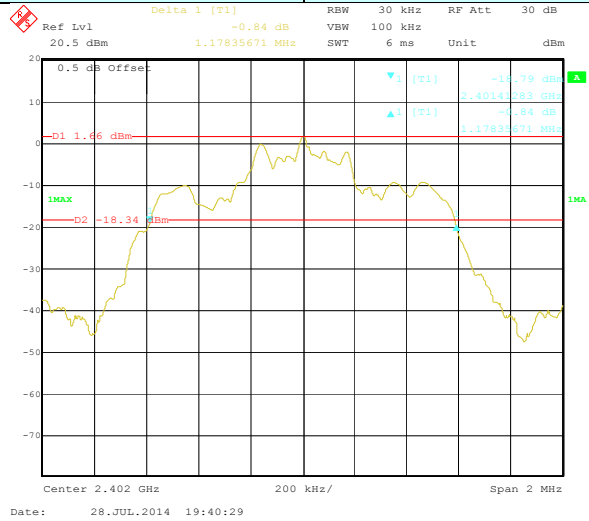

Lowest channel

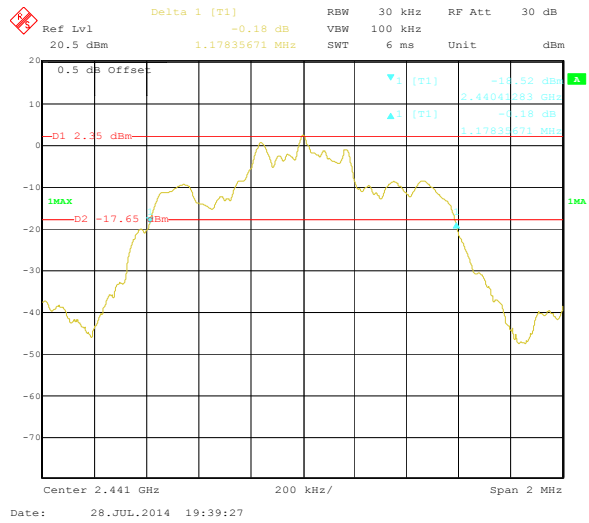

Middle channel

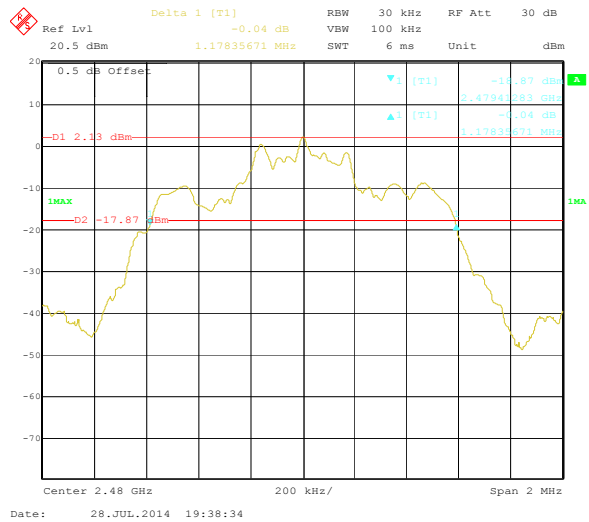

Highest channel

6.5 Carrier Frequencies Separation

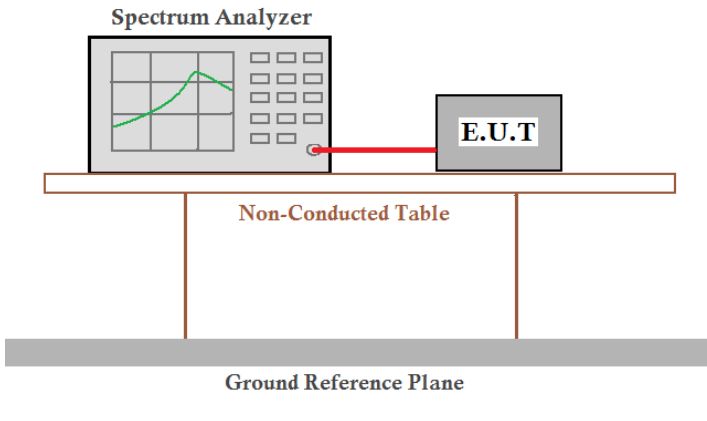
Test Requirement:	FCC Part15 C Section 15.247 (a)(1)
Test Method:	ANSI C63.4:2003 and DA00-705
Receiver setup:	RBW=100 kHz, VBW=300 kHz, detector=Peak
Limit:	0.025MHz or 2/3 of the 20dB bandwidth (whichever is greater)
Test setup:	 <p>The diagram illustrates the test setup. A Spectrum Analyzer is connected to an E.U.T. (Equipment Under Test) via a red cable. Both are placed on a Non-Conducted Table, which is supported by two vertical legs. Below the table is a Ground Reference Plane, represented by a thick grey bar.</p>
Test Instruments:	Refer to section 5.7 for details
Test mode:	Hopping mode
Test results:	Pass

Measurement Data

GFSK mode			
Test channel	Carrier Frequencies Separation (kHz)	Limit (kHz)	Result
Lowest	1002	563.79	Pass
Middle	1002	563.79	Pass
Highest	1002	563.79	Pass
$\pi/4$ -DQPSK mode			
Test channel	Carrier Frequencies Separation (kHz)	Limit (kHz)	Result
Lowest	1002	756.18	Pass
Middle	1002	756.18	Pass
Highest	1002	756.18	Pass
8DPSK mode			
Test channel	Carrier Frequencies Separation (kHz)	Limit (kHz)	Result
Lowest	1002	785.57	Pass
Middle	1002	785.57	Pass
Highest	1002	785.57	Pass

Note: According to section 6.4

Mode	20dB bandwidth (kHz) (worse case)	Limit (kHz) (Carrier Frequencies Separation)
GFSK	845.69	563.79
$\pi/4$ -DQPSK	1134.27	756.18
8DPSK	1178.36	785.57

Test plot as follows:

Modulation mode: **GFSK**

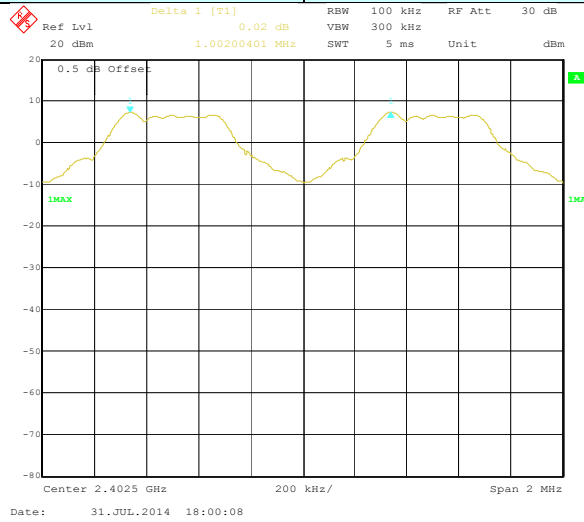

Lowest channel

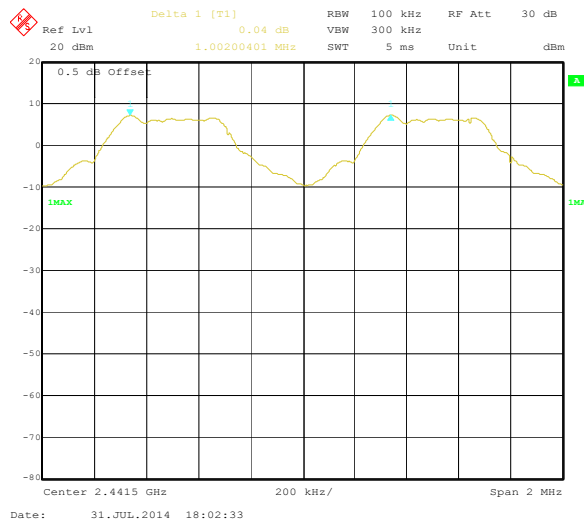

Middle channel

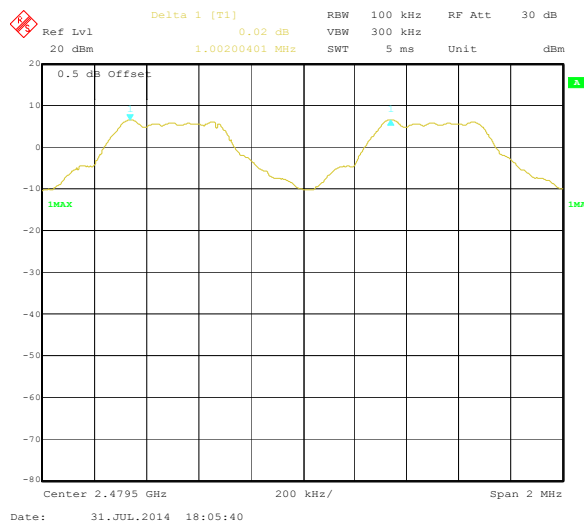

Highest channel

Modulation mode: π/4-DQPSK

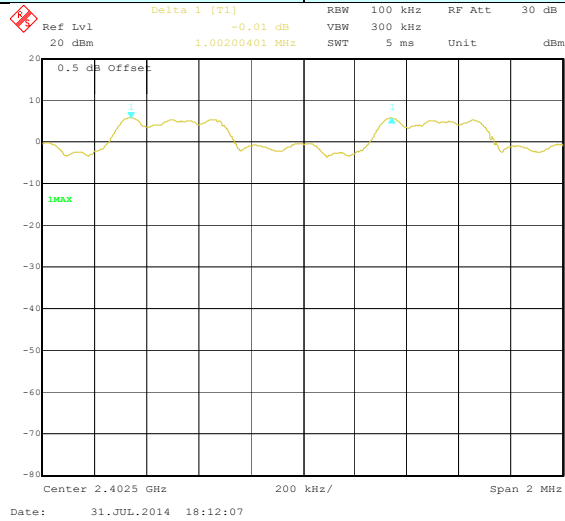

Lowest channel

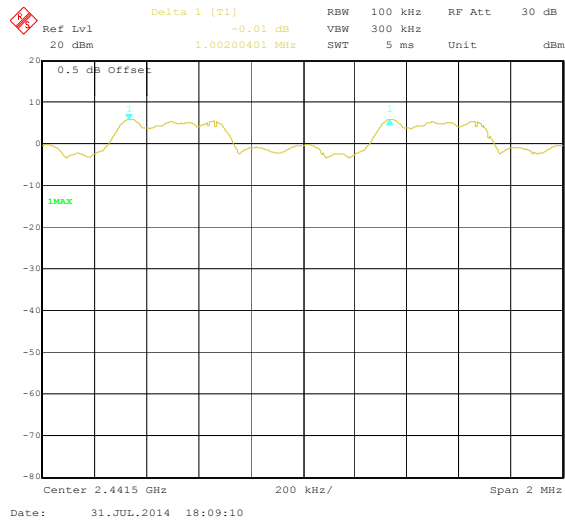

Middle channel

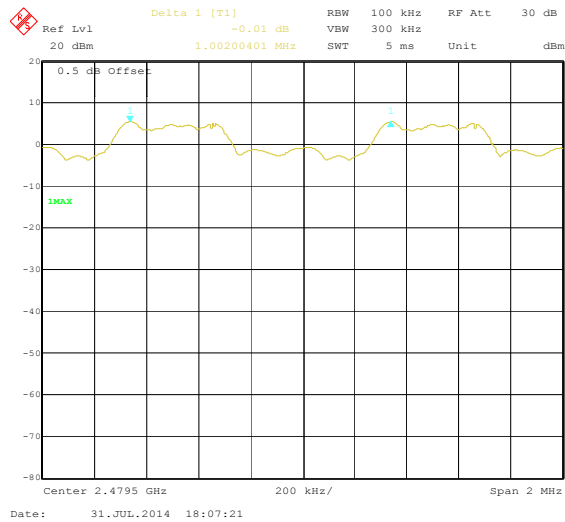

Highest channel

Modulation mode: **8DPSK**

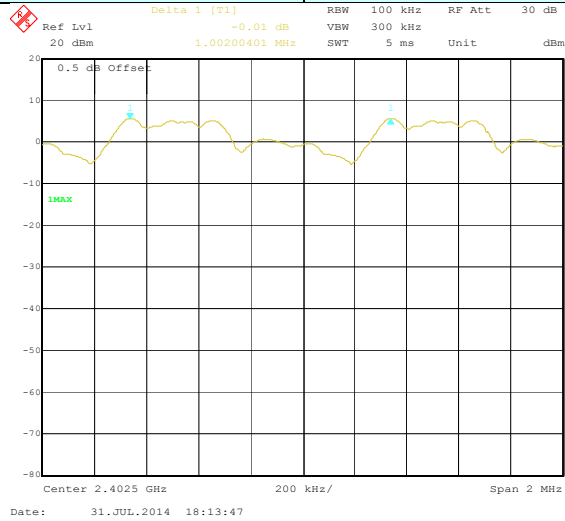

Lowest channel

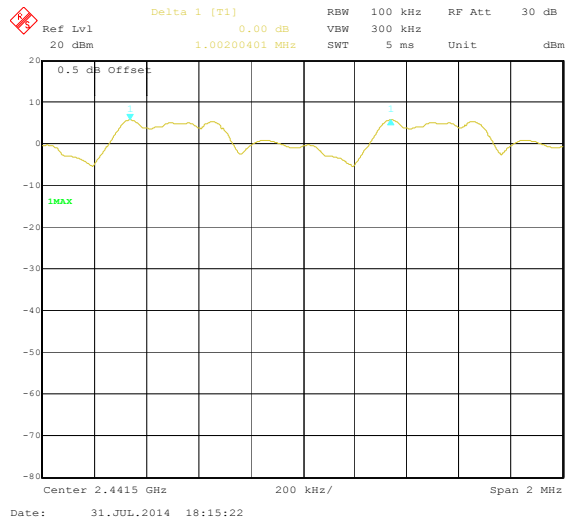

Middle channel

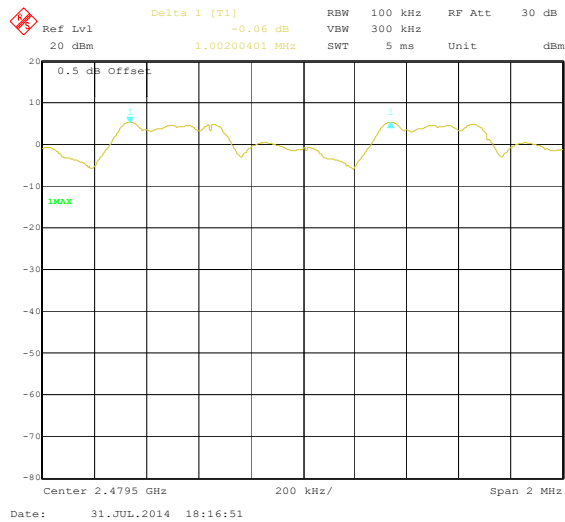

Highest channel

6.6 Hopping Channel Number

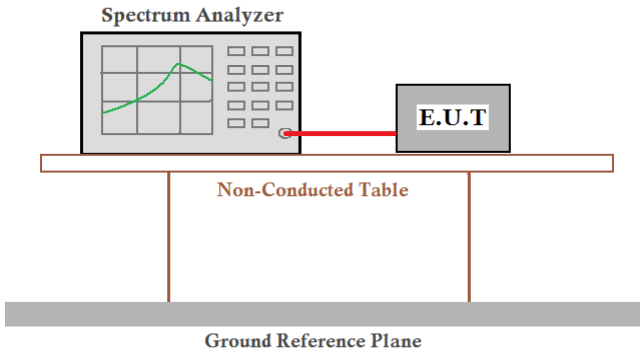
Test Requirement:	FCC Part15 C Section 15.247 (a)(1)
Test Method:	ANSI C63.4:2003 and DA00-705
Receiver setup:	RBW=100 kHz, VBW=300 kHz, Frequency range=2400MHz-2483.5MHz, Detector=Peak
Limit:	15 channels
Test setup:	 <p>The diagram illustrates the test setup. A Spectrum Analyzer and an E.U.T. (Equipment Under Test) are placed on a Non-Conducted Table. The table is supported by two legs and sits above a Ground Reference Plane. A red cable connects the Spectrum Analyzer to the E.U.T.</p>
Test Instruments:	Refer to section 5.7 for details
Test mode:	Hopping mode
Test results:	Pass

Measurement Data:

Mode	Hopping channel numbers	Limit	Result
GFSK, $\pi/4$ -DQPSK, 8DPSK	79	15	Pass

GFSK

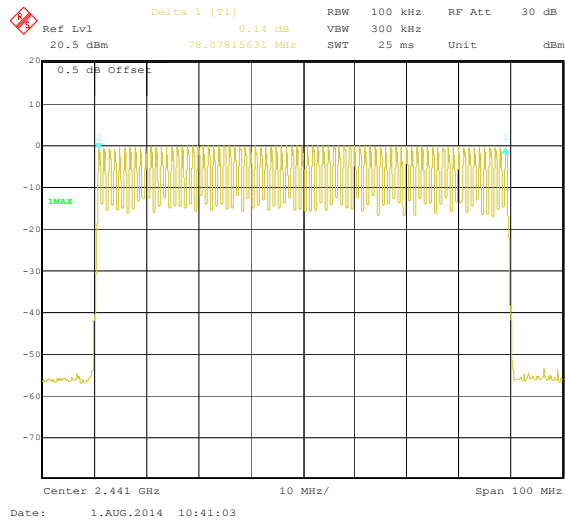

$\pi/4$ -DQPSK

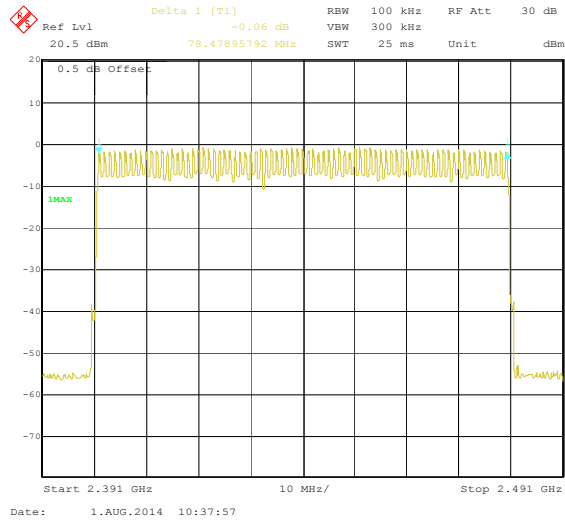

8DPSK

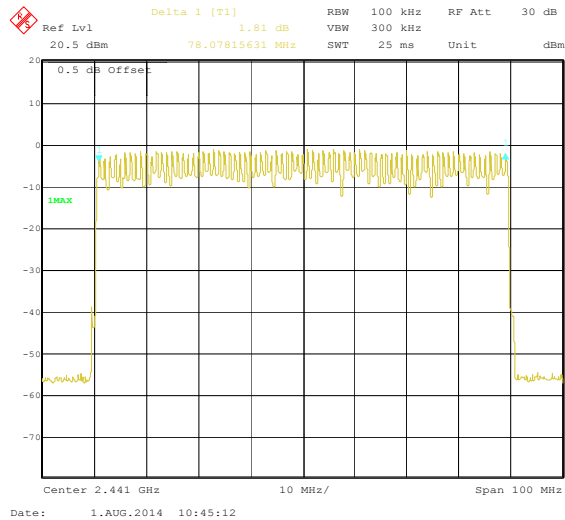

6.7 Dwell Time

Test Requirement:	FCC Part15 C Section 15.247 (a)(1)
Test Method:	ANSI C63.4:2003 and KDB DA00-705
Receiver setup:	RBW=1 MHz, VBW=1 MHz, Span=0 Hz, Detector=Peak
Limit:	0.4 Second
Test setup:	<p>The diagram illustrates the test setup. A Spectrum Analyzer is connected via a red cable to an E.U.T. (Equipment Under Test). Both are placed on a Non-Conducted Table. Below the table is a Ground Reference Plane.</p>
Test Instruments:	Refer to section 5.7 for details
Test mode:	Hopping mode
Test results:	Pass

Measurement Data (Worse case)

Mode	Packet	Dwell time (second)	Limit (second)	Result
GFSK	DH1	0.12832	0.4	Pass
	DH3	0.26832		
	DH5	0.31744		
π /4-DQPSK	2-DH1	0.12960	0.4	Pass
	2-DH3	0.26768		
	2-DH5	0.31296		
8DPSK	3-DH1	0.12768	0.4	Pass
	3-DH3	0.26672		
	3-DH5	0.31531		

For GFSK, π/4-DQPSK and 8DPSK:

The test period: $T = 0.4 \text{ Second/Channel} \times 79 \text{ Channel} = 31.6 \text{ s}$

DH1 time slot = $0.401 \times (1600 / (2 \times 79)) \times 31.6 = 128.32 \text{ ms}$

DH3 time slot = $1.677 \times (1600 / (4 \times 79)) \times 31.6 = 268.32 \text{ ms}$

DH5 time slot = $2.976 \times (1600 / (6 \times 79)) \times 31.6 = 317.44 \text{ ms}$

2-DH1 time slot = $0.405 \times (1600 / (2 \times 79)) \times 31.6 = 129.60 \text{ ms}$

2-DH3 time slot = $1.673 \times (1600 / (4 \times 79)) \times 31.6 = 267.68 \text{ ms}$

2-DH5 time slot = $2.934 \times (1600 / (6 \times 79)) \times 31.6 = 312.96 \text{ ms}$

3-DH1 time slot = $0.399 \times (1600 / (2 \times 79)) \times 31.6 = 127.68 \text{ ms}$

3-DH3 time slot = $1.667 \times (1600 / (4 \times 79)) \times 31.6 = 266.72 \text{ ms}$

3-DH5 time slot = $2.956 \times (1600 / (6 \times 79)) \times 31.6 = 315.31 \text{ ms}$

Test plot as follows:

Modulation mode:	GFSK
------------------	------

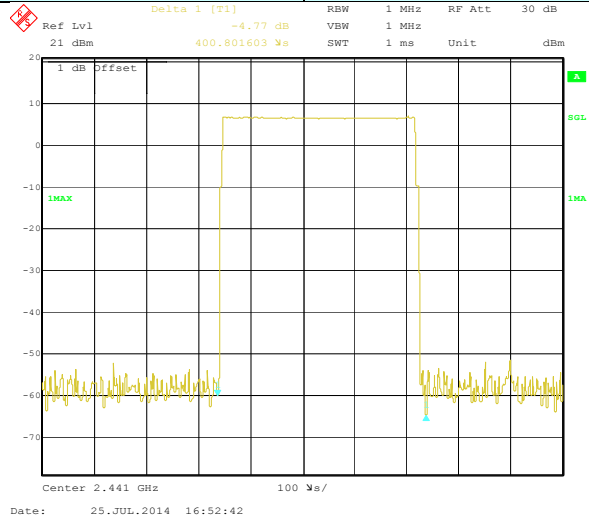

DH1

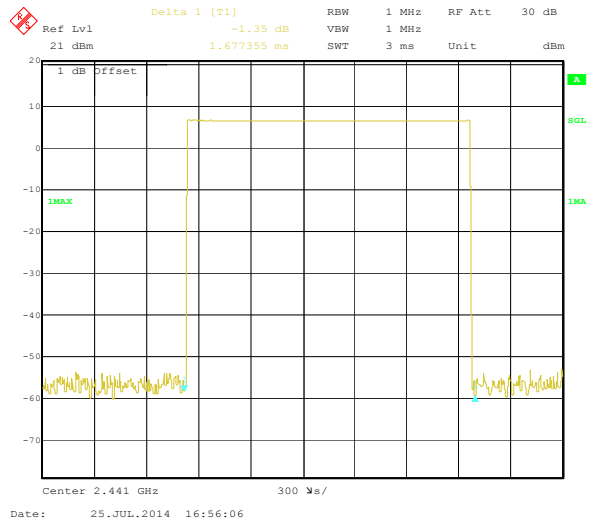

DH3

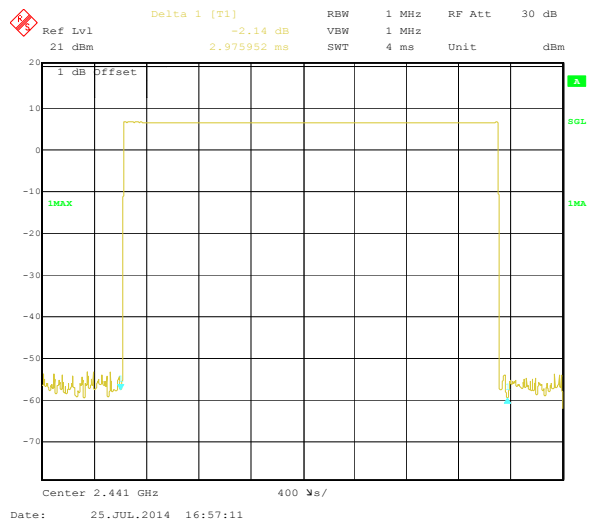

DH5

Modulation mode: $\pi/4$ -DQPSK

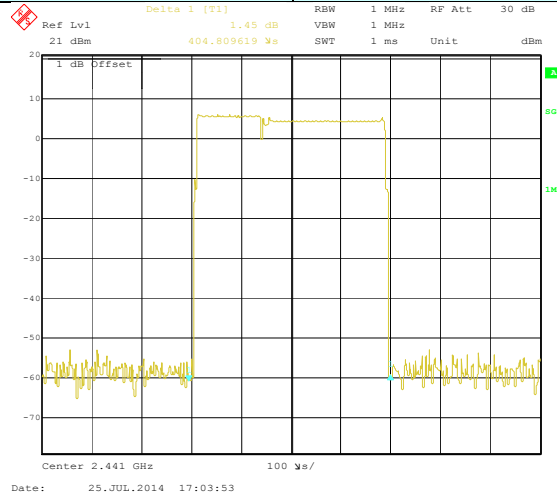

2-DH1

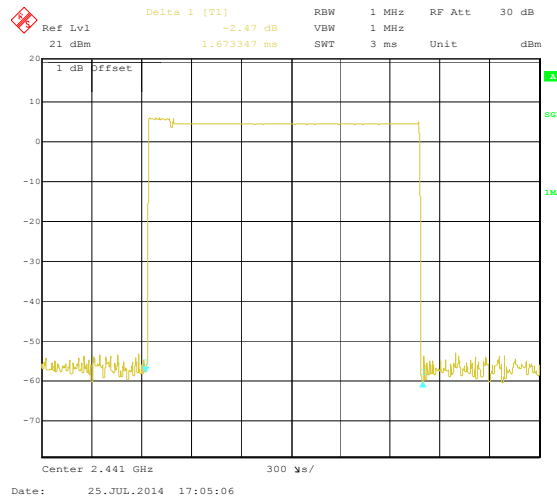

2-DH3

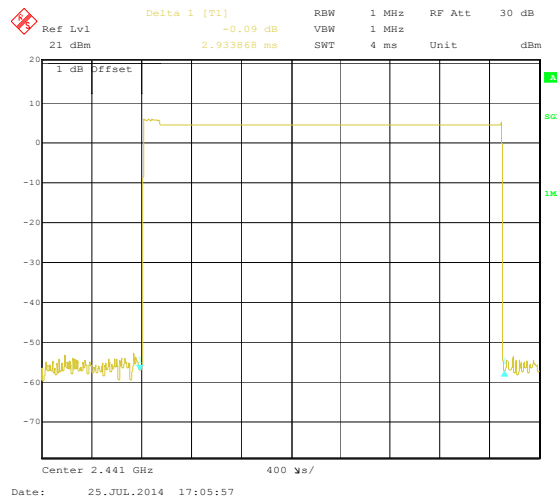

2-DH5

Modulation mode: **8DPSK**

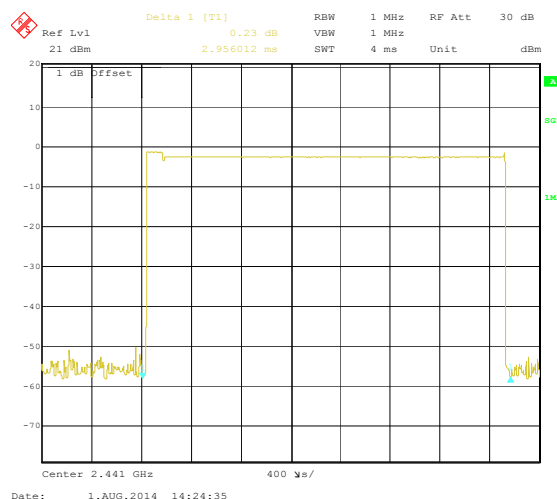
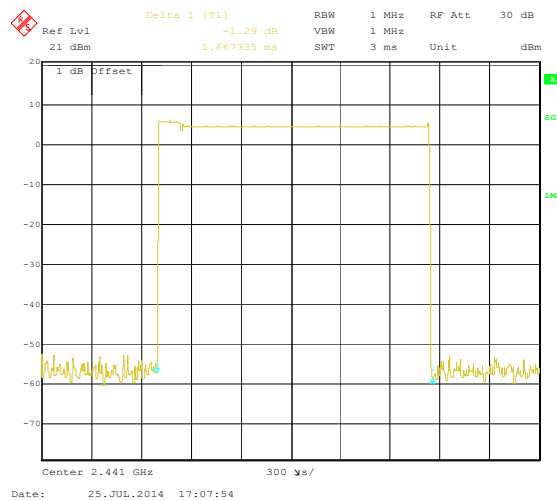
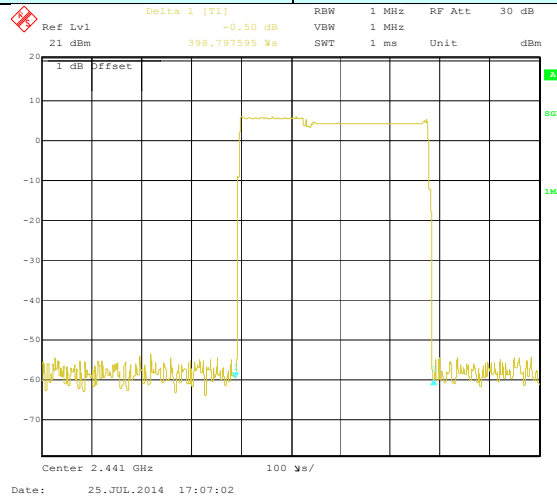

3-DH5

6.8 Pseudorandom Frequency Hopping Sequence

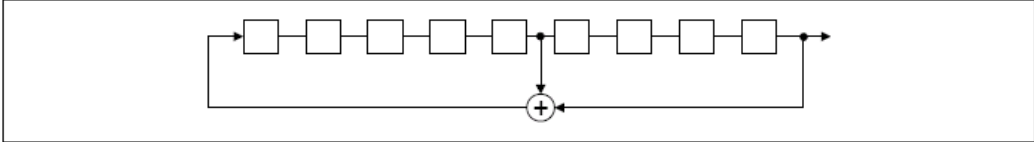
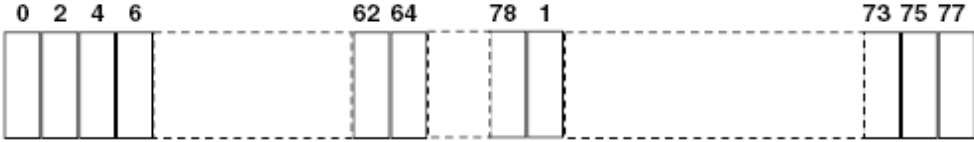
Test Requirement:	FCC Part15 C Section 15.247 (a)(1) requirement:
<p>Frequency hopping systems shall have hopping channel carrier frequencies separated by a minimum of 25 kHz or the 20 dB bandwidth of the hopping channel, whichever is greater.</p> <p>Alternatively, Frequency hopping systems operating in the 2400-2483.5 MHz band may have hopping channel carrier frequencies that are separated by 25 kHz or two-thirds of the 20 dB bandwidth of the hopping channel, whichever is greater, provided the systems operate with an output power no greater than 125 mW. The system shall hop to channel frequencies that are selected at the system hopping rate from a Pseudorandom ordered list of hopping frequencies. Each frequency must be used equally on the average by each transmitter. The system receivers shall have input bandwidths that match the hopping channel bandwidths of their corresponding transmitters and shall shift frequencies in synchronization with the transmitted signals.</p>	
EUT Pseudorandom Frequency Hopping Sequence	
<p>The pseudorandom sequence may be generated in a nine-stage shift register whose 5th and 9th stage outputs are added in a modulo-two addition stage. And the result is fed back to the input of the first stage. The sequence begins with the first ONE of 9 consecutive ONES; i.e. the shift register is initialized with nine ones.</p> <ul style="list-style-type: none"> • Number of shift register stages: 9 • Length of pseudo-random sequence: $2^9 - 1 = 511$ bits • Longest sequence of zeros: 8 (non-inverted signal) 	
	
<p><i>Linear Feedback Shift Register for Generation of the PRBS sequence</i></p>	
<p>An example of Pseudorandom Frequency Hopping Sequence as follow:</p>	
	
<p>Each frequency used equally on the average by each transmitter.</p> <p>The system receivers have input bandwidths that match the hopping channel bandwidths of their corresponding transmitters and shift frequencies in synchronization with the transmitted signals.</p>	

6.9 Band Edge

6.9.1 Conducted Emission Method

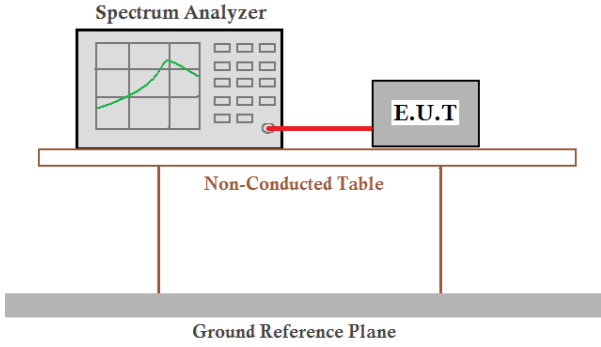
Test Requirement:	FCC Part15 C Section 15.247 (d)
Test Method:	ANSI C63.4:2003 and DA00-705
Receiver setup:	RBW=100 kHz, VBW=300 kHz, Detector=Peak
Limit:	In any 100 kHz bandwidth outside the frequency band in which the spread spectrum intentional radiator is operating, the radio frequency power that is produced by the intentional radiator shall be at least 20 dB below that in the 100 kHz bandwidth within the band that contains the highest level of the desired power, based on either an RF conducted or a radiated measurement.
Test setup:	 <p>The diagram illustrates the test setup. A Spectrum Analyzer is connected to an E.U.T. (Equipment Under Test) via a red cable. Both are placed on a Non-Conducted Table, which is supported by a Ground Reference Plane.</p>
Test Instruments:	Refer to section 5.7 for details
Test mode:	Non-hopping mode and hopping mode
Test results:	Pass

Test plot as follows:

GFSK



$\pi/4$ -DQPSK

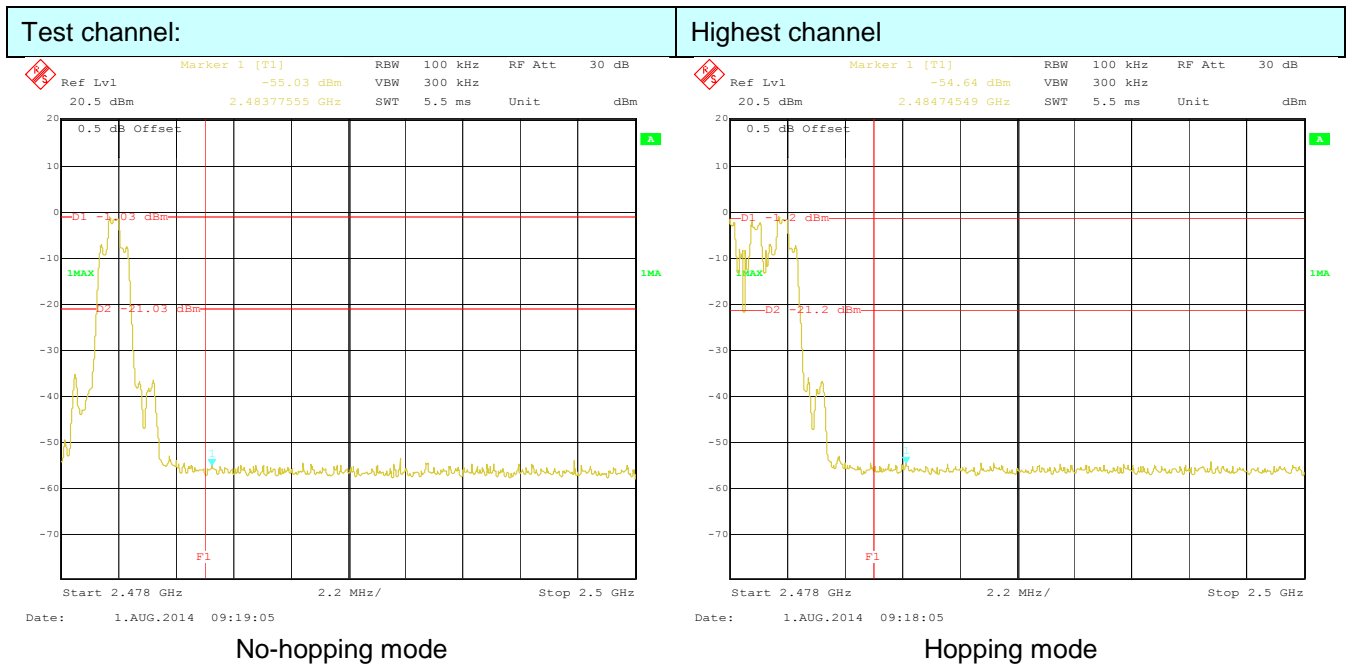

8DPSK

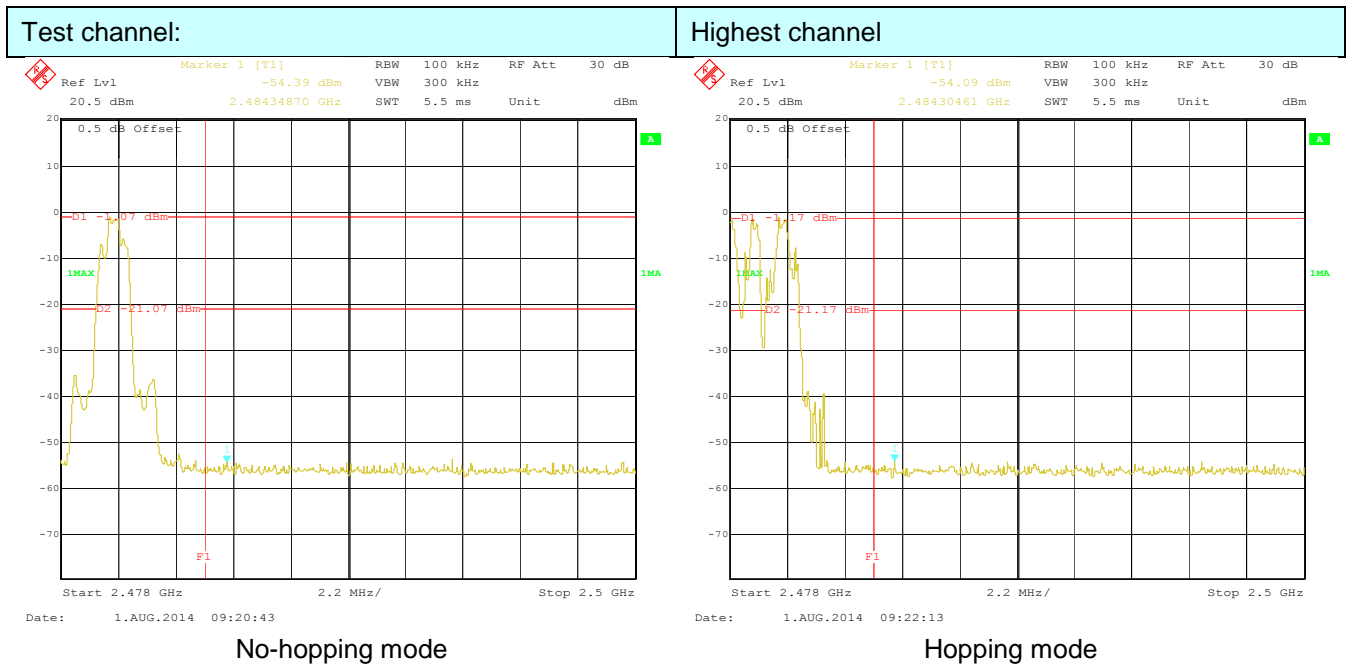

6.9.2 Radiated Emission Method

Test Requirement:	FCC Part15 C Section 15.209 and 15.205				
Test Method:	ANSI C63.4: 2003				
Test Frequency Range:	2.3GHz to 2.5GHz				
Test site:	Measurement Distance: 3m				
Receiver setup:	Frequency	Detector	RBW	VBW	Remark
	Above 1GHz	Peak	1MHz	3MHz	Peak Value
		Peak	1MHz	10Hz	Average Value
Limit:	Frequency		Limit (dBuV/m @3m)		Remark
	Above 1GHz		54.00		Average Value
			74.00		Peak Value
Test setup:					
Test Procedure:	<ol style="list-style-type: none"> 1. The EUT was placed on the top of a rotating table 0.8 meters above the ground at a 3 meter camber. The table was rotated 360 degrees to determine the position of the highest radiation. 2. The EUT was set 3 meters away from the interference-receiving antenna, which was mounted on the top of a variable-height antenna tower. 3. The antenna height is varied from one meter to four meters above the ground to determine the maximum value of the field strength. Both horizontal and vertical polarizations of the antenna are set to make the measurement. 4. For each suspected emission, the EUT was arranged to its worst case and then the antenna was tuned to heights from 1 meter to 4 meters and the rota table was turned from 0 degrees to 360 degrees to find the maximum reading. 5. The test-receiver system was set to Peak Detect Function and Specified Bandwidth with Maximum Hold Mode. 6. If the emission level of the EUT in peak mode was 10dB lower than the limit specified, then testing could be stopped and the peak values of the EUT would be reported. Otherwise the emissions that did not have 10dB margin would be re-tested one by one using peak, quasi-peak or average method as specified and then reported in a data sheet. 				
Test Instruments:	Refer to section 5.7 for details				
Test mode:	Non-hopping mode				
Test results:	Passed				

Remark:

1. During the test, pre-scan the GFSK, $\pi/4$ -DQPSK, 8DPSK, and all data were shown in report.
2. Pre-scan all kind of the place mode (X-axis, Y-axis, Z-axis), and found the Y-axis is the worst case.

GFSK mode
 Test channel: Lowest
 Horizontal:

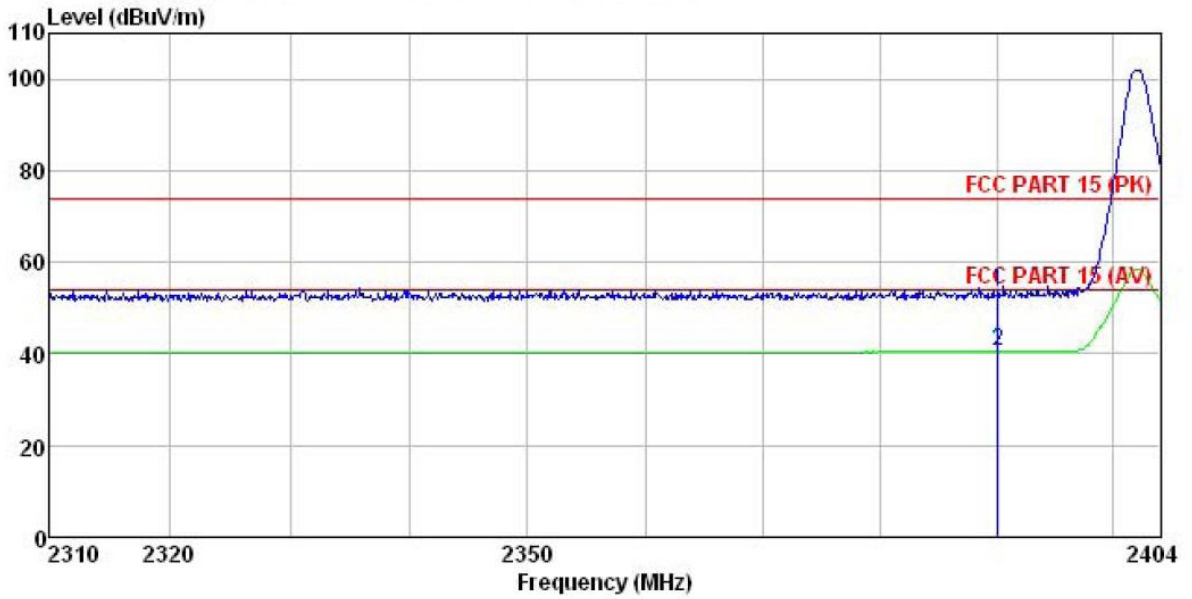

Site : 3m chamber
 Condition : FCC PART 15 (PK) 3m BBHA9120(1G18) HORIZONTAL
 EUT : Mobile phone
 Model : AM102
 Test mode : BT-DH1-L
 Power Rating : AC120V/60Hz
 Environment : Temp:25.5°C Humi:55%
 Test Engineer: Garen
 REMARK :

	Freq	Read Level	Antenna Factor	Cable Loss	Preamp Factor	Level	Limit	Over	Remark
	MHz	dBm	dB/m	dB	dB	dBm/m	dBm/m	dB	
1	2390.000	20.25	27.58	5.67	0.00	53.50	74.00	-20.50	Peak
2	2390.000	7.20	27.58	5.67	0.00	40.45	54.00	-13.55	Average

Vertical:

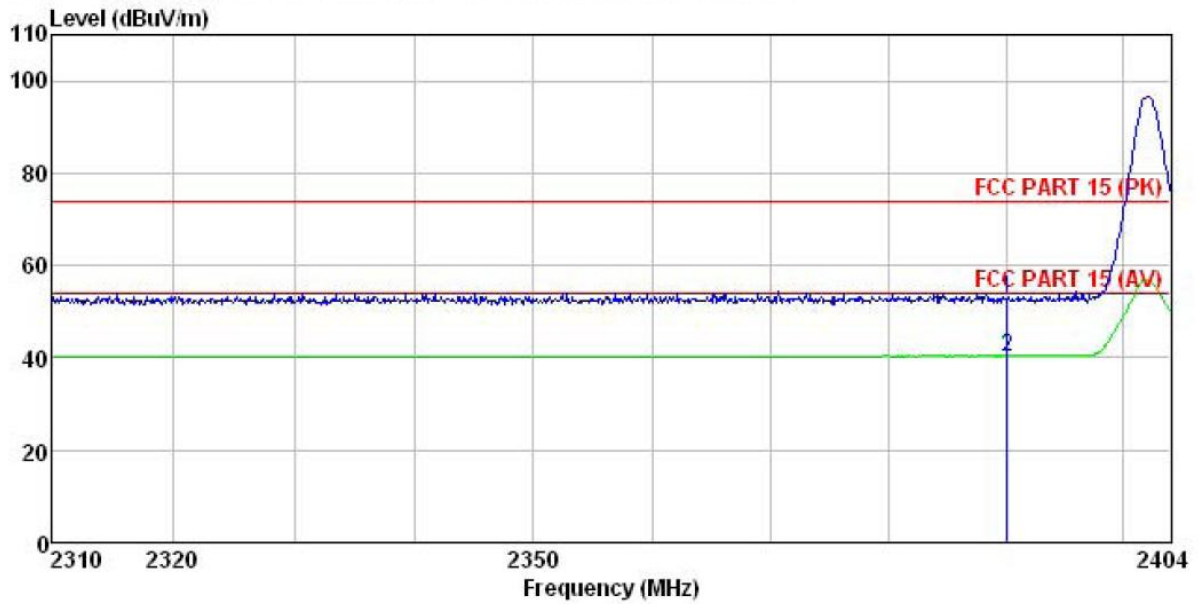

Site : 3m chamber
 Condition : FCC PART 15 (PK) 3m BBHA9120(1G18) VERTICAL
 EUT : Mobile phone
 Model : AM102
 Test mode : BT-DH1-L
 Power Rating : AC120V/60Hz
 Environment : Temp:25.5°C Humi:55%
 Test Engineer: Garen
 REMARK :

	Read	Antenna	Cable	Preamp	Limit	Over			
Freq	Level	Factor	Loss	Factor	Line	Limit	Remark		
MHz	dBm	dB/m	dB	dB	dBm/m	dBm/m	dB		
1	2390.000	19.49	27.58	5.67	0.00	52.74	74.00	-21.26	Peak
2	2390.000	7.13	27.58	5.67	0.00	40.38	54.00	-13.62	Average

Test channel: Highest

Horizontal:

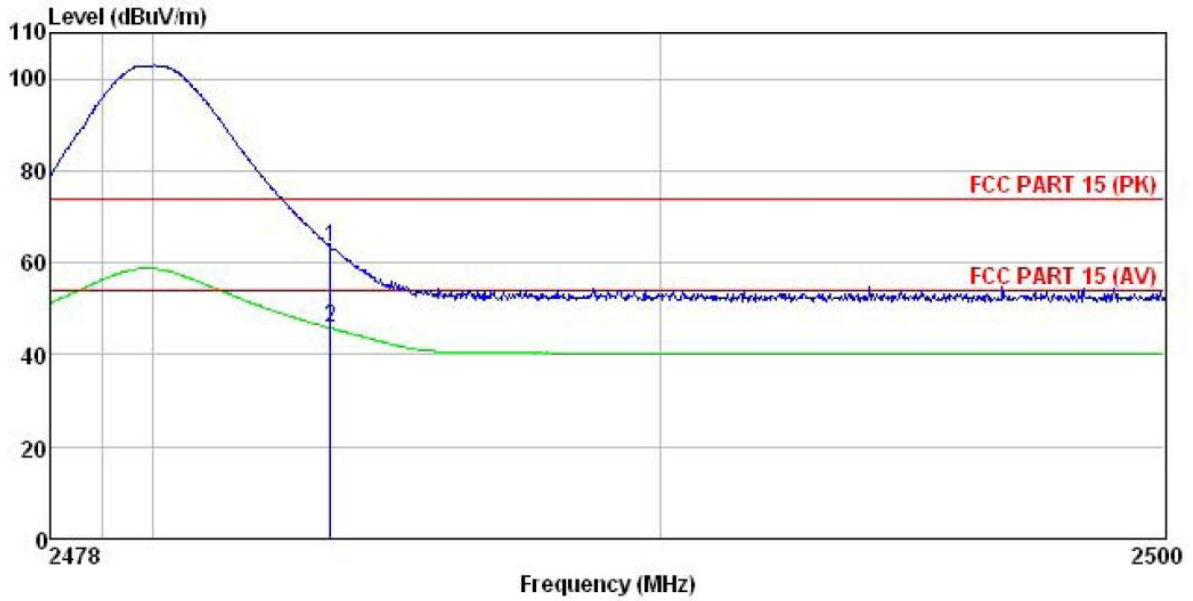

Site : 3m chamber
 Condition : FCC PART 15 (PK) 3m BBHA9120(1G18) HORIZONTAL
 EUT : Mobile phone
 Model : AM102
 Test mode : BT-DH1-H
 Power Rating : AC120V/60Hz
 Environment : Temp:25.5°C Humi:55%
 Test Engineer: Garen
 REMARK :

	Read	Antenna	Cable	Preamp	Level	Limit	Over	
Freq	Level	Factor	Loss	Factor	Level	Line	Limit	Remark
MHz	dBm	dB/m	dB	dB	dBm/m	dBm/m	dB	
1	2483.500	30.11	27.52	5.70	0.00	63.33	74.00	-10.67 Peak
2	2483.500	12.57	27.52	5.70	0.00	45.79	54.00	-8.21 Average

Vertical:

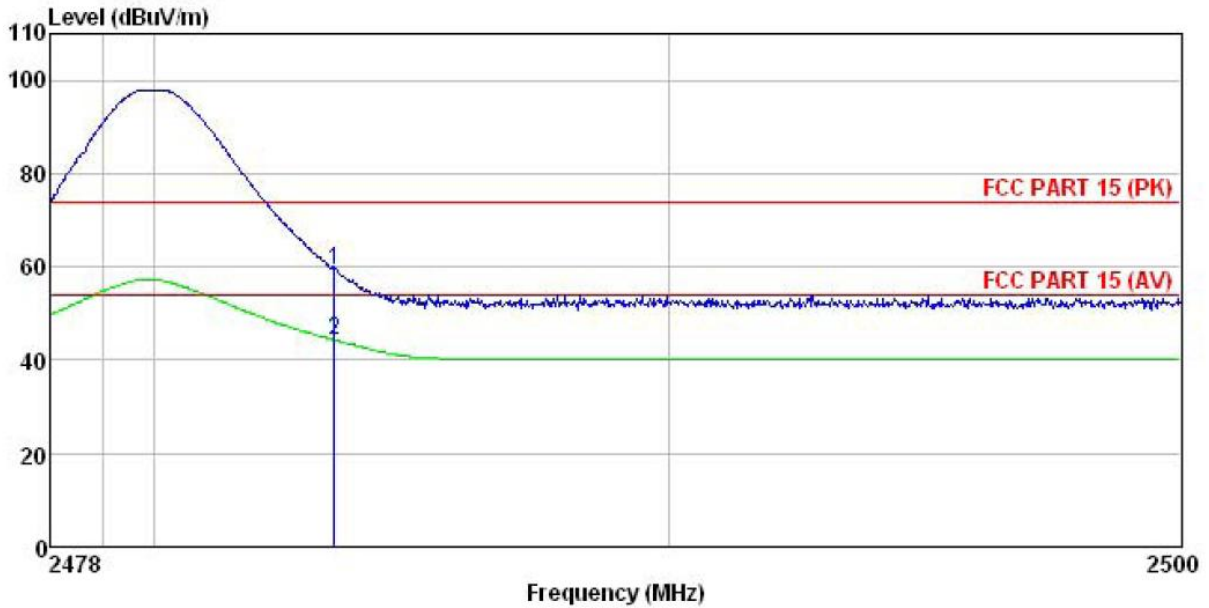

Site : 3m chamber
 Condition : FCC PART 15 (PK) 3m BBHA9120(1G18) VERTICAL
 EUT : Mobile phone
 Model : AM102
 Test mode : BT-DH1-H
 Power Rating : AC120V/60Hz
 Environment : Temp:25.5°C Humi:55%
 Test Engineer: Garen
 REMARK :

	Read	Antenna	Cable	Preamp	Limit	Over	
Freq	Level	Factor	Loss	Factor	Line	Limit	Remark
-----	-----	-----	-----	-----	-----	-----	-----
MHz	dBm	dB/m	dB	dB	dBm/m	dBm/m	dB
1	2483.500	25.96	27.52	5.70	0.00	59.18	74.00 -14.82 Peak
2	2483.500	11.10	27.52	5.70	0.00	44.32	54.00 -9.68 Average

$\pi/4$ -DQPSK mode
 Test channel: Lowest
 Horizontal:

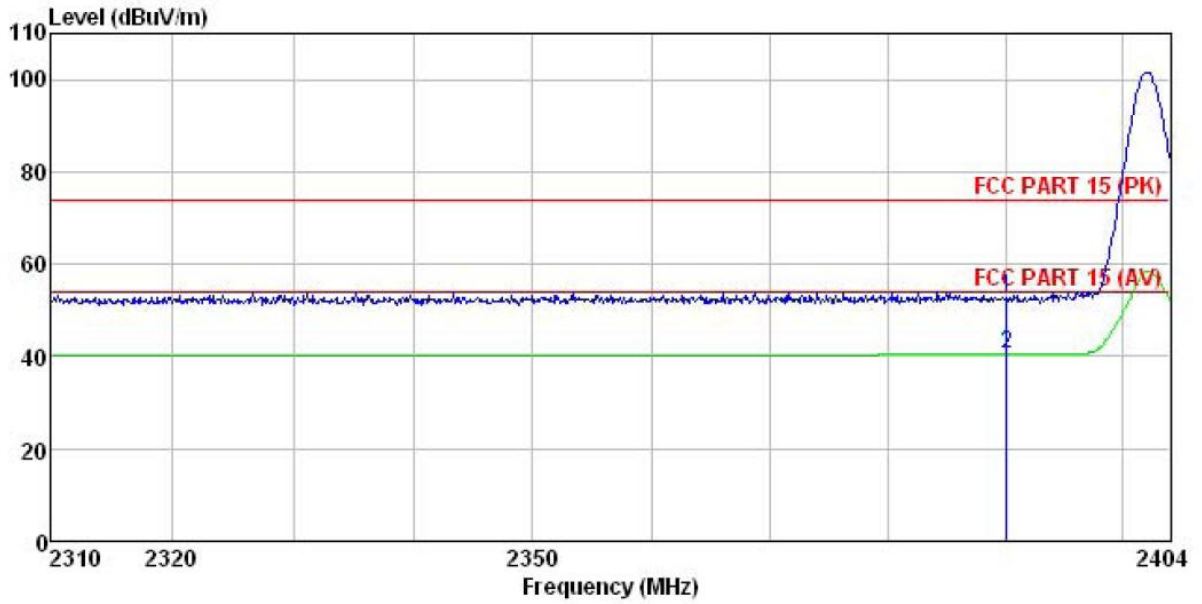

Site : 3m chamber
 Condition : FCC PART 15 (PK) 3m BBHA9120(1G18) HORIZONTAL
 EUT : Mobile phone
 Model : AM102
 Test mode : BT-2DH1-L
 Power Rating : AC120V/60Hz
 Environment : Temp:25.5°C Humi:55%
 Test Engineer: Garen
 REMARK :

	Freq	Read Level	Antenna Factor	Cable Loss	Preamp Factor	Level	Limit Line	Over Limit	Remark
	MHz	dBm	dB/m	dB	dB	dBm/m	dBm/m	dB	
1	2390.000	19.49	27.58	5.67	0.00	52.74	74.00	-21.26	Peak
2	2390.000	7.20	27.58	5.67	0.00	40.45	54.00	-13.55	Average

Vertical:

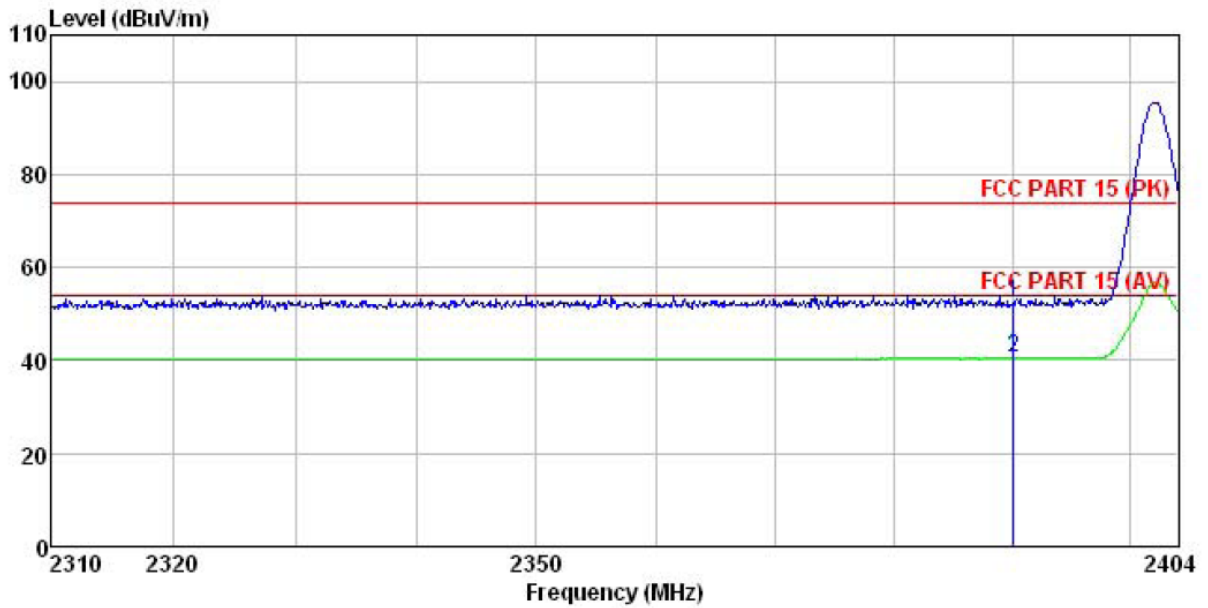

Site : 3m chamber
 Condition : FCC PART 15 (PK) 3m BBHA9120(1G18) VERTICAL
 EUT : Mobile phone
 Model : AM102
 Test mode : BT-2DH1-L
 Power Rating : AC120V/60Hz
 Environment : Temp:25.5°C Humi:55%
 Test Engineer: Garen
 REMARK :

	ReadAntenna	Cable	Preamp	Limit	Over			
Freq	Level	Factor	Loss	Factor	Line	Limit Remark		
-----MHz	-----dBm	-----dB/m	-----dB	-----dB	-----dBm/m	-----dBm/m	-----dB	
1	2390.000	18.99	27.58	5.67	0.00	52.24	74.00	-21.76 Peak
2	2390.000	7.15	27.58	5.67	0.00	40.40	54.00	-13.60 Average

Test channel: Highest

Horizontal:

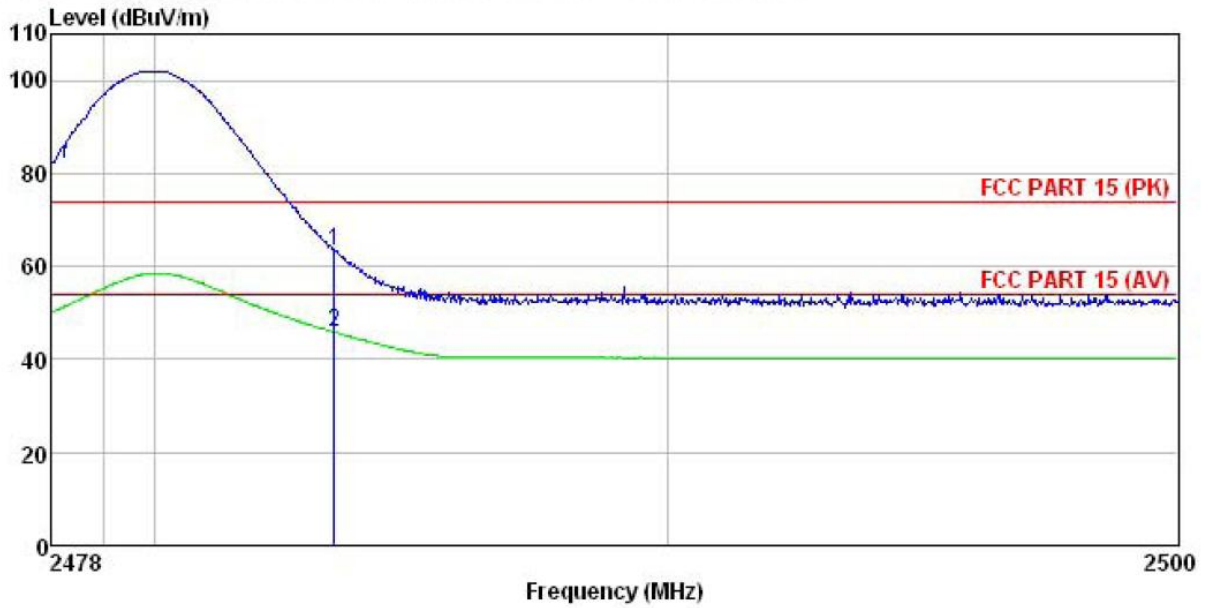

Site : 3m chamber
 Condition : FCC PART 15 (PK) 3m BBHA9120(1G18) HORIZONTAL
 EUT : Mobile phone
 Model : AM102
 Test mode : BT-2DH1-H
 Power Rating : AC120V/60Hz
 Environment : Temp:25.5°C Humi:55%
 Test Engineer: Garen
 REMARK :

	Read	Antenna	Cable	Preamp	Level	Limit	Over	
Freq	Level	Factor	Loss	Factor	Level	Line	Limit	Remark
MHz	dBm	dB/m	dB	dB	dBm/m	dBm/m	dB	
1	2483.500	29.97	27.52	5.70	0.00	63.19	74.00	-10.81 Peak
2	2483.500	12.64	27.52	5.70	0.00	45.86	54.00	-8.14 Average

Vertical:

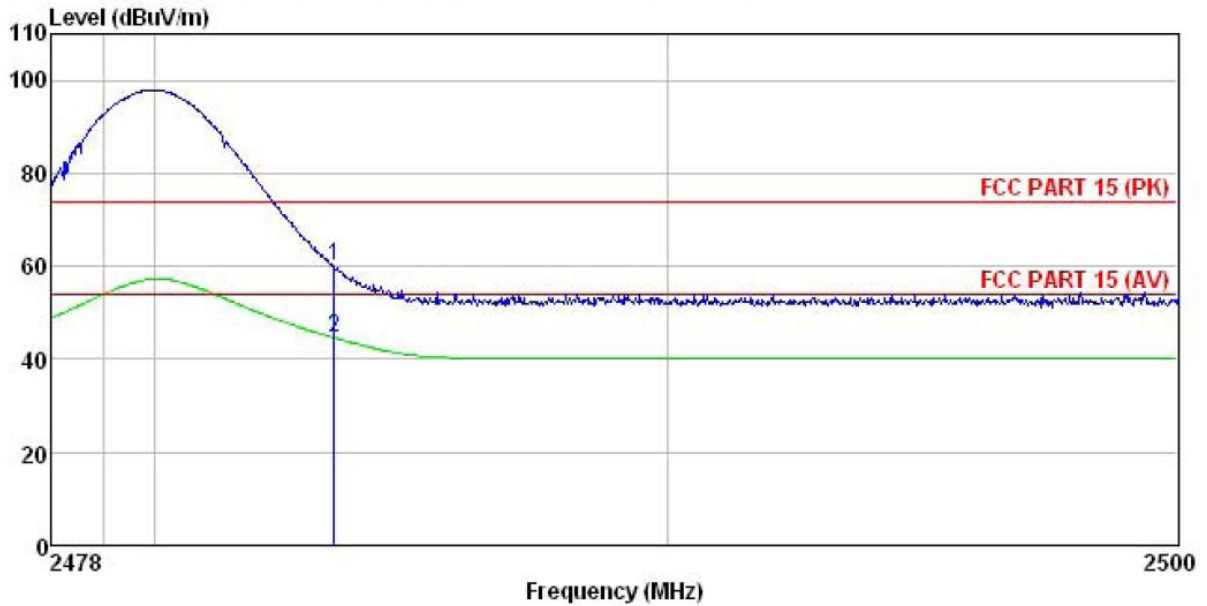

Site : 3m chamber
 Condition : FCC PART 15 (PK) 3m BBHA9120(1G18) VERTICAL
 EUT : Mobile phone
 Model : AM102
 Test mode : BT-2DH1-H
 Power Rating : AC120V/60Hz
 Environment : Temp:25.5°C Humi:55%
 Test Engineer: Garen
 REMARK :

	Read	Antenna	Cable	Preamp	Limit	Over	
Freq	Level	Factor	Loss	Factor	Line	Limit	Remark
MHz	dBm	dB/m	dB	dB	dBm/m	dBm/m	dB
1	2483.500	26.77	27.52	5.70	0.00	59.99	74.00 -14.01 Peak
2	2483.500	11.40	27.52	5.70	0.00	44.62	54.00 -9.38 Average

8DPSK mode
 Test channel: Lowest
 Horizontal:

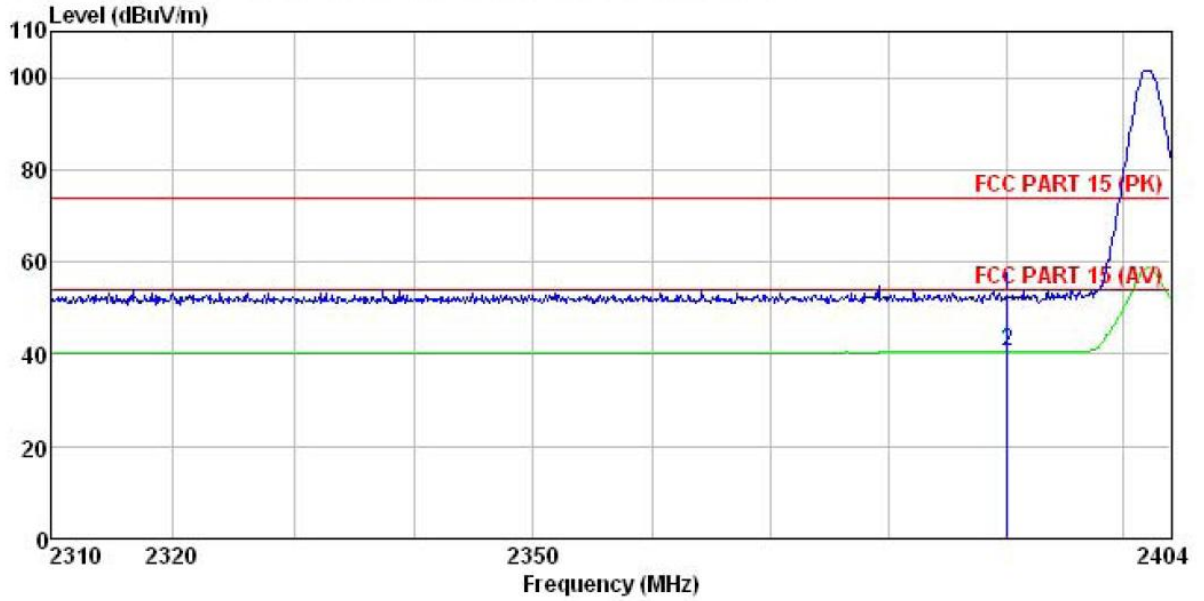

Site : 3m chamber
 Condition : FCC PART 15 (PK) 3m BBHA9120(1G18) HORIZONTAL
 EUT : Mobile phone
 Model : AM102
 Test mode : BT-3DH1-L
 Power Rating : AC120V/60Hz
 Environment : Temp:25.5°C Humi:55%
 Test Engineer: Garen
 REMARK :

	Read	Antenna	Cable	Preamp	Limit	Over	
Freq	Level	Factor	Loss	Factor	Line	Limit	Remark
MHz	dBm	dB/m	dB	dB	dBm/m	dBm/m	dB
1	2390.000	19.34	27.58	5.67	0.00	52.59	74.00 -21.41 Peak
2	2390.000	7.19	27.58	5.67	0.00	40.44	54.00 -13.56 Average

Vertical:

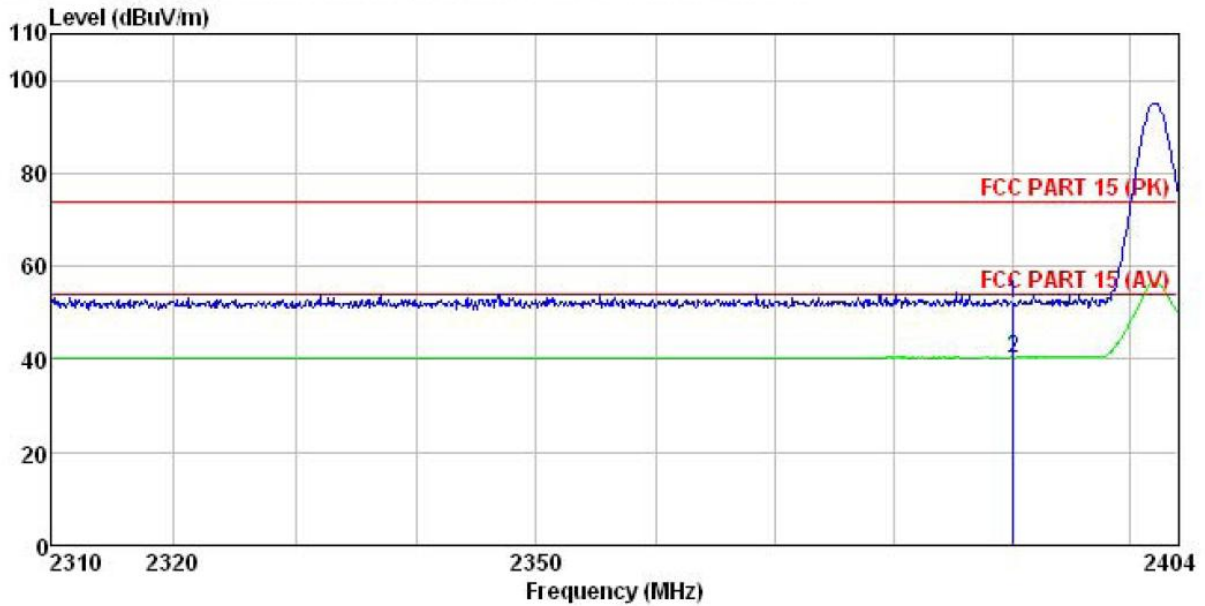

Site : 3m chamber
 Condition : FCC PART 15 (PK) 3m BBHA9120(1G18) VERTICAL
 EUT : Mobile phone
 Model : AM102
 Test mode : BT-3DH1-L
 Power Rating : AC120V/60Hz
 Environment : Temp:25.5°C Humi:55%
 Test Engineer: Garen
 REMARK :

	Freq	Read Level	Antenna Factor	Cable Loss	Preamp Factor	Level	Limit	Over Limit	Remark
	MHz	dBm	dB/m	dB	dB	dBm/m	dBm/m	dB	
1	2390.000	18.61	27.58	5.67	0.00	51.86	74.00	-22.14	Peak
2	2390.000	7.13	27.58	5.67	0.00	40.38	54.00	-13.62	Average

Test channel: Highest

Horizontal:

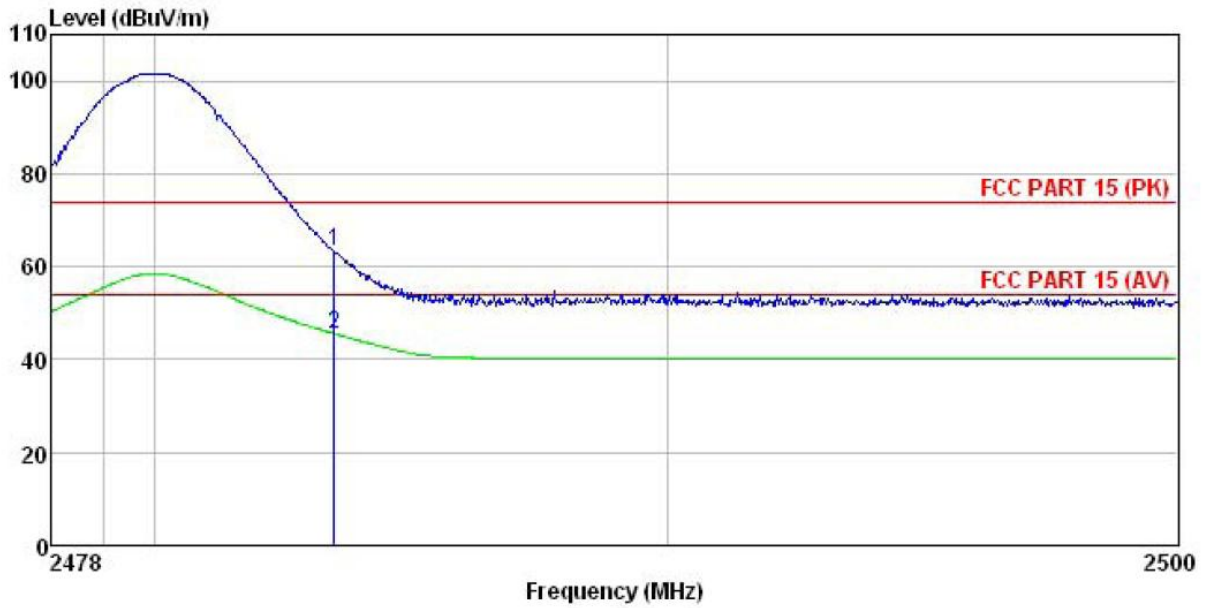

Site : 3m chamber
 Condition : FCC PART 15 (PK) 3m BBHA9120(1G18) HORIZONTAL
 EUT : Mobile phone
 Model : AM102
 Test mode : BT-3DH1-H
 Power Rating : AC120V/60Hz
 Environment : Temp:25.5°C Humi:55%
 Test Engineer: Garen
 REMARK :

	Freq	Read Level	Antenna Factor	Cable Loss	Preamp Factor	Level	Limit Line	Over Limit	Remark
	MHz	dBm	dB/m	dB	dB	dBm/m	dBm/m	dB	
1	2483.500	30.02	27.52	5.70	0.00	63.24	74.00	-10.76	Peak
2	2483.500	12.34	27.52	5.70	0.00	45.56	54.00	-8.44	Average

Vertical:

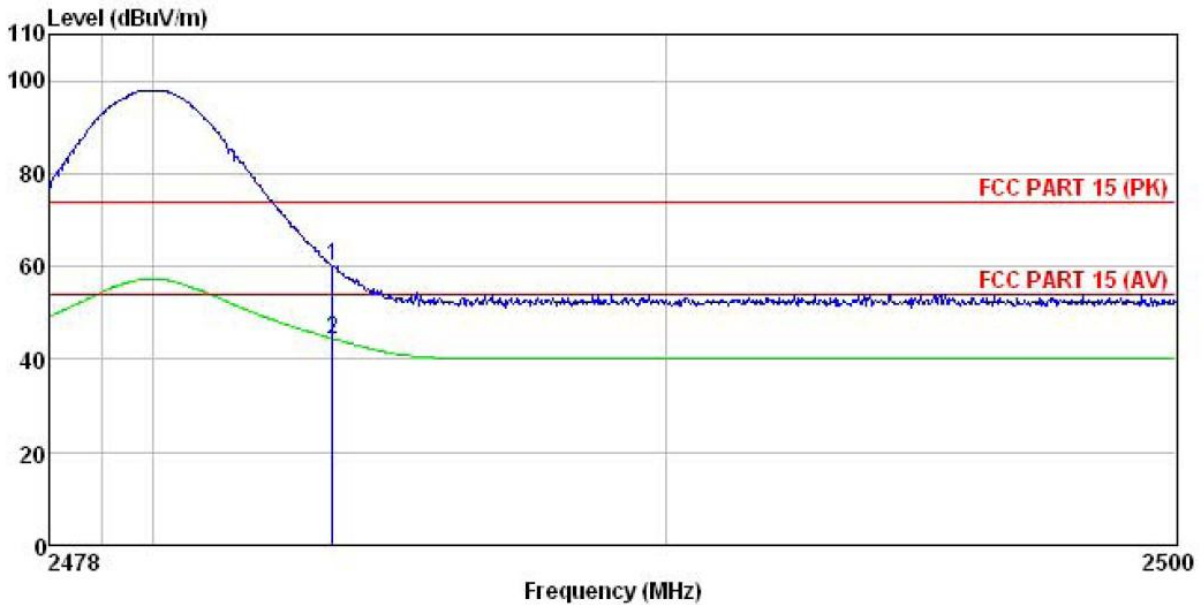

Site : 3m chamber
 Condition : FCC PART 15 (PK) 3m BBHA9120(1G18) VERTICAL
 EUT : Mobile phone
 Model : AM102
 Test mode : BT-3DH1-H
 Power Rating : AC120V/60Hz
 Environment : Temp:25.5°C Humi:55%
 Test Engineer: Garen
 REMARK :

	Read	Antenna	Cable	Preamp	Limit	Over	
Freq	Level	Factor	Loss	Factor	Line	Limit	Remark
MHz	dBm	dB/m	dB	dB	dBm/m	dBm/m	dB
1	2483.500	26.91	27.52	5.70	0.00	60.13	74.00 -13.87 Peak
2	2483.500	11.21	27.52	5.70	0.00	44.43	54.00 -9.57 Average

6.10 Spurious Emission

6.10.1 Conducted Emission Method

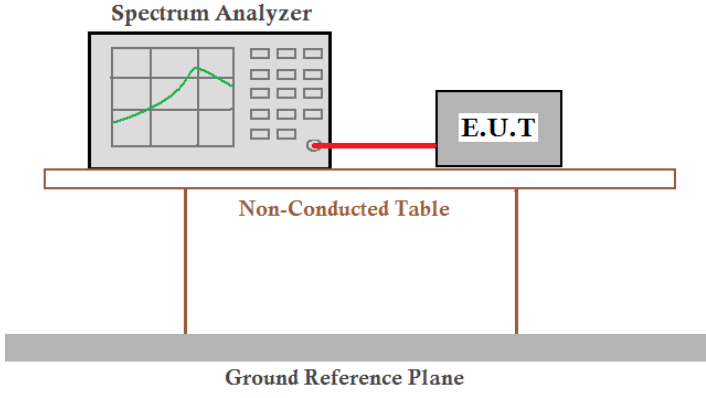
Test Requirement:	FCC Part15 C Section 15.247 (d)
Test Method:	ANSI C63.4:2003 and DA00-705
Limit:	In any 100 kHz bandwidth outside the frequency band in which the spread spectrum intentional radiator is operating, the radio frequency power that is produced by the intentional radiator shall be at least 20 dB below that in the 100 kHz bandwidth within the band that contains the highest level of the desired power, based on either an RF conducted or a radiated measurement.
Test setup:	 <p>The diagram illustrates the test setup. A Spectrum Analyzer is connected to an E.U.T (Equipment Under Test) via a red cable. Both are placed on a Non-Conducted Table, which is supported by a Ground Reference Plane.</p>
Test Instruments:	Refer to section 5.7 for details
Test mode:	Non-hopping mode
Test results:	Pass

GFSK

Lowest channel

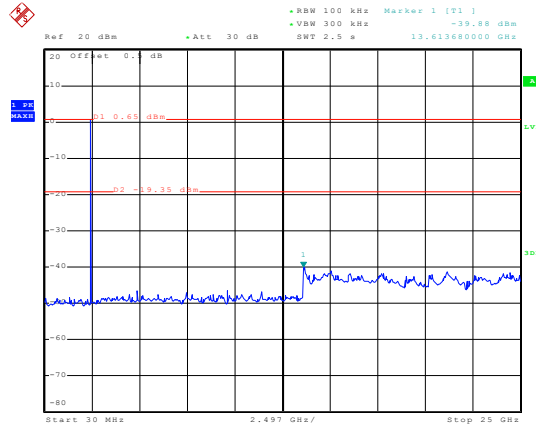

Date: 1.AUG.2014 09:24:22

30MHz~25GHz

Middle channel

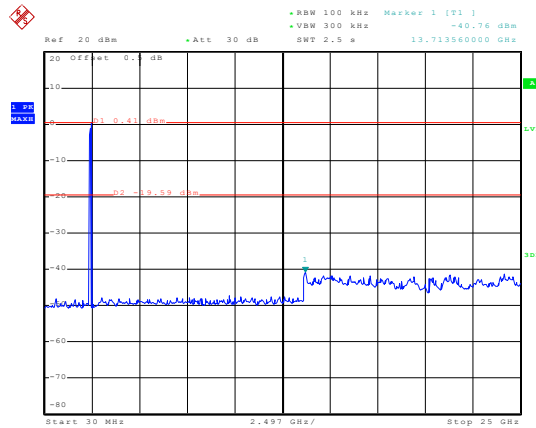

Date: 1.AUG.2014 09:23:23

30MHz~25GHz

Highest channel

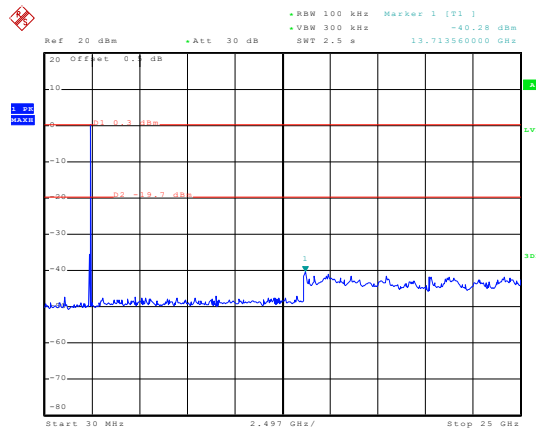

Date: 1.AUG.2014 09:22:31

30MHz~25GHz

$\pi/4$ -DQPSK

Lowest channel

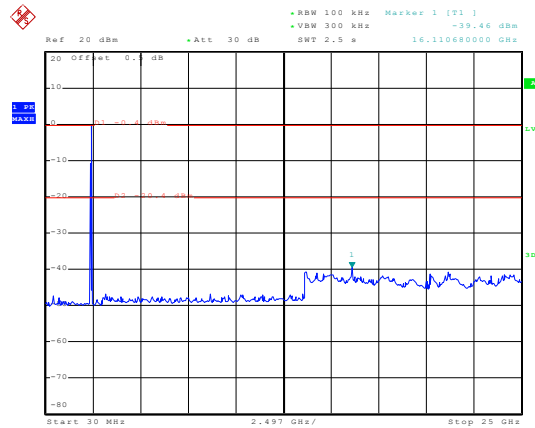

Date: 1.AUG.2014 09:18:49

30MHz~25GHz

Middle channel

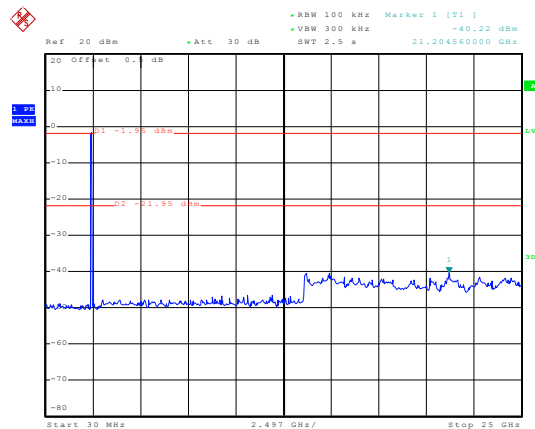

Date: 1.AUG.2014 09:20:07

30MHz~25GHz

Highest channel

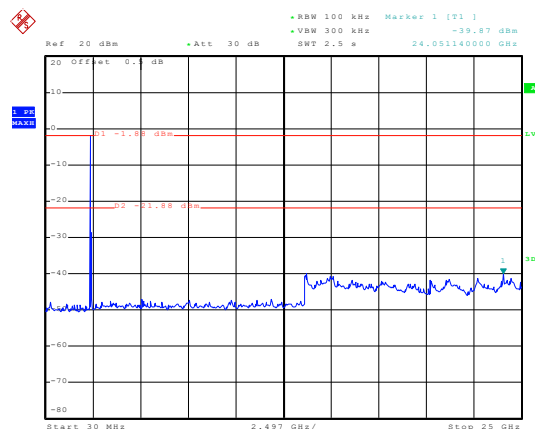

Date: 1.AUG.2014 09:21:16

30MHz~25GHz

8DPSK

Lowest channel

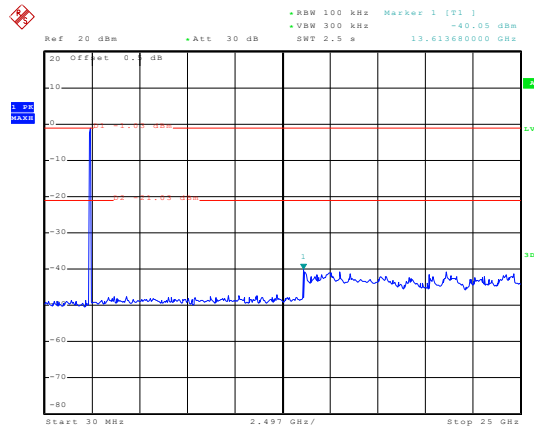

Date: 1.AUG.2014 09:16:31

30MHz~25GHz

Middle channel

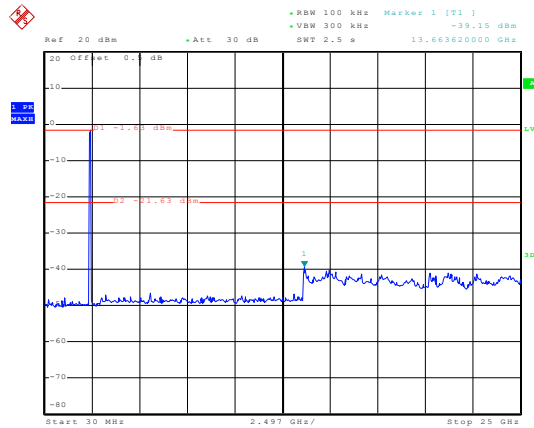

Date: 1.AUG.2014 09:14:55

30MHz~25GHz

Highest channel

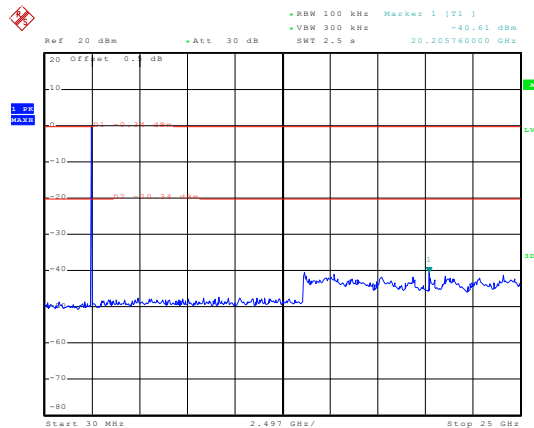

Date: 1.AUG.2014 09:29:36

30MHz~25GHz

6.10.2 Radiated Emission Method

Test Requirement:	FCC Part15 C Section 15.209				
Test Method:	ANSI C63.4: 2003				
Test Frequency Range:	9 kHz to 25 GHz				
Test site:	Measurement Distance: 3m				
Receiver setup:	Frequency	Detector	RBW	VBW	Remark
	30MHz-1GHz	Quasi-peak	120kHz	300kHz	Quasi-peak Value
	Above 1GHz	Peak	1MHz	3MHz	Peak Value
Peak		1MHz	10Hz	Average Value	
Limit:	Frequency	Limit (dBuV/m @3m)		Remark	
	30MHz-88MHz	40.0		Quasi-peak Value	
	88MHz-216MHz	43.5		Quasi-peak Value	
	216MHz-960MHz	46.0		Quasi-peak Value	
	960MHz-1GHz	54.0		Quasi-peak Value	
	Above 1GHz	54.0		Average Value	
74.0		Peak Value			
Test setup:	Below 1GHz				
Test setup:	Above 1GHz				

<p>Test Procedure:</p>	<ol style="list-style-type: none"> 1. The EUT was placed on the top of a rotating table 0.8 meters above the ground at a 3 meter camber. The table was rotated 360 degrees to determine the position of the highest radiation. 2. The EUT was set 3 meters away from the interference-receiving antenna, which was mounted on the top of a variable-height antenna tower. 3. The antenna height is varied from one meter to four meters above the ground to determine the maximum value of the field strength. Both horizontal and vertical polarizations of the antenna are set to make the measurement. 4. For each suspected emission, the EUT was arranged to its worst case and then the antenna was tuned to heights from 1 meter to 4 meters and the rota table was turned from 0 degrees to 360 degrees to find the maximum reading. 5. The test-receiver system was set to Peak Detect Function and Specified Bandwidth with Maximum Hold Mode. 6. If the emission level of the EUT in peak mode was 10dB lower than the limit specified, then testing could be stopped and the peak values of the EUT would be reported. Otherwise the emissions that did not have 10dB margin would be re-tested one by one using peak, quasi-peak or average method as specified and then reported in a data sheet.
<p>Test Instruments:</p>	<p>Refer to section 5.7 for details</p>
<p>Test mode:</p>	<p>Non-hopping mode</p>
<p>Test results:</p>	<p>Pass</p>

Remark:

1. *During the test, pre-scan the GFSK, $\pi/4$ -DQPSK, 8DPSK modulation, and found the GFSK modulation is the worst case.*
2. *Pre-scan all kind of the place mode (X-axis, Y-axis, Z-axis), and found the Y-axis is the worst case.*
3. *9 kHz to 30 MHz is noise floor, so only shows the data of above 30MHz in this report.*

Measurement data:

Below 1GHz

Vertical:

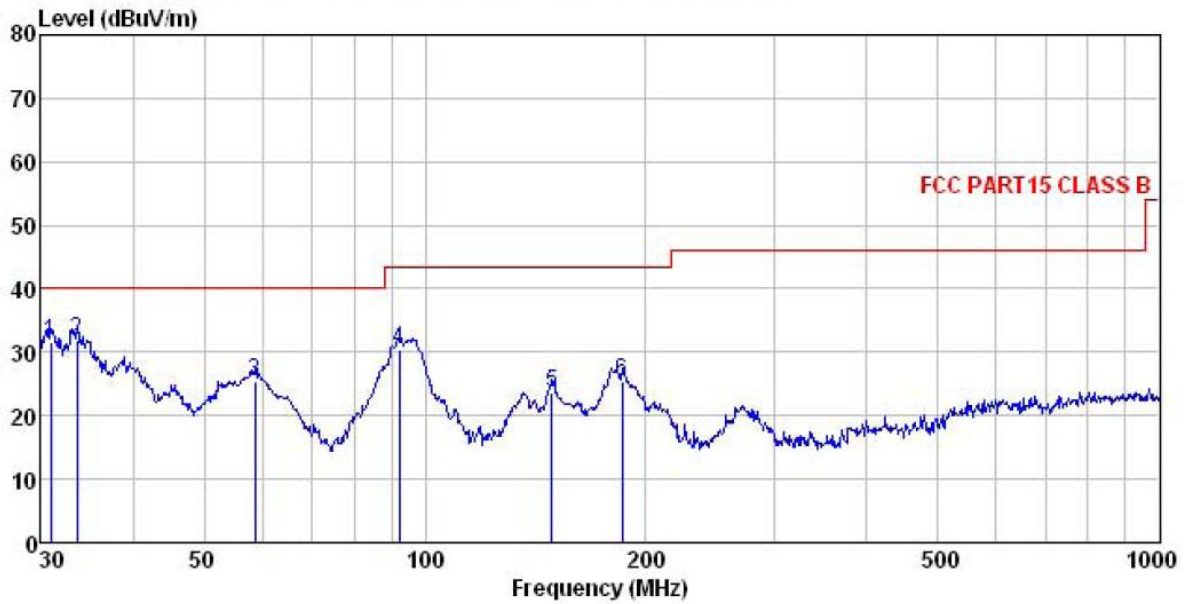

Site : 3m chamber
 Condition : FCC PART15 CLASS B 3m VULB9163(30M1G) VERTICAL
 EUT : Mobile Phone
 Model : AM102
 Test mode : BT Mode
 Power Rating : AC120V/60Hz
 Environment : Temp:25.5°C Humi:55%
 Test Engineer: Garen
 REMARK :

	ReadAntenna	Cable	Preamp	Limit	Over			
Freq	Level	Factor	Loss	Factor	Level	Line	Limit	Remark
MHz	dBuV	dB/m	dB	dB	dBuV/m	dBuV/m	dB	
1	30.962	44.99	12.32	0.78	26.38	31.71	40.00	-8.29 QP
2	33.562	45.23	12.31	0.98	26.65	31.87	40.00	-8.13 QP
3	58.613	40.31	12.79	1.37	29.09	25.38	40.00	-14.62 QP
4	92.139	45.97	12.33	2.03	30.07	30.26	43.50	-13.24 QP
5	148.963	42.03	8.26	2.51	29.25	23.55	43.50	-19.95 QP
6	185.788	41.14	10.16	2.77	28.55	25.52	43.50	-17.98 QP

Horizontal:

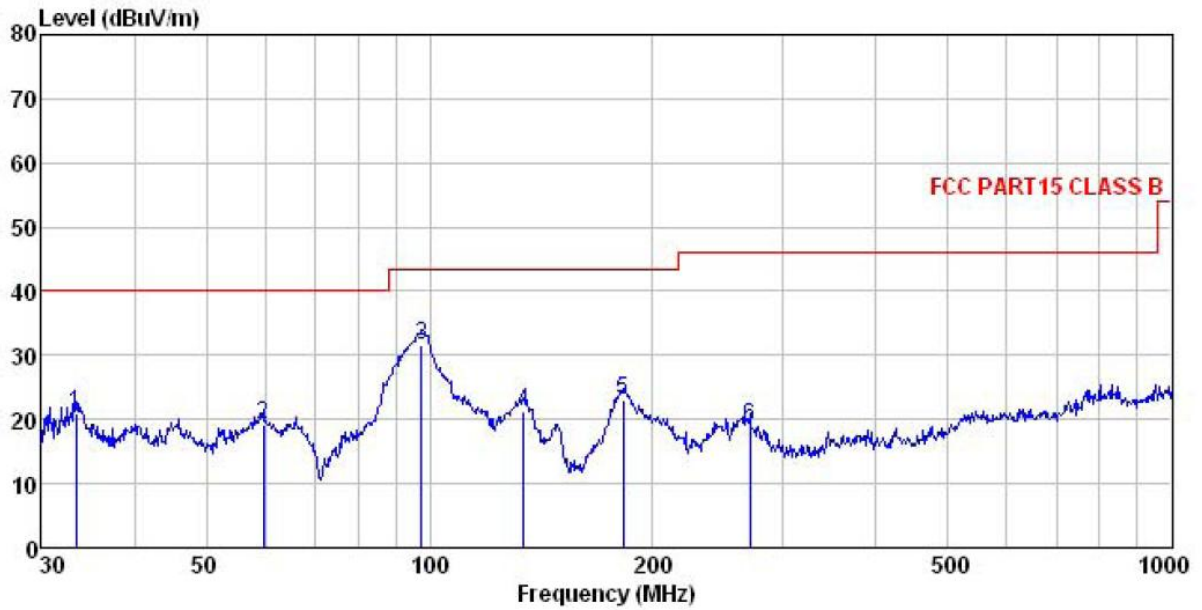

Site : 3m chamber
 Condition : FCC PART15 CLASS B 3m VULB9163(30M1G) HORIZONTAL
 EUT : Mobile Phone
 Model : AM102
 Test mode : BT Mode
 Power Rating : AC120V/60Hz
 Environment : Temp:25.5°C Humi:55%
 Test Engineer: Garen
 REMARK :

	ReadAntenna	Cable	Preamp	Limit	Over			
Freq	Level	Factor	Loss	Factor	Level	Line	Limit	Remark
MHz	dBuV	dB/m	dB	dB	dBuV/m	dBuV/m	dB	
1	33.328	34.18	12.31	0.98	26.63	20.84	40.00	-19.16 QP
2	59.649	34.33	12.73	1.38	29.17	19.27	40.00	-20.73 QP
3	97.456	46.66	13.00	1.98	30.09	31.55	43.50	-11.95 QP
4	134.088	39.88	8.61	2.33	29.47	21.35	43.50	-22.15 QP
5	182.559	37.50	9.92	2.75	27.28	22.89	43.50	-20.61 QP
6	270.375	33.30	12.38	2.86	29.53	19.01	46.00	-26.99 QP

Above 1GHz:

Test channel:			Lowest		Level:		Peak	
Frequency (MHz)	Read Level (dBuV)	Antenna Factor (dB/m)	Cable Loss (dB)	Preamp Factor (dB)	Level (dBuV/m)	Limit Line (dBuV/m)	Over Limit (dB)	Polarization
4804.00	47.07	31.53	8.90	40.24	50.47	74.00	-23.53	Vertical
7206.00	45.72	36.47	10.59	41.24	50.68	74.00	-23.32	Vertical
4804.00	46.39	31.53	8.90	40.24	46.58	74.00	-27.42	Horizontal
7206.00	45.10	36.47	10.59	41.24	50.92	74.00	-23.08	Horizontal
Test channel:			Lowest		Level:		Average	
Frequency (MHz)	Read Level (dBuV)	Antenna Factor (dB/m)	Cable Loss (dB)	Preamp Factor (dB)	Level (dBuV/m)	Limit Line (dBuV/m)	Over Limit (dB)	Polarization
4804.00	36.63	31.53	8.90	40.24	36.82	54.00	-17.18	Vertical
7206.00	35.31	36.47	10.59	41.24	41.13	54.00	-12.87	Vertical
4804.00	36.39	31.53	8.90	40.24	36.58	54.00	-17.42	Horizontal
7206.00	35.23	36.47	10.59	41.24	41.05	54.00	-12.95	Horizontal

Test channel:			Middle		Level:		Peak	
Frequency (MHz)	Read Level (dBuV)	Antenna Factor (dB/m)	Cable Loss (dB)	Preamp Factor (dB)	Level (dBuV/m)	Limit Line (dBuV/m)	Over Limit (dB)	Polarization
4882.00	46.06	31.58	8.98	40.15	46.47	74.00	-27.53	Vertical
7323.00	44.76	36.47	10.69	41.15	50.77	74.00	-23.23	Vertical
4882.00	46.64	31.58	8.98	40.15	47.05	74.00	-26.95	Horizontal
7323.00	44.45	36.47	10.69	41.15	50.46	74.00	-23.54	Horizontal
Test channel:			Middle		Level:		Average	
Frequency (MHz)	Read Level (dBuV)	Antenna Factor (dB/m)	Cable Loss (dB)	Preamp Factor (dB)	Level (dBuV/m)	Limit Line (dBuV/m)	Over Limit (dB)	Polarization
4882.00	36.51	31.58	8.98	40.15	36.92	54.00	-17.08	Vertical
7323.00	34.85	36.47	10.69	41.15	40.86	54.00	-13.14	Vertical
4882.00	36.57	31.58	8.98	40.15	36.98	54.00	-17.02	Horizontal
7323.00	33.13	36.47	10.69	41.15	39.14	54.00	-14.86	Horizontal

Remark:

1. Final Level = Receiver Read level + Antenna Factor + Cable Loss – Pre-amplifier Factor
2. “**”, means average level is not recorded when its peak level is less than average limit.
3. The emission levels of other frequencies are very lower than the limit and not show in test report.

Test channel:			Highest		Level:		Peak	
Frequency (MHz)	Read Level (dBuV)	Antenna Factor (dB/m)	Cable Loss (dB)	Preamp Factor (dB)	Level (dBuV/m)	Limit Line (dBuV/m)	Over Limit (dB)	Polarization
4960.00	46.07	31.69	9.08	40.03	46.81	74.00	-27.19	Vertical
7440.00	46.84	36.60	10.80	41.05	53.19	74.00	-20.81	Vertical
4960.00	46.80	31.69	9.08	40.03	47.54	74.00	-26.46	Horizontal
7440.00	46.16	36.60	10.80	41.05	52.51	74.00	-21.49	Horizontal
Test channel:			Highest		Level:		Average	
Frequency (MHz)	Read Level (dBuV)	Antenna Factor (dB/m)	Cable Loss (dB)	Preamp Factor (dB)	Level (dBuV/m)	Limit Line (dBuV/m)	Over Limit (dB)	Polarization
4960.00	35.38	31.69	9.08	40.03	36.12	54.00	-17.88	Vertical
7440.00	35.75	36.60	10.80	41.05	42.10	54.00	-11.90	Vertical
4960.00	35.51	31.69	9.08	40.03	36.25	54.00	-17.75	Horizontal
7440.00	36.37	36.60	10.80	41.05	42.72	54.00	-11.28	Horizontal

Remark:

1. Final Level = Receiver Read level + Antenna Factor + Cable Loss – Pre-amplifier Factor
2. “**”, means average level is not recorded when its peak level is less than average limit.
3. The emission levels of other frequencies are very lower than the limit and not show in test report.

7 Test Setup Photo

Radiated Spurious Emission

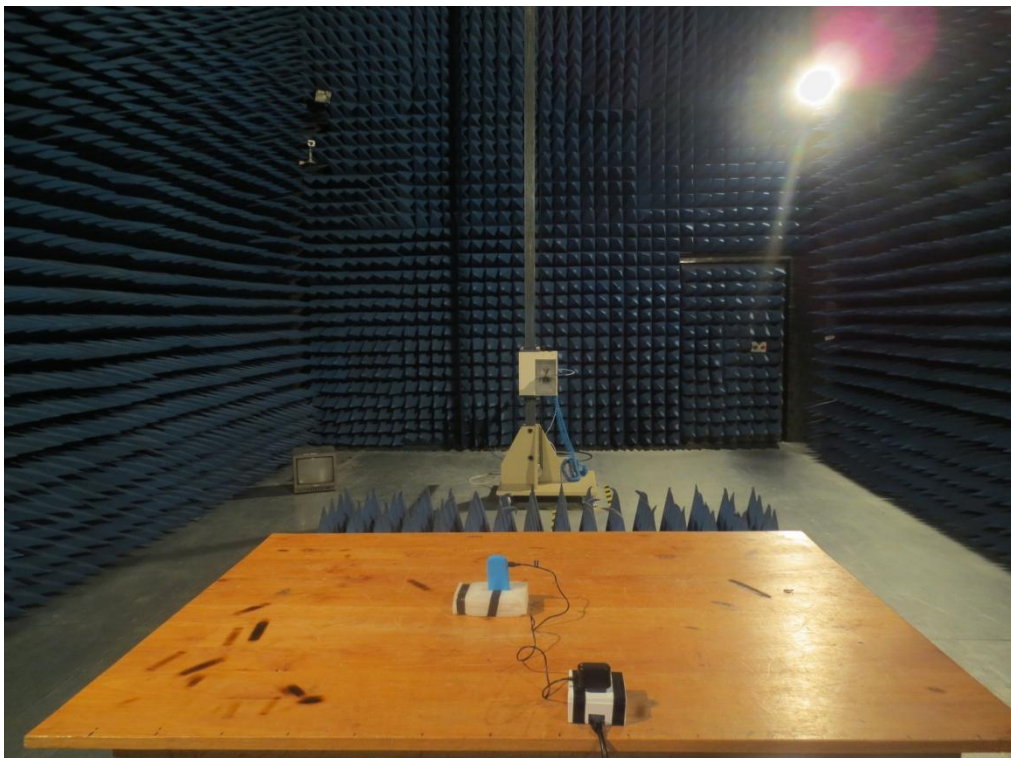
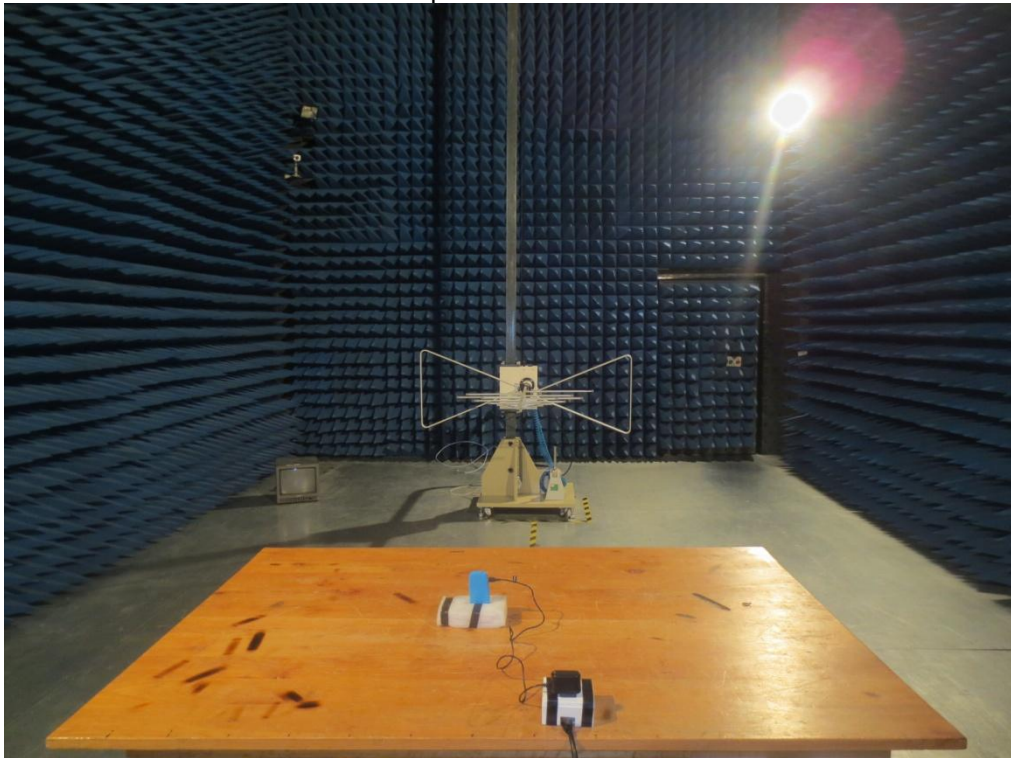

Conducted Emission



8 EUT Constructional Details

Reference to the test report No. CCIS14070055701

-----End of report-----