

FCC Test Report

Product Name	IP Aux Camera WiFi Side Mount/IP Aux Camera WiFi Rear Mount
Model No	DC-ACW-01 / DC-ACW-02
FCC ID.	UO3DCACW

Applicant	Lytx, Inc.
Address	9785 Towne Centre Drive, San Diego, California 92121

Date of Receipt	Oct. 22, 2021
Issue Date	Nov. 17, 2021
Report No.	21A0736R-RFUSWL2V01-A
Report Version	V1.0

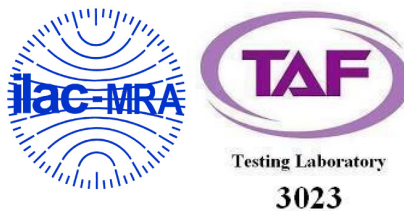

The test results relate only to the samples tested.

The test results shown in the test report are traceable to the national/international standard through the calibration report of the equipment and evaluated measurement uncertainty herein.

This report must not be used to claim product endorsement by TAF or any agency of the government.

The test report shall not be reproduced without the written approval of DEKRA Testing and Certification Co., Ltd.

Measurement uncertainties evaluated for each testing system and associated connections are given here to provide the system information for reference. Compliance determinations do not take into account measurement uncertainties for each testing system, but are based on the results of the compliance measurement.

Test Report

Issue Date: Nov. 17, 2021

Report No.: 21A0736R-RFUSWL2V01-A



Product Name	IP Aux Camera WiFi Side Mount/IP Aux Camera WiFi Rear Mount
Applicant	Lytx, Inc.
Address	9785 Towne Centre Drive, San Diego, California 92121
Manufacturer	Lytx, Inc.
Model No.	DC-ACW-01 / DC-ACW-02
FCC ID.	U03DCACW
EUT Rated Voltage	DC 12V (Power by Battery)
EUT Test Voltage	DC 12V (Power by Battery)
Trade Name	Lytx
Applicable Standard	FCC CFR Title 47 Part 15 Subpart C ANSI C63.4: 2014, ANSI C63.10: 2013
Test Result	Complied

Documented By :

Joanne Lin

(Senior Project Specialist / Joanne Lin)

Tested By :

Ivan Chuang

(Senior Engineer / Ivan Chuang)

Approved By :

Alan Chen

(Senior Engineer / Alan Chen)

TABLE OF CONTENTS

Description	Page
1. GENERAL INFORMATION	6
1.1. EUT Description.....	6
1.2. Tested System Details.....	8
1.3. Configuration of Tested System	8
1.4. EUT Exercise Software	8
1.5. Test Facility	9
1.6. List of Test Item and Equipment	10
1.7. Uncertainty	12
2. Conducted Emission.....	13
2.1. Test Setup	13
2.2. Limits	13
2.3. Test Procedure	13
2.4. Test Result of Conducted Emission.....	14
3. Peak Power Output	15
3.1. Test Setup	15
3.2. Limits	15
3.3. Test Procedure	15
3.4. Test Result of Peak Power Output.....	16
4. Radiated Emission	19
4.1. Test Setup	19
4.2. Limits	20
4.3. Test Procedure	21
4.4. Test Result of Radiated Emission.....	23
5. RF antenna conducted test.....	28
5.1. Test Setup	28
5.2. Limits	28
5.3. Test Procedure	28
5.4. Test Result of RF antenna conducted test.....	29
6. Band Edge	32
6.1. Test Setup	32
6.2. Limits	33
6.3. Test Procedure	33
6.4. Test Result of Band Edge	35
7. 6dB Bandwidth	41
7.1. Test Setup	41
7.2. Limits	41
7.3. Test Procedure	41
7.4. Test Result of 6dB Bandwidth.....	42
8. Power Density	45
8.1. Test Setup	45

8.2.	Limits	45
8.3.	Test Procedure	45
8.4.	Test Result of Power Density	46
9.	Duty Cycle	49
9.1.	Test Setup	49
9.2.	Test Procedure	49
9.3.	Test Result of Duty Cycle.....	50
10.	EMI Reduction Method During Compliance Testing	52

Appendix 1: EUT Test Photographs

Appendix 2: Product Photos-Please refer to the file: 21A0736R-Product Photos

Revision History

Report No.	Version	Description	Issued Date
21A0736R-RFUSWL2V01-A	V1.0	Initial issue of report.	2021-11-17

1. GENERAL INFORMATION

1.1. EUT Description

Product Name	IP Aux Camera WiFi Side Mount/IP Aux Camera WiFi Rear Mount
Trade Name	Lytx
Model No.	DC-ACW-01 / DC-ACW-02
FCC ID.	UO3DCACW
Frequency Range	802.11b/g/n-20BW: 2412-2462MHz
Number of Channels	802.11b/g/n-20MHz: 11
Data Speed	802.11b: 1-11Mbps, 802.11g: 6-54Mbps, 802.11n: up to 72.2Mbps
Channel separation	802.11b/g/n: 5 MHz
Type of Modulation	802.11b: DSSS (DBPSK, DQPSK, CCK) 802.11g/n: OFDM (BPSK, QPSK, 16QAM, 64QAM)
Antenna Type	PIFA Antenna
Antenna Gain	Refer to the table "Antenna List"
Channel Control	Auto

Antenna List

No.	Manufacturer	Part No.	Antenna Type	Peak Gain
1	Grand-Tek Technology CO., Ltd.	YR0374506070020	PIFA Antenna	5.3dBi for 2.4 GHz

Note: The antenna of EUT is conforming to FCC 15.203.

802.11b/g/n-20MHz Center Frequency of Each Channel:

Channel	Frequency	Channel	Frequency	Channel	Frequency	Channel	Frequency
Channel 01:	2412 MHz	Channel 02:	2417 MHz	Channel 03:	2422 MHz	Channel 04:	2427 MHz
Channel 05:	2432 MHz	Channel 06:	2437 MHz	Channel 07:	2442 MHz	Channel 08:	2447 MHz
Channel 09:	2452 MHz	Channel 10:	2457 MHz	Channel 11:	2462 MHz		

Note:

1. The EUT is an IP Aux Camera WiFi Side Mount/IP Aux Camera WiFi Rear Mount with built-in WLAN (802.11b/g/n) transceiver, this report for 2.4GHz WLAN.
2. Regarding to the operation frequency, the lowest, middle and highest frequency are selected to perform the test.
3. The different of the two models is shown as below:

Product Name	Model Number
IP Aux Camera WiFi Side Mount	DC-ACW-01
IP Aux Camera WiFi Rear Mount	DC-ACW-02

4. Lowest and highest data rates are tested in each mode. Only worst case is shown in the report.
5. These tests are conducted on a sample for the purpose of demonstrating compliance of transmitter with Part 15 Subpart C Paragraph 15.247 of spread spectrum devices.

Test Mode	Mode 1: Transmit (802.11b 1Mbps)
	Mode 2: Transmit (802.11g 6Mbps)
	Mode 3: Transmit (802.11n-20MBW 7.2Mbps)

1.2. Tested System Details

The types for all equipment, plus descriptions of all cables used in the tested system (including inserted cards) are:

Product	Manufacturer	Model No.	Serial No.	Power Cord
1 Battery	YUASA	55B24L-CMF II	N/A	N/A
2 Notebook PC	DELL	Latitude E5440	74BTK32	N/A

Signal Cable Type	Signal cable Description
A UR Cable	Non-shielded, 1m
B Signal Cable	Non-shielded, 0.28m
C Power Cable	Non-shielded, 3m

1.3. Configuration of Tested System

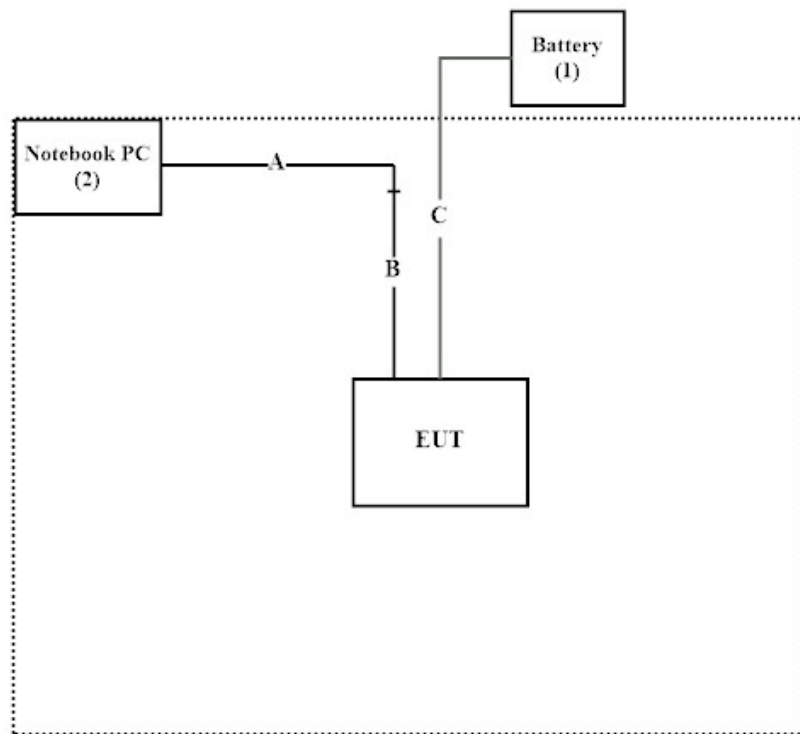

1.4. EUT Exercise Software

1. Setup the EUT as shown in Section 1.4.
2. Execute software “Tera Term Version 4.105 (SVN #8433)” on the EUT.
3. Configure the test mode, the test channel, and the data rate.
4. Press “OK” to start the continuous Transmit.
5. Verify that the EUT works properly.

1.5. Test Facility

Ambient conditions in the laboratory:

Performed Item	Items	Required	Actual
Radiated Emission	Temperature (°C)	10~40 °C	25.9°C
	Humidity (%RH)	10~90 %	62.3%
Conductive	Temperature (°C)	10~40 °C	23.6°C
	Humidity (%RH)	10~90 %	57%

USA : **FCC Registration Number: TW0033**

Canada : **IC Registration Number: 26930**

Site Description : Accredited by TAF
Accredited Number: 3023

Test Laboratory : DEKRA Testing and Certification Co., Ltd
Address : No. 5-22, Ruishukeng Linkou District, New Taipei City, 24451, Taiwan
Performed Location : No. 26, Huaya 1st Rd., Guishan Dist., Taoyuan City 333411, Taiwan,
R.O.C.
Phone number : +886-3-275-7255
Fax number : +866-3-327-8031
Email address : info.tw@dekra.com
Website : <http://www.dekra.com.tw>

1.6. List of Test Item and Equipment

For Conducted measurements /SH2

	Equipment	Manufacturer	Model No.	Serial No.	Cal. Date	Due. Date
X	Spectrum Analyzer	R&S	FSV30	103464	2021.03.25	2022.03.24
X	Peak Power Analyzer	KEYSIGHT	8900B	MY51000539	2021.06.07	2022.06.06
X	Power Sensor	KEYSIGHT	N1923A	MY59240002	2021.05.17	2022.05.16
X	Power Sensor	KEYSIGHT	N1923A	MY59240003	2021.05.17	2022.05.16

Note:

1. All equipments are calibrated every one year.
2. The test instruments marked with "X" are used to measure the final test results.
3. Test Software version : DEKRA Conduction Test System V9.0.5.

For Radiated measurements /966-2

	Equipment	Manufacturer	Model No.	Serial No.	Cal. Date	Due. Date
X	Loop Antenna	AMETEK	HLA6121	56736	2021.04.14	2022.04.13
X	Bi-Log Antenna	SCHWARZBECK	VULB9168	9168-953	2021.01.29	2022.01.28
	Horn Antenna	ETS-Lindgren	3117	00203799	2020.12.22	2021.12.21
	Horn Antenna	Com-Power	AH-840	101087	2021.06.16	2022.06.15
X	Pre-Amplifier	EMCI	EMC001330	980302	2021.07.06	2022.07.05
	Pre-Amplifier	EMCI	EMC051835SE	980312	2021.02.24	2022.02.23
	Pre-Amplifier	EMCI	EMC05820SE	980361	2020.12.21	2021.12.20
	Pre-Amplifier	EMCI	EMC184045SE	980314	2021.06.24	2022.06.23
X	Filter	MICRO TRONICS	BRM50702	G251	2021.09.16	2022.09.15
	Filter	MICRO TRONICS	BRM50716	G188	2021.09.16	2022.09.15
X	EMI Test Receiver	R&S	ESR	102792	2020.12.15	2021.12.14
	Spectrum Analyzer	R&S	FSV3044	101114	2021.02.04	2022.02.03
X	Coaxial Cable	SGH	HA800 , SGH18	HY2105-002C	2021.03.03	2022.03.02
	Mircoflex Cable	HUBER SUHNER	SUCOFLEX 102	MY3381/2	2021.06.25	2022.06.24

Note:

1. All equipments are calibrated every one year.
2. The test instruments marked with "X" are used to measure the final test results.
3. Test Software version : AUDIX e3 V9.

For Radiated measurements /966-4

	Equipment	Manufacturer	Model No.	Serial No.	Cal. Date	Due. Date
	Loop Antenna	AMETEK	HLA6121	56736	2021.04.14	2022.04.13
	Bi-Log Antenna	SCHWARZBECK	VULB9168	9168-0678	2021.01.29	2022.01.28
X	Horn Antenna	ETS-Lindgren	3117	00228113	2021.06.23	2022.06.22
X	Horn Antenna	Com-Power	AH-840	101087	2021.06.16	2022.06.15
	Pre-Amplifier	SGH	EM330	060736	2021.08.11	2022.08.10
X	Pre-Amplifier	SGH	PRAMP118	20200701	2021.08.11	2022.08.10
X	Pre-Amplifier	SGH	PRAMP0510	20200703	2021.08.11	2022.08.10
X	Pre-Amplifier	SGH	EMC184045SE	980369	2021.04.27	2022.04.26
X	Filter	MICRO TRONICS	BRM50702	G251	2021.09.16	2022.09.15
	Filter	MICRO TRONICS	BRM50716	G188	2021.09.16	2022.09.15
X	Spectrum Analyzer	R&S	FSV3044	101114	2021.02.04	2022.02.03
X	Coaxial Cable	SGH, EMCI	HA800 , SGH18	HY2108-004C	2021.03.03	2022.03.02
X	Mircoflex Cable	HUBER SUHNER	SUCOFLEX 102	MY3381/2	2021.06.25	2022.06.24

Note:

1. All equipments are calibrated every one year.
2. The test instruments marked with "X" are used to measure the final test results.
3. Test Software version : AUDIX e3 V9.

1.7. Uncertainty

Uncertainties have been calculated according to the DEKRA internal document, and is described in each test chapter of this report.

The reported expanded uncertainties are based on a standard uncertainty multiplied by a coverage factor of $k=2$, providing a level of confidence of approximately 95%.

Measurement uncertainties evaluated for each testing system and associated connections are given here to provide the system information for reference. Compliance determinations do not take into account measurement uncertainties for each testing system, but are based on the results of the compliance measurement.

Test item	Uncertainty	
Conducted Emission	±3.42 dB	
Peak Power Output	±0.91 dB	
Radiated Emission	Under 1GHz ±4.06 dB	Above 1GHz ±3.73 dB
RF Antenna Conducted Test	±2.53 dB	
Band Edge	Under 1GHz ±4.06 dB	Above 1GHz ±3.73 dB
6dB Bandwidth	±682.83 Hz	
Power Density	±2.53 dB	
Duty Cycle	±2.31 ms	

2. Conducted Emission

2.1. Test Setup

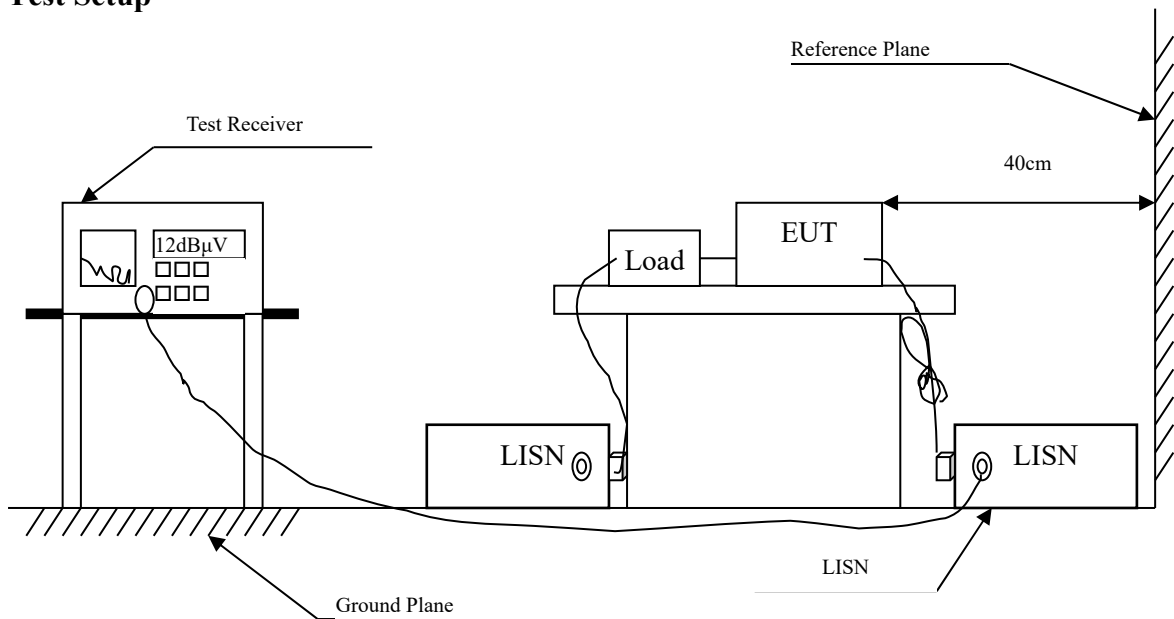

2.2. Limits

FCC Part 15 Subpart C Paragraph 15.207 (dB μ V) Limit		
Frequency MHz	Limits	
	QP	AVG
0.15 - 0.50	66-56	56-46
0.50-5.0	56	46
5.0 - 30	60	50

2.3. Test Procedure

The EUT and simulators are connected to the main power through a line impedance stabilization network (L.I.S.N.). This provides a 50 ohm /50uH coupling impedance for the measuring equipment. The peripheral devices are also connected to the main power through a LISN that provides a 50ohm /50uH coupling impedance with 50ohm termination. (Please refers to the block diagram of the test setup and photographs.)

Both sides of A.C. line are checked for maximum conducted interference. In order to find the maximum emission, the relative positions of equipment and all of the interface cables must be changed according to ANSI C63.4: 2014 on conducted measurement.

Conducted emissions were investigated over the frequency range from 0.15MHz to 30MHz using a receiver bandwidth of 9kHz.

2.4. Test Result of Conducted Emission

Owing to the EUT use battery supply voltage, this test item is not performed.

3. Peak Power Output

3.1. Test Setup

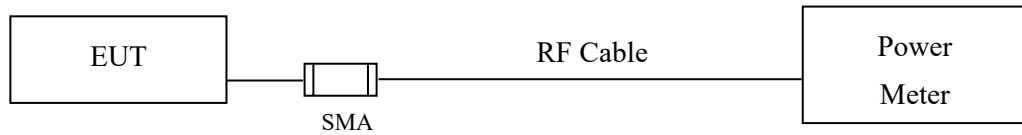

3.2. Limits

The maximum peak power shall be less 1 Watt.

3.3. Test Procedure

The EUT was tested according to C63.10:2013 for compliance to FCC 47CFR 15.247 requirements. The maximum peak conducted output power using C63.10:2013 Section 11.9.1.3 PKPM1 Peak power meter method. The maximum average conducted output power using C63.10:2013 Section 11.9.2.3 Measurement using a power meter (PM). (Measurement using a gated RF average-reading power meter).

3.4. Test Result of Peak Power Output

Product : IP Aux Camera WiFi Side Mount/IP Aux Camera WiFi Rear Mount
 Test Item : Peak Power Output Data
 Test Mode : Mode 1: Transmit (802.11b 1Mbps)
 Test Date : 2021/10/28

Channel No.	Frequency (MHz)	Average Power For different Data Rate (Mbps)				Peak Power	Required Limit	Result
		1	2	5.5	11			
		Measurement Level (dBm)						
01	2412	11.72	--	--	--	13.46	<30dBm	Pass
06	2437	11.69	11.63	11.58	11.49	13.99	<30dBm	Pass
11	2462	12.04	--	--	--	14.31	<30dBm	Pass

Note: Peak Power Output Value = Reading value on power meter + cable loss

Product : IP Aux Camera WiFi Side Mount/IP Aux Camera WiFi Rear Mount
 Test Item : Peak Power Output Data
 Test Mode : Mode 2: Transmit (802.11g 6Mbps)
 Test Date : 2021/10/28

Channel No.	Frequency (MHz)	Average Power For different Data Rate (Mbps)								Peak Power	Required Limit	Result
		6	9	12	18	24	36	48	54			
		Measurement Level (dBm)										
01	2412	12.88	--	--	--	--	--	--	--	20.61	<30dBm	Pass
06	2437	13.10	13.07	13.04	12.96	12.91	12.84	12.78	12.71	21.74	<30dBm	Pass
11	2462	13.47	--	--	--	--	--	--	--	22.23	<30dBm	Pass

Note: Peak Power Output Value =Reading value on power meter + cable loss

Product : IP Aux Camera WiFi Side Mount/IP Aux Camera WiFi Rear Mount
 Test Item : Peak Power Output Data
 Test Mode : Mode 3: Transmit (802.11n-20MBW 7.2Mbps)
 Test Date : 2021/10/28

Channel No.	Frequency (MHz)	Average Power								Peak Power	Required Limit	Result
		For different Data Rate (Mbps)										
		7.2	14.4	21.7	28.9	43.3	57.8	65	72.2	7.2		
Measurement Level (dBm)												
01	2412	12.76	--	--	--	--	--	--	--	20.89	<30dBm	Pass
06	2437	13.15	13.1	13.07	13.04	13.01	12.93	12.83	12.75	21.06	<30dBm	Pass
11	2462	13.31	--	--	--	--	--	--	--	21.51	<30dBm	Pass

Note: Peak Power Output Value = Reading value on power meter + cable loss

4. Radiated Emission

4.1. Test Setup

Radiated Emission Under 30MHz

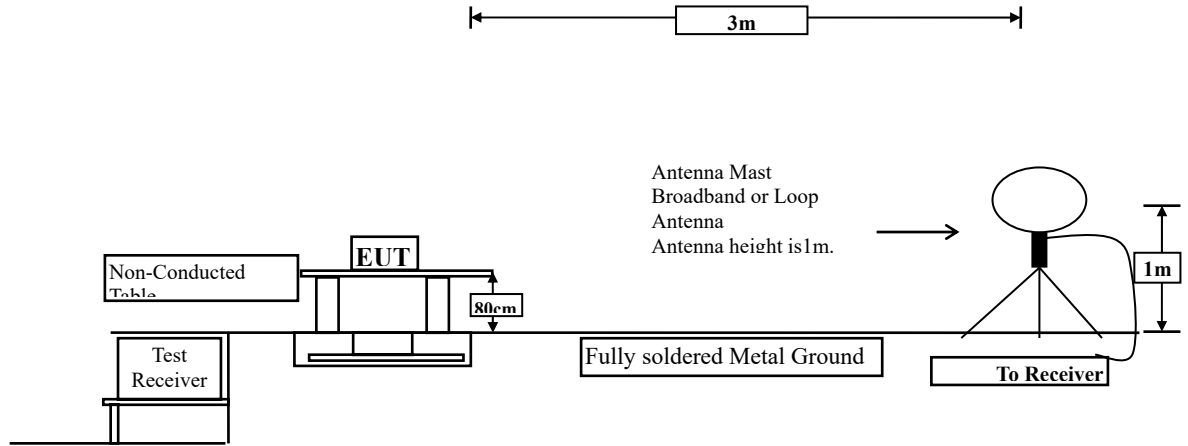

Radiated Emission Below 1GHz

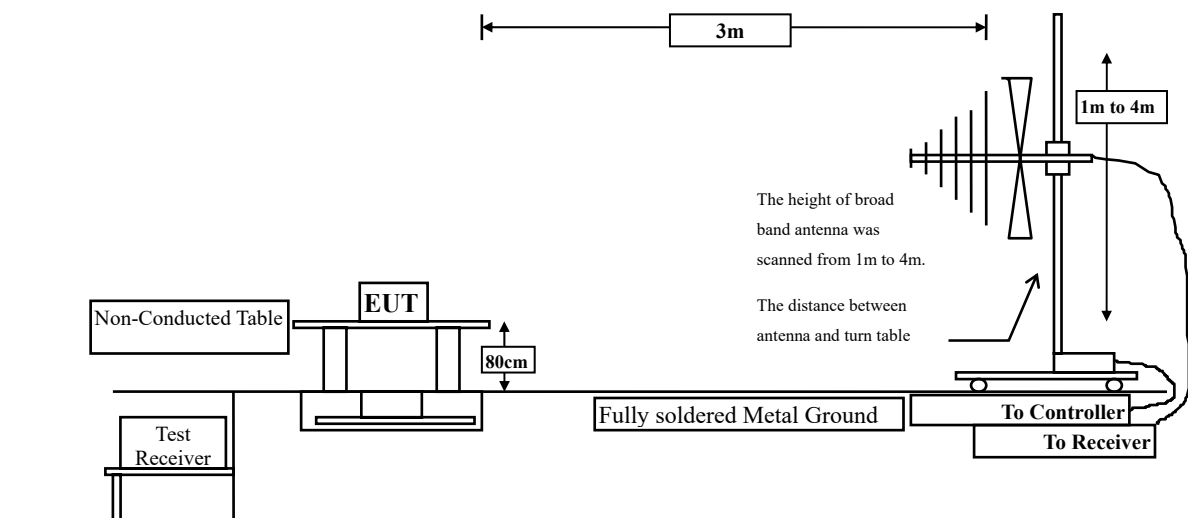

Radiated Emission Above 1GHz

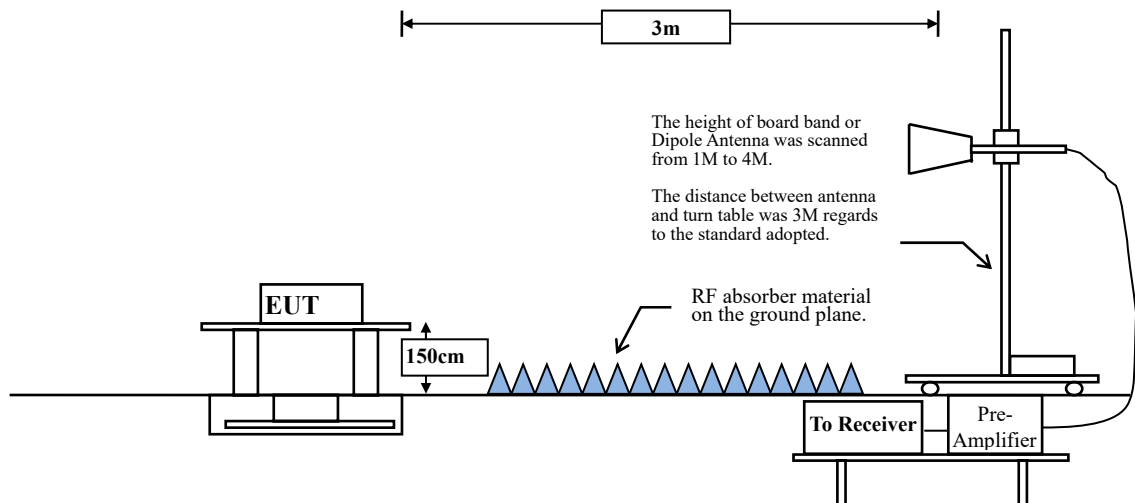

4.2. Limits

➤ General Radiated Emission Limits

Emissions radiated outside of the specified frequency bands, except for harmonics, shall be attenuated by at least 20dB below the level of the fundamental or to the general radiated emission limits in paragraph 15.209, whichever is the lesser attenuation.

FCC Part 15 Subpart C Paragraph 15.209 Limits		
Frequency MHz	Field strength (microvolts/meter)	Measurement distance (meter)
0.009-0.490	2400/F(kHz)	300
0.490-1.705	24000/F(kHz)	30
1.705-30	30	30
30-88	100	3
88-216	150	3
216-960	200	3
Above 960	500	3

- Remarks:
1. RF Voltage (dBuV) = 20 log RF Voltage (uV)
 2. In the Above Table, the tighter limit applies at the band edges.
 3. Distance refers to the distance in meters between the measuring instrument antenna and the closed point of any part of the device or system.

4.3. Test Procedure

The EUT was setup according to ANSI C63.10: 2013 and tested according to C63.10:2013 Section 11.12.1 for compliance to FCC 47CFR 15.247 requirements.

Measuring the frequency range below 1GHz, the EUT is placed on a turn table which is 0.8 meter above ground, when measuring the frequency range above 1GHz, the EUT is placed on a turn table which is 1.5 meter above ground.

The turn table is rotated 360 degrees to determine the position of the maximum emission level.

The EUT was positioned such that the distance from antenna to the EUT was 3 meters.

The antenna is scanned between 1 meter and 4 meters to find out the maximum emission level. This is repeated for both horizontal and vertical polarization of the antenna. In order to find the maximum emission, all of the interface cables were manipulated according to ANSI C63.10: 2013 on radiated measurement.

The resolution bandwidth below 30MHz setting on the field strength meter is 9kHz and 30MHz~1GHz is 120kHz and above 1GHz is 1MHz.

Radiated emission measurements below 30MHz are made using Loop Antenna and 30MHz~1GHz are made using broadband Bilog antenna and above 1GHz are made using Horn Antennas.

The measurement is divided into the Preliminary Measurement and the Final Measurement.

The suspected frequencies are searched for in Preliminary Measurement with the measurement antenna kept pointed at the source of the emission both in azimuth and elevation, with the polarization of the antenna oriented for maximum response. The antenna is pointed at an angle towards the source of the emission, and the EUT is rotated in both height and polarization to maximize the measured emission. The emission is kept within the illumination area of the 3 dB bandwidth of the antenna.

The measurement frequency range from 9kHz - 10th Harmonic of fundamental was investigated.

RBW and VBW Parameter setting:

According to C63.10 Section 11.12.2.4 Peak measurement procedure.

RBW = as specified in Table 1.

VBW \geq 3 x RBW.

Table 1 —RBW as a function of frequency

Frequency	RBW
9-150 kHz	200-300 Hz
0.15-30 MHz	9-10 kHz
30-1000 MHz	100-120 kHz
> 1000 MHz	1 MHz

According to C63.10 Section 11.12.2.5 Average measurement procedure.

RBW = 1MHz.

VBW = 10Hz, when duty cycle \geq 98 %

VBW \geq 1/T, when duty cycle < 98 %

(T refers to the minimum transmission duration over which the transmitter is on and is transmitting at its maximum power control level for the tested mode of operation.)

2.4GHz band	Duty Cycle (%)	T (ms)	1/T (Hz)	VBW (Hz)
802.11b	98.98	8.4348	119	10
802.11g	93.23	1.3985	715	1000
802.11n20	93.29	1.3115	762	1000

Note: Duty Cycle Refer to Section 9.

4.4. Test Result of Radiated Emission

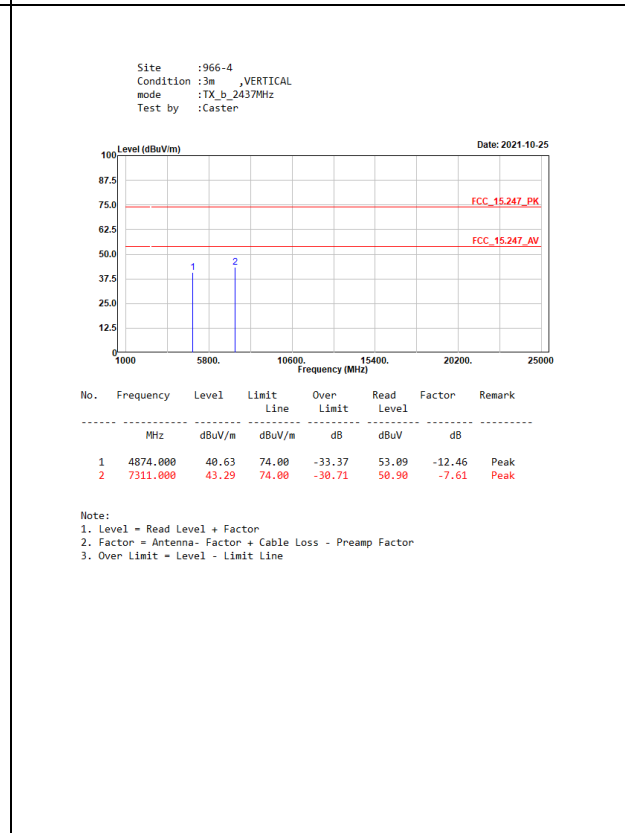
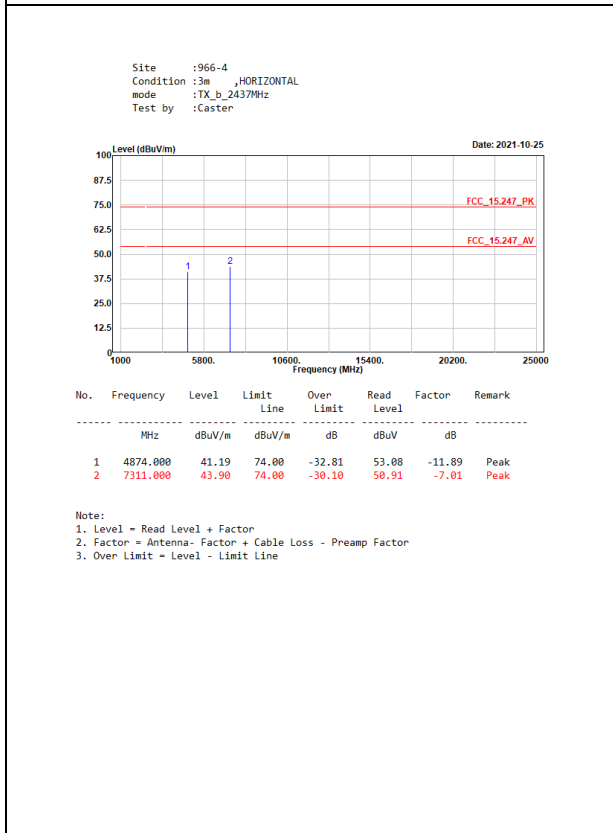
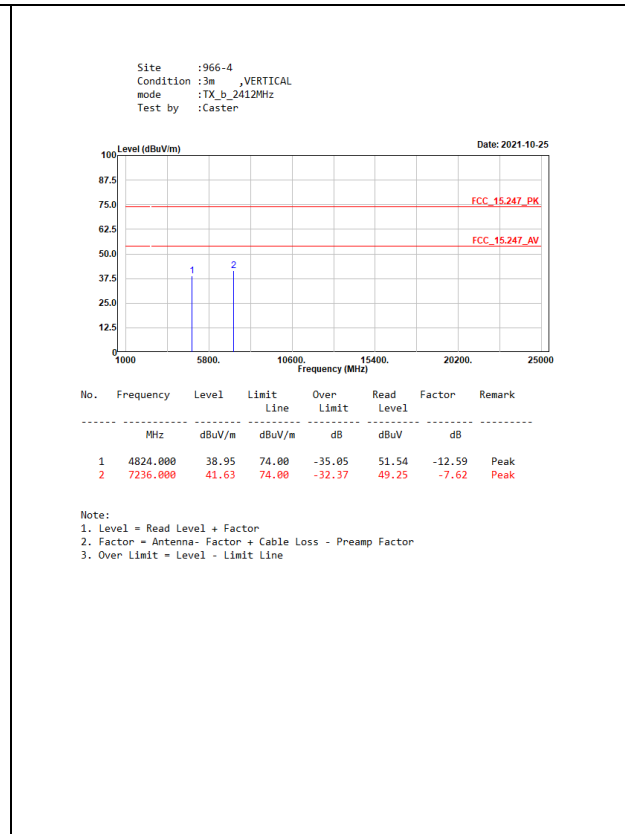
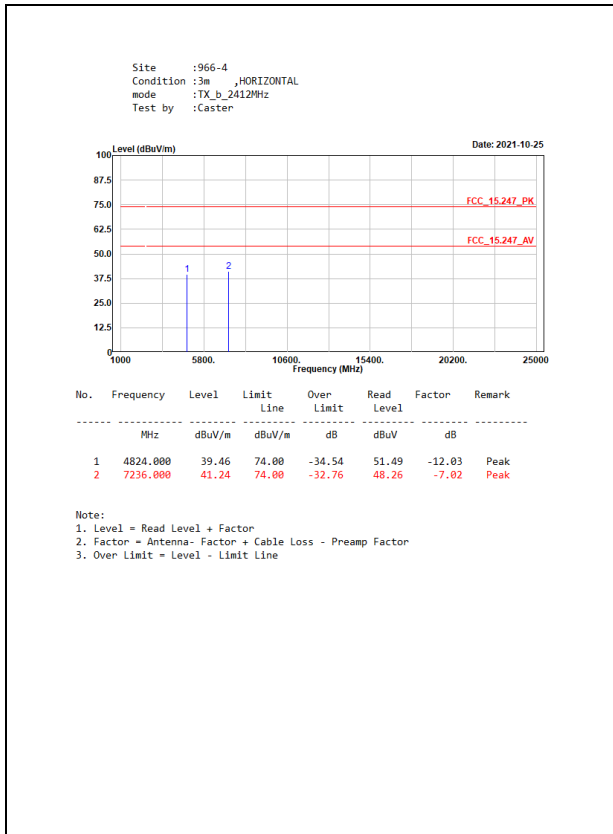

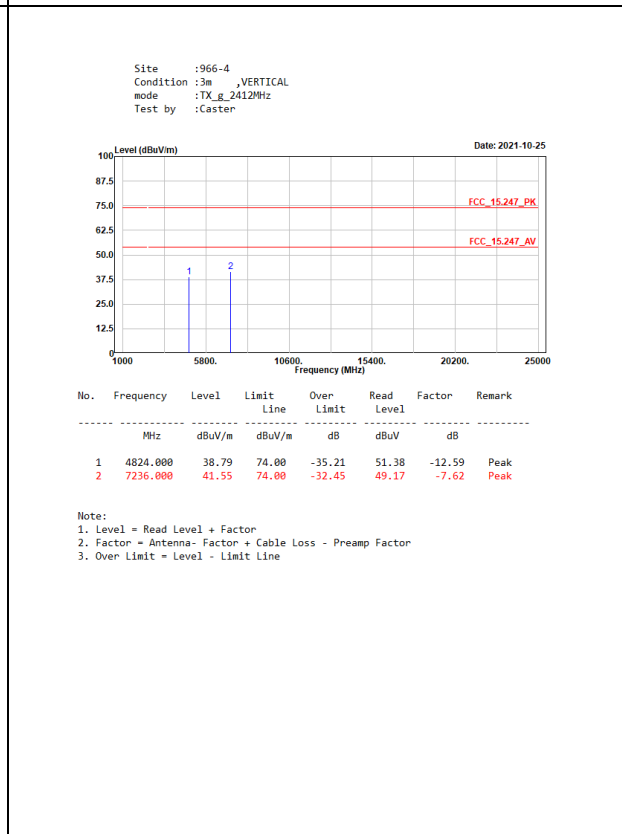
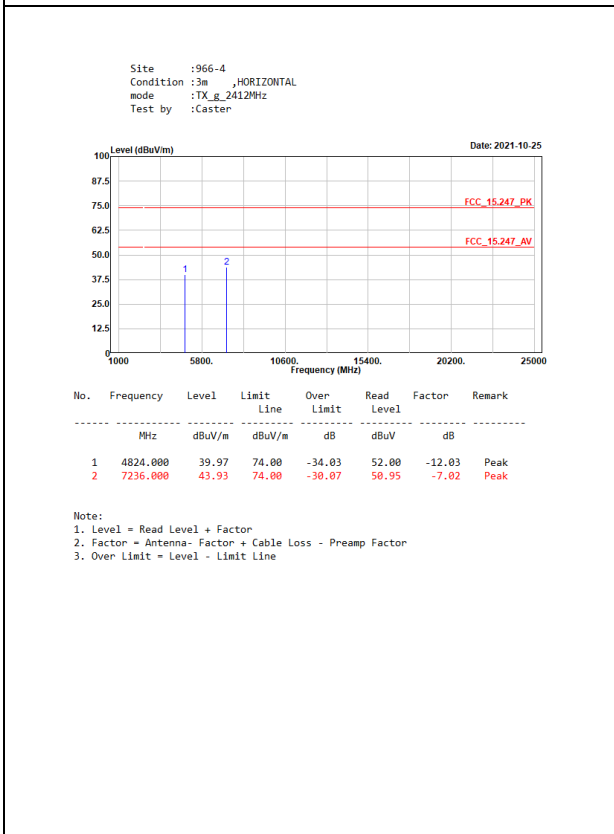
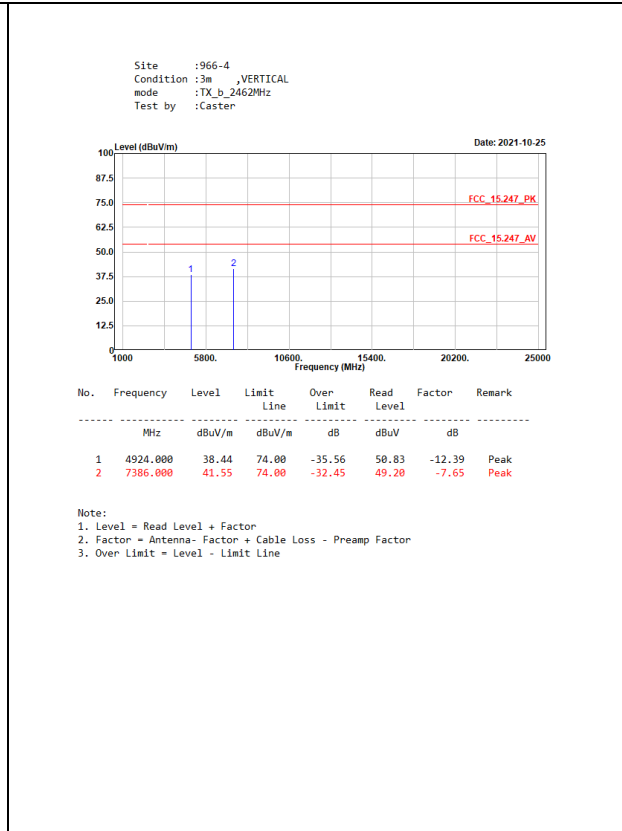
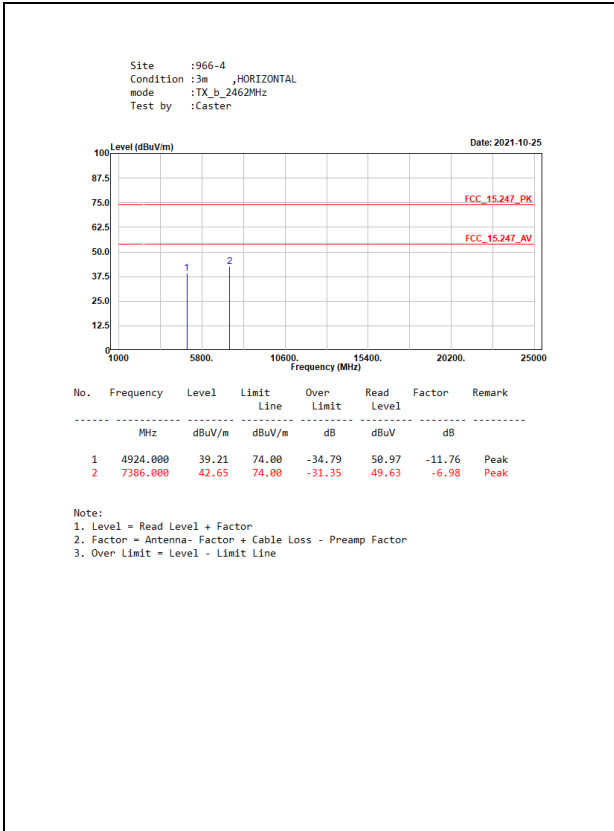

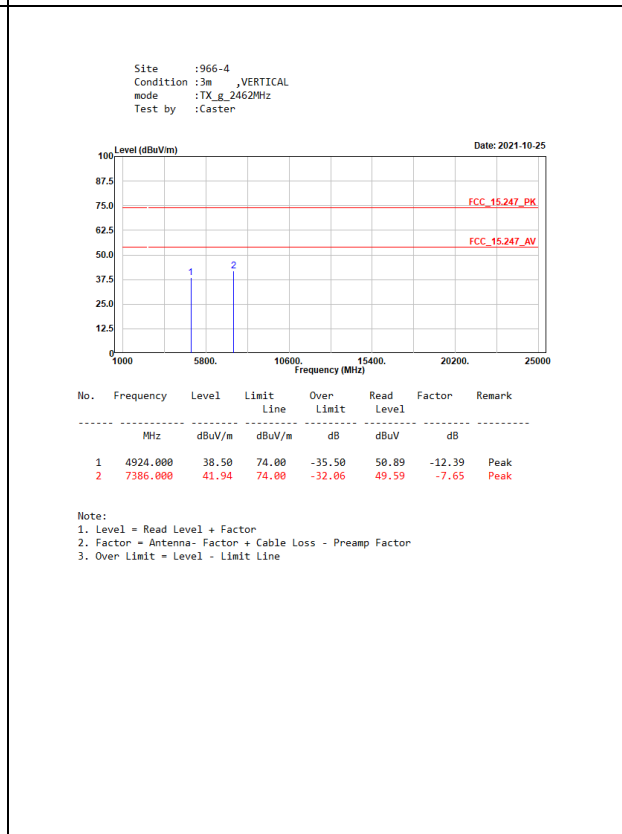
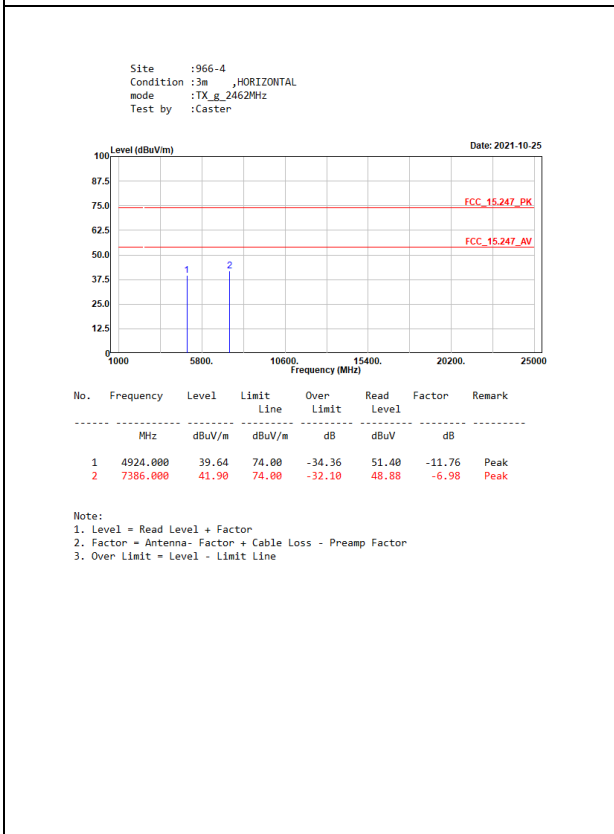
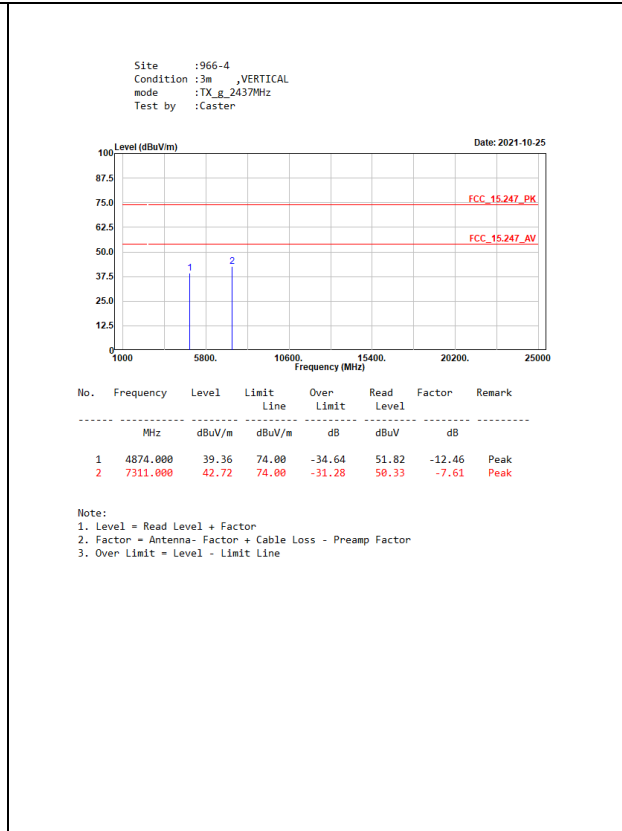
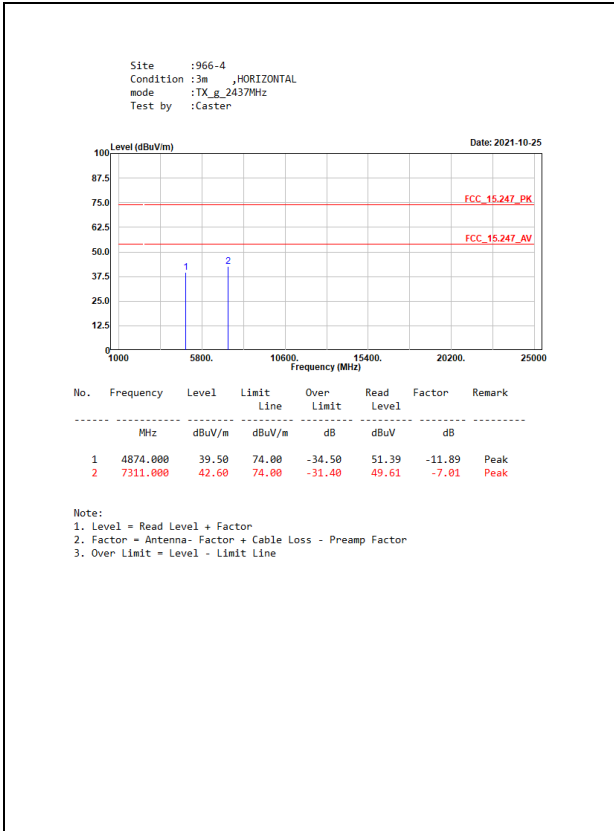

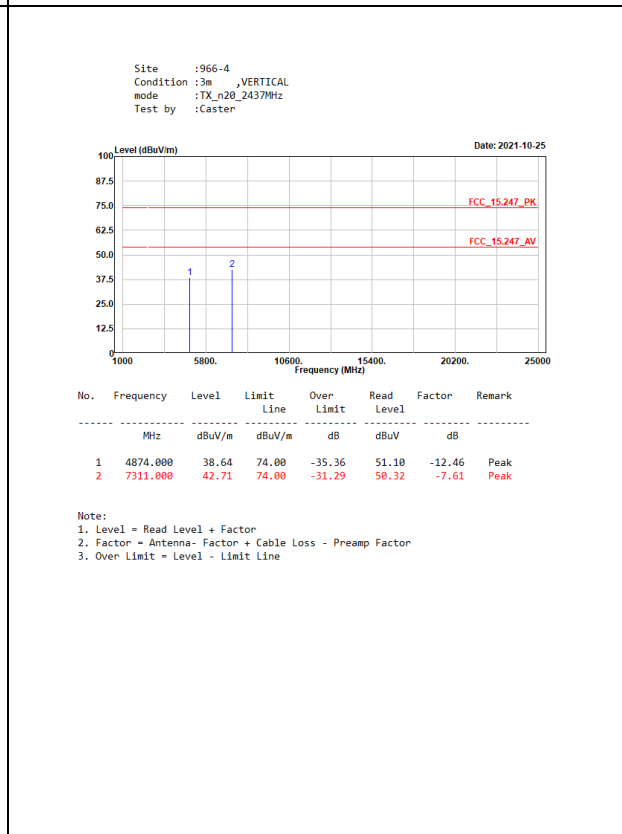
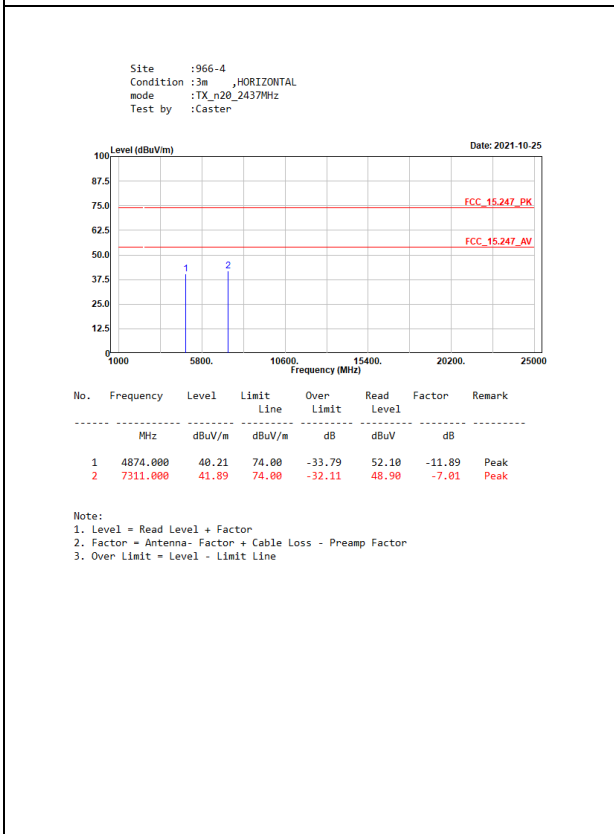
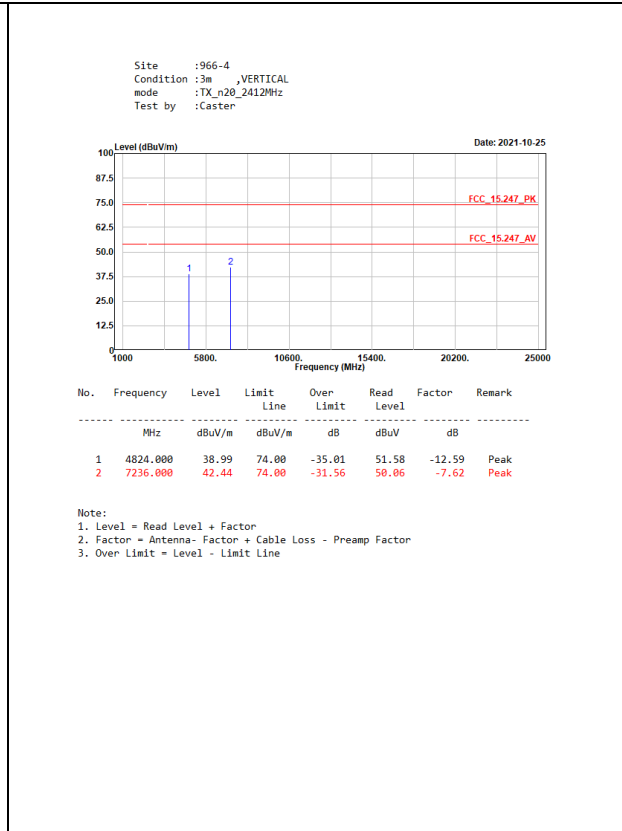
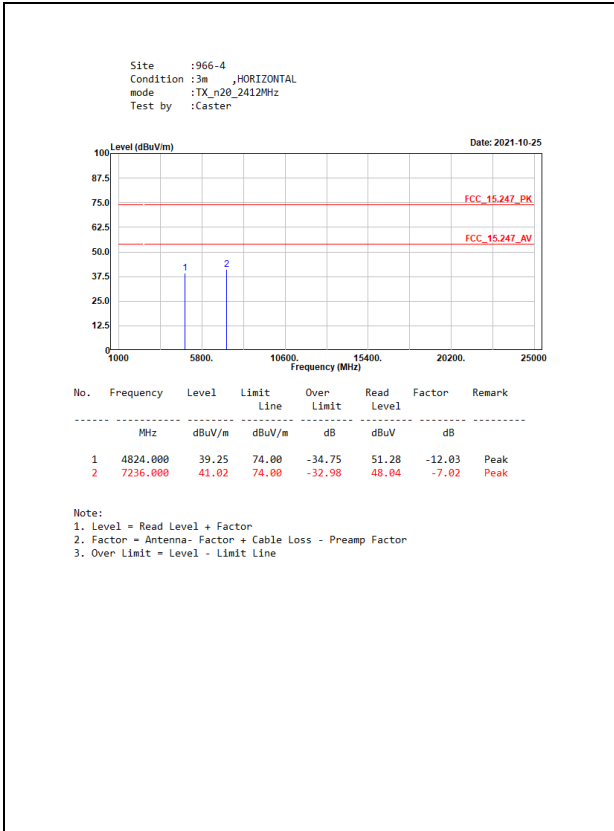

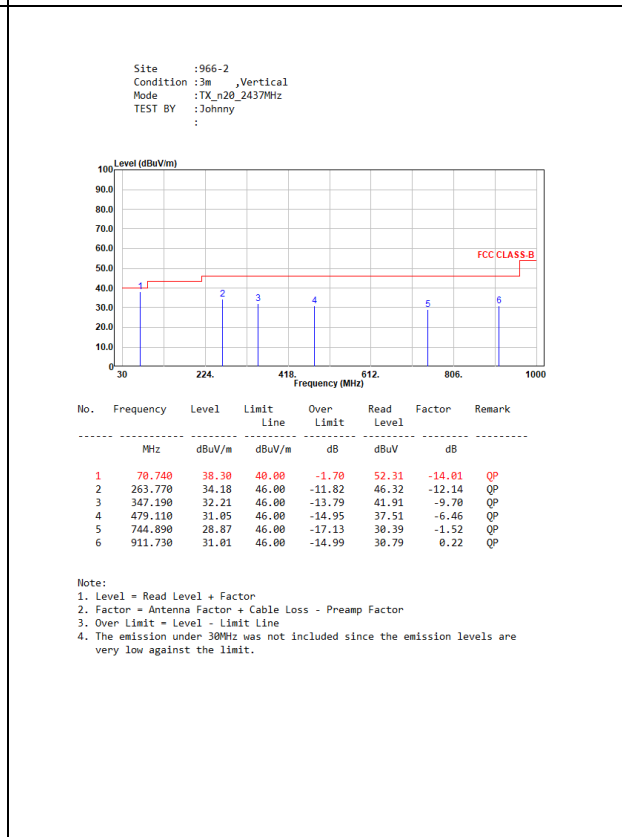
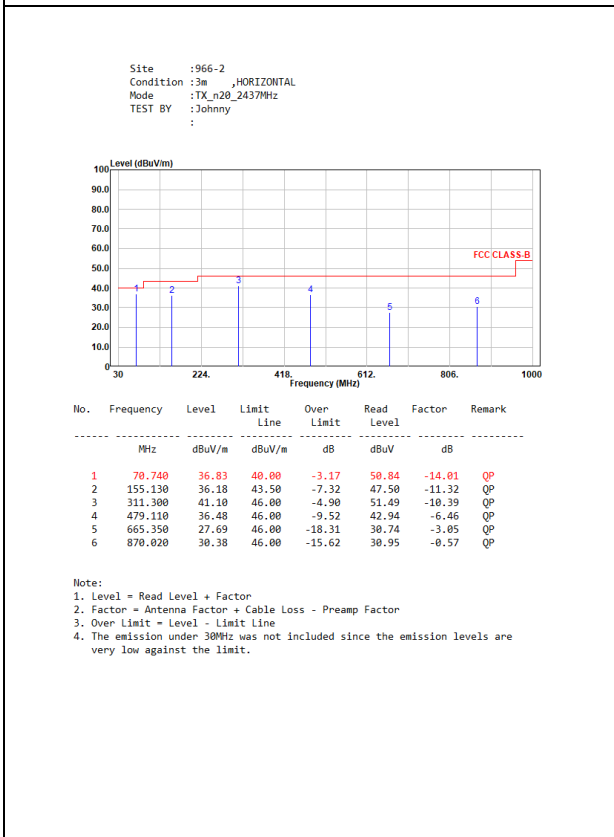
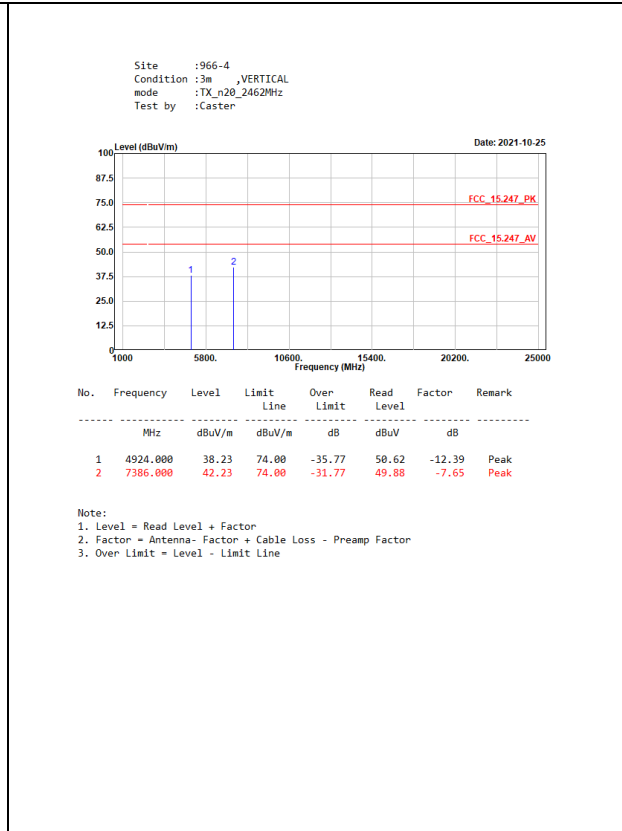
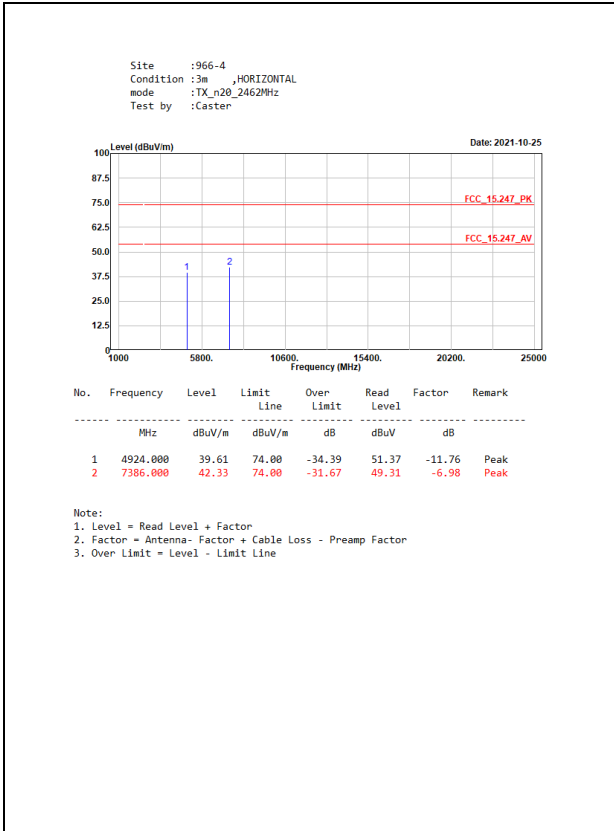

5. RF antenna conducted test

5.1. Test Setup

RF antenna Conducted Measurement:

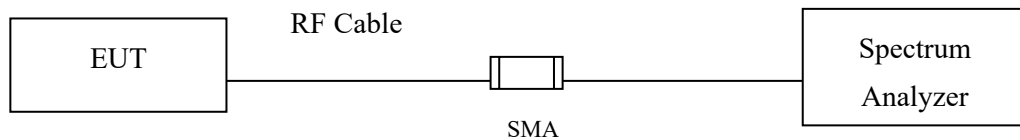

5.2. Limits

In any 100 kHz bandwidth outside the frequency band in which the spread spectrum intentional radiator is operating, the radio frequency power that is produced by the intentional radiator shall be at least 20 dB below that in the 100 kHz bandwidth within the band that contains the highest level of the desired power, based on either an RF conducted or a radiated measurement. Attenuation below the general limits specified in Section 15.209(a) is not required. In addition, radiated emissions which fall in the restricted bands, as defined in Section 15.205(a), must also comply with the radiated emission limits specified in Section 15.209(a) (see Section 15.205(c)).

5.3. Test Procedure

The EUT was tested according to C63.10:2013 Section 11.11 for compliance to FCC 47CFR 15.247 requirements.

Set RBW = 100 kHz, Set VBW > RBW, scan up through 10th harmonic.

5.4. Test Result of RF antenna conducted test

Product : IP Aux Camera WiFi Side Mount/IP Aux Camera WiFi Rear Mount
 Test Item : RF antenna conducted test
 Test Mode : Mode 1: Transmit (802.11b 1Mbps)
 Test Date : 2021/10/28

Channel 01 (2412MHz)

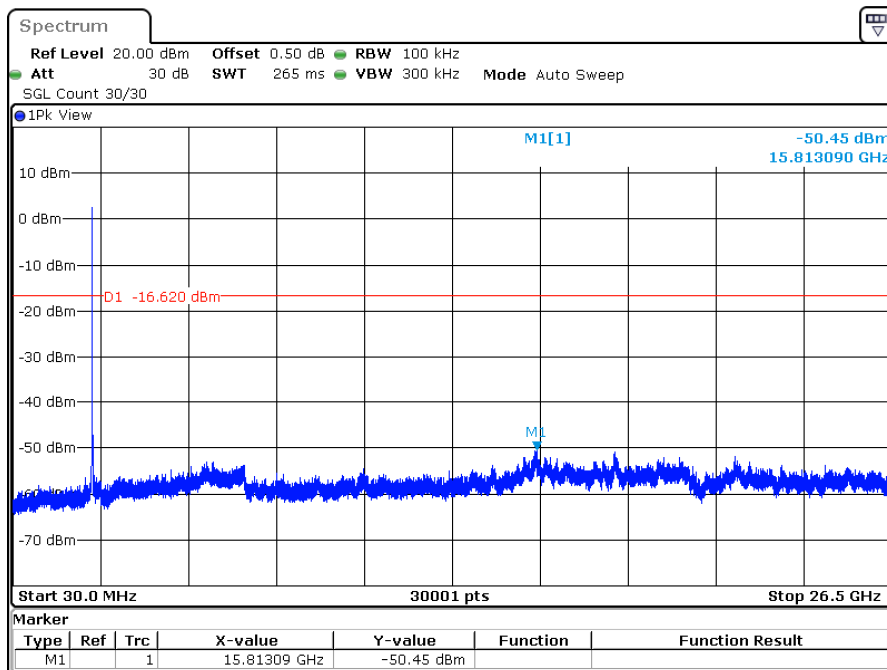

Date: 28.OCT.2021 13:44:17

Product : IP Aux Camera WiFi Side Mount/IP Aux Camera WiFi Rear Mount
 Test Item : RF Antenna Conducted Spurious
 Test Mode : Mode 2: Transmit (802.11g 6Mbps)
 Test Date : 2021/10/28

hannel 11 (2462MHz)

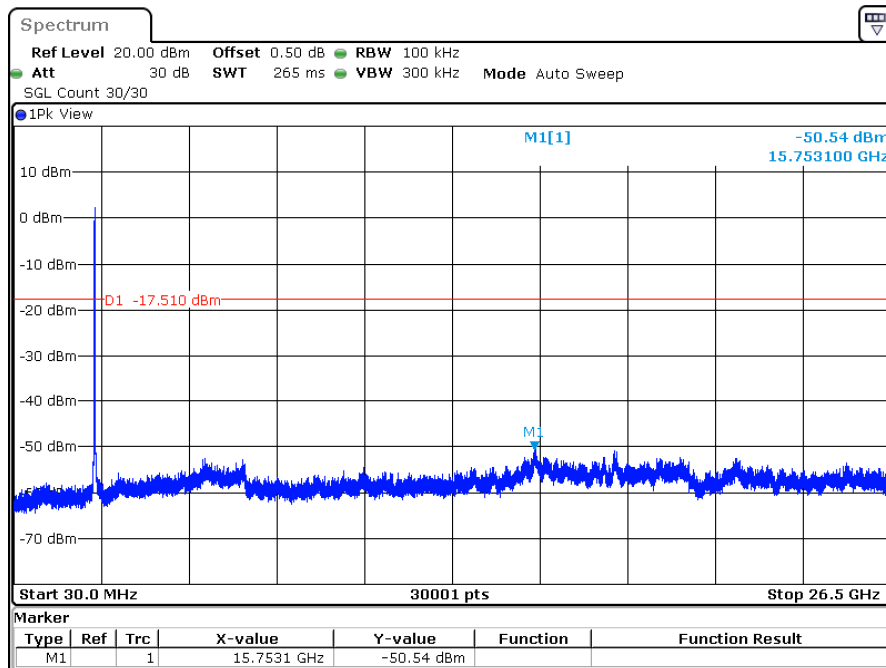

Date: 28.OCT.2021 14:03:34

Product : IP Aux Camera WiFi Side Mount/IP Aux Camera WiFi Rear Mount
 Test Item : RF Antenna Conducted Spurious
 Test Mode : Mode 3: Transmit (802.11n-20MBW 7.2Mbps)
 Test Date : 2021/10/28

Channel 01 (2412MHz)

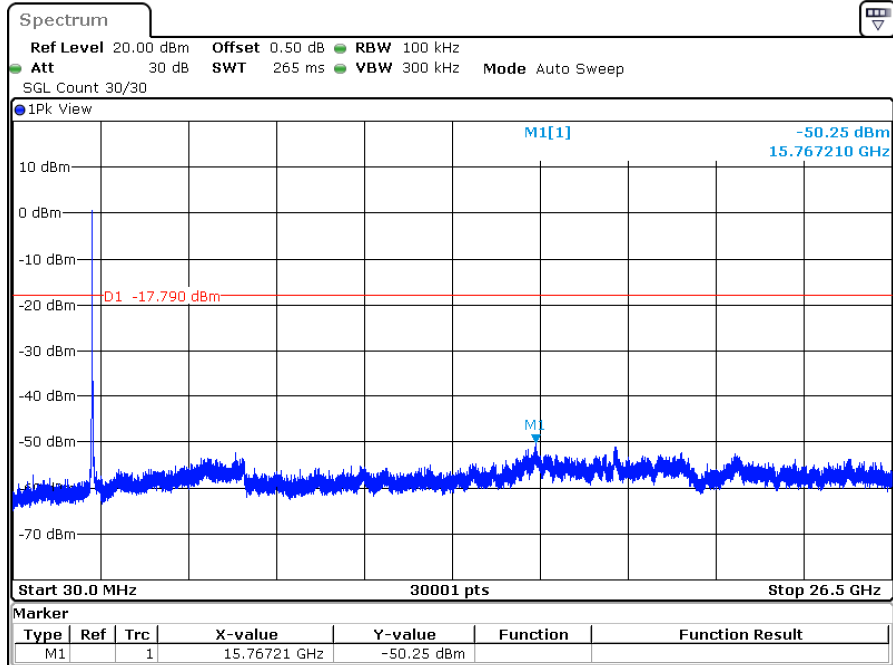

Date: 28.OCT.2021 14:08:16

6. Band Edge

6.1. Test Setup

RF Conducted Measurement

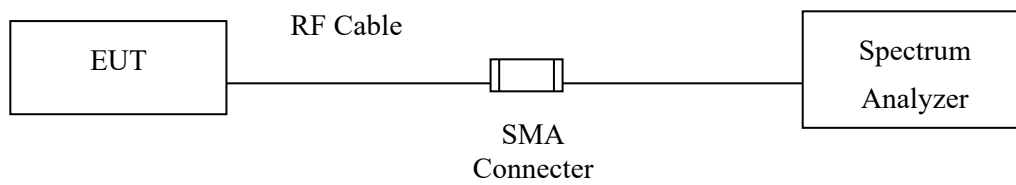

RF Radiated Measurement:

Above 1GHz

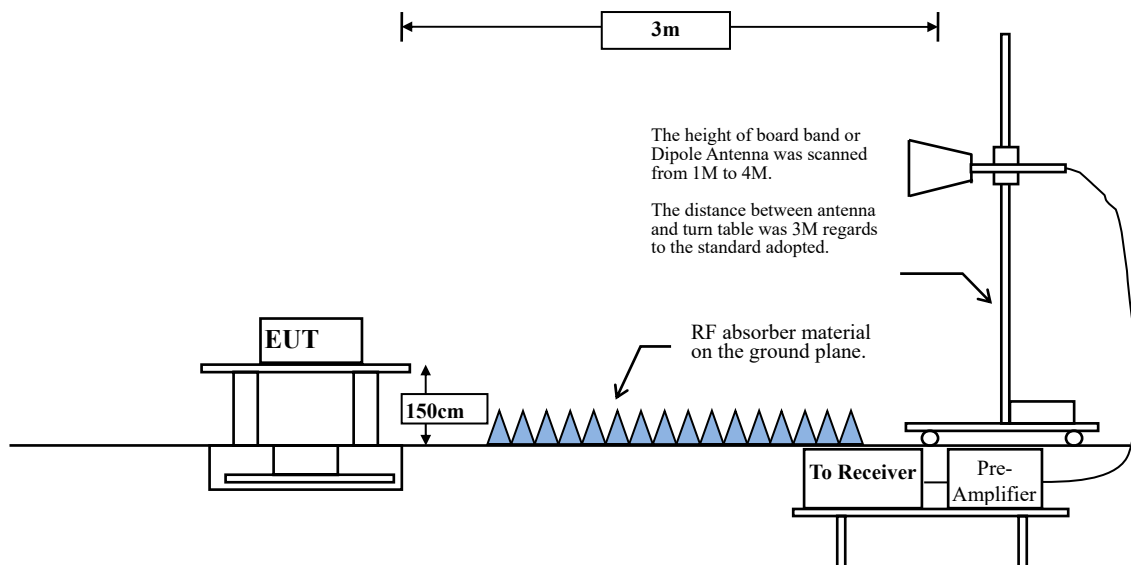

6.2. Limits

According to FCC Section 15.247(d). In any 100 kHz bandwidth outside the frequency band in which the spread spectrum or digitally modulated intentional radiator is operating, the radio frequency power that is produced by the intentional radiator shall be at least 20 dB below that in the 100 kHz bandwidth within the band that contains the highest level of the desired power, based on either an RF conducted or measurement, provided the transmitter demonstrates compliance with the peak conducted power limits. If the transmitter complies with the conducted power limits based on the use of RMS averaging over a time interval, the attenuation required under this paragraph shall be 30 dB instead of 20 dB. Attenuation below the general limits specified in Section 15.209(a) is not required. In addition, radiated emissions which fall in the restricted bands, as defined in Section 15.205(a), must also comply with the radiated emission limits specified in Section 15.209(a) (see Section 15.205(c)).

6.3. Test Procedure

The EUT was setup according to ANSI C63.10, 2013 and tested according to C63.10:2013 Section 11.12.1 for compliance to FCC 47CFR 15.247 requirements.

The EUT is placed on a turn table which is 1.5 meter above ground. The turn table is rotated 360 degrees to determine the position of the maximum emission level. The EUT was positioned such that the distance from antenna to the EUT was 3 meters.

The antenna is scanned from 1 meter to 4 meters to find out the maximum emission level. This is repeated for both horizontal and vertical polarization of the antenna. In order to find the maximum emission, all of the interface cables were manipulated according to ANSI C63.10:2013 on radiated measurement.

RBW and VBW Parameter setting:

According to C63.10 Section 11.12.2.4 Peak measurement procedure.

RBW = as specified in Table 1.

$VBW \geq 3 \times RBW$.

Table 1 —RBW as a function of frequency

Frequency	RBW
9-150 kHz	200-300 Hz
0.15-30 MHz	9-10 kHz
30-1000 MHz	100-120 kHz
> 1000 MHz	1 MHz

According to C63.10 Section 11.12.2.5 Average measurement procedure.

RBW = 1MHz.

VBW = 10Hz, when duty cycle $\geq 98\%$

$VBW \geq 1/T$, when duty cycle $< 98\%$

(T refers to the minimum transmission duration over which the transmitter is on and is transmitting at its maximum power control level for the tested mode of operation.)

2.4GHz band	Duty Cycle (%)	T (ms)	1/T (Hz)	VBW (Hz)
802.11b	98.98	8.4348	119	10
802.11g	93.23	1.3985	715	1000
802.11n20	93.29	1.3115	762	1000

Note: Duty Cycle Refer to Section 9.

6.4. Test Result of Band Edge

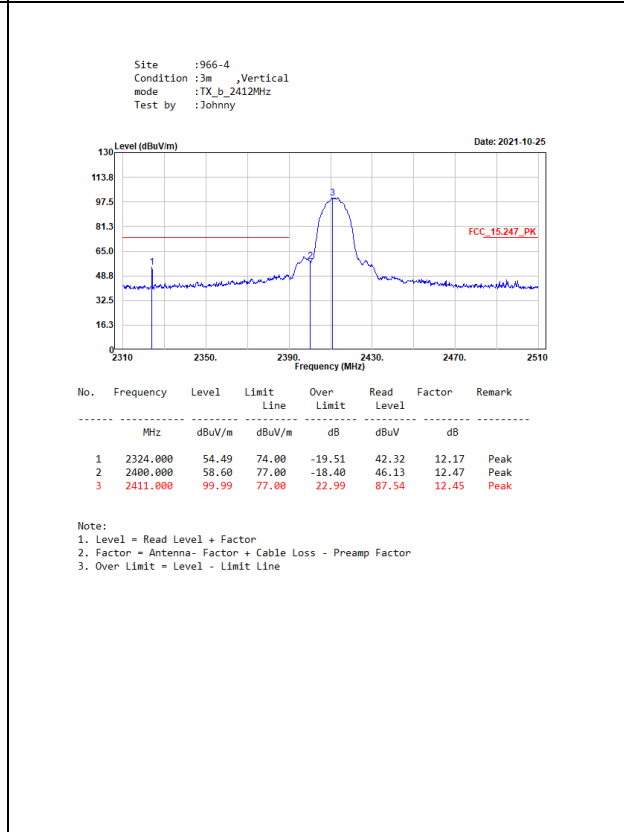
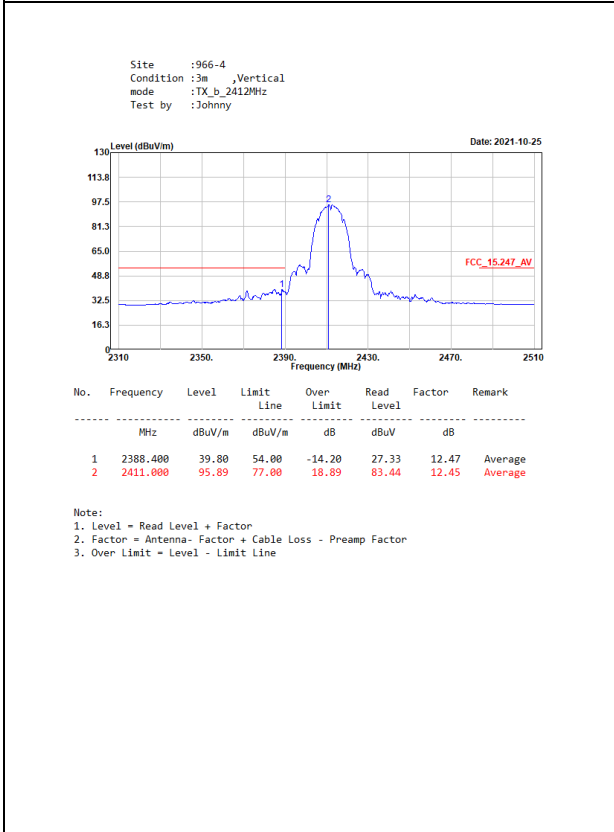
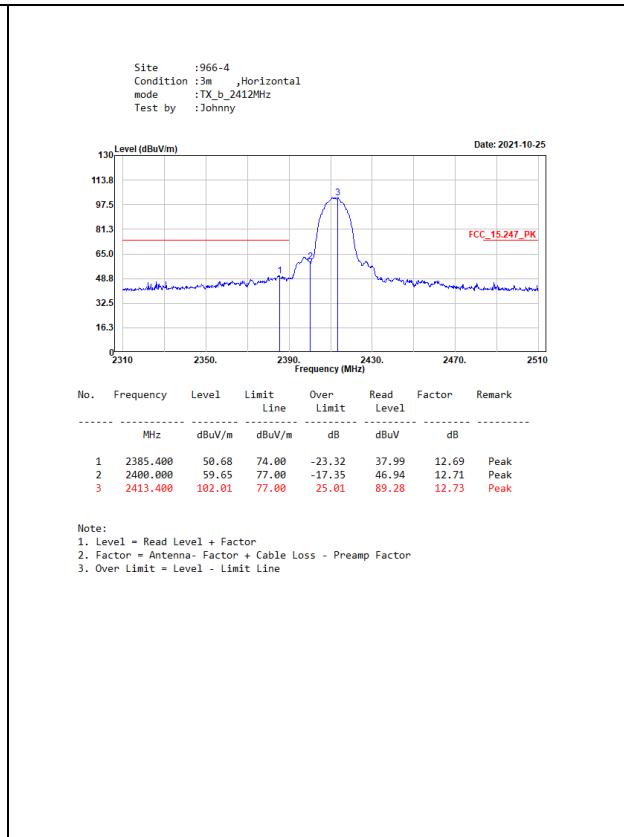
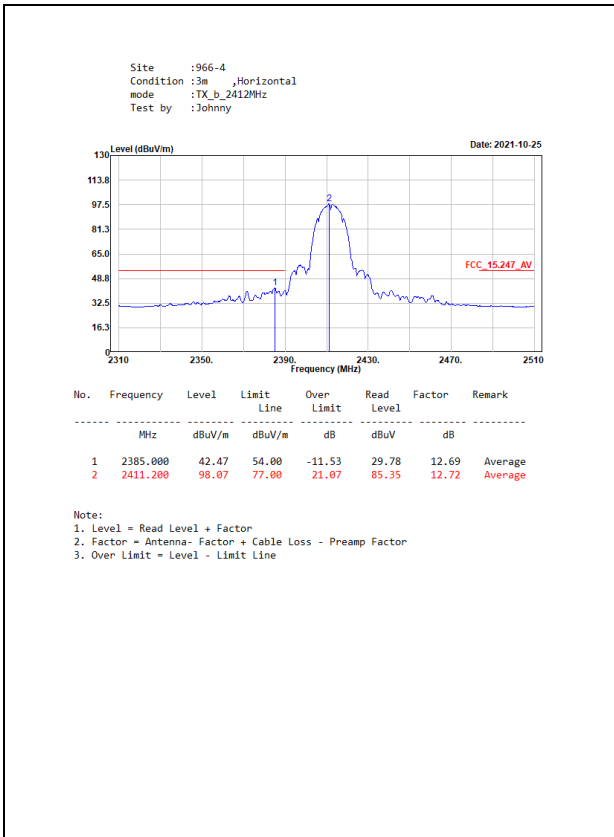

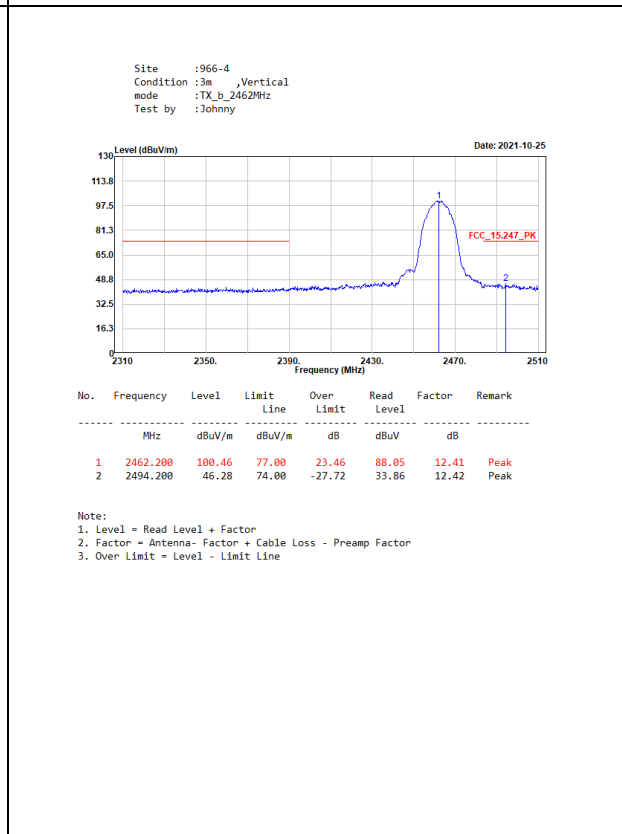
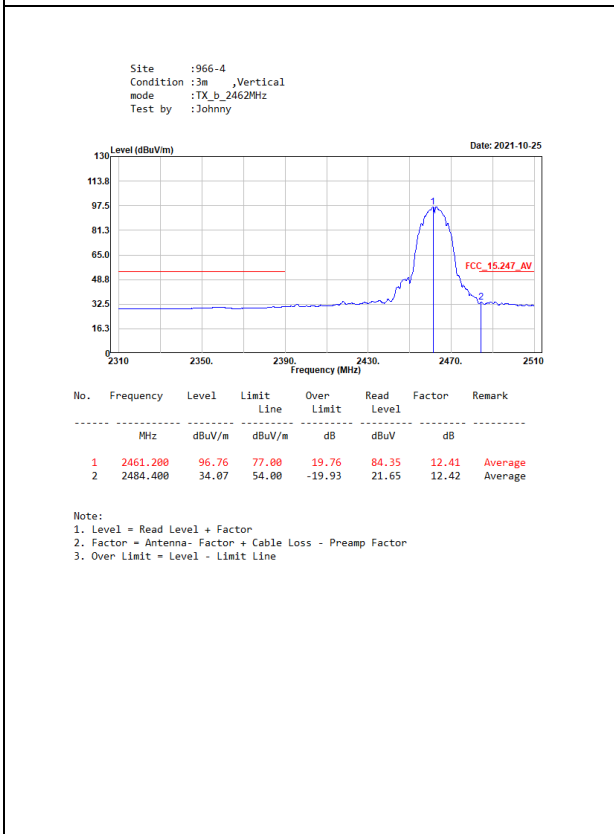
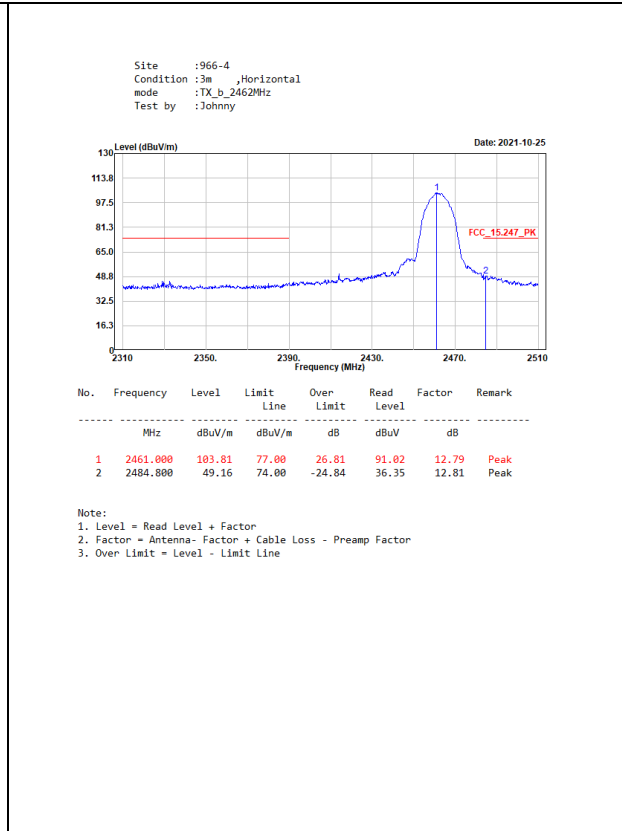
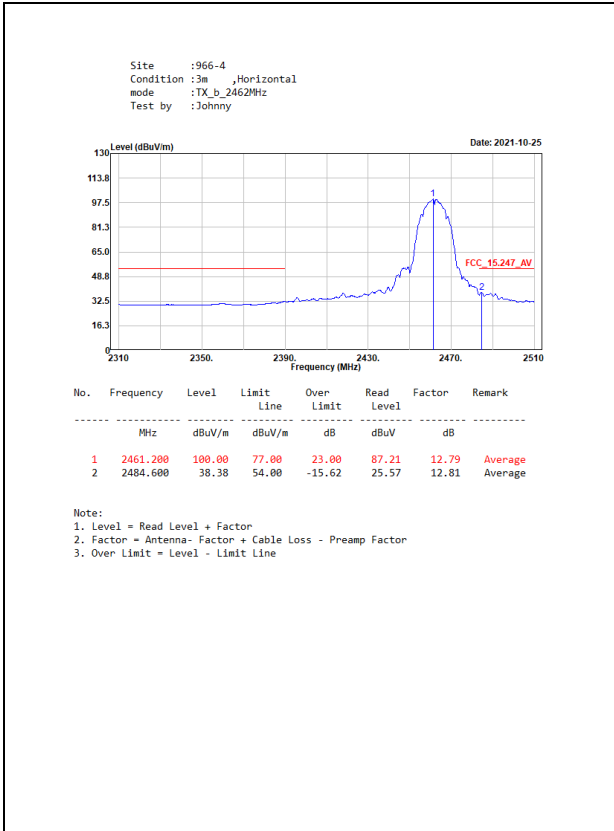

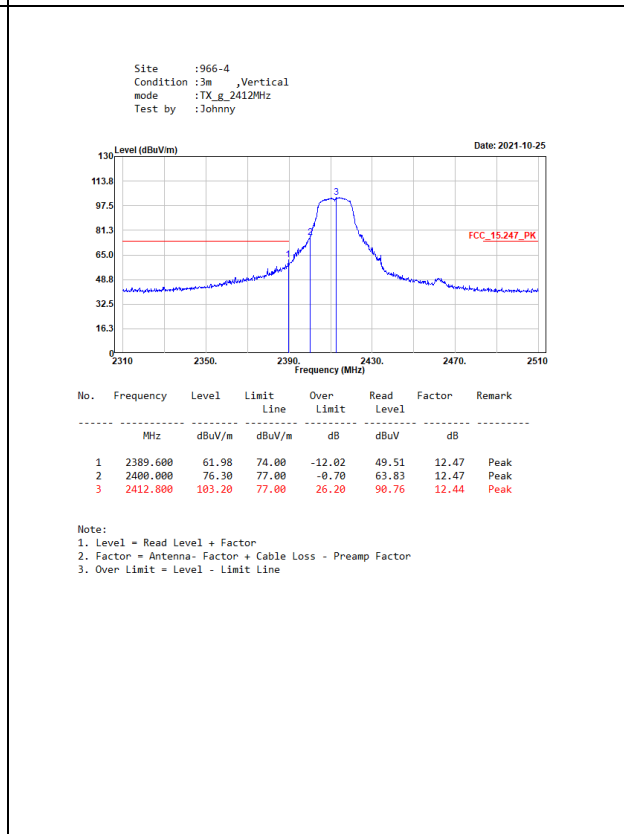
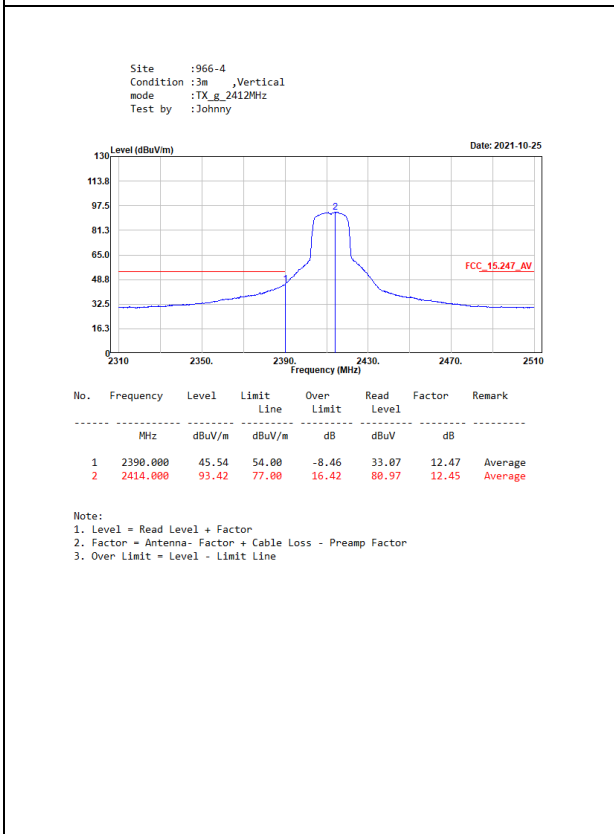
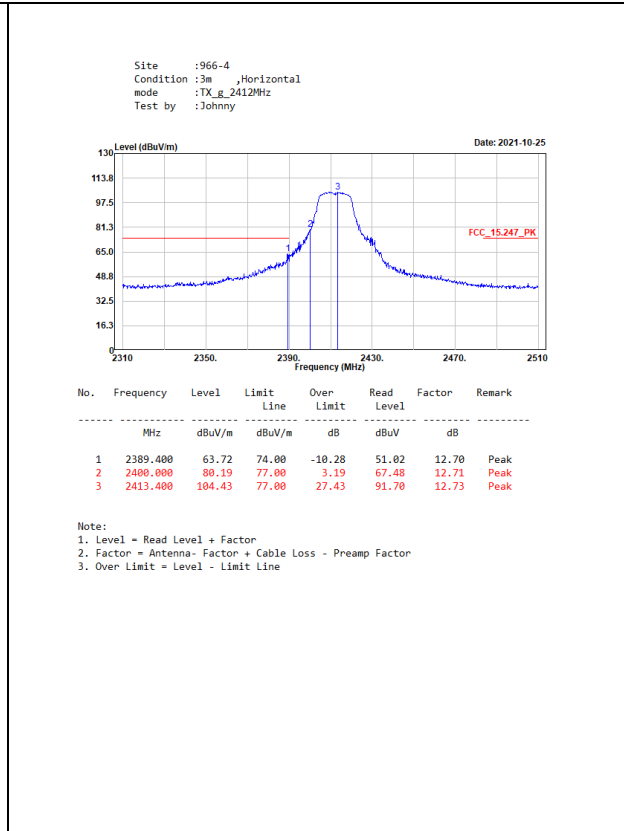
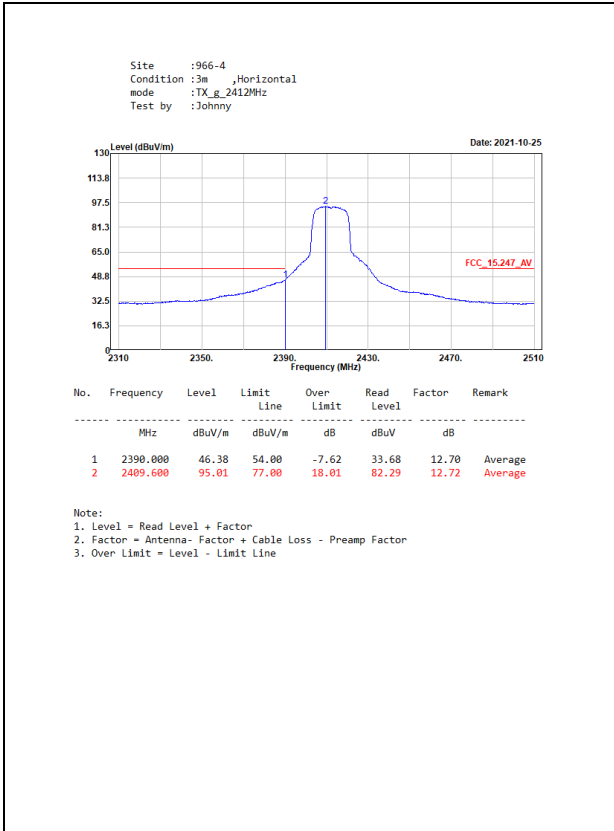

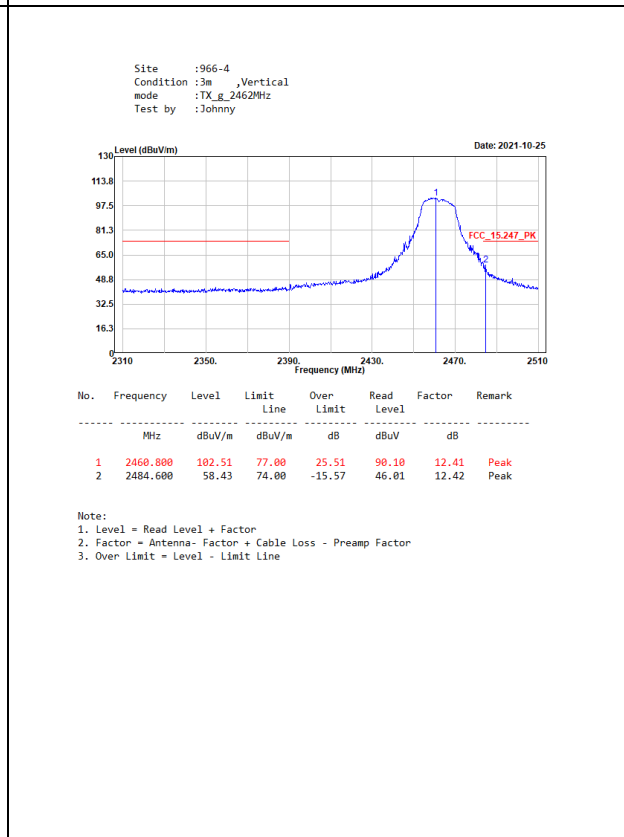
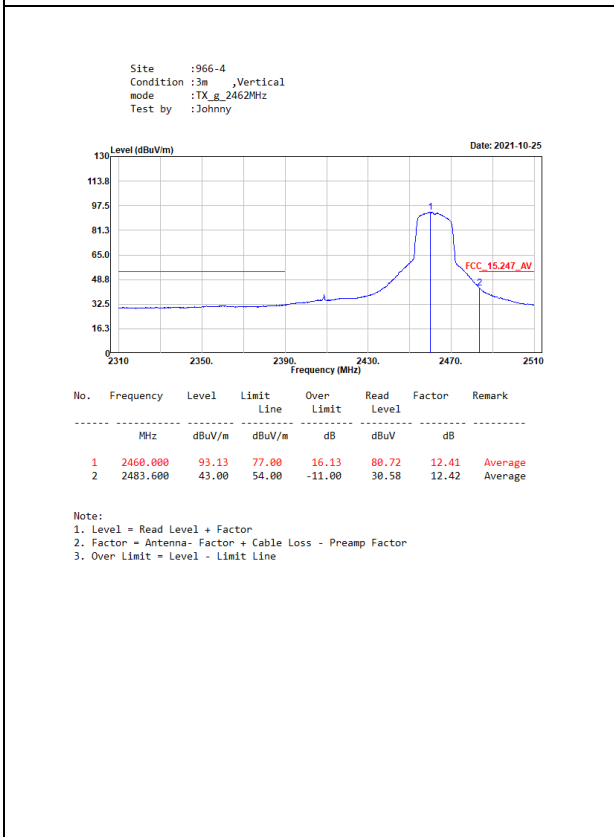
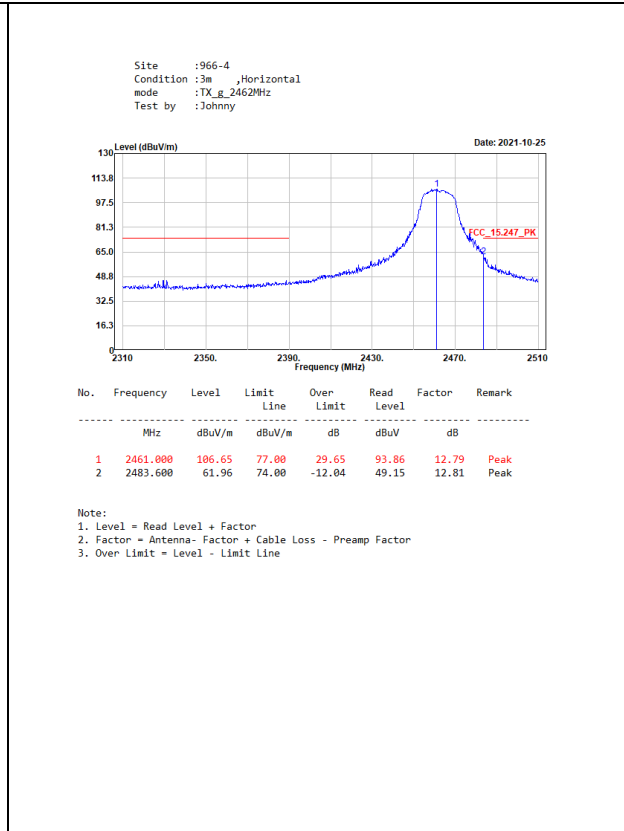
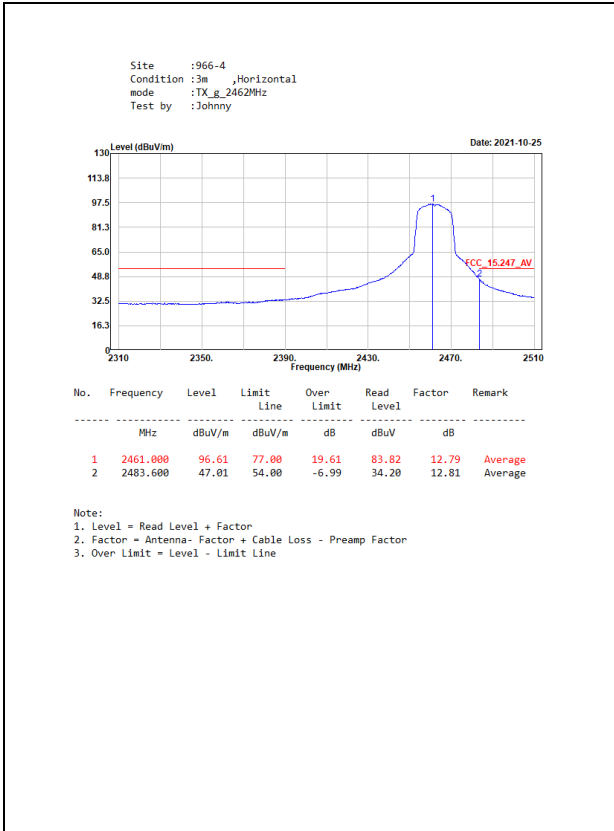

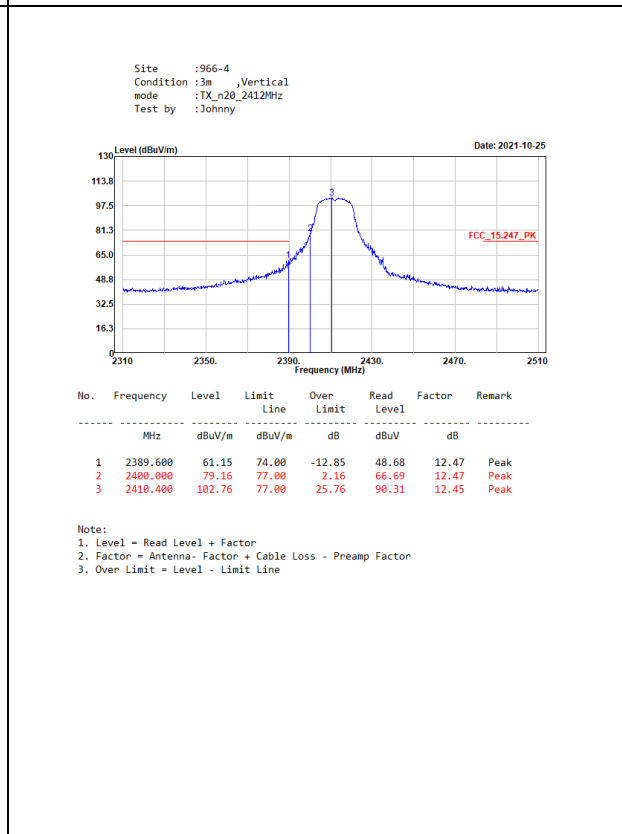
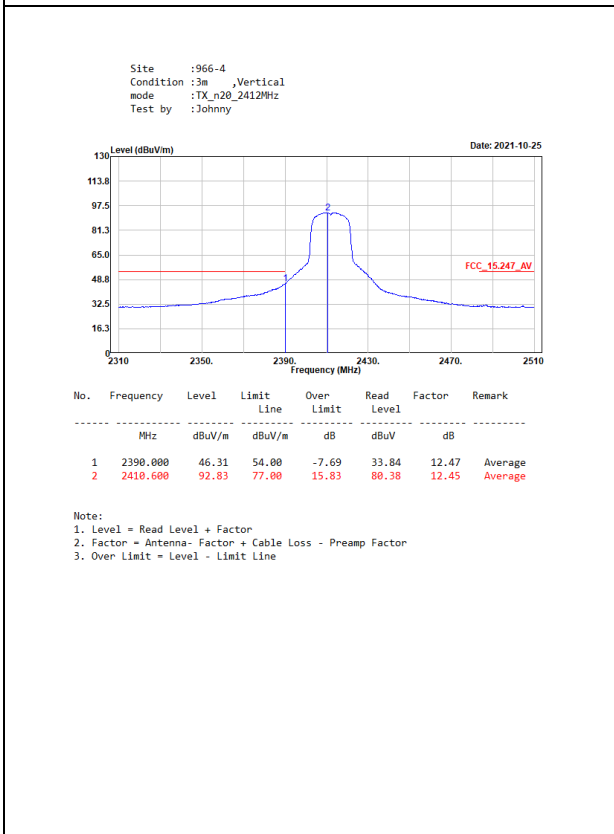
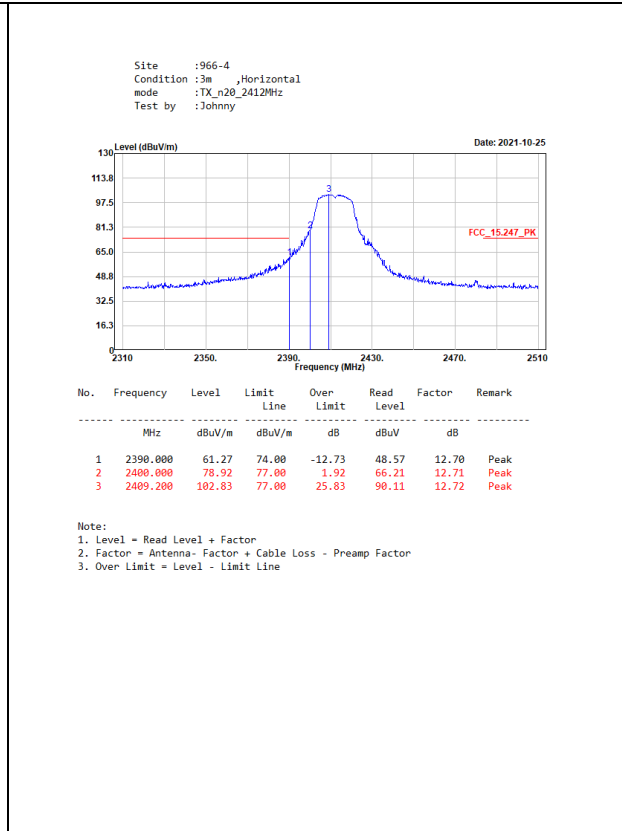
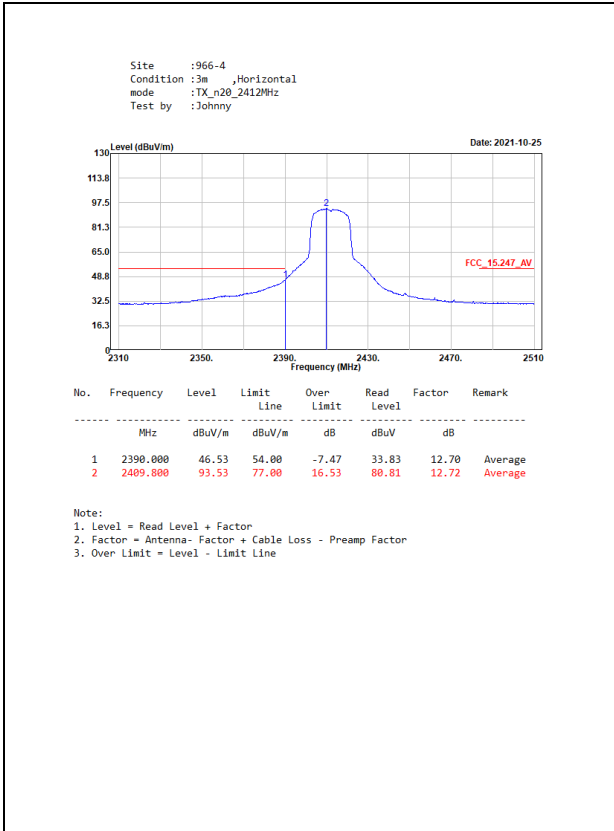

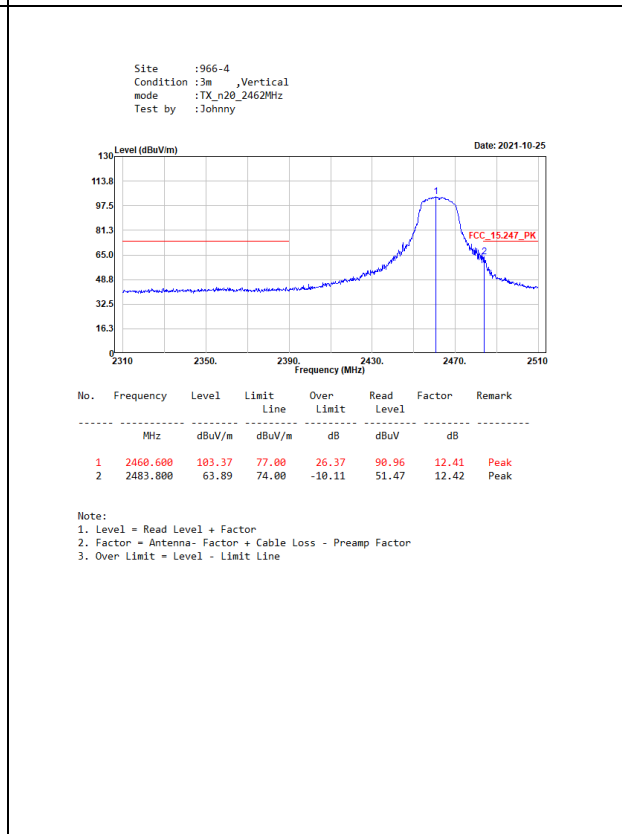
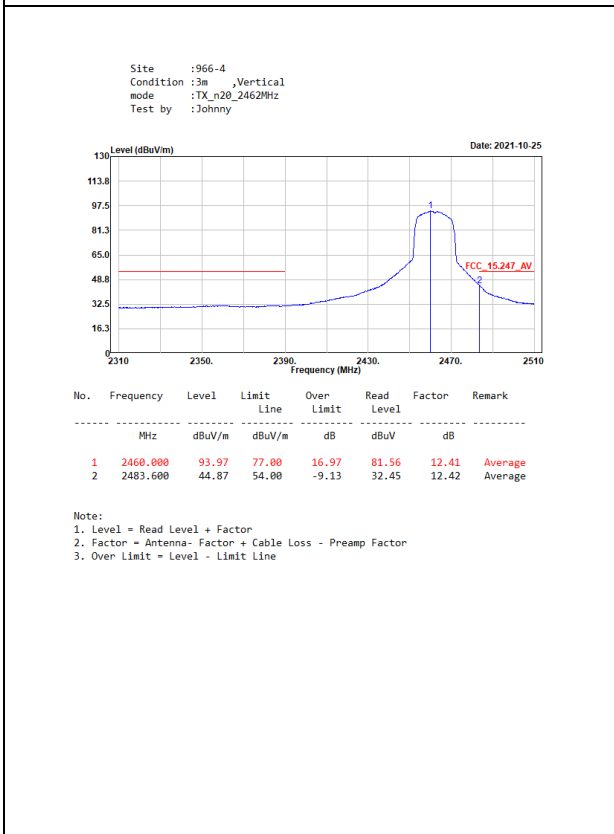
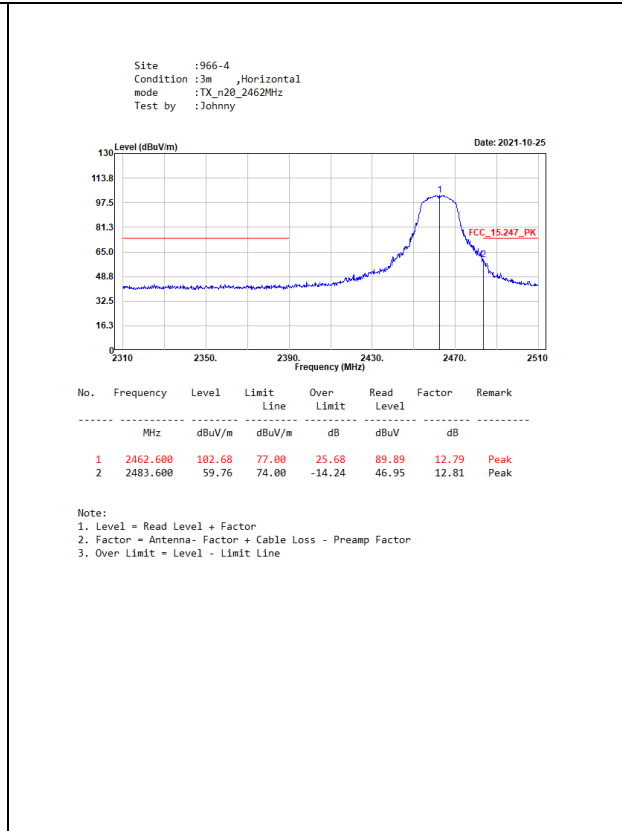
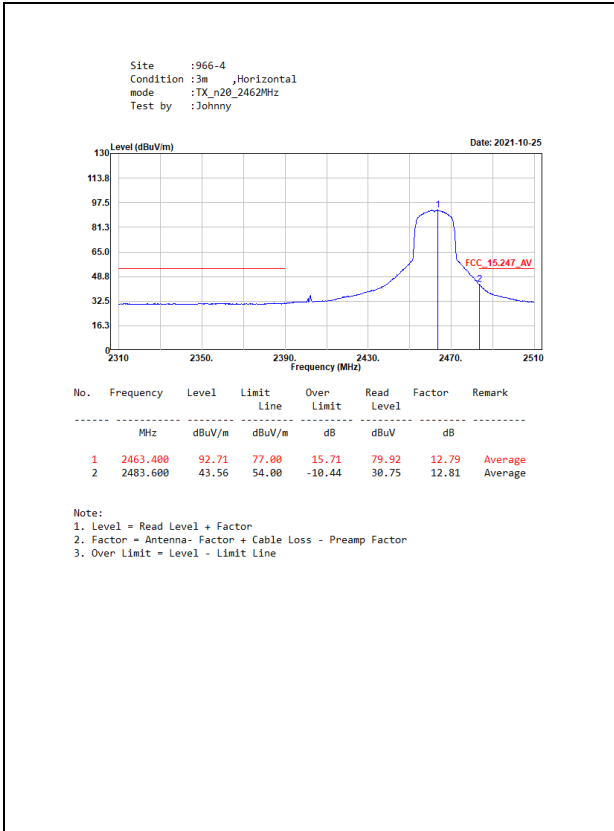

7. 6dB Bandwidth

7.1. Test Setup

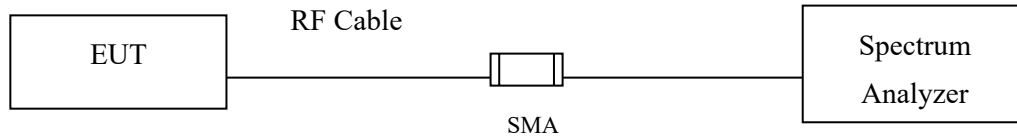

7.2. Limits

The minimum bandwidth shall be at least 500 kHz.

7.3. Test Procedure

The EUT was setup according to ANSI C63.4, 2014; tested according to ANSI C63.10 Section 11.8 for compliance to FCC 47CFR 15.247 requirements.

7.4. Test Result of 6dB Bandwidth

Product : IP Aux Camera WiFi Side Mount/IP Aux Camera WiFi Rear Mount
 Test Item : 6dB Bandwidth Data
 Test Mode : Mode 1: Transmit (802.11b 1Mbps)

Channel No.	Frequency (MHz)	Measurement Level (kHz)	Required Limit (kHz)	Result
01	2412	9031	>500	Pass
06	2437	9031	>500	Pass
11	2462	9031	>500	Pass

Figure Channel 01:

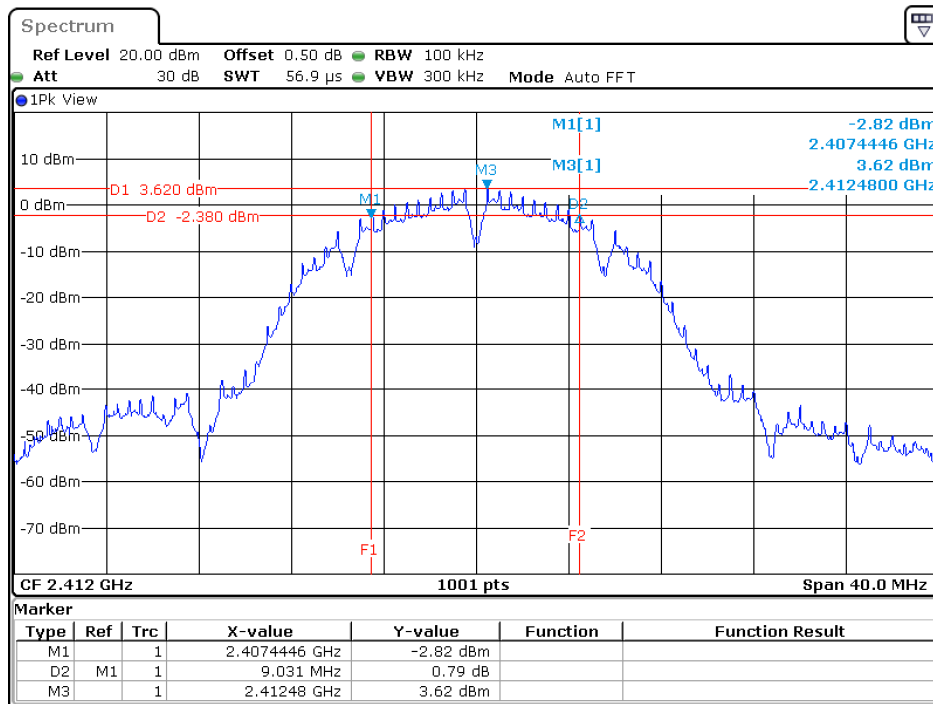

Date: 28.OCT.2021 13:40:50

Product : IP Aux Camera WiFi Side Mount/IP Aux Camera WiFi Rear Mount
 Test Item : 6dB Bandwidth Data
 Test Mode : Mode 2: Transmit (802.11g 6Mbps)

Channel No.	Frequency (MHz)	Measurement Level (kHz)	Required Limit (kHz)	Result
01	2412	15104	>500	Pass
06	2437	15104	>500	Pass
11	2462	15104	>500	Pass

Figure Channel 01:

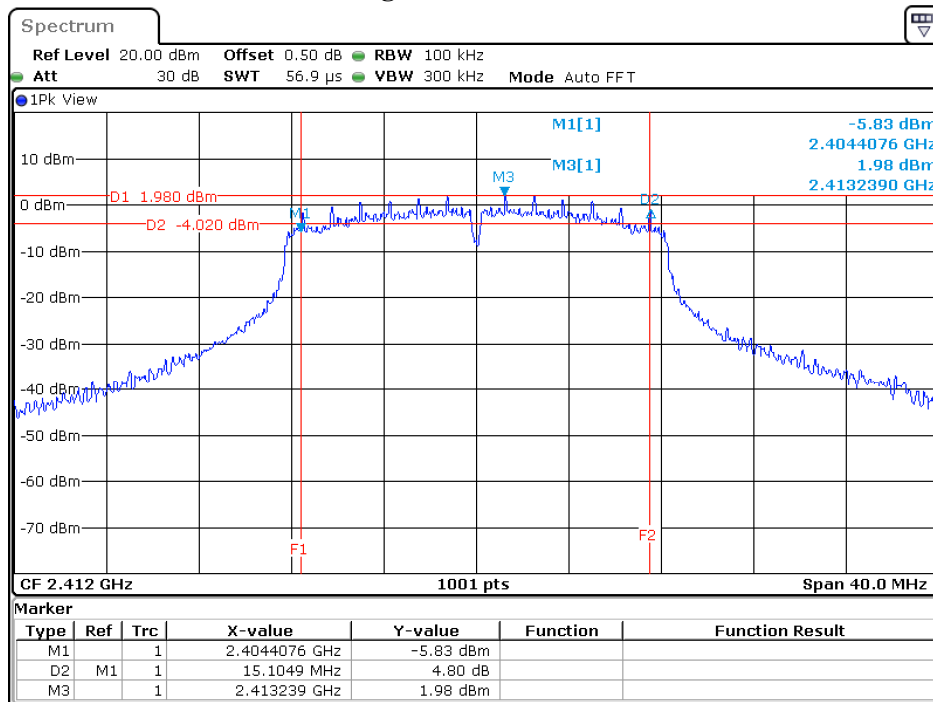

Date: 28.OCT.2021 13:53:55

Product : IP Aux Camera WiFi Side Mount/IP Aux Camera WiFi Rear Mount
 Test Item : 6dB Bandwidth Data
 Test Mode : Mode 3: Transmit (802.11n-20MBW 7.2Mbps)

Channel No.	Frequency (MHz)	Measurement Level (kHz)	Required Limit (kHz)	Result
01	2412	15104	>500	Pass
06	2437	15104	>500	Pass
11	2462	15104	>500	Pass

Figure Channel 01:

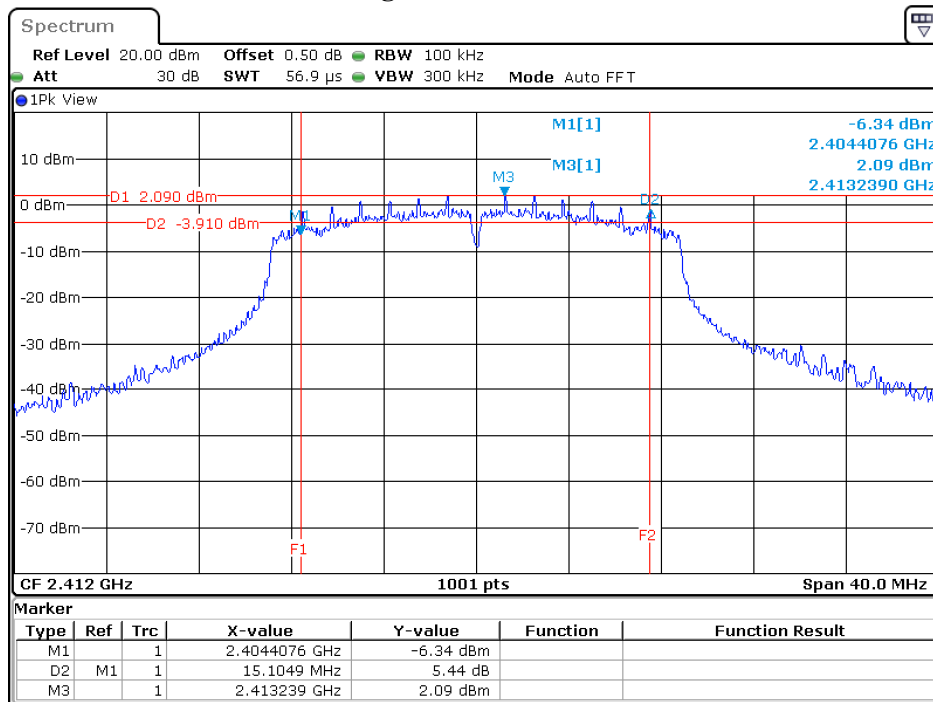

Date: 28.OCT.2021 14:05:05

8. Power Density

8.1. Test Setup

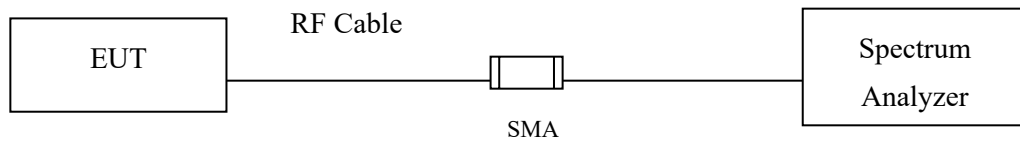

8.2. Limits

The transmitted power density averaged over any 1 second interval shall not be greater +8dBm in any 3kHz bandwidth.

8.3. Test Procedure

The EUT was setup according to ANSI C63.10, 2013; tested according to DTS test procedure of KDB 558074 for compliance to FCC 47CFR 15.247 requirements.

The maximum power spectral density using C63.10 Section 11.10.2 Method PKPSD (peak PSD)

8.4. Test Result of Power Density

Product : IP Aux Camera WiFi Side Mount/IP Aux Camera WiFi Rear Mount
 Test Item : Power Density Data
 Test Mode : Mode 1: Transmit (802.11b 1Mbps)

Channel No.	Frequency (MHz)	Measure Level (dBm)	Limit (dBm)	Result
01	2412	-8.830	≤ 8dBm	Pass
06	2437	-8.810	≤ 8dBm	Pass
11	2462	-8.330	≤ 8dBm	Pass

Figure Channel 11:

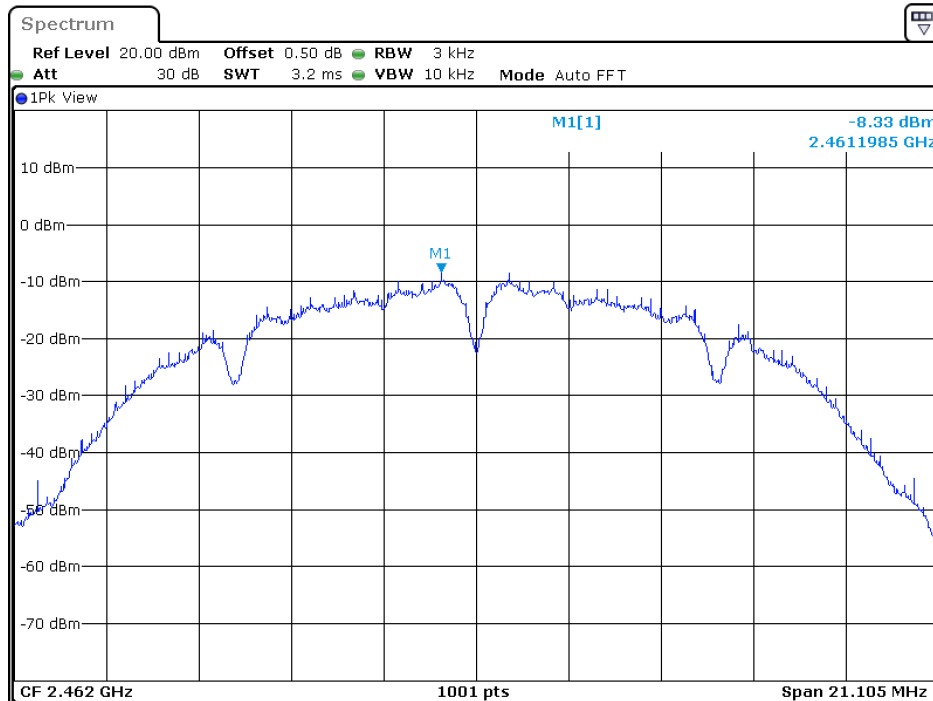

Date: 28.OCT.2021 13:50:59

Product : IP Aux Camera WiFi Side Mount/IP Aux Camera WiFi Rear Mount
 Test Item : Power Density Data
 Test Mode : Mode 2: Transmit (802.11g 6Mbps)

Channel No.	Frequency (MHz)	Measure Level (dBm)	Limit (dBm)	Result
01	2412	-10.990	≤ 8dBm	Pass
06	2437	-10.530	≤ 8dBm	Pass
11	2462	-10.640	≤ 8dBm	Pass

Figure Channel 06:

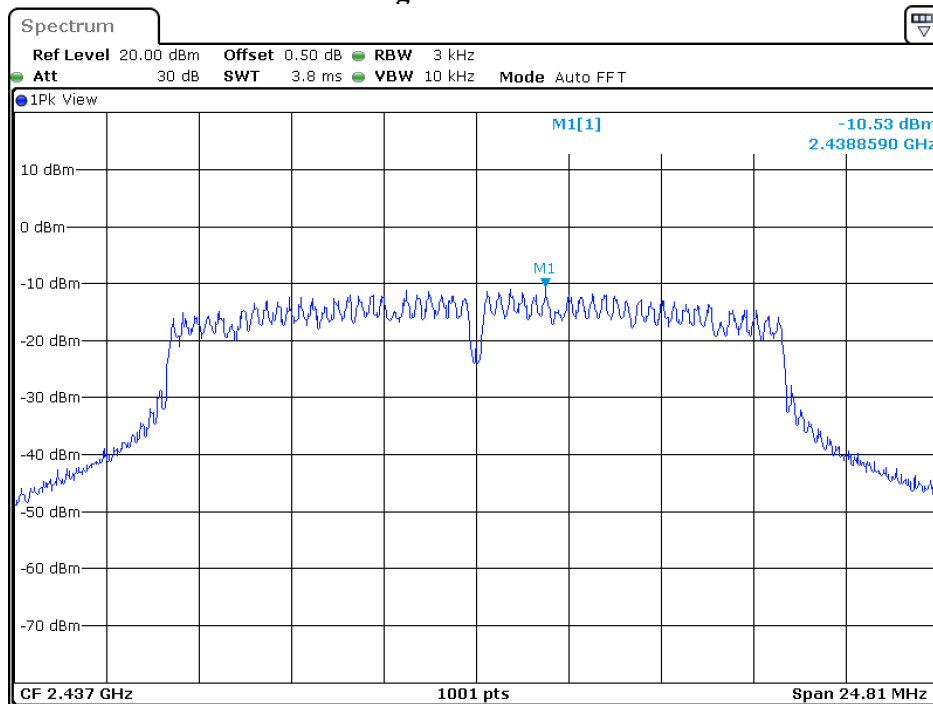

Date: 28.OCT.2021 13:58:35

Product : IP Aux Camera WiFi Side Mount/IP Aux Camera WiFi Rear Mount
 Test Item : Power Density Data
 Test Mode : Mode 3: Transmit (802.11n-20MBW 7.2Mbps)

Channel No.	Frequency (MHz)	Measure Level (dBm)	Limit (dBm)	Result
01	2412	-11.140	≤ 8dBm	Pass
06	2437	-10.980	≤ 8dBm	Pass
11	2462	-10.500	≤ 8dBm	Pass

Figure Channel 11:

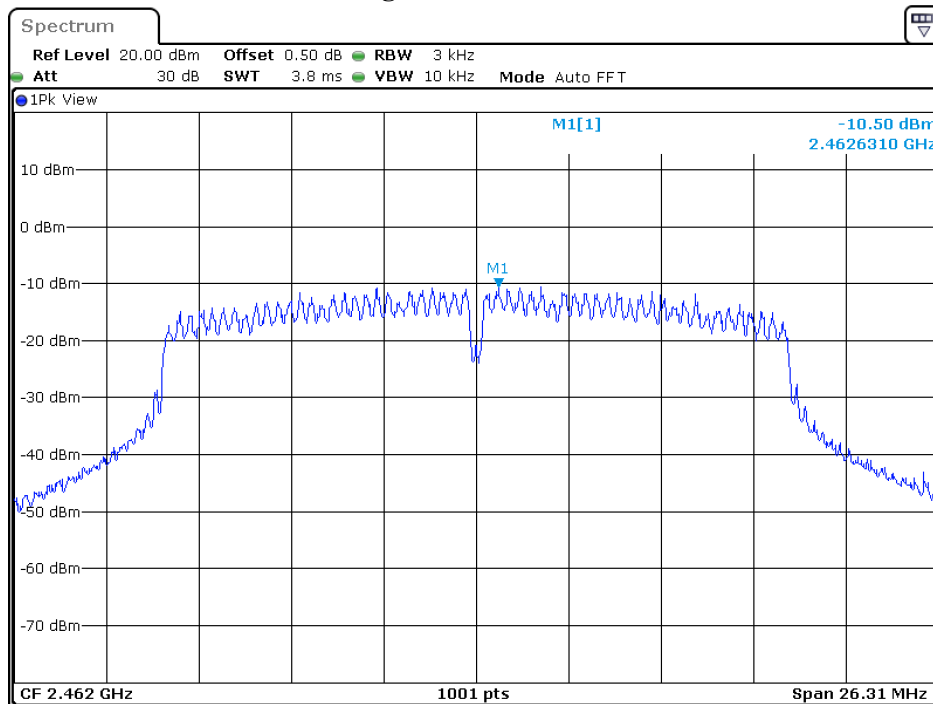

Date: 28.OCT.2021 14:15:52

9. Duty Cycle

9.1. Test Setup

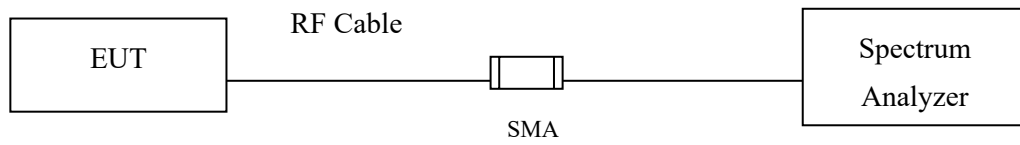

9.2. Test Procedure

The EUT was setup according to ANSI C63.10 2013; tested according to ANSI C63.10 2013 for compliance to FCC 47CFR 15.247 requirements.

9.3. Test Result of Duty Cycle

Product : IP Aux Camera WiFi Side Mount/IP Aux Camera WiFi Rear Mount
 Test Item : Duty Cycle
 Test Mode : Transmit

Duty Cycle Formula:

$$\text{Duty Cycle} = \text{Ton} / (\text{Ton} + \text{Toff})$$

$$\text{Duty Factor} = 10 \text{ Log} (1/\text{Duty Cycle})$$

Results:

2.4GHz band	Ton (ms)	Ton + Toff (ms)	Duty Cycle (%)	Duty Factor (dB)
802.11b	8.4348	8.5217	98.98	0.04
802.11g	1.3985	1.5000	93.23	0.30
802.11n20	1.3115	1.4058	93.29	0.30

802.11b

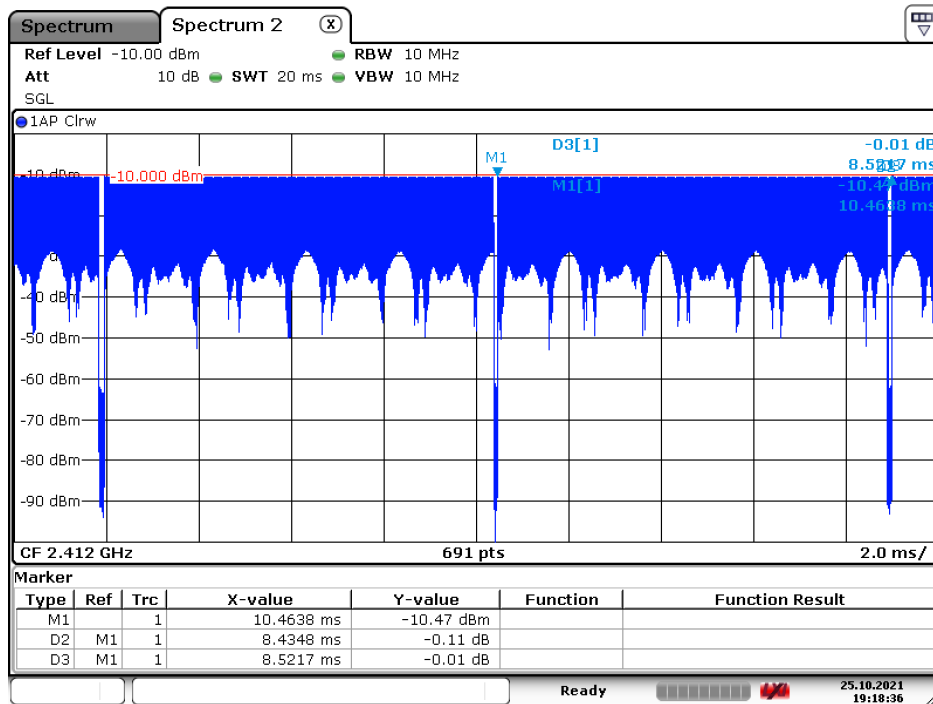

Date: 25.OCT.2021 19:18:36

802.11g

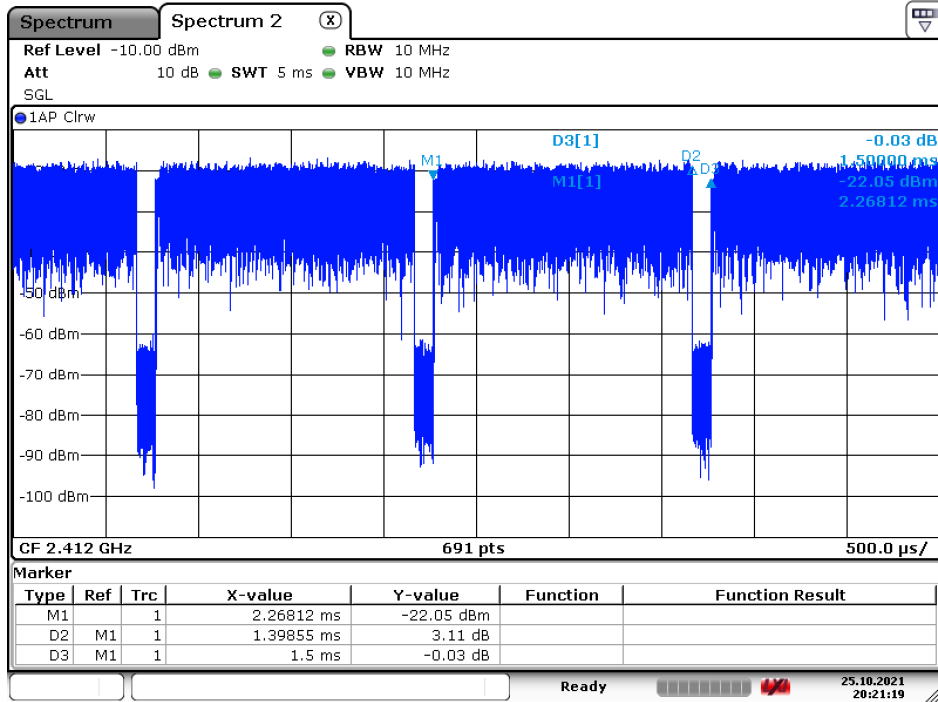

Date: 25.OCT.2021 20:21:19

802.11n20

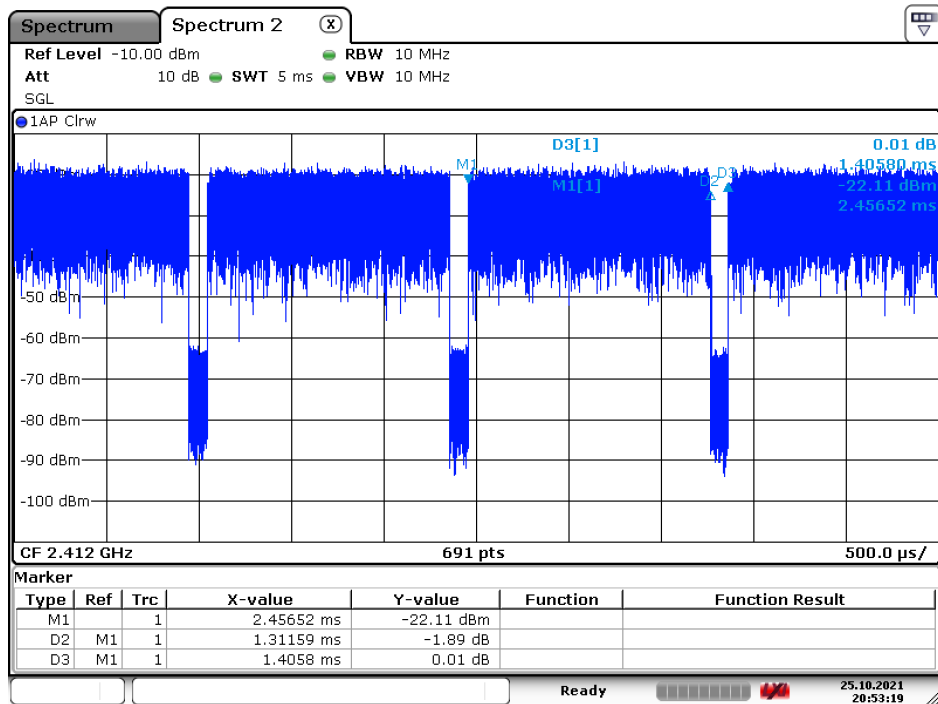

Date: 25.OCT.2021 20:53:19

10. EMI Reduction Method During Compliance Testing

No modification was made during testing.