



FCC TEST REPORT

REPORT NO.: RF960627L13A

MODEL NO.: MXP802NU2C

RECEIVED: Jul. 23, 2007

TESTED: Aug. 01 ~ Aug. 15, 2007

ISSUED: Nov. 13, 2007

APPLICANT: Newer Technology, Inc.

ADDRESS: 1002 Courtaulds Drive, Woodstock, IL, United States, 60098

ISSUED BY: Advance Data Technology Corporation

LAB ADDRESS: 47 14th Lin, Chiapau Tsun, Linko, Taipei, Taiwan, R.O.C.

TEST LOCATION: No. 19, Hwa Ya 2nd Rd., Kueishan, Taoyuan, Taiwan, R.O.C.

This test report consists of 103 pages in total. It may be duplicated completely for legal use with the approval of the applicant. It should not be reproduced except in full, without the written approval of our laboratory. The client should not use it to claim product endorsement by TAF, A2LA or any government agencies. The test results in the report only apply to the tested sample.





TABLE OF CONTENTS

1.	CERTIFICATION	4
2.	SUMMARY OF TEST RESULTS	5
2.1	MEASUREMENT UNCERTAINTY	5
3.	GENERAL INFORMATION	6
3.1	GENERAL DESCRIPTION OF EUT	6
3.2	DESCRIPTION OF TEST MODES	7
3.2.1	CONFIGURATION OF SYSTEM UNDER TEST	8
3.2.2	TEST MODE APPLICABILITY AND TESTED CHANNEL DETAIL	9
3.3	GENERAL DESCRIPTION OF APPLIED STANDARDS	11
3.4	DESCRIPTION OF SUPPORT UNITS.....	11
4.	TEST TYPES AND RESULTS	12
4.1	CONDUCTED EMISSION MEASUREMENT	12
4.1.1	LIMITS OF CONDUCTED EMISSION MEASUREMENT	12
4.1.2	TEST INSTRUMENTS.....	12
4.1.3	TEST PROCEDURES	13
4.1.4	DEVIATION FROM TEST STANDARD.....	13
4.1.5	TEST SETUP	14
4.1.6	EUT OPERATING CONDITIONS	14
4.1.7	TEST RESULTS	15
4.2	RADIATED EMISSION MEASUREMENT	33
4.2.1	LIMITS OF RADIATED EMISSION MEASUREMENT	33
4.2.2	TEST INSTRUMENTS.....	34
4.2.3	TEST PROCEDURES	35
4.2.4	DEVIATION FROM TEST STANDARD.....	35
4.2.5	TEST SETUP	36
4.2.6	EUT OPERATING CONDITIONS	36
4.2.7	TEST RESULTS	37
4.3	6dB BANDWIDTH MEASUREMENT	51
4.3.1	LIMITS OF 6dB BANDWIDTH MEASUREMENT	51
4.3.2	TEST INSTRUMENTS.....	51
4.3.3	TEST PROCEDURE	51
4.3.4	DEVIATION FROM TEST STANDARD.....	51
4.3.5	TEST SETUP	52
4.3.6	EUT OPERATING CONDITIONS	52
4.3.7	TEST RESULTS	53
4.4	MAXIMUM PEAK OUTPUT POWER.....	65
4.4.1	LIMITS OF MAXIMUM PEAK OUTPUT POWER MEASUREMENT	65
4.4.2	INSTRUMENTS	65
4.4.3	TEST PROCEDURES	65
4.4.4	DEVIATION FROM TEST STANDARD.....	65
4.4.5	TEST SETUP	66
4.4.6	EUT OPERATING CONDITIONS	66
4.4.7	TEST RESULTS	67



4.5	POWER SPECTRAL DENSITY MEASUREMENT.....	69
4.5.1	LIMITS OF POWER SPECTRAL DENSITY MEASUREMENT	69
4.5.2	TEST INSTRUMENTS.....	69
4.5.3	TEST PROCEDURE	69
4.5.4	DEVIATION FROM TEST STANDARD.....	69
4.5.5	TEST SETUP	70
4.5.6	EUT OPERATING CONDITION.....	70
4.5.7	TEST RESULTS	71
4.6	BAND EDGES MEASUREMENT	83
4.6.1	LIMITS OF BAND EDGES MEASUREMENT	83
4.6.2	TEST INSTRUMENTS.....	83
4.6.3	TEST PROCEDURE	84
4.6.4	DEVIATION FROM TEST STANDARD.....	84
4.6.5	EUT OPERATING CONDITION.....	85
4.6.6	TEST RESULTS	85
4.7	ANTENNA REQUIREMENT	101
4.7.1	STANDARD APPLICABLE	101
4.7.2	ANTENNA CONNECTED CONSTRUCTION.....	101
6.	INFORMATION ON THE TESTING LABORATORIES	102
7.	APPENDIX A - MODIFICATIONS RECORDERS FOR ENGINEERING CHANGES TO THE EUT BY THE LAB.....	103



1. CERTIFICATION

PRODUCT: Wireless-N USB Dongle
MODEL: MXP802NU2C
BRAND: MaxPower
APPLICANT: Newer Technology, Inc.
TESTED: Aug. 01 ~ Aug. 15, 2007
TEST SAMPLE: ENGINEERING SAMPLE
STANDARDS: **FCC Part 15, Subpart C (Section 15.247)**
ANSI C63.4-2003

The above equipment (model: MXP802NU2C) has been tested by **Advance Data Technology Corporation**, and found compliance with the requirement of the above standards. The test record, data evaluation & Equipment Under Test (EUT) configurations represented herein are true and accurate accounts of the measurements of the sample's EMC characteristics under the conditions specified in this report.

PREPARED BY : Ivy Lin , **DATE:** Nov. 13, 2007
Ivy Lin / Specialist

TECHNICAL ACCEPTANCE : Long Chen , **DATE:** Nov. 13, 2007
Responsible for RF Long Chen / Senior Engineer

APPROVED BY : Gary Chang , **DATE:** Nov. 13, 2007
Gary Chang / Assistant Manager

2. SUMMARY OF TEST RESULTS

The EUT has been tested according to the following specifications:

APPLIED STANDARD: FCC Part 15, Subpart C			
STANDARD SECTION	TEST TYPE AND LIMIT	RESULT	REMARK
15.207	AC Power Conducted Emission	PASS	Meet the requirement of limit. Minimum passing margin is -12.09dB at 0.179MHz.
15.247(a)(2)	Spectrum Bandwidth of a Direct Sequence Spread Spectrum System Limit : min. 500kHz	PASS	Meet the requirement of limit.
15.247(b)	Maximum Peak Output Power Limit: max. 30dBm	PASS	Meet the requirement of limit.
15.247(d)	Transmitter Radiated Emissions Limit: Table 15.209	PASS	Meet the requirement of limit. Minimum passing margin is -5.86dB at 142.67MHz.
15.247(e)	Power Spectral Density Limit: max. 8dBm	PASS	Meet the requirement of limit.
15.247(d)	Band Edge Measurement Limit: 20dB less than the peak value of fundamental frequency	PASS	Meet the requirement of limit.

2.1 MEASUREMENT UNCERTAINTY

Where relevant, the following measurement uncertainty levels have been estimated for tests performed on the EUT as specified in CISPR 16-4:

MEASUREMENT	FREQUENCY	UNCERTAINTY
Conducted emissions	9kHz ~ 30MHz	2.44 dB
Radiated emissions	30MHz ~ 200MHz	3.19 dB
	200MHz ~1000MHz	3.21 dB
	1GHz ~ 18GHz	2.26 dB
	18GHz ~ 40GHz	1.94 dB

This uncertainty represents an expanded uncertainty expressed at approximately the 95% confidence level using a coverage factor of $k = 2$.

3. GENERAL INFORMATION

3.1 GENERAL DESCRIPTION OF EUT

PRODUCT	Wireless-N USB Dongle
MODEL NO.	MXP802NU2C
FCC ID	UNH-MXP802NU2C
POWER SUPPLY	5Vdc from host equipment
MODULATION TYPE	CCK, DQPSK, DBPSK for DSSS 64QAM, 16QAM, QPSK, BPSK for OFDM
MODULATION TECHNOLOGY	DSSS, OFDM
TRANSFER RATE	802.11b: 11/ 5.5/ 2/ 1Mbps 802.11g: 54/ 48/ 36/ 24/ 18/ 12/ 9/ 6Mbps Draft 802.11n (20MHz): 144.444/ 130.000/ 115.556/ 86.667/ 57.778/ 43.333/ 28.889/ 14.444/ 72.2/ 65.0/ 57.8/ 43.3/ 28.9/ 21.7/ 14.4/ 7.2Mbps Draft 802.11n (40MHz): 300/ 270/ 240/ 180/ 120/ 90/ 60/ 30/ 150/ 135/ 120/ 90/ 60/ 45/ 30/ 15Mbps
FREQUENCY RANGE	2412MHz ~ 2462MHz
NUMBER OF CHANNEL	11 for 802.11b, 802.11g, draft 802.11n (20MHz) 7 for draft 802.11n (40MHz)
MAXIMUM OUTPUT POWER	15.507mW
ANTENNA TYPE	Printed antenna with 1.0dBi gain
DATA CABLE	1.45m shielded USB cable without core for cradle
I/O PORTS	USB
ACCESSORY DEVICES	NA

NOTE:

1. This is a duplicate report of RF960627L13, the difference are changing applicant, brand name and model name.
2. The EUT incorporates a MIMO function with 802.11b, 802.11g and draft 802.11n. Physically, the card provides two completed transmitters and two receivers.
3. The EUT is 2 * 2 spatial MIMO (2Tx & 2Rx) without beam forming function.
4. When the EUT operating in 802.11b and 802.11g, the software operation, which is defined by manufacturer, only set single Tx.
5. When the EUT operating in draft 802.11n, the software operation, which is defined by manufacturer, only set 0 ~ 15 of "MCS" (MCS: Modulation and Coding Schemes) for dual Tx.
6. The EUT complies with draft 802.11n standards and backwards compatible with 802.11b, 802.11g products.
7. The EUT operates in the 2.4GHz frequency spectrum with throughput of up to 300Mbps.
8. The above EUT information was declared by manufacturer and for more detailed features description, please refer to the manufacturer's specifications or user's manual.

3.2 DESCRIPTION OF TEST MODES

Eleven channels are provided for 802.11b, 802.11g and draft 802.11n (20MHz):

CHANNEL	FREQUENCY	CHANNEL	FREQUENCY
1	2412MHz	7	2442MHz
2	2417MHz	8	2447MHz
3	2422MHz	9	2452MHz
4	2427MHz	10	2457MHz
5	2432MHz	11	2462MHz
6	2437MHz		

Seven channels are provided for draft 802.11n (40MHz):

CHANNEL	FREQUENCY	CHANNEL	FREQUENCY
1	2422MHz	5	2442MHz
2	2427MHz	6	2447MHz
3	2432MHz	7	2452MHz
4	2437MHz		

3.2.1 CONFIGURATION OF SYSTEM UNDER TEST

Test mode A

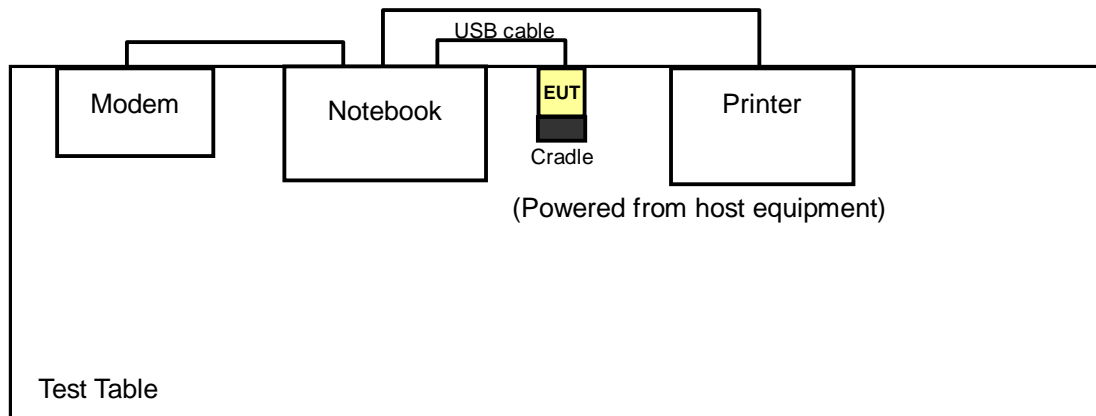

Test mode B

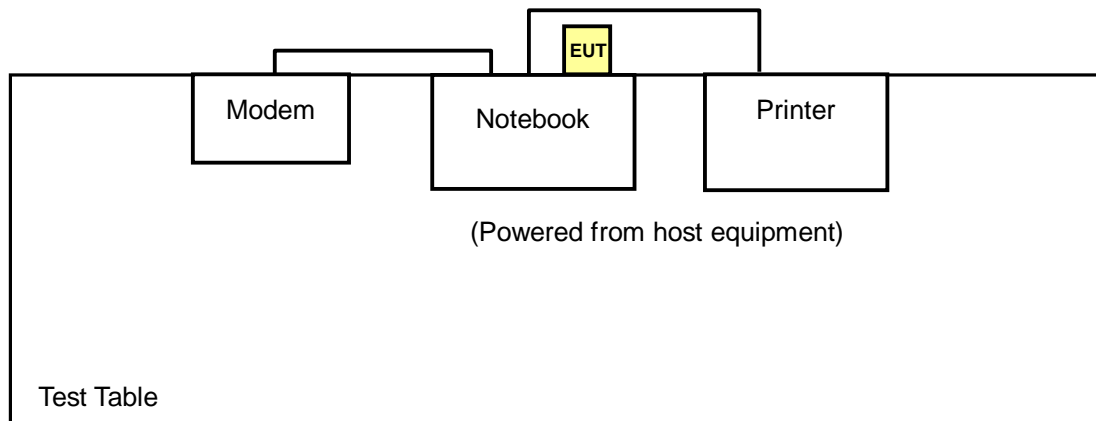

3.2.2 TEST MODE APPLICABILITY AND TESTED CHANNEL DETAIL

EUT CONFIGURE MODE	APPLICABLE TO				DESCRIPTION
	PLC	RE < 1G	RE ≥ 1G	APCM	
A	√	√	√	√	With cradle
B	NOTE 1	√	NOTE 2	NOTE 2	Without cradle

Where **PLC**: Power Line Conducted Emission **RE < 1G**: Radiated Emission below 1GHz
RE ≥ 1G: Radiated Emission above 1GHz **APCM**: Antenna Port Conducted Measurement

NOTE 1: After pre-testing each mode, the worst case was found at test mode A.
2: No effect.

POWER LINE CONDUCTED EMISSION TEST:

- Pre-Scan has been conducted to determine the worst-case mode from all possible combinations between available modulations, data rates and antenna ports (if EUT with antenna diversity architecture).
- Following channel(s) was (were) selected for the final test as listed below.

EUT CONFIGURE MODE	MODE	AVAILABLE CHANNEL	TESTED CHANNEL	MODULATION TECHNOLOGY	MODULATION TYPE	DATA RATE (Mbps)
A	802.11g	1 to 11	1, 6, 11	OFDM	BPSK	6.0
A	Draft 802.11n (20MHz)	1 to 11	1, 6, 11	OFDM	BPSK	7.2
A	Draft 802.11n (40MHz)	1 to 7	1, 4, 7	OFDM	BPSK	15.0

RADIATED EMISSION TEST (BELOW 1 GHz):

- Pre-Scan has been conducted to determine the worst-case mode from all possible combinations between available modulations, data rates and antenna ports (if EUT with antenna diversity architecture).
- Following channel(s) was (were) selected for the final test as listed below.

EUT CONFIGURE MODE	MODE	AVAILABLE CHANNEL	TESTED CHANNEL	MODULATION TECHNOLOGY	MODULATION TYPE	DATA RATE (Mbps)
A, B	802.11g	1 to 11	1	OFDM	BPSK	6.0

RADIATED EMISSION TEST (ABOVE 1 GHz):

- Pre-Scan has been conducted to determine the worst-case mode from all possible combinations between available modulations, data rates and antenna ports (if EUT with antenna diversity architecture).
- Following channel(s) was (were) selected for the final test as listed below.

EUT CONFIGURE MODE	MODE	AVAILABLE CHANNEL	TESTED CHANNEL	MODULATION TECHNOLOGY	MODULATION TYPE	DATA RATE (Mbps)
A	802.11b	1 to 11	1, 6, 11	DSSS	DBPSK	1.0
A	802.11g	1 to 11	1, 6, 11	OFDM	BPSK	6.0
A	Draft 802.11n (20MHz)	1 to 11	1, 6, 11	OFDM	BPSK	7.2
A	Draft 802.11n (40MHz)	1 to 7	1, 4, 7	OFDM	BPSK	15.0

BANDEDGE MEASUREMENT:

- Pre-Scan has been conducted to determine the worst-case mode from all possible combinations between available modulations, data rates and antenna ports (if EUT with antenna diversity architecture).
- Following channel(s) was (were) selected for the final test as listed below.

EUT CONFIGURE MODE	MODE	AVAILABLE CHANNEL	TESTED CHANNEL	MODULATION TECHNOLOGY	MODULATION TYPE	DATA RATE (Mbps)
A	802.11b	1 to 11	1, 11	DSSS	DBPSK	1.0
A	802.11g	1 to 11	1, 11	OFDM	BPSK	6.0
A	Draft 802.11n (20MHz)	1 to 11	1, 11	OFDM	BPSK	7.2
A	Draft 802.11n (40MHz)	1 to 7	1, 7	OFDM	BPSK	15.0

ANTENNA PORT CONDUCTED MEASUREMENT:

- Pre-Scan has been conducted to determine the worst-case mode from all possible combinations between available modulations, data rates and antenna ports (if EUT with antenna diversity architecture).
- Following channel(s) was (were) selected for the final test as listed below.

EUT CONFIGURE MODE	MODE	AVAILABLE CHANNEL	TESTED CHANNEL	MODULATION TECHNOLOGY	MODULATION TYPE	DATA RATE (Mbps)
A	802.11b	1 to 11	1, 6, 11	DSSS	DBPSK	1.0
A	802.11g	1 to 11	1, 6, 11	OFDM	BPSK	6.0
A	Draft 802.11n (20MHz)	1 to 11	1, 6, 11	OFDM	BPSK	7.2
A	Draft 802.11n (40MHz)	1 to 7	1, 4, 7	OFDM	BPSK	15.0

3.3 GENERAL DESCRIPTION OF APPLIED STANDARDS

The EUT is a RF product. According to the specifications of the manufacturer, it must comply with the requirements of the following standards:

FCC Part 15, Subpart C. (15.247)

ANSI C63.4-2003

All test items have been performed and recorded as per the above standards.

NOTE: The EUT is also considered as a kind of computer peripheral, because the connection to computer is necessary for typical use. It has been verified to comply with the requirements of FCC Part 15, Subpart B, Class B (DoC). The test report has been issued separately.

3.4 DESCRIPTION OF SUPPORT UNITS

The EUT has been tested as an independent unit together with other necessary accessories or support units. The following support units or accessories were used to form a representative test configuration during the tests.

NO.	PRODUCT	BRAND	MODEL NO.	SERIAL NO.	FCC ID
1	NOTEBOOK COMPUTER	DELL	PP05L	12130898320	E2K24CLNS
2	PRINTER	EPSON	LQ-300+	DCGY054146	FCC DoC Approved
3	MODEM	ACEEX	1414V/3	0401008260	IFAXDM1414

NO.	SIGNAL CABLE DESCRIPTION OF THE ABOVE SUPPORT UNITS
1	NA
2	1.8m braid shielded wire , DB25 connector , w/o core.
3	1.2m braid shielded wire , DB25 & DB9 connector , w/o core.

NOTE: All power cords of the above support units are non shielded (1.8m).

4. TEST TYPES AND RESULTS

4.1 CONDUCTED EMISSION MEASUREMENT

4.1.1 LIMITS OF CONDUCTED EMISSION MEASUREMENT

FREQUENCY OF EMISSION (MHz)	CONDUCTED LIMIT (dB μ V)	
	Quasi-peak	Average
0.15-0.5	66 to 56	56 to 46
0.5-5	56	46
5-30	60	50

- NOTE:**
1. The lower limit shall apply at the transition frequencies.
 2. The limit decreases in line with the logarithm of the frequency in the range of 0.15 to 0.50 MHz.
 3. All emanations from a class A/B digital device or system, including any network of conductors and apparatus connected thereto, shall not exceed the level of field strengths specified above.

4.1.2 TEST INSTRUMENTS

DESCRIPTION & MANUFACTURER	MODEL NO.	SERIAL NO.	CALIBRATED UNTIL
Test Receiver ROHDE & SCHWARZ	ESCS30	100288	Sep. 25, 2007
RF signal cable Woken	5D-FB	Cable-HYCO3-01	Jan. 06, 2008
LISN ROHDE & SCHWARZ	ESH2-Z5	100100	Jan. 08, 2008
LISN ROHDE & SCHWARZ	ESH3-Z5	100311	Jan. 16, 2008
Software ADT	ADT_Cond_V3	NA	NA

- NOTE:**
1. The calibration interval of the above test instruments is 12 months and the calibrations are traceable to NML/ROC and NIST/USA.
 2. The test was performed in HwaYa Shielded Room 2.
 3. The VCCI Site Registration No. is C-2047.

4.1.3 TEST PROCEDURES

- a. The EUT was placed 0.4 meters from the conducting wall of the shielded room with EUT being connected to the power mains through a line impedance stabilization network (LISN). Other support units were connected to the power mains through another LISN. The two LISNs provide 50 ohm/ 50uH of coupling impedance for the measuring instrument.
- b. Both lines of the power mains connected to the EUT were checked for maximum conducted interference.
- c. The frequency range from 150kHz to 30MHz was searched. Emission levels under (Limit - 20dB) was not recorded.

4.1.4 DEVIATION FROM TEST STANDARD

No deviation

4.1.5 TEST SETUP

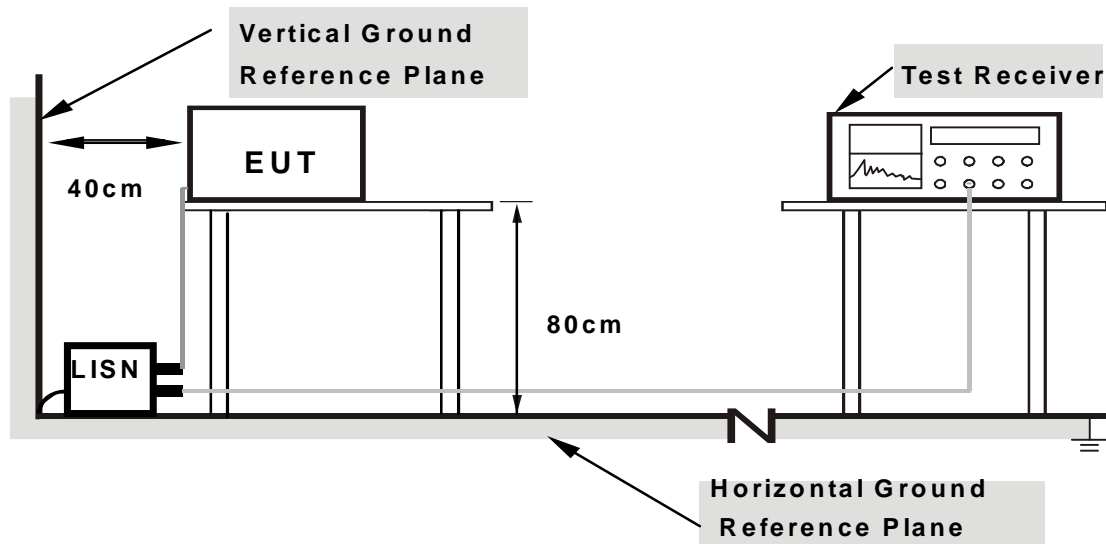

- Note:**
1. Support units were connected to second LISN.
 2. Both of LISNs (AMN) are 80 cm from EUT and at least 80 from other units and other metal planes

For the actual test configuration, please refer to the attached file (Test Setup Photo).

4.1.6 EUT OPERATING CONDITIONS

- a. Connected the EUT to notebook via USB cable with cradle and placed on a testing table.
- b. The notebook ran a test program (provided by manufacturer) to enable EUT under transmission condition continuously at specific channel frequency.
- c. The necessary accessories enable the system in full functions.

4.1.7 TEST RESULTS

CONDUCTED WORST-CASE DATA: 802.11g OFDM MODULATION

EUT TEST CONDITION		MEASUREMENT DETAIL	
CHANNEL	Channel 1	PHASE	Line 1
MODULATION TYPE	BPSK	6dB BANDWIDTH	9 kHz
TRANSFER RATE	6.0Mbps	INPUT POWER (SYSTEM)	120Vac, 60 Hz
ENVIRONMENTAL CONDITIONS	22deg. C, 60%RH, 991hPa	TESTED BY	Match Tsui

No	Freq. [MHz]	Corr.	Reading Value		Emission Level		Limit		Margin	
		Factor	[dB (uV)]		[dB (uV)]		[dB (uV)]		(dB)	
		(dB)	Q.P.	AV.	Q.P.	AV.	Q.P.	AV.	Q.P.	AV.
1	0.179	0.10	52.36	-	52.46	-	64.55	54.55	-12.09	-
2	0.236	0.10	43.20	-	43.30	-	62.22	52.22	-18.92	-
3	1.762	0.19	31.50	-	31.69	-	56.00	46.00	-24.31	-
4	2.699	0.24	30.08	-	30.32	-	56.00	46.00	-25.68	-
5	4.109	0.28	33.18	-	33.46	-	56.00	46.00	-22.54	-
6	19.183	0.56	27.57	-	28.13	-	60.00	50.00	-31.87	-

- REMARKS:**
1. Q.P. and AV. are abbreviations of quasi-peak and average individually.
 2. "-": The Quasi-peak reading value also meets average limit and measurement with the average detector is unnecessary.
 3. The emission levels of other frequencies were very low against the limit.
 4. Margin value = Emission level - Limit value
 5. Correction factor = Insertion loss + Cable loss
 6. Emission Level = Correction Factor + Reading Value.

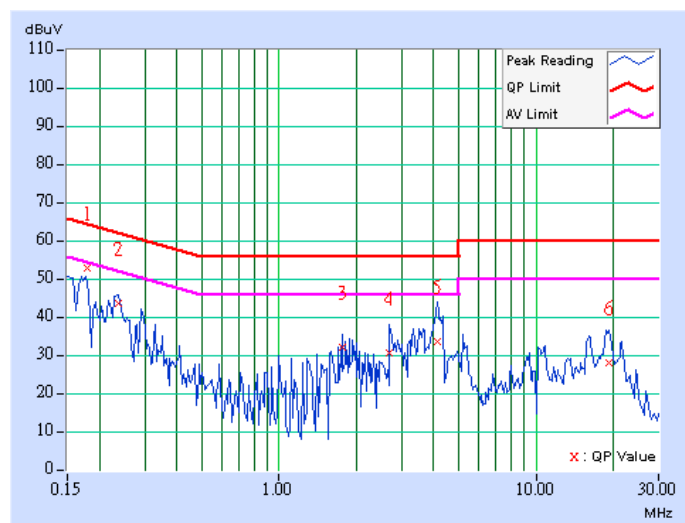

EUT TEST CONDITION		MEASUREMENT DETAIL	
CHANNEL	Channel 1	PHASE	Line 2
MODULATION TYPE	BPSK	6dB BANDWIDTH	9 kHz
TRANSFER RATE	6.0Mbps	INPUT POWER (SYSTEM)	120Vac, 60 Hz
ENVIRONMENTAL CONDITIONS	22deg. C, 60%RH, 991hPa	TESTED BY	Match Tsui

No	Freq.	Corr.	Reading Value		Emission Level		Limit		Margin	
		Factor	[dB (uV)]		[dB (uV)]		[dB (uV)]		(dB)	
	[MHz]	(dB)	Q.P.	AV.	Q.P.	AV.	Q.P.	AV.	Q.P.	AV.
1	0.179	0.10	52.07	-	52.17	-	64.55	54.55	-12.38	-
2	0.236	0.10	43.51	-	43.61	-	62.24	52.24	-18.63	-
3	2.115	0.22	32.27	-	32.49	-	56.00	46.00	-23.51	-
4	3.520	0.27	34.37	-	34.64	-	56.00	46.00	-21.36	-
5	3.814	0.27	37.08	-	37.35	-	56.00	46.00	-18.65	-
6	17.337	0.52	28.33	-	28.85	-	60.00	50.00	-31.15	-

- REMARKS:**
1. Q.P. and AV. are abbreviations of quasi-peak and average individually.
 2. "-": The Quasi-peak reading value also meets average limit and measurement with the average detector is unnecessary.
 3. The emission levels of other frequencies were very low against the limit.
 4. Margin value = Emission level - Limit value
 5. Correction factor = Insertion loss + Cable loss
 6. Emission Level = Correction Factor + Reading Value.

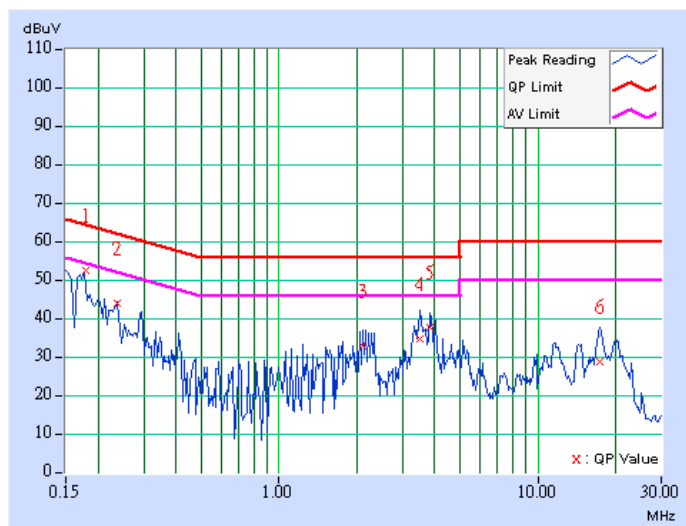

EUT TEST CONDITION		MEASUREMENT DETAIL	
CHANNEL	Channel 6	PHASE	Line 1
MODULATION TYPE	BPSK	6dB BANDWIDTH	9 kHz
TRANSFER RATE	6.0Mbps	INPUT POWER (SYSTEM)	120Vac, 60 Hz
ENVIRONMENTAL CONDITIONS	22deg. C, 60%RH, 991hPa	TESTED BY	Match Tsui

No	Freq. [MHz]	Corr. Factor (dB)	Reading Value		Emission Level		Limit		Margin	
			[dB (uV)]		[dB (uV)]		[dB (uV)]		(dB)	
			Q.P.	AV.	Q.P.	AV.	Q.P.	AV.	Q.P.	AV.
1	0.177	0.10	51.27	-	51.37	-	64.60	54.60	-13.23	-
2	0.236	0.10	42.27	-	42.37	-	62.22	52.22	-19.85	-
3	1.764	0.19	32.24	-	32.43	-	56.00	46.00	-23.57	-
4	2.700	0.24	28.27	-	28.51	-	56.00	46.00	-27.49	-
5	4.113	0.28	36.07	-	36.35	-	56.00	46.00	-19.65	-
6	19.186	0.56	30.87	-	31.43	-	60.00	50.00	-28.57	-

- REMARKS:**
1. Q.P. and AV. are abbreviations of quasi-peak and average individually.
 2. "-": The Quasi-peak reading value also meets average limit and measurement with the average detector is unnecessary.
 3. The emission levels of other frequencies were very low against the limit.
 4. Margin value = Emission level - Limit value
 5. Correction factor = Insertion loss + Cable loss
 6. Emission Level = Correction Factor + Reading Value.

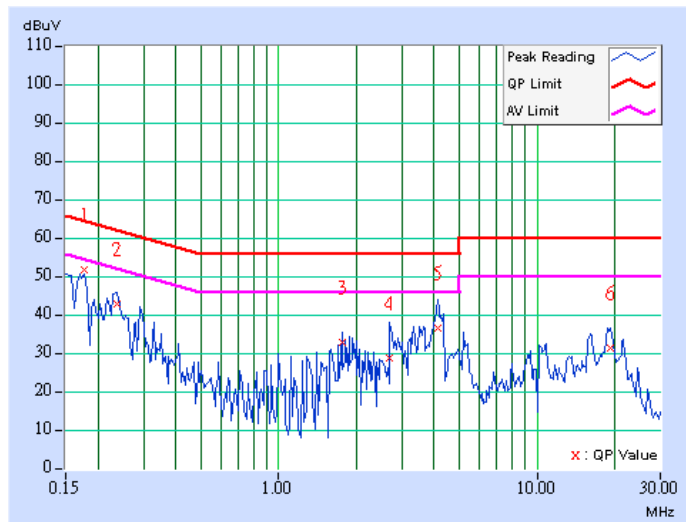

EUT TEST CONDITION		MEASUREMENT DETAIL	
CHANNEL	Channel 6	PHASE	Line 2
MODULATION TYPE	BPSK	6dB BANDWIDTH	9 kHz
TRANSFER RATE	6.0Mbps	INPUT POWER (SYSTEM)	120Vac, 60 Hz
ENVIRONMENTAL CONDITIONS	22deg. C, 60%RH, 991hPa	TESTED BY	Match Tsui

No	Freq. [MHz]	Corr. Factor (dB)	Reading Value		Emission Level		Limit		Margin	
			[dB (uV)]		[dB (uV)]		[dB (uV)]		(dB)	
			Q.P.	AV.	Q.P.	AV.	Q.P.	AV.	Q.P.	AV.
1	0.181	0.10	49.97	-	50.07	-	64.43	54.43	-14.36	-
2	0.236	0.10	42.60	-	42.70	-	62.23	52.23	-19.53	-
3	1.985	0.22	32.85	-	33.07	-	56.00	46.00	-22.93	-
4	4.270	0.29	36.78	-	37.07	-	56.00	46.00	-18.93	-
5	5.145	0.31	33.24	-	33.55	-	60.00	50.00	-26.45	-
6	16.845	0.51	31.57	-	32.08	-	60.00	50.00	-27.92	-

- REMARKS:**
1. Q.P. and AV. are abbreviations of quasi-peak and average individually.
 2. "-": The Quasi-peak reading value also meets average limit and measurement with the average detector is unnecessary.
 3. The emission levels of other frequencies were very low against the limit.
 4. Margin value = Emission level - Limit value
 5. Correction factor = Insertion loss + Cable loss
 6. Emission Level = Correction Factor + Reading Value.

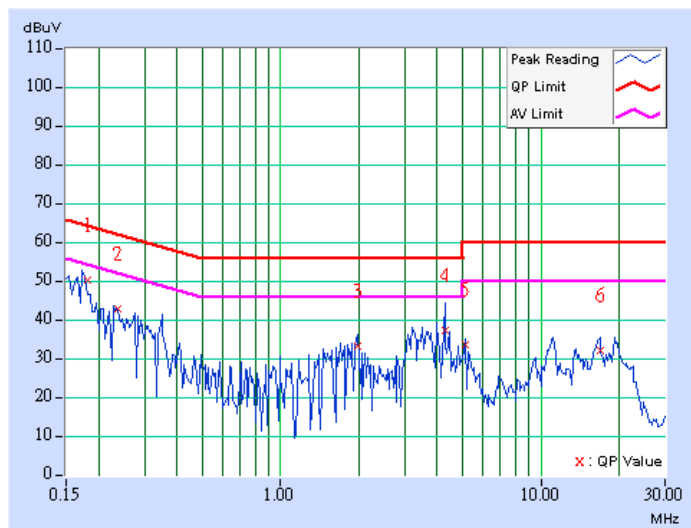

EUT TEST CONDITION		MEASUREMENT DETAIL	
CHANNEL	Channel 11	PHASE	Line 1
MODULATION TYPE	BPSK	6dB BANDWIDTH	9 kHz
TRANSFER RATE	6.0Mbps	INPUT POWER (SYSTEM)	120Vac, 60 Hz
ENVIRONMENTAL CONDITIONS	22deg. C, 60%RH, 991hPa	TESTED BY	Match Tsui

No	Freq.	Corr. Factor	Reading Value		Emission Level		Limit		Margin	
			[dB (uV)]		[dB (uV)]		[dB (uV)]		(dB)	
	[MHz]	(dB)	Q.P.	AV.	Q.P.	AV.	Q.P.	AV.	Q.P.	AV.
1	0.175	0.10	50.24	-	50.34	-	64.70	54.70	-14.36	-
2	0.221	0.10	42.07	-	42.17	-	62.76	52.76	-20.59	-
3	2.272	0.23	32.27	-	32.50	-	56.00	46.00	-23.50	-
4	3.625	0.27	36.70	-	36.97	-	56.00	46.00	-19.03	-
5	5.085	0.29	32.28	-	32.57	-	60.00	50.00	-27.43	-
6	17.251	0.52	31.58	-	32.10	-	60.00	50.00	-27.90	-

- REMARKS:**
1. Q.P. and AV. are abbreviations of quasi-peak and average individually.
 2. "-": The Quasi-peak reading value also meets average limit and measurement with the average detector is unnecessary.
 3. The emission levels of other frequencies were very low against the limit.
 4. Margin value = Emission level - Limit value
 5. Correction factor = Insertion loss + Cable loss
 6. Emission Level = Correction Factor + Reading Value.

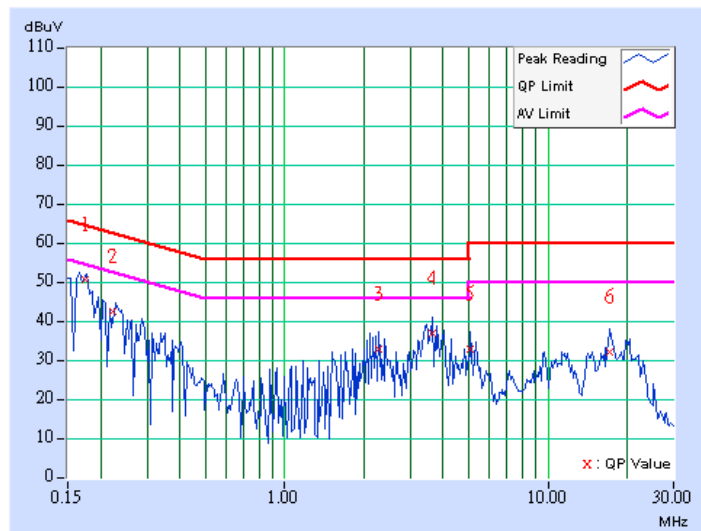

EUT TEST CONDITION		MEASUREMENT DETAIL	
CHANNEL	Channel 11	PHASE	Line 2
MODULATION TYPE	BPSK	6dB BANDWIDTH	9 kHz
TRANSFER RATE	6.0Mbps	INPUT POWER (SYSTEM)	120Vac, 60 Hz
ENVIRONMENTAL CONDITIONS	22deg. C, 60%RH, 991hPa	TESTED BY	Match Tsui

No	Freq. [MHz]	Corr.	Reading Value		Emission Level		Limit		Margin	
		Factor	[dB (uV)]		[dB (uV)]		[dB (uV)]		(dB)	
		(dB)	Q.P.	AV.	Q.P.	AV.	Q.P.	AV.	Q.P.	AV.
1	0.178	0.10	51.54	-	51.64	-	64.60	54.60	-12.96	-
2	0.225	0.10	42.24	-	42.34	-	62.64	52.64	-20.30	-
3	2.116	0.22	32.27	-	32.49	-	56.00	46.00	-23.51	-
4	3.508	0.27	34.37	-	34.64	-	56.00	46.00	-21.36	-
5	3.807	0.27	38.60	-	38.87	-	56.00	46.00	-17.13	-
6	17.326	0.52	31.31	-	31.83	-	60.00	50.00	-28.17	-

- REMARKS:**
1. Q.P. and AV. are abbreviations of quasi-peak and average individually.
 2. "-": The Quasi-peak reading value also meets average limit and measurement with the average detector is unnecessary.
 3. The emission levels of other frequencies were very low against the limit.
 4. Margin value = Emission level - Limit value
 5. Correction factor = Insertion loss + Cable loss
 6. Emission Level = Correction Factor + Reading Value.

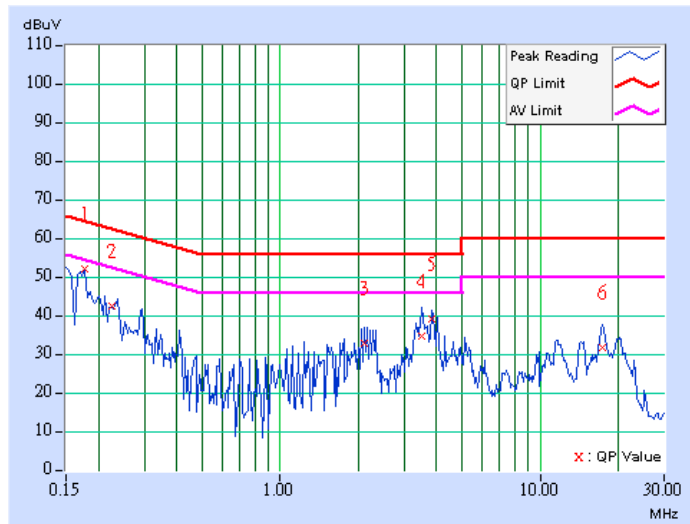

DRAFT 802.11n (20MHz) OFDM MODULATION

EUT TEST CONDITION		MEASUREMENT DETAIL	
CHANNEL	Channel 1	PHASE	Line 1
MODULATION TYPE	BPSK	6dB BANDWIDTH	9 kHz
TRANSFER RATE	7.2Mbps	INPUT POWER (SYSTEM)	120Vac, 60 Hz
ENVIRONMENTAL CONDITIONS	22deg. C, 60%RH, 991hPa	TESTED BY	Match Tsui

No	Freq. [MHz]	Corr. Factor (dB)	Reading Value		Emission Level		Limit		Margin	
			[dB (uV)]		[dB (uV)]		[dB (uV)]		(dB)	
			Q.P.	AV.	Q.P.	AV.	Q.P.	AV.	Q.P.	AV.
1	0.181	0.10	50.54	-	50.64	-	64.45	54.45	-13.81	-
2	0.234	0.10	43.08	-	43.18	-	62.32	52.32	-19.14	-
3	2.282	0.23	32.57	-	32.80	-	56.00	46.00	-23.20	-
4	3.635	0.27	37.69	-	37.96	-	56.00	46.00	-18.04	-
5	5.076	0.29	34.24	-	34.53	-	60.00	50.00	-25.47	-
6	17.256	0.52	30.50	-	31.02	-	60.00	50.00	-28.98	-

- REMARKS:**
1. Q.P. and AV. are abbreviations of quasi-peak and average individually.
 2. "-": The Quasi-peak reading value also meets average limit and measurement with the average detector is unnecessary.
 3. The emission levels of other frequencies were very low against the limit.
 4. Margin value = Emission level - Limit value
 5. Correction factor = Insertion loss + Cable loss
 6. Emission Level = Correction Factor + Reading Value.

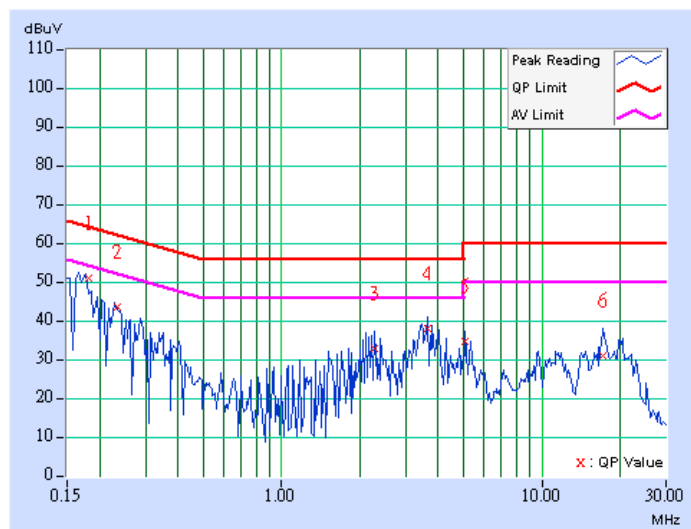

EUT TEST CONDITION		MEASUREMENT DETAIL	
CHANNEL	Channel 1	PHASE	Line 2
MODULATION TYPE	BPSK	6dB BANDWIDTH	9 kHz
TRANSFER RATE	7.2Mbps	INPUT POWER (SYSTEM)	120Vac, 60 Hz
ENVIRONMENTAL CONDITIONS	22deg. C, 60%RH, 991hPa	TESTED BY	Match Tsui

No	Freq. [MHz]	Corr. Factor (dB)	Reading Value		Emission Level		Limit		Margin	
			[dB (uV)]		[dB (uV)]		[dB (uV)]		(dB)	
			Q.P.	AV.	Q.P.	AV.	Q.P.	AV.	Q.P.	AV.
1	0.177	0.10	51.54	-	51.64	-	64.61	54.61	-12.97	-
2	0.234	0.10	43.51	-	43.61	-	62.29	52.29	-18.68	-
3	2.113	0.22	30.57	-	30.79	-	56.00	46.00	-25.21	-
4	3.405	0.26	35.08	-	35.34	-	56.00	46.00	-20.66	-
5	3.805	0.27	36.65	-	36.92	-	56.00	46.00	-19.08	-
6	17.335	0.52	30.86	-	31.38	-	60.00	50.00	-28.62	-

- REMARKS:**
1. Q.P. and AV. are abbreviations of quasi-peak and average individually.
 2. "-": The Quasi-peak reading value also meets average limit and measurement with the average detector is unnecessary.
 3. The emission levels of other frequencies were very low against the limit.
 4. Margin value = Emission level - Limit value
 5. Correction factor = Insertion loss + Cable loss
 6. Emission Level = Correction Factor + Reading Value.

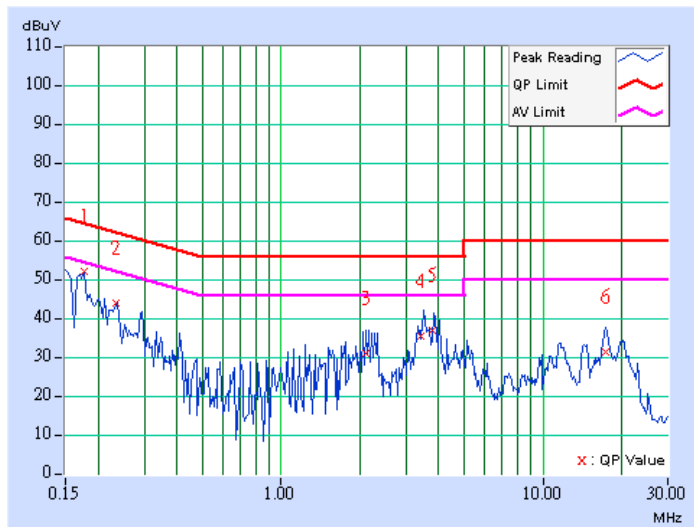

EUT TEST CONDITION		MEASUREMENT DETAIL	
CHANNEL	Channel 6	PHASE	Line 1
MODULATION TYPE	BPSK	6dB BANDWIDTH	9 kHz
TRANSFER RATE	7.2Mbps	INPUT POWER (SYSTEM)	120Vac, 60 Hz
ENVIRONMENTAL CONDITIONS	22deg. C, 60%RH, 991hPa	TESTED BY	Match Tsui

No	Freq.	Corr. Factor	Reading Value		Emission Level		Limit		Margin	
			[dB (uV)]		[dB (uV)]		[dB (uV)]		(dB)	
	[MHz]	(dB)	Q.P.	AV.	Q.P.	AV.	Q.P.	AV.	Q.P.	AV.
1	0.163	0.10	49.24	-	49.34	-	65.29	55.29	-15.95	-
2	0.236	0.10	42.27	-	42.37	-	62.24	52.24	-19.87	-
3	1.753	0.19	30.54	-	30.73	-	56.00	46.00	-25.27	-
4	2.700	0.24	29.67	-	29.91	-	56.00	46.00	-26.09	-
5	4.101	0.28	35.05	-	35.33	-	56.00	46.00	-20.67	-
6	19.175	0.56	29.63	-	30.19	-	60.00	50.00	-29.81	-

- REMARKS:**
1. Q.P. and AV. are abbreviations of quasi-peak and average individually.
 2. "-": The Quasi-peak reading value also meets average limit and measurement with the average detector is unnecessary.
 3. The emission levels of other frequencies were very low against the limit.
 4. Margin value = Emission level - Limit value
 5. Correction factor = Insertion loss + Cable loss
 6. Emission Level = Correction Factor + Reading Value.

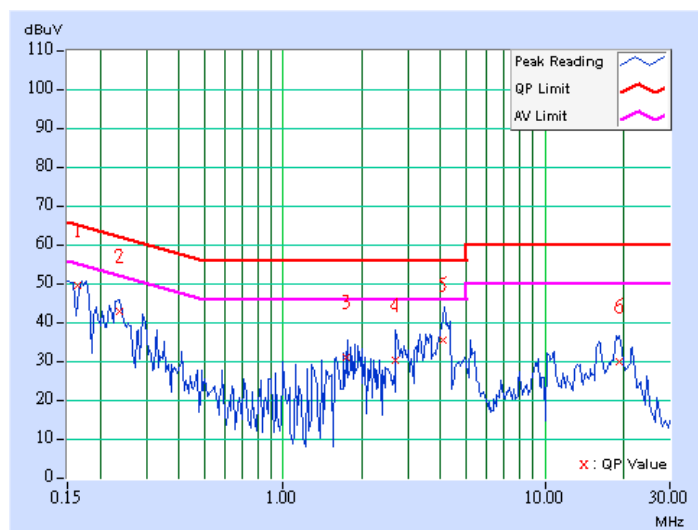

EUT TEST CONDITION		MEASUREMENT DETAIL	
CHANNEL	Channel 6	PHASE	Line 2
MODULATION TYPE	BPSK	6dB BANDWIDTH	9 kHz
TRANSFER RATE	7.2Mbps	INPUT POWER (SYSTEM)	120Vac, 60 Hz
ENVIRONMENTAL CONDITIONS	22deg. C, 60%RH, 991hPa	TESTED BY	Match Tsui

No	Freq.	Corr. Factor	Reading Value		Emission Level		Limit		Margin	
			[dB (uV)]		[dB (uV)]		[dB (uV)]		(dB)	
	[MHz]	(dB)	Q.P.	AV.	Q.P.	AV.	Q.P.	AV.	Q.P.	AV.
1	0.173	0.10	49.27	-	49.37	-	64.80	54.80	-15.43	-
2	0.235	0.10	42.60	-	42.70	-	62.26	52.26	-19.56	-
3	1.986	0.22	32.85	-	33.07	-	56.00	46.00	-22.93	-
4	4.269	0.29	34.84	-	35.13	-	56.00	46.00	-20.87	-
5	5.145	0.31	34.08	-	34.39	-	60.00	50.00	-25.61	-
6	16.847	0.51	30.20	-	30.71	-	60.00	50.00	-29.29	-

- REMARKS:**
1. Q.P. and AV. are abbreviations of quasi-peak and average individually.
 2. "-": The Quasi-peak reading value also meets average limit and measurement with the average detector is unnecessary.
 3. The emission levels of other frequencies were very low against the limit.
 4. Margin value = Emission level - Limit value
 5. Correction factor = Insertion loss + Cable loss
 6. Emission Level = Correction Factor + Reading Value.

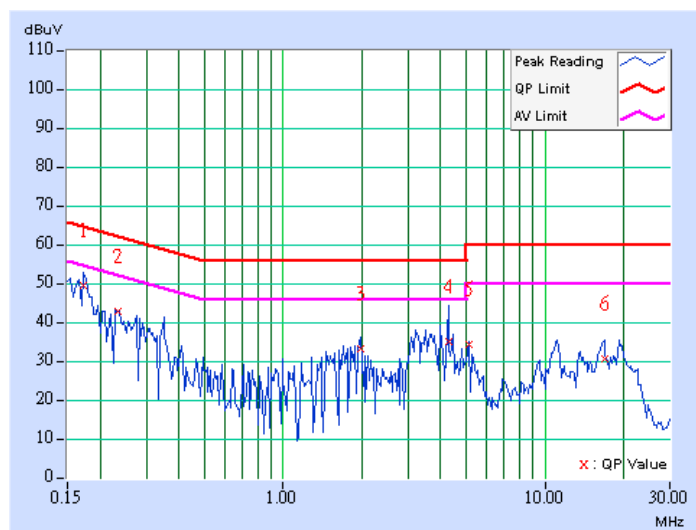

EUT TEST CONDITION		MEASUREMENT DETAIL	
CHANNEL	Channel 11	PHASE	Line 1
MODULATION TYPE	BPSK	6dB BANDWIDTH	9 kHz
TRANSFER RATE	7.2Mbps	INPUT POWER (SYSTEM)	120Vac, 60 Hz
ENVIRONMENTAL CONDITIONS	22deg. C, 60%RH, 991hPa	TESTED BY	Match Tsui

No	Freq.	Corr. Factor	Reading Value		Emission Level		Limit		Margin	
			[dB (uV)]		[dB (uV)]		[dB (uV)]		(dB)	
	[MHz]	(dB)	Q.P.	AV.	Q.P.	AV.	Q.P.	AV.	Q.P.	AV.
1	0.171	0.10	49.64	-	49.74	-	64.89	54.89	-15.15	-
2	0.232	0.10	42.72	-	42.82	-	62.39	52.39	-19.57	-
3	2.050	0.22	32.87	-	33.09	-	56.00	46.00	-22.91	-
4	3.633	0.27	37.26	-	37.53	-	56.00	46.00	-18.47	-
5	4.922	0.29	30.34	-	30.63	-	56.00	46.00	-25.37	-
6	17.281	0.52	30.59	-	31.11	-	60.00	50.00	-28.89	-

- REMARKS:**
1. Q.P. and AV. are abbreviations of quasi-peak and average individually.
 2. "-": The Quasi-peak reading value also meets average limit and measurement with the average detector is unnecessary.
 3. The emission levels of other frequencies were very low against the limit.
 4. Margin value = Emission level - Limit value
 5. Correction factor = Insertion loss + Cable loss
 6. Emission Level = Correction Factor + Reading Value.

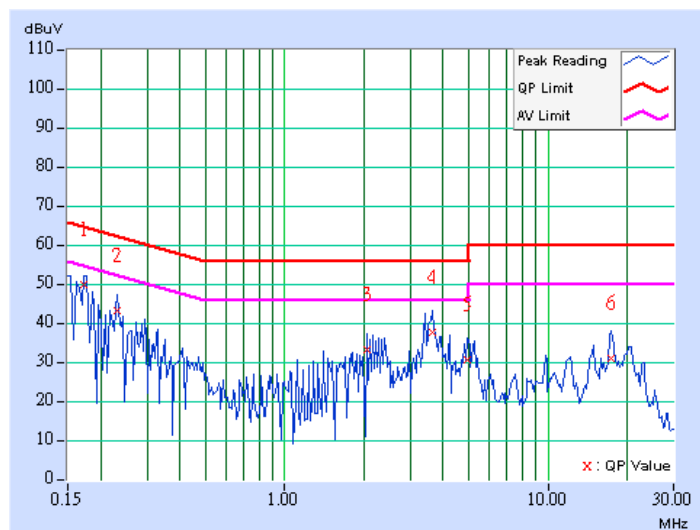

EUT TEST CONDITION		MEASUREMENT DETAIL	
CHANNEL	Channel 11	PHASE	Line 2
MODULATION TYPE	BPSK	6dB BANDWIDTH	9 kHz
TRANSFER RATE	7.2Mbps	INPUT POWER (SYSTEM)	120Vac, 60 Hz
ENVIRONMENTAL CONDITIONS	22deg. C, 60%RH, 991hPa	TESTED BY	Match Tsui

No	Freq.	Corr. Factor	Reading Value		Emission Level		Limit		Margin	
			[dB (uV)]		[dB (uV)]		[dB (uV)]		(dB)	
	[MHz]	(dB)	Q.P.	AV.	Q.P.	AV.	Q.P.	AV.	Q.P.	AV.
1	0.172	0.10	48.89	-	48.99	-	64.85	54.85	-15.86	-
2	0.236	0.10	42.60	-	42.70	-	62.24	52.24	-19.54	-
3	1.984	0.22	32.27	-	32.49	-	56.00	46.00	-23.51	-
4	4.270	0.29	35.42	-	35.71	-	56.00	46.00	-20.29	-
5	5.143	0.31	33.38	-	33.69	-	60.00	50.00	-26.31	-
6	16.846	0.51	30.60	-	31.11	-	60.00	50.00	-28.89	-

- REMARKS:**
1. Q.P. and AV. are abbreviations of quasi-peak and average individually.
 2. "-": The Quasi-peak reading value also meets average limit and measurement with the average detector is unnecessary.
 3. The emission levels of other frequencies were very low against the limit.
 4. Margin value = Emission level - Limit value
 5. Correction factor = Insertion loss + Cable loss
 6. Emission Level = Correction Factor + Reading Value.

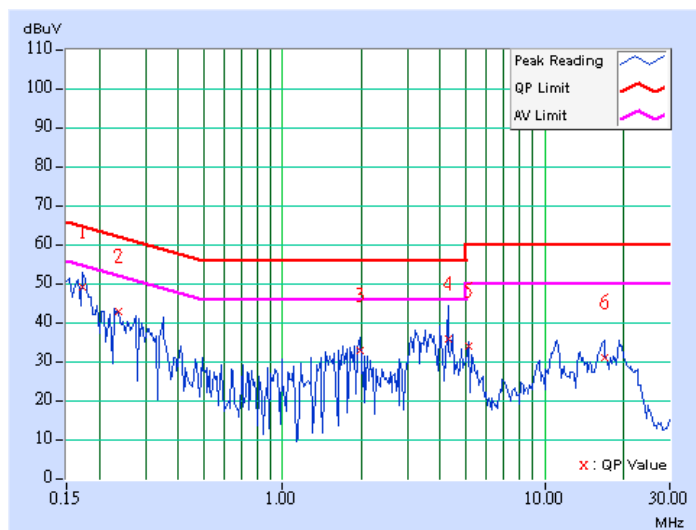

DRAFT 802.11n (40MHz) OFDM MODULATION

EUT TEST CONDITION		MEASUREMENT DETAIL	
CHANNEL	Channel 1	PHASE	Line 1
MODULATION TYPE	BPSK	6dB BANDWIDTH	9 kHz
TRANSFER RATE	15.0Mbps	INPUT POWER (SYSTEM)	120Vac, 60 Hz
ENVIRONMENTAL CONDITIONS	22deg. C, 60%RH, 991hPa	TESTED BY	Match Tsui

No	Freq. [MHz]	Corr. Factor (dB)	Reading Value		Emission Level		Limit		Margin	
			[dB (uV)]		[dB (uV)]		[dB (uV)]		(dB)	
			Q.P.	AV.	Q.P.	AV.	Q.P.	AV.	Q.P.	AV.
1	0.174	0.10	51.36	-	51.46	-	64.75	54.75	-13.29	-
2	0.222	0.10	42.54	-	42.64	-	62.76	52.76	-20.12	-
3	1.869	0.21	34.54	-	34.75	-	56.00	46.00	-21.25	-
4	3.276	0.26	35.63	-	35.89	-	56.00	46.00	-20.11	-
5	4.273	0.28	35.04	-	35.32	-	56.00	46.00	-20.68	-
6	19.134	0.55	30.34	-	30.89	-	60.00	50.00	-29.11	-

- REMARKS:**
1. Q.P. and AV. are abbreviations of quasi-peak and average individually.
 2. "-": The Quasi-peak reading value also meets average limit and measurement with the average detector is unnecessary.
 3. The emission levels of other frequencies were very low against the limit.
 4. Margin value = Emission level - Limit value
 5. Correction factor = Insertion loss + Cable loss
 6. Emission Level = Correction Factor + Reading Value.

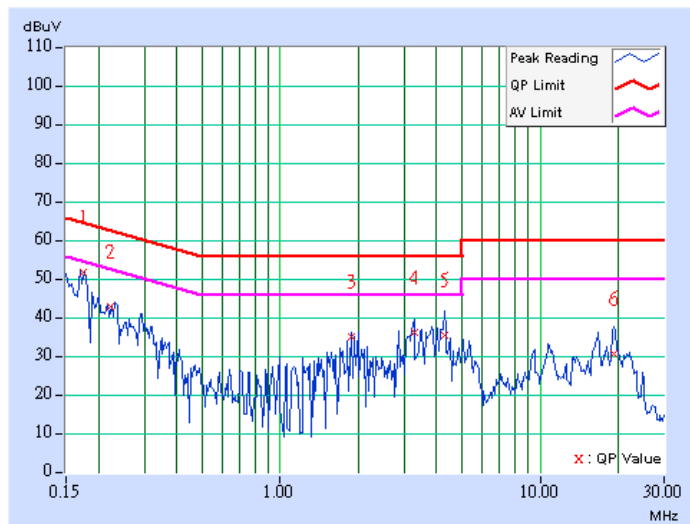

EUT TEST CONDITION		MEASUREMENT DETAIL	
CHANNEL	Channel 1	PHASE	Line 2
MODULATION TYPE	BPSK	6dB BANDWIDTH	9 kHz
TRANSFER RATE	15.0Mbps	INPUT POWER (SYSTEM)	120Vac, 60 Hz
ENVIRONMENTAL CONDITIONS	22deg. C, 60%RH, 991hPa	TESTED BY	Match Tsui

No	Freq. [MHz]	Corr. Factor (dB)	Reading Value		Emission Level		Limit		Margin	
			[dB (uV)]		[dB (uV)]		[dB (uV)]		(dB)	
			Q.P.	AV.	Q.P.	AV.	Q.P.	AV.	Q.P.	AV.
1	0.174	0.10	48.64	-	48.74	-	64.76	54.76	-16.02	-
2	0.225	0.10	42.60	-	42.70	-	62.65	52.65	-19.95	-
3	1.985	0.22	32.54	-	32.76	-	56.00	46.00	-23.24	-
4	4.255	0.29	36.08	-	36.37	-	56.00	46.00	-19.63	-
5	5.142	0.31	32.59	-	32.90	-	60.00	50.00	-27.10	-
6	16.848	0.51	30.69	-	31.20	-	60.00	50.00	-28.80	-

- REMARKS:**
1. Q.P. and AV. are abbreviations of quasi-peak and average individually.
 2. "-": The Quasi-peak reading value also meets average limit and measurement with the average detector is unnecessary.
 3. The emission levels of other frequencies were very low against the limit.
 4. Margin value = Emission level - Limit value
 5. Correction factor = Insertion loss + Cable loss
 6. Emission Level = Correction Factor + Reading Value.

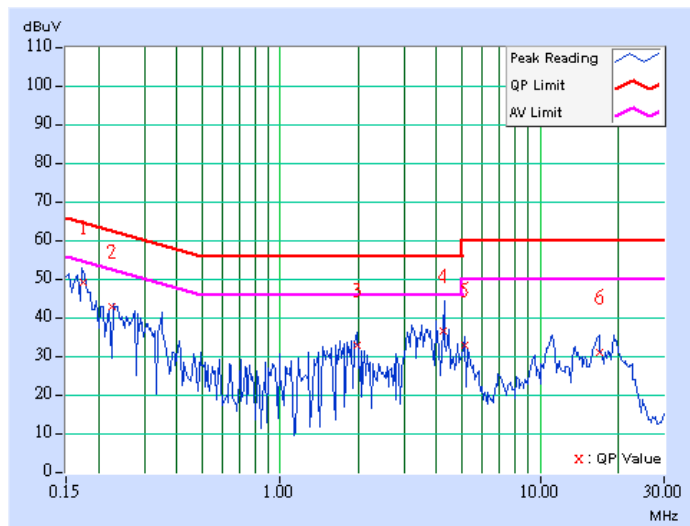

EUT TEST CONDITION		MEASUREMENT DETAIL	
CHANNEL	Channel 4	PHASE	Line 1
MODULATION TYPE	BPSK	6dB BANDWIDTH	9 kHz
TRANSFER RATE	15.0Mbps	INPUT POWER (SYSTEM)	120Vac, 60 Hz
ENVIRONMENTAL CONDITIONS	22deg. C, 60%RH, 991hPa	TESTED BY	Match Tsui

No	Freq.	Corr.	Reading Value		Emission Level		Limit		Margin	
		Factor	[dB (uV)]		[dB (uV)]		[dB (uV)]		(dB)	
	[MHz]	(dB)	Q.P.	AV.	Q.P.	AV.	Q.P.	AV.	Q.P.	AV.
1	0.173	0.10	50.54	-	50.64	-	64.80	54.80	-14.16	-
2	0.232	0.10	42.54	-	42.64	-	62.38	52.38	-19.74	-
3	1.870	0.21	32.40	-	32.61	-	56.00	46.00	-23.39	-
4	3.277	0.26	33.85	-	34.11	-	56.00	46.00	-21.89	-
5	4.273	0.28	33.60	-	33.88	-	56.00	46.00	-22.12	-
6	19.140	0.55	31.35	-	31.90	-	60.00	50.00	-28.10	-

- REMARKS:**
1. Q.P. and AV. are abbreviations of quasi-peak and average individually.
 2. "-": The Quasi-peak reading value also meets average limit and measurement with the average detector is unnecessary.
 3. The emission levels of other frequencies were very low against the limit.
 4. Margin value = Emission level - Limit value
 5. Correction factor = Insertion loss + Cable loss
 6. Emission Level = Correction Factor + Reading Value.

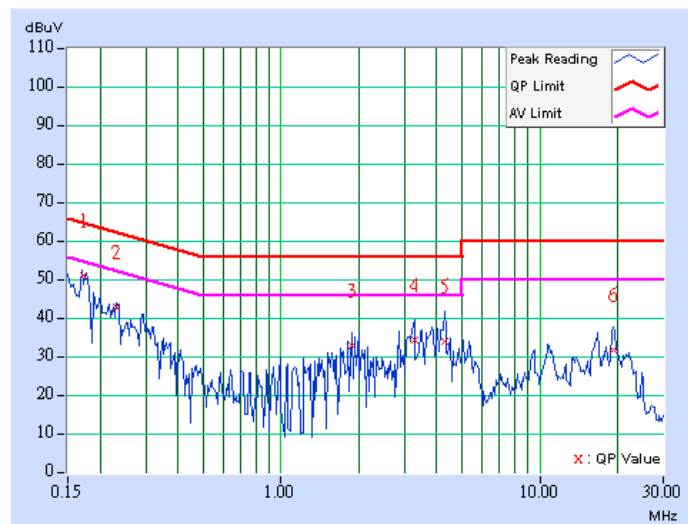

EUT TEST CONDITION		MEASUREMENT DETAIL	
CHANNEL	Channel 4	PHASE	Line 2
MODULATION TYPE	BPSK	6dB BANDWIDTH	9 kHz
TRANSFER RATE	15.0Mbps	INPUT POWER (SYSTEM)	120Vac, 60 Hz
ENVIRONMENTAL CONDITIONS	22deg. C, 60%RH, 991hPa	TESTED BY	Match Tsui

No	Freq.	Corr. Factor	Reading Value		Emission Level		Limit		Margin	
			[dB (uV)]		[dB (uV)]		[dB (uV)]		(dB)	
	[MHz]	(dB)	Q.P.	AV.	Q.P.	AV.	Q.P.	AV.	Q.P.	AV.
1	0.171	0.10	49.57	-	49.67	-	64.89	54.89	-15.22	-
2	0.234	0.10	43.22	-	43.32	-	62.30	52.30	-18.98	-
3	2.047	0.22	35.57	-	35.79	-	56.00	46.00	-20.21	-
4	3.513	0.27	35.98	-	36.25	-	56.00	46.00	-19.75	-
5	5.266	0.31	33.50	-	33.81	-	60.00	50.00	-26.19	-
6	17.250	0.52	30.32	-	30.84	-	60.00	50.00	-29.16	-

- REMARKS:**
1. Q.P. and AV. are abbreviations of quasi-peak and average individually.
 2. "-": The Quasi-peak reading value also meets average limit and measurement with the average detector is unnecessary.
 3. The emission levels of other frequencies were very low against the limit.
 4. Margin value = Emission level - Limit value
 5. Correction factor = Insertion loss + Cable loss
 6. Emission Level = Correction Factor + Reading Value.

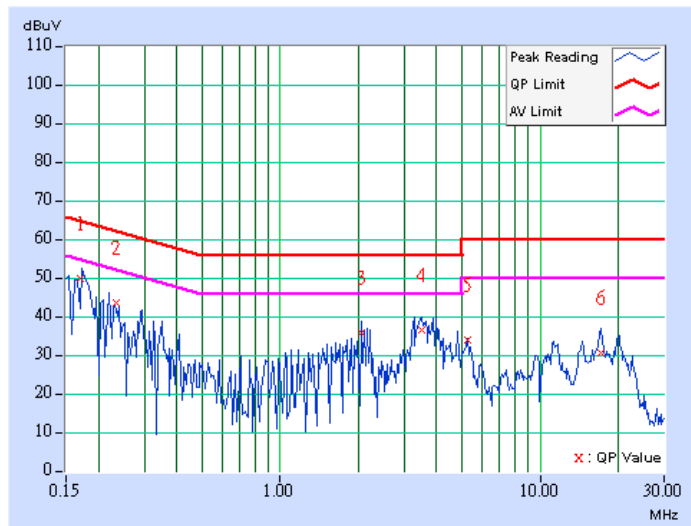

EUT TEST CONDITION		MEASUREMENT DETAIL	
CHANNEL	Channel 7	PHASE	Line 1
MODULATION TYPE	BPSK	6dB BANDWIDTH	9 kHz
TRANSFER RATE	15.0Mbps	INPUT POWER (SYSTEM)	120Vac, 60 Hz
ENVIRONMENTAL CONDITIONS	22deg. C, 60%RH, 991hPa	TESTED BY	Match Tsui

No	Freq.	Corr. Factor	Reading Value		Emission Level		Limit		Margin	
			[dB (uV)]		[dB (uV)]		[dB (uV)]		(dB)	
	[MHz]	(dB)	Q.P.	AV.	Q.P.	AV.	Q.P.	AV.	Q.P.	AV.
1	0.185	0.10	50.53	-	50.63	-	64.28	54.28	-13.65	-
2	0.234	0.10	42.57	-	42.67	-	62.30	52.30	-19.63	-
3	2.281	0.23	31.21	-	31.44	-	56.00	46.00	-24.56	-
4	3.635	0.27	36.93	-	37.20	-	56.00	46.00	-18.80	-
5	5.087	0.29	34.24	-	34.53	-	60.00	50.00	-25.47	-
6	17.253	0.52	30.05	-	30.57	-	60.00	50.00	-29.43	-

- REMARKS:**
1. Q.P. and AV. are abbreviations of quasi-peak and average individually.
 2. "-": The Quasi-peak reading value also meets average limit and measurement with the average detector is unnecessary.
 3. The emission levels of other frequencies were very low against the limit.
 4. Margin value = Emission level - Limit value
 5. Correction factor = Insertion loss + Cable loss
 6. Emission Level = Correction Factor + Reading Value.

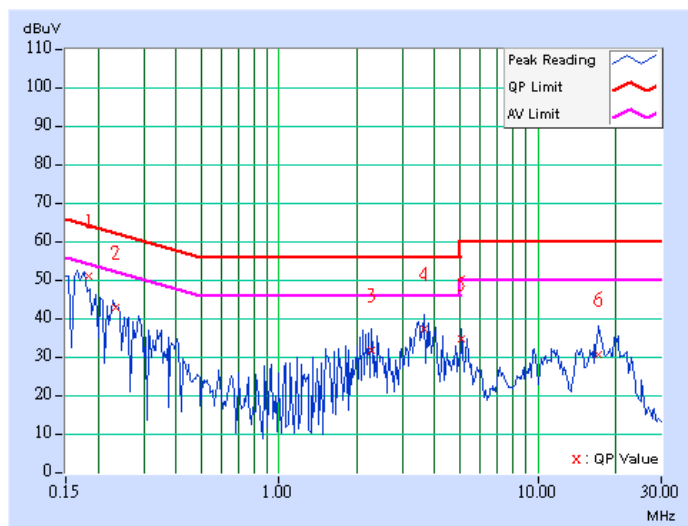

EUT TEST CONDITION		MEASUREMENT DETAIL	
CHANNEL	Channel 7	PHASE	Line 2
MODULATION TYPE	BPSK	6dB BANDWIDTH	9 kHz
TRANSFER RATE	15.0Mbps	INPUT POWER (SYSTEM)	120Vac, 60 Hz
ENVIRONMENTAL CONDITIONS	22deg. C, 60%RH, 991hPa	TESTED BY	Match Tsui

No	Freq.	Corr. Factor	Reading Value		Emission Level		Limit		Margin	
			[dB (uV)]		[dB (uV)]		[dB (uV)]		(dB)	
	[MHz]	(dB)	Q.P.	AV.	Q.P.	AV.	Q.P.	AV.	Q.P.	AV.
1	0.174	0.10	48.67	-	48.77	-	64.79	54.79	-16.02	-
2	0.235	0.10	42.60	-	42.70	-	62.29	52.29	-19.59	-
3	1.984	0.22	31.79	-	32.01	-	56.00	46.00	-23.99	-
4	4.270	0.29	36.52	-	36.81	-	56.00	46.00	-19.19	-
5	5.142	0.31	32.87	-	33.18	-	60.00	50.00	-26.82	-
6	16.849	0.51	30.16	-	30.67	-	60.00	50.00	-29.33	-

- REMARKS:**
1. Q.P. and AV. are abbreviations of quasi-peak and average individually.
 2. "-": The Quasi-peak reading value also meets average limit and measurement with the average detector is unnecessary.
 3. The emission levels of other frequencies were very low against the limit.
 4. Margin value = Emission level - Limit value
 5. Correction factor = Insertion loss + Cable loss
 6. Emission Level = Correction Factor + Reading Value.

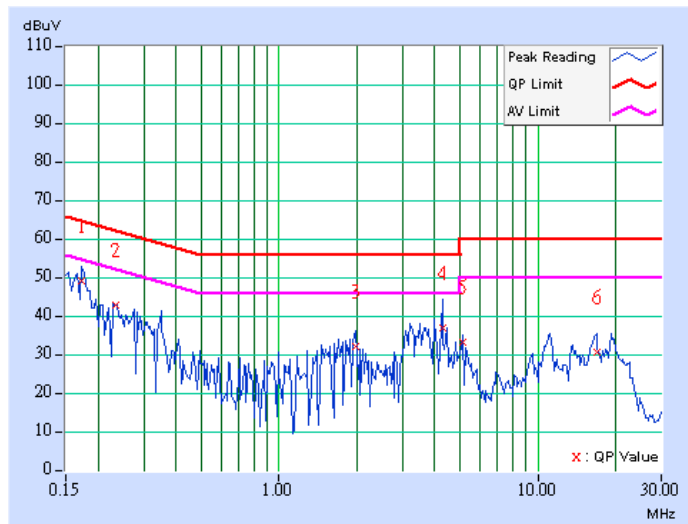

4.2 RADIATED EMISSION MEASUREMENT

4.2.1 LIMITS OF RADIATED EMISSION MEASUREMENT

Emissions radiated outside of the specified bands, shall be according to the general radiated limits in 15.209 as following:

FREQUENCIES (MHz)	FIELD STRENGTH (microvolts/meter)	MEASUREMENT DISTANCE (meters)
0.009 ~ 0.490	2400 / F(kHz)	300
0.490 ~ 1.705	24000 / F(kHz)	30
1.705 ~ 30.0	30	30
30 ~ 88	100	3
88 ~ 216	150	3
216 ~ 960	200	3
Above 960	500	3

NOTE:

1. The lower limit shall apply at the transition frequencies.
2. Emission level (dBuV/m) = 20 log Emission level (uV/m).
3. As shown in 15.35(b), for frequencies above 1000MHz, the field strength limits are based on average detector, however, the peak field strength of any emission shall not exceed the maximum permitted average limits, specified above by more than 20dB under any condition of modulation.

4.2.2 TEST INSTRUMENTS

DESCRIPTION & MANUFACTURER	MODEL NO.	SERIAL NO.	CALIBRATED UNTIL
Test Receiver ROHDE & SCHWARZ	ESI7	838496/016	Dec. 29, 2007
Spectrum Analyzer ROHDE & SCHWARZ	FSP40	100039	Dec. 01, 2007
BILOG Antenna SCHWARZBECK	VULB9168	9168-155	Jan. 04, 2008
HORN Antenna SCHWARZBECK	BBHA 9120D	9120D-405	Dec. 18, 2007
HORN Antenna SCHWARZBECK	BBHA 9170	BBHA9170242	Jan. 16, 2008
Preamplifier Agilent	8449B	3008A1960	Oct. 30, 2007
Preamplifier Agilent	8447D	2944A10631	Oct. 30, 2007
RF signal cable HUBER+SUHNNER	SUCOFLEX 104	230128/4	Nov. 14, 2007
RF signal cable HUBER+SUHNNER	SUCOFLEX 104	233233/4	Nov. 14, 2007
Software ADT.	ADT_Radiated_V7.6	NA	NA
Antenna Tower inn-co GmbH	MA 4000	010303	NA
Antenna Tower Controller inn-co GmbH	CO2000	019303	NA
Turn Table ADT.	TT100.	TT93021704	NA
Turn Table Controller ADT.	SC100.	SC93021704	NA

- NOTE:**
1. The calibration interval of the above test instruments is 12 months and the calibrations are traceable to NML/ROC and NIST/USA.
 2. The test was performed in HwaYa Chamber 4.
 3. The horn antenna and HP preamplifier (model: 8449B) are used only for the measurement of emission frequency above 1GHz if tested.
 4. The IC Site Registration No. is IC3789B-4.

4.2.3 TEST PROCEDURES

- a. The EUT was placed on the top of a rotating table 0.8 meters above the ground at a 3 meters semi-anechoic chamber. The table was rotated 360 degrees to determine the position of the highest radiation.
- b. The EUT was set 3 meters away from the interference-receiving antenna, which was mounted on the top of a variable-height antenna tower.
- c. The antenna is a broadband antenna, and its height is varied from one meter to four meters above the ground to determine the maximum value of the field strength. Both horizontal and vertical polarizations of the antenna are set to make the measurement.
- d. For each suspected emission, the EUT was arranged to its worst case and then the antenna was tuned to heights from 1 meter to 4 meters and the rotatable table was turned from 0 degrees to 360 degrees to find the maximum reading.
- e. The test-receiver system was set to Peak Detect Function and Specified Bandwidth with Maximum Hold Mode.
- f. If the emission level of the EUT in peak mode was lower than the limit specified, then testing could be stopped and the peak values of the EUT would be reported. Otherwise the emissions would be re-tested one by one using peak, quasi-peak or average method as specified and then reported in a data sheet.

NOTE:

1. The resolution bandwidth and video bandwidth of test receiver/spectrum analyzer is 120kHz for Peak detection (PK) and Quasi-peak detection (QP) at frequency below 1GHz.
2. The resolution bandwidth of test receiver/spectrum analyzer is 1 MHz and video bandwidth is 3MHz for Peak detection at frequency above 1GHz.
3. The resolution bandwidth of test receiver/spectrum analyzer is 1MHz and the video bandwidth is 10Hz for Average detection (AV) at frequency above 1GHz.

4.2.4 DEVIATION FROM TEST STANDARD

No deviation

4.2.5 TEST SETUP

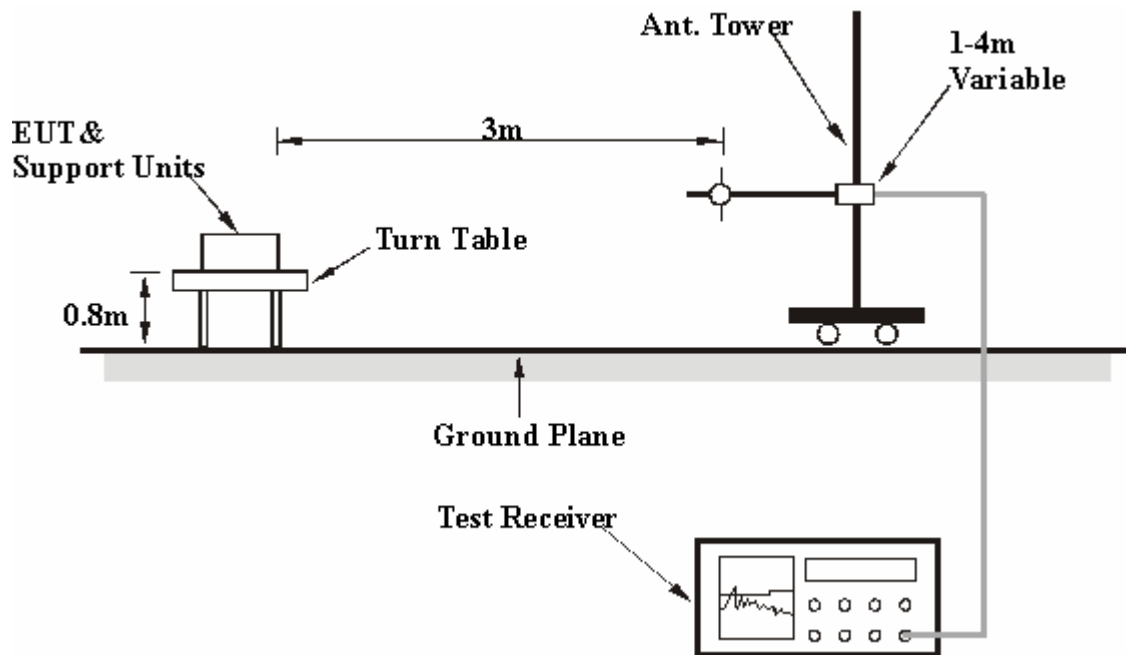

For the actual test configuration, please refer to the attached file (Test Setup Photo)

4.2.6 EUT OPERATING CONDITIONS

- a. Connected the EUT to notebook (via USB cable with cradle) and placed on a testing table.
- b. The notebook ran a test program (provided by manufacturer) to enable EUT under transmission condition continuously at specific channel frequency.
- c. The necessary accessories enable the system in full functions.



4.2.7 TEST RESULTS

BELOW 1GHz TEST DATA_802.11g OFDM MODULATION FOR TEST MODE A (WITH CRADLE)

EUT TEST CONDITION		MEASUREMENT DETAIL	
CHANNEL	Channel 1	FREQUENCY RANGE	Below 1000MHz
MODULATION TYPE	BPSK for 802.11g	INPUT POWER (SYSTEM)	120Vac, 60 Hz
TRANSFER RATE	6.0Mbps	DETECTOR FUNCTION	Quasi-Peak
ENVIRONMENTAL CONDITIONS	25deg. C, 69%RH, 991hPa	TESTED BY	Brad Wu

ANTENNA POLARITY & TEST DISTANCE: HORIZONTAL AT 3 M								
No.	Freq. (MHz)	Emission Level (dBuV/m)	Limit (dBuV/m)	Margin (dB)	Antenna Height (m)	Table Angle (Degree)	Raw Value (dBuV)	Correction Factor (dB/m)
1	152.39	35.25 QP	43.50	-8.25	1.50 H	136	21.63	13.62
2	360.43	30.44 QP	46.00	-15.56	1.00 H	97	15.64	14.80
3	467.36	31.02 QP	46.00	-14.98	1.50 H	184	13.27	17.75
4	663.74	32.93 QP	46.00	-13.07	1.00 H	172	11.26	21.67
5	867.89	32.60 QP	46.00	-13.40	1.25 H	154	7.58	25.01
6	960.00	34.98 QP	46.00	-11.02	1.00 H	223	9.21	25.76

ANTENNA POLARITY & TEST DISTANCE: VERTICAL AT 3 M								
No.	Freq. (MHz)	Emission Level (dBuV/m)	Limit (dBuV/m)	Margin (dB)	Antenna Height (m)	Table Angle (Degree)	Raw Value (dBuV)	Correction Factor (dB/m)
1	142.67	37.64 QP	43.50	-5.86	1.00 V	241	24.97	12.67
2	348.76	29.27 QP	46.00	-16.73	1.25 V	220	14.74	14.53
3	467.36	28.74 QP	46.00	-17.26	1.25 V	292	11.00	17.75
4	661.79	30.76 QP	46.00	-15.24	1.25 V	184	9.11	21.65
5	731.79	32.66 QP	46.00	-13.34	1.50 V	193	9.90	22.76
6	865.94	31.26 QP	46.00	-14.74	1.00 V	256	6.27	25.00

- REMARKS:**
1. Emission level(dBuV/m)=Raw Value(dBuV) + Correction Factor(dB/m)
 2. Correction Factor(dB/m) = Antenna Factor (dB/m) + Cable Factor (dB)
 3. The other emission levels were very low against the limit.
 4. Margin value = Emission level – Limit value.

FOR TEST MODE B (WITHOUT CRADLE)

EUT TEST CONDITION		MEASUREMENT DETAIL	
CHANNEL	Channel 1	FREQUENCY RANGE	Below 1000MHz
MODULATION TYPE	BPSK for 802.11g	INPUT POWER (SYSTEM)	120Vac, 60 Hz
TRANSFER RATE	6.0Mbps	DETECTOR FUNCTION	Quasi-Peak
ENVIRONMENTAL CONDITIONS	25deg. C, 69%RH, 991hPa	TESTED BY	Brad Wu

ANTENNA POLARITY & TEST DISTANCE: HORIZONTAL AT 3 M

No.	Freq. (MHz)	Emission Level (dBuV/m)	Limit (dBuV/m)	Margin (dB)	Antenna Height (m)	Table Angle (Degree)	Raw Value (dBuV)	Correction Factor (dB/m)
1	109.62	28.42 QP	43.50	-15.08	1.50 H	142	18.11	10.31
2	232.11	24.50 QP	46.00	-21.50	1.50 H	235	12.74	11.75
3	463.48	27.65 QP	46.00	-18.35	1.50 H	289	10.02	17.63
4	663.74	30.31 QP	46.00	-15.69	1.00 H	223	8.64	21.67
5	731.79	33.07 QP	46.00	-12.93	1.00 H	163	10.32	22.76
6	865.94	31.07 QP	46.00	-14.93	1.00 H	10	6.07	25.00

ANTENNA POLARITY & TEST DISTANCE: VERTICAL AT 3 M

No.	Freq. (MHz)	Emission Level (dBuV/m)	Limit (dBuV/m)	Margin (dB)	Antenna Height (m)	Table Angle (Degree)	Raw Value (dBuV)	Correction Factor (dB/m)
1	125.17	31.53 QP	43.50	-11.97	1.00 V	178	19.77	11.76
2	430.42	27.49 QP	46.00	-18.51	1.00 V	226	10.87	16.62
3	465.42	27.07 QP	46.00	-18.93	1.00 V	286	9.38	17.69
4	727.90	31.78 QP	46.00	-14.22	1.50 V	109	9.12	22.66
5	864.00	35.23 QP	46.00	-10.77	1.50 V	334	10.25	24.98
6	945.66	38.72 QP	46.00	-7.28	1.00 V	208	13.03	25.69

- REMARKS:**
1. Emission level(dBuV/m)=Raw Value(dBuV) + Correction Factor(dB/m)
 2. Correction Factor(dB/m) = Antenna Factor (dB/m) + Cable Factor (dB)
 3. The other emission levels were very low against the limit.
 4. Margin value = Emission level – Limit value.



**ABOVE 1GHz WORST-CASE DATA
802.11b DSSS MODULATION**

EUT TEST CONDITION		MEASUREMENT DETAIL	
CHANNEL	Channel 1	FREQUENCY RANGE	1 ~ 25GHz
MODULATION TYPE	DBPSK	INPUT POWER (SYSTEM)	120Vac, 60 Hz
TRANSFER RATE	1.0Mbps	DETECTOR FUNCTION	Peak(PK) Average (AV)
ENVIRONMENTAL CONDITIONS	25deg. C, 65%RH, 991hPa	TESTED BY	Brad Wu

ANTENNA POLARITY & TEST DISTANCE: HORIZONTAL AT 3 M								
No.	Freq. (MHz)	Emission Level (dBuV/m)	Limit (dBuV/m)	Margin (dB)	Antenna Height (m)	Table Angle (Degree)	Raw Value (dBuV)	Correction Factor (dB/m)
1	2390.00	56.95 PK	74.00	-17.05	1.49 H	44	24.72	32.23
2	2390.00	45.27 AV	54.00	-8.73	1.49 H	44	13.04	32.23
3	*2412.00	94.06 PK			1.49 H	44	61.74	32.32
4	*2412.00	89.73 AV			1.49 H	44	57.41	32.32
5	4824.00	48.35 PK	74.00	-25.65	1.08 H	2	9.86	38.49
6	4824.00	36.30 AV	54.00	-17.70	1.08 H	2	-2.19	38.49

ANTENNA POLARITY & TEST DISTANCE: VERTICAL AT 3 M								
No.	Freq. (MHz)	Emission Level (dBuV/m)	Limit (dBuV/m)	Margin (dB)	Antenna Height (m)	Table Angle (Degree)	Raw Value (dBuV)	Correction Factor (dB/m)
1	2390.00	57.07 PK	74.00	-16.93	1.37 V	248	24.84	32.23
2	2390.00	45.38 AV	54.00	-8.62	1.37 V	248	13.15	32.23
3	*2412.00	97.37 PK			1.37 V	248	65.05	32.32
4	*2412.00	92.81 AV			1.37 V	248	60.49	32.32
5	4824.00	48.65 PK	74.00	-25.35	1.01 V	7	10.16	38.49
6	4824.00	36.79 AV	54.00	-17.21	1.01 V	7	-1.70	38.49

- REMARKS:**
1. Emission level (dBuV/m) = Raw Value (dBuV) + Correction Factor (dB/m).
 2. Correction Factor (dB/m) = Antenna Factor (dB/m) + Cable Factor (dB).
 3. The other emission levels were very low against the limit.
 4. Margin value = Emission level – Limit value.
 5. The limit value is defined as per 15.247.
 6. “ * “: Fundamental frequency.

EUT TEST CONDITION		MEASUREMENT DETAIL	
CHANNEL	Channel 6	FREQUENCY RANGE	1 ~ 25GHz
MODULATION TYPE	DBPSK	INPUT POWER (SYSTEM)	120Vac, 60 Hz
TRANSFER RATE	1.0Mbps	DETECTOR FUNCTION	Peak(PK) Average (AV)
ENVIRONMENTAL CONDITIONS	25deg. C, 65%RH, 991hPa	TESTED BY	Brad Wu

ANTENNA POLARITY & TEST DISTANCE: HORIZONTAL AT 3 M								
No.	Freq. (MHz)	Emission Level (dBuV/m)	Limit (dBuV/m)	Margin (dB)	Antenna Height (m)	Table Angle (Degree)	Raw Value (dBuV)	Correction Factor (dB/m)
1	*2437.00	95.48 PK			1.49 H	27	63.07	32.41
2	*2437.00	90.92 AV			1.49 H	27	58.51	32.41
3	4874.00	47.05 PK	74.00	-26.95	1.01 H	250	8.36	38.69
4	4874.00	35.14 AV	54.00	-18.86	1.01 H	250	-3.55	38.69

ANTENNA POLARITY & TEST DISTANCE: VERTICAL AT 3 M								
No.	Freq. (MHz)	Emission Level (dBuV/m)	Limit (dBuV/m)	Margin (dB)	Antenna Height (m)	Table Angle (Degree)	Raw Value (dBuV)	Correction Factor (dB/m)
1	*2437.00	96.91 PK			1.32 V	248	64.50	32.41
2	*2437.00	92.45 AV			1.32 V	248	60.04	32.41
3	4874.00	49.27 PK	74.00	-24.73	1.01 V	8	10.58	38.69
4	4874.00	36.76 AV	54.00	-17.24	1.01 V	8	-1.93	38.69

- REMARKS:**
1. Emission level (dBuV/m) = Raw Value (dBuV) + Correction Factor (dB/m).
 2. Correction Factor (dB/m) = Antenna Factor (dB/m) + Cable Factor (dB).
 3. The other emission levels were very low against the limit.
 4. Margin value = Emission level – Limit value.
 5. The limit value is defined as per 15.247.
 6. “ * “: Fundamental frequency.

EUT TEST CONDITION		MEASUREMENT DETAIL	
CHANNEL	Channel 11	FREQUENCY RANGE	1 ~ 25GHz
MODULATION TYPE	DBPSK	INPUT POWER (SYSTEM)	120Vac, 60 Hz
TRANSFER RATE	1.0Mbps	DETECTOR FUNCTION	Peak(PK) Average (AV)
ENVIRONMENTAL CONDITIONS	25deg. C, 65%RH, 991hPa	TESTED BY	Brad Wu

ANTENNA POLARITY & TEST DISTANCE: HORIZONTAL AT 3 M								
No.	Freq. (MHz)	Emission Level (dBuV/m)	Limit (dBuV/m)	Margin (dB)	Antenna Height (m)	Table Angle (Degree)	Raw Value (dBuV)	Correction Factor (dB/m)
1	*2462.00	95.52 PK			1.48 H	28	63.01	32.51
2	*2462.00	91.02 AV			1.48 H	28	58.51	32.51
3	2483.50	58.04 PK	74.00	-15.96	1.48 H	28	25.45	32.59
4	2483.50	45.76 AV	54.00	-8.24	1.48 H	28	13.17	32.59
5	4924.00	47.11 PK	74.00	-26.89	1.08 H	234	8.26	38.85
6	4924.00	35.20 AV	54.00	-18.80	1.08 H	234	-3.65	38.85

ANTENNA POLARITY & TEST DISTANCE: VERTICAL AT 3 M								
No.	Freq. (MHz)	Emission Level (dBuV/m)	Limit (dBuV/m)	Margin (dB)	Antenna Height (m)	Table Angle (Degree)	Raw Value (dBuV)	Correction Factor (dB/m)
1	*2462.00	97.35 PK			1.34 V	250	64.84	32.51
2	*2462.00	92.84 AV			1.34 V	250	60.33	32.51
3	2483.50	58.80 PK	74.00	-15.20	1.34 V	250	26.21	32.59
4	2483.50	46.39 AV	54.00	-7.61	1.34 V	250	13.80	32.59
5	4924.00	48.95 PK	74.00	-25.05	1.01 V	28	10.10	38.85
6	4924.00	36.31 AV	54.00	-17.69	1.01 V	28	-2.54	38.85

- REMARKS:**
1. Emission level (dBuV/m) = Raw Value (dBuV) + Correction Factor (dB/m).
 2. Correction Factor (dB/m) = Antenna Factor (dB/m) + Cable Factor (dB).
 3. The other emission levels were very low against the limit.
 4. Margin value = Emission level – Limit value.
 5. The limit value is defined as per 15.247.
 6. “ * “: Fundamental frequency.

802.11g OFDM MODULATION

EUT TEST CONDITION		MEASUREMENT DETAIL	
CHANNEL	Channel 1	FREQUENCY RANGE	1 ~ 25GHz
MODULATION TYPE	BPSK	INPUT POWER (SYSTEM)	120Vac, 60 Hz
TRANSFER RATE	6.0Mbps	DETECTOR FUNCTION	Peak(PK) Average (AV)
ENVIRONMENTAL CONDITIONS	25deg. C, 65%RH, 991hPa	TESTED BY	Brad Wu

ANTENNA POLARITY & TEST DISTANCE: HORIZONTAL AT 3 M								
No.	Freq. (MHz)	Emission Level (dBuV/m)	Limit (dBuV/m)	Margin (dB)	Antenna Height (m)	Table Angle (Degree)	Raw Value (dBuV)	Correction Factor (dB/m)
1	2390.00	56.58 PK	74.00	-17.42	1.49 H	9	24.35	32.23
2	2390.00	45.10 AV	54.00	-8.90	1.49 H	9	12.87	32.23
3	*2412.00	94.67 PK			1.50 H	9	62.35	32.32
4	*2412.00	84.93 AV			1.50 H	9	52.61	32.32
5	4824.00	48.12 PK	74.00	-25.88	1.02 H	341	9.63	38.49
6	4824.00	34.51 AV	54.00	-19.49	1.02 H	341	-3.98	38.49

ANTENNA POLARITY & TEST DISTANCE: VERTICAL AT 3 M								
No.	Freq. (MHz)	Emission Level (dBuV/m)	Limit (dBuV/m)	Margin (dB)	Antenna Height (m)	Table Angle (Degree)	Raw Value (dBuV)	Correction Factor (dB/m)
1	2390.00	56.74 PK	74.00	-17.26	1.42 V	284	24.51	32.23
2	2390.00	45.19 AV	54.00	-8.81	1.42 V	284	12.96	32.23
3	*2412.00	96.49 PK			1.42 V	284	64.17	32.32
4	*2412.00	86.54 AV			1.42 V	284	54.22	32.32
5	4824.00	48.56 PK	74.00	-25.44	1.10 V	76	10.07	38.49
6	4824.00	34.92 AV	54.00	-19.08	1.10 V	76	-3.57	38.49

- REMARKS:**
1. Emission level (dBuV/m) = Raw Value (dBuV) + Correction Factor (dB/m).
 2. Correction Factor (dB/m) = Antenna Factor (dB/m) + Cable Factor (dB).
 3. The other emission levels were very low against the limit.
 4. Margin value = Emission level – Limit value.
 5. The limit value is defined as per 15.247.
 6. “ * “: Fundamental frequency.



EUT TEST CONDITION		MEASUREMENT DETAIL	
CHANNEL	Channel 6	FREQUENCY RANGE	1 ~ 25GHz
MODULATION TYPE	BPSK	INPUT POWER (SYSTEM)	120Vac, 60 Hz
TRANSFER RATE	6.0Mbps	DETECTOR FUNCTION	Peak(PK) Average (AV)
ENVIRONMENTAL CONDITIONS	25deg. C, 65%RH, 991hPa	TESTED BY	Brad Wu

ANTENNA POLARITY & TEST DISTANCE: HORIZONTAL AT 3 M								
No.	Freq. (MHz)	Emission Level (dBuV/m)	Limit (dBuV/m)	Margin (dB)	Antenna Height (m)	Table Angle (Degree)	Raw Value (dBuV)	Correction Factor (dB/m)
1	*2437.00	94.38 PK			1.48 H	11	61.97	32.41
2	*2437.00	84.61 AV			1.48 H	11	52.20	32.41
3	4874.00	48.25 PK	74.00	-25.75	1.21 H	326	9.56	38.69
4	4874.00	34.66 AV	54.00	-19.34	1.21 H	326	-4.03	38.69

ANTENNA POLARITY & TEST DISTANCE: VERTICAL AT 3 M								
No.	Freq. (MHz)	Emission Level (dBuV/m)	Limit (dBuV/m)	Margin (dB)	Antenna Height (m)	Table Angle (Degree)	Raw Value (dBuV)	Correction Factor (dB/m)
1	*2437.00	96.24 PK			1.10 V	284	63.83	32.41
2	*2437.00	86.21 AV			1.10 V	284	53.80	32.41
3	4874.00	48.86 PK	74.00	-25.14	1.19 V	204	10.17	38.69
4	4874.00	35.20 AV	54.00	-18.80	1.19 V	204	-3.49	38.69

- REMARKS:**
1. Emission level (dBuV/m) = Raw Value (dBuV) + Correction Factor (dB/m).
 2. Correction Factor (dB/m) = Antenna Factor (dB/m) + Cable Factor (dB).
 3. The other emission levels were very low against the limit.
 4. Margin value = Emission level – Limit value.
 5. The limit value is defined as per 15.247.
 6. “ * “: Fundamental frequency.

EUT TEST CONDITION		MEASUREMENT DETAIL	
CHANNEL	Channel 11	FREQUENCY RANGE	1 ~ 25GHz
MODULATION TYPE	BPSK	INPUT POWER (SYSTEM)	120Vac, 60 Hz
TRANSFER RATE	6.0Mbps	DETECTOR FUNCTION	Peak(PK) Average (AV)
ENVIRONMENTAL CONDITIONS	25deg. C, 65%RH, 991hPa	TESTED BY	Brad Wu

ANTENNA POLARITY & TEST DISTANCE: HORIZONTAL AT 3 M								
No.	Freq. (MHz)	Emission Level (dBuV/m)	Limit (dBuV/m)	Margin (dB)	Antenna Height (m)	Table Angle (Degree)	Raw Value (dBuV)	Correction Factor (dB/m)
1	*2462.00	94.85 PK			1.49 H	13	62.34	32.51
2	*2462.00	85.01 AV			1.49 H	13	52.50	32.51
3	2483.50	57.02 PK	74.00	-16.98	1.12 H	247	24.43	32.59
4	2483.50	46.13 AV	54.00	-7.87	1.12 H	247	13.54	32.59
5	4924.00	48.68 PK	74.00	-25.32	1.11 H	304	9.83	38.85
6	4924.00	35.04 AV	54.00	-18.96	1.11 H	304	-3.81	38.85

ANTENNA POLARITY & TEST DISTANCE: VERTICAL AT 3 M								
No.	Freq. (MHz)	Emission Level (dBuV/m)	Limit (dBuV/m)	Margin (dB)	Antenna Height (m)	Table Angle (Degree)	Raw Value (dBuV)	Correction Factor (dB/m)
1	*2462.00	97.10 PK			1.08 V	286	64.59	32.51
2	*2462.00	86.91 AV			1.08 V	286	54.40	32.51
3	2483.50	57.18 PK	74.00	-16.82	1.08 V	286	24.59	32.59
4	2483.50	46.30 AV	54.00	-7.70	1.08 V	286	13.71	32.59
5	4924.00	48.95 PK	74.00	-25.05	1.12 V	48	10.10	38.85
6	4924.00	35.31 AV	54.00	-18.69	1.12 V	48	-3.54	38.85

- REMARKS:**
1. Emission level (dBuV/m) = Raw Value (dBuV) + Correction Factor (dB/m).
 2. Correction Factor (dB/m) = Antenna Factor (dB/m) + Cable Factor (dB).
 3. The other emission levels were very low against the limit.
 4. Margin value = Emission level – Limit value.
 5. The limit value is defined as per 15.247.
 6. “ * “: Fundamental frequency.



DRAFT 802.11n (20MHz) OFDM MODULATION

EUT TEST CONDITION		MEASUREMENT DETAIL	
CHANNEL	Channel 1	FREQUENCY RANGE	1 ~ 25GHz
MODULATION TYPE	BPSK	INPUT POWER (SYSTEM)	120Vac, 60 Hz
TRANSFER RATE	7.2Mbps	DETECTOR FUNCTION	Peak(PK) Average (AV)
ENVIRONMENTAL CONDITIONS	25deg. C, 65%RH, 991hPa	TESTED BY	Brad Wu

ANTENNA POLARITY & TEST DISTANCE: HORIZONTAL AT 3 M								
No.	Freq. (MHz)	Emission Level (dBuV/m)	Limit (dBuV/m)	Margin (dB)	Antenna Height (m)	Table Angle (Degree)	Raw Value (dBuV)	Correction Factor (dB/m)
1	2390.00	56.03 PK	74.00	-17.97	1.26 H	182	23.80	32.23
2	2390.00	45.23 AV	54.00	-8.77	1.26 H	182	13.00	32.23
3	*2412.00	95.13 PK			1.26 H	182	62.81	32.32
4	*2412.00	85.14 AV			1.26 H	182	52.82	32.32
5	4824.00	48.24 PK	74.00	-25.76	1.02 H	323	9.75	38.49
6	4824.00	34.61 AV	54.00	-19.39	1.02 H	323	-3.88	38.49

ANTENNA POLARITY & TEST DISTANCE: VERTICAL AT 3 M								
No.	Freq. (MHz)	Emission Level (dBuV/m)	Limit (dBuV/m)	Margin (dB)	Antenna Height (m)	Table Angle (Degree)	Raw Value (dBuV)	Correction Factor (dB/m)
1	2390.00	56.07 PK	74.00	-17.93	1.40 V	343	23.84	32.23
2	2390.00	45.17 AV	54.00	-8.83	1.40 V	343	12.94	32.23
3	*2412.00	96.85 PK			1.40 V	343	64.53	32.32
4	*2412.00	87.44 AV			1.40 V	343	55.12	32.32
5	4824.00	49.21 PK	74.00	-24.79	1.13 V	214	10.72	38.49
6	4824.00	35.69 AV	54.00	-18.31	1.13 V	214	-2.80	38.49

- REMARKS:**
1. Emission level (dBuV/m) = Raw Value (dBuV) + Correction Factor (dB/m).
 2. Correction Factor (dB/m) = Antenna Factor (dB/m) + Cable Factor (dB).
 3. The other emission levels were very low against the limit.
 4. Margin value = Emission level – Limit value.
 5. The limit value is defined as per 15.247.
 6. “ * “: Fundamental frequency.



EUT TEST CONDITION		MEASUREMENT DETAIL	
CHANNEL	Channel 6	FREQUENCY RANGE	1 ~ 25GHz
MODULATION TYPE	BPSK	INPUT POWER (SYSTEM)	120Vac, 60 Hz
TRANSFER RATE	7.2Mbps	DETECTOR FUNCTION	Peak(PK) Average (AV)
ENVIRONMENTAL CONDITIONS	25deg. C, 65%RH, 991hPa	TESTED BY	Brad Wu

ANTENNA POLARITY & TEST DISTANCE: HORIZONTAL AT 3 M								
No.	Freq. (MHz)	Emission Level (dBuV/m)	Limit (dBuV/m)	Margin (dB)	Antenna Height (m)	Table Angle (Degree)	Raw Value (dBuV)	Correction Factor (dB/m)
1	*2437.00	95.01 PK			1.25 H	181	62.60	32.41
2	*2437.00	85.03 AV			1.25 H	181	52.62	32.41
3	4874.00	49.25 PK	74.00	-24.75	1.13 H	104	10.56	38.69
4	4874.00	35.68 AV	54.00	-18.32	1.13 H	104	-3.01	38.69

ANTENNA POLARITY & TEST DISTANCE: VERTICAL AT 3 M								
No.	Freq. (MHz)	Emission Level (dBuV/m)	Limit (dBuV/m)	Margin (dB)	Antenna Height (m)	Table Angle (Degree)	Raw Value (dBuV)	Correction Factor (dB/m)
1	*2437.00	96.60 PK			1.41 V	345	64.19	32.41
2	*2437.00	87.21 AV			1.41 V	345	54.80	32.41
3	4874.00	49.38 PK	74.00	-24.62	1.14 V	219	10.69	38.69
4	4874.00	35.82 AV	54.00	-18.18	1.14 V	219	-2.87	38.69

- REMARKS:**
1. Emission level (dBuV/m) = Raw Value (dBuV) + Correction Factor (dB/m).
 2. Correction Factor (dB/m) = Antenna Factor (dB/m) + Cable Factor (dB).
 3. The other emission levels were very low against the limit.
 4. Margin value = Emission level – Limit value.
 5. The limit value is defined as per 15.247.
 6. “ * “: Fundamental frequency.

EUT TEST CONDITION		MEASUREMENT DETAIL	
CHANNEL	Channel 11	FREQUENCY RANGE	1 ~ 25GHz
MODULATION TYPE	BPSK	INPUT POWER (SYSTEM)	120Vac, 60 Hz
TRANSFER RATE	7.2Mbps	DETECTOR FUNCTION	Peak(PK) Average (AV)
ENVIRONMENTAL CONDITIONS	25deg. C, 65%RH, 991hPa	TESTED BY	Brad Wu

ANTENNA POLARITY & TEST DISTANCE: HORIZONTAL AT 3 M								
No.	Freq. (MHz)	Emission Level (dBuV/m)	Limit (dBuV/m)	Margin (dB)	Antenna Height (m)	Table Angle (Degree)	Raw Value (dBuV)	Correction Factor (dB/m)
1	*2462.00	94.88 PK			1.25 H	184	62.37	32.51
2	*2462.00	84.92 AV			1.25 H	184	52.41	32.51
3	2483.50	56.50 PK	74.00	-17.50	1.25 H	184	23.91	32.59
4	2483.50	46.15 AV	54.00	-7.85	1.25 H	184	13.56	32.59
5	4924.00	49.11 PK	74.00	-24.89	1.02 H	58	10.26	38.85
6	4924.00	35.60 AV	54.00	-18.40	1.02 H	58	-3.25	38.85

ANTENNA POLARITY & TEST DISTANCE: VERTICAL AT 3 M								
No.	Freq. (MHz)	Emission Level (dBuV/m)	Limit (dBuV/m)	Margin (dB)	Antenna Height (m)	Table Angle (Degree)	Raw Value (dBuV)	Correction Factor (dB/m)
1	*2462.00	96.45 PK			1.40 V	351	63.94	32.51
2	*2462.00	87.03 AV			1.40 V	351	54.52	32.51
3	2483.50	56.73 PK	74.00	-17.27	1.40 V	351	24.14	32.59
4	2483.50	46.39 AV	54.00	-7.61	1.40 V	351	13.80	32.59
5	4924.00	49.36 PK	74.00	-24.64	1.05 V	321	10.51	38.85
6	4924.00	35.84 AV	54.00	-18.16	1.05 V	321	-3.01	38.85

- REMARKS:**
1. Emission level (dBuV/m) = Raw Value (dBuV) + Correction Factor (dB/m).
 2. Correction Factor (dB/m) = Antenna Factor (dB/m) + Cable Factor (dB).
 3. The other emission levels were very low against the limit.
 4. Margin value = Emission level – Limit value.
 5. The limit value is defined as per 15.247.
 6. “ * “: Fundamental frequency.



DRAFT 802.11n (40MHz) OFDM MODULATION

EUT TEST CONDITION		MEASUREMENT DETAIL	
CHANNEL	Channel 1	FREQUENCY RANGE	1 ~ 25GHz
MODULATION TYPE	BPSK	INPUT POWER (SYSTEM)	120Vac, 60 Hz
TRANSFER RATE	15.0Mbps	DETECTOR FUNCTION	Peak(PK) Average (AV)
ENVIRONMENTAL CONDITIONS	25deg. C, 65%RH, 991hPa	TESTED BY	Brad Wu

ANTENNA POLARITY & TEST DISTANCE: HORIZONTAL AT 3 M								
No.	Freq. (MHz)	Emission Level (dBuV/m)	Limit (dBuV/m)	Margin (dB)	Antenna Height (m)	Table Angle (Degree)	Raw Value (dBuV)	Correction Factor (dB/m)
1	2390.00	57.55 PK	74.00	-16.45	1.50 H	190	25.32	32.23
2	2390.00	45.09 AV	54.00	-8.91	1.50 H	190	12.86	32.23
3	*2422.00	94.13 PK			1.50 H	190	61.78	32.35
4	*2422.00	83.68 AV			1.50 H	190	51.33	32.35
5	4844.00	47.76 PK	74.00	-26.24	1.01 H	103	9.19	38.57
6	4844.00	35.08 AV	54.00	-18.92	1.01 H	103	-3.49	38.57

ANTENNA POLARITY & TEST DISTANCE: VERTICAL AT 3 M								
No.	Freq. (MHz)	Emission Level (dBuV/m)	Limit (dBuV/m)	Margin (dB)	Antenna Height (m)	Table Angle (Degree)	Raw Value (dBuV)	Correction Factor (dB/m)
1	2390.00	57.69 PK	74.00	-16.31	1.14 V	13	25.46	32.23
2	2390.00	45.29 AV	54.00	-8.71	1.14 V	13	13.06	32.23
3	*2422.00	95.03 PK			1.14 V	13	62.68	32.35
4	*2422.00	84.60 AV			1.14 V	13	52.25	32.35
5	4844.00	48.93 PK	74.00	-25.07	1.01 V	189	10.36	38.57
6	4844.00	36.31 AV	54.00	-17.69	1.01 V	189	-2.26	38.57

- REMARKS:**
1. Emission level (dBuV/m) = Raw Value (dBuV) + Correction Factor (dB/m).
 2. Correction Factor (dB/m) = Antenna Factor (dB/m) + Cable Factor (dB).
 3. The other emission levels were very low against the limit.
 4. Margin value = Emission level – Limit value.
 5. The limit value is defined as per 15.247.
 6. “ * “: Fundamental frequency.

EUT TEST CONDITION		MEASUREMENT DETAIL	
CHANNEL	Channel 4	FREQUENCY RANGE	1 ~ 25GHz
MODULATION TYPE	BPSK	INPUT POWER (SYSTEM)	120Vac, 60 Hz
TRANSFER RATE	15.0Mbps	DETECTOR FUNCTION	Peak(PK) Average (AV)
ENVIRONMENTAL CONDITIONS	25deg. C, 65%RH, 991hPa	TESTED BY	Brad Wu

ANTENNA POLARITY & TEST DISTANCE: HORIZONTAL AT 3 M								
No.	Freq. (MHz)	Emission Level (dBuV/m)	Limit (dBuV/m)	Margin (dB)	Antenna Height (m)	Table Angle (Degree)	Raw Value (dBuV)	Correction Factor (dB/m)
1	*2437.00	93.85 PK			1.48 H	192	61.44	32.41
2	*2437.00	83.36 AV			1.48 H	192	50.95	32.41
3	4874.00	47.65 PK	74.00	-26.35	1.05 H	186	8.96	38.69
4	4874.00	34.96 AV	54.00	-19.04	1.05 H	186	-3.73	38.69

ANTENNA POLARITY & TEST DISTANCE: VERTICAL AT 3 M								
No.	Freq. (MHz)	Emission Level (dBuV/m)	Limit (dBuV/m)	Margin (dB)	Antenna Height (m)	Table Angle (Degree)	Raw Value (dBuV)	Correction Factor (dB/m)
1	*2437.00	94.86 PK			1.15 V	14	62.45	32.41
2	*2437.00	84.36 AV			1.15 V	14	51.95	32.41
3	4874.00	48.82 PK	74.00	-25.18	1.01 V	239	10.13	38.69
4	4874.00	36.20 AV	54.00	-17.80	1.01 V	239	-2.49	38.69

- REMARKS:**
1. Emission level (dBuV/m) = Raw Value (dBuV) + Correction Factor (dB/m).
 2. Correction Factor (dB/m) = Antenna Factor (dB/m) + Cable Factor (dB).
 3. The other emission levels were very low against the limit.
 4. Margin value = Emission level – Limit value.
 5. The limit value is defined as per 15.247.
 6. “ * “: Fundamental frequency.

EUT TEST CONDITION		MEASUREMENT DETAIL	
CHANNEL	Channel 7	FREQUENCY RANGE	1 ~ 25GHz
MODULATION TYPE	BPSK	INPUT POWER (SYSTEM)	120Vac, 60 Hz
TRANSFER RATE	15.0Mbps	DETECTOR FUNCTION	Peak(PK) Average (AV)
ENVIRONMENTAL CONDITIONS	25deg. C, 65%RH, 991hPa	TESTED BY	Brad Wu

ANTENNA POLARITY & TEST DISTANCE: HORIZONTAL AT 3 M								
No.	Freq. (MHz)	Emission Level (dBuV/m)	Limit (dBuV/m)	Margin (dB)	Antenna Height (m)	Table Angle (Degree)	Raw Value (dBuV)	Correction Factor (dB/m)
1	*2452.00	93.95 PK			1.48 H	186	61.48	32.47
2	*2452.00	83.52 AV			1.48 H	186	51.05	32.47
3	2483.50	56.42 PK	74.00	-17.58	1.48 H	186	23.83	32.59
4	2483.50	45.79 AV	54.00	-8.21	1.48 H	186	13.20	32.59
5	4904.00	48.82 PK	74.00	-25.18	1.13 H	38	10.01	38.81
6	4904.00	36.29 AV	54.00	-17.71	1.13 H	38	-2.52	38.81

ANTENNA POLARITY & TEST DISTANCE: VERTICAL AT 3 M								
No.	Freq. (MHz)	Emission Level (dBuV/m)	Limit (dBuV/m)	Margin (dB)	Antenna Height (m)	Table Angle (Degree)	Raw Value (dBuV)	Correction Factor (dB/m)
1	*2452.00	95.15 PK			1.10 V	32	62.68	32.47
2	*2452.00	84.70 AV			1.10 V	32	52.23	32.47
3	2483.50	56.93 PK	74.00	-17.07	1.10 V	32	24.34	32.59
4	2483.50	46.25 AV	54.00	-7.75	1.10 V	32	13.66	32.59
5	4904.00	48.96 PK	74.00	-25.04	1.11 V	29	10.15	38.81
6	4904.00	36.34 AV	54.00	-17.66	1.11 V	29	-2.47	38.81

- REMARKS:**
1. Emission level (dBuV/m) = Raw Value (dBuV) + Correction Factor (dB/m).
 2. Correction Factor (dB/m) = Antenna Factor (dB/m) + Cable Factor (dB).
 3. The other emission levels were very low against the limit.
 4. Margin value = Emission level – Limit value.
 5. The limit value is defined as per 15.247.
 6. “ * “: Fundamental frequency.

4.3 6dB BANDWIDTH MEASUREMENT

4.3.1 LIMITS OF 6dB BANDWIDTH MEASUREMENT

The minimum of 6dB Bandwidth Measurement is 0.5 MHz.

4.3.2 TEST INSTRUMENTS

DESCRIPTION & MANUFACTURER	MODEL NO.	SERIAL NO.	CALIBRATED UNTIL
SPECTRUM ANALYZER	FSP 40	100040	Jun. 28, 2008

NOTE: The calibration interval of the above test instruments is 12 months and the calibrations are traceable to NML/ROC and NIST/USA.

4.3.3 TEST PROCEDURE

The transmitter output was connected to the spectrum analyzer through an attenuator. The bandwidth of the fundamental frequency was measured by spectrum analyzer with 100kHz RBW and 100kHz VBW. The 6dB bandwidth is defined as the total spectrum the power of which is higher than peak power minus 6dB.

4.3.4 DEVIATION FROM TEST STANDARD

No deviation

4.3.5 TEST SETUP

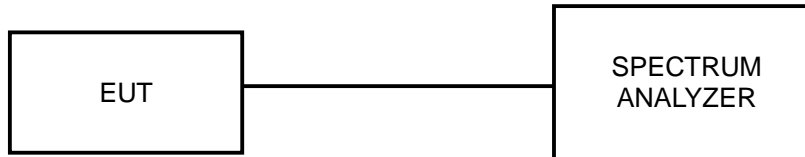

4.3.6 EUT OPERATING CONDITIONS

The software provided by client to enable the EUT under transmission condition continuously at lowest, middle and highest channel frequencies individually.

4.3.7 TEST RESULTS

802.11b DSSS MODULATION

MODULATION TYPE	DBPSK	TRANSFER RATE	1.0Mbps
INPUT POWER (SYSTEM)	120Vac, 60 Hz	ENVIRONMENTAL CONDITIONS	26deg.C, 66%RH, 991hPa
TESTED BY	Brad Wu		

CHANNEL	CHANNEL FREQUENCY (MHz)	6dB BANDWIDTH (MHz)	MINIMUM LIMIT (MHz)	PASS / FAIL
1	2412	12.28	0.5	PASS
6	2437	12.16	0.5	PASS
11	2462	12.28	0.5	PASS

CH 1

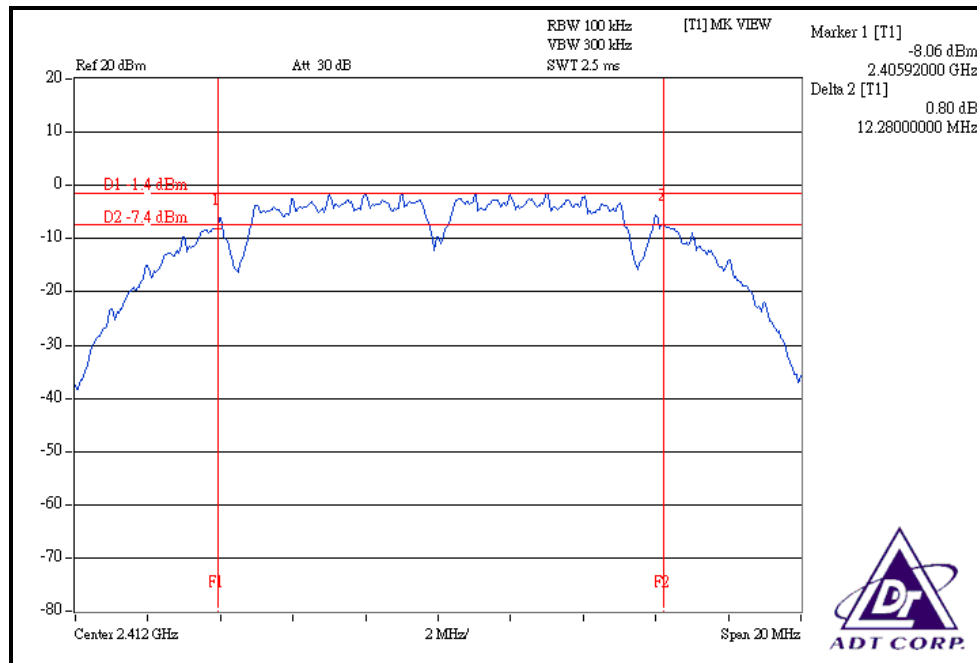

CH 6

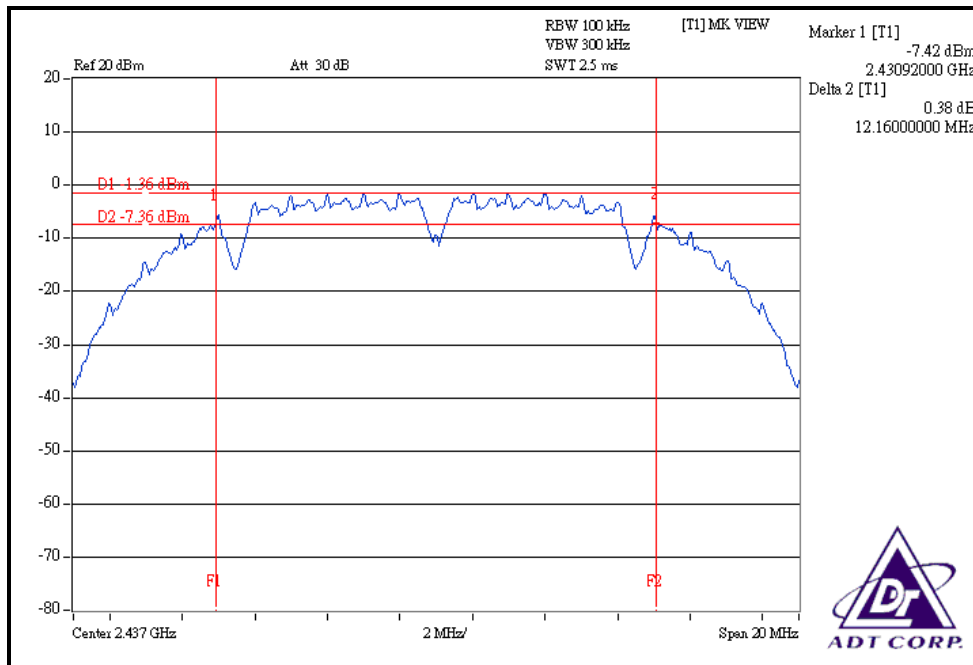

CH 11

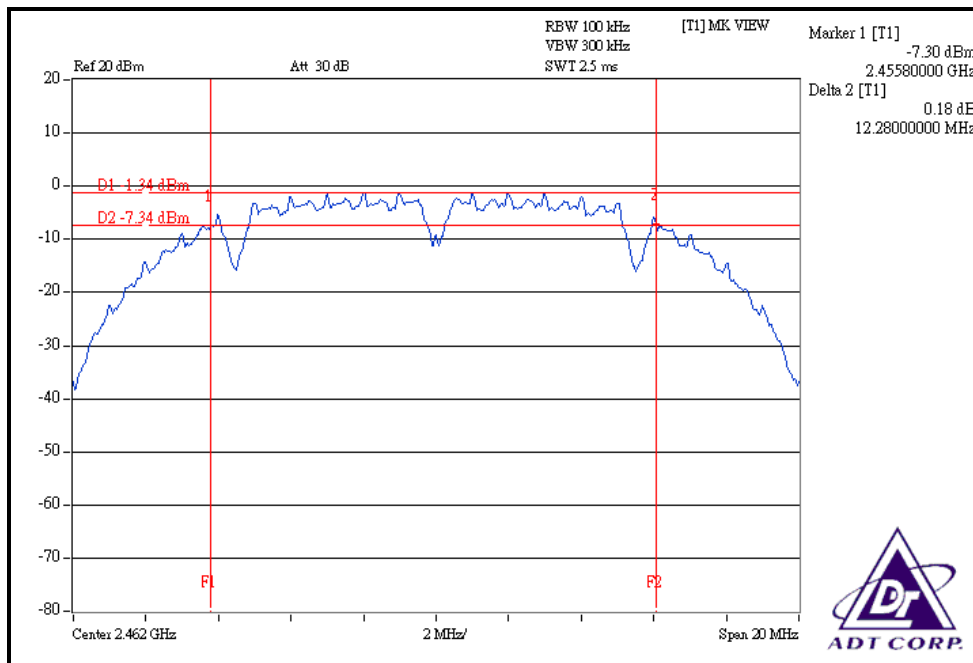



802.11g OFDM MODULATION

MODULATION TYPE	BPSK	TRANSFER RATE	6.0Mbps
INPUT POWER (SYSTEM)	120Vac, 60 Hz	ENVIRONMENTAL CONDITIONS	26deg.C, 66%RH, 991hPa
TESTED BY	Brad Wu		

CHANNEL	CHANNEL FREQUENCY (MHz)	6dB BANDWIDTH (MHz)	MINIMUM LIMIT (MHz)	PASS / FAIL
1	2412	16.60	0.5	PASS
6	2437	16.64	0.5	PASS
11	2462	16.64	0.5	PASS

CH 1

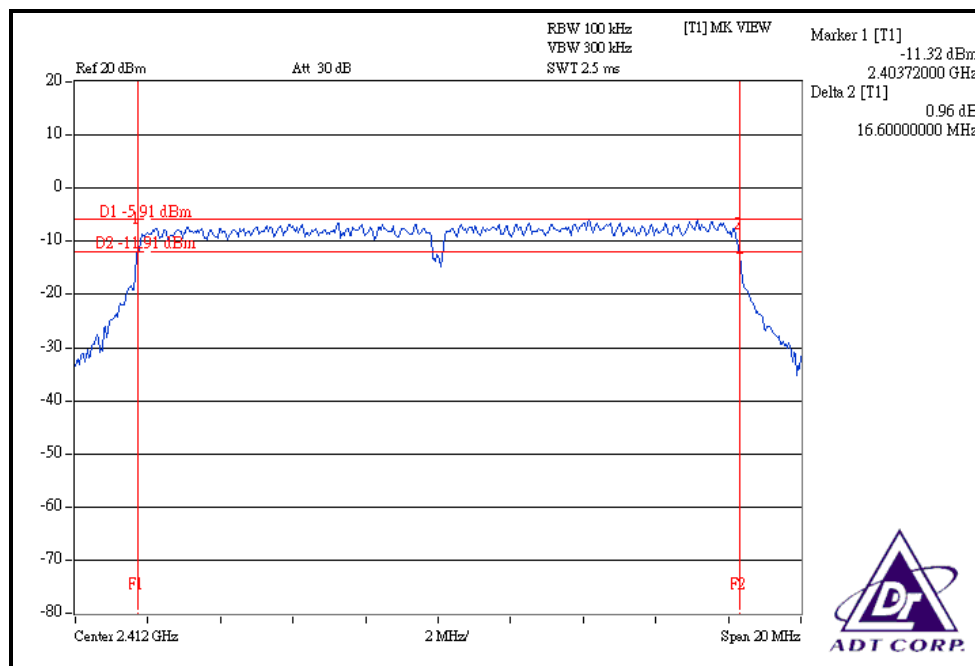

CH 6

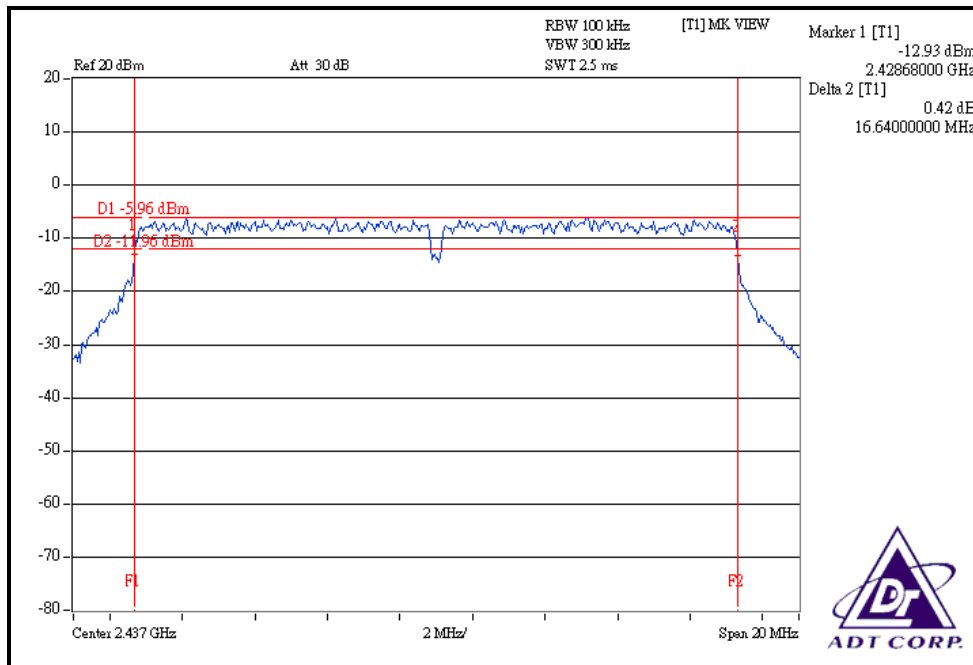

CH 11

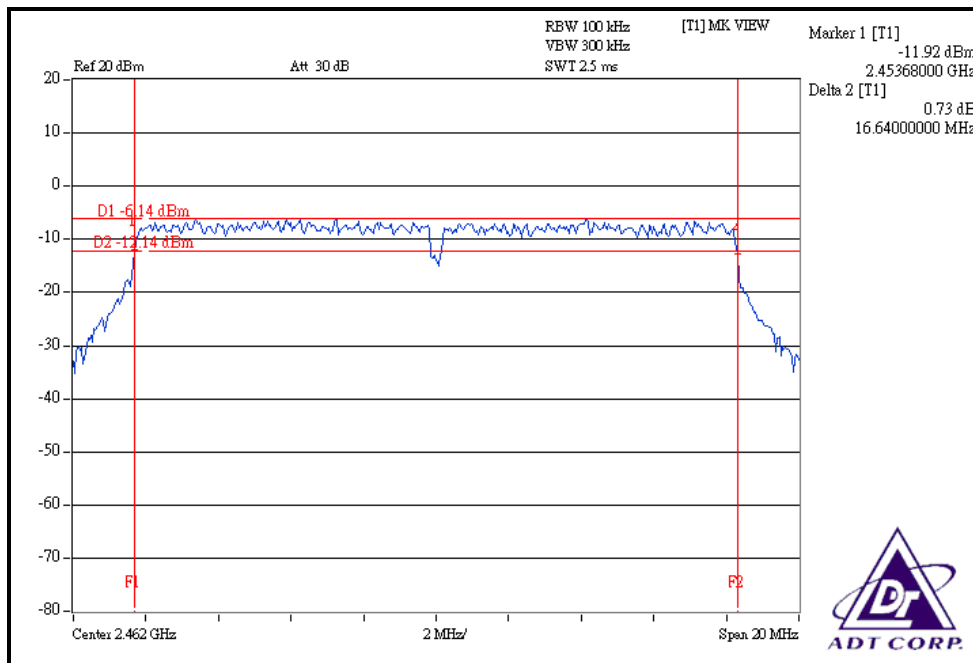



DRAFT 802.11n (20MHz) OFDM MODULATION

MODULATION TYPE	BPSK	TRANSFER RATE	7.2Mbps
INPUT POWER (SYSTEM)	120Vac, 60 Hz	ENVIRONMENTAL CONDITIONS	26deg.C, 66%RH, 991hPa
TESTED BY	Brad Wu		

CHANNEL	CHANNEL FREQUENCY (MHz)	6dB BANDWIDTH (MHz)		MINIMUM LIMIT (MHz)	PASS / FAIL
		CHAIN 0	CHAIN 1		
1	2412	17.76	17.80	0.5	PASS
6	2437	17.76	17.72	0.5	PASS
11	2462	17.76	17.76	0.5	PASS

FOR CHAIN 0: CH 1

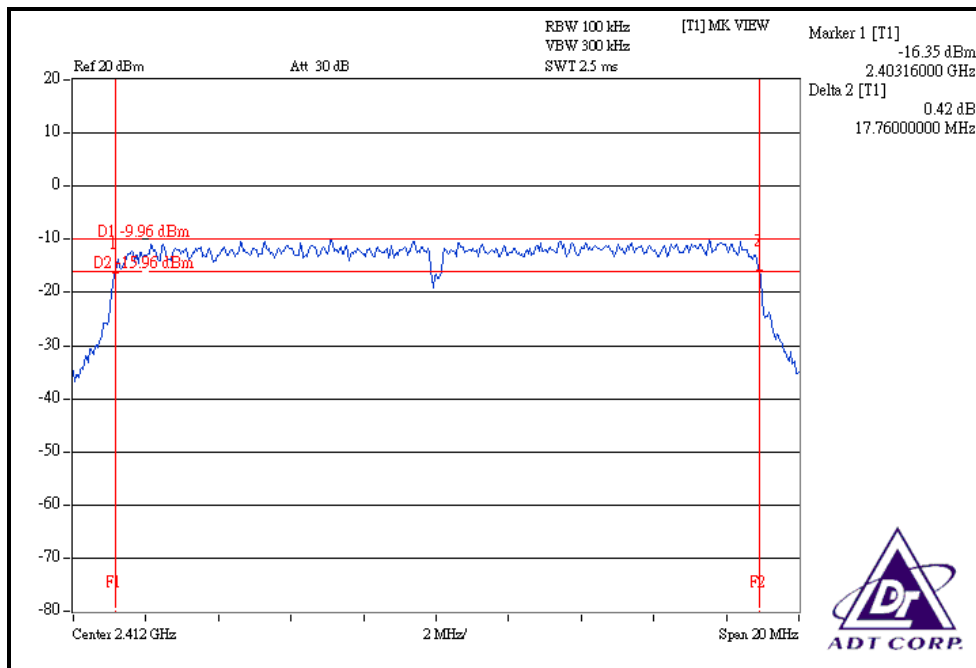

CH 6

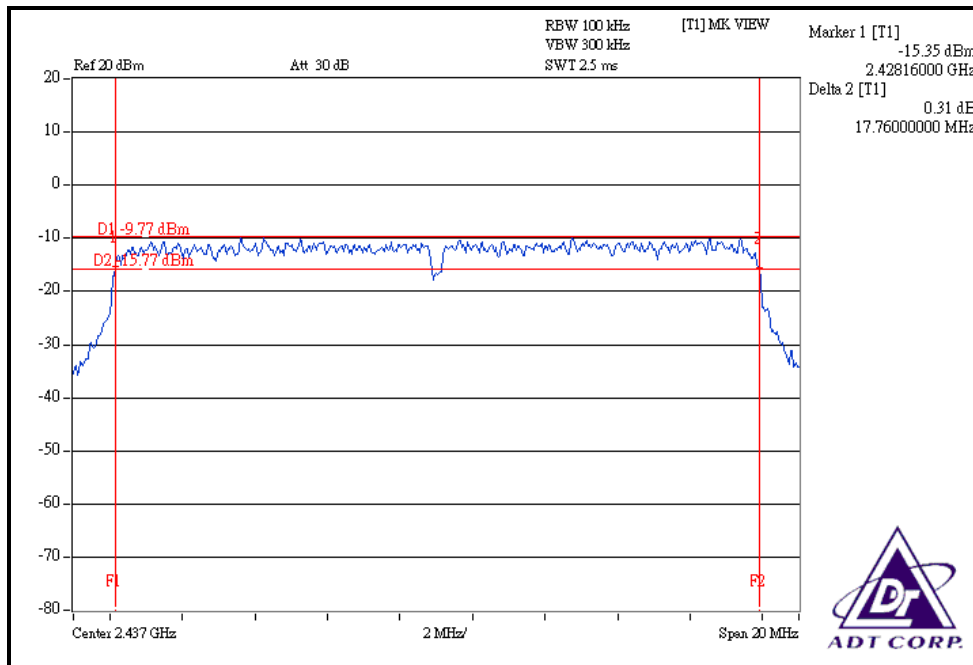

CH 11

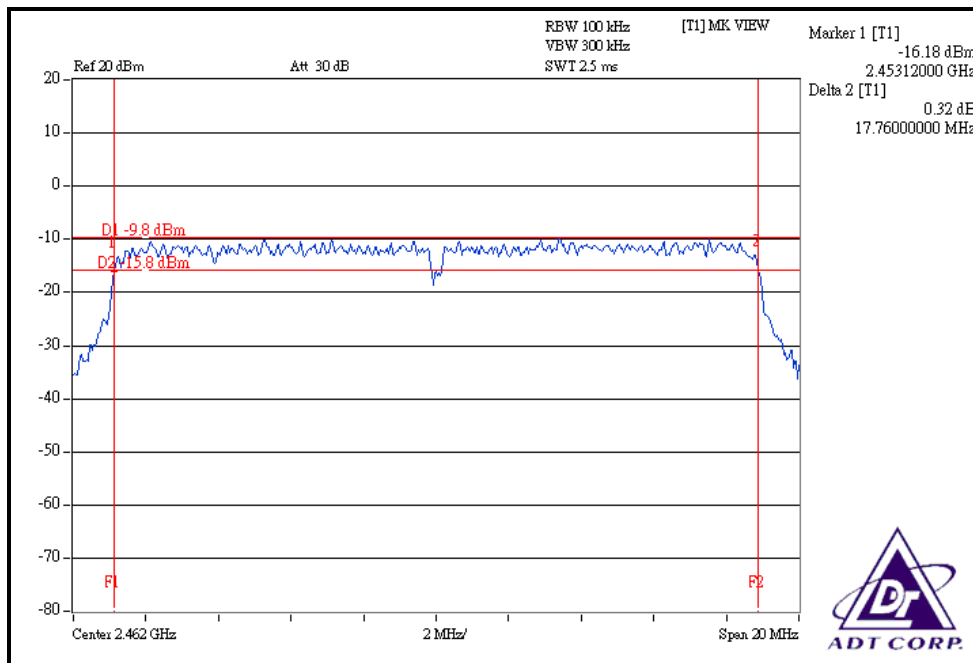

FOR CHAIN 1: CH 1

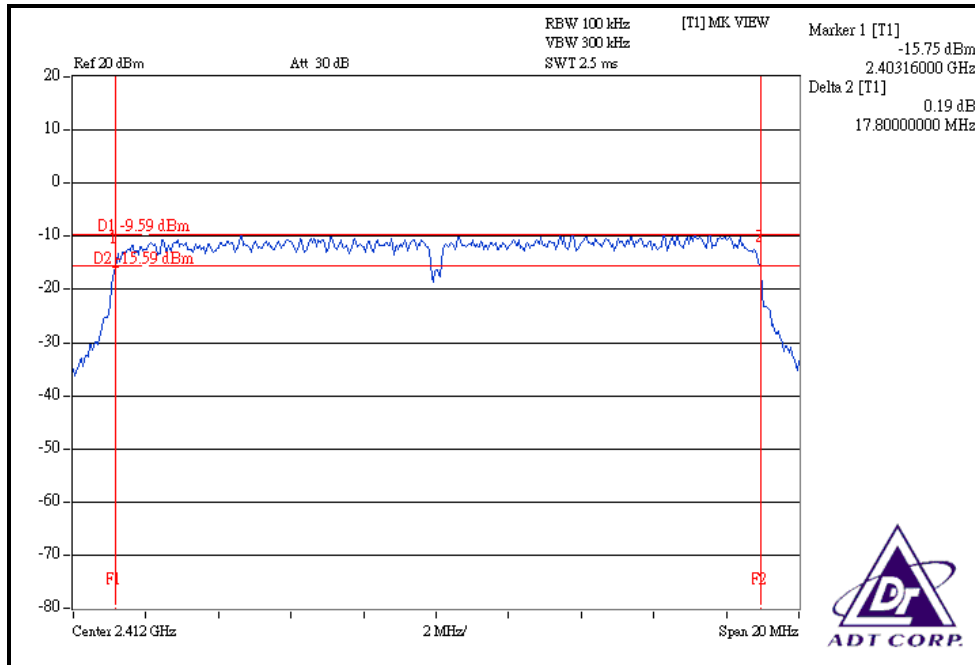

CH 6

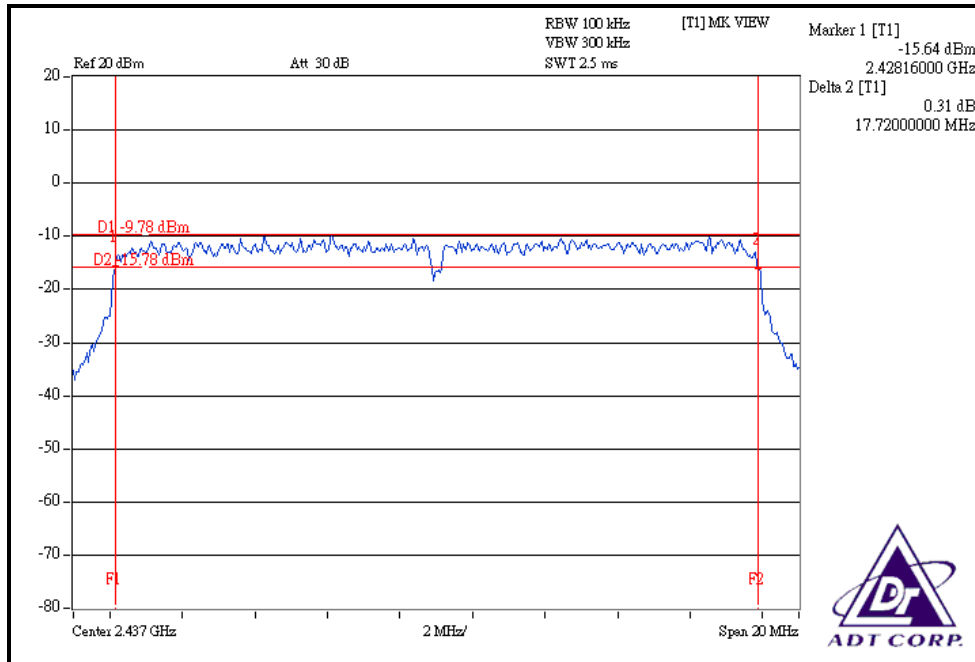

CH 11

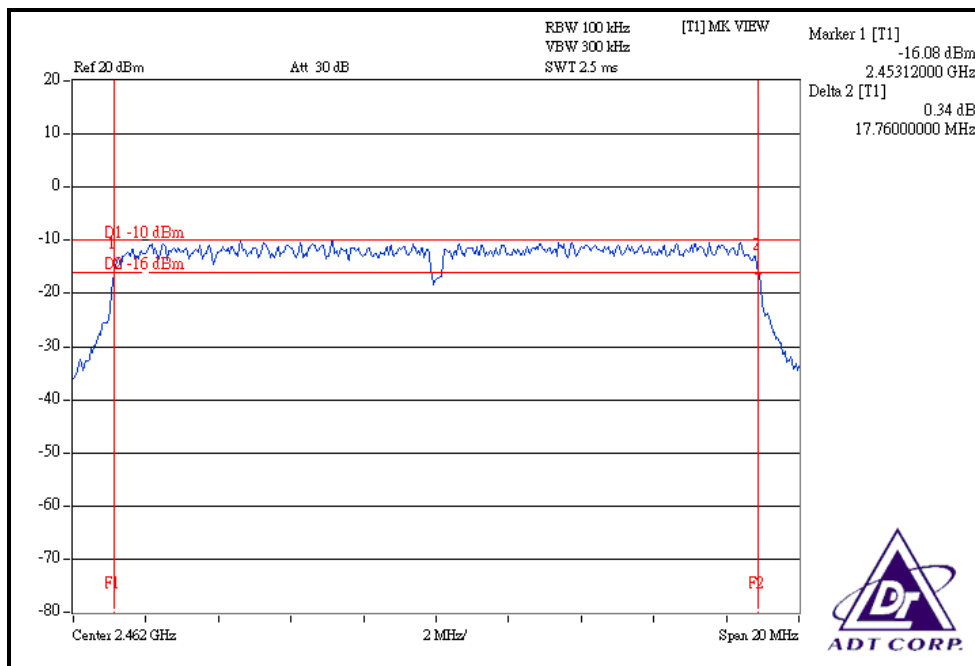



DRAFT 802.11n (40MHz) OFDM MODULATION

MODULATION TYPE	BPSK	TRANSFER RATE	15.0Mbps
INPUT POWER (SYSTEM)	120Vac, 60 Hz	ENVIRONMENTAL CONDITIONS	26deg.C, 66%RH, 991hPa
TESTED BY	Brad Wu		

CHANNEL	CHANNEL FREQUENCY (MHz)	6dB BANDWIDTH (MHz)		MINIMUM LIMIT (MHz)	PASS / FAIL
		CHAIN 0	CHAIN 1		
1	2422	36.48	36.48	0.5	PASS
4	2437	36.48	36.48	0.5	PASS
7	2452	36.56	36.56	0.5	PASS

FOR CHAIN 0: CH 1

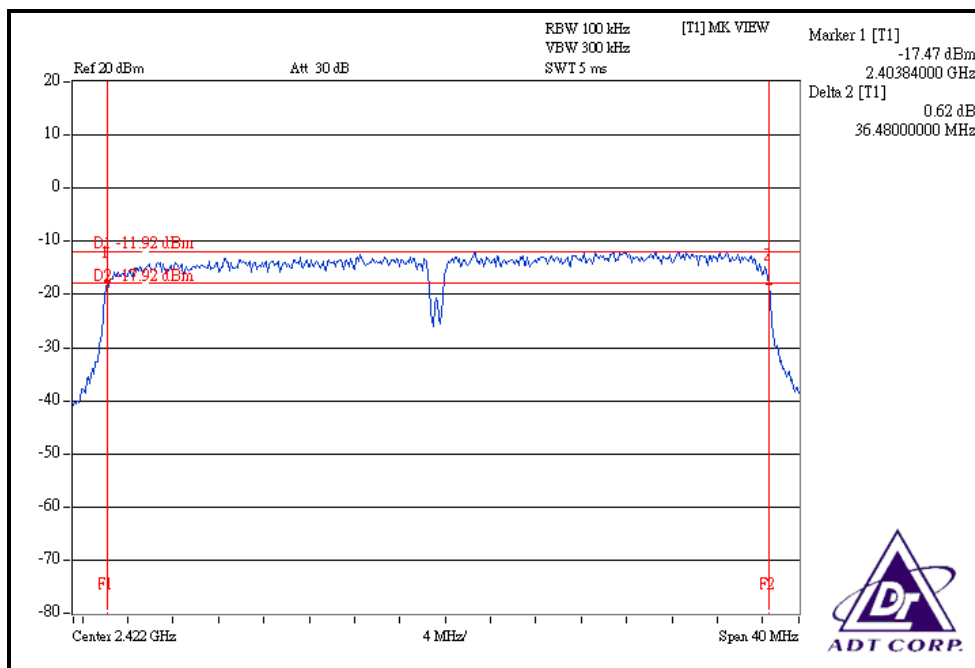

CH 4

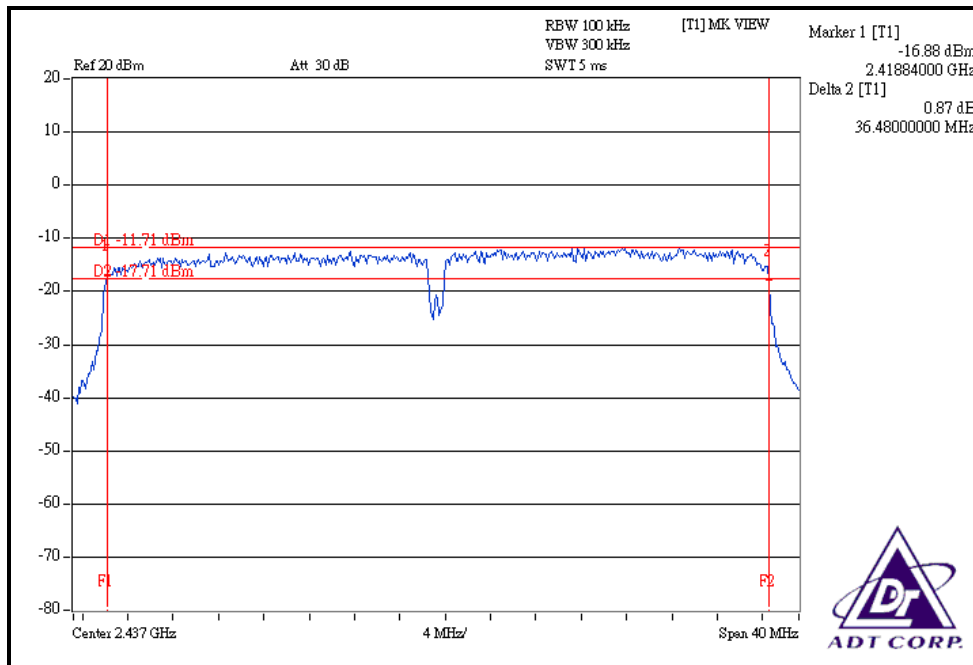

CH 7

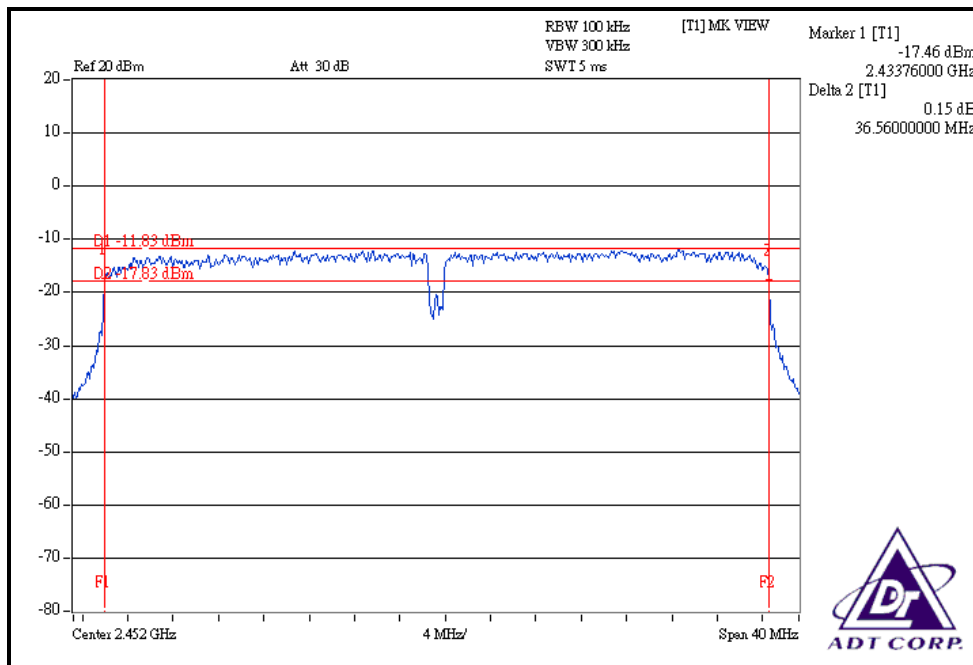

FOR CHAIN 1: CH 1

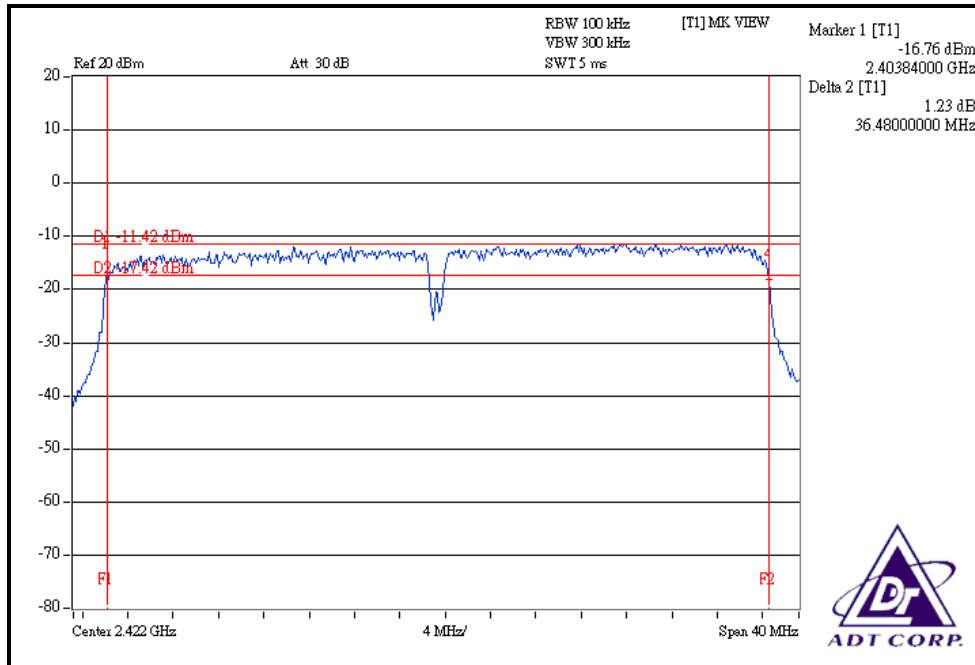

CH 4

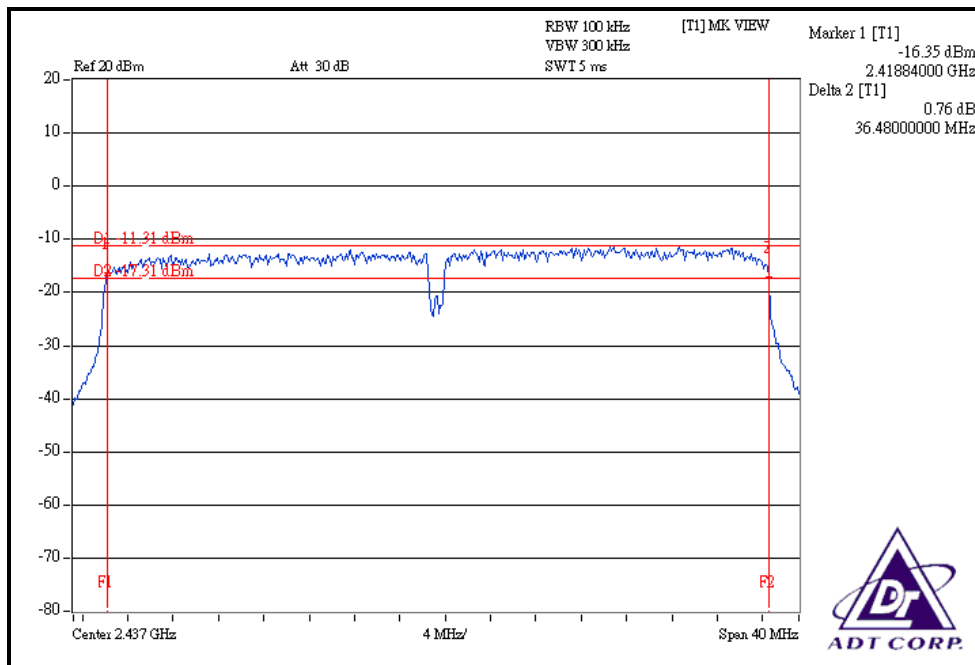

CH 7

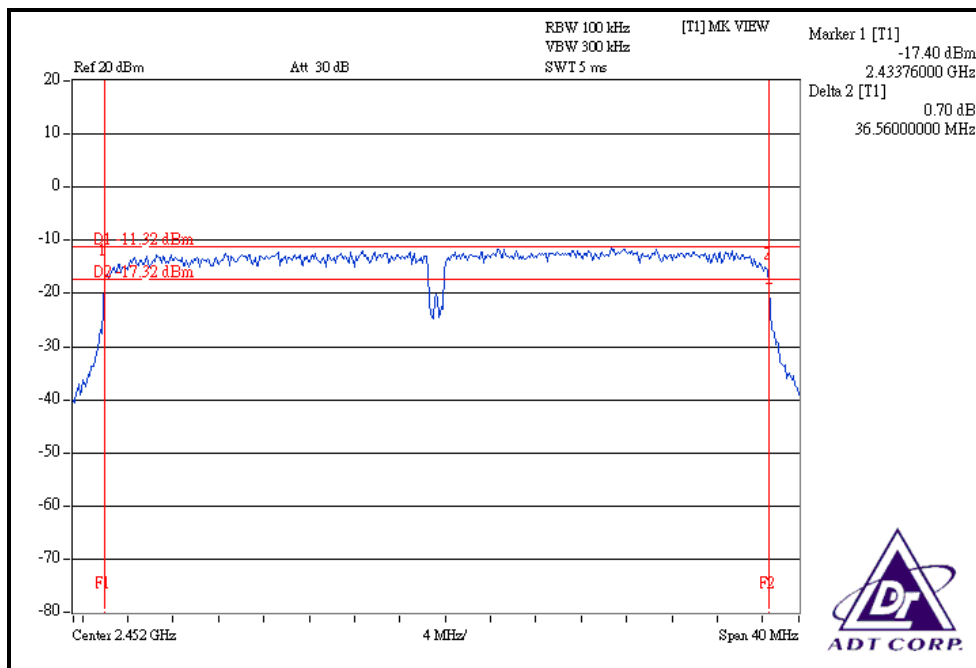

4.4 MAXIMUM PEAK OUTPUT POWER

4.4.1 LIMITS OF MAXIMUM PEAK OUTPUT POWER MEASUREMENT

The Maximum Peak Output Power Measurement is 30dBm.

4.4.2 INSTRUMENTS

DESCRIPTION & MANUFACTURER	MODEL NO.	SERIAL NO.	CALIBRATED UNTIL
SPECTRUM ANALYZER	FSP40	100040	Jun. 28, 2008
AGILENT SYNTHESIZED SIGNAL GENERATOR	E8257C	MY43320668	Dec. 28, 2007
DIGITAL RT OSCILLOSCOPE	TDS1012	C037299	Nov. 27, 2007
NARDA DETECTOR	4503A	FSCM99899	NA

NOTE: The calibration interval of the above test instruments is 12 months and the calibrations are traceable to NML/ROC and NIST/USA.

4.4.3 TEST PROCEDURES

- a. A detector was used on the output port of the EUT. An oscilloscope was used to read the response of the detector.
- b. Replaced the EUT by the signal generator. The center frequency of the S.G was adjusted to the center frequency of the measured channel.
- c. Adjusted the power to have the same reading on oscilloscope. Record the power level.

4.4.4 DEVIATION FROM TEST STANDARD

No deviation

4.4.5 TEST SETUP



4.4.6 EUT OPERATING CONDITIONS

Same as Item 4.3.6

4.4.7 TEST RESULTS

802.11b DSSS MODULATION

MODULATION TYPE	DBPSK	TRANSFER RATE	1.0Mbps
INPUT POWER (SYSTEM)	120Vac, 60 Hz	ENVIRONMENTAL CONDITIONS	26deg.C, 66%RH, 991hPa
TESTED BY	Brad Wu		

CHAN	CHANNEL FREQUENCY (MHz)	PEAK POWER OUTPUT (mW)	PEAK POWER OUTPUT (dBm)	PEAK POWER LIMIT (dBm)	PASS/FAIL
1	2412	15.241	11.83	30	PASS
6	2437	15.417	11.88	30	PASS
11	2462	15.382	11.87	30	PASS

802.11g OFDM MODULATION

MODULATION TYPE	BPSK	TRANSFER RATE	6.0Mbps
INPUT POWER (SYSTEM)	120Vac, 60 Hz	ENVIRONMENTAL CONDITIONS	26deg.C, 66%RH, 991hPa
TESTED BY	Brad Wu		

CHAN	CHANNEL FREQUENCY (MHz)	PEAK POWER OUTPUT (mW)	PEAK POWER OUTPUT (dBm)	PEAK POWER LIMIT (dBm)	PASS/FAIL
1	2412	15.417	11.88	30	PASS
6	2437	15.346	11.86	30	PASS
11	2462	15.382	11.87	30	PASS



DRAFT 802.11n (20MHz) OFDM MODULATION

MODULATION TYPE	BPSK	TRANSFER RATE	7.2Mbps
INPUT POWER (SYSTEM)	120Vac, 60 Hz	ENVIRONMENTAL CONDITIONS	26deg.C, 66%RH, 991hPa
TESTED BY	Brad Wu		

CHANNEL	CHANNEL FREQUENCY (MHz)	PEAK POWER OUTPUT (mW)		PEAK POWER OUTPUT (dBm)		TOTAL PEAK POWER (mW)	TOTAL PEAK POWER (dBm)	PEAK POWER LIMIT (dBm)	PASS / FAIL
		CHAIN 0	CHAIN 1	CHAIN 0	CHAIN 1				
1	2412	7.709	7.762	8.87	8.90	15.471	11.90	30	PASS
6	2437	7.638	7.709	8.83	8.87	15.347	11.86	30	PASS
11	2462	7.603	7.638	8.81	8.83	15.241	11.83	30	PASS

DRAFT 802.11n (40MHz) OFDM MODULATION

MODULATION TYPE	BPSK	TRANSFER RATE	15.0Mbps
INPUT POWER (SYSTEM)	120Vac, 60 Hz	ENVIRONMENTAL CONDITIONS	26deg.C, 66%RH, 991hPa
TESTED BY	Brad Wu		

CHANNEL	CHANNEL FREQUENCY (MHz)	PEAK POWER OUTPUT (mW)		PEAK POWER OUTPUT (dBm)		TOTAL PEAK POWER (mW)	TOTAL PEAK POWER (dBm)	PEAK POWER LIMIT (dBm)	PASS / FAIL
		CHAIN 0	CHAIN 1	CHAIN 0	CHAIN 1				
1	2422	7.762	7.745	8.90	8.89	15.507	11.91	30	PASS
4	2437	7.656	7.638	8.84	8.83	15.294	11.85	30	PASS
7	2452	7.709	7.745	8.87	8.89	15.454	11.89	30	PASS

4.5 POWER SPECTRAL DENSITY MEASUREMENT

4.5.1 LIMITS OF POWER SPECTRAL DENSITY MEASUREMENT

The Maximum of Power Spectral Density Measurement is 8dBm.

4.5.2 TEST INSTRUMENTS

DESCRIPTION & MANUFACTURER	MODEL NO.	SERIAL NO.	CALIBRATED UNTIL
R&S SPECTRUM ANALYZER	FSP 40	100040	Jun. 28, 2008

NOTE: The calibration interval of the above test instruments is 12 months and the calibrations are traceable to NML/ROC and NIST/USA.

4.5.3 TEST PROCEDURE

The transmitter output was connected to the spectrum analyzer through an attenuator, the bandwidth of the fundamental frequency was measured with the spectrum analyzer using 3kHz RBW and 30kHz VBW, set sweep time = span/3kHz. The power spectral density was measured and recorded.

The sweep time is allowed to be longer than span/3kHz for a full response of the mixer in the spectrum analyzer.

4.5.4 DEVIATION FROM TEST STANDARD

No deviation

4.5.5 TEST SETUP

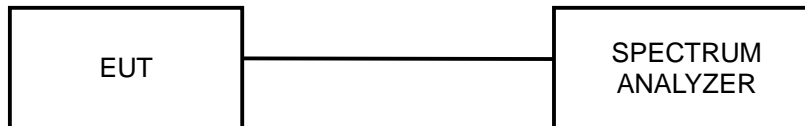

4.5.6 EUT OPERATING CONDITION

Same as Item 4.3.6

CH 6

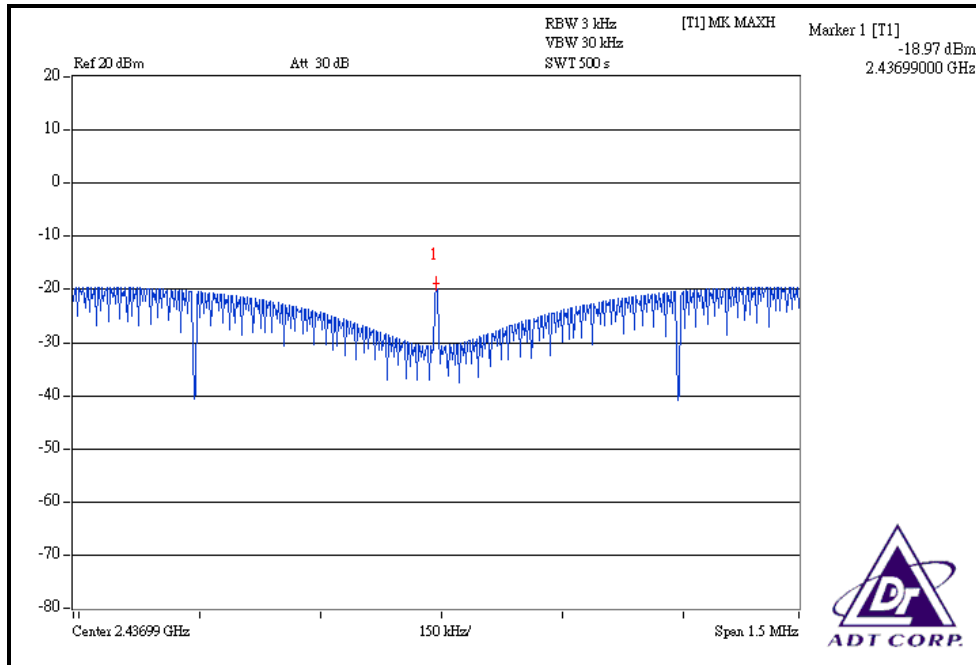

CH 11

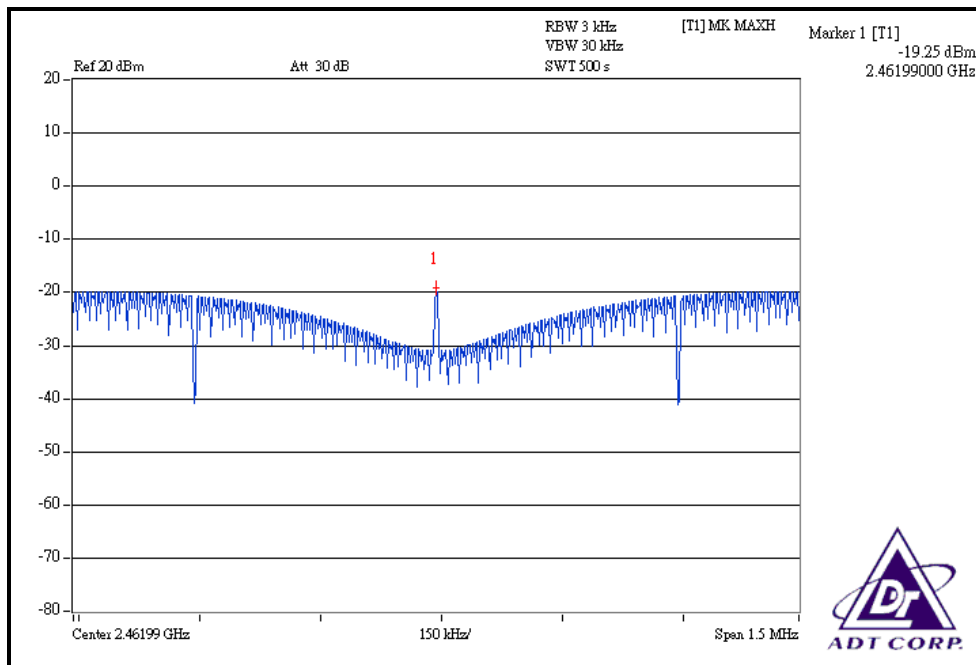



802.11g OFDM MODULATION

MODULATION TYPE	BPSK	TRANSFER RATE	6.0Mbps
INPUT POWER (SYSTEM)	120Vac, 60 Hz	ENVIRONMENTAL CONDITIONS	26deg.C, 66%RH, 991hPa
TESTED BY	Brad Wu		

CHANNEL	CHANNEL FREQUENCY (MHz)	RF POWER LEVEL IN 3 kHz BW (dBm)	MAXIMUM LIMIT (dBm)	PASS/FAIL
1	2412	-20.36	8	PASS
6	2437	-20.48	8	PASS
11	2462	-20.53	8	PASS

CH 1

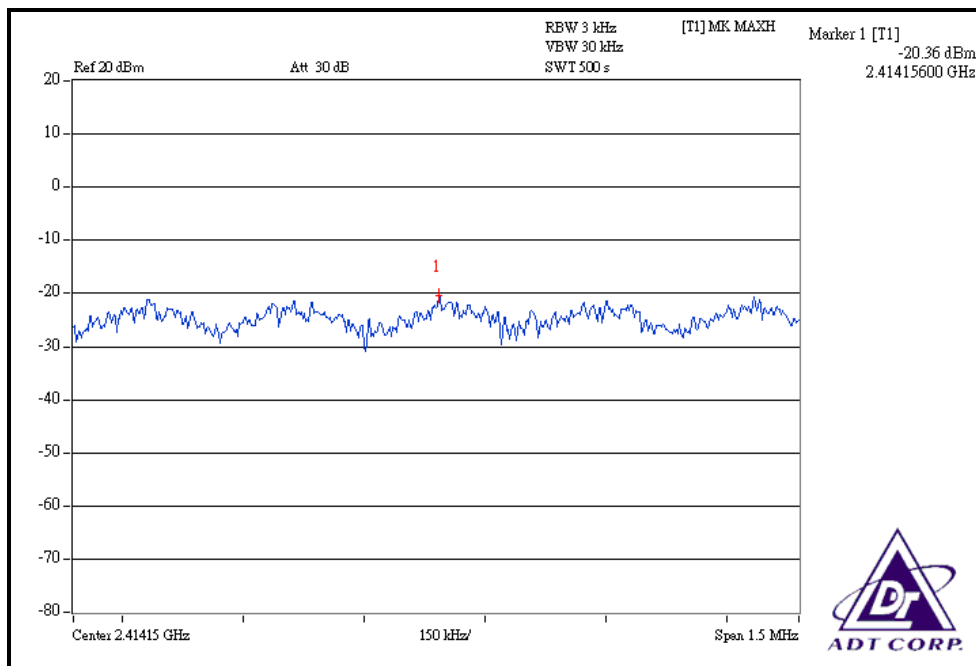

CH 6

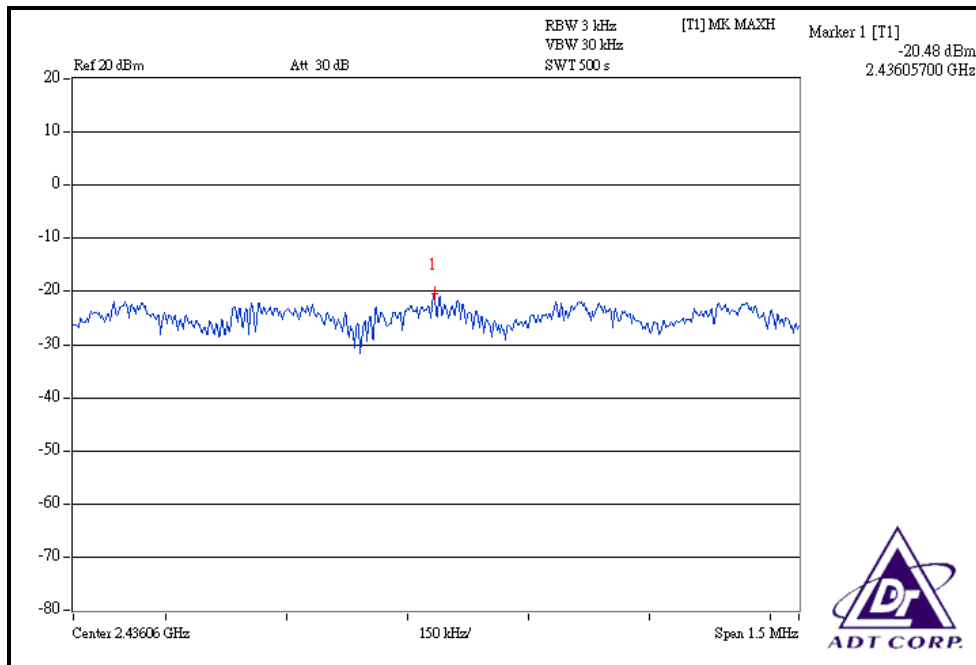

CH 11

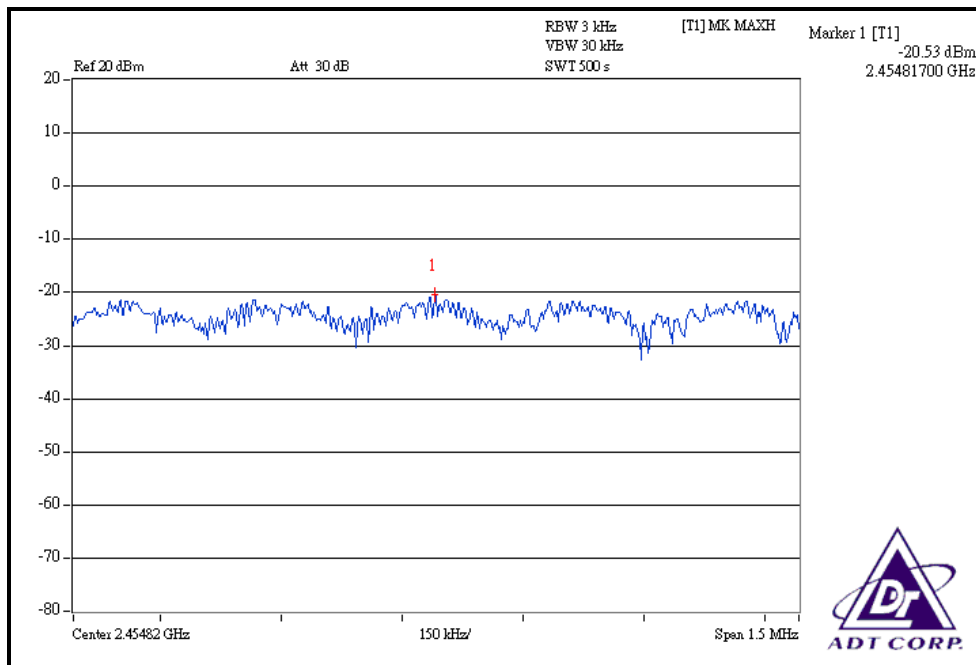



DRAFT 802.11n (20MHz) OFDM MODULATION

MODULATION TYPE	BPSK	TRANSFER RATE	7.2Mbps
INPUT POWER (SYSTEM)	120Vac, 60 Hz	ENVIRONMENTAL CONDITIONS	26deg.C, 66%RH, 991hPa
TESTED BY	Brad Wu		

CHANNEL	CHANNEL FREQUENCY (MHz)	RF POWER LEVEL IN 3kHz BW (mW)		RF POWER LEVEL IN 3kHz BW (dBm)		TOTAL POWER DENSITY (mW)	TOTAL POWER DENSITY (dBm)	MAX. LIMIT (dBm)	PASS / FAIL
		CHAIN 0	CHAIN 1	CHAIN 0	CHAIN 1				
1	2412	0.004	0.004	-23.70	-23.80	0.008	-20.74	8	PASS
6	2437	0.004	0.004	-23.58	-23.55	0.008	-20.55	8	PASS
11	2462	0.005	0.004	-23.46	-23.87	0.009	-20.65	8	PASS

FOR CHAIN 0: CH 1

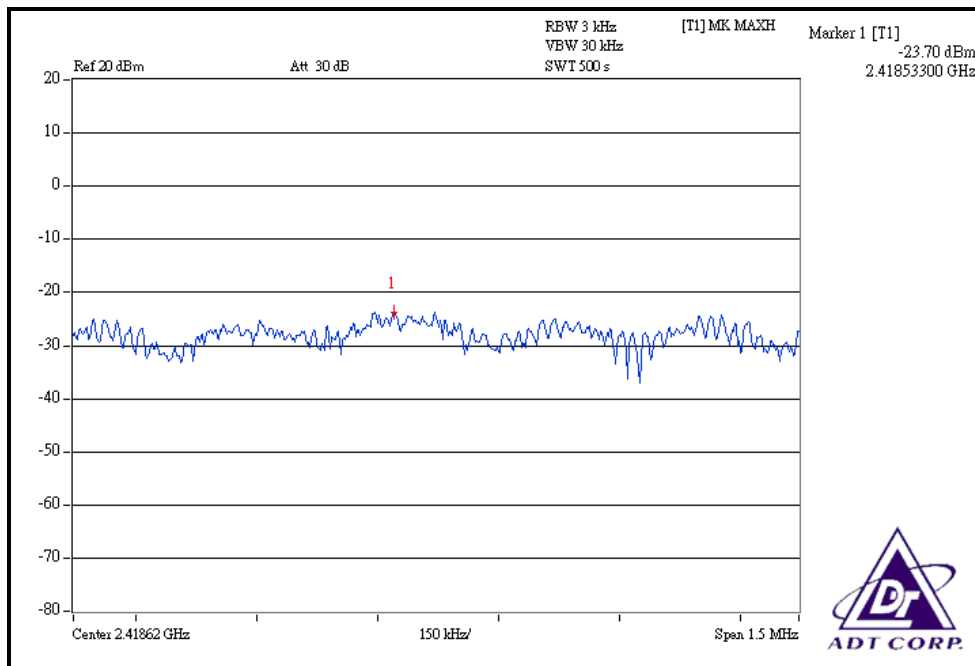

FOR CHAIN 1: CH 1

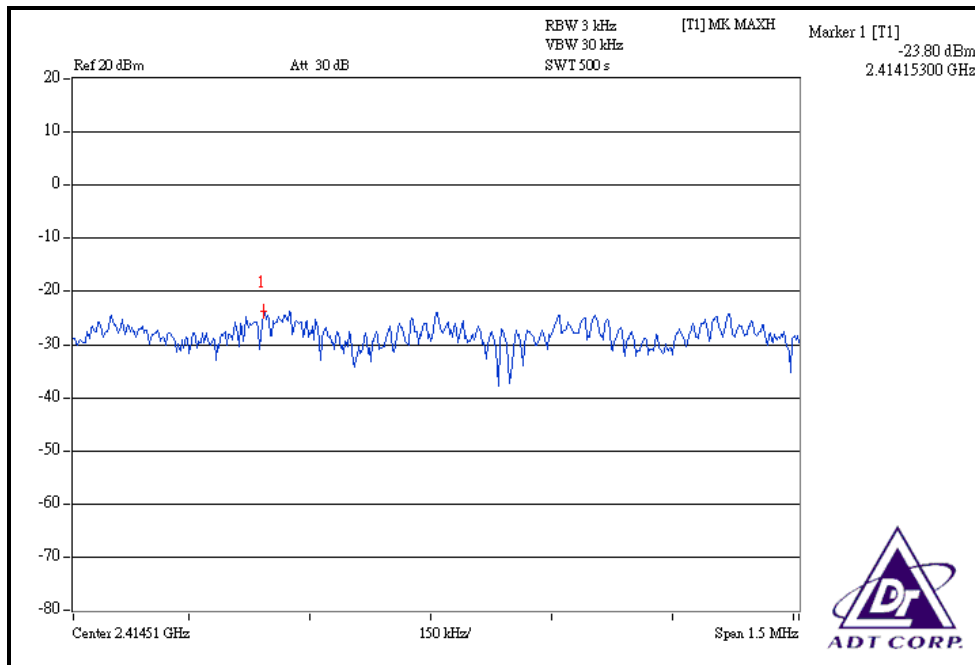

CH 6

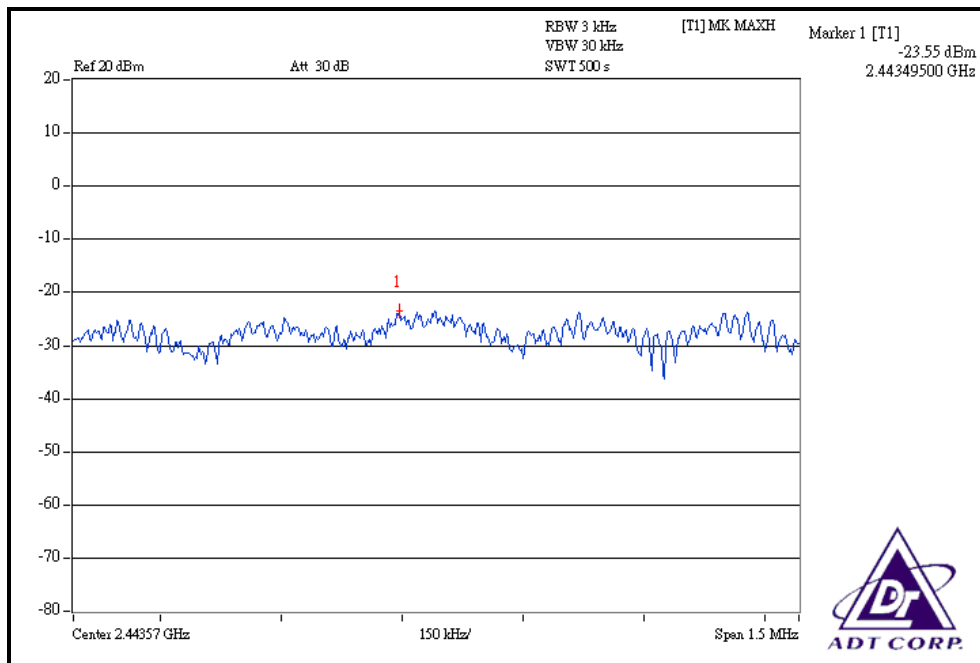

CH 11

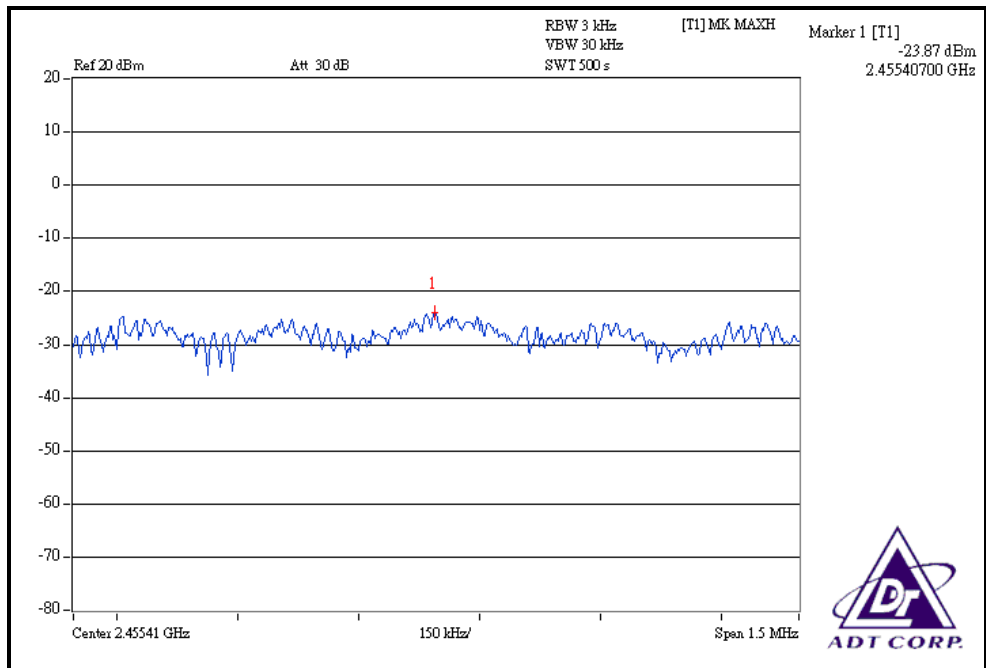



DRAFT 802.11n (40MHz) OFDM MODULATION

MODULATION TYPE	BPSK	TRANSFER RATE	15.0Mbps
INPUT POWER (SYSTEM)	120Vac, 60 Hz	ENVIRONMENTAL CONDITIONS	26deg.C, 66%RH, 991hPa
TESTED BY	Brad Wu		

CHANNEL	CHANNEL FREQUENCY (MHz)	RF POWER LEVEL IN 3kHz BW (mW)		RF POWER LEVEL IN 3kHz BW (dBm)		TOTAL POWER DENSITY (mW)	TOTAL POWER DENSITY (dBm)	MAX. LIMIT (dBm)	PASS / FAIL
		CHAIN 0	CHAIN 1	CHAIN 0	CHAIN 1				
1	2422	0.004	0.005	-23.76	-23.46	0.009	-20.60	8	PASS
4	2437	0.004	0.004	-23.78	-23.68	0.008	-20.72	8	PASS
7	2452	0.004	0.004	-23.60	-23.67	0.008	-20.62	8	PASS

FOR CHAIN 0: CH 1

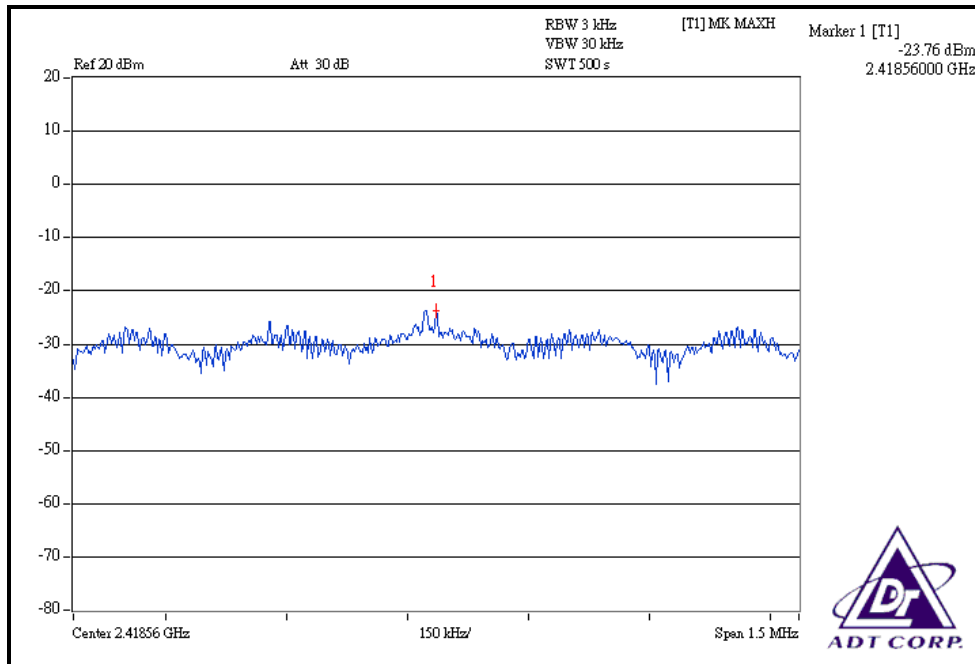

CH 7

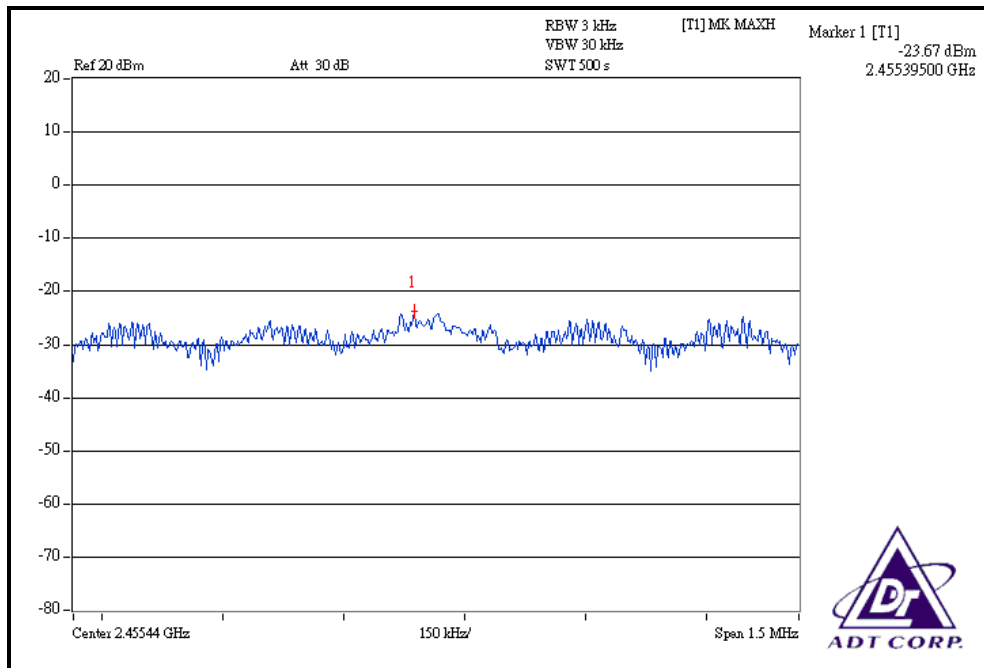

4.6 BAND EDGES MEASUREMENT

4.6.1 LIMITS OF BAND EDGES MEASUREMENT

Below -20dB of the highest emission level of operating band (in 100kHz Resolution Bandwidth).

4.6.2 TEST INSTRUMENTS

DESCRIPTION & MANUFACTURER	MODEL NO.	SERIAL NO.	CALIBRATED UNTIL
For Single TX:			
R&S SPECTRUM ANALYZER	FSP40	100040	Jun. 28, 2008
For Dual TX:			
Test Receiver ROHDE & SCHWARZ	ESI7	838496/016	Dec. 29, 2007
Spectrum Analyzer ROHDE & SCHWARZ	FSP40	100039	Dec. 01, 2007
BILOG Antenna SCHWARZBECK	VULB9168	9168-155	Jan. 04, 2008
HORN Antenna SCHWARZBECK	BBHA 9120D	9120D-405	Dec. 18, 2007
HORN Antenna SCHWARZBECK	BBHA 9170	BBHA9170242	Jan. 16, 2008
Preamplifier Agilent	8449B	3008A1960	Oct. 30, 2007
Preamplifier Agilent	8447D	2944A10631	Oct. 30, 2007
RF signal cable HUBER+SUHNNER	SUCOFLEX 104	230128/4	Nov. 14, 2007
RF signal cable HUBER+SUHNNER	SUCOFLEX 104	233233/4	Nov. 14, 2007

NOTE: The calibration interval of the above test instruments is 12 months and the calibrations are traceable to NML/ROC and NIST/USA.

4.6.3 TEST PROCEDURE

For Single TX:

The transmitter output was connected to the spectrum analyzer via a low loss cable. Set both RBW and VBW of spectrum analyzer to 100kHz with suitable frequency span including 10Hz bandwidth from band edge. The band edges was measured and recorded.

The spectrum plots (Peak RBW = VBW = 100kHz; Average RBW = 1MHz, VBW = 10Hz) are attached on the following pages.

For Dual TX:

- a. The EUT was placed on the top of a rotating table 0.8 meters above the ground at a 3 meter semi-anechoic chamber. The table was rotated 360 degrees to determine the position of the highest radiation.
- b. The EUT was set 3 meters away from the interference-receiving antenna, which was mounted on the top of a variable-height antenna tower.
- c. The antenna is a broadband antenna, and its height is varied from one meter to four meters above the ground to determine the maximum value of the field strength. Both horizontal and vertical polarizations of the antenna are set to make the measurement.
- d. For each suspected emission, the EUT was arranged to its worst case and then the antenna was tuned to heights from 1 meter to 4 meters and the rotatable table was turned from 0 degrees to 360 degrees to find the maximum reading.
- e. Set both RBW and VBW of spectrum analyzer to 100kHz with suitable frequency span including 100MHz bandwidth from band edge. The band edges was measured and recorded.

The spectrum plots (Peak RBW = VBW = 100kHz; Average RBW = 1MHz, VBW = 10Hz)

NOTE: The resolution bandwidth of test receiver/spectrum analyzer is 1 MHz and the video bandwidth is 10Hz for Average detection (AV) at frequency above 1GHz.

4.6.4 DEVIATION FROM TEST STANDARD

No deviation

4.6.5 EUT OPERATING CONDITION

Same as Item 4.3.6

4.6.6 TEST RESULTS

The spectrum plots are attached on the following 24 images. D1 line indicates the highest level, and D2 line indicates the 20dB offset below D1. It shows compliance with the requirement in part 15.247(d).

802.11b DSSS MODULATION

NOTE 1: The band edge emission plot on the next page shows 45.95dBc between carrier maximum power and local maximum emission in restrict band (2.35720GHz). The emission of carrier strength list in the test result of channel 1 at the item 4.2.7 is 97.37dBuV/m (Peak), so the maximum field strength in restrict band is $97.37 - 45.95 = 51.42$ dBuV/m which is under 74dBuV/m limit.

The band edge emission plot on the next page shows 54.78dBc between carrier maximum power and local maximum emission in restrict band (2.39000GHz). The emission of carrier strength list in the test result of channel 1 at the item 4.2.7 is 92.81dBuV/m (Average), so the maximum field strength in restrict band is $92.81 - 54.78 = 38.03$ dBuV/m which is under 54dBuV/m limit.

NOTE 2: The band edge emission plot on the next second page shows 46.10dBc between carrier maximum power and local maximum emission in restrict band (2.48360GHz). The emission of carrier strength list in the test result of channel 11 at the item 4.2.7 is 97.35dBuV/m (Peak), so the maximum field strength in restrict band is $97.35 - 46.10 = 51.25$ dBuV/m which is under 74dBuV/m limit.

The band edge emission plot on the next third page shows 54.38dBc between carrier maximum power and local maximum emission in restrict band (2.48380GHz). The emission of carrier strength list in the test result of channel 11 at the item 4.2.7 is 92.84dBuV/m (Average), so the maximum field strength in restrict band is $92.84 - 54.38 = 38.46$ dBuV/m which is under 54dBuV/m limit.

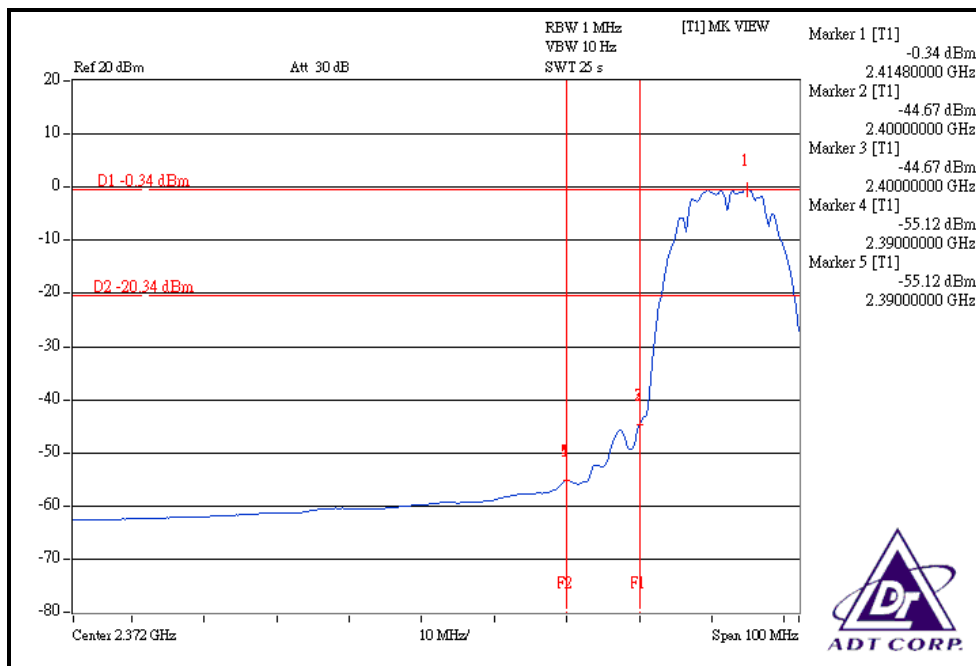
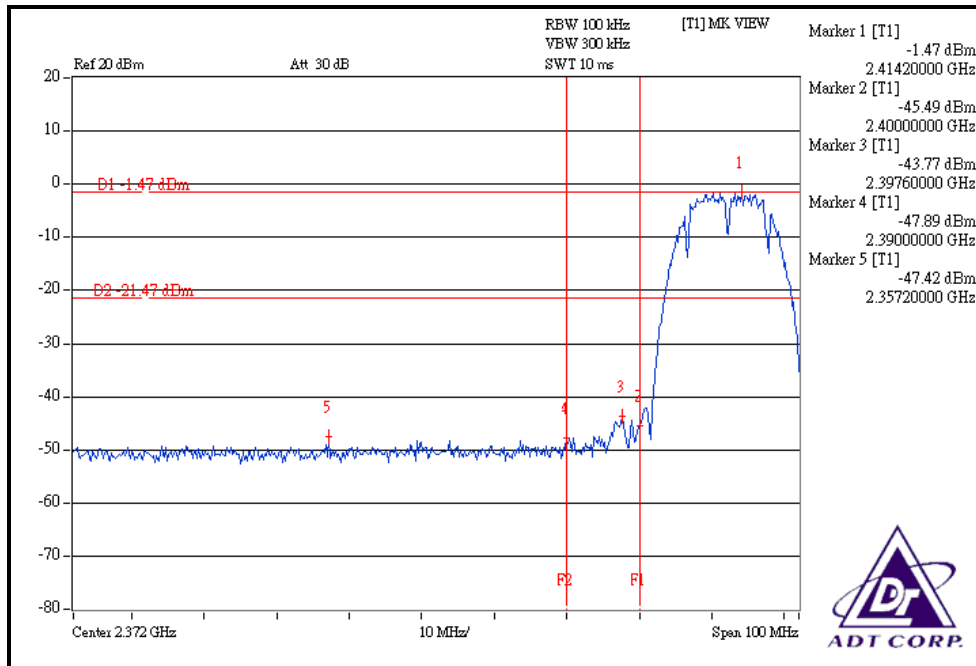

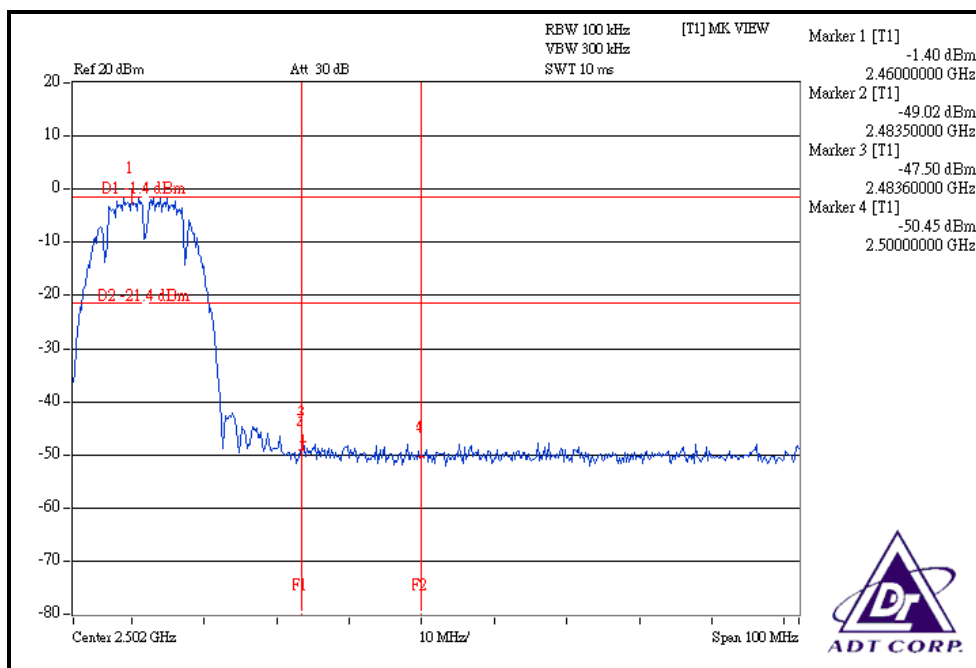
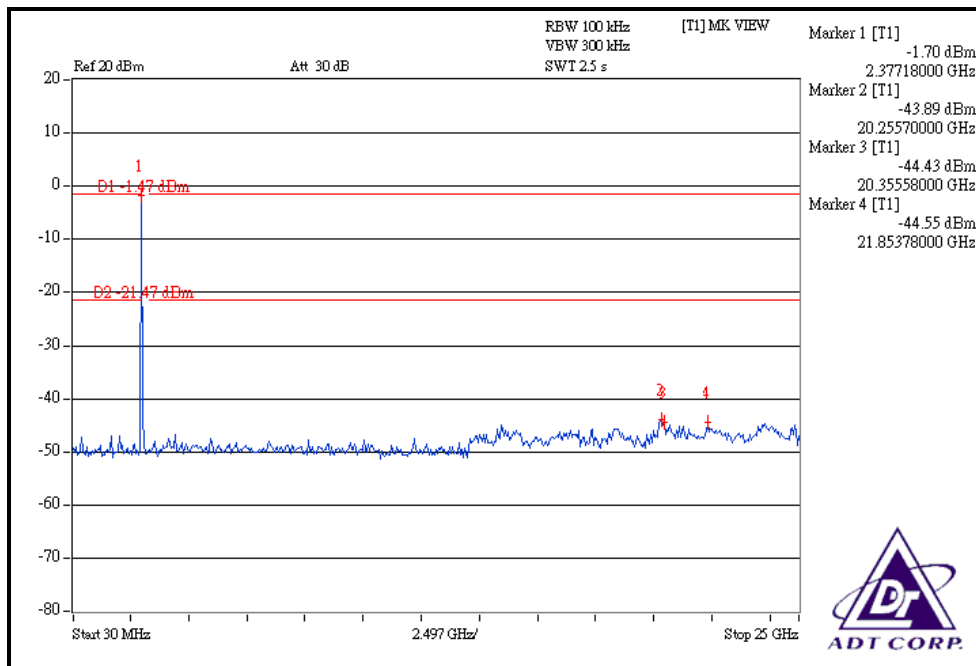

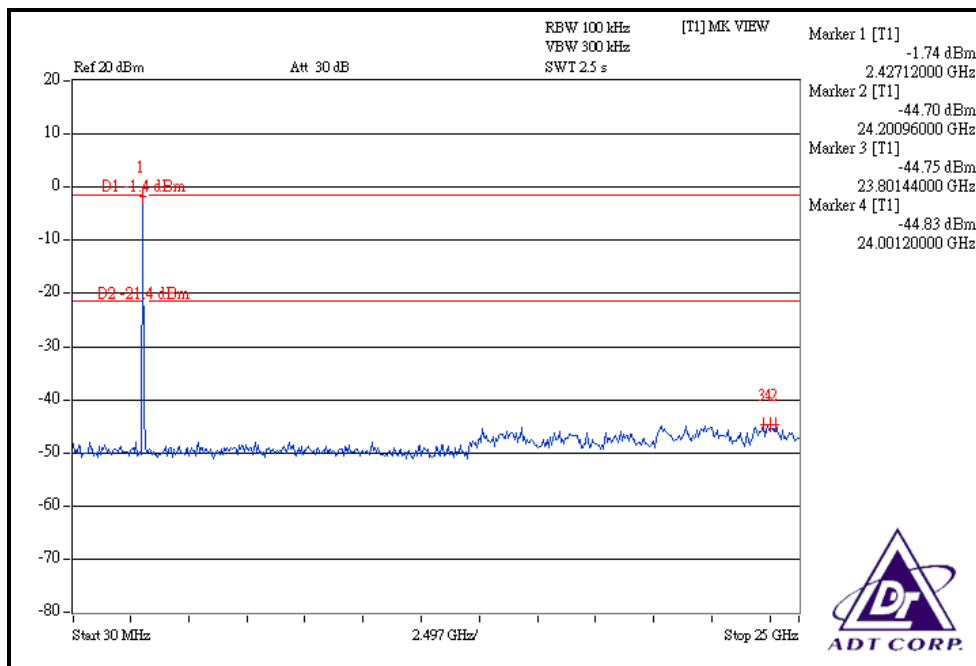
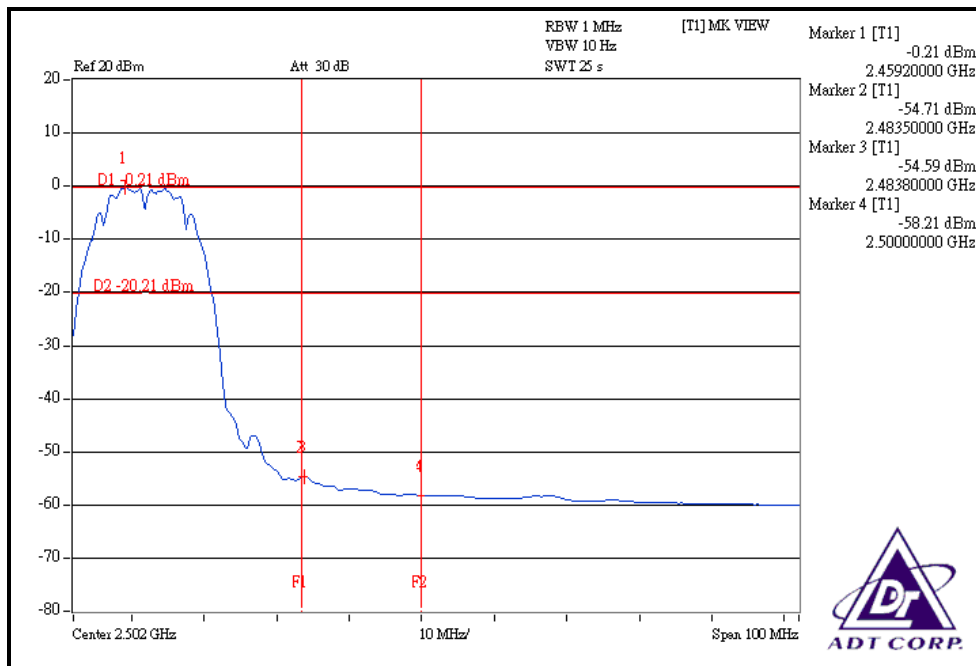

802.11g OFDM MODULATION

NOTE 1: The band edge emission plot on the next page shows 42.59dBc between carrier maximum power and local maximum emission in restrict band (2.34180GHz). The emission of carrier strength list in the test result of channel 1 at the item 4.2.7 is 96.49dBuV/m (Peak), so the maximum field strength in restrict band is $96.49 - 42.59 = 53.90$ dBuV/m which is under 74dBuV/m limit.

The band edge emission plot on the next page shows 51.81dBc between carrier maximum power and local maximum emission in restrict band (2.39000GHz). The emission of carrier strength list in the test result of channel 1 at the item 4.2.7 is 86.54dBuV/m (Average), so the maximum field strength in restrict band is $86.54 - 51.81 = 34.73$ dBuV/m which is under 54dBuV/m limit.

NOTE 2: The band edge emission plot on the next second page shows 41.89dBc between carrier maximum power and local maximum emission in restrict band (2.49320GHz). The emission of carrier strength list in the test result of channel 11 at the item 4.2.7 is 97.10dBuV/m (Peak), so the maximum field strength in restrict band is $97.10 - 41.89 = 55.21$ dBuV/m which is under 74dBuV/m limit.

The band edge emission plot on the next third page shows 50.43dBc between carrier maximum power and local maximum emission in restrict band (2.48350GHz). The emission of carrier strength list in the test result of channel 11 at the item 4.2.7 is 86.91dBuV/m (Average), so the maximum field strength in restrict band is $86.91 - 50.43 = 36.48$ dBuV/m which is under 54dBuV/m limit.

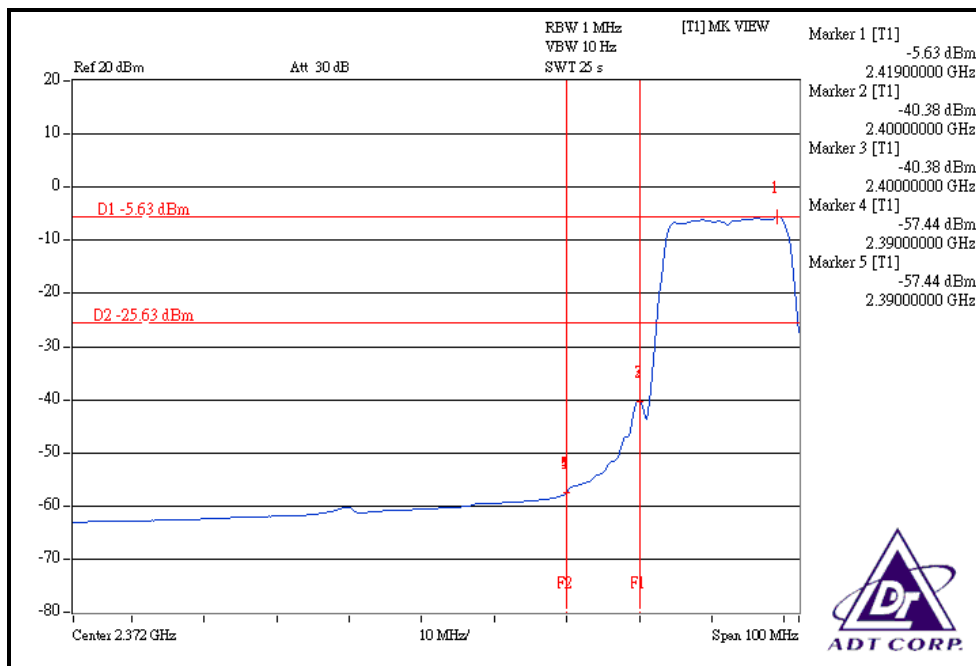
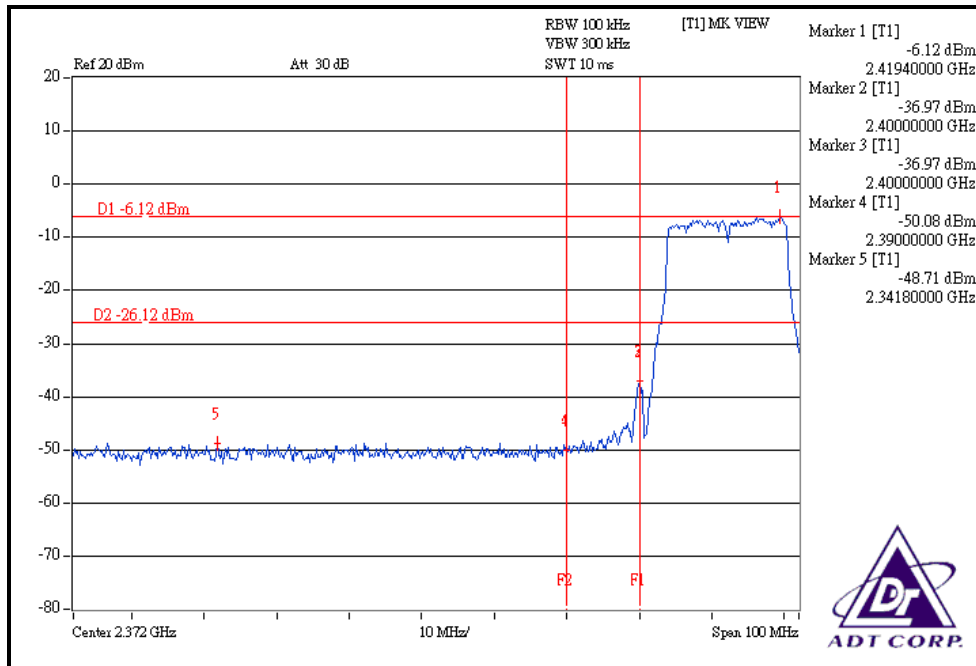

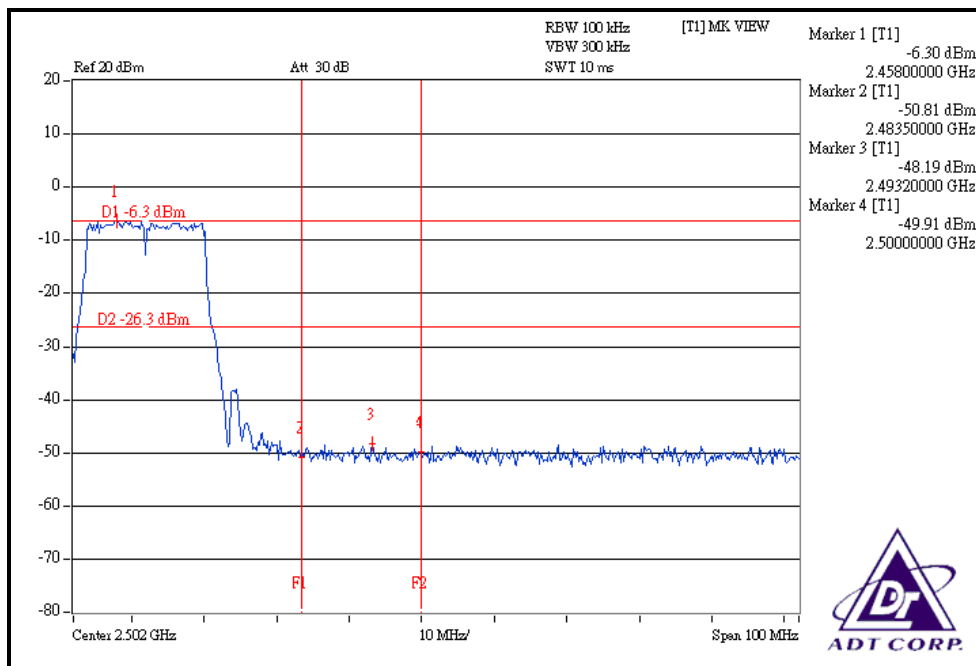
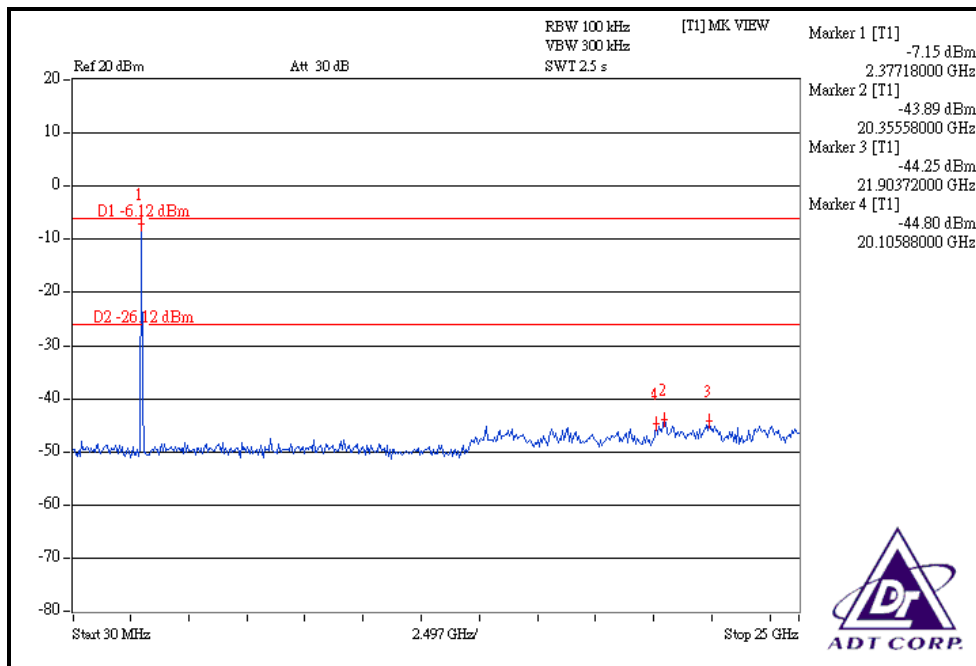

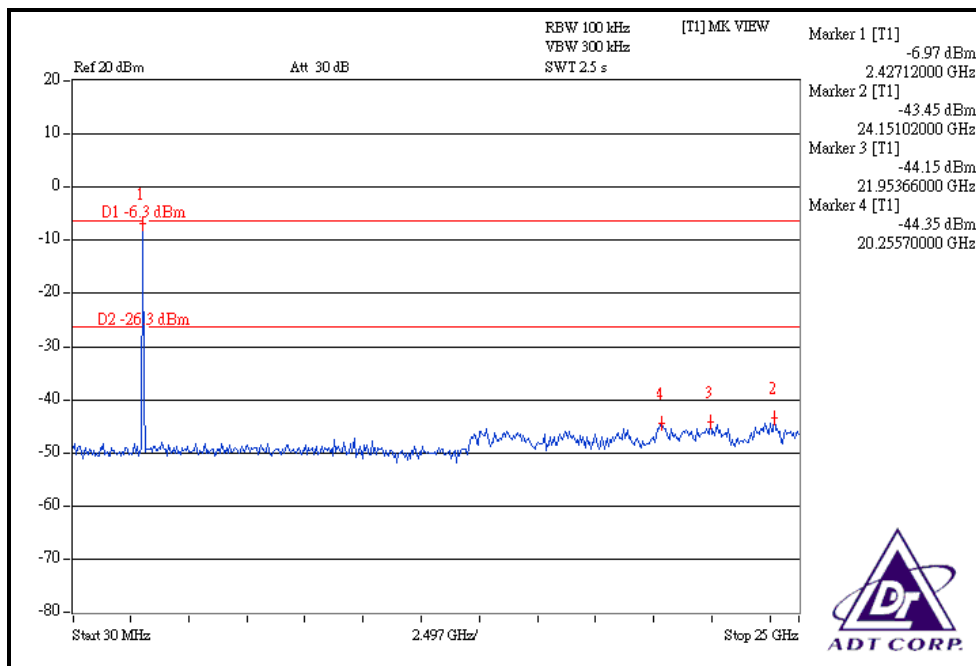
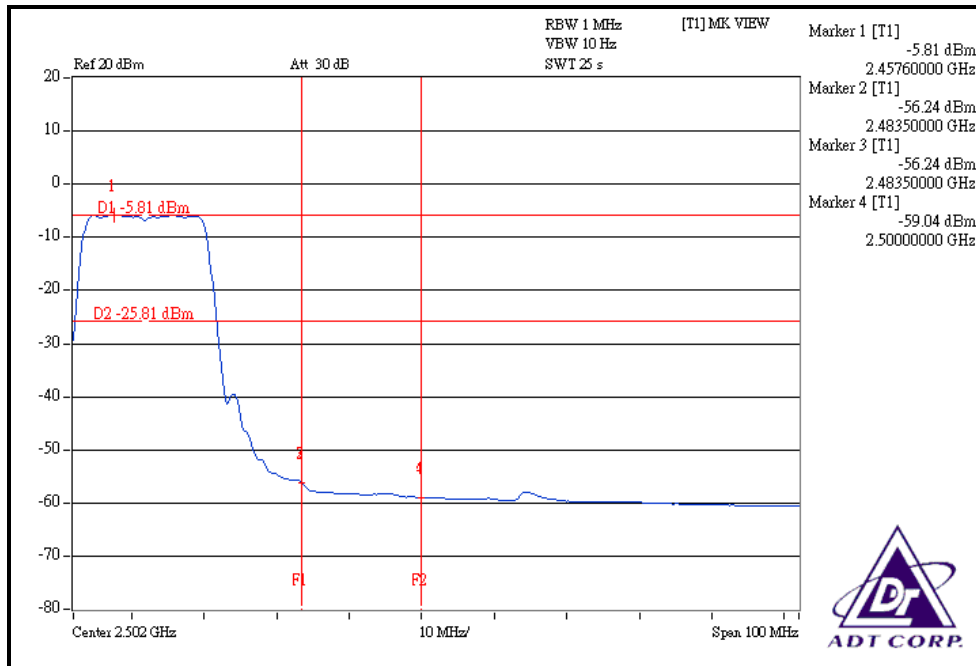

DRAFT 802.11n (20MHz) OFDM MODULATION

NOTE 1: The band edge emission plot on the next page shows 40.97dBc between carrier maximum power and local maximum emission in restrict band (2.37800GHz). The emission of carrier strength list in the test result of channel 1 at the item 4.2.7 is 96.85dBuV/m (Peak), so the maximum field strength in restrict band is $96.85 - 40.97 = 55.88$ dBuV/m which is under 74dBuV/m limit.

The band edge emission plot on the next page shows 49.72dBc between carrier maximum power and local maximum emission in restrict band (2.39000GHz). The emission of carrier strength list in the test result of channel 1 at the item 4.2.7 is 87.44dBuV/m (Average), so the maximum field strength in restrict band is $87.44 - 49.72 = 37.72$ dBuV/m which is under 54dBuV/m limit.

NOTE 2: The band edge emission plot on the next second page shows 42.44dBc between carrier maximum power and local maximum emission in restrict band (2.49440GHz) is 96.45dBuV/m (Peak), so the maximum field strength in restrict band is $96.45 - 42.44 = 54.01$ dBuV/m which is under 74dBuV/m limit.

The band edge emission plot on the next third page shows 48.81dBc between carrier maximum power and local maximum emission in restrict band (2.48350GHz). The emission of carrier strength list in the test result of channel 11 at the item 4.2.7 is 87.03dBuV/m (Average), so the maximum field strength in restrict band is $87.03 - 48.81 = 38.22$ dBuV/m which is under 54dBuV/m limit.

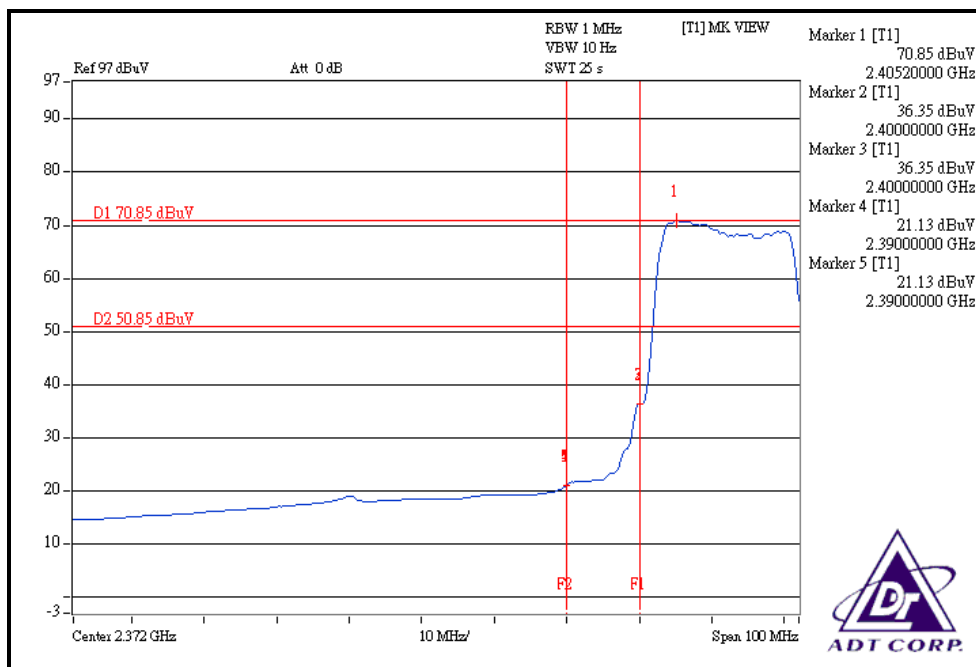
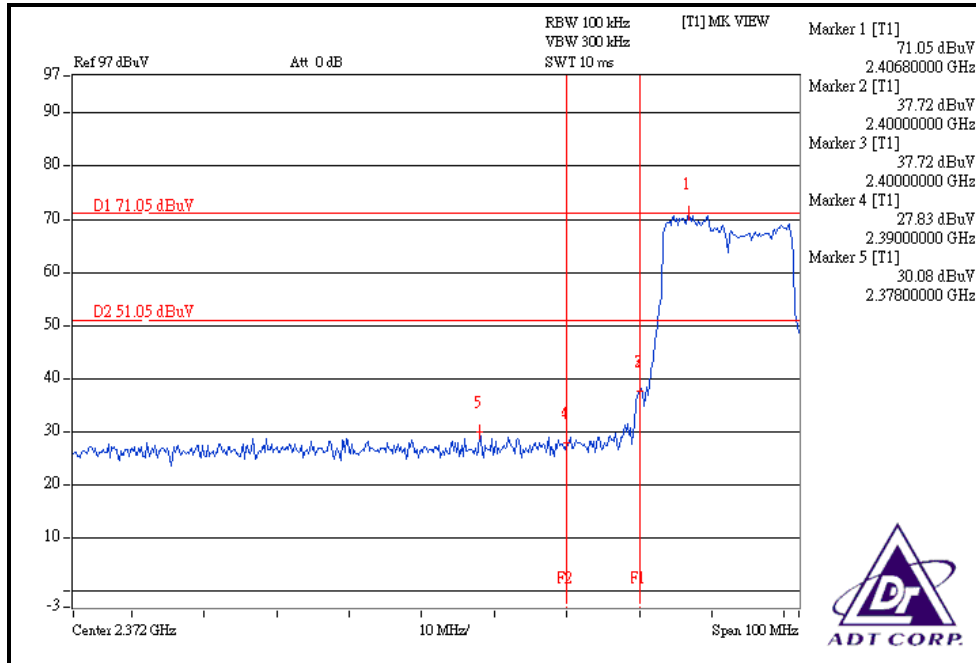

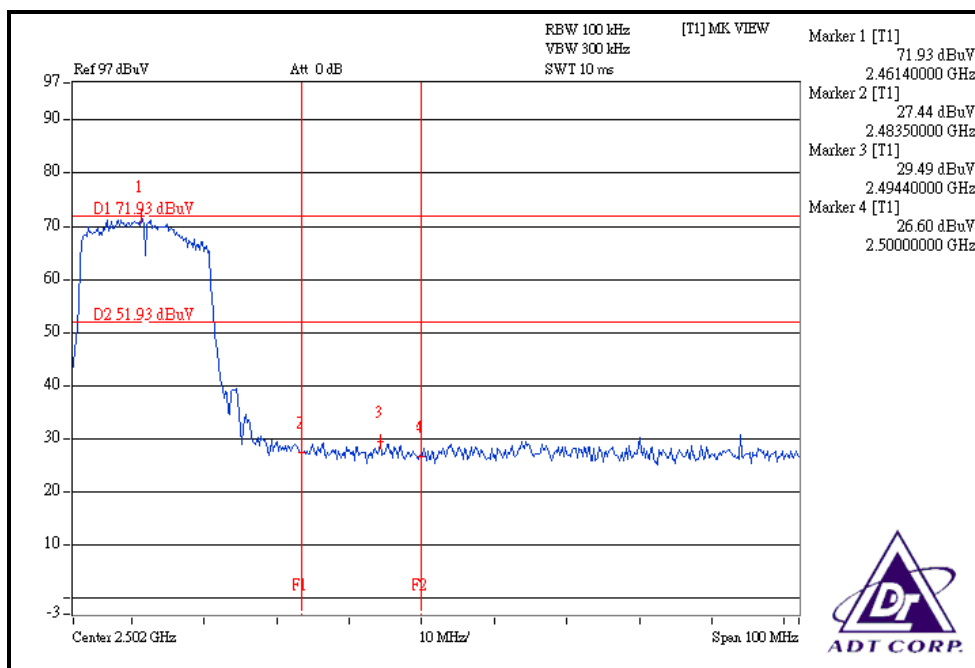
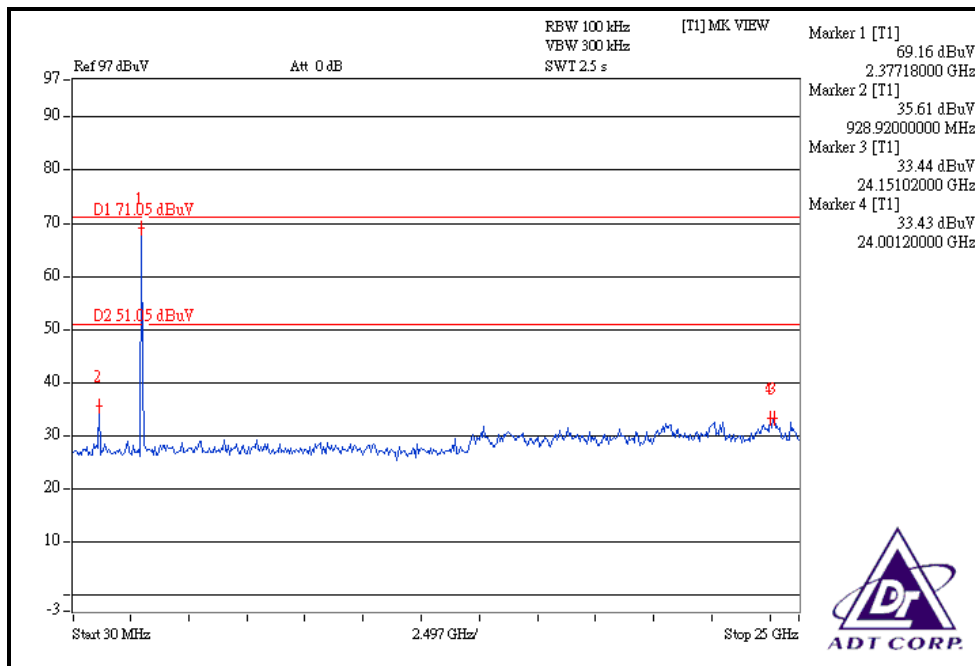

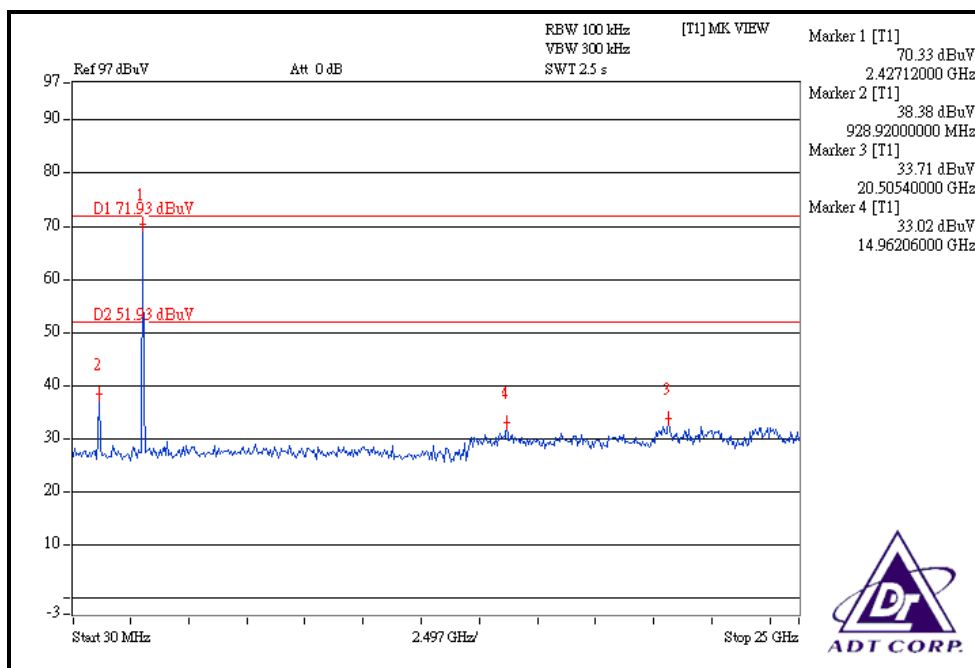
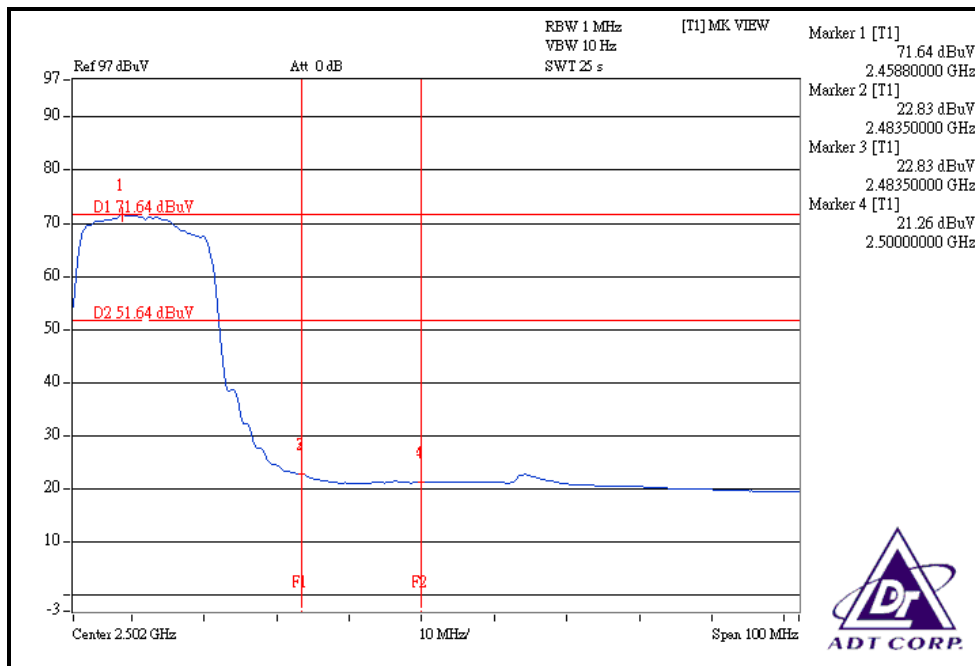

DRAFT 802.11n (40MHz) OFDM MODULATION

NOTE 1: The band edge emission plot on the next page shows 34.09dBc between carrier maximum power and local maximum emission in restrict band (2.38240GHz). The emission of carrier strength list in the test result of channel 1 at the item 4.2.7 is 95.03dBuV/m (Peak), so the maximum field strength in restrict band is $95.03 - 34.09 = 60.94$ dBuV/m which is under 74dBuV/m limit.

The band edge emission plot on the next page shows 44.65dBc between carrier maximum power and local maximum emission in restrict band (2.39000GHz). The emission of carrier strength list in the test result of channel 1 at the item 4.2.7 is 84.60dBuV/m (Average), so the maximum field strength in restrict band is $84.60 - 44.65 = 39.95$ dBuV/m which is under 54dBuV/m limit.

NOTE 2: The band edge emission plot on the next second page shows 33.76dBc between carrier maximum power and local maximum emission in restrict band (2.48960GHz). The emission of carrier strength list in the test result of channel 7 at the item 4.2.7 is 95.15dBuV/m (Peak), so the maximum field strength in restrict band is $95.15 - 33.76 = 61.39$ dBuV/m which is under 74dBuV/m limit.

The band edge emission plot on the next third page shows 43.30dBc between carrier maximum power and local maximum emission in restrict band (2.48440GHz). The emission of carrier strength list in the test result of channel 7 at the item 4.2.7 is 84.70dBuV/m (Average), so the maximum field strength in restrict band is $84.70 - 43.30 = 41.40$ dBuV/m which is under 54dBuV/m limit.

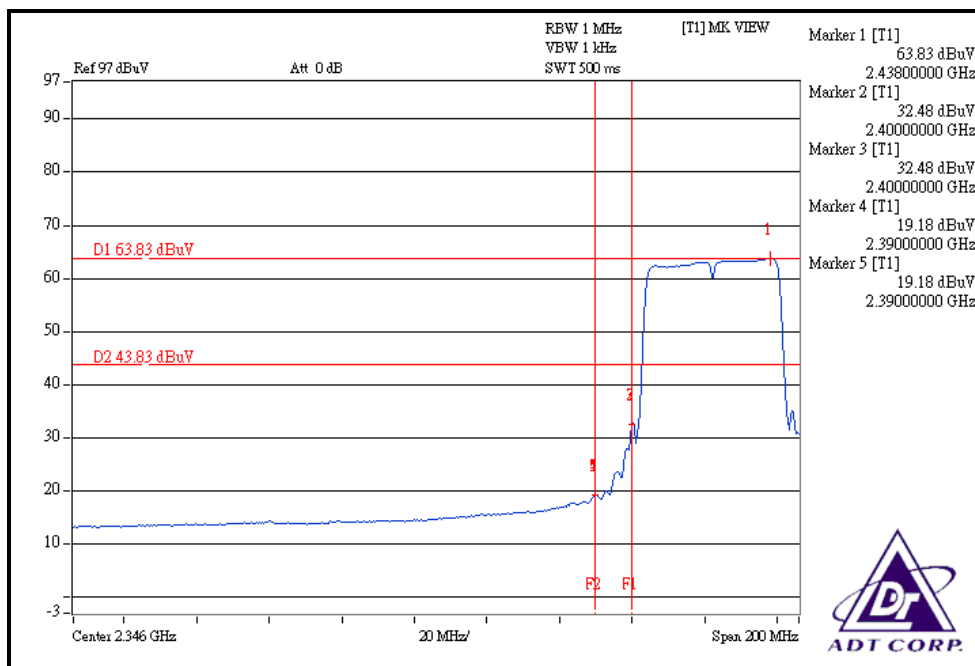
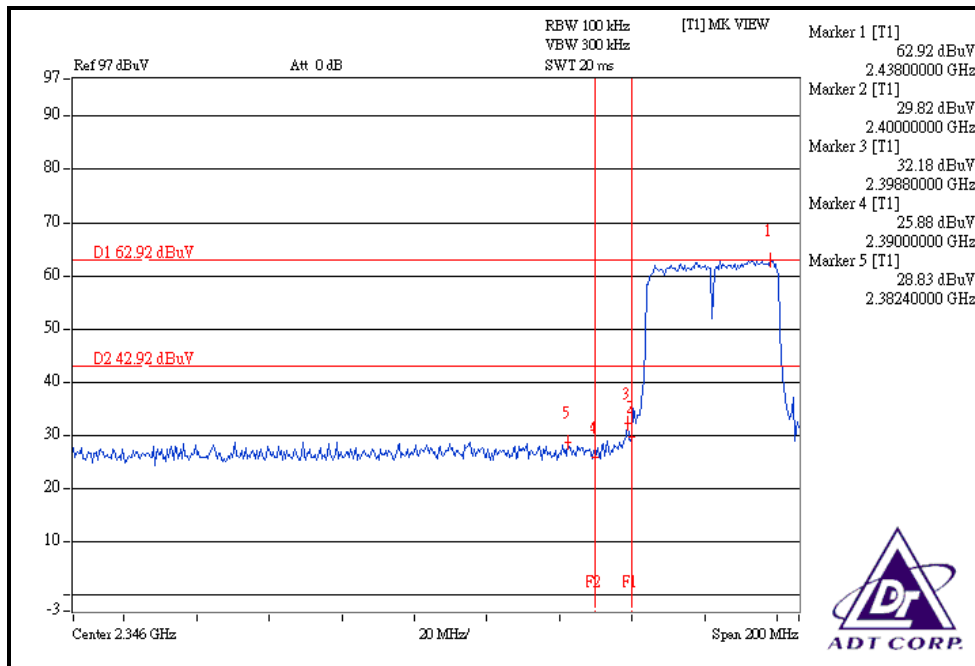

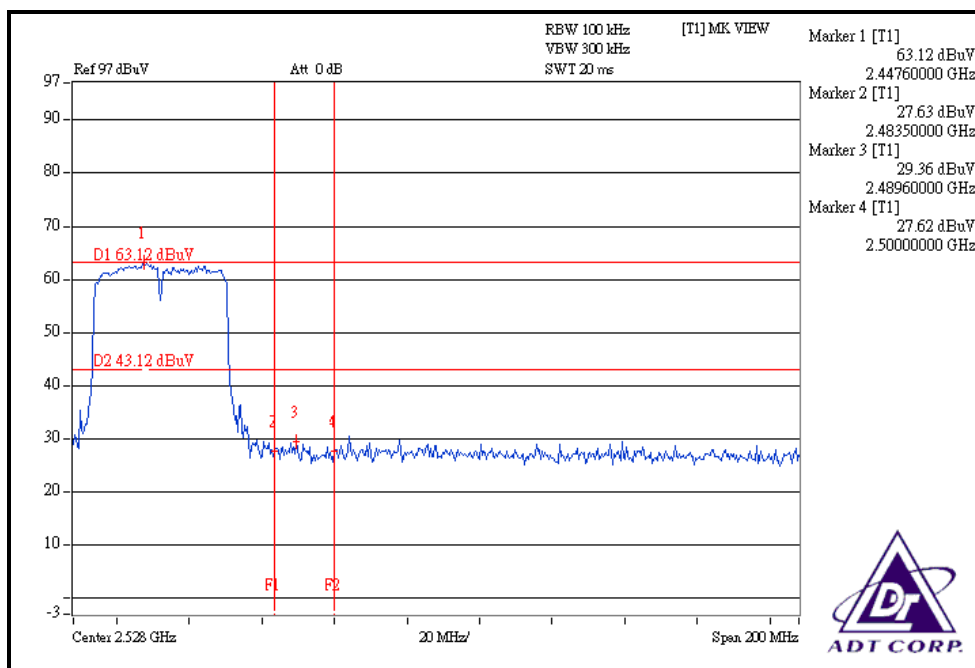
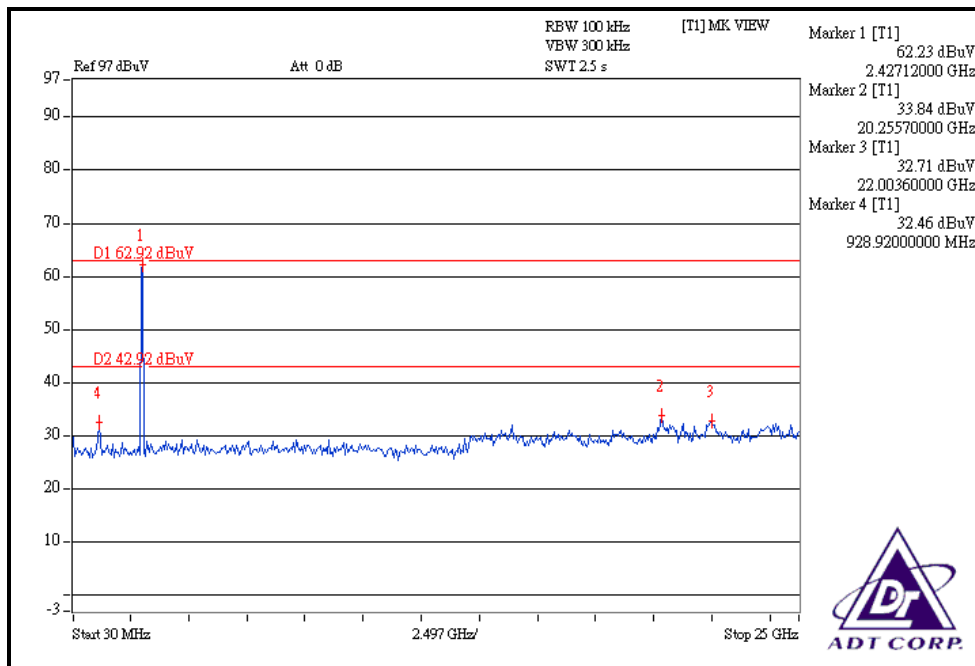

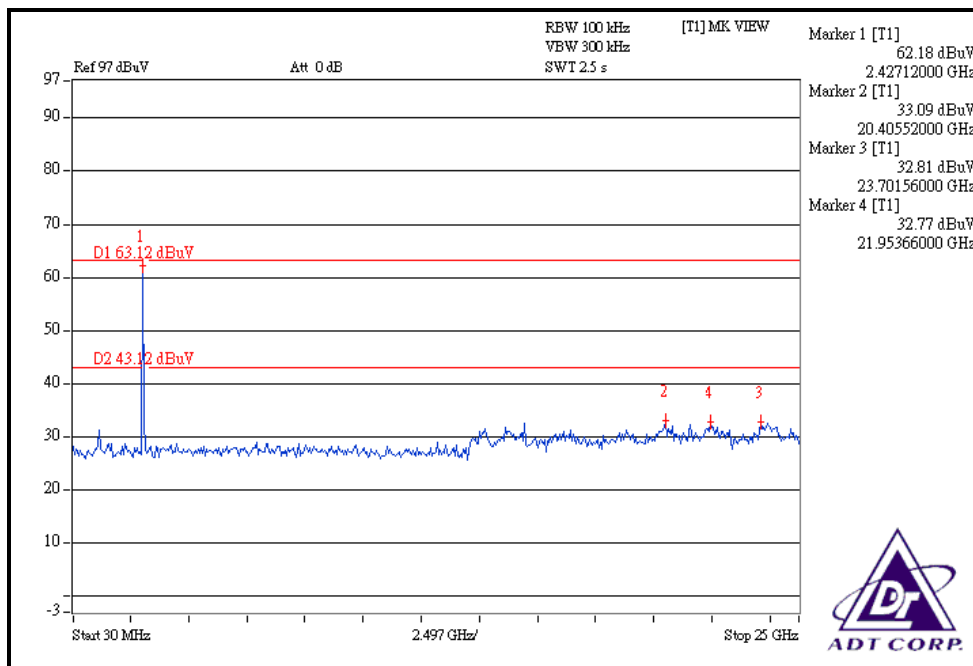
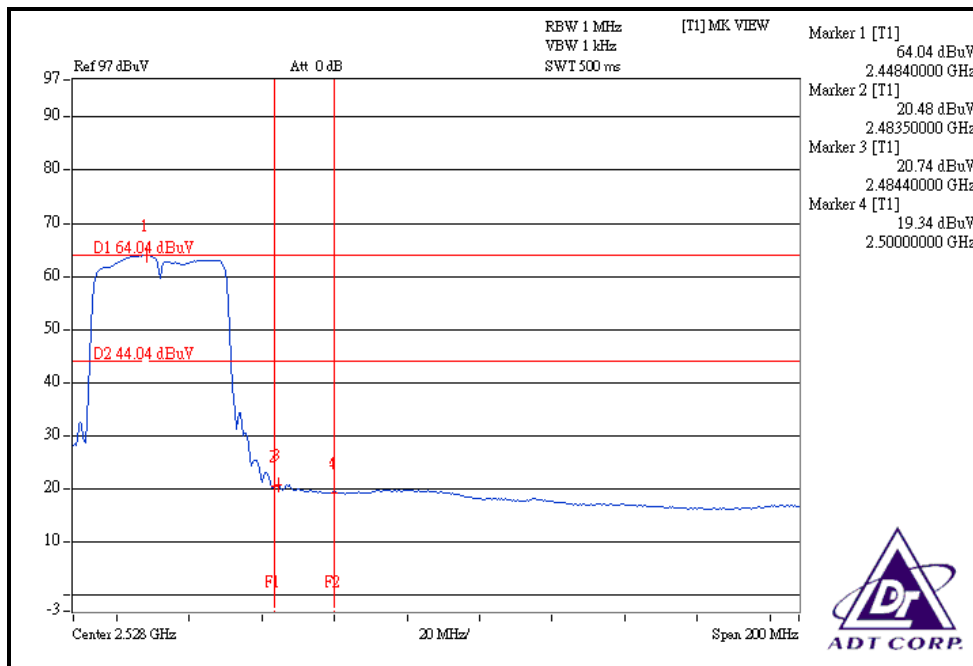

4.7 ANTENNA REQUIREMENT

4.7.1 STANDARD APPLICABLE

For intentional device, according to FCC 47 CFR Section 15.203, an intentional radiator shall be designed to ensure that no antenna other than that furnished by the responsible party shall be used with the device. And according to FCC 47 CFR Section 15.247 (b), if transmitting antennas of directional gain greater than 6dBi are used, the power shall be reduced by the amount in dB that the directional gain of the antenna exceeds 6dBi.

4.7.2 ANTENNA CONNECTED CONSTRUCTION

The antenna used in this product is printed antenna without antenna connector. The maximum Gain of the antenna is 1dBi.



6. INFORMATION ON THE TESTING LABORATORIES

We, ADT Corp., were founded in 1988 to provide our best service in EMC, Radio, Telecom and Safety consultation. Our laboratories are accredited and approved by the following approval agencies according to ISO/IEC 17025.

USA	FCC, UL, A2LA
Germany	TUV Rheinland
Japan	VCCI
Norway	NEMKO
Canada	INDUSTRY CANADA , CSA
R.O.C.	TAF, BSMI, NCC
Netherlands	Telefication
Singapore	PSB , GOST-ASIA(MOU)
Russia	CERTIS(MOU)

Copies of accreditation certificates of our laboratories obtained from approval agencies can be downloaded from our web site:

www.adt.com.tw/index.5/phtml. If you have any comments, please feel free to contact us at the following:

Linko EMC/RF Lab:

Tel: 886-2-26052180

Fax: 886-2-26051924

Hsin Chu EMC/RF Lab:

Tel: 886-3-5935343

Fax: 886-3-5935342

Hwa Ya EMC/RF/Safety Telecom Lab:

Tel: 886-3-3183232

Fax: 886-3-3185050

Web Site: www.adt.com.tw

The address and road map of all our labs can be found in our web site also.

7. APPENDIX A - MODIFICATIONS RECORDERS FOR ENGINEERING CHANGES TO THE EUT BY THE LAB

No any modifications are made to the EUT by the lab during the test.