

# FCC TEST REPORT

**REPORT NO.:** RF951121L11C

**MODEL NO.:** MXP802NPCM

**RECEIVED:** Nov. 21, 2006

**TESTED:** Jan. 23 ~ Feb. 13, 2007

**ISSUED:** Nov. 13, 2007

**APPLICANT:** Newer Technology, Inc.

**ADDRESS:** 1002 Courtaulds Drive, Woodstock, IL, United States, 60098

**ISSUED BY:** Advance Data Technology Corporation

**LAB ADDRESS:** 47 14<sup>th</sup> Lin, Chiapau Tsun, Linko, Taipei, Taiwan, R.O.C.

**TEST LOCATION:** No. 19, Hwa Ya 2<sup>nd</sup> Rd., Kueishan, Taoyuan, Taiwan, R.O.C.

This test report consists of 104 pages in total. It may be duplicated completely for legal use with the approval of the applicant. It should not be reproduced, except in full, without the written approval of our laboratory. The client should not use it to claim product endorsement by TAF, A2LA or any government agencies. The test results in the report only apply to the tested sample.



## TABLE OF CONTENTS

1.	CERTIFICATION .....	4
2.	SUMMARY OF TEST RESULTS .....	5
2.1	MEASUREMENT UNCERTAINTY .....	5
3.	GENERAL INFORMATION .....	6
3.1	GENERAL DESCRIPTION OF EUT .....	6
3.2	DESCRIPTION OF TEST MODES.....	7
3.2.1	CONFIGURATION OF SYSTEM UNDER TEST.....	7
3.2.2	TEST MODE APPLICABILITY AND TESTED CHANNEL DETAIL .....	8
3.3	GENERAL DESCRIPTION OF APPLIED STANDARDS.....	10
3.4	DESCRIPTION OF SUPPORT UNITS.....	10
4.	TEST TYPES AND RESULTS .....	11
4.1	CONDUCTED EMISSION MEASUREMENT .....	11
4.1.1	LIMITS OF CONDUCTED EMISSION MEASUREMENT .....	11
4.1.2	TEST INSTRUMENTS .....	11
4.1.3	TEST PROCEDURES .....	12
4.1.4	DEVIATION FROM TEST STANDARD .....	12
4.1.5	TEST SETUP.....	13
4.1.6	EUT OPERATING CONDITIONS.....	13
4.1.7	TEST RESULTS .....	14
4.2	RADIATED EMISSION MEASUREMENT .....	32
4.2.1	LIMITS OF RADIATED EMISSION MEASUREMENT .....	32
4.2.2	TEST INSTRUMENTS .....	33
4.2.3	TEST PROCEDURES .....	34
4.2.4	DEVIATION FROM TEST STANDARD .....	34
4.2.5	TEST SETUP.....	35
4.2.6	EUT OPERATING CONDITIONS.....	35
4.2.7	TEST RESULTS .....	36
4.3	6dB BANDWIDTH MEASUREMENT .....	51
4.3.1	LIMITS OF 6dB BANDWIDTH MEASUREMENT.....	51
4.3.2	TEST INSTRUMENTS .....	51
4.3.3	TEST PROCEDURE.....	51
4.3.4	DEVIATION FROM TEST STANDARD .....	51
4.3.5	TEST SETUP.....	52
4.3.6	EUT OPERATING CONDITIONS.....	52
4.3.7	TEST RESULTS .....	53
4.4	MAXIMUM PEAK OUTPUT POWER .....	65
4.4.1	LIMITS OF MAXIMUM PEAK OUTPUT POWER MEASUREMENT .....	65
4.4.2	INSTRUMENTS.....	65
4.4.3	TEST PROCEDURES .....	65



4.4.4	DEVIATION FROM TEST STANDARD .....	65
4.4.5	TEST SETUP.....	66
4.4.6	EUT OPERATING CONDITIONS.....	66
4.4.7	TEST RESULTS .....	67
4.5	POWER SPECTRAL DENSITY MEASUREMENT .....	69
4.5.1	LIMITS OF POWER SPECTRAL DENSITY MEASUREMENT.....	69
4.5.2	TEST INSTRUMENTS .....	69
4.5.3	TEST PROCEDURE.....	69
4.5.4	DEVIATION FROM TEST STANDARD .....	69
4.5.5	TEST SETUP.....	70
4.5.6	EUT OPERATING CONDITION .....	70
4.5.7	TEST RESULTS .....	71
4.6	BAND EDGES MEASUREMENT .....	83
4.6.1	LIMITS OF BAND EDGES MEASUREMENT .....	83
4.6.2	TEST INSTRUMENTS .....	83
4.6.3	TEST PROCEDURE.....	84
4.6.4	DEVIATION FROM TEST STANDARD .....	84
4.6.5	EUT OPERATING CONDITION .....	85
4.6.6	TEST RESULTS .....	85
4.7	ANTENNA REQUIREMENT .....	101
4.7.1	STANDARD APPLICABLE .....	101
4.7.2	ANTENNA CONNECTED CONSTRUCTION.....	101
5.	PHOTOGRAPHS OF THE TEST CONFIGURATION.....	102
6.	INFORMATION ON THE TESTING LABORATORIES .....	103
7.	APPENDIX-A MODIFICATIONS RECORDERS FOR ENGINEERING CHANGES TO THE EUT BY THE LAB .....	104



# 1. CERTIFICATION

**PRODUCT :** Wireless-N Notebook Adapter  
**MODEL NO.:** MXP802NPCM  
**BRAND:** MaxPower  
**APPLICANT :** Newer Technology, Inc.  
**TESTED:** Jan. 23 ~ Feb. 13, 2007  
**TEST SAMPLE:** ENGINEERING SAMPLE  
**STANDARDS :** **FCC Part 15, Subpart C (Section 15.247)**  
ANSI C63.4-2003

The above equipment (model: MXP802NPCM) has been tested by **Advance Data Technology Corporation**, and found compliance with the requirement of the above standards. The test record, data evaluation & Equipment Under Test (EUT) configurations represented herein are true and accurate accounts of the measurements of the sample's EMC characteristics under the conditions specified in this report.

**PREPARED BY :** Ivy Lin , **DATE:** Nov. 13, 2007  
Ivy Lin / Specialist

**TECHNICAL ACCEPTANCE :** Long Chen , **DATE:** Nov. 13, 2007  
Responsible for RF Long Chen / Senior Engineer

**APPROVED BY :** Gary Chang , **DATE:** Nov. 13, 2007  
Gary Chang / Assistant Manager

## 2. SUMMARY OF TEST RESULTS

The EUT has been tested according to the following specifications:

APPLIED STANDARD: FCC Part 15, Subpart C			
STANDARD SECTION	TEST TYPE AND LIMIT	RESULT	REMARK
15.207	AC Power Conducted Emission	PASS	Meet the requirement of limit. Minimum passing margin is -14.20dB at 0.176MHz.
15.247(a)(2)	Spectrum Bandwidth of a Direct Sequence Spread Spectrum System Limit : min. 500kHz	PASS	Meet the requirement of limit.
15.247(b)	Maximum Peak Output Power Limit: max. 30dBm	PASS	Meet the requirement of limit.
15.247(d)	Transmitter Radiated Emissions Limit: Table 15.209	PASS	Meet the requirement of limit. Minimum passing margin is -1.16dB at 2390.00MHz.
15.247(e)	Power Spectral Density Limit: max. 8dBm	PASS	Meet the requirement of limit.
15.247(d)	Band Edge Measurement Limit: 20dB less than the peak value of fundamental frequency	PASS	Meet the requirement of limit.

### 2.1 MEASUREMENT UNCERTAINTY

Where relevant, the following measurement uncertainty levels have been estimated for tests performed on the EUT as specified in CISPR 16-4-2:

MEASUREMENT	FREQUENCY	UNCERTAINTY
Conducted emissions	9kHz ~ 30MHz	2.44dB
Radiated emissions	30MHz ~ 200MHz	3.59 dB
	200MHz ~ 1000MHz	3.61 dB
	1GHz ~ 18GHz	2.26 dB
	18GHz ~ 40GHz	1.94 dB

This uncertainty represents an expanded uncertainty expressed at approximately the 95% confidence level using a coverage factor of  $k = 2$ .

### 3. GENERAL INFORMATION

#### 3.1 GENERAL DESCRIPTION OF EUT

<b>PRODUCT</b>	Wireless-N Notebook Adapter
<b>MODEL NO.</b>	MXP802NPCM
<b>FCC ID</b>	UNH-MXP802NPCM
<b>POWER SUPPLY</b>	3.3Vdc from host equipment
<b>MODULATION TYPE</b>	CCK, DQPSK, DBPSK for DSSS 64QAM, 16QAM, QPSK, BPSK for OFDM
<b>MODULATION TECHNOLOGY</b>	DSSS, OFDM
<b>TRANSFER RATE</b>	802.11b: 11.0/ 5.5/ 2.0/ 1.0Mbps 802.11g: 54.0/ 48.0/ 36.0/ 24.0/ 18.0/ 12.0/ 9.0/ 6.0Mbps Draft 802.11n (20MHz): 144.44/ 130.00/ 115.56/ 86.67/ 57.78/ 43.33/ 28.89/ 14.44/ 72.2/ 65.0/ 57.8/ 43.3/ 28.9/ 21.7/ 14.4/ 7.2Mbps Draft 802.11n (40MHz): 300.0/ 270.0/ 240.0/ 180.0/ 120.0/ 90.0/ 60.0/ 30.0/ 150.0/ 135.0/ 120.0/ 90.0/ 60.0/ 45.0/ 30.0/ 15.0Mbps
<b>FREQUENCY RANGE</b>	2412MHz ~ 2462MHz
<b>NUMBER OF CHANNEL</b>	11 for 802.11b, 802.11g, Draft 802.11n (20MHz) 7 for Draft 802.11n (40MHz)
<b>MAXIMUM OUTPUT POWER</b>	81.576mW
<b>ANTENNA TYPE</b>	Printed Dipole antenna with 1dBi gain
<b>DATA CABLE</b>	NA
<b>I/O PORTS</b>	NA
<b>ACCESSORY DEVICE</b>	NA

**NOTE:**

1. This is a duplicate report of RF951121L11B, the difference are changing applicant, brand name and model name.
2. The EUT incorporates a MIMO function. Physically, the card provides two completed transmitters and three receivers.
3. The EUT is 2 \* 3 spatial MIMO (2Tx & 3Rx) without beam forming function that only operate dual chain configuration (chain 0 and chain 1 transceivers are operational).
4. When the EUT operating in 802.11b and 802.11g is for single Tx.
5. When the EUT operating in draft 802.11n, the software operation, which is defined by manufacturer, only set 0 ~ 15 of "MCS" (MCS: Modulation and Coding Schemes) for dual Tx.
6. The EUT complies with draft 802.11n standards and backwards compatible with 802.11b, 802.11g products.
7. The EUT operates in the 2.4GHz frequency spectrum with throughput of up to 300Mbps.
8. The above EUT information was declared by manufacturer and for more detailed features description, please refer to the manufacturer's specifications or user's manual.

### 3.2 DESCRIPTION OF TEST MODES

Eleven channels are provided for 802.11b, 802.11g, draft 802.11n (20MHz):

CHANNEL	FREQUENCY	CHANNEL	FREQUENCY
1	2412MHz	7	2442MHz
2	2417MHz	8	2447MHz
3	2422MHz	9	2452MHz
4	2427MHz	10	2457MHz
5	2432MHz	11	2462MHz
6	2437MHz		

Seven channels are provided for draft 802.11n (40MHz):

CHANNEL	FREQUENCY	CHANNEL	FREQUENCY
1	2422MHz	5	2442MHz
2	2427MHz	6	2447MHz
3	2432MHz	7	2452MHz
4	2437MHz		

#### 3.2.1 CONFIGURATION OF SYSTEM UNDER TEST

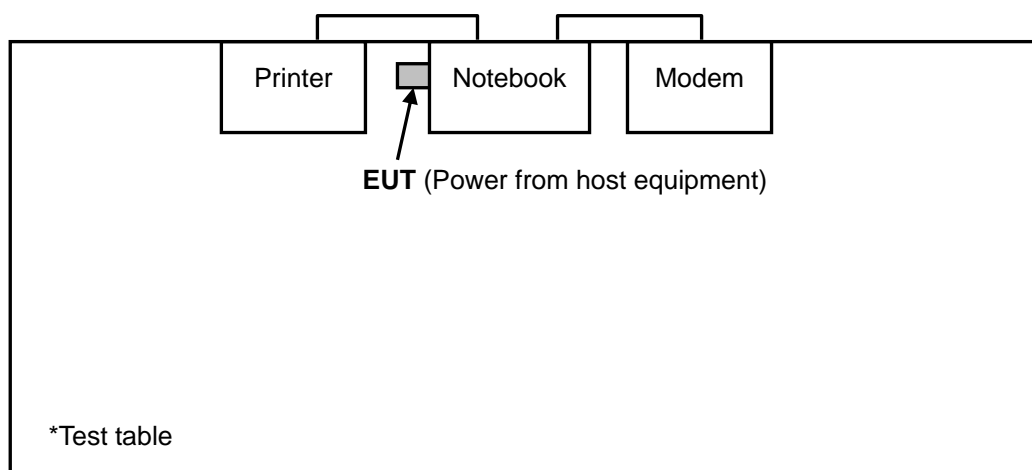

### 3.2.2 TEST MODE APPLICABILITY AND TESTED CHANNEL DETAIL

EUT CONFIGURE MODE	APPLICABLE TO				DESCRIPTION
	PLC	RE < 1G	RE ≥ 1G	APCM	
-	√	√	√	√	-

Where **PLC**: Power Line Conducted Emission      **RE < 1G**: Radiated Emission below 1GHz  
**RE ≥ 1G**: Radiated Emission above 1GHz      **APCM**: Antenna Port Conducted Measurement

#### **POWER LINE CONDUCTED EMISSION TEST:**

- Pre-Scan has been conducted to determine the worst-case mode from all possible combinations between available modulations, data rates and antenna ports (if EUT with antenna diversity architecture).
- Following channel(s) was (were) selected for the final test as listed below.

MODE	AVAILABLE CHANNEL	TESTED CHANNEL	MODULATION TECHNOLOGY	MODULATION TYPE	DATA RATE (Mbps)
802.11g	1 to 11	1, 6, 11	OFDM	BPSK	6.0
Draft 802.11n (20MHz)	1 to 11	1, 6, 11	OFDM	BPSK	7.2
Draft 802.11n (40MHz)	1 to 7	1, 4, 7	OFDM	BPSK	15.0

#### **RADIATED EMISSION TEST (BELOW 1 GHz):**

- Pre-Scan has been conducted to determine the worst-case mode from all possible combinations between available modulations, data rates and antenna ports (if EUT with antenna diversity architecture).
- Following channel(s) was (were) selected for the final test as listed below.

MODE	AVAILABLE CHANNEL	TESTED CHANNEL	MODULATION TECHNOLOGY	MODULATION TYPE	DATA RATE (Mbps)
802.11g	1 to 11	1	OFDM	BPSK	6.0
Draft 802.11n (20MHz)	1 to 11	1	OFDM	BPSK	7.2
Draft 802.11n (40MHz)	1 to 7	1	OFDM	BPSK	15.0



**RADIATED EMISSION TEST (ABOVE 1 GHz):**

- Pre-Scan has been conducted to determine the worst-case mode from all possible combinations between available modulations, data rates and antenna ports (if EUT with antenna diversity architecture).
- Following channel(s) was (were) selected for the final test as listed below.

MODE	AVAILABLE CHANNEL	TESTED CHANNEL	MODULATION TECHNOLOGY	MODULATION TYPE	DATA RATE (Mbps)
802.11b	1 to 11	1, 6, 11	DSSS	DBPSK	1.0
802.11g	1 to 11	1, 6, 11	OFDM	BPSK	6.0
Draft 802.11n (20MHz)	1 to 11	1, 6, 11	OFDM	BPSK	7.2
Draft 802.11n (40MHz)	1 to 7	1, 4, 7	OFDM	BPSK	15.0

**BANDEDGE MEASUREMENT:**

- Pre-Scan has been conducted to determine the worst-case mode from all possible combinations between available modulations, data rates and antenna ports (if EUT with antenna diversity architecture).
- Following channel(s) was (were) selected for the final test as listed below.

MODE	AVAILABLE CHANNEL	TESTED CHANNEL	MODULATION TECHNOLOGY	MODULATION TYPE	DATA RATE (Mbps)
802.11b	1 to 11	1, 11	DSSS	DBPSK	1.0
802.11g	1 to 11	1, 11	OFDM	BPSK	6.0
Draft 802.11n (20MHz)	1 to 11	1, 11	OFDM	BPSK	7.2
Draft 802.11n (40MHz)	1 to 7	1, 7	OFDM	BPSK	15.0

**ANTENNA PORT CONDUCTED MEASUREMENT:**

- Pre-Scan has been conducted to determine the worst-case mode from all possible combinations between available modulations, data rates and antenna ports (if EUT with antenna diversity architecture).
- Following channel(s) was (were) selected for the final test as listed below.

MODE	AVAILABLE CHANNEL	TESTED CHANNEL	MODULATION TECHNOLOGY	MODULATION TYPE	DATA RATE (Mbps)
802.11b	1 to 11	1, 6, 11	DSSS	DBPSK	1.0
802.11g	1 to 11	1, 6, 11	OFDM	BPSK	6.0
Draft 802.11n (20MHz)	1 to 11	1, 6, 11	OFDM	BPSK	7.2
Draft 802.11n (40MHz)	1 to 7	1, 4, 7	OFDM	BPSK	15.0

### 3.3 GENERAL DESCRIPTION OF APPLIED STANDARDS

The EUT is a RF product. According to the specifications of the manufacturer, it must comply with the requirements of the following standards:

#### FCC Part 15, Subpart C. (15.247)

#### ANSI C63.4-2003

All test items have been performed and recorded as per the above standards.

**NOTE:** The EUT is also considered as a kind of computer peripheral, because the connection to computer is necessary for typical use. It has been verified to comply with the requirements of FCC Part 15, Subpart B, Class B (DoC). The test report has been issued separately.

### 3.4 DESCRIPTION OF SUPPORT UNITS

The EUT has been tested as an independent unit together with other necessary accessories or support units. The following support units or accessories were used to form a representative test configuration during the tests.

NO.	PRODUCT	BRAND	MODEL NO.	SERIAL NO.	FCC ID
1	NOTEBOOK COMPUTER	DELL	PP05L	9954115984	E2K24CLNS
2	MODEM	ACEEX	1414V/3	0401008260	IFAXDM1414
3	PRINTER	EPSON	LQ-300+	DCGY054146	FCC DoC Approved

NO.	SIGNAL CABLE DESCRIPTION OF THE ABOVE SUPPORT UNITS
1	NA
2	1.2 m shielded cable
3	1.2 m shielded cable

**NOTE:** All power cords of the above support units are non shielded (1.8m).

## 4. TEST TYPES AND RESULTS

### 4.1 CONDUCTED EMISSION MEASUREMENT

#### 4.1.1 LIMITS OF CONDUCTED EMISSION MEASUREMENT

FREQUENCY OF EMISSION (MHz)	CONDUCTED LIMIT (dB $\mu$ V)	
	Quasi-peak	Average
0.15-0.5	66 to 56	56 to 46
0.5-5	56	46
5-30	60	50

- NOTE:**
1. The lower limit shall apply at the transition frequencies.
  2. The limit decreases in line with the logarithm of the frequency in the range of 0.15 to 0.50 MHz.
  3. All emanations from a class A/B digital device or system, including any network of conductors and apparatus connected thereto, shall not exceed the level of field strengths specified above.

#### 4.1.2 TEST INSTRUMENTS

DESCRIPTION & MANUFACTURER	MODEL NO.	SERIAL NO.	CALIBRATED UNTIL
Test Receiver ROHDE & SCHWARZ	ESCS30	100288	Sep. 25, 2007
RF signal cable Woken	5D-FB	Cable-HYCO3-01	Jan. 06, 2008
LISN ROHDE & SCHWARZ	ESH2-Z5	100100	Jan. 08, 2008
LISN ROHDE & SCHWARZ	ESH3-Z5	100311	Jan. 16, 2008
Software ADT	ADT_Cond_V3	NA	NA

- NOTE:**
1. The calibration interval of the above test instruments is 12 months and the calibrations are traceable to NML/ROC and NIST/USA.
  2. The test was performed in HwaYa Shielded Room 2.
  3. The VCCI Site Registration No. is C-2047.

#### 4.1.3 TEST PROCEDURES

- a. The EUT was placed 0.4 meters from the conducting wall of the shielded room with EUT being connected to the power mains through a line impedance stabilization network (LISN). Other support units were connected to the power mains through another LISN. The two LISNs provide 50 ohm/ 50uH of coupling impedance for the measuring instrument.
- b. Both lines of the power mains connected to the EUT were checked for maximum conducted interference.
- c. The frequency range from 150kHz to 30MHz was searched. Emission levels under (Limit - 20dB) was not recorded.

#### 4.1.4 DEVIATION FROM TEST STANDARD

No deviation

#### 4.1.5 TEST SETUP

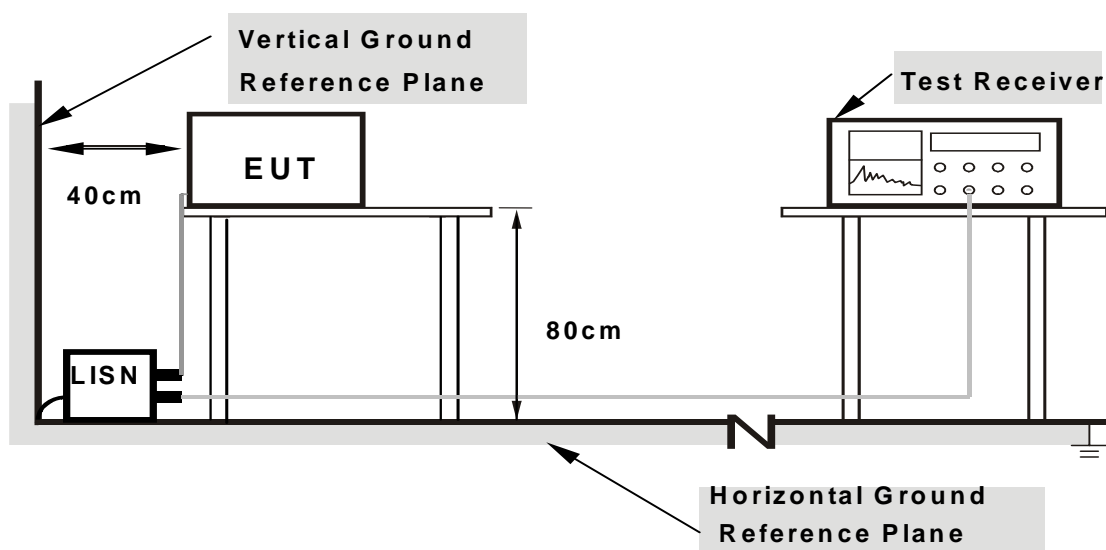

**Note: 1.Support units were connected to second LISN.**

**2.Both of LISNs (AMN) are 80 cm from EUT and at least 80 from other units and other metal planes**

For the actual test configuration, please refer to the attached file (Test Setup Photo).

#### 4.1.6 EUT OPERATING CONDITIONS

- a. Plugged EUT into notebook system and placed on the test table.
- b. The notebook system ran a test program (provided by manufacturer) to enable EUT under transmission condition continuously at specific channel frequency.
- c. The necessary accessories enable the system in full functions.

#### 4.1.7 TEST RESULTS

##### CONDUCTED WORST-CASE DATA: 802.11g OFDM MODULATION:

EUT TEST CONDITION		MEASUREMENT DETAIL	
CHANNEL	Channel 1	PHASE	Line 1
MODULATION TYPE	BPSK	6dB BANDWIDTH	9 kHz
TRANSFER RATE	6.0Mbps	INPUT POWER (SYSTEM)	120Vac, 60 Hz
ENVIRONMENTAL CONDITIONS	22deg. C, 60% RH, 991hPa	TESTED BY	Dean Wang

No	Freq. [MHz]	Corr. Factor (dB)	Reading Value [dB (uV)]		Emission Level [dB (uV)]		Limit [dB (uV)]		Margin (dB)	
			Q.P.	AV.	Q.P.	AV.	Q.P.	AV.	Q.P.	AV.
1	0.177	0.10	49.89	-	49.99	-	64.61	54.61	-14.62	-
2	0.271	0.10	37.70	-	37.80	-	61.09	51.09	-23.29	-
3	0.627	0.10	32.58	-	32.68	-	56.00	46.00	-23.32	-
4	2.168	0.23	30.19	-	30.42	-	56.00	46.00	-25.58	-
5	10.395	0.34	32.59	-	32.93	-	60.00	50.00	-27.07	-
6	17.227	0.52	26.11	-	26.63	-	60.00	50.00	-33.37	-

- REMARKS:**
1. Q.P. and AV. are abbreviations of quasi-peak and average individually.
  2. "-": The Quasi-peak reading value also meets average limit and measurement with the average detector is unnecessary.
  3. The emission levels of other frequencies were very low against the limit.
  4. Margin value = Emission level - Limit value
  5. Correction factor = Insertion loss + Cable loss
  6. Emission Level = Correction Factor + Reading Value.

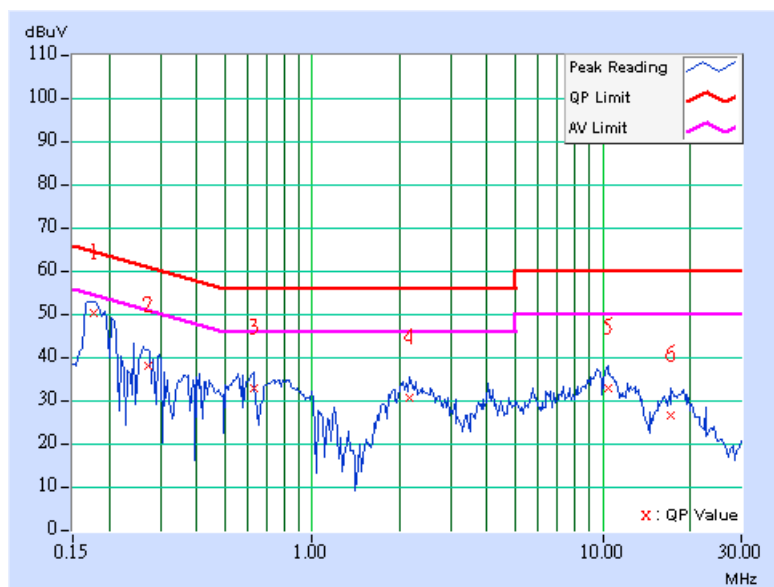

EUT TEST CONDITION		MEASUREMENT DETAIL	
CHANNEL	Channel 1	PHASE	Line 2
MODULATION TYPE	BPSK	6dB BANDWIDTH	9 kHz
TRANSFER RATE	6.0Mbps	INPUT POWER (SYSTEM)	120Vac, 60 Hz
ENVIRONMENTAL CONDITIONS	22deg. C, 60% RH, 991hPa	TESTED BY	Dean Wang

No	Freq. [MHz]	Corr. Factor (dB)	Reading Value [dB (uV)]		Emission Level [dB (uV)]		Limit [dB (uV)]		Margin (dB)	
			Q.P.	AV.	Q.P.	AV.	Q.P.	AV.	Q.P.	AV.
1	0.176	0.10	50.38	-	50.48	-	64.68	54.68	-14.20	-
2	0.264	0.10	38.30	-	38.40	-	61.29	51.29	-22.89	-
3	0.630	0.14	31.61	-	31.75	-	56.00	46.00	-24.25	-
4	1.980	0.22	29.27	-	29.49	-	56.00	46.00	-26.51	-
5	10.152	0.43	33.18	-	33.61	-	60.00	50.00	-26.39	-
6	19.520	0.56	25.33	-	25.89	-	60.00	50.00	-34.11	-

- REMARKS:**
1. Q.P. and AV. are abbreviations of quasi-peak and average individually.
  2. "-": The Quasi-peak reading value also meets average limit and measurement with the average detector is unnecessary.
  3. The emission levels of other frequencies were very low against the limit.
  4. Margin value = Emission level - Limit value
  5. Correction factor = Insertion loss + Cable loss
  6. Emission Level = Correction Factor + Reading Value.

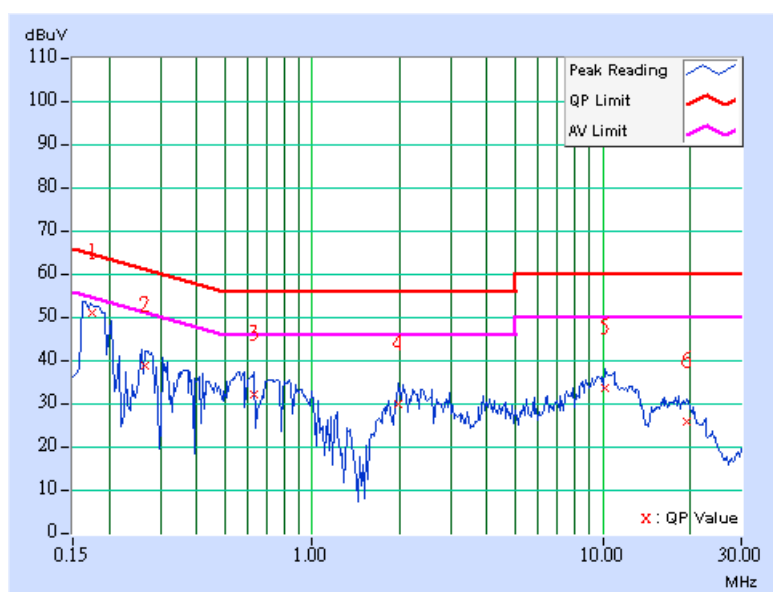

EUT TEST CONDITION		MEASUREMENT DETAIL	
CHANNEL	Channel 6	PHASE	Line 1
MODULATION TYPE	BPSK	6dB BANDWIDTH	9 kHz
TRANSFER RATE	6.0Mbps	INPUT POWER (SYSTEM)	120Vac, 60 Hz
ENVIRONMENTAL CONDITIONS	22deg. C, 60% RH, 991hPa	TESTED BY	Dean Wang

No	Freq. [MHz]	Corr. Factor (dB)	Reading Value [dB (uV)]		Emission Level [dB (uV)]		Limit [dB (uV)]		Margin (dB)	
			Q.P.	AV.	Q.P.	AV.	Q.P.	AV.	Q.P.	AV.
1	0.181	0.10	49.30	-	49.40	-	64.43	54.43	-15.03	-
2	0.275	0.10	38.85	-	38.95	-	60.97	50.97	-22.02	-
3	0.630	0.10	31.09	-	31.19	-	56.00	46.00	-24.81	-
4	2.152	0.22	30.35	-	30.57	-	56.00	46.00	-25.43	-
5	9.914	0.33	32.33	-	32.66	-	60.00	50.00	-27.34	-
6	12.844	0.42	29.32	-	29.74	-	60.00	50.00	-30.26	-

- REMARKS:**
1. Q.P. and AV. are abbreviations of quasi-peak and average individually.
  2. "-": The Quasi-peak reading value also meets average limit and measurement with the average detector is unnecessary.
  3. The emission levels of other frequencies were very low against the limit.
  4. Margin value = Emission level - Limit value
  5. Correction factor = Insertion loss + Cable loss
  6. Emission Level = Correction Factor + Reading Value.

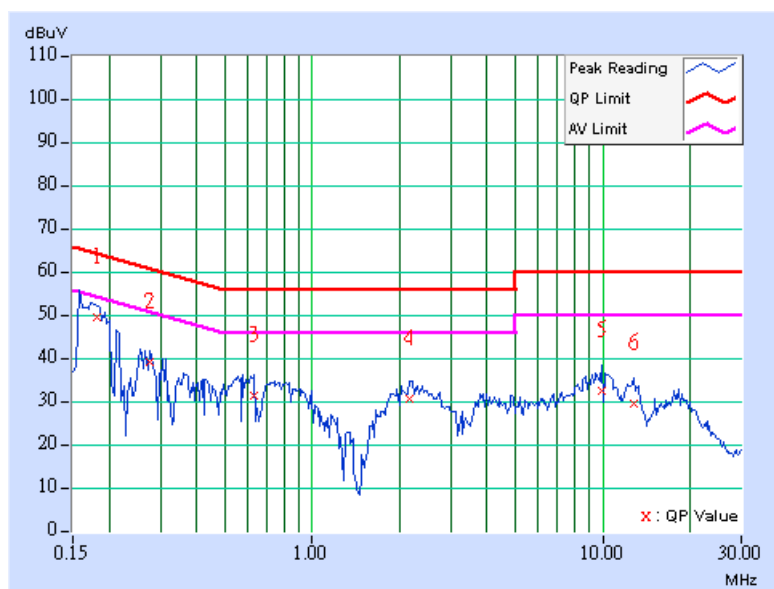



EUT TEST CONDITION		MEASUREMENT DETAIL	
CHANNEL	Channel 6	PHASE	Line 2
MODULATION TYPE	BPSK	6dB BANDWIDTH	9 kHz
TRANSFER RATE	6.0Mbps	INPUT POWER (SYSTEM)	120Vac, 60 Hz
ENVIRONMENTAL CONDITIONS	22deg. C, 60% RH, 991hPa	TESTED BY	Dean Wang

No	Freq. [MHz]	Corr. Factor (dB)	Reading Value [dB (uV)]		Emission Level [dB (uV)]		Limit [dB (uV)]		Margin (dB)	
			Q.P.	AV.	Q.P.	AV.	Q.P.	AV.	Q.P.	AV.
1	0.178	0.10	49.70	-	49.80	-	64.56	54.56	-14.76	-
2	0.263	0.10	39.12	-	39.22	-	61.32	51.32	-22.10	-
3	0.630	0.14	31.55	-	31.69	-	56.00	46.00	-24.31	-
4	2.156	0.22	29.93	-	30.15	-	56.00	46.00	-25.85	-
5	7.738	0.37	27.82	-	28.19	-	60.00	50.00	-31.81	-
6	10.820	0.44	32.65	-	33.09	-	60.00	50.00	-26.91	-

- REMARKS:**
1. Q.P. and AV. are abbreviations of quasi-peak and average individually.
  2. "-": The Quasi-peak reading value also meets average limit and measurement with the average detector is unnecessary.
  3. The emission levels of other frequencies were very low against the limit.
  4. Margin value = Emission level - Limit value
  5. Correction factor = Insertion loss + Cable loss
  6. Emission Level = Correction Factor + Reading Value.

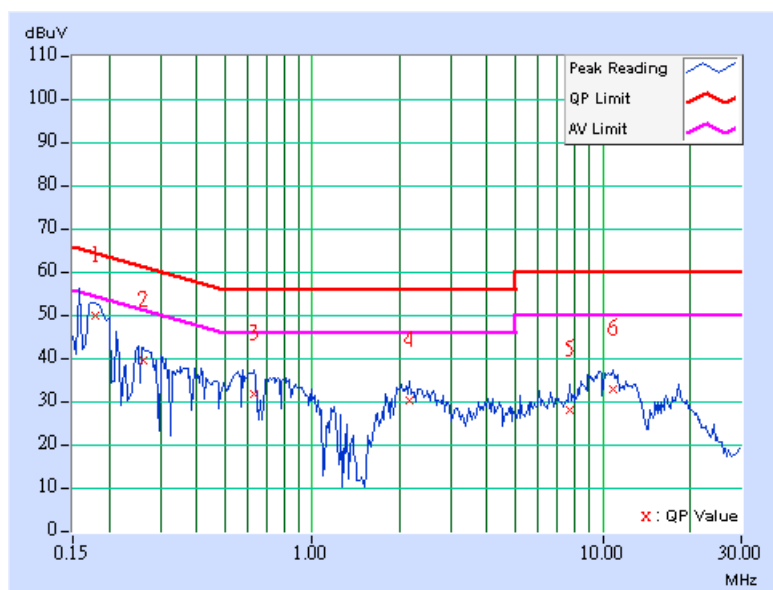

EUT TEST CONDITION		MEASUREMENT DETAIL	
CHANNEL	Channel 11	PHASE	Line 1
MODULATION TYPE	BPSK	6dB BANDWIDTH	9 kHz
TRANSFER RATE	6.0Mbps	INPUT POWER (SYSTEM)	120Vac, 60 Hz
ENVIRONMENTAL CONDITIONS	22deg. C, 60% RH, 991hPa	TESTED BY	Dean Wang

No	Freq. [MHz]	Corr. Factor (dB)	Reading Value [dB (uV)]		Emission Level [dB (uV)]		Limit [dB (uV)]		Margin (dB)	
			Q.P.	AV.	Q.P.	AV.	Q.P.	AV.	Q.P.	AV.
1	0.177	0.10	49.91	-	50.01	-	64.61	54.61	-14.60	-
2	0.259	0.10	39.41	-	39.51	-	61.45	51.45	-21.94	-
3	0.630	0.10	29.89	-	29.99	-	56.00	46.00	-26.01	-
4	2.043	0.22	30.82	-	31.04	-	56.00	46.00	-24.96	-
5	10.406	0.34	32.55	-	32.89	-	60.00	50.00	-27.11	-
6	18.836	0.55	26.58	-	27.13	-	60.00	50.00	-32.87	-

- REMARKS:**
1. Q.P. and AV. are abbreviations of quasi-peak and average individually.
  2. "-": The Quasi-peak reading value also meets average limit and measurement with the average detector is unnecessary.
  3. The emission levels of other frequencies were very low against the limit.
  4. Margin value = Emission level - Limit value
  5. Correction factor = Insertion loss + Cable loss
  6. Emission Level = Correction Factor + Reading Value.

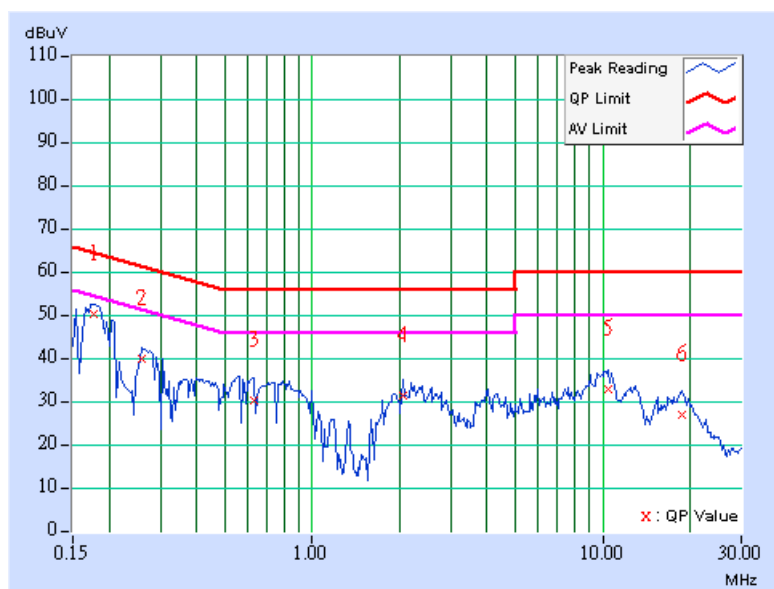

EUT TEST CONDITION		MEASUREMENT DETAIL	
CHANNEL	Channel 11	PHASE	Line 2
MODULATION TYPE	BPSK	6dB BANDWIDTH	9 kHz
TRANSFER RATE	6.0Mbps	INPUT POWER (SYSTEM)	120Vac, 60 Hz
ENVIRONMENTAL CONDITIONS	22deg. C, 60% RH, 991hPa	TESTED BY	Dean Wang

No	Freq. [MHz]	Corr. Factor (dB)	Reading Value [dB (uV)]		Emission Level [dB (uV)]		Limit [dB (uV)]		Margin (dB)	
			Q.P.	AV.	Q.P.	AV.	Q.P.	AV.	Q.P.	AV.
1	0.177	0.10	49.91	-	50.01	-	64.61	54.61	-14.60	-
2	0.268	0.10	38.05	-	38.15	-	61.19	51.19	-23.04	-
3	0.627	0.14	33.37	-	33.51	-	56.00	46.00	-22.49	-
4	2.102	0.22	30.50	-	30.72	-	56.00	46.00	-25.28	-
5	10.074	0.43	33.06	-	33.49	-	60.00	50.00	-26.51	-
6	17.867	0.53	25.90	-	26.43	-	60.00	50.00	-33.57	-

- REMARKS:**
1. Q.P. and AV. are abbreviations of quasi-peak and average individually.
  2. "-": The Quasi-peak reading value also meets average limit and measurement with the average detector is unnecessary.
  3. The emission levels of other frequencies were very low against the limit.
  4. Margin value = Emission level - Limit value
  5. Correction factor = Insertion loss + Cable loss
  6. Emission Level = Correction Factor + Reading Value.

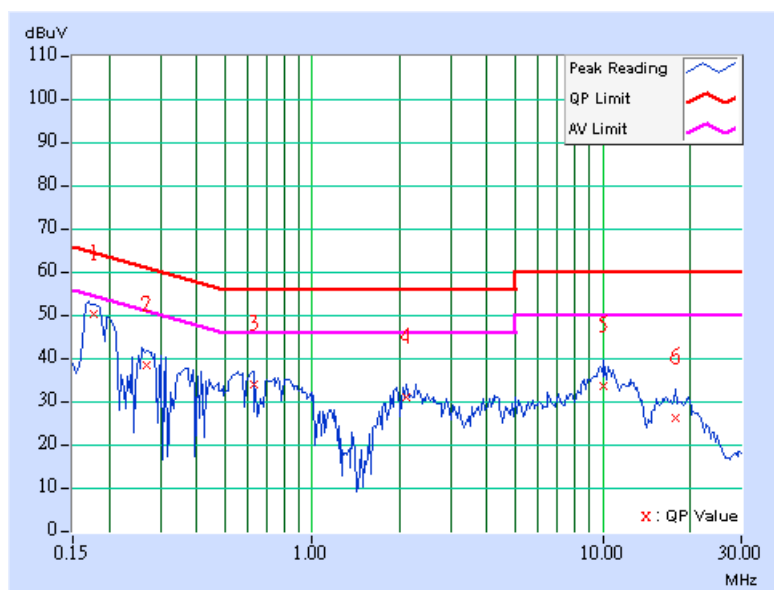

**DRAFT 802.11n (20MHz) OFDM MODULATION:**

EUT TEST CONDITION		MEASUREMENT DETAIL	
CHANNEL	Channel 1	PHASE	Line 1
MODULATION TYPE	BPSK	6dB BANDWIDTH	9 kHz
TRANSFER RATE	7.2Mbps	INPUT POWER (SYSTEM)	120Vac, 60 Hz
ENVIRONMENTAL CONDITIONS	22deg. C, 60% RH, 991hPa	TESTED BY	Dean Wang

No	Freq. [MHz]	Corr. Factor (dB)	Reading Value [dB (uV)]		Emission Level [dB (uV)]		Limit [dB (uV)]		Margin (dB)	
			Q.P.	AV.	Q.P.	AV.	Q.P.	AV.	Q.P.	AV.
1	0.181	0.10	49.28	-	49.38	-	64.43	54.43	-15.05	-
2	0.269	0.10	37.73	-	37.83	-	61.16	51.16	-23.33	-
3	0.560	0.10	32.69	-	32.79	-	56.00	46.00	-23.21	-
4	2.051	0.22	30.04	-	30.26	-	56.00	46.00	-25.74	-
5	10.504	0.35	33.28	-	33.63	-	60.00	50.00	-26.37	-
6	12.738	0.41	30.04	-	30.45	-	60.00	50.00	-29.55	-

- REMARKS:**
1. Q.P. and AV. are abbreviations of quasi-peak and average individually.
  2. "-": The Quasi-peak reading value also meets average limit and measurement with the average detector is unnecessary.
  3. The emission levels of other frequencies were very low against the limit.
  4. Margin value = Emission level - Limit value
  5. Correction factor = Insertion loss + Cable loss
  6. Emission Level = Correction Factor + Reading Value.

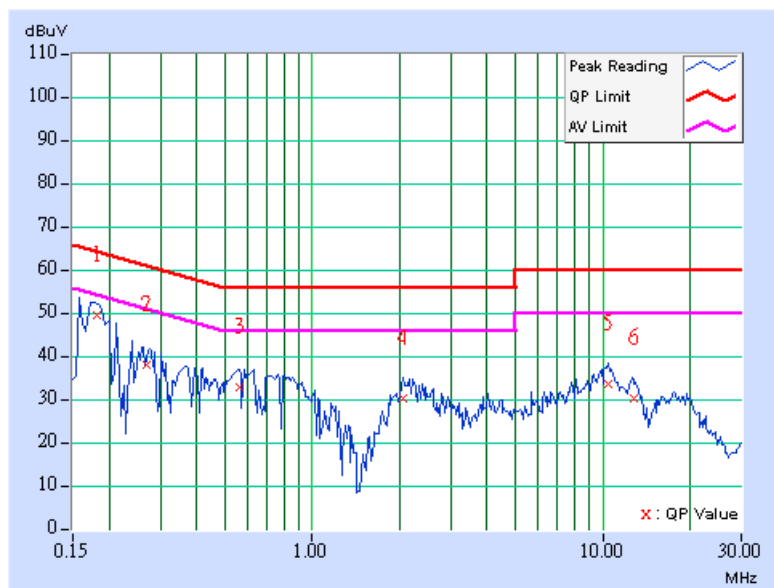

EUT TEST CONDITION		MEASUREMENT DETAIL	
CHANNEL	Channel 1	PHASE	Line 2
MODULATION TYPE	BPSK	6dB BANDWIDTH	9 kHz
TRANSFER RATE	7.2Mbps	INPUT POWER (SYSTEM)	120Vac, 60 Hz
ENVIRONMENTAL CONDITIONS	22deg. C, 60% RH, 991hPa	TESTED BY	Dean Wang

No	Freq. [MHz]	Corr. Factor (dB)	Reading Value [dB (uV)]		Emission Level [dB (uV)]		Limit [dB (uV)]		Margin (dB)	
			Q.P.	AV.	Q.P.	AV.	Q.P.	AV.	Q.P.	AV.
1	0.181	0.10	49.07	-	49.17	-	64.43	54.43	-15.26	-
2	0.271	0.10	37.82	-	37.92	-	61.08	51.08	-23.16	-
3	0.556	0.13	32.51	-	32.64	-	56.00	46.00	-23.36	-
4	2.391	0.23	30.38	-	30.61	-	56.00	46.00	-25.39	-
5	9.945	0.43	32.41	-	32.84	-	60.00	50.00	-27.16	-
6	17.723	0.53	26.61	-	27.14	-	60.00	50.00	-32.86	-

- REMARKS:**
1. Q.P. and AV. are abbreviations of quasi-peak and average individually.
  2. "-": The Quasi-peak reading value also meets average limit and measurement with the average detector is unnecessary.
  3. The emission levels of other frequencies were very low against the limit.
  4. Margin value = Emission level - Limit value
  5. Correction factor = Insertion loss + Cable loss
  6. Emission Level = Correction Factor + Reading Value.

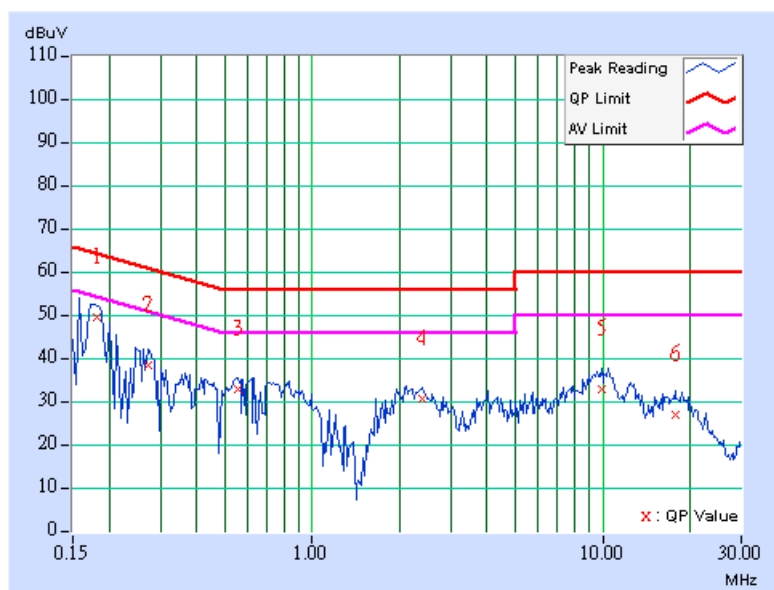

EUT TEST CONDITION		MEASUREMENT DETAIL	
CHANNEL	Channel 6	PHASE	Line 1
MODULATION TYPE	BPSK	6dB BANDWIDTH	9 kHz
TRANSFER RATE	7.2Mbps	INPUT POWER (SYSTEM)	120Vac, 60 Hz
ENVIRONMENTAL CONDITIONS	22deg. C, 60% RH, 991hPa	TESTED BY	Dean Wang

No	Freq. [MHz]	Corr. Factor (dB)	Reading Value [dB (uV)]		Emission Level [dB (uV)]		Limit [dB (uV)]		Margin (dB)	
			Q.P.	AV.	Q.P.	AV.	Q.P.	AV.	Q.P.	AV.
1	0.177	0.10	49.56	-	49.66	-	64.61	54.61	-14.95	-
2	0.269	0.10	37.75	-	37.85	-	61.16	51.16	-23.31	-
3	0.615	0.10	31.98	-	32.08	-	56.00	46.00	-23.92	-
4	2.152	0.22	30.13	-	30.35	-	56.00	46.00	-25.65	-
5	9.926	0.33	32.41	-	32.74	-	60.00	50.00	-27.26	-
6	17.543	0.53	26.48	-	27.01	-	60.00	50.00	-32.99	-

- REMARKS:**
1. Q.P. and AV. are abbreviations of quasi-peak and average individually.
  2. "-": The Quasi-peak reading value also meets average limit and measurement with the average detector is unnecessary.
  3. The emission levels of other frequencies were very low against the limit.
  4. Margin value = Emission level - Limit value
  5. Correction factor = Insertion loss + Cable loss
  6. Emission Level = Correction Factor + Reading Value.

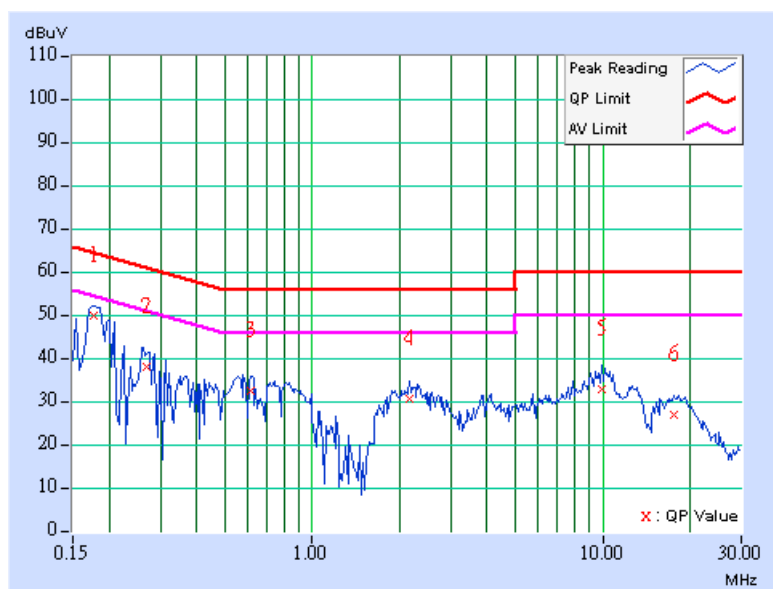

EUT TEST CONDITION		MEASUREMENT DETAIL	
CHANNEL	Channel 6	PHASE	Line 2
MODULATION TYPE	BPSK	6dB BANDWIDTH	9 kHz
TRANSFER RATE	7.2Mbps	INPUT POWER (SYSTEM)	120Vac, 60 Hz
ENVIRONMENTAL CONDITIONS	22deg. C, 60% RH, 991hPa	TESTED BY	Dean Wang

No	Freq. [MHz]	Corr. Factor (dB)	Reading Value [dB (uV)]		Emission Level [dB (uV)]		Limit [dB (uV)]		Margin (dB)	
			Q.P.	AV.	Q.P.	AV.	Q.P.	AV.	Q.P.	AV.
1	0.179	0.10	49.42	-	49.52	-	64.54	54.54	-15.02	-
2	0.266	0.10	38.23	-	38.33	-	61.25	51.25	-22.92	-
3	0.630	0.14	32.16	-	32.30	-	56.00	46.00	-23.70	-
4	2.410	0.23	30.22	-	30.45	-	56.00	46.00	-25.55	-
5	10.438	0.43	33.27	-	33.70	-	60.00	50.00	-26.30	-
6	19.469	0.56	25.26	-	25.82	-	60.00	50.00	-34.18	-

- REMARKS:**
1. Q.P. and AV. are abbreviations of quasi-peak and average individually.
  2. "-": The Quasi-peak reading value also meets average limit and measurement with the average detector is unnecessary.
  3. The emission levels of other frequencies were very low against the limit.
  4. Margin value = Emission level - Limit value
  5. Correction factor = Insertion loss + Cable loss
  6. Emission Level = Correction Factor + Reading Value.

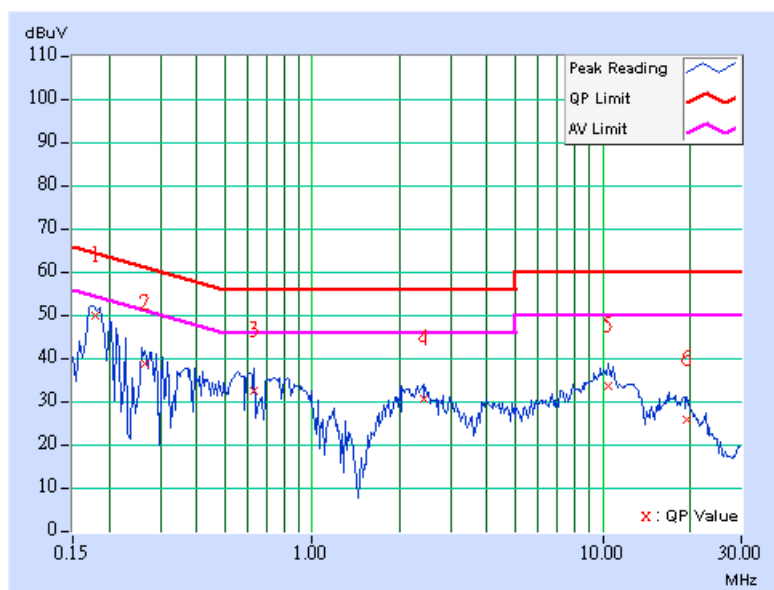

EUT TEST CONDITION		MEASUREMENT DETAIL	
CHANNEL	Channel 11	PHASE	Line 1
MODULATION TYPE	BPSK	6dB BANDWIDTH	9 kHz
TRANSFER RATE	7.2Mbps	INPUT POWER (SYSTEM)	120Vac, 60 Hz
ENVIRONMENTAL CONDITIONS	22deg. C, 60% RH, 991hPa	TESTED BY	Dean Wang

No	Freq. [MHz]	Corr. Factor (dB)	Reading Value [dB (uV)]		Emission Level [dB (uV)]		Limit [dB (uV)]		Margin (dB)	
			Q.P.	AV.	Q.P.	AV.	Q.P.	AV.	Q.P.	AV.
1	0.181	0.10	49.28	-	49.38	-	64.43	54.43	-15.05	-
2	0.267	0.10	37.76	-	37.86	-	61.20	51.20	-23.34	-
3	0.623	0.10	33.19	-	33.29	-	56.00	46.00	-22.71	-
4	2.086	0.22	30.08	-	30.30	-	56.00	46.00	-25.70	-
5	10.453	0.34	33.29	-	33.63	-	60.00	50.00	-26.37	-
6	13.027	0.42	29.32	-	29.74	-	60.00	50.00	-30.26	-

- REMARKS:**
1. Q.P. and AV. are abbreviations of quasi-peak and average individually.
  2. "-": The Quasi-peak reading value also meets average limit and measurement with the average detector is unnecessary.
  3. The emission levels of other frequencies were very low against the limit.
  4. Margin value = Emission level - Limit value
  5. Correction factor = Insertion loss + Cable loss
  6. Emission Level = Correction Factor + Reading Value.

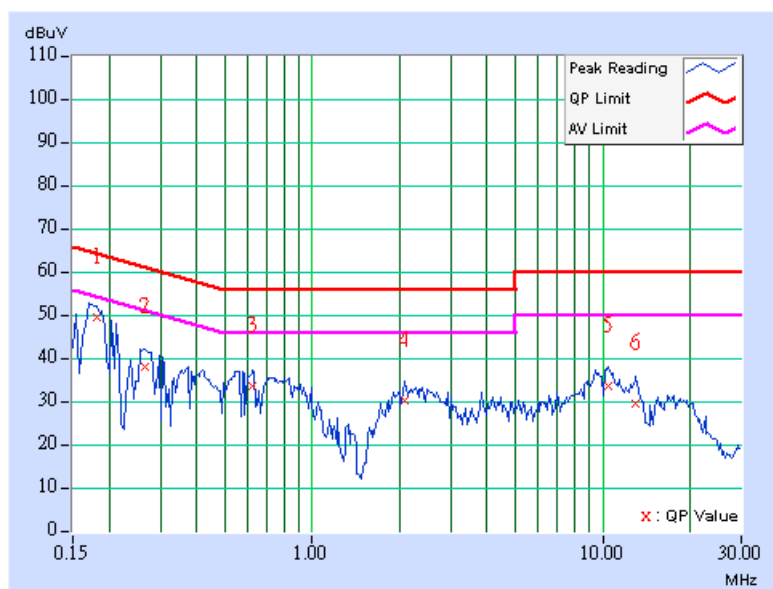



EUT TEST CONDITION		MEASUREMENT DETAIL	
CHANNEL	Channel 11	PHASE	Line 2
MODULATION TYPE	BPSK	6dB BANDWIDTH	9 kHz
TRANSFER RATE	7.2Mbps	INPUT POWER (SYSTEM)	120Vac, 60 Hz
ENVIRONMENTAL CONDITIONS	22deg. C, 60% RH, 991hPa	TESTED BY	Dean Wang

No	Freq. [MHz]	Corr. Factor (dB)	Reading Value [dB (uV)]		Emission Level [dB (uV)]		Limit [dB (uV)]		Margin (dB)	
			Q.P.	AV.	Q.P.	AV.	Q.P.	AV.	Q.P.	AV.
1	0.177	0.10	49.46	-	49.56	-	64.61	54.61	-15.05	-
2	0.267	0.10	37.91	-	38.01	-	61.20	51.20	-23.19	-
3	0.638	0.14	27.13	-	27.27	-	56.00	46.00	-28.73	-
4	2.160	0.22	29.77	-	29.99	-	56.00	46.00	-26.01	-
5	10.035	0.43	32.57	-	33.00	-	60.00	50.00	-27.00	-
6	17.793	0.53	26.37	-	26.90	-	60.00	50.00	-33.10	-

- REMARKS:**
1. Q.P. and AV. are abbreviations of quasi-peak and average individually.
  2. "-": The Quasi-peak reading value also meets average limit and measurement with the average detector is unnecessary.
  3. The emission levels of other frequencies were very low against the limit.
  4. Margin value = Emission level - Limit value
  5. Correction factor = Insertion loss + Cable loss
  6. Emission Level = Correction Factor + Reading Value.

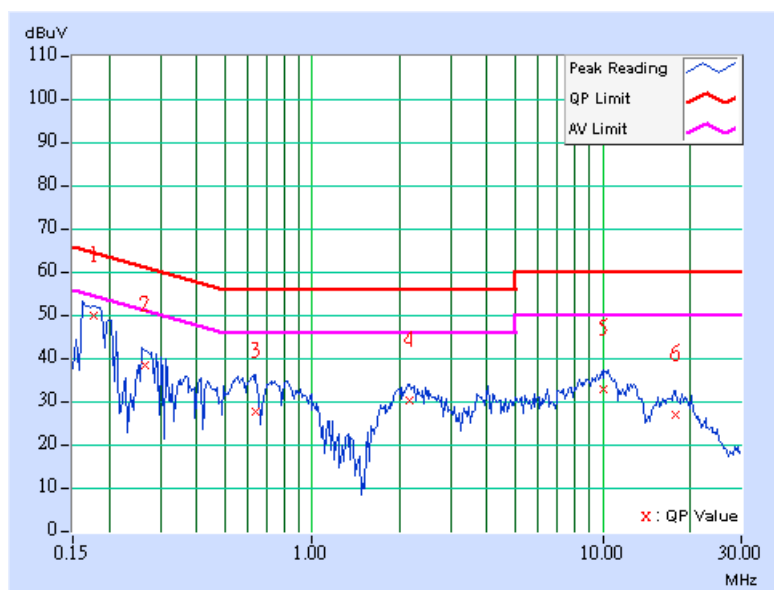

**DRAFT 802.11n (40MHz) OFDM MODULATION:**

EUT TEST CONDITION		MEASUREMENT DETAIL	
CHANNEL	Channel 1	PHASE	Line 1
MODULATION TYPE	BPSK	6dB BANDWIDTH	9 kHz
TRANSFER RATE	15.0Mbps	INPUT POWER (SYSTEM)	120Vac, 60 Hz
ENVIRONMENTAL CONDITIONS	22deg. C, 60% RH, 991hPa	TESTED BY	Dean Wang

No	Freq. [MHz]	Corr. Factor (dB)	Reading Value [dB (uV)]		Emission Level [dB (uV)]		Limit [dB (uV)]		Margin (dB)	
			Q.P.	AV.	Q.P.	AV.	Q.P.	AV.	Q.P.	AV.
1	0.180	0.10	48.89	-	48.99	-	64.48	54.48	-15.49	-
2	0.264	0.10	38.78	-	38.88	-	61.29	51.29	-22.41	-
3	0.634	0.10	26.34	-	26.44	-	56.00	46.00	-29.56	-
4	2.203	0.23	31.10	-	31.33	-	56.00	46.00	-24.67	-
5	10.488	0.34	32.48	-	32.82	-	60.00	50.00	-27.18	-
6	12.719	0.41	29.51	-	29.92	-	60.00	50.00	-30.08	-

- REMARKS:**
1. Q.P. and AV. are abbreviations of quasi-peak and average individually.
  2. "-": The Quasi-peak reading value also meets average limit and measurement with the average detector is unnecessary.
  3. The emission levels of other frequencies were very low against the limit.
  4. Margin value = Emission level - Limit value
  5. Correction factor = Insertion loss + Cable loss
  6. Emission Level = Correction Factor + Reading Value.

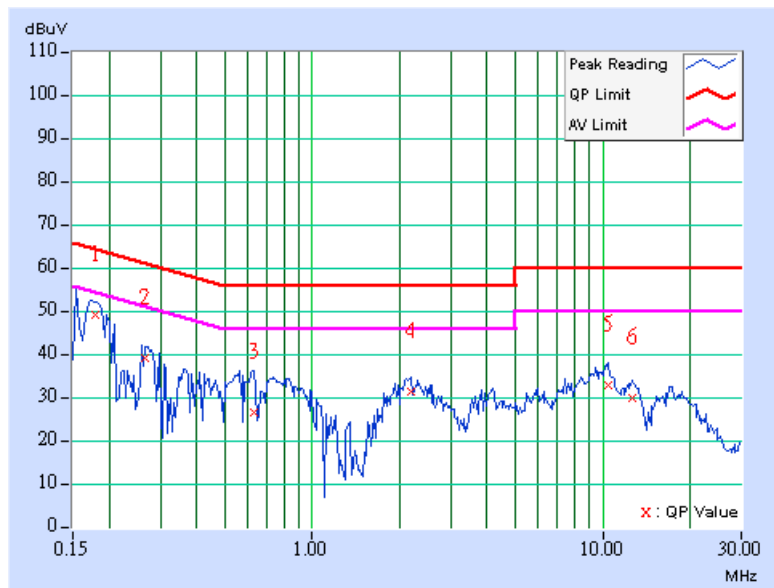

EUT TEST CONDITION		MEASUREMENT DETAIL	
CHANNEL	Channel 1	PHASE	Line 2
MODULATION TYPE	BPSK	6dB BANDWIDTH	9 kHz
TRANSFER RATE	15.0Mbps	INPUT POWER (SYSTEM)	120Vac, 60 Hz
ENVIRONMENTAL CONDITIONS	22deg. C, 60% RH, 991hPa	TESTED BY	Dean Wang

No	Freq. [MHz]	Corr. Factor (dB)	Reading Value [dB (uV)]		Emission Level [dB (uV)]		Limit [dB (uV)]		Margin (dB)	
			Q.P.	AV.	Q.P.	AV.	Q.P.	AV.	Q.P.	AV.
1	0.177	0.10	49.70	-	49.80	-	64.64	54.64	-14.84	-
2	0.285	0.10	34.79	-	34.89	-	60.66	50.66	-25.77	-
3	0.623	0.14	33.19	-	33.33	-	56.00	46.00	-22.67	-
4	2.277	0.23	29.96	-	30.19	-	56.00	46.00	-25.81	-
5	9.965	0.43	32.93	-	33.36	-	60.00	50.00	-26.64	-
6	17.051	0.52	26.16	-	26.68	-	60.00	50.00	-33.32	-

- REMARKS:**
1. Q.P. and AV. are abbreviations of quasi-peak and average individually.
  2. "-": The Quasi-peak reading value also meets average limit and measurement with the average detector is unnecessary.
  3. The emission levels of other frequencies were very low against the limit.
  4. Margin value = Emission level - Limit value
  5. Correction factor = Insertion loss + Cable loss
  6. Emission Level = Correction Factor + Reading Value.

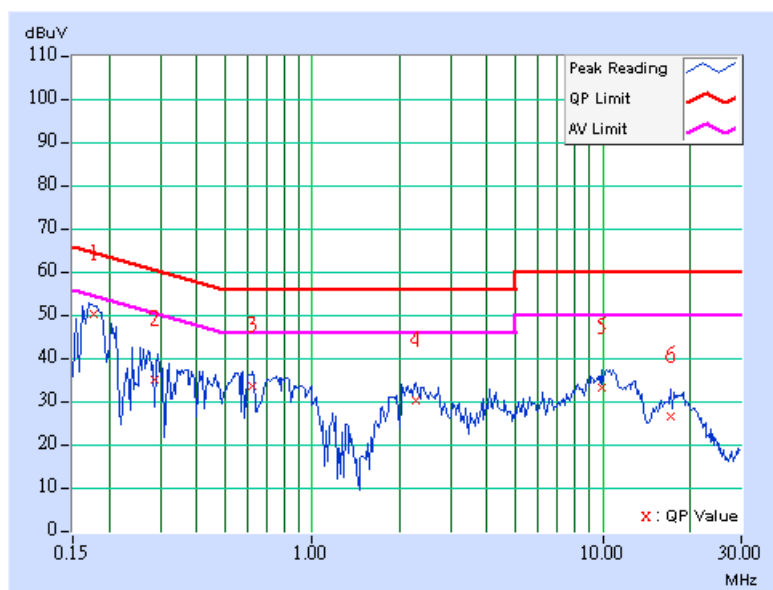

EUT TEST CONDITION		MEASUREMENT DETAIL	
CHANNEL	Channel 4	PHASE	Line 1
MODULATION TYPE	BPSK	6dB BANDWIDTH	9 kHz
TRANSFER RATE	15.0Mbps	INPUT POWER (SYSTEM)	120Vac, 60 Hz
ENVIRONMENTAL CONDITIONS	22deg. C, 60% RH, 991hPa	TESTED BY	Dean Wang

No	Freq. [MHz]	Corr. Factor (dB)	Reading Value [dB (uV)]		Emission Level [dB (uV)]		Limit [dB (uV)]		Margin (dB)	
			Q.P.	AV.	Q.P.	AV.	Q.P.	AV.	Q.P.	AV.
1	0.177	0.10	49.68	-	49.78	-	64.61	54.61	-14.83	-
2	0.271	0.10	38.14	-	38.24	-	61.08	51.08	-22.84	-
3	0.630	0.10	27.41	-	27.51	-	56.00	46.00	-28.49	-
4	2.594	0.24	28.38	-	28.62	-	56.00	46.00	-27.38	-
5	10.055	0.33	32.58	-	32.91	-	60.00	50.00	-27.09	-
6	17.211	0.52	26.19	-	26.71	-	60.00	50.00	-33.29	-

- REMARKS:**
1. Q.P. and AV. are abbreviations of quasi-peak and average individually.
  2. "-": The Quasi-peak reading value also meets average limit and measurement with the average detector is unnecessary.
  3. The emission levels of other frequencies were very low against the limit.
  4. Margin value = Emission level - Limit value
  5. Correction factor = Insertion loss + Cable loss
  6. Emission Level = Correction Factor + Reading Value.

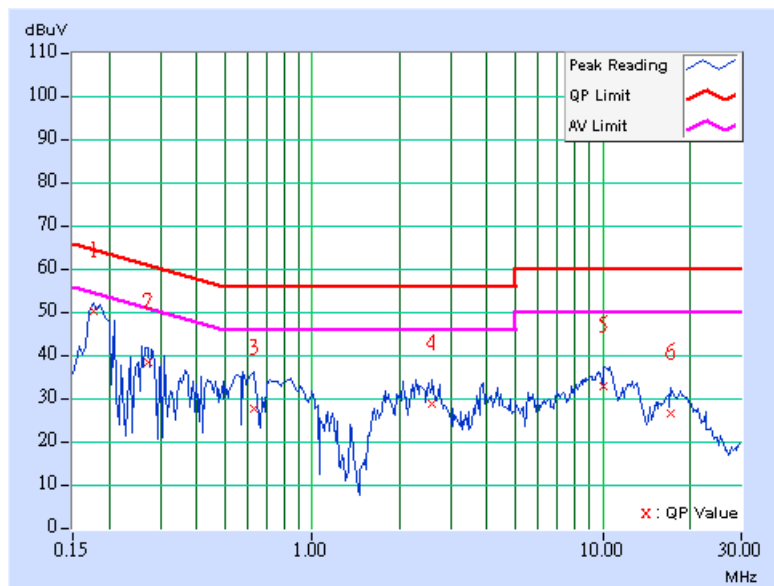

EUT TEST CONDITION		MEASUREMENT DETAIL	
CHANNEL	Channel 4	PHASE	Line 2
MODULATION TYPE	BPSK	6dB BANDWIDTH	9 kHz
TRANSFER RATE	15.0Mbps	INPUT POWER (SYSTEM)	120Vac, 60 Hz
ENVIRONMENTAL CONDITIONS	22deg. C, 60% RH, 991hPa	TESTED BY	Dean Wang

No	Freq. [MHz]	Corr. Factor (dB)	Reading Value [dB (uV)]		Emission Level [dB (uV)]		Limit [dB (uV)]		Margin (dB)	
			Q.P.	AV.	Q.P.	AV.	Q.P.	AV.	Q.P.	AV.
1	0.176	0.10	49.80	-	49.90	-	64.67	54.67	-14.77	-
2	0.271	0.10	37.88	-	37.98	-	61.08	51.08	-23.10	-
3	0.560	0.13	32.85	-	32.98	-	56.00	46.00	-23.02	-
4	2.184	0.23	30.55	-	30.78	-	56.00	46.00	-25.22	-
5	10.695	0.44	32.92	-	33.36	-	60.00	50.00	-26.64	-
6	17.965	0.53	26.08	-	26.61	-	60.00	50.00	-33.39	-

- REMARKS:**
1. Q.P. and AV. are abbreviations of quasi-peak and average individually.
  2. "-": The Quasi-peak reading value also meets average limit and measurement with the average detector is unnecessary.
  3. The emission levels of other frequencies were very low against the limit.
  4. Margin value = Emission level - Limit value
  5. Correction factor = Insertion loss + Cable loss
  6. Emission Level = Correction Factor + Reading Value.

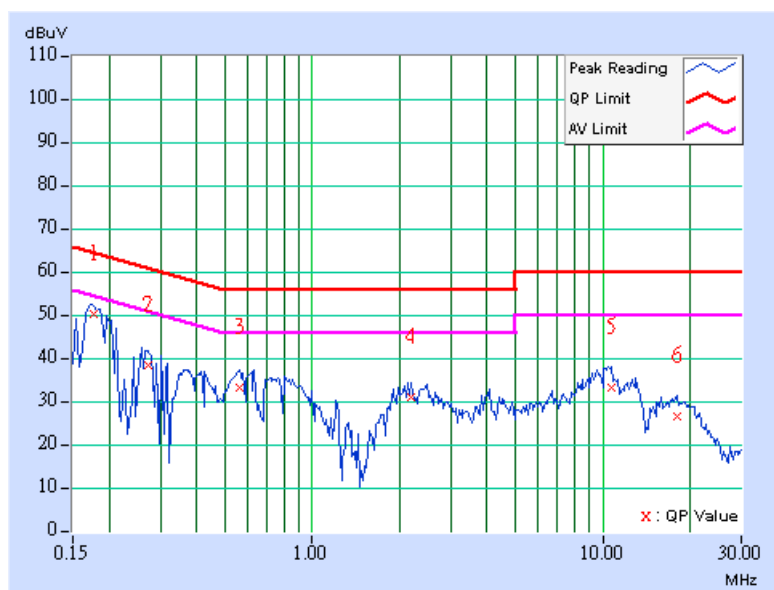

EUT TEST CONDITION		MEASUREMENT DETAIL	
CHANNEL	Channel 7	PHASE	Line 1
MODULATION TYPE	BPSK	6dB BANDWIDTH	9 kHz
TRANSFER RATE	15.0Mbps	INPUT POWER (SYSTEM)	120Vac, 60 Hz
ENVIRONMENTAL CONDITIONS	22deg. C, 60% RH, 991hPa	TESTED BY	Dean Wang

No	Freq. [MHz]	Corr. Factor (dB)	Reading Value [dB (uV)]		Emission Level [dB (uV)]		Limit [dB (uV)]		Margin (dB)	
			Q.P.	AV.	Q.P.	AV.	Q.P.	AV.	Q.P.	AV.
1	0.181	0.10	49.14	-	49.24	-	64.43	54.43	-15.19	-
2	0.289	0.10	34.18	-	34.28	-	60.54	50.54	-26.26	-
3	0.630	0.10	26.89	-	26.99	-	56.00	46.00	-29.01	-
4	1.988	0.22	30.01	-	30.23	-	56.00	46.00	-25.77	-
5	10.027	0.33	32.47	-	32.80	-	60.00	50.00	-27.20	-
6	13.328	0.43	27.65	-	28.08	-	60.00	50.00	-31.92	-

- REMARKS:**
1. Q.P. and AV. are abbreviations of quasi-peak and average individually.
  2. "-": The Quasi-peak reading value also meets average limit and measurement with the average detector is unnecessary.
  3. The emission levels of other frequencies were very low against the limit.
  4. Margin value = Emission level - Limit value
  5. Correction factor = Insertion loss + Cable loss
  6. Emission Level = Correction Factor + Reading Value.

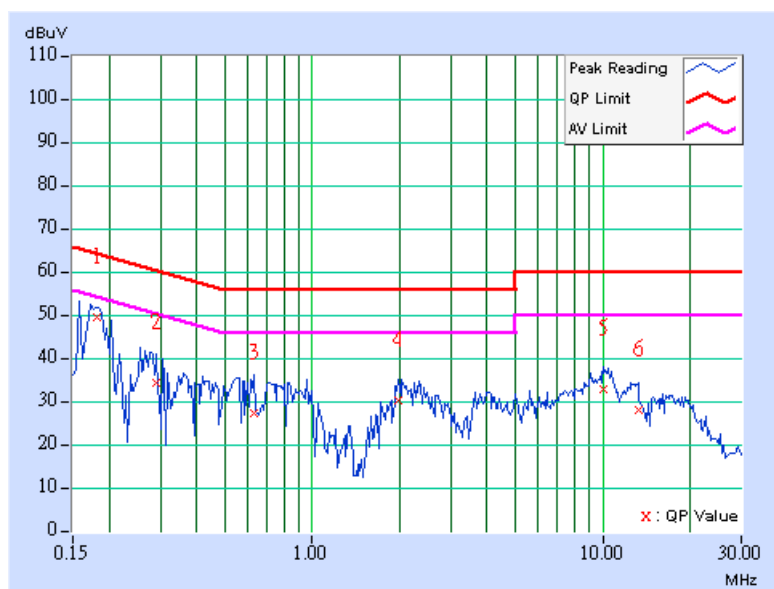

EUT TEST CONDITION		MEASUREMENT DETAIL	
CHANNEL	Channel 7	PHASE	Line 2
MODULATION TYPE	BPSK	6dB BANDWIDTH	9 kHz
TRANSFER RATE	15.0Mbps	INPUT POWER (SYSTEM)	120Vac, 60 Hz
ENVIRONMENTAL CONDITIONS	22deg. C, 60% RH, 991hPa	TESTED BY	Dean Wang

No	Freq. [MHz]	Corr. Factor (dB)	Reading Value [dB (uV)]		Emission Level [dB (uV)]		Limit [dB (uV)]		Margin (dB)	
			Q.P.	AV.	Q.P.	AV.	Q.P.	AV.	Q.P.	AV.
1	0.173	0.10	50.29	-	50.39	-	64.79	54.79	-14.40	-
2	0.261	0.10	39.46	-	39.56	-	61.41	51.41	-21.85	-
3	0.560	0.13	32.87	-	33.00	-	56.00	46.00	-23.00	-
4	2.227	0.23	30.55	-	30.78	-	56.00	46.00	-25.22	-
5	10.008	0.43	33.03	-	33.46	-	60.00	50.00	-26.54	-
6	12.645	0.46	30.21	-	30.67	-	60.00	50.00	-29.33	-

- REMARKS:**
1. Q.P. and AV. are abbreviations of quasi-peak and average individually.
  2. "-": The Quasi-peak reading value also meets average limit and measurement with the average detector is unnecessary.
  3. The emission levels of other frequencies were very low against the limit.
  4. Margin value = Emission level - Limit value
  5. Correction factor = Insertion loss + Cable loss
  6. Emission Level = Correction Factor + Reading Value.

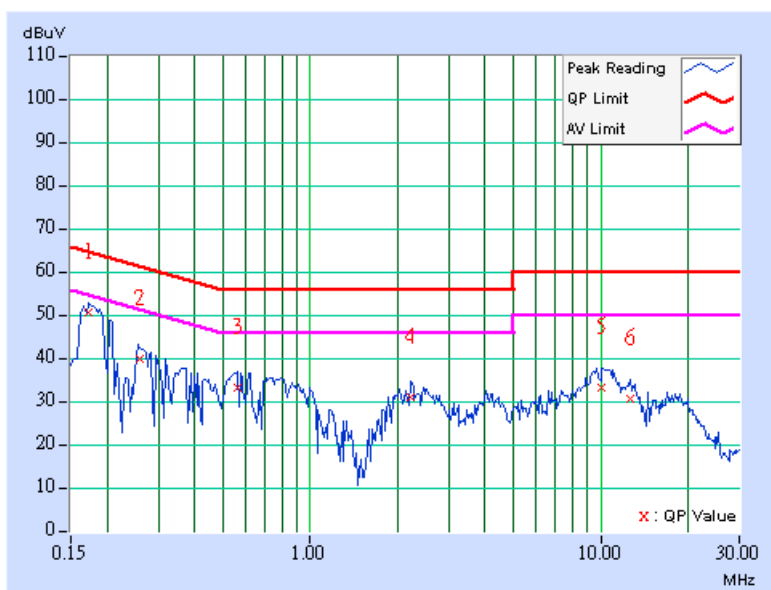

## 4.2 RADIATED EMISSION MEASUREMENT

### 4.2.1 LIMITS OF RADIATED EMISSION MEASUREMENT

Emissions radiated outside of the specified bands, shall be according to the general radiated limits in 15.209 as following:

FREQUENCIES (MHz)	FIELD STRENGTH (microvolts/meter)	MEASUREMENT DISTANCE (meters)
0.009 ~ 0.490	2400 / F(kHz)	300
0.490 ~ 1.705	24000 / F(kHz)	30
1.705 ~ 30.0	30	30
30 ~ 88	100	3
88 ~ 216	150	3
216 ~ 960	200	3
Above 960	500	3

**NOTE:**

1. The lower limit shall apply at the transition frequencies.
2. Emission level (dBuV/m) = 20 log Emission level (uV/m).
3. As shown in 15.35(b), for frequencies above 1000MHz, the field strength limits are based on average detector, however, the peak field strength of any emission shall not exceed the maximum permitted average limits, specified above by more than 20dB under any condition of modulation.



#### 4.2.2 TEST INSTRUMENTS

DESCRIPTION & MANUFACTURER	MODEL NO.	SERIAL NO.	CALIBRATED UNTIL
Test Receiver ROHDE & SCHWARZ	ESIB7	100212	May 08, 2007
Spectrum Analyzer ROHDE & SCHWARZ	FSP40	100269	Aug. 07, 2007
BILOG Antenna SCHWARZBECK	VULB9168	9168-153	Jan. 04, 2008
HORN Antenna SCHWARZBECK	BBHA 9120 D	9120D-563	Jul. 26, 2007
HORN Antenna SCHWARZBECK	BBHA 9170	BBHA9170242	Jan. 16, 2008
Preamplifier Agilent	8449B	3008A01911	Sep. 13, 2007
Preamplifier Agilent	8447D	2944A10638	Dec. 20, 2007
RF signal cable HUBER+SUHNNER	SUCOFLEX 104	218188/218189	Nov. 14, 2007
RF signal cable Worken	8D-FB	Cable-HYCH9-01	Mar. 08, 2007
Software	ADT_Radiated_V7.6	NA	NA
Antenna Tower EMCO	2070/2080	512.835.4684	NA
Turn Table EMCO	2087-2.03	NA	NA
Antenna Tower & Turn Table Controller EMCO	2090	NA	NA

- NOTE:**
1. The calibration interval of the above test instruments is 12 months and the calibrations are traceable to NML/ROC and NIST/USA.
  2. The test was performed in HwaYa Chamber 9.
  3. The horn antenna and HP preamplifier (model: 8449B) are used only for the measurement of emission frequency above 1GHz if tested.
  4. The IC Site Registration No. is IC4924A-9.

#### 4.2.3 TEST PROCEDURES

- a. The EUT was placed on the top of a rotating table 0.8 meters above the ground at a 3 meters semi-anechoic chamber. The table was rotated 360 degrees to determine the position of the highest radiation.
- b. The EUT was set 3 meters away from the interference-receiving antenna, which was mounted on the top of a variable-height antenna tower.
- c. The antenna is a broadband antenna, and its height is varied from one meter to four meters above the ground to determine the maximum value of the field strength. Both horizontal and vertical polarizations of the antenna are set to make the measurement.
- d. For each suspected emission, the EUT was arranged to its worst case and then the antenna was tuned to heights from 1 meter to 4 meters and the rotatable table was turned from 0 degrees to 360 degrees to find the maximum reading.
- e. The test-receiver system was set to Peak Detect Function and Specified Bandwidth with Maximum Hold Mode.
- f. If the emission level of the EUT in peak mode was lower than the limit specified, then testing could be stopped and the peak values of the EUT would be reported. Otherwise the emissions would be re-tested one by one using peak, quasi-peak or average method as specified and then reported in a data sheet.

**NOTE:**

1. The resolution bandwidth and video bandwidth of test receiver/spectrum analyzer is 120kHz for Peak detection (PK) and Quasi-peak detection (QP) at frequency below 1GHz.
2. The resolution bandwidth of test receiver/spectrum analyzer is 1 MHz and video bandwidth is 3MHz for Peak detection at frequency above 1GHz.
3. The resolution bandwidth of test receiver/spectrum analyzer is 1MHz and the video bandwidth is 10Hz for Average detection (AV) at frequency above 1GHz.

#### 4.2.4 DEVIATION FROM TEST STANDARD

No deviation

#### 4.2.5 TEST SETUP

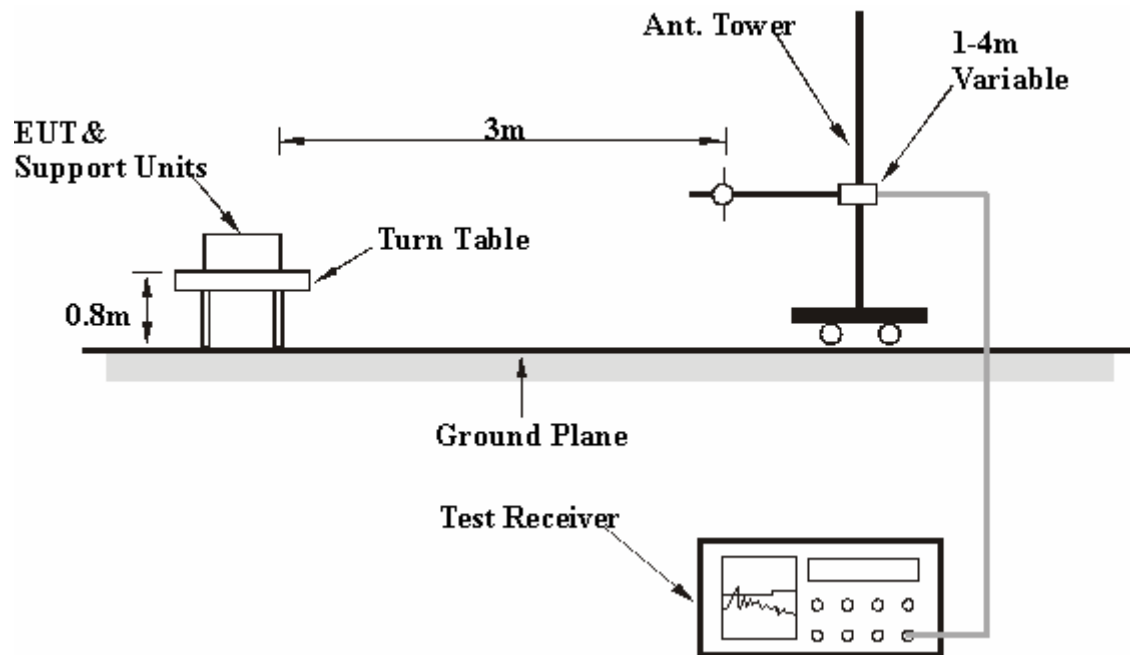

For the actual test configuration, please refer to the attached file (Test Setup Photo).

#### 4.2.6 EUT OPERATING CONDITIONS

Same as 4.1.6

#### 4.2.7 TEST RESULTS

#### BELOW 1GHz WORST-CASE DATA

#### 802.11g OFDM MODULATION:

EUT TEST CONDITION		MEASUREMENT DETAIL	
CHANNEL	Channel 1	FREQUENCY RANGE	Below 1000MHz
MODULATION TYPE	BPSK	INPUT POWER (SYSTEM)	120Vac, 60 Hz
TRANSFER RATE	6.0Mbps	DETECTOR FUNCTION	Quasi-Peak
ENVIRONMENTAL CONDITIONS	23deg. C, 63% RH, 991hPa	TESTED BY	Brad Wu

ANTENNA POLARITY & TEST DISTANCE: HORIZONTAL AT 3 m								
No.	Freq. (MHz)	Emission Level (dBuV/m)	Limit (dBuV/m)	Margin (dB)	Antenna Height (m)	Table Angle (Degree)	Raw Value (dBuV)	Correction Factor (dB/m)
1	115.53	32.52 QP	43.50	-10.98	1.50 H	265	20.78	11.75
2	199.12	32.87 QP	43.50	-10.63	1.00 H	232	21.47	11.40
3	333.25	30.12 QP	46.00	-15.88	1.00 H	190	14.51	15.61
4	465.43	27.35 QP	46.00	-18.65	2.00 H	133	7.95	19.40
5	599.56	32.28 QP	46.00	-13.72	2.00 H	250	9.15	23.13
6	700.64	30.55 QP	46.00	-15.45	1.50 H	208	5.30	25.26

ANTENNA POLARITY & TEST DISTANCE: VERTICAL AT 3 m								
No.	Freq. (MHz)	Emission Level (dBuV/m)	Limit (dBuV/m)	Margin (dB)	Antenna Height (m)	Table Angle (Degree)	Raw Value (dBuV)	Correction Factor (dB/m)
1	133.03	33.20 QP	43.50	-10.30	1.00 V	286	20.19	13.01
2	199.12	31.42 QP	43.50	-12.08	1.00 V	157	20.02	11.40
3	333.25	24.71 QP	46.00	-21.29	1.50 V	265	9.10	15.61
4	599.56	34.03 QP	46.00	-11.97	1.00 V	10	10.90	23.13
5	700.64	31.86 QP	46.00	-14.14	1.50 V	241	6.60	25.26
6	799.78	29.23 QP	46.00	-16.77	1.50 V	331	2.81	26.43

**REMARKS:** 1. Emission level (dBuV/m) = Raw Value (dBuV) + Correction Factor (dB/m).

2. Correction Factor (dB/m) = Antenna Factor (dB/m) + Cable Factor (dB).

3. The other emission levels were very low against the limit.

4. Margin value = Emission level – Limit value.

**DRAFT 802.11n (20MHz) OFDM MODULATION:**

EUT TEST CONDITION		MEASUREMENT DETAIL	
CHANNEL	Channel 1	FREQUENCY RANGE	Below 1000MHz
MODULATION TYPE	BPSK	INPUT POWER (SYSTEM)	120Vac, 60 Hz
TRANSFER RATE	7.2Mbps	DETECTOR FUNCTION	Quasi-Peak
ENVIRONMENTAL CONDITIONS	23deg. C, 63% RH, 991hPa	TESTED BY	Brad Wu

ANTENNA POLARITY & TEST DISTANCE: HORIZONTAL AT 3 m								
No.	Freq. (MHz)	Emission Level (dBuV/m)	Limit (dBuV/m)	Margin (dB)	Antenna Height (m)	Table Angle (Degree)	Raw Value (dBuV)	Correction Factor (dB/m)
1	115.69	32.84 QP	43.50	-10.66	1.00 H	293	21.08	11.76
2	199.69	32.68 QP	43.50	-10.82	1.00 H	241	21.32	11.36
3	333.59	30.86 QP	46.00	-15.14	1.00 H	212	15.24	15.62
4	465.10	28.46 QP	46.00	-17.54	1.50 H	24	9.07	19.39
5	599.98	32.96 QP	46.00	-13.04	1.50 H	244	9.82	23.14
6	700.11	30.87 QP	46.00	-15.13	1.00 H	215	5.62	25.25

ANTENNA POLARITY & TEST DISTANCE: VERTICAL AT 3 m								
No.	Freq. (MHz)	Emission Level (dBuV/m)	Limit (dBuV/m)	Margin (dB)	Antenna Height (m)	Table Angle (Degree)	Raw Value (dBuV)	Correction Factor (dB/m)
1	133.25	33.68 QP	43.50	-9.82	1.50 V	304	20.66	13.02
2	199.54	31.86 QP	43.50	-11.64	1.00 V	204	20.49	11.37
3	333.58	24.92 QP	46.00	-21.08	1.00 V	86	9.30	15.62
4	600.14	34.56 QP	46.00	-11.44	1.00 V	8	11.41	23.15
5	700.25	31.72 QP	46.00	-14.28	1.50 V	293	6.47	25.25
6	799.90	30.24 QP	46.00	-15.76	1.50 V	222	3.81	26.43

- REMARKS:**
1. Emission level (dBuV/m) = Raw Value (dBuV) + Correction Factor (dB/m).
  2. Correction Factor (dB/m) = Antenna Factor (dB/m) + Cable Factor (dB).
  3. The other emission levels were very low against the limit.
  4. Margin value = Emission level – Limit value.

**DRAFT 802.11n (40MHz) OFDM MODULATION:**

EUT TEST CONDITION		MEASUREMENT DETAIL	
CHANNEL	Channel 1	FREQUENCY RANGE	Below 1000MHz
MODULATION TYPE	BPSK	INPUT POWER (SYSTEM)	120Vac, 60 Hz
TRANSFER RATE	15.0Mbps	DETECTOR FUNCTION	Quasi-Peak
ENVIRONMENTAL CONDITIONS	23deg. C, 63% RH, 991hPa	TESTED BY	Brad Wu

ANTENNA POLARITY & TEST DISTANCE: HORIZONTAL AT 3 m								
No.	Freq. (MHz)	Emission Level (dBuV/m)	Limit (dBuV/m)	Margin (dB)	Antenna Height (m)	Table Angle (Degree)	Raw Value (dBuV)	Correction Factor (dB/m)
1	113.50	29.47 QP	43.50	-14.03	1.50 H	346	17.94	11.53
2	199.05	30.00 QP	43.50	-13.50	1.50 H	10	18.60	11.40
3	265.16	33.72 QP	46.00	-12.28	1.50 H	10	19.70	14.02
4	298.21	29.78 QP	46.00	-16.22	1.00 H	40	15.08	14.70
5	333.21	34.43 QP	46.00	-11.57	1.00 H	37	18.82	15.61
6	731.79	28.57 QP	46.00	-17.43	1.00 H	142	2.96	25.62

ANTENNA POLARITY & TEST DISTANCE: VERTICAL AT 3 m								
No.	Freq. (MHz)	Emission Level (dBuV/m)	Limit (dBuV/m)	Margin (dB)	Antenna Height (m)	Table Angle (Degree)	Raw Value (dBuV)	Correction Factor (dB/m)
1	132.95	32.89 QP	43.50	-10.61	1.50 V	10	19.89	13.00
2	354.60	31.87 QP	46.00	-14.13	1.50 V	184	15.70	16.17
3	442.09	31.45 QP	46.00	-14.55	1.00 V	226	12.80	18.65
4	593.74	31.05 QP	46.00	-14.95	1.00 V	106	8.08	22.98
5	665.68	39.35 QP	46.00	-6.65	1.00 V	100	14.77	24.57
6	700.68	34.21 QP	46.00	-11.79	1.00 V	106	8.95	25.26

- REMARKS:**
1. Emission level (dBuV/m) = Raw Value (dBuV) + Correction Factor (dB/m).
  2. Correction Factor (dB/m) = Antenna Factor (dB/m) + Cable Factor (dB).
  3. The other emission levels were very low against the limit.
  4. Margin value = Emission level – Limit value.

**802.11b DSSS MODULATION:**

EUT TEST CONDITION		MEASUREMENT DETAIL	
CHANNEL	Channel 1	FREQUENCY RANGE	1 ~ 25GHz
MODULATION TYPE	DBPSK	INPUT POWER (SYSTEM)	120Vac, 60 Hz
TRANSFER RATE	1.0Mbps	DETECTOR FUNCTION	Peak(PK) Average (AV)
ENVIRONMENTAL CONDITIONS	23deg. C, 63% RH, 991hPa	TESTED BY	Brad Wu

ANTENNA POLARITY & TEST DISTANCE: HORIZONTAL AT 3 m								
NO.	FREQ. (MHz)	EMISSION LEVEL (dBuV/m)	LIMIT (dBuV/m)	MARGIN (dB)	ANTENNA HEIGHT (m)	TABLE ANGLE (Degree)	RAW VALUE (dBuV)	CORRECTION FACTOR (dB/m)
1	2386.00	60.38 PK	74.00	-13.62	1.41 H	284	28.16	32.22
2	2386.00	51.02 AV	54.00	-2.98	1.41 H	284	18.80	32.22
3	*2412.00	106.15 PK			1.39 H	281	73.84	32.31
4	*2412.00	101.63 AV			1.39 H	281	69.32	32.31
5	4824.00	52.08 PK	74.00	-21.92	1.20 H	233	13.73	38.35
6	4824.00	47.02 AV	54.00	-6.98	1.20 H	233	8.67	38.35

ANTENNA POLARITY & TEST DISTANCE: VERTICAL AT 3 m								
NO.	FREQ. (MHz)	EMISSION LEVEL (dBuV/m)	LIMIT (dBuV/m)	MARGIN (dB)	ANTENNA HEIGHT (m)	TABLE ANGLE (Degree)	RAW VALUE (dBuV)	CORRECTION FACTOR (dB/m)
1	2390.00	56.25 PK	74.00	-17.75	1.27 V	158	24.02	32.23
2	2390.00	44.93 AV	54.00	-9.07	1.27 V	158	12.70	32.23
3	*2412.00	96.78 PK			1.27 V	158	64.47	32.31
4	*2412.00	91.43 AV			1.27 V	158	59.12	32.31
5	4824.00	54.28 PK	74.00	-19.72	1.26 V	264	15.93	38.35
6	4824.00	50.71 AV	54.00	-3.29	1.26 V	264	12.36	38.35

- REMARKS:**
1. Emission level (dBuV/m) = Raw Value (dBuV) + Correction Factor (dB/m).
  2. Correction Factor (dB/m) = Antenna Factor (dB/m) + Cable Factor (dB).
  3. The other emission levels were very low against the limit.
  4. Margin value = Emission level – Limit value.
  5. The limit value is defined as per 15.247.
  6. “ \* “: Fundamental frequency.

EUT TEST CONDITION		MEASUREMENT DETAIL	
CHANNEL	Channel 6	FREQUENCY RANGE	1 ~ 25GHz
MODULATION TYPE	DBPSK	INPUT POWER (SYSTEM)	120Vac, 60 Hz
TRANSFER RATE	1.0Mbps	DETECTOR FUNCTION	Peak(PK) Average (AV)
ENVIRONMENTAL CONDITIONS	23deg. C, 63% RH, 991hPa	TESTED BY	Brad Wu

ANTENNA POLARITY & TEST DISTANCE: HORIZONTAL AT 3 m								
NO.	FREQ. (MHz)	EMISSION LEVEL (dBuV/m)	LIMIT (dBuV/m)	MARGIN (dB)	ANTENNA HEIGHT (m)	TABLE ANGLE (Degree)	RAW VALUE (dBuV)	CORRECTION FACTOR (dB/m)
1	*2437.00	106.25 PK			1.31 H	249	73.84	32.41
2	*2437.00	101.92 AV			1.31 H	249	69.51	32.41
3	4874.00	52.19 PK	74.00	-21.81	1.12 H	243	13.73	38.46
4	4874.00	47.26 AV	54.00	-6.74	1.12 H	243	8.80	38.46

ANTENNA POLARITY & TEST DISTANCE: VERTICAL AT 3 m								
NO.	FREQ. (MHz)	EMISSION LEVEL (dBuV/m)	LIMIT (dBuV/m)	MARGIN (dB)	ANTENNA HEIGHT (m)	TABLE ANGLE (Degree)	RAW VALUE (dBuV)	CORRECTION FACTOR (dB/m)
1	*2437.00	96.92 PK			1.26 V	164	64.51	32.41
2	*2437.00	91.58 AV			1.26 V	164	59.17	32.41
3	4874.00	52.16 PK	74.00	-21.84	1.22 V	74	13.70	38.46
4	4874.00	48.53 AV	54.00	-5.47	1.22 V	74	10.07	38.46

- REMARKS:**
1. Emission level (dBuV/m) = Raw Value (dBuV) + Correction Factor (dB/m).
  2. Correction Factor (dB/m) = Antenna Factor (dB/m) + Cable Factor (dB).
  3. The other emission levels were very low against the limit.
  4. Margin value = Emission level – Limit value.
  5. The limit value is defined as per 15.247.
  6. “ \* “: Fundamental frequency.



EUT TEST CONDITION		MEASUREMENT DETAIL	
CHANNEL	Channel 11	FREQUENCY RANGE	1 ~ 25GHz
MODULATION TYPE	DBPSK	INPUT POWER (SYSTEM)	120Vac, 60 Hz
TRANSFER RATE	1.0Mbps	DETECTOR FUNCTION	Peak(PK) Average (AV)
ENVIRONMENTAL CONDITIONS	23deg. C, 63% RH, 991hPa	TESTED BY	Brad Wu

ANTENNA POLARITY & TEST DISTANCE: HORIZONTAL AT 3 m								
NO.	FREQ. (MHz)	EMISSION LEVEL (dBuV/m)	LIMIT (dBuV/m)	MARGIN (dB)	ANTENNA HEIGHT (m)	TABLE ANGLE (Degree)	RAW VALUE (dBuV)	CORRECTION FACTOR (dB/m)
1	*2462.00	106.36 PK			1.30 H	250	73.86	32.50
2	*2462.00	102.00 AV			1.30 H	250	69.50	32.50
3	2488.00	60.19 PK	74.00	-13.81	1.30 H	250	27.59	32.60
4	2488.00	51.47 AV	54.00	-2.53	1.30 H	250	18.87	32.60
5	4924.00	51.28 PK	74.00	-22.72	1.13 H	248	12.70	38.58
6	4924.00	44.45 AV	54.00	-9.55	1.13 H	248	5.87	38.58

ANTENNA POLARITY & TEST DISTANCE: VERTICAL AT 3 m								
NO.	FREQ. (MHz)	EMISSION LEVEL (dBuV/m)	LIMIT (dBuV/m)	MARGIN (dB)	ANTENNA HEIGHT (m)	TABLE ANGLE (Degree)	RAW VALUE (dBuV)	CORRECTION FACTOR (dB/m)
1	*2462.00	96.98 PK			1.25 V	161	64.48	32.50
2	*2462.00	91.65 AV			1.25 V	161	59.15	32.50
3	2488.00	56.13 PK	74.00	-17.87	1.25 V	161	23.53	32.60
4	2488.00	44.72 AV	54.00	-9.28	1.25 V	161	12.12	32.60
5	4924.00	52.18 PK	74.00	-21.82	1.45 V	107	13.60	38.58
6	4924.00	46.49 AV	54.00	-7.51	1.45 V	107	7.91	38.58

- REMARKS:**
1. Emission level (dBuV/m) = Raw Value (dBuV) + Correction Factor (dB/m).
  2. Correction Factor (dB/m) = Antenna Factor (dB/m) + Cable Factor (dB).
  3. The other emission levels were very low against the limit.
  4. Margin value = Emission level – Limit value.
  5. The limit value is defined as per 15.247.
  6. “ \* “: Fundamental frequency.

**802.11g OFDM MODULATION:**

EUT TEST CONDITION		MEASUREMENT DETAIL	
CHANNEL	Channel 1	FREQUENCY RANGE	1 ~ 25GHz
MODULATION TYPE	BPSK	INPUT POWER (SYSTEM)	120Vac, 60 Hz
TRANSFER RATE	6.0Mbps	DETECTOR FUNCTION	Peak(PK) Average (AV)
ENVIRONMENTAL CONDITIONS	23deg. C, 63% RH, 991hPa	TESTED BY	Brad Wu

ANTENNA POLARITY & TEST DISTANCE: HORIZONTAL AT 3 m								
NO.	FREQ. (MHz)	EMISSION LEVEL (dBuV/m)	LIMIT (dBuV/m)	MARGIN (dB)	ANTENNA HEIGHT (m)	TABLE ANGLE (Degree)	RAW VALUE (dBuV)	CORRECTION FACTOR (dB/m)
1	2390.00	63.08 PK	74.00	-10.92	1.00 H	49	30.85	32.23
2	2390.00	52.06 AV	54.00	-1.94	1.00 H	49	19.83	32.23
3	*2412.00	109.34 PK			1.00 H	49	77.03	32.31
4	*2412.00	97.56 AV			1.00 H	49	65.25	32.31
5	4824.00	51.23 PK	74.00	-22.77	1.15 H	213	12.88	38.35
6	4824.00	37.05 AV	54.00	-16.95	1.15 H	213	-1.30	38.35

ANTENNA POLARITY & TEST DISTANCE: VERTICAL AT 3 m								
NO.	FREQ. (MHz)	EMISSION LEVEL (dBuV/m)	LIMIT (dBuV/m)	MARGIN (dB)	ANTENNA HEIGHT (m)	TABLE ANGLE (Degree)	RAW VALUE (dBuV)	CORRECTION FACTOR (dB/m)
1	2390.00	53.89 PK	74.00	-20.11	1.35 V	216	21.66	32.23
2	2390.00	42.81 AV	54.00	-11.19	1.35 V	216	10.58	32.23
3	*2412.00	98.20 PK			1.35 V	216	65.89	32.31
4	*2412.00	86.42 AV			1.35 V	216	54.11	32.31
5	4824.00	51.09 PK	74.00	-22.91	1.11 V	56	12.74	38.35
6	4824.00	36.81 AV	54.00	-17.19	1.11 V	56	-1.54	38.35

- REMARKS:**
1. Emission level (dBuV/m) = Raw Value (dBuV) + Correction Factor (dB/m).
  2. Correction Factor (dB/m) = Antenna Factor (dB/m) + Cable Factor (dB).
  3. The other emission levels were very low against the limit.
  4. Margin value = Emission level – Limit value.
  5. The limit value is defined as per 15.247.
  6. “ \* “: Fundamental frequency.

EUT TEST CONDITION		MEASUREMENT DETAIL	
CHANNEL	Channel 6	FREQUENCY RANGE	1 ~ 25GHz
MODULATION TYPE	BPSK	INPUT POWER (SYSTEM)	120Vac, 60 Hz
TRANSFER RATE	6.0Mbps	DETECTOR FUNCTION	Peak(PK) Average (AV)
ENVIRONMENTAL CONDITIONS	23deg. C, 63% RH, 991hPa	TESTED BY	Brad Wu

ANTENNA POLARITY & TEST DISTANCE: HORIZONTAL AT 3 m								
NO.	FREQ. (MHz)	EMISSION LEVEL (dBuV/m)	LIMIT (dBuV/m)	MARGIN (dB)	ANTENNA HEIGHT (m)	TABLE ANGLE (Degree)	RAW VALUE (dBuV)	CORRECTION FACTOR (dB/m)
1	*2437.00	109.05 PK			1.01 H	52	76.64	32.41
2	*2437.00	97.23 AV			1.01 H	52	64.82	32.41
3	4874.00	50.18 PK	74.00	-23.82	1.21 H	59	11.72	38.46
4	4874.00	36.20 AV	54.00	-17.80	1.21 H	59	-2.26	38.46

ANTENNA POLARITY & TEST DISTANCE: VERTICAL AT 3 m								
NO.	FREQ. (MHz)	EMISSION LEVEL (dBuV/m)	LIMIT (dBuV/m)	MARGIN (dB)	ANTENNA HEIGHT (m)	TABLE ANGLE (Degree)	RAW VALUE (dBuV)	CORRECTION FACTOR (dB/m)
1	*2437.00	98.01 PK			1.34 V	218	65.60	32.41
2	*2437.00	86.35 AV			1.34 V	218	53.94	32.41
3	4874.00	51.12 PK	74.00	-22.88	1.08 V	54	12.66	38.46
4	4874.00	36.95 AV	54.00	-17.05	1.08 V	54	-1.51	38.46

- REMARKS:**
1. Emission level (dBuV/m) = Raw Value (dBuV) + Correction Factor (dB/m).
  2. Correction Factor (dB/m) = Antenna Factor (dB/m) + Cable Factor (dB).
  3. The other emission levels were very low against the limit.
  4. Margin value = Emission level – Limit value.
  5. The limit value is defined as per 15.247.
  6. “ \* “: Fundamental frequency.

EUT TEST CONDITION		MEASUREMENT DETAIL	
CHANNEL	Channel 11	FREQUENCY RANGE	1 ~ 25GHz
MODULATION TYPE	BPSK	INPUT POWER (SYSTEM)	120Vac, 60 Hz
TRANSFER RATE	6.0Mbps	DETECTOR FUNCTION	Peak(PK) Average (AV)
ENVIRONMENTAL CONDITIONS	23deg. C, 63% RH, 991hPa	TESTED BY	Brad Wu

ANTENNA POLARITY & TEST DISTANCE: HORIZONTAL AT 3 m								
NO.	FREQ. (MHz)	EMISSION LEVEL (dBuV/m)	LIMIT (dBuV/m)	MARGIN (dB)	ANTENNA HEIGHT (m)	TABLE ANGLE (Degree)	RAW VALUE (dBuV)	CORRECTION FACTOR (dB/m)
1	*2462.00	108.65 PK			1.00 H	52	76.15	32.50
2	*2462.00	97.17 AV			1.00 H	52	64.67	32.50
3	2483.50	63.41 PK	74.00	-10.59	1.00 H	58	30.83	32.58
4	2483.50	51.72 AV	54.00	-2.28	1.00 H	58	19.14	32.58
5	4924.00	51.09 PK	74.00	-22.91	1.22 H	98	12.51	38.58
6	4924.00	36.78 AV	54.00	-17.22	1.22 H	98	-1.80	38.58

ANTENNA POLARITY & TEST DISTANCE: VERTICAL AT 3 m								
NO.	FREQ. (MHz)	EMISSION LEVEL (dBuV/m)	LIMIT (dBuV/m)	MARGIN (dB)	ANTENNA HEIGHT (m)	TABLE ANGLE (Degree)	RAW VALUE (dBuV)	CORRECTION FACTOR (dB/m)
1	*2462.00	97.86 PK			1.32 V	208	65.36	32.50
2	*2462.00	86.02 AV			1.32 V	208	53.52	32.50
3	2483.50	53.71 PK	74.00	-20.29	1.32 V	208	21.13	32.58
4	2483.50	42.68 AV	54.00	-11.32	1.32 V	208	10.10	32.58
5	4924.00	51.28 PK	74.00	-22.72	1.15 V	22	12.70	38.58
6	4924.00	37.05 AV	54.00	-16.95	1.15 V	22	-1.53	38.58

- REMARKS:**
1. Emission level (dBuV/m) = Raw Value (dBuV) + Correction Factor (dB/m).
  2. Correction Factor (dB/m) = Antenna Factor (dB/m) + Cable Factor (dB).
  3. The other emission levels were very low against the limit.
  4. Margin value = Emission level – Limit value.
  5. The limit value is defined as per 15.247.
  6. “ \* “: Fundamental frequency.

**DRAFT 802.11n (20MHz) OFDM MODULATION:**

EUT TEST CONDITION		MEASUREMENT DETAIL	
CHANNEL	Channel 1	FREQUENCY RANGE	1 ~ 25GHz
MODULATION TYPE	BPSK	INPUT POWER (SYSTEM)	120Vac, 60 Hz
TRANSFER RATE	7.2Mbps	DETECTOR FUNCTION	Peak(PK) Average (AV)
ENVIRONMENTAL CONDITIONS	23deg. C, 63% RH, 991hPa	TESTED BY	Brad Wu

ANTENNA POLARITY & TEST DISTANCE: HORIZONTAL AT 3 m								
NO.	FREQ. (MHz)	EMISSION LEVEL (dBuV/m)	LIMIT (dBuV/m)	MARGIN (dB)	ANTENNA HEIGHT (m)	TABLE ANGLE (Degree)	RAW VALUE (dBuV)	CORRECTION FACTOR (dB/m)
1	2360.00	62.68 PK	74.00	-11.32	1.42 H	283	30.56	32.12
2	2360.00	51.13 AV	54.00	-2.87	1.42 H	283	19.01	32.12
3	2390.00	62.59 PK	74.00	-11.41	1.41 H	284	30.36	32.23
4	2390.00	49.63 AV	54.00	-4.37	1.41 H	284	17.40	32.23
5	*2412.00	111.04 PK			1.38 H	282	78.73	32.31
6	*2412.00	101.63 AV			1.38 H	282	69.32	32.31
7	4824.00	50.88 PK	74.00	-23.12	1.17 H	229	12.53	38.35
8	4824.00	36.59 AV	54.00	-17.41	1.17 H	229	-1.76	38.35

ANTENNA POLARITY & TEST DISTANCE: VERTICAL AT 3 m								
NO.	FREQ. (MHz)	EMISSION LEVEL (dBuV/m)	LIMIT (dBuV/m)	MARGIN (dB)	ANTENNA HEIGHT (m)	TABLE ANGLE (Degree)	RAW VALUE (dBuV)	CORRECTION FACTOR (dB/m)
1	2390.00	53.68 PK	74.00	-20.32	1.25 V	84	21.45	32.23
2	2390.00	40.82 AV	54.00	-13.18	1.25 V	84	8.59	32.23
3	*2412.00	100.23 PK			1.25 V	84	67.92	32.31
4	*2412.00	90.85 AV			1.25 V	84	58.54	32.31
5	4824.00	49.85 PK	74.00	-24.15	1.20 V	81	11.50	38.35
6	4824.00	35.41 AV	54.00	-18.59	1.20 V	81	-2.94	38.35

- REMARKS:**
1. Emission level (dBuV/m) = Raw Value (dBuV) + Correction Factor (dB/m).
  2. Correction Factor (dB/m) = Antenna Factor (dB/m) + Cable Factor (dB).
  3. The other emission levels were very low against the limit.
  4. Margin value = Emission level – Limit value.
  5. The limit value is defined as per 15.247.
  6. “ \* “: Fundamental frequency.

EUT TEST CONDITION		MEASUREMENT DETAIL	
CHANNEL	Channel 6	FREQUENCY RANGE	1 ~ 25GHz
MODULATION TYPE	BPSK	INPUT POWER (SYSTEM)	120Vac, 60 Hz
TRANSFER RATE	7.2Mbps	DETECTOR FUNCTION	Peak(PK) Average (AV)
ENVIRONMENTAL CONDITIONS	23deg. C, 63% RH, 991hPa	TESTED BY	Brad Wu

ANTENNA POLARITY & TEST DISTANCE: HORIZONTAL AT 3 m								
NO.	FREQ. (MHz)	EMISSION LEVEL (dBuV/m)	LIMIT (dBuV/m)	MARGIN (dB)	ANTENNA HEIGHT (m)	TABLE ANGLE (Degree)	RAW VALUE (dBuV)	CORRECTION FACTOR (dB/m)
1	*2437.00	110.86 PK			1.39 H	280	78.45	32.41
2	*2437.00	101.45 AV			1.39 H	280	69.04	32.41
3	4874.00	50.96 PK	74.00	-23.04	1.13 H	249	12.50	38.46
4	4874.00	36.72 AV	54.00	-17.28	1.13 H	249	-1.74	38.46

ANTENNA POLARITY & TEST DISTANCE: VERTICAL AT 3 m								
NO.	FREQ. (MHz)	EMISSION LEVEL (dBuV/m)	LIMIT (dBuV/m)	MARGIN (dB)	ANTENNA HEIGHT (m)	TABLE ANGLE (Degree)	RAW VALUE (dBuV)	CORRECTION FACTOR (dB/m)
1	*2437.00	100.02 PK			1.26 V	90	67.61	32.41
2	*2437.00	90.52 AV			1.26 V	90	58.11	32.41
3	4874.00	49.23 PK	74.00	-24.77	1.13 V	68	10.77	38.46
4	4874.00	34.80 AV	54.00	-19.20	1.13 V	68	-3.66	38.46

- REMARKS:**
1. Emission level (dBuV/m) = Raw Value (dBuV) + Correction Factor (dB/m).
  2. Correction Factor (dB/m) = Antenna Factor (dB/m) + Cable Factor (dB).
  3. The other emission levels were very low against the limit.
  4. Margin value = Emission level – Limit value.
  5. The limit value is defined as per 15.247.
  6. “ \* “: Fundamental frequency.

EUT TEST CONDITION		MEASUREMENT DETAIL	
CHANNEL	Channel 11	FREQUENCY RANGE	1 ~ 25GHz
MODULATION TYPE	BPSK	INPUT POWER (SYSTEM)	120Vac, 60 Hz
TRANSFER RATE	7.2Mbps	DETECTOR FUNCTION	Peak(PK) Average (AV)
ENVIRONMENTAL CONDITIONS	23deg. C, 63% RH, 991hPa	TESTED BY	Brad Wu

ANTENNA POLARITY & TEST DISTANCE: HORIZONTAL AT 3 m								
NO.	FREQ. (MHz)	EMISSION LEVEL (dBuV/m)	LIMIT (dBuV/m)	MARGIN (dB)	ANTENNA HEIGHT (m)	TABLE ANGLE (Degree)	RAW VALUE (dBuV)	CORRECTION FACTOR (dB/m)
1	*2462.00	111.27 PK			1.19 H	65	78.77	32.50
2	*2462.00	101.88 AV			1.19 H	65	69.38	32.50
3	2483.50	69.18 PK	74.00	-4.82	1.25 H	72	36.60	32.58
4	2483.50	52.60 AV	54.00	-1.40	1.25 H	72	20.02	32.58
5	4924.00	50.13 PK	74.00	-23.87	1.12 H	53	11.55	38.58
6	4924.00	35.69 AV	54.00	-18.31	1.12 H	53	-2.89	38.58

ANTENNA POLARITY & TEST DISTANCE: VERTICAL AT 3 m								
NO.	FREQ. (MHz)	EMISSION LEVEL (dBuV/m)	LIMIT (dBuV/m)	MARGIN (dB)	ANTENNA HEIGHT (m)	TABLE ANGLE (Degree)	RAW VALUE (dBuV)	CORRECTION FACTOR (dB/m)
1	*2462.00	100.46 PK			1.21 V	90	67.96	32.50
2	*2462.00	91.01 AV			1.21 V	90	58.51	32.50
3	2483.50	53.98 PK	74.00	-20.02	1.21 V	90	21.40	32.58
4	2483.50	41.11 AV	54.00	-12.89	1.21 V	90	8.53	32.58
5	4924.00	49.61 PK	74.00	-24.39	1.31 V	321	11.03	38.58
6	4924.00	35.20 AV	54.00	-18.80	1.31 V	321	-3.38	38.58

- REMARKS:**
1. Emission level (dBuV/m) = Raw Value (dBuV) + Correction Factor (dB/m).
  2. Correction Factor (dB/m) = Antenna Factor (dB/m) + Cable Factor (dB).
  3. The other emission levels were very low against the limit.
  4. Margin value = Emission level – Limit value.
  5. The limit value is defined as per 15.247.
  6. “ \* “: Fundamental frequency.

**DRAFT 802.11n (40MHz) OFDM MODULATION:**

EUT TEST CONDITION		MEASUREMENT DETAIL	
CHANNEL	Channel 1	FREQUENCY RANGE	1 ~ 25GHz
MODULATION TYPE	BPSK	INPUT POWER (SYSTEM)	120Vac, 60 Hz
TRANSFER RATE	15.0Mbps	DETECTOR FUNCTION	Peak(PK) Average (AV)
ENVIRONMENTAL CONDITIONS	23deg. C, 63% RH, 991hPa	TESTED BY	Brad Wu

ANTENNA POLARITY & TEST DISTANCE: HORIZONTAL AT 3 m								
NO.	FREQ. (MHz)	EMISSION LEVEL (dBuV/m)	LIMIT (dBuV/m)	MARGIN (dB)	ANTENNA HEIGHT (m)	TABLE ANGLE (Degree)	RAW VALUE (dBuV)	CORRECTION FACTOR (dB/m)
1	2390.00	70.37 PK	74.00	-3.63	1.04 H	47	38.14	32.23
2	2390.00	52.84 AV	54.00	-1.16	1.04 H	47	20.61	32.23
3	*2422.00	104.50 PK			1.00 H	47	72.15	32.35
4	*2422.00	94.71 AV			1.00 H	47	62.36	32.35
5	4844.00	50.35 PK	74.00	-23.65	1.09 H	25	11.96	38.39
6	4844.00	36.03 AV	54.00	-17.97	1.09 H	25	-2.36	38.39

ANTENNA POLARITY & TEST DISTANCE: VERTICAL AT 3 m								
NO.	FREQ. (MHz)	EMISSION LEVEL (dBuV/m)	LIMIT (dBuV/m)	MARGIN (dB)	ANTENNA HEIGHT (m)	TABLE ANGLE (Degree)	RAW VALUE (dBuV)	CORRECTION FACTOR (dB/m)
1	2390.00	61.48 PK	74.00	-12.52	1.21 V	65	29.25	32.23
2	2390.00	43.92 AV	54.00	-10.08	1.21 V	65	11.69	32.23
3	*2422.00	94.76 PK			1.21 V	65	62.41	32.35
4	*2422.00	84.92 AV			1.21 V	65	52.57	32.35
5	4844.00	50.22 PK	74.00	-23.78	1.18 V	64	11.83	38.39
6	4844.00	35.93 AV	54.00	-18.07	1.18 V	64	-2.46	38.39

- REMARKS:**
1. Emission level (dBuV/m) = Raw Value (dBuV) + Correction Factor (dB/m).
  2. Correction Factor (dB/m) = Antenna Factor (dB/m) + Cable Factor (dB).
  3. The other emission levels were very low against the limit.
  4. Margin value = Emission level – Limit value.
  5. The limit value is defined as per 15.247.
  6. “ \* “: Fundamental frequency.



EUT TEST CONDITION		MEASUREMENT DETAIL	
CHANNEL	Channel 4	FREQUENCY RANGE	1 ~ 25GHz
MODULATION TYPE	BPSK	INPUT POWER (SYSTEM)	120Vac, 60 Hz
TRANSFER RATE	15.0Mbps	DETECTOR FUNCTION	Peak(PK) Average (AV)
ENVIRONMENTAL CONDITIONS	23deg. C, 63% RH, 991hPa	TESTED BY	Brad Wu

ANTENNA POLARITY & TEST DISTANCE: HORIZONTAL AT 3 m								
NO.	FREQ. (MHz)	EMISSION LEVEL (dBuV/m)	LIMIT (dBuV/m)	MARGIN (dB)	ANTENNA HEIGHT (m)	TABLE ANGLE (Degree)	RAW VALUE (dBuV)	CORRECTION FACTOR (dB/m)
1	*2437.00	104.20 PK			1.02 H	51	71.79	32.41
2	*2437.00	94.39 AV			1.02 H	51	61.98	32.41
3	4874.00	50.69 PK	74.00	-23.31	1.11 H	59	12.23	38.46
4	4874.00	36.38 AV	54.00	-17.62	1.11 H	59	-2.08	38.46

ANTENNA POLARITY & TEST DISTANCE: VERTICAL AT 3 m								
NO.	FREQ. (MHz)	EMISSION LEVEL (dBuV/m)	LIMIT (dBuV/m)	MARGIN (dB)	ANTENNA HEIGHT (m)	TABLE ANGLE (Degree)	RAW VALUE (dBuV)	CORRECTION FACTOR (dB/m)
1	*2437.00	94.56 PK			1.20 V	66	62.15	32.41
2	*2437.00	84.71 AV			1.20 V	66	52.30	32.41
3	4874.00	50.46 PK	74.00	-23.54	1.16 V	23	12.00	38.46
4	4874.00	36.18 AV	54.00	-17.82	1.16 V	23	-2.28	38.46

- REMARKS:**
1. Emission level (dBuV/m) = Raw Value (dBuV) + Correction Factor (dB/m).
  2. Correction Factor (dB/m) = Antenna Factor (dB/m) + Cable Factor (dB).
  3. The other emission levels were very low against the limit.
  4. Margin value = Emission level – Limit value.
  5. The limit value is defined as per 15.247.
  6. “ \* “: Fundamental frequency.

EUT TEST CONDITION		MEASUREMENT DETAIL	
CHANNEL	Channel 7	FREQUENCY RANGE	1 ~ 25GHz
MODULATION TYPE	BPSK	INPUT POWER (SYSTEM)	120Vac, 60 Hz
TRANSFER RATE	15.0Mbps	DETECTOR FUNCTION	Peak(PK) Average (AV)
ENVIRONMENTAL CONDITIONS	23deg. C, 63% RH, 991hPa	TESTED BY	Brad Wu

ANTENNA POLARITY & TEST DISTANCE: HORIZONTAL AT 3 m								
NO.	FREQ. (MHz)	EMISSION LEVEL (dBuV/m)	LIMIT (dBuV/m)	MARGIN (dB)	ANTENNA HEIGHT (m)	TABLE ANGLE (Degree)	RAW VALUE (dBuV)	CORRECTION FACTOR (dB/m)
1	*2452.00	103.83 PK			1.02 H	48	71.37	32.46
2	*2452.00	94.30 AV			1.02 H	48	61.84	32.46
3	2483.50	63.00 PK	74.00	-11.00	1.00 H	48	30.42	32.58
4	2483.50	50.83 AV	54.00	-3.17	1.00 H	48	18.25	32.58
5	4904.00	50.01 PK	74.00	-23.99	1.12 H	54	11.48	38.53
6	4904.00	35.76 AV	54.00	-18.24	1.12 H	54	-2.77	38.53

ANTENNA POLARITY & TEST DISTANCE: VERTICAL AT 3 m								
NO.	FREQ. (MHz)	EMISSION LEVEL (dBuV/m)	LIMIT (dBuV/m)	MARGIN (dB)	ANTENNA HEIGHT (m)	TABLE ANGLE (Degree)	RAW VALUE (dBuV)	CORRECTION FACTOR (dB/m)
1	*2452.00	94.11 PK			1.21 V	72	61.65	32.46
2	*2452.00	84.35 AV			1.21 V	72	51.89	32.46
3	2483.50	61.23 PK	74.00	-12.77	1.21 V	72	28.65	32.58
4	2483.50	43.52 AV	54.00	-10.48	1.21 V	72	10.94	32.58
5	4904.00	50.46 PK	74.00	-23.54	1.14 V	209	11.93	38.53
6	4904.00	36.21 AV	54.00	-17.79	1.14 V	209	-2.32	38.53

- REMARKS:**
1. Emission level (dBuV/m) = Raw Value (dBuV) + Correction Factor (dB/m).
  2. Correction Factor (dB/m) = Antenna Factor (dB/m) + Cable Factor (dB).
  3. The other emission levels were very low against the limit.
  4. Margin value = Emission level – Limit value.
  5. The limit value is defined as per 15.247.
  6. “ \* “: Fundamental frequency.

### 4.3 6dB BANDWIDTH MEASUREMENT

#### 4.3.1 LIMITS OF 6dB BANDWIDTH MEASUREMENT

The minimum of 6dB Bandwidth Measurement is 0.5 MHz.

#### 4.3.2 TEST INSTRUMENTS

DESCRIPTION & MANUFACTURER	MODEL NO.	SERIAL NO.	CALIBRATED UNTIL
SPECTRUM ANALYZER	FSP40	100040	Jun. 07, 2007

**NOTE:** The calibration interval of the above test instruments is 12 months and the calibrations are traceable to NML/ROC and NIST/USA.

#### 4.3.3 TEST PROCEDURE

The transmitter output was connected to the spectrum analyzer through an attenuator. The bandwidth of the fundamental frequency was measured by spectrum analyzer with 100kHz RBW and 100kHz VBW. The 6dB bandwidth is defined as the total spectrum the power of which is higher than peak power minus 6dB.

#### 4.3.4 DEVIATION FROM TEST STANDARD

No deviation

#### 4.3.5 TEST SETUP

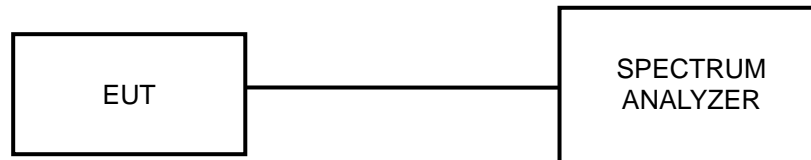

#### 4.3.6 EUT OPERATING CONDITIONS

The software provided by client to enable the EUT under transmission condition continuously at lowest, middle and highest channel frequencies individually.

### 4.3.7 TEST RESULTS

#### 802.11b DSSS MODULATION:

<b>MODULATION TYPE</b>	DBPSK	<b>TRANSFER RATE</b>	1.0Mbps
<b>INPUT POWER (SYSTEM)</b>	120Vac, 60 Hz	<b>ENVIRONMENTAL CONDITIONS</b>	25 deg. C, 63% RH, 991hPa
<b>TESTED BY</b>	Long Chen		

CHANNEL	CHANNEL FREQUENCY (MHz)	6dB BANDWIDTH (MHz)	MINIMUM LIMIT (MHz)	PASS / FAIL
1	2412	12.32	0.5	PASS
6	2437	12.24	0.5	PASS
11	2462	12.24	0.5	PASS

#### CH 1

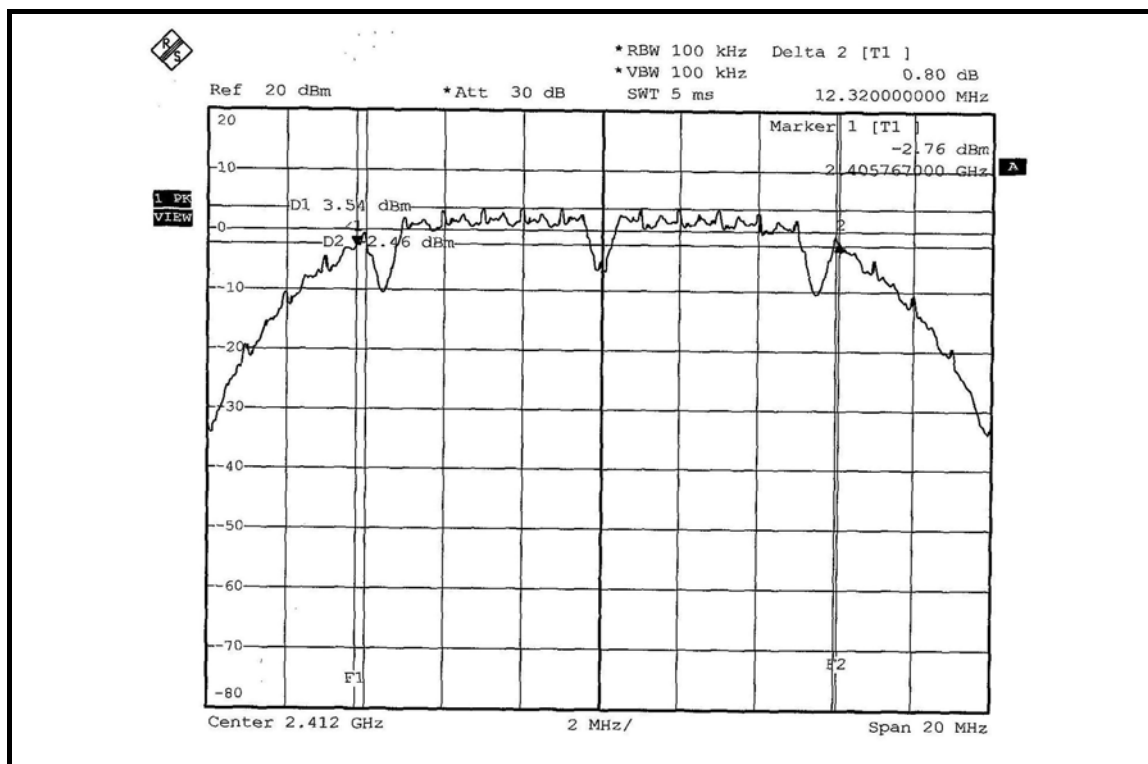

CH 6

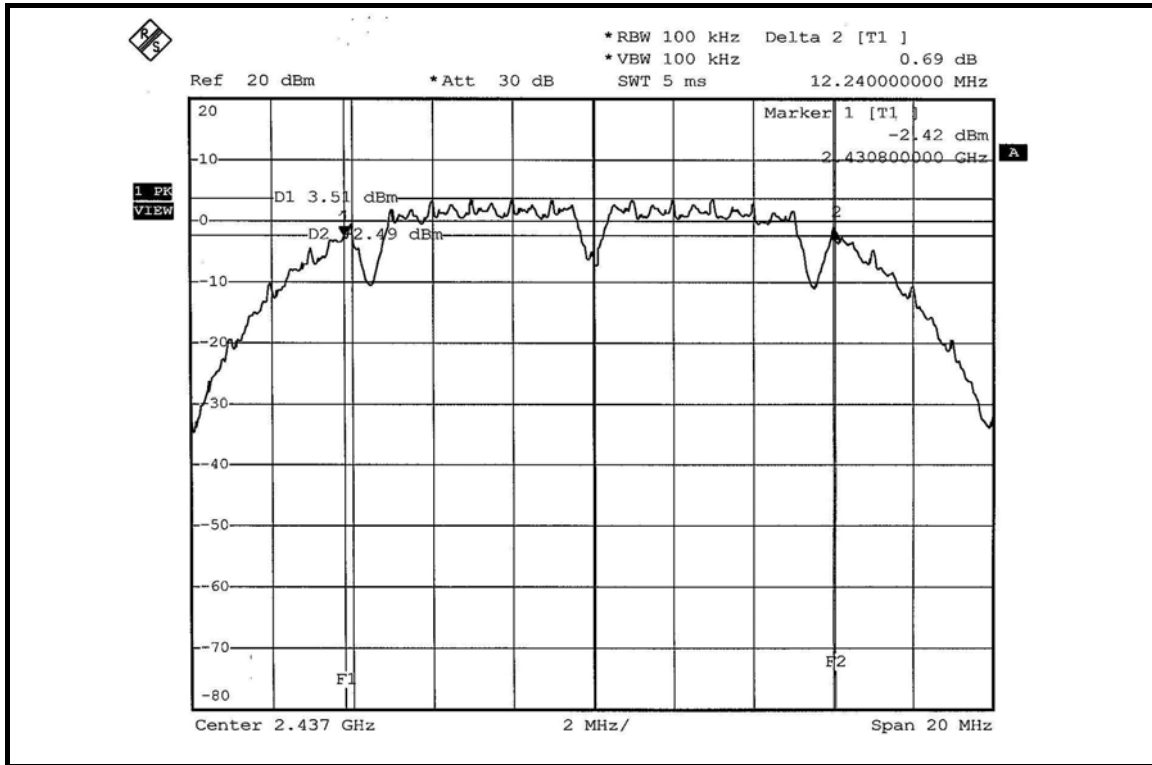

CH 11

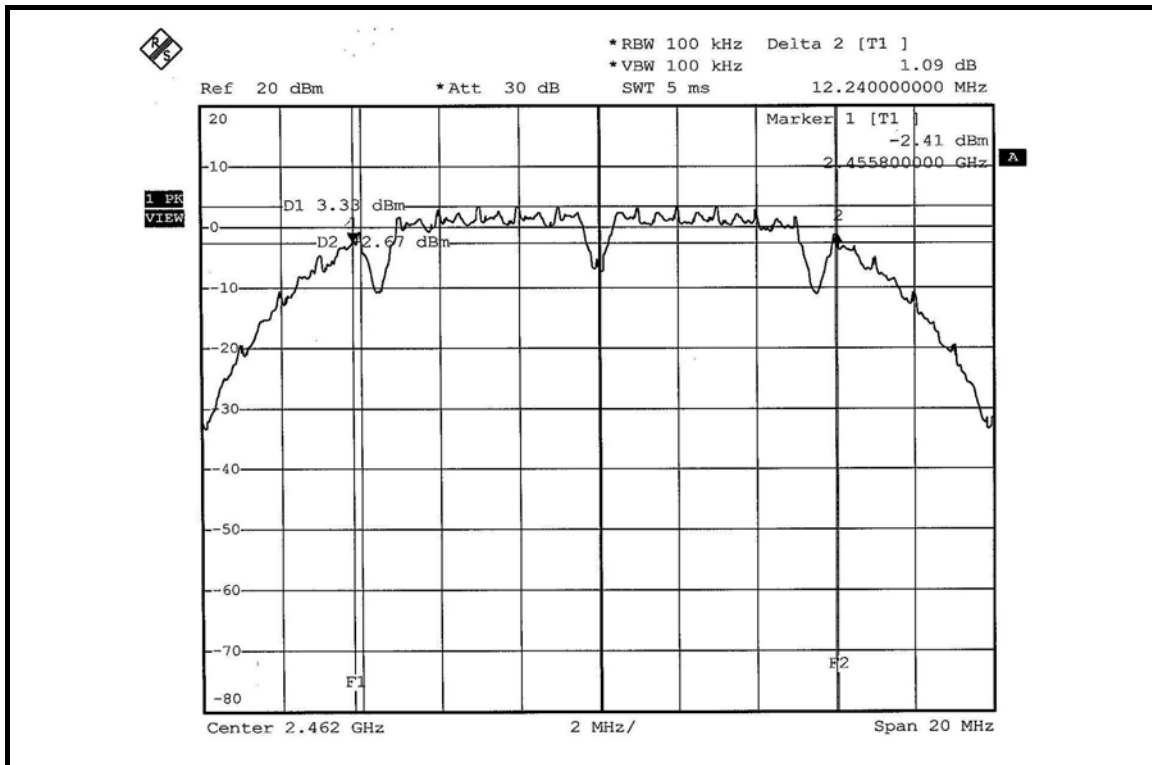

**802.11g OFDM MODULATION:**

<b>MODULATION TYPE</b>	BPSK	<b>TRANSFER RATE</b>	6.0Mbps
<b>INPUT POWER (SYSTEM)</b>	120Vac, 60 Hz	<b>ENVIRONMENTAL CONDITIONS</b>	25 deg. C, 63% RH, 991hPa
<b>TESTED BY</b>	Long Chen		

CHANNEL	CHANNEL FREQUENCY (MHz)	6dB BANDWIDTH (MHz)	MINIMUM LIMIT (MHz)	PASS / FAIL
1	2412	16.60	0.5	PASS
6	2437	16.60	0.5	PASS
11	2462	16.57	0.5	PASS

**CH 1**

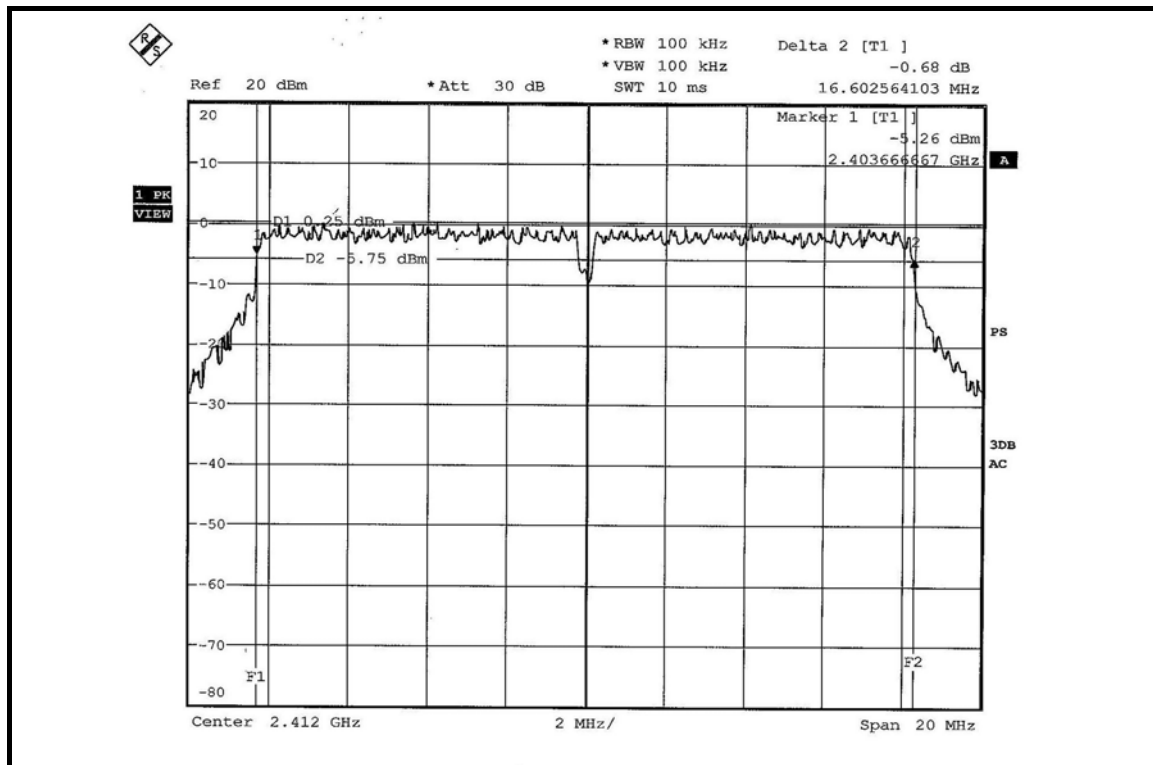

CH 6

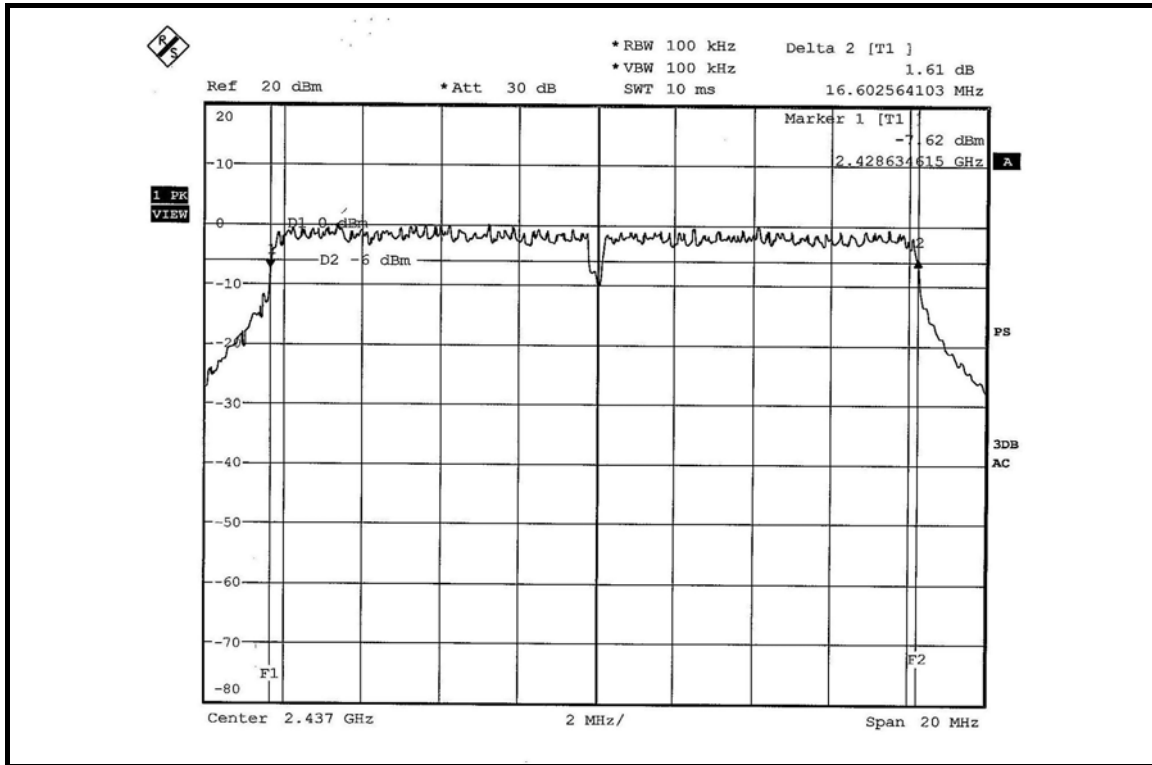

CH 11

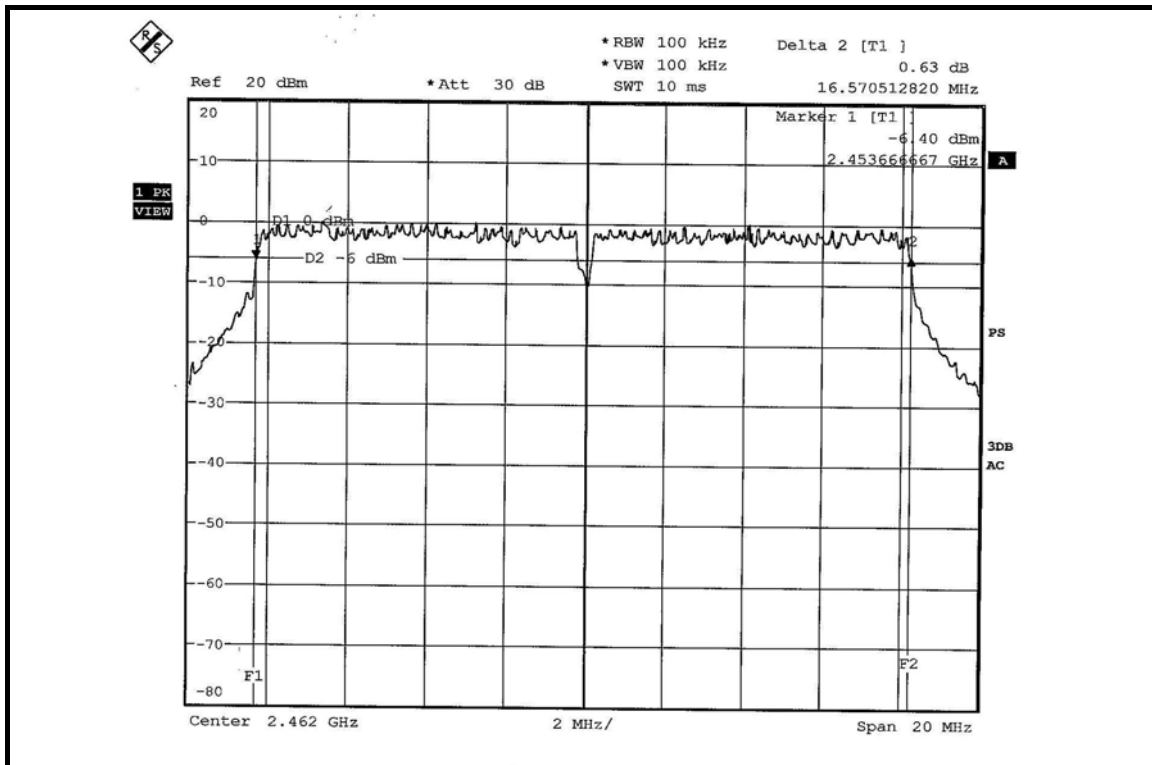



**DRAFT 802.11n (20MHz) OFDM MODULATION:**

<b>MODULATION TYPE</b>	BPSK	<b>TRANSFER RATE</b>	7.2Mbps
<b>INPUT POWER (SYSTEM)</b>	120Vac, 60 Hz	<b>ENVIRONMENTAL CONDITIONS</b>	25 deg. C, 63% RH, 991hPa
<b>TESTED BY</b>	Long Chen		

CHANNEL	CHANNEL FREQUENCY (MHz)	6dB BANDWIDTH (MHz)		MINIMUM LIMIT (MHz)	PASS / FAIL
		CHAIN 0	CHAIN 1		
1	2412	17.72	17.66	0.5	PASS
6	2437	17.63	17.72	0.5	PASS
11	2462	17.66	17.63	0.5	PASS

**FOR CHAIN 0: CH 1**

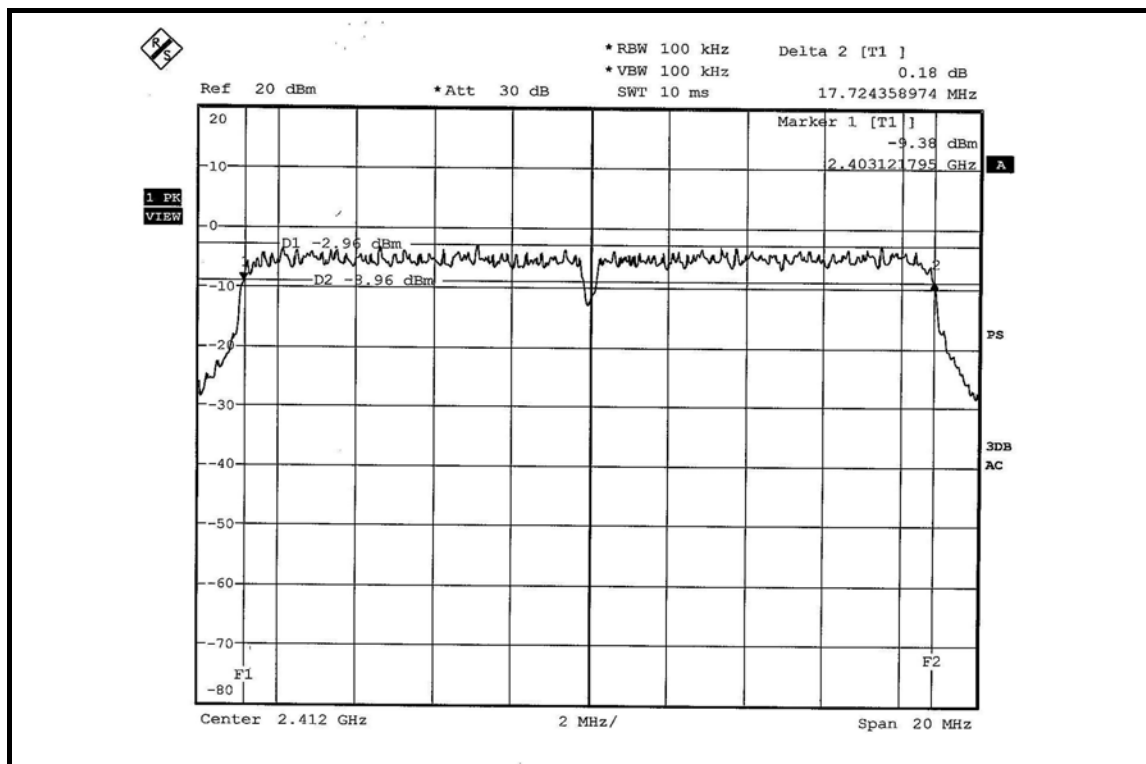

CH 6

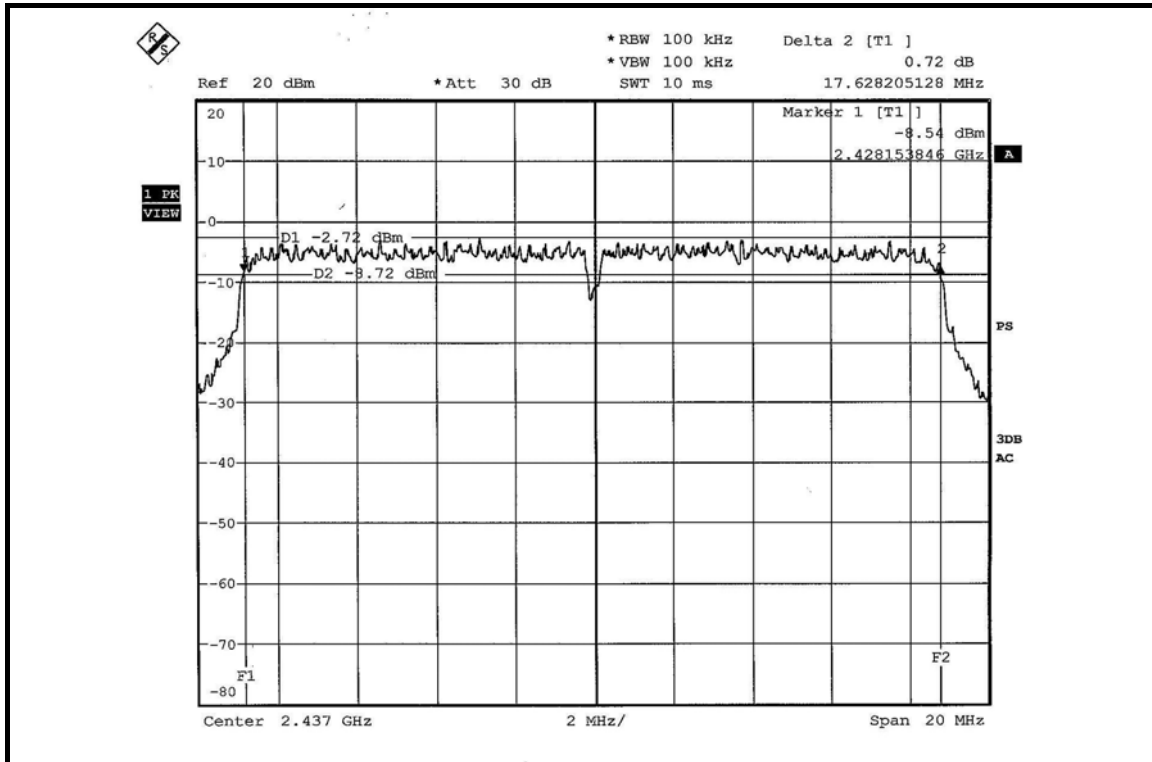

CH 11

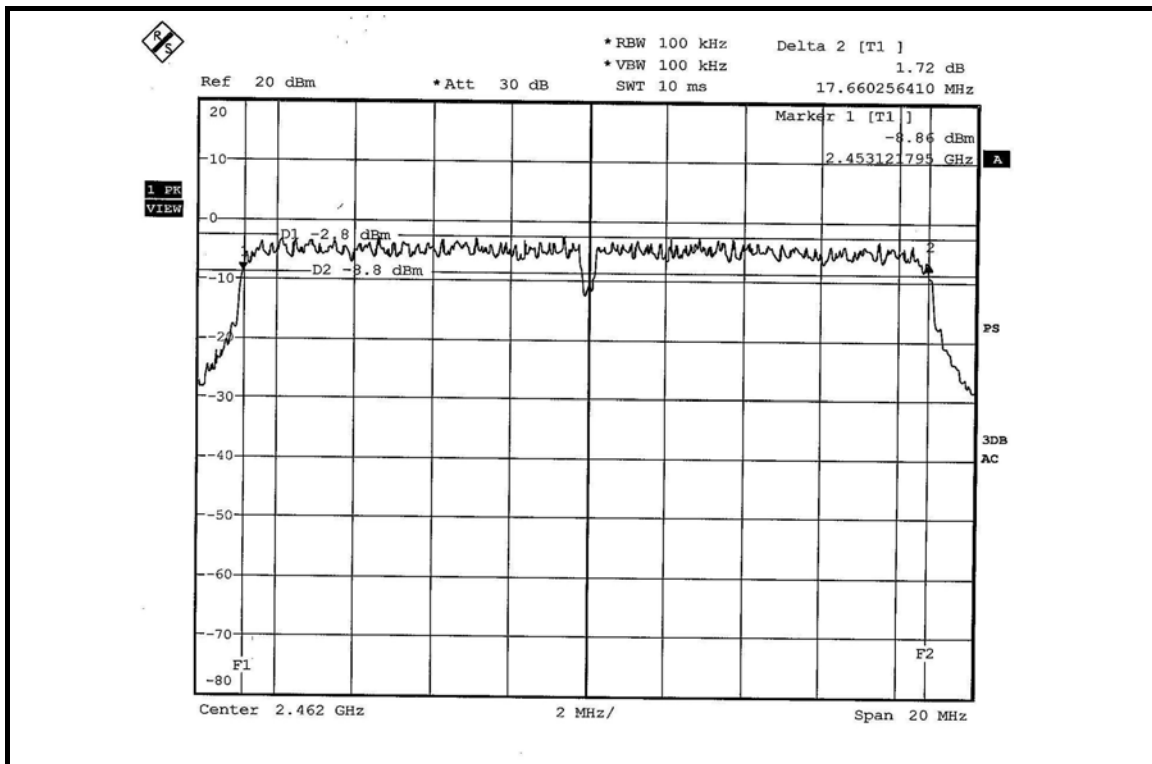

FOR CHAIN 1: CH 1

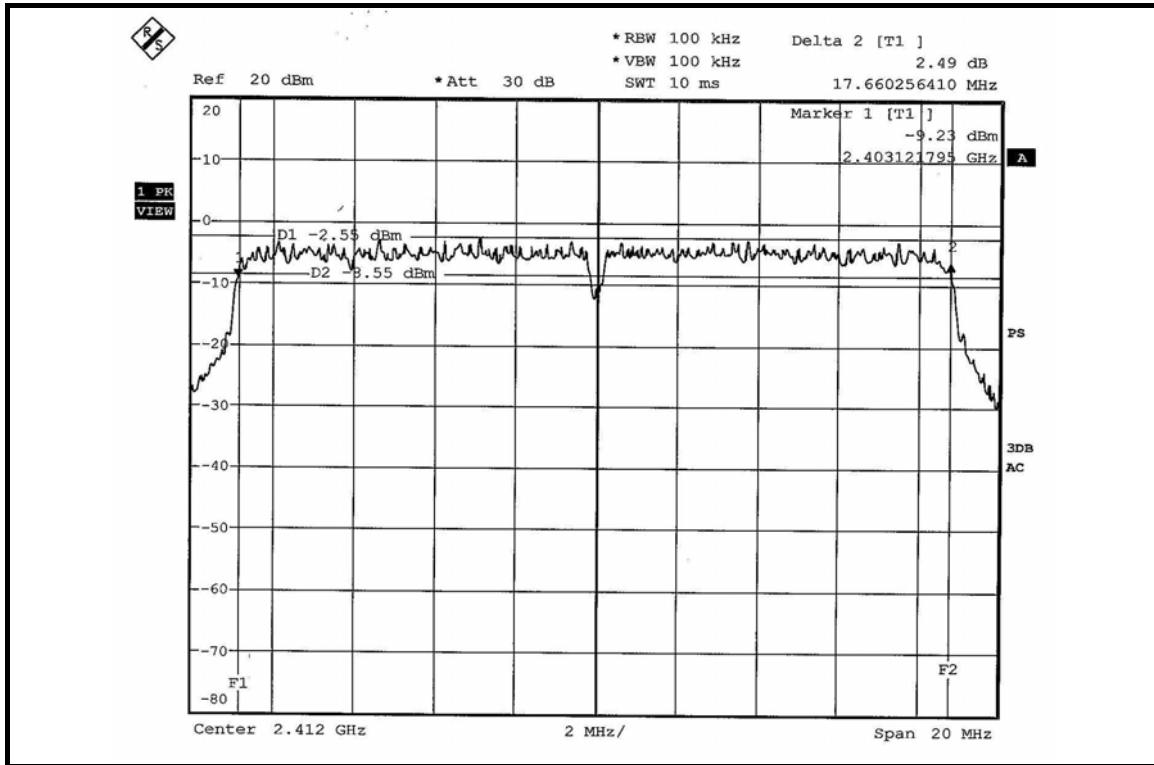

CH 6

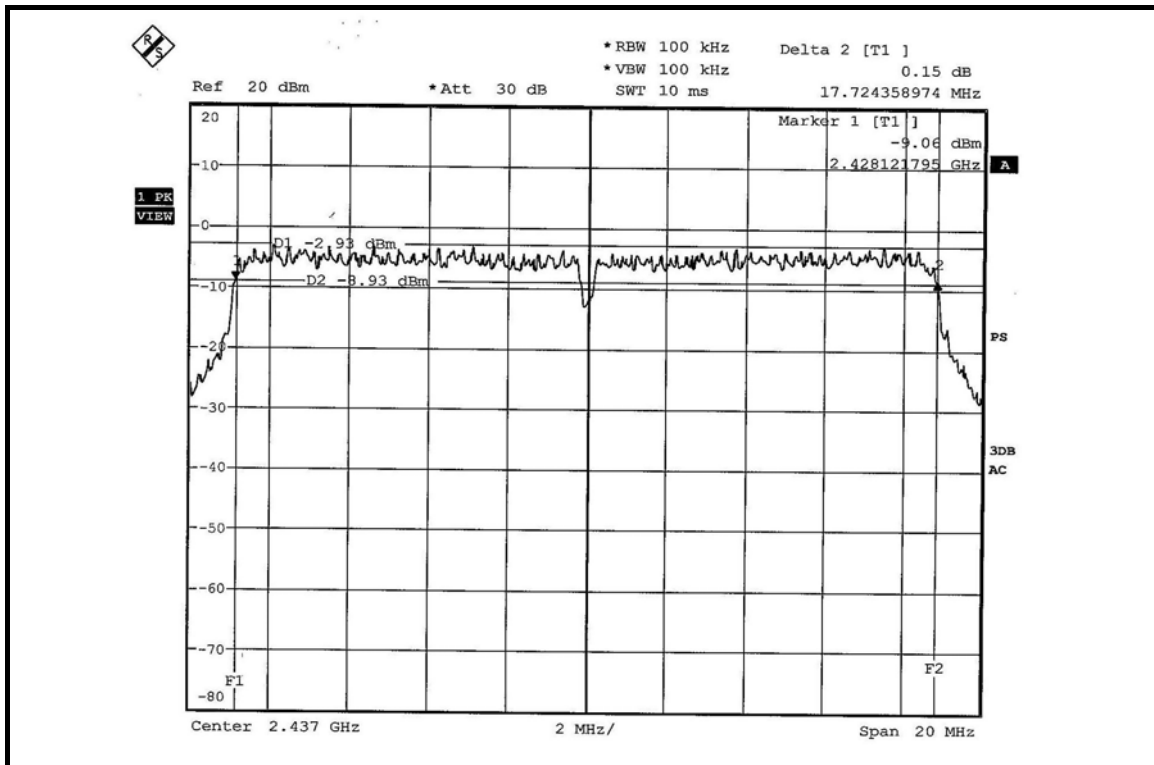

CH 11

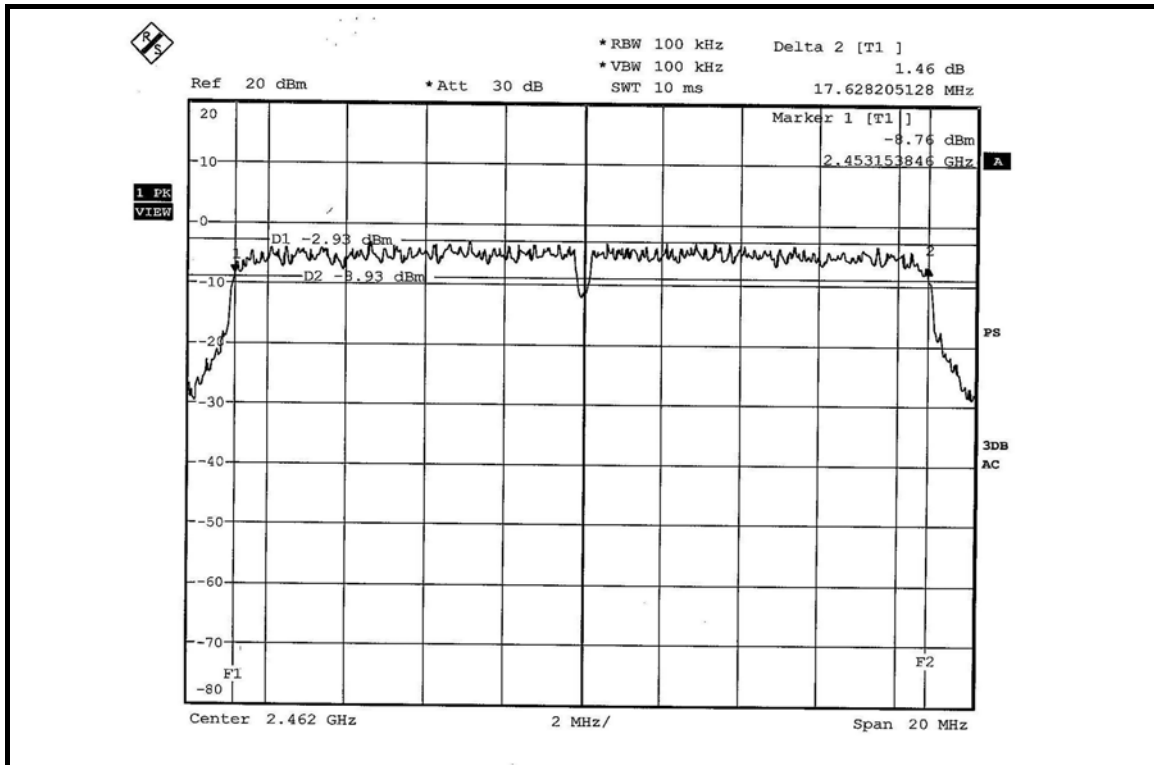

**DRAFT 802.11n (40MHz) OFDM MODULATION:**

<b>MODULATION TYPE</b>	BPSK	<b>TRANSFER RATE</b>	15.0Mbps
<b>INPUT POWER (SYSTEM)</b>	120Vac, 60 Hz	<b>ENVIRONMENTAL CONDITIONS</b>	25 deg. C, 63% RH, 991hPa
<b>TESTED BY</b>	Long Chen		

CHANNEL	CHANNEL FREQUENCY (MHz)	6dB BANDWIDTH (MHz)		MINIMUM LIMIT (MHz)	PASS / FAIL
		CHAIN 0	CHAIN 1		
1	2422	36.41	36.41	0.5	PASS
4	2437	36.41	36.47	0.5	PASS
7	2452	36.47	36.47	0.5	PASS

**FOR CHAIN 0: CH 1**

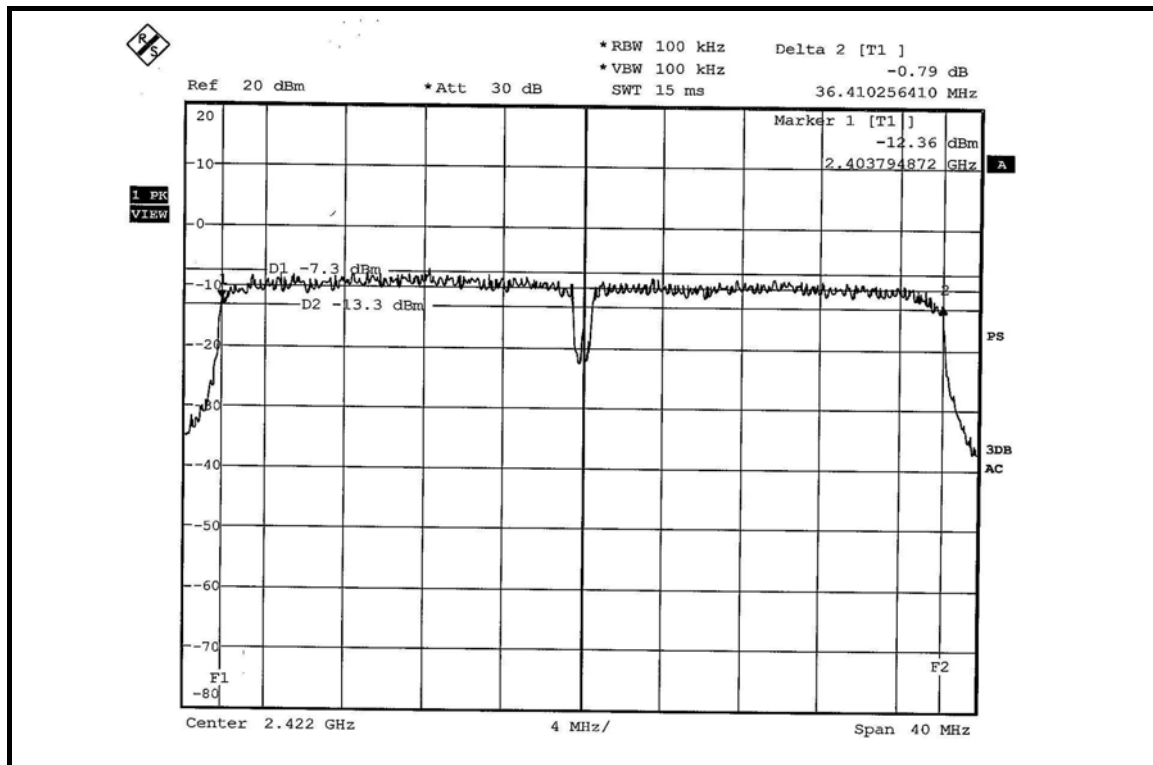



FOR CHAIN 1: CH 1

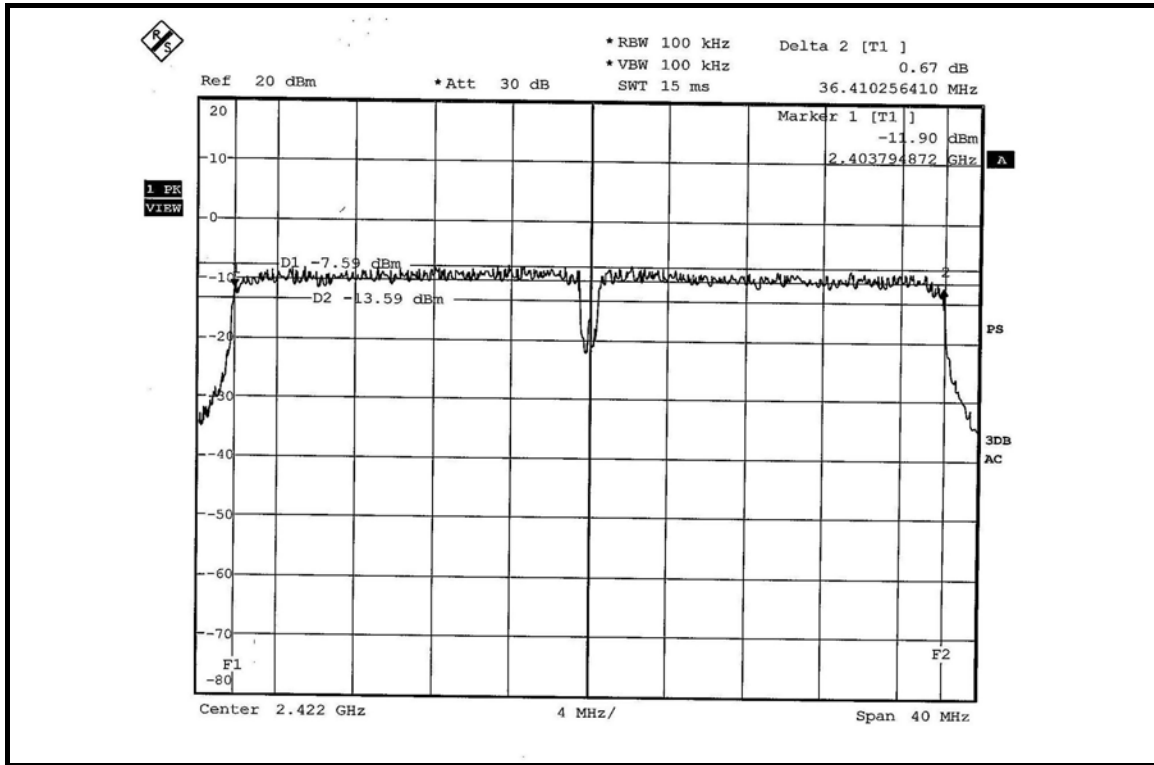

CH 4

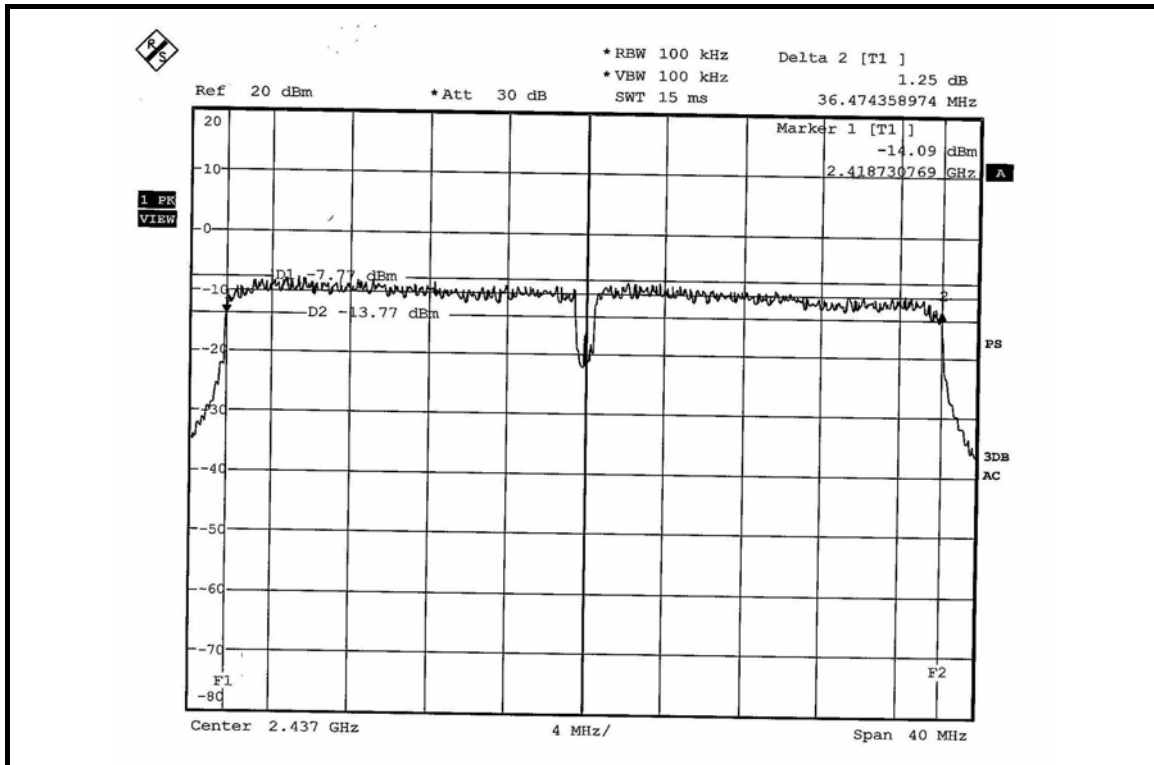

CH 7

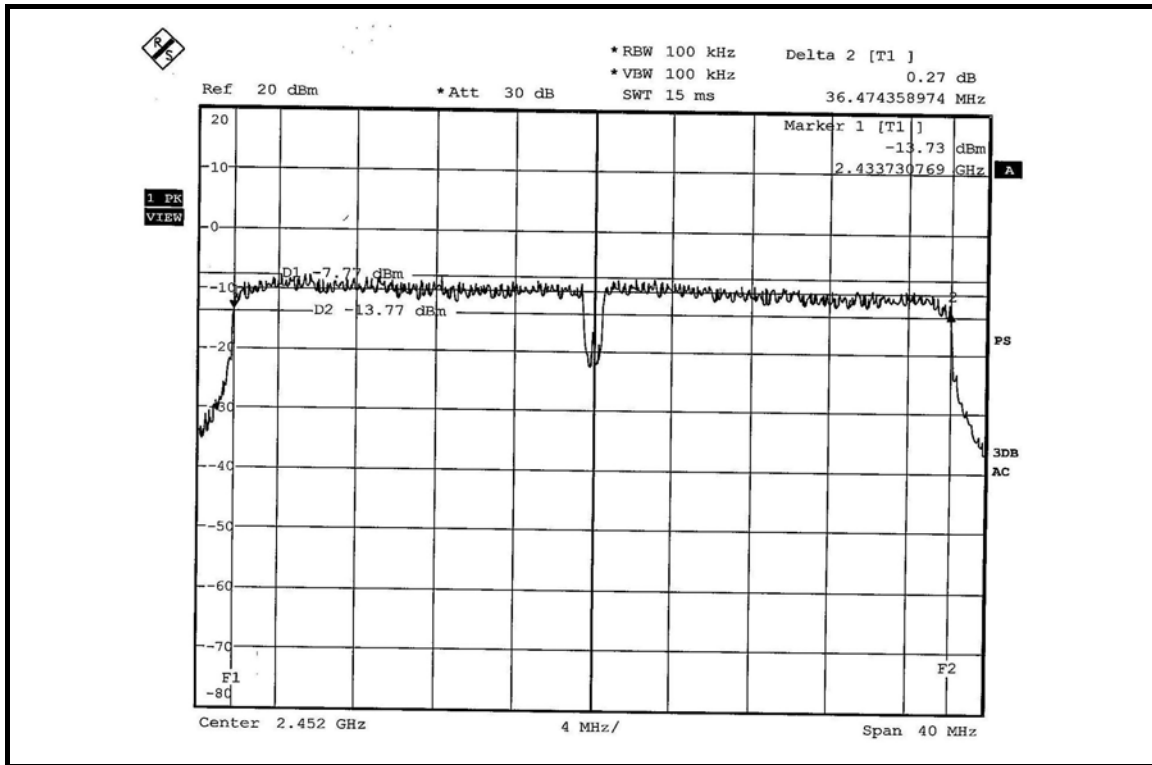



#### 4.4 MAXIMUM PEAK OUTPUT POWER

##### 4.4.1 LIMITS OF MAXIMUM PEAK OUTPUT POWER MEASUREMENT

The Maximum Peak Output Power Measurement is 30dBm.

##### 4.4.2 INSTRUMENTS

DESCRIPTION & MANUFACTURER	MODEL NO.	SERIAL NO.	CALIBRATED UNTIL
R&S SPECTRUM ANALYZER	FSP 40	100040	Jun. 07, 2007
ANRITSU SYNTHESIZED SIGNAL GENERATOR	68247B	984703	May 08, 2007
DIGITAL RT OSCILLOSCOPE	TDS1012	C037299	Nov. 28, 2007
NARDA DETECTOR	4503A	FSCM99899	NA

**NOTE:** The calibration interval of the above test instruments is 12 months and the calibrations are traceable to NML/ROC and NIST/USA.

##### 4.4.3 TEST PROCEDURES

1. A detector was used on the output port of the EUT. An oscilloscope was used to read the response of the detector.
2. Replaced the EUT by the signal generator. The center frequency of the S.G was adjusted to the center frequency of the measured channel.
3. Adjusted the power to have the same reading on oscilloscope. Record the power level.

##### 4.4.4 DEVIATION FROM TEST STANDARD

No deviation

#### 4.4.5 TEST SETUP



#### 4.4.6 EUT OPERATING CONDITIONS

Same as 4.3.6

#### 4.4.7 TEST RESULTS

##### 802.11b DSSS MODULATION:

<b>MODULATION TYPE</b>	DBPSK	<b>TRANSFER RATE</b>	1.0Mbps
<b>INPUT POWER (SYSTEM)</b>	120Vac, 60 Hz	<b>ENVIRONMENTAL CONDITIONS</b>	25 deg. C, 63% RH, 991hPa
<b>TESTED BY</b>	Long Chen		

CHANNEL	CHANNEL FREQUENCY (MHz)	PEAK POWER OUTPUT (mW)	PEAK POWER OUTPUT (dBm)	PEAK POWER LIMIT (dBm)	PASS / FAIL
1	2412	57.016	17.56	30	PASS
6	2437	56.364	17.51	30	PASS
11	2462	56.754	17.54	30	PASS

##### 802.11g OFDM MODULATION:

<b>MODULATION TYPE</b>	BPSK	<b>TRANSFER RATE</b>	6.0Mbps
<b>INPUT POWER (SYSTEM)</b>	120Vac, 60 Hz	<b>ENVIRONMENTAL CONDITIONS</b>	25 deg. C, 63% RH, 991hPa
<b>TESTED BY</b>	Long Chen		

CHANNEL	CHANNEL FREQUENCY (MHz)	PEAK POWER OUTPUT (mW)	PEAK POWER OUTPUT (dBm)	PEAK POWER LIMIT (dBm)	PASS / FAIL
1	2412	70.958	18.51	30	PASS
6	2437	71.450	18.54	30	PASS
11	2462	71.121	18.52	30	PASS

**DRAFT 802.11n (20MHz) OFDM MODULATION:**

<b>MODULATION TYPE</b>	BPSK	<b>TRANSFER RATE</b>	7.2Mbps
<b>INPUT POWER (SYSTEM)</b>	120Vac, 60 Hz	<b>ENVIRONMENTAL CONDITIONS</b>	25 deg. C, 63% RH, 991hPa
<b>TESTED BY</b>	Long Chen		

CHAN.	CHANNEL FREQUENCY (MHz)	PEAK POWER OUTPUT (mW)		PEAK POWER OUTPUT (dBm)		TOTAL PEAK POWER (mW)	TOTAL PEAK POWER (dBm)	PEAK POWER LIMIT (dBm)	PASS / FAIL
		CHAIN 0	CHAIN 1	CHAIN 0	CHAIN 1				
1	2412	41.305	40.272	16.16	16.05	81.576	19.12	30	PASS
6	2437	41.020	39.902	16.13	16.01	80.923	19.08	30	PASS
11	2462	40.832	40.087	16.11	16.03	80.919	19.08	30	PASS

**DRAFT 802.11n (40MHz) OFDM MODULATION:**

<b>MODULATION TYPE</b>	BPSK	<b>TRANSFER RATE</b>	15.0Mbps
<b>INPUT POWER (SYSTEM)</b>	120Vac, 60 Hz	<b>ENVIRONMENTAL CONDITIONS</b>	25deg.C, 63% RH, 991hPa
<b>TESTED BY</b>	Long Chen		

CHAN.	CHANNEL FREQUENCY (MHz)	PEAK POWER OUTPUT (mW)		PEAK POWER OUTPUT (dBm)		TOTAL PEAK POWER (mW)	TOTAL PEAK POWER (dBm)	PEAK POWER LIMIT (dBm)	PASS / FAIL
		CHAIN 0	CHAIN 1	CHAIN 0	CHAIN 1				
1	2422	23.281	22.646	13.67	13.55	45.927	16.62	30	PASS
4	2437	22.961	22.803	13.61	13.58	45.765	16.61	30	PASS
7	2452	22.909	22.439	13.60	13.51	45.347	16.57	30	PASS

## 4.5 POWER SPECTRAL DENSITY MEASUREMENT

### 4.5.1 LIMITS OF POWER SPECTRAL DENSITY MEASUREMENT

The Maximum of Power Spectral Density Measurement is 8dBm.

### 4.5.2 TEST INSTRUMENTS

DESCRIPTION & MANUFACTURER	MODEL NO.	SERIAL NO.	CALIBRATED UNTIL
R&S SPECTRUM ANALYZER	FSP40	100040	Jun. 07, 2007

**NOTE:** The calibration interval of the above test instruments is 12 months and the calibrations are traceable to NML/ROC and NIST/USA.

### 4.5.3 TEST PROCEDURE

The transmitter output was connected to the spectrum analyzer through an attenuator, the bandwidth of the fundamental frequency was measured with the spectrum analyzer using 3kHz RBW and 30kHz VBW, set sweep time = span/3kHz. The power spectral density was measured and recorded.

The sweep time is allowed to be longer than span/3kHz for a full response of the mixer in the spectrum analyzer.

### 4.5.4 DEVIATION FROM TEST STANDARD

No deviation

#### 4.5.5 TEST SETUP

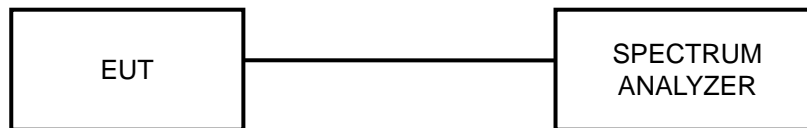

#### 4.5.6 EUT OPERATING CONDITION

Same as 4.3.6

### 4.5.7 TEST RESULTS

#### 802.11b DSSS MODULATION:

<b>MODULATION TYPE</b>	DBPSK	<b>TRANSFER RATE</b>	1.0Mbps
<b>INPUT POWER (SYSTEM)</b>	120Vac, 60 Hz	<b>ENVIRONMENTAL CONDITIONS</b>	25 deg. C, 63% RH, 991hPa
<b>TESTED BY</b>	Long Chen		

CHANNEL	CHANNEL FREQUENCY (MHz)	RF POWER LEVEL IN 3kHz BW (dBm)	MAXIMUM LIMIT (dBm)	PASS / FAIL
1	2412	-14.16	8	PASS
6	2437	-14.24	8	PASS
11	2462	-13.99	8	PASS

#### CH 1

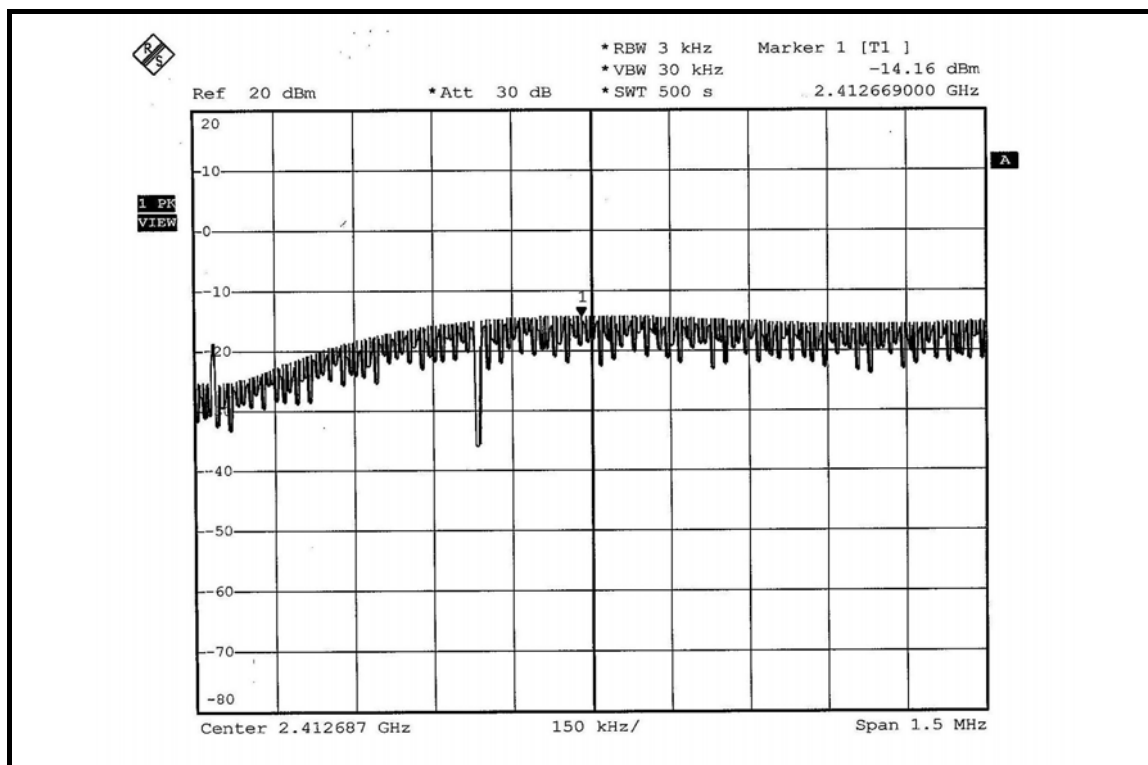





### 802.11g OFDM MODULATION:

<b>MODULATION TYPE</b>	BPSK	<b>TRANSFER RATE</b>	6.0Mbps
<b>INPUT POWER (SYSTEM)</b>	120Vac, 60 Hz	<b>ENVIRONMENTAL CONDITIONS</b>	25 deg. C, 63% RH, 991hPa
<b>TESTED BY</b>	Long Chen		

CHANNEL	CHANNEL FREQUENCY (MHz)	RF POWER LEVEL IN 3kHz BW (dBm)	MAXIMUM LIMIT (dBm)	PASS / FAIL
1	2412	-13.67	8	PASS
6	2437	-13.86	8	PASS
11	2462	-13.90	8	PASS

### CH 1

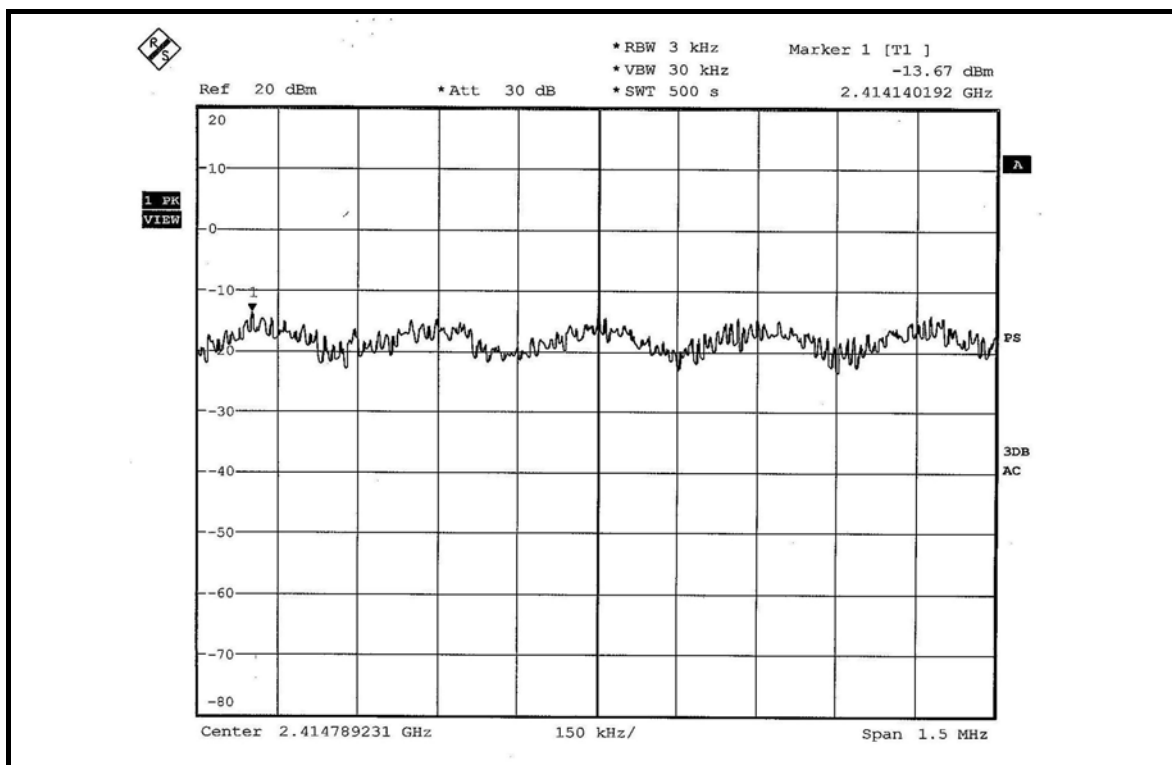

CH 6

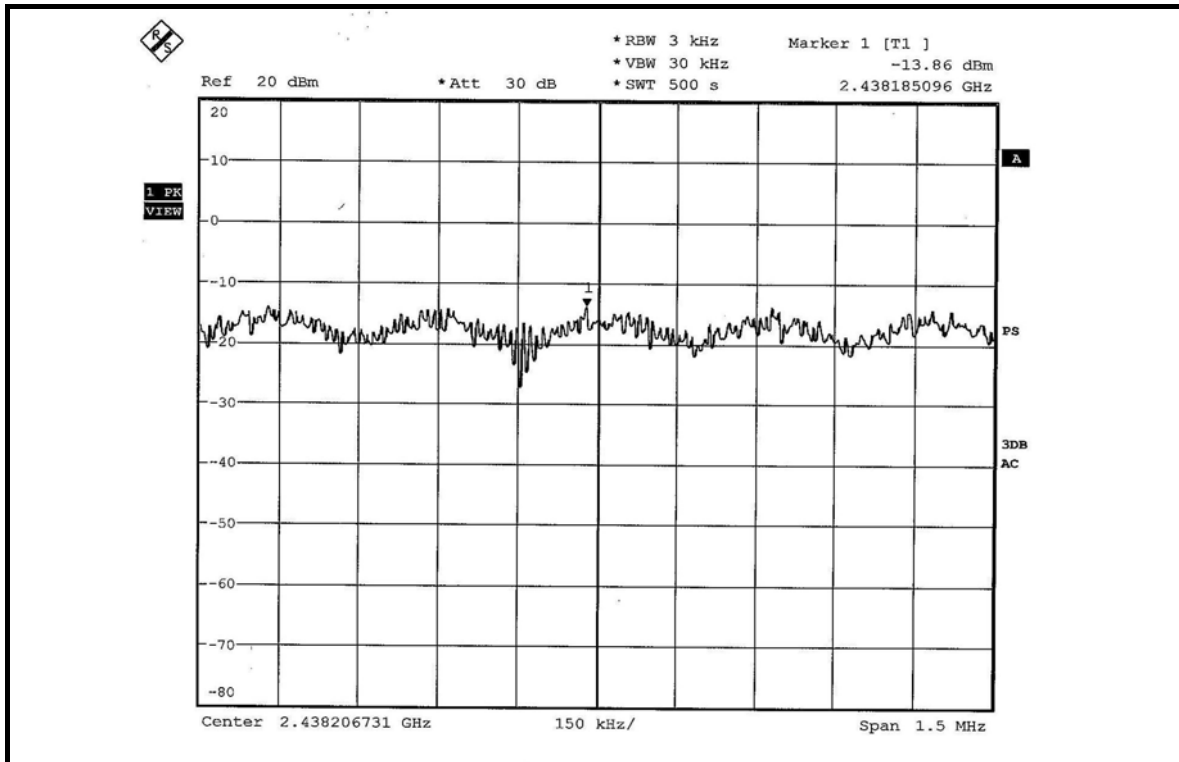

CH 11

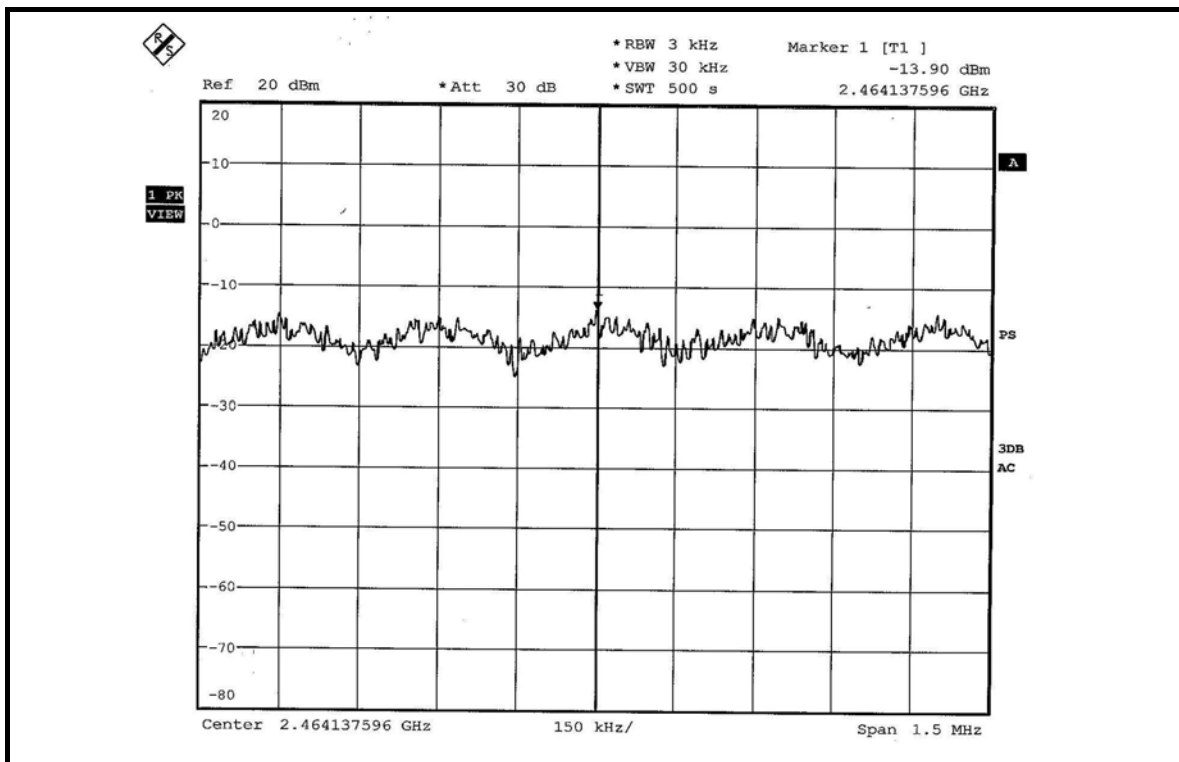





FOR CHAIN 1: CH 1

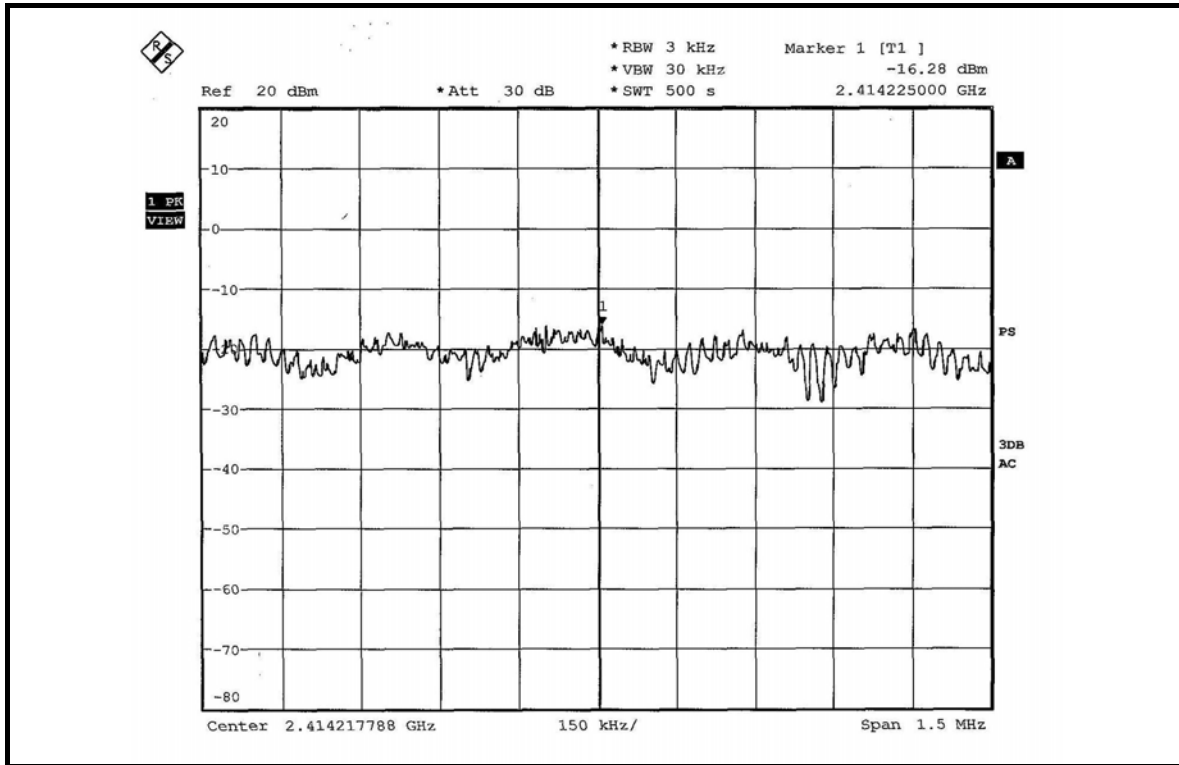

CH 6

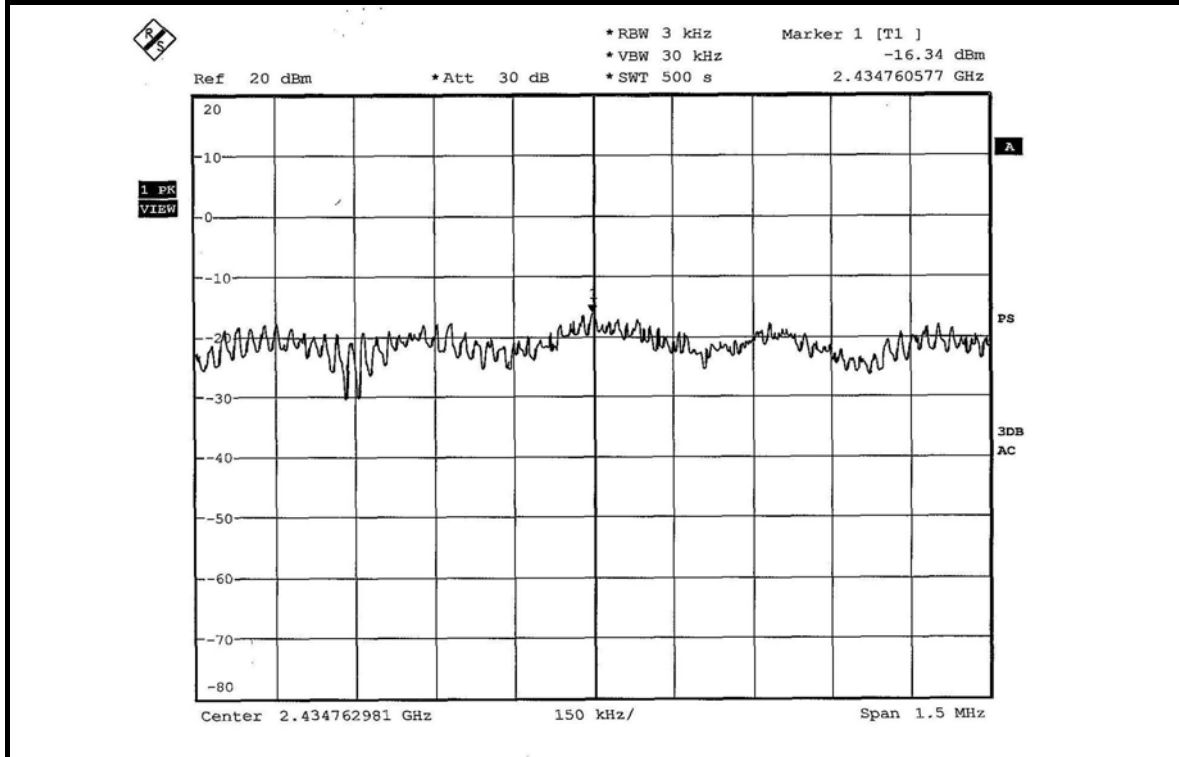

CH 11

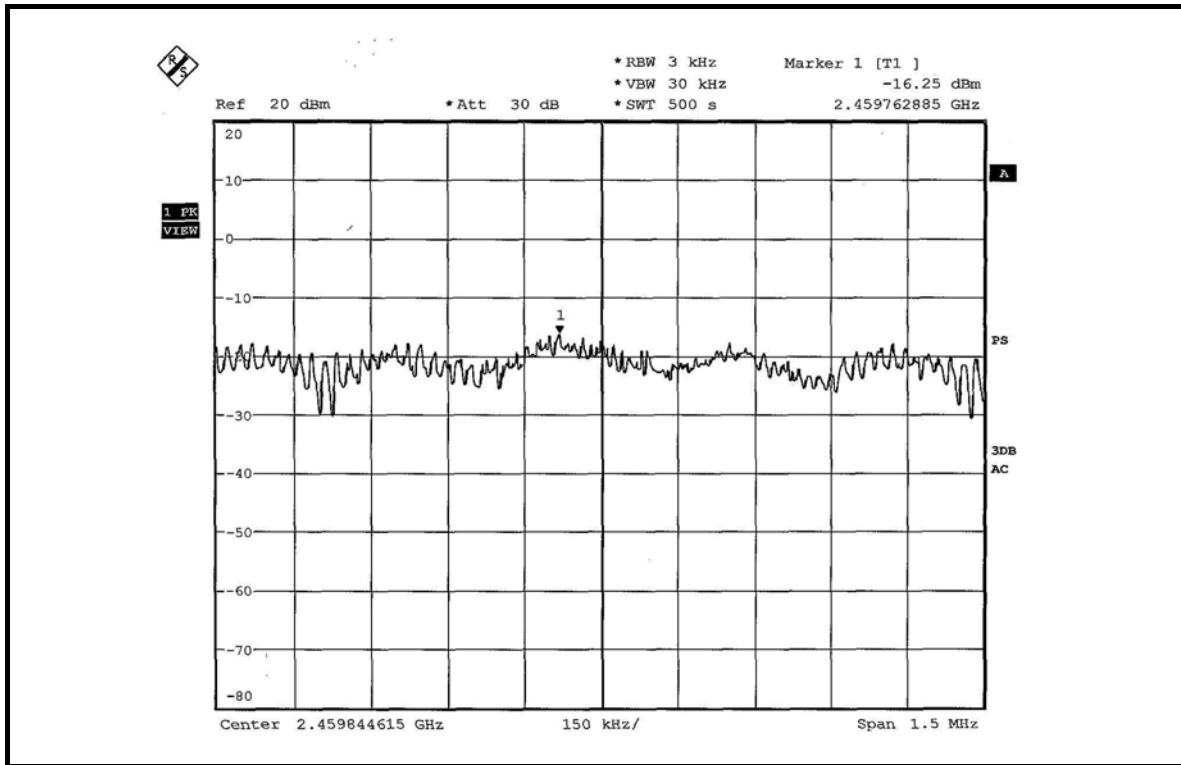



CH 4

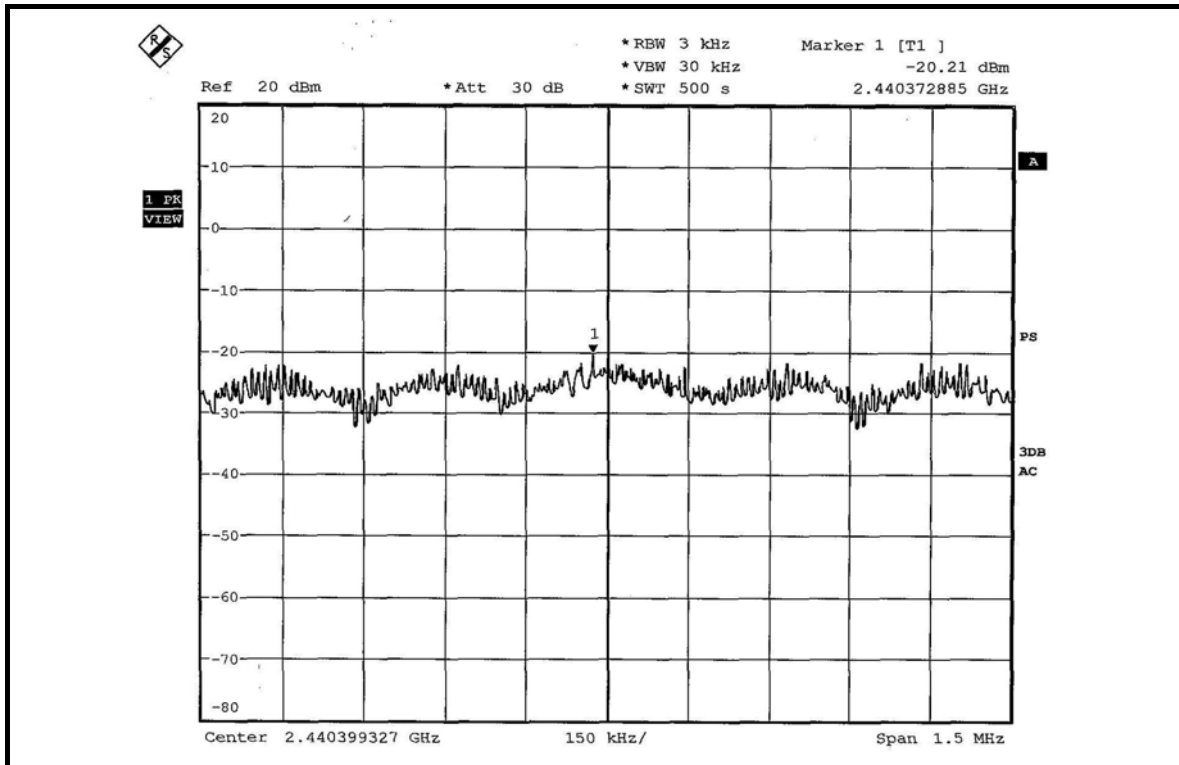

CH 7

