



FCC 47 CFR PART 15 SUBPART C

TEST REPORT

For

LF Controller

Model : TPMS-LF004

Trade Name : MOBILETRON

Issued for

MOBILETRON ELECTRONICS CO., LTD.

39, Sec. 3, Chung-Ching Rd., Ta-Ya,

Taichung Hsien, Taiwan 428

Issued by

**Compliance Certification Services Inc.
Hsinchu Lab.**

Rm. 258, Bldg. 17, NO.195, Sec.4 Chung Hsing Rd.,
ChuTung Chen, Hsinchu, Taiwan 310, R.O.C

TEL: (03) 591-0068

FAX: (03) 582-5720



Note: This report shall not be reproduced except in full, without the written approval of Compliance Certification Services Inc. This document may be altered or revised by Compliance Certification Services Inc. personnel only, and shall be noted in the revision section of the document. The client should not use it to claim product endorsement by TAF or any government agencies. The test results in the report only apply to the tested sample.



Revision History

Rev.	Issue Date	Revisions	Effect Page	Revised By
00	06/04/2008	Initial Issue	All Page 19	Jason Chang
01	07/03/2008	Update Output Power	Page 10, 11	Jason Chang
02	07/11/2008	Deletion Output Power Chapter And Update Radiated Emissions	Page 10, 11, 12, 13	Jason Chang



TABLE OF CONTENTS

TITLE	PAGE NO.
1. TEST REPORT CERTIFICATION.....	4
2. EUT DESCRIPTION.....	5
2.1 DESCRIPTION OF EUT & POWER.....	5
3. DESCRIPTION OF TEST MODES.....	5
4. TEST METHODOLOGY.....	6
5. FACILITIES AND ACCREDITATIONS.....	6
5.1 FACILITIES.....	6
5.2 EQUIPMENT.....	6
5.3 LABORATORY ACCREDITATIONS LISTINGS.....	6
5.4 TABLE OF ACCREDITATIONS AND LISTINGS.....	7
6. CALIBRATION AND UNCERTAINTY.....	8
6.1 MEASURING INSTRUMENT CALIBRATION.....	8
6.2 MEASUREMENT UNCERTAINTY.....	8
7. SETUP OF EQUIPMENT UNDER TEST.....	9
8. APPLICABLE LIMITS AND TEST RESULTS.....	10
8.1 RADIATED EMISSIONS.....	10-13
8.2 POWERLINE CONDUCTED EMISSIONS.....	14-15
9. ANTENNA REQUIREMENT.....	16
9.1 STANDARD APPLICABLE.....	16
9.2 ANTENNA CONNECTED CONSTRUCTION.....	16
APPENDIX SETUP PHOTOS.....	17



1. TEST REPORT CERTIFICATION

Applicant : MOBILETRON ELECTRONICS CO., LTD.
Address : 39, Sec. 3, Chung-Ching Rd., Ta-Ya,
Taichung Hsien, Taiwan 428
Equipment Under Test : LF Controller
Model : TPMS-LF004
Trade Name : MOBILETRON
Tested Date : March 21 ~ May 26, 2008

APPLICABLE STANDARD	
STANDARD	TEST RESULT
FCC Part 15 Subpart C AND ANSI C63.4:2003	No non-compliance noted

Approved by:

Jason Chang
Team Leader of Hsinchu Laboratory
Compliance Certification Services Inc.

Reviewed by:



Alan Fan
Team Leader of Hsinchu Laboratory
Compliance Certification Services Inc.

WE HEREBY CERTIFY THAT: The measurements shown in the attachment were made in accordance with the procedures indicated, and the energy emitted by the equipment was found to be within the limits applicable. We assume full responsibility for the accuracy and completeness of these measurements and vouch for the qualifications of all persons taking them.



2. EUT DESCRIPTION

2.1 DESCRIPTION OF EUT & POWER

Product Name	LF Controller
Model Number	TPMS-LF004
Channel Number	1
Frequency Range	125 kHz
Field Strength	18.34 dB μ V/m
Modulation Technique	ASK
Antenna Type	serial-resonant-LC circuit
Power Source	1.5V \times 2 (From Power Battery)

Remark:

1. The sample selected for test was engineering sample that approximated to production product and was provided by manufacturer.
2. This submittal(s) (test report) is intended for FCC ID: ULZ-LF004 filing to comply with Section 15.207 and 15.209 of the FCC Part 15, Subpart C Rules.
3. For more details, please refer to the User's manual of the EUT.

3. DESCRIPTION OF TEST MODES

The EUT had been tested under operating condition.

There are one channel have been tested as following :

Channel	Frequency (kHz)
1	125

Note : The field strength of spurious emission was measured in the following position: EUT stand-up position(Z axis), lie-down position(X,Y axis). The worst emission was found in lie-down position(Y axis) and the worst case was recorded.



4. TEST METHODOLOGY

The tests documented in this report were performed in accordance with ANSI C63.4 and FCC CRF 47 2.1046, 2046, 2.1047, 2.1049, 2.1051, 2.1053, 2.1055, 2.1057, 15.207, 15.209.

5. FACILITIES AND ACCREDITATIONS

5.1 FACILITIES

All measurement facilities used to collect the measurement data are located at Rm.258, Bldg.17, NO.195 , Sec. 4, Chung Hsing Rd., Chu-Tung Chen. Hsin-Chu, Taiwan 310 R.O.C.

The sites are constructed in conformance with the requirements of ANSI C63.7, ANSI C63.4 and CISPR Publication 22.

5.2 EQUIPMENT

Radiated emissions are measured with one or more of the following types of linearly polarized antennas: tuned dipole, biconical, log periodic, bi-log, and/or ridged waveguide, horn. Spectrum analyzers with preselectors and quasi-peak detectors are used to perform radiated measurements.

Conducted emissions are measured with Line Impedance Stabilization Networks and EMI Test Receivers.





Calibrated wideband preamplifiers, coaxial cables, and coaxial attenuators are also used for making measurements.

All receiving equipment conforms to CISPR Publication 16-1, "Radio Interference Measuring Apparatus and Measurement Methods."

5.3 LABORATORY ACCREDITATIONS LISTINGS

The test facilities used to perform radiated and conducted emissions tests are accredited by National Voluntary Laboratory Accreditation Program for the specific scope of accreditation under Lab Code: 200118-0 to perform Electromagnetic Interference tests according to FCC PART 15 AND CISPR 22 requirements. No part of this report may be used to claim or imply product endorsement by TAF or any agency of the Government. In addition, the test facilities are listed with Federal Communications Commission (registration no: 90585 and 90584).

5.4 TABLE OF ACCREDITATIONS AND LISTINGS

Country	Agency	Scope of Accreditation	Logo
USA	FCC	3/10 meter Open Area Test Sites to perform FCC Part 15/18 measurements	 90585, 90584
Japan	VCCI	3/10 meter Open Area Test Sites to perform conducted/radiated measurements	 R-1229/1189 C-1250/1294
Taiwan	TAF	FCC Method-47 CFR Part 15 Subpart C,D,E CISPR 11, FCC METHOD-47 CFR Part 18, EN 55011, CNS 13803, CISPR 13, CNS 13439, FCC Method-47 CFR Part 15 Subpart B, CISPR 14-1, EN 55014-1, CNS 13783-1, EN 55015, CNS 14115, CISPR 22, EN 55022, VCCI CNS 13438, EN 61000-4-2/3/4/5/6/8/11	 Testing Laboratory 0240
Taiwan	BSMI	CNS 13803, CNS 13438, CNS 13439, CNS 13783-1, CNS 14115	 SL2-IS-E-0002 SL2-IN-E-0002 SL2-A1-E-0002 SL2-R1-E-0002 SL2-R2-E-0002 SL2-L1-E-0002
Canada	Industry Canada	RSS-GEN Issue 2	 IC 4417-1, IC-4417-2

** No part of this report may be used to claim or imply product endorsement by TAF or any agency of the US Government.*



6. CALIBRATION AND UNCERTAINTY

6.1 MEASURING INSTRUMENT CALIBRATION

The measuring equipment utilized to perform the tests documented in this report has been calibrated in accordance with the manufacturer's recommendations, and is traceable to recognized national standards.

6.2 MEASUREMENT UNCERTAINTY

Where relevant, the following measurement uncertainty levels have been estimated for tests performed on the apparatus:

PARAMETER	UNCERTAINTY
Radiated Emission, 30 to 1000 MHz	+/- 3.2 dB
Radiated Emission, 1 to 26.5 GHz	+/- 3.2 dB
Power Line Conducted Emission	+/- 2.1 dB

Uncertainty figures are valid to a confidence level of 95%



7. SETUP OF EQUIPMENT UNDER TEST

SUPPORT EQUIPMENT

N/A

SETUP DIAGRAM FOR TESTS

EUT & peripherals setup diagram is shown in appendix setup photos.

EUT OPERATING CONDITION

1. Setup all equipments like the setup diagram.
2. EUT is in operation.
3. Start test.



8. APPLICABLE LIMITS AND TEST RESULTS

8.1 RADIATED EMISSIONS

LIMIT

1. According to §15.209(a), Except as provided elsewhere in this Subpart, the emissions from an intentional radiator shall not exceed the field strength levels specified in the following table:

Fundamental Frequency (MHz)	Field Strength (microvolts/meter)	Measurement Distance (microvolts/meter)
0.009 – 0.490	2400/F(kHz)	300
0.490 – 1.705	24000/F(kHz)	30
1.705 – 30.0	30	30
30 – 88	100 **	3
88 – 216	150 **	3
216 – 960	200 **	3
Above 960	500	3

Remark: ** Except as provided in paragraph (g), fundamental emissions from intentional radiators operating under this Section shall not be located in the frequency bands 54 – 72 MHz, 76 – 88 MHz, 174 – 216 MHz or 470 – 806 MHz. However, operation within these frequency bands is permitted under other sections of this Part, e.g., Sections 15.231 and 15.241.

2. In the above emission table, the tighter limit applies at the band edges.

Frequency (MHz)	Field Strength ($\mu\text{V}/\text{m}$ at 3-meter)	Field Strength ($\text{dB}\mu\text{V}/\text{m}$ at 3-meter)
30-88	100	40
88-216	150	43.5
216-960	200	46
Above 960	500	54

TEST EQUIPMENTS

The following test equipment is utilized in making the measurements contained in this report.

Manufacturer or Type	Model No.	Serial No.	Date of Calibration	Calibration Period	Remark
CHASE BILOG ANTENNA	CBL6112B	2817	December 21, 2007	1 Year	FINAL
R/S SPECTRUM ANALYZER	FSEK30	835253/002	October 25, 2007	1 Year	FINAL
AGILENT SPECTRUM ANALYZER	E4446A	MY433601.32	June 06, 2007	1 Year	FINAL
R/S EMI TEST RECEIVER	ESCS30	835418/008	October 16, 2007	1 Year	FINAL
OPEN SITE	-----	No.2	May 07, 2008	1 Year	FINAL
MIYAZAKI N TYPE COAXIAL CABLE	8D-FB	02	May 16, 2008	1 Year	FINAL
Horn Antenna	AH-118	10089	October 18, 2007	1 Year	FINAL
Horn Antenna	AH-840	03077	December 25, 2007	1 Year	FINAL
Agilent Pre-amplifier	8449B	3008A01471	December 20, 2007	1 Year	FINAL
HP Amplifier	8447D	2944A10052	December 24, 2007	1 Year	FINAL
Loop Antenna	6502	89052356	May 31, 2008	1 Year	FINAL
HP High pass filter	84300/80038	002	CAL. ON USE	1 Year	FINAL
HP High pass filter	84300/80039	003	CAL. ON USE	1 Year	FINAL

TEST SETUP

Below 30MHz

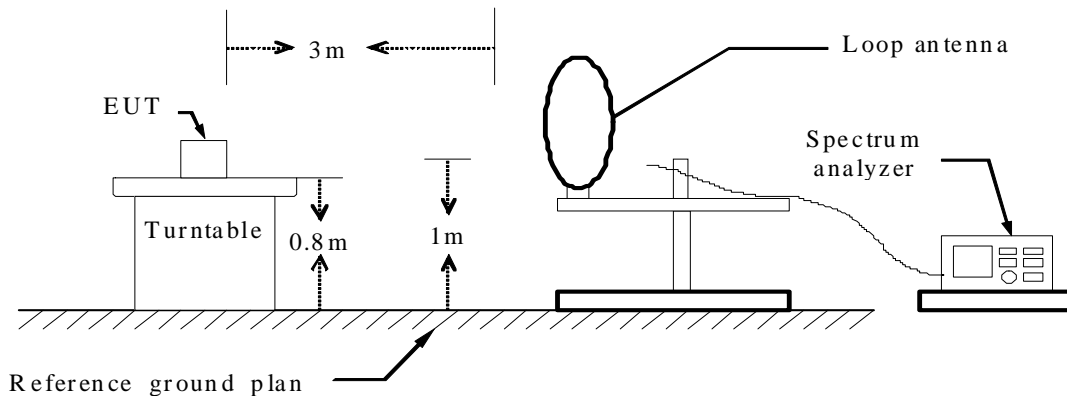

30 MHz ~ 1000 MHz

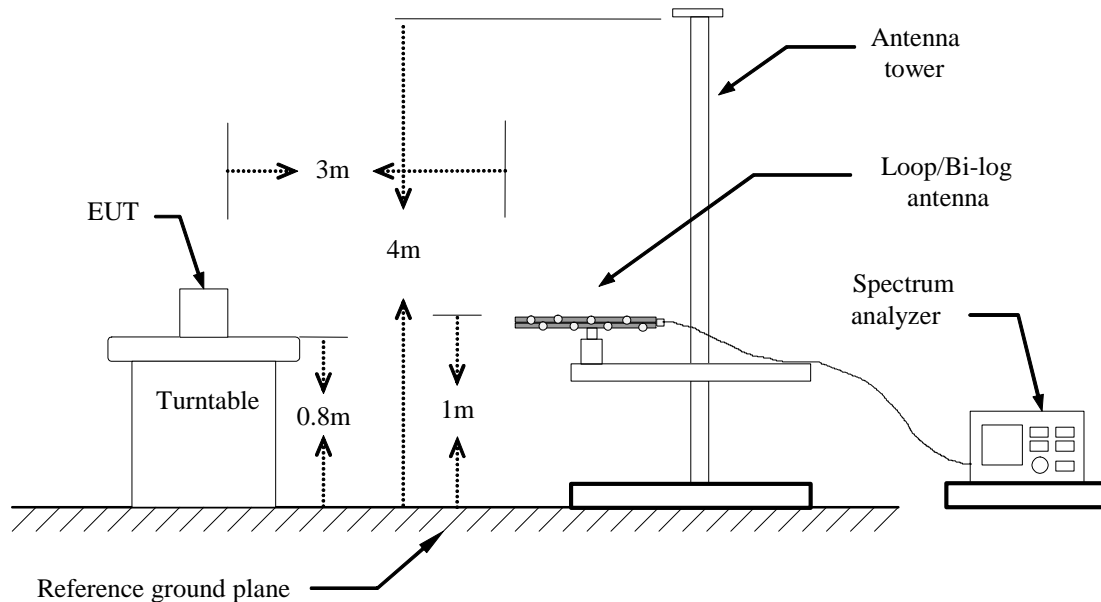

TEST PROCEDURE

The devices under test were placed on a rotatable table top 0.8 meter above ground. The table was rotated 360 degrees to determine the position of the highest radiation. EUT is set 3 meters from the interference receiving antenna which is mounted on the top of a variable height mast. The antenna height is varied between one meter and four meters above ground to find the maximum value of the field strength both horizontal polarization and vertical polarization of the antenna are set to make the measurement. The bandwidth setting on the E.M.I. meter (R/S TEST RECEIVER) is 120 KHz.

The levels are quasi peak value readings. The frequency spectrum from 10kHz to 1000MHz was investigated.

TEST RESULTS

No non-compliance noted



Product Name	LF Controller	Test Date	2008/05/03
Model Name	TPMS-LF004	Test By	Rueyyan Chang
Test Mode	TX	TEMP & Humidity	25.3 °C, 50%

FUNDAMENTAL							
Frequency (kHz)	Correction Factor (dB/m)	Meter Reading at 3m(dBμV)		Limits (dBμV/m)	Emission Level at 3m(dBμV/m)		
		Horizontal	Vertical		Horizontal	Vertical	
125	-0.5	18.84	18.55	105.66	18.34	18.05	
HARMONIC							
Frequency (MHz)	Antenna Factor (dB/m)	Cable Loss (dB)	Meter Reading at 3m(dBμV)		Limits (dBμV/m)	Emission Level at 3m(dBμV/m)	
			Horizontal	Vertical		Horizontal	Vertical
167.05	10.55	1.87	18.40	20.70	43.50	30.82	33.12
201.03	10.53	2.10	17.30	18.90	43.50	29.93	31.53
235.44	11.79	2.25	17.20	18.50	46.00	31.24	32.54
266.02	13.76	2.40	13.20	15.40	46.00	29.36	31.56
300.01	14.00	2.60	11.40	13.40	46.00	28.00	30.00
368.03	15.90	2.81	8.50	10.80	46.00	27.21	29.51

Remark:

1. Emission level (dBμV/m) = Antenna Factor (dB/m) + Cable loss (dB) + Meter Reading (dBμV).
2. According to technical experience, all spurious emission at channel Low, Middle and High are almost the same below 1GHz, so the spurious emission test result of the channel Low was chosen as representative in final test.



8.2 POWERLINE CONDUCTED EMISSIONS

LIMITS

§ 15.207 (a) Except as shown in paragraph (b) and (c) this section, for an intentional radiator that is designed to be connected to the public utility (AC) power line, the radio frequency voltage that is conducted back onto the AC power line on any frequency or frequencies within the band 150 kHz to 30 MHz shall not exceed the limits in the following table, as measured using a 50 μ H/50 ohms line impedance stabilization network (LISN). Compliance with the provisions of this paragraph shall be based on the measurement of the radio frequency voltage between each power line and ground at the power terminal.

The lower limit applies at the boundary between the frequency ranges.

Frequency of Emission (MHz)	Conducted limit (dB μ v)	
	Quasi-peak	Average
0.15 - 0.5	66 to 56	56 to 46
0.5 - 5	56	46
5 - 30	60	50

TEST EQUIPMENTS

The following test equipment is used during the conducted powerline tests :

Manufacturer or Type	Model No.	Serial No.	Date of Calibration	Calibration Period	Remark
SCHWARZBECK L.I.S.N	NSLK 8127	8127-465	July 09, 2007	1 Year	FINAL
SCHWARZBECK L.I.S.N	NSLK 8127	8127-473	October 04, 2007	1 Year	FINAL
R & S TEST RECEIVER	ESHS30	838550/003	January 23, 2008	1 Year	FINAL
KEENE SHIELDED ROOM	5983	No.1	N/A	N/A	FINAL
R & S PULSE LIMIT	ESH3-Z2	10117	September 17, 2007	1 Year	FINAL
BELDEN N TYPE COAXIAL CABLE	8268 M17/164	003	September 14, 2007	1 Year	FINAL



TEST SETUP

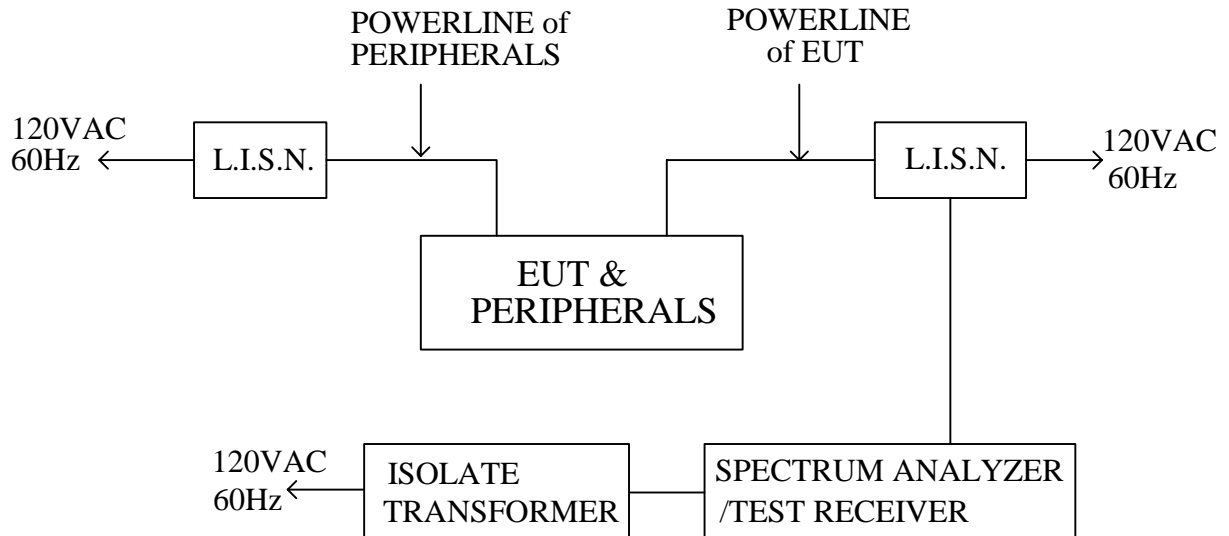

TEST PROCEDURE

The EUT is placed on a non-conducting table 40 cm from the vertical ground plane and 80cm above the horizontal ground plane. The EUT IS CONFIGURED IN ACCORDANCE WITH ANSI C63.4.

The resolution bandwidth is set to 9 kHz for both quasi-peak detection and average detection measurements.

Line conducted data is recorded for both NEUTRAL and LINE.

TEST RESULTS

No non-compliance noted

Sine this EUT is powered by Battery Powered, this test item is not applicable.



9. ANTENNA REQUIREMENT

9.1 STANDARD APPLICABLE

For intentional device, according to FCC 47 CFR Section 15.203, an intentional radiator shall be designed to ensure that no antenna other than that furnished by the responsible party shall be used with the device.

9.2 ANTENNA CONNECTED CONSTRUCTION

The antenna used in this product is serial-resonant-LC circuit.