



# FCC Radio Test Report

## FCC ID: ULT540605090101

This report concerns (check one) :  Original Grant  Class I Change

**Issued Date** : Jan. 19, 2009

**Project No.** : R0901001A

**Equipment** : N\_Max Wireless Access Point

**Model Name** : WAP-6010

**Applicant** : Digital Data Communications Asia Co.,  
Ltd.

**Address** : 8F, No. 41, Lane 221, Kang-Chien Rd.,  
Nei-Hu, 114, Taipei, Taiwan

**Tested by:**

Neutron Engineering Inc. EMC Laboratory

**Date of Test:**

Jan. 09, 2009 ~ Jan. 14, 2009

Testing Engineer :

Rush Kao  
(Rush Kao)

Technical Manager :

Jeff Yang  
(Jeff Yang)

Authorized Signatory :

Andy Chiu  
(Andy Chiu)

### Neutron Engineering Inc.

B1, No. 37, Lane 365, YangGuang St.

NeiHu District 114, Taipei, Taiwan.

TEL: +886-2-2657-3299

FAX: +886-2-2657-3331





**Declaration**

**Neutron** represents to the client that testing is done in accordance with standard procedures as applicable and that test instruments used has been calibrated with the standards traceable to National Measurement Laboratory (**NML**) of **R.O.C.**, or National Institute of Standards and Technology (**NIST**) of **U.S.A.**

**Neutron's** reports apply only to the specific samples tested under conditions. It is manufacture's responsibility to ensure that additional production units of this model are manufactured with the identical electrical and mechanical components. **Neutron** shall have no liability for any declarations, inferences or generalizations drawn by the client or others from **Neutron** issued reports.

**Neutron's** reports must not be used by the client to claim product endorsement by the authorities or any agency of the Government.

This report is the confidential property of the client. As a mutual protection to the clients, the public and **Neutron-self**, extracts from the test report shall not be reproduced except in full with **Neutron's** authorized written approval.

**Neutron's** laboratory quality assurance procedures are in compliance with the **ISO Guide 17025** requirements, and accredited by the conformity assessment authorities listed in this test report.

**Limitation**

For the use of the authority's logo is limited unless the Test Standard(s)/Scope(s)/Item(s) mentioned in this test report is (are) included in the conformity assessment authorities acceptance respective.



<b>Table of Contents</b>	<b>Page</b>
<b>1 . CERTIFICATION</b>	<b>5</b>
<b>2 . SUMMARY OF TEST RESULTS</b>	<b>6</b>
2.1 TEST FACILITY	7
2.2 MEASUREMENT UNCERTAINTY	7
<b>3 . GENERAL INFORMATION</b>	<b>8</b>
3.1 GENERAL DESCRIPTION OF EUT	8
3.2 DESCRIPTION OF TEST MODES	11
3.3 BLOCK DIGRAM SHOWING THE CONFIGURATION OF SYSTEM TESTED	12
3.4 DESCRIPTION OF SUPPORT UNITS	13
<b>4 . EMC EMISSION TEST</b>	<b>14</b>
4.1 CONDUCTED EMISSION MEASUREMENT	14
4.1.1 POWER LINE CONDUCTED EMISSION	14
4.1.2 MEASUREMENT INSTRUMENTS LIST	14
4.1.3 TEST PROCEDURE	15
4.1.4 DEVIATION FROM TEST STANDARD	15
4.1.5 TEST SETUP	15
4.1.6 EUT OPERATING CONDITIONS	16
4.1.7 TEST RESULTS	17
4.2 RADIATED EMISSION MEASUREMENT	19
4.2.1 RADIATED EMISSION LIMITS	19
4.2.2 MEASUREMENT INSTRUMENTS LIST	20
4.2.3 TEST PROCEDURE	20
4.2.4 DEVIATION FROM TEST STANDARD	20
4.2.5 TEST SETUP	21
4.2.6 EUT OPERATING CONDITIONS	21
4.2.7 TEST RESULTS-BETWEEN 30MHZ - 1000MHZ	22
4.2.8 TEST RESULTS - ABOVE 1000MHZ	24
4.2.9 TEST RESULTS-RESTRICTED BANDS REQUIREMENTS	72
<b>5 . BANDWITH TEST</b>	<b>88</b>
5.1 APPLIED PROCEDURES / LIMIT	88
5.1.1 MEASUREMENT INSTRUMENTS LIST	88
5.1.2 TEST PROCEDURE	88
5.1.3 DEVIATION FROM STANDARD	88
5.1.4 TEST SETUP	88
5.1.5 EUT OPERATION CONDITIONS	88
5.1.6 TEST RESULTS	89



<b>Table of Contents</b>	<b>Page</b>
<b>6 . PEAK OUTPUT POWER TEST</b>	<b>101</b>
<b>6.1 APPLIED PROCEDURES / LIMIT</b>	<b>101</b>
6.1.1 MEASUREMENT INSTRUMENTS LIST	101
6.1.2 TEST PROCEDURE	101
6.1.3 DEVIATION FROM STANDARD	101
6.1.4 TEST SETUP	101
6.1.5 EUT OPERATION CONDITIONS	101
6.1.6 TEST RESULTS	102
<b>7 . ANTENNA CONDUCTED SPURIOUS EMISSION</b>	<b>105</b>
<b>7.1 APPLIED PROCEDURES / LIMIT</b>	<b>105</b>
7.1.1 MEASUREMENT INSTRUMENTS LIST	105
7.1.2 TEST PROCEDURE	105
7.1.3 DEVIATION FROM STANDARD	105
7.1.4 TEST SETUP	105
7.1.5 EUT OPERATION CONDITIONS	105
7.1.6 TEST RESULTS	106
<b>8 . POWER SPECTRAL DENSITY TEST</b>	<b>114</b>
<b>8.1 APPLIED PROCEDURES / LIMIT</b>	<b>114</b>
8.1.1 MEASUREMENT INSTRUMENTS LIST	114
8.1.2 TEST PROCEDURE	114
8.1.3 DEVIATION FROM STANDARD	114
8.1.4 TEST SETUP	114
8.1.5 EUT OPERATION CONDITIONS	114
8.1.6 TEST RESULTS	115
<b>9 . RF EXPOSURE TEST</b>	<b>127</b>
<b>9.1 APPLIED PROCEDURES / LIMIT</b>	<b>127</b>
9.1.1 MEASUREMENT INSTRUMENTS LIST	127
9.1.2 MPE CALCULATION METHOD	127
9.1.3 DEVIATION FROM STANDARD	128
9.1.4 TEST SETUP	128
9.1.5 EUT OPERATION CONDITIONS	128
9.1.6 TEST RESULTS	129
<b>10 . EUT TEST PHOTO</b>	<b>132</b>



## 1. CERTIFICATION

Equipment : N\_Max Wireless Access Point  
Brand Name : Level one  
Model Name : WAP-6010  
Applicant : Digital Data Communications Asia Co., Ltd.  
Date of Test : Jan. 09, 2009 ~ Jan. 14, 2009  
Standards : FCC Part15, Subpart C / ANCI C63.4 : 2003

The above equipment has been tested and found compliance with the requirement of the relative standards by Neutron Engineering Inc. EMC Laboratory.

The test data, data evaluation, and equipment configuration contained in our test report (Ref No. NEI-FCCP-1-R0901001A) were obtained utilizing the test procedures, test instruments, test sites that has been accredited by the Authority of NVLAP and TAF according to the ISO-17025 quality assessment standard and technical standard(s).



**2. SUMMARY OF TEST RESULTS**

Test procedures according to the technical standards:

FCC Part15, Subpart C			
Standard Section	Test Item	Judgment	Remark
15.207	Conducted Emission	PASS	
15.247 (c)	Antenna conducted Spurious Emission	PASS	
15.247 (a)(2)	6dB Bandwidth	PASS	
15.247 (b)	Peak Output Power	PASS	
15.247 (c)	Radiated Spurious Emission	PASS	
15.247 (d)	Power Spectral Density	PASS	
15.203	Antenna Requirement	PASS	
1.1307 1.1310 2.1091 2.1093	RF Exposure Compliance	PASS	

**NOTE:**

(1) "N/A" denotes test is not applicable in this Test Report

(2) This test report covers EUT radio function only. Its receive function testing is covered in another DOC test report: NEI-FCCE-1-R0901001A.



**2.1 TEST FACILITY**

The test facilities used to collect the test data in this report is **C01/OS01 (FCC Test Firm Number: 95335)** at the location of No.132-1, Lane 329, Sec. 2, Palian Road, Shijr City, Taipei, Taiwan.

**2.2 MEASUREMENT UNCERTAINTY**

The reported uncertainty of measurement  $y \pm U$ , where expended uncertainty **U** is based on a standard uncertainty multiplied by a coverage factor of **k=2**, providing a level of confidence of approximately **95 %**.

A. Conducted Measurement :

Test Site	Method	Measurement Frequency Range	U , (dB)	NOTE
C01	ANSI	150 KHz ~ 30MHz	1.94	

B. Radiated Measurement :

Test Site	Method	Measurement Frequency Range	Ant. H / V	U , (dB)	NOTE
OS-01	ANSI	30MHz ~ 200MHz	V	3.82	
		30MHz ~ 200MHz	H	3.60	
		200MHz ~ 1,000MHz	V	3.86	
		200MHz ~ 1,000MHz	H	3.94	
OS-02	ANSI	30MHz ~ 200MHz	V	2.48	
		30MHz ~ 200MHz	H	2.16	
		200MHz ~ 1,000MHz	V	2.50	
		200MHz ~ 1,000MHz	H	2.66	



### **3. GENERAL INFORMATION**

#### **3.1 GENERAL DESCRIPTION OF EUT**





## Neutron Engineering Inc.

Equipment	N_Max Wireless Access Point														
Brand Name	Level one														
Model Name	WAP-6010														
OEM Brand/Model Name	N/A														
Model Difference	<p>The EUT has two optional antennas. The differences please refer to Note 4.</p> <p>The EUT has three optional Switching Adapters. The differences between that are model names and plugs, detail please refer to <b>ATTACHMENT PHOTOGRAPHS OF EUT</b>.</p> <p>All the antennas were tested, and the model: WAP-6010 with antenna IWX-2411RSXX-999 was found to be the worst case during the pr-scanning test. This model of the worst case was used for final testing and collecting test data included in this report.</p>														
Product Description	<p>The EUT is an N_Max Wireless Access Point.</p> <table border="1"> <tr> <td>Operation Frequency:</td> <td>2412~2462 MHz</td> </tr> <tr> <td>Modulation Type:</td> <td>802.11b:CCK, DQPSK, DBPSK 802.11g:OFDM 802.11n:OFDM</td> </tr> <tr> <td>Bit Rate of Transmitter:</td> <td>802.11b: 11/5.5/2/1 Mbps 802.11g: 54/48/36/24/18/12/9/6 Mbps 802.11n(20MHz): 150+ Mbps 802.11n(40MHz): 300+ Mbps</td> </tr> <tr> <td>Number Of Channel:</td> <td>11CH .Please see Note 2.</td> </tr> <tr> <td>Antenna Designation:</td> <td>Please see Note 3.</td> </tr> <tr> <td>Antenna Gain(Peak):</td> <td>Please see Note 3.</td> </tr> <tr> <td>EIRP Power(Max):</td> <td>802.11b:18.68 dBm (Max.) 802.11g:25.82 dBm (Max.) 802.11n(20MHz):27.01 dBm (Max.) 802.11n(40MHz):25.69 dBm (Max.)</td> </tr> </table> <p>Based on the application, features, or specification exhibited in User's Manual, the EUT is considered as an ITE/Computing Device. More details of EUT technical specification, please refer to the User's Manual.</p>	Operation Frequency:	2412~2462 MHz	Modulation Type:	802.11b:CCK, DQPSK, DBPSK 802.11g:OFDM 802.11n:OFDM	Bit Rate of Transmitter:	802.11b: 11/5.5/2/1 Mbps 802.11g: 54/48/36/24/18/12/9/6 Mbps 802.11n(20MHz): 150+ Mbps 802.11n(40MHz): 300+ Mbps	Number Of Channel:	11CH .Please see Note 2.	Antenna Designation:	Please see Note 3.	Antenna Gain(Peak):	Please see Note 3.	EIRP Power(Max):	802.11b:18.68 dBm (Max.) 802.11g:25.82 dBm (Max.) 802.11n(20MHz):27.01 dBm (Max.) 802.11n(40MHz):25.69 dBm (Max.)
Operation Frequency:	2412~2462 MHz														
Modulation Type:	802.11b:CCK, DQPSK, DBPSK 802.11g:OFDM 802.11n:OFDM														
Bit Rate of Transmitter:	802.11b: 11/5.5/2/1 Mbps 802.11g: 54/48/36/24/18/12/9/6 Mbps 802.11n(20MHz): 150+ Mbps 802.11n(40MHz): 300+ Mbps														
Number Of Channel:	11CH .Please see Note 2.														
Antenna Designation:	Please see Note 3.														
Antenna Gain(Peak):	Please see Note 3.														
EIRP Power(Max):	802.11b:18.68 dBm (Max.) 802.11g:25.82 dBm (Max.) 802.11n(20MHz):27.01 dBm (Max.) 802.11n(40MHz):25.69 dBm (Max.)														
Channel List	Please refer to the Note 3.														
Power Source	DC Voltage supplied from Switching Adapter.														
Power Rating	I/P AC 100-240V 50/60Hz 0.3A / O/P DC +12V1A														
Connecting I/O Port(s)	Please refer to the User's Manual														
Products Covered	Switching Adapter (optional): DVE / DSA-12G-12 FEU; DSA-12G-12 FUK; DSA-12G-12 FUS														

Note:

1. For a more detailed features description, please refer to the manufacturer's specifications or the User's Manual.
2. CH 01 – CH 11 for 802.11b, 802.11g, 802.11n(20MHz)  
CH 03 – CH 09 for 802.11n(40MHz)

Channel List					
Channel	Frequency (MHz)	Channel	Frequency (MHz)	Channel	Frequency (MHz)
<b>01</b>	<b>2412</b>	05	2432	<b>09</b>	<b>2452</b>
02	2417	<b>06</b>	<b>2437</b>	10	2457
<b>03</b>	<b>2422</b>	07	2442	<b>11</b>	<b>2462</b>
04	2427	08	2447		

3. Table for Filed Antenna

Brand	Model Name	Antenna Type	Connector	Gain (dBi)
Joymax	IWX-2411RSXX-999	Dipole	Reverse SMA Plug	2
Picolink (Shen Zhen)	221-SMA-002	Dipole	Reverse SMA Plug	2

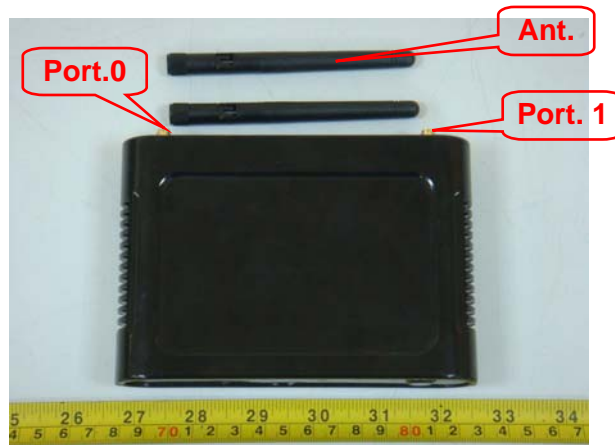

\*Only WAP-6010 was used for final testing and collecting test data included in this report.

- 4 The EUT incorporates MIMO function. Physically, the EUT provides two completed transmitters and two receivers (2T2R)

Modulated type	TX Function
802.11b	1TX
802.11g	1TX
Draft 802.11n(20MHz)	2TX
Draft 802.11n(40MHz)	2TX



**3.2 DESCRIPTION OF TEST MODES**

To investigate the maximum EMI emission characteristics generates from EUT, the test system was pre-scanning tested base on the consideration of following EUT operation mode or test configuration mode which possible have effect on EMI emission level. Each of these EUT operation mode(s) or test configuration mode(s) mentioned above was evaluated respectively.

Pretest Test Mode	Description
Mode 1	802.11b/CH01, CH06, CH11
Mode 2	802.11g/CH01, CH06, CH11
Mode 3	802.11n/20M/CH01, CH06, CH11 (Port. 0 + Port. 1)
Mode 4	802.11n/40M/CH03, CH6, CH9 (Port. 0 + Port. 1)

For Conducted Test	
Final Test Mode	Description
Mode 1	802.11b/CH06

For Radiated Test	
Final Test Mode	Description
Mode 1	802.11b/CH01, CH06, CH11
Mode 2	802.11g/CH01, CH06, CH11
Mode 3	802.11n/20M/CH01, CH06, CH11 (Port. 0 + Port. 1)
Mode 4	802.11n/40M/CH03, CH6, CH9 (Port. 0 + Port. 1)



**3.3 BLOCK DIGRAM SHOWING THE CONFIGURATION OF SYSTEM TESTED**

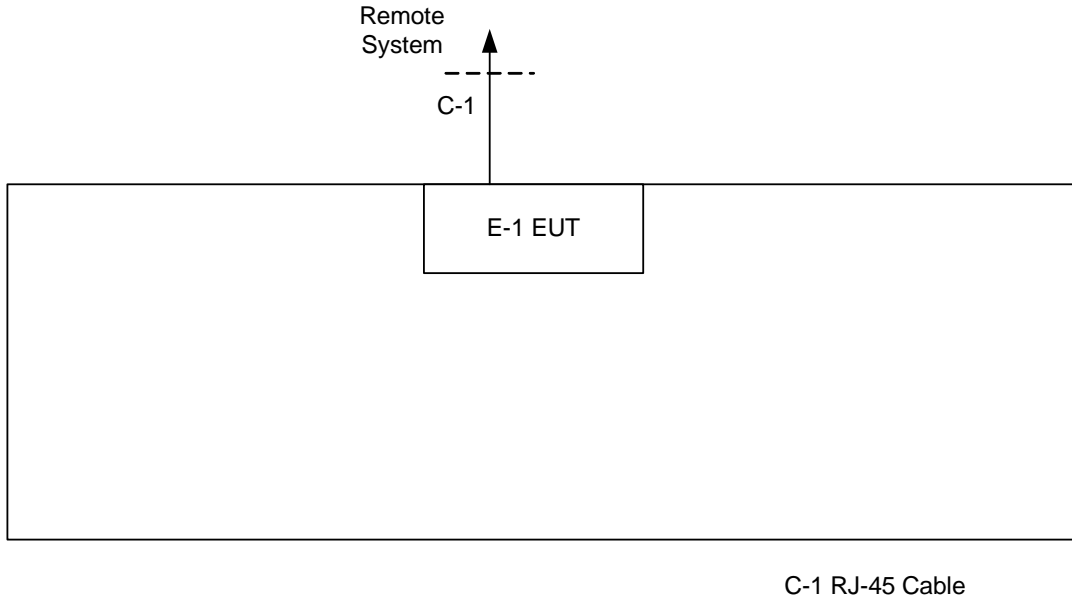



**3.4 DESCRIPTION OF SUPPORT UNITS**

The EUT has been tested as an independent unit together with other necessary accessories or support units. The following support units or accessories were used to form a representative test configuration during the tests.

Item	Equipment	Mfr/Brand	Model/Type No.	FCC ID	Series No.	Note
E-1	N_Max Wireless Access Point	Level one	WAP-6010	ULT540605090101	N/A	EUT

Item	Shielded Type	Ferrite Core	Length	Note
C-1	NO	NO	10.0M	

Note:

- (1) The support equipment was authorized by Declaration of Confirmation.
- (2) For detachable type I/O cable should be specified the length in cm in 『Length』 column.



**4. EMC EMISSION TEST**

**4.1 CONDUCTED EMISSION MEASUREMENT**

**4.1.1 POWER LINE CONDUCTED EMISSION (Frequency Range 150KHz-30MHz)**

FREQUENCY (MHz)	Class A (dBuV)		Class B (dBuV)	
	Quasi-peak	Average	Quasi-peak	Average
0.15 -0.5	79.00	66.00	66 - 56 *	56 - 46 *
0.50 -5.0	73.00	60.00	56.00	46.00
5.0 -30.0	73.00	60.00	60.00	50.00

Note:

- (1) The tighter limit applies at the band edges.
- (2) The limit of " \* " marked band means the limitation decreases linearly with the logarithm of the frequency in the range.

**4.1.2 MEASUREMENT INSTRUMENTS LIST**

Item	Kind of Equipment	Manufacturer	Type No.	Serial No.	Calibrated until
1	Test Cable	N/A	SR03_C_01 &02	N/A	Oct. 19, 2009
2	LISN (SR03)	EMCO	3816/2	00042991	Jan. 29, 2009
3	Pulse Limiter	Electro-Metrics	EM-7600	112647	Dec. 15, 2009
4	EMI Test Receiver	R&S	ESCI	100082	Mar. 23, 2009

Remark: " N/A" denotes No Model Name , Serial No. or No Calibration specified.

#### 4.1.3 TEST PROCEDURE

- The EUT was placed 0.8 meters from the horizontal ground plane with EUT being connected to the power mains through a line impedance stabilization network (LISN). All other support equipments powered from additional LISN(s). The LISN provide 50 Ohm/ 50uH of coupling impedance for the measuring instrument.
- Interconnecting cables that hang closer than 40 cm to the ground plane shall be folded back and forth in the center forming a bundle 30 to 40 cm long.
- I/O cables that are not connected to a peripheral shall be bundled in the center. The end of the cable may be terminated, if required, using the correct terminating impedance. The overall length shall not exceed 1 m.
- LISN at least 80 cm from nearest part of EUT chassis.
- For the actual test configuration, please refer to the related Item –EUT Test Photos.

#### 4.1.4 DEVIATION FROM TEST STANDARD

No deviation

#### 4.1.5 TEST SETUP

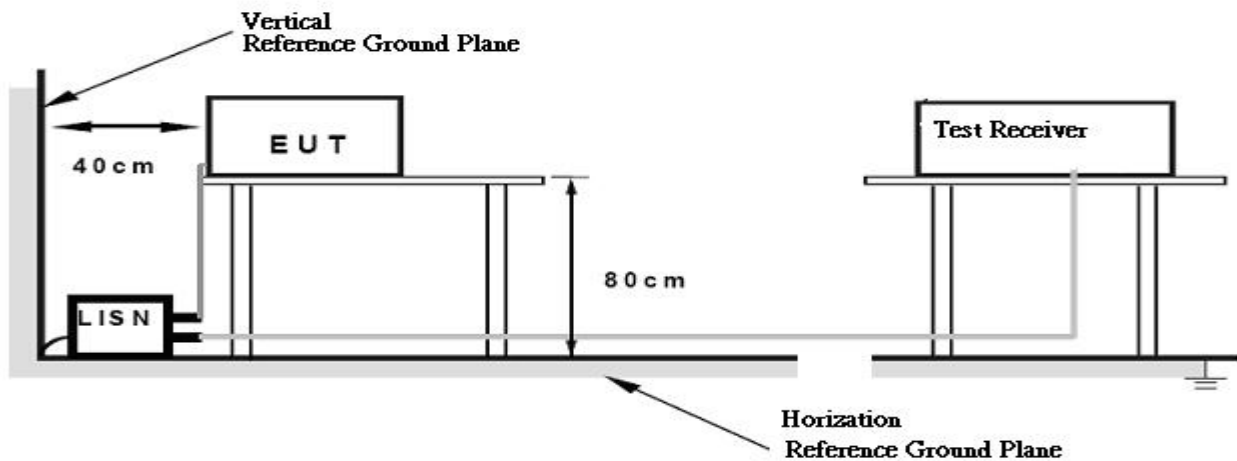



**4.1.6 EUT OPERATING CONDITIONS**

The EUT was configured for testing in a typical fashion (as a customer would normally use it). The EUT has been programmed to continuously transmit during test. This operating condition was tested and used to collect the included data.





**4.1.7 TEST RESULTS**

EUT :	N_Max Wireless Access Point	Model Name :	WAP-6010
Temperature :	26 °C	Relative Humidity :	55%
Test Voltage :	AC 120V/60Hz		
Test Mode :	802.11b/CH06		

Freq. (MHz)	Terminal L/N	Measured(dBuV)		Limits(dBuV)		Margin (dB)	Note
		QP-Mode	AV-Mode	QP-Mode	AV-Mode		
0.27	Line	43.75	*	61.24	51.24	-17.49	(QP)
0.39	Line	39.68	*	58.08	48.08	-18.40	(QP)
0.51	Line	38.82	*	56.00	46.00	-17.18	(QP)
5.60	Line	41.25	*	60.00	50.00	-18.75	(QP)
7.95	Line	39.23	*	60.00	50.00	-20.77	(QP)
24.00	Line	37.20	*	60.00	50.00	-22.80	(QP)

**Remark**

- (1) Reading in which marked as QP means measurements by using are Quasi-Peak Mode with Detector BW=9KHz; SPA setting in RBW=10KHz,VBW =10KHz, Swp. Time = 0.2 sec./MHz ◦ Reading in which marked as AV means measurements by using are Average Mode with instrument setting in RBW=10KHz,VBW=10KHz, Swp. Time =0.2 sec./MHz ◦
- (2) All readings are QP Mode value unless otherwise stated AVG in column of『Note』. If the QP Mode Measured value compliance with the QP Limits and lower than AVG Limits, the EUT shall be deemed to meet both QP & AVG Limits and then only QP Mode was measured, but AVG Mode didn't perform ◦ In this case, a “ \* ” marked in AVG Mode column of Interference Voltage Measured ◦
- (3) Measuring frequency range from 150KHz to 30MHz ◦

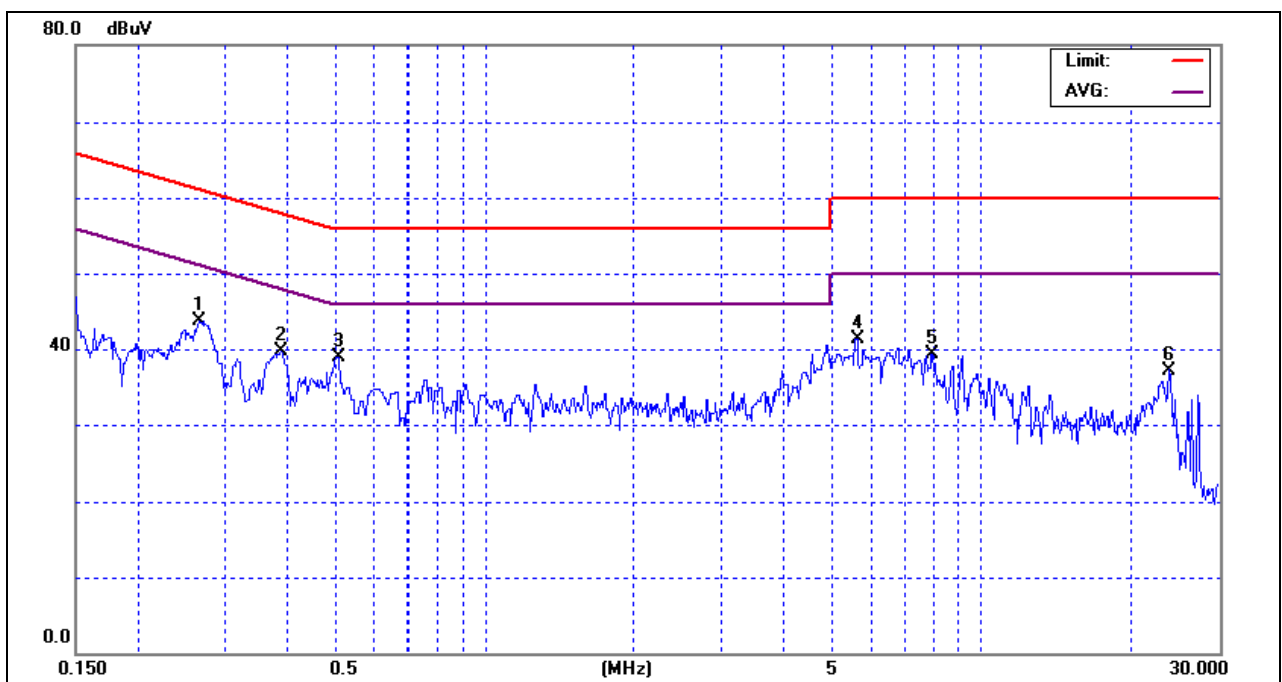



E.U.T :	N_Max Wireless Access Point	Model Name :	WAP-6010
Temperature :	23 °C	Relative Humidity :	50%
Test Voltage :	AC 120V/60Hz		
Test Mode :	802.11b/CH06		

Freq. (MHz)	Terminal L/N	Measured(dBuV)		Limits(dBuV)		Margin (dB)	Note
		QP-Mode	AV-Mode	QP-Mode	AV-Mode		
0.22	Neutral	49.62	*	62.93	52.93	-13.31	(QP)
0.27	Neutral	46.48	*	61.17	51.17	-14.69	(QP)
0.37	Neutral	39.96	*	58.49	48.49	-18.53	(QP)
0.49	Neutral	38.70	*	56.19	46.19	-17.49	(QP)
0.88	Neutral	38.17	*	56.00	46.00	-17.83	(QP)
6.20	Neutral	39.67	*	60.00	50.00	-20.33	(QP)

**Remark**

- (1) Reading in which marked as QP means measurements by using are Quasi-Peak Mode with Detector BW=9KHz ; SPA setting in RBW=10KHz,VBW =10KHz, Swp. Time = 0.2 sec./MHz ◦  
Reading in which marked as AV means measurements by using are Average Mode with instrument setting in RBW=10KHz,VBW=10KHz, Swp. Time =0.2 sec./MHz ◦
- (2) All readings are QP Mode value unless otherwise stated AVG in column of 'Note'. If the QP Mode Measured value compliance with the QP Limits and lower than AVG Limits, the EUT shall be deemed to meet both QP & AVG Limits and then only QP Mode was measured, but AVG Mode didn't perform ◦ In this case, a " \* " marked in AVG Mode column of Interference Voltage Measured ◦
- (3) Measuring frequency range from 150KHz to 30MHz ◦

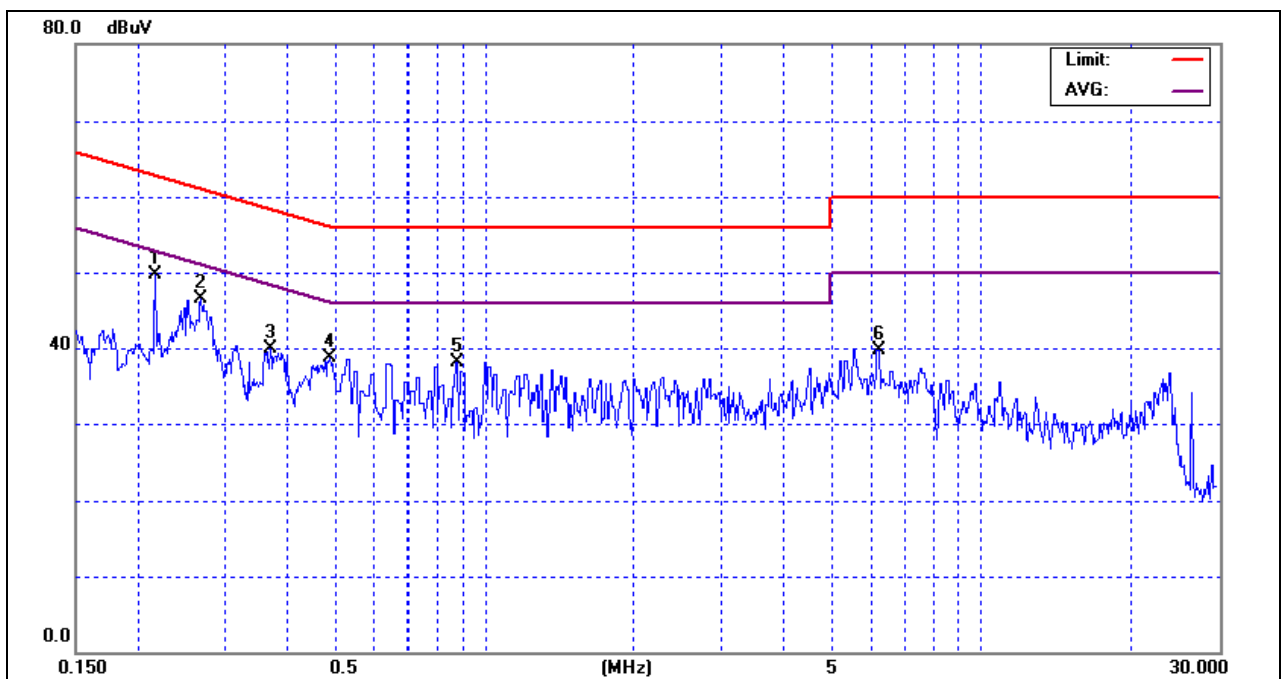



**4.2 RADIATED EMISSION MEASUREMENT**

**4.2.1 RADIATED EMISSION LIMITS (Frequency Range 9kHz-1000MHz)**

20dBc in any 100 kHz bandwidth outside the operating frequency band. In case the emission fall within the restricted band specified on 15.205(a), then the 15.209(a) limit in the table below has to be followed.

Frequencies (MHz)	Field Strength (micovolts/meter)	Measurement Distance (meters)
0.009~0.490	2400/F(KHz)	300
0.490~1.705	24000/F(KHz)	30
1.705~30.0	30	30
30~88	100	3
88~216	150	3
216~960	200	3
Above 960	500	3

**LIMITS OF RADIATED EMISSION MEASUREMENT (Above 1000MHz)**

FREQUENCY (MHz)	Class A (dBuV/m) (at 3m)		Class B (dBuV/m) (at 3m)	
	PEAK	AVERAGE	PEAK	AVERAGE
Above 1000	80	60	74	54

Notes:

- (1) The limit for radiated test was performed according to FCC PART 15B.
- (2) The tighter limit applies at the band edges.
- (3) Emission level (dBuV/m)=20log Emission level (uV/m).



**4.2.2 MEASUREMENT INSTRUMENTS LIST**

Item	Kind of Equipment	Manufacturer	Type No.	Serial No.	Calibrated until
1	Log-Bicon Antenna	Schwarzbeck	VULB 9160	3176	Jul. 24, 2009
2	Test Cable	N/A	10M_OS01	N/A	Oct. 20, 2009
3	Test Cable	N/A	3M_OS01	N/A	Oct. 08, 2009
4	Test Cable	N/A	OS01-1/-2	N/A	Oct. 08, 2009
5	Pre-Amplifier	Anritsu	MH648A(OS01)	M09961	Oct. 08, 2009
6	Positioning Controller (OS01)	MF	MF7802	N/A	N/A
7	Turn Table	Chance Most	CMTB-1.5	N/A	N/A
8	Spectrum Analyzer	HP	8591EM	3536A00681010	Mar. 13, 2009
9	EMI Measuring Receiver	SHCAFFNER	SCR 3501	408	Nov.24.2009
10	Spectrum Analyzer	R&S	FSP-40	100129	Sep. 9, 2009
11	Horn Antenna	Schwarzbeck	BBHA 9120 D	9120D-546	May 27, 2009
12	Microwave Pre_amplifier	Agilent	8449B	3008A02331	Jan. 14, 2010
13	Microflex Cable	NA	NA	1m	Sep. 15, 2009
14	Microflex Cable	NA	NA	10M	Feb. 20, 2009

Remark: " N/A" denotes No Model Name / Serial No. and No Calibration specified.

**4.2.3 TEST PROCEDURE**

- a. The measuring distance of at 10 m shall be used for measurements at frequency up to 1GHz. For frequencies above 1GHz, any suitable measuring distance may be used.
- b. The EUT was placed on the top of a rotating table 0.8 meters above the ground at a 3m or 10 meter open area test site. The table was rotated 360 degrees to determine the position of the highest radiation.
- c. The height of the equipment or of the substitution antenna shall be 0.8 m; the height of the test antenna shall vary between 1 m to 4 m. Both horizontal and vertical polarizations of the antenna are set to make the measurement.
- d. The initial step in collecting conducted emission data is a spectrum analyzer peak detector mode pre-scanning the measurement frequency range. Significant peaks are then marked and then Quasi Peak detector mode re-measured.
- e. If the Peak Mode measured value compliance with and lower than Quasi Peak Mode Limit, the EUT shall be deemed to meet QP Limits and then no additional QP Mode measurement performed.
- f. For the actual test configuration, please refer to the related Item –EUT Test Photos.

**4.2.4 DEVIATION FROM TEST STANDARD**

No deviation

#### 4.2.5 TEST SETUP

(A) Radiated Emission Test Set-Up, Frequency Below 1000MHz

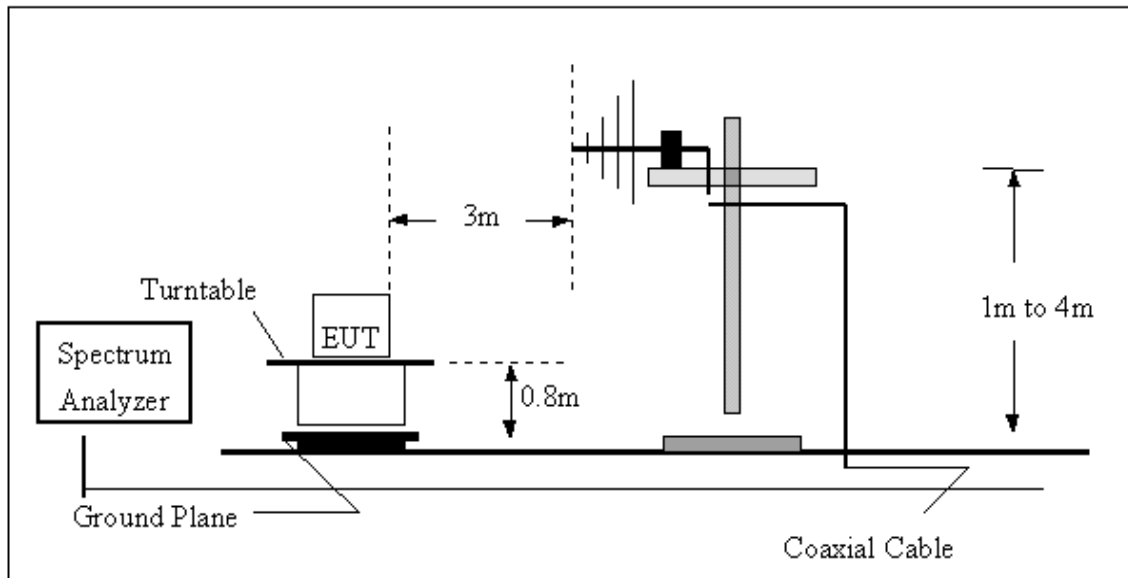

(B) Radiated Emission Test Set-UP Frequency Over 1 GHz

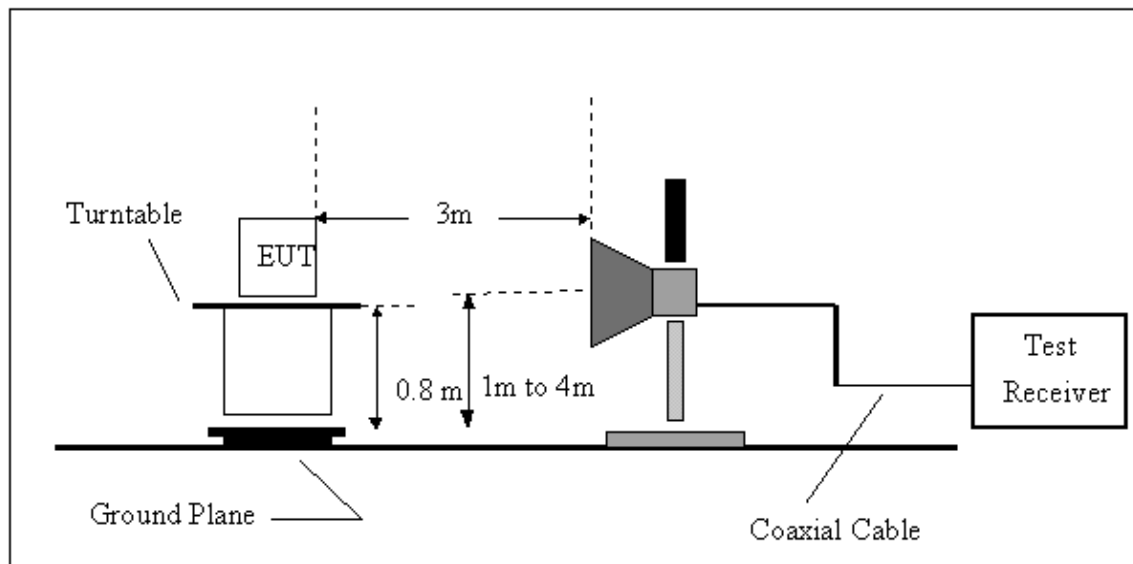

#### 4.2.6 EUT OPERATING CONDITIONS

The EUT tested system was configured as the statements of 4.1.6 Unless otherwise a special operating condition is specified in the follows during the testing.



**4.2.7 TEST RESULTS-BETWEEN 30MHZ - 1000MHZ**

EUT :	N_Max Wireless Access Point	Model Name :	WAP-6010
Temperature :	14 ° C	Relative Humidity :	64%
Test Voltage :	AC 120V/60Hz		
Test Mode :	802.11b/CH06		

Freq. (MHz)	Ant. H/V	Reading(RA) (dBuV)	Corr.Factor(CF) (dB)	Measured(FS) (dBuV/m)	Limits(QP) (dBuV/m)	Margin (dB)	Note
74.62	V	53.90	-18.26	35.64	40.00	- 4.36	
249.22	V	58.52	-13.67	44.85	46.00	- 1.15	
383.08	V	42.80	-8.47	34.33	46.00	- 11.67	
499.50	V	43.62	-5.33	38.29	46.00	- 7.71	
641.10	V	42.26	-2.24	40.02	46.00	- 5.98	
897.14	V	34.35	2.47	36.82	46.00	- 9.18	

**Remark :**

- (1) Spectrum Setting : 30MHz – 1000MHz , RBW= 100KHz, VBW=100KHz, Sweep time = 200 ms. 1GHz- 25GHz, RBW= 1MHz, VBW= 1MHz, Sweep time = Auto
- (2) All readings are Peak unless otherwise stated QP in column of 『Note』 . Peak denotes that the Peak reading compliance with the QP Limits and then QP Mode measurement didn't perform ◦
- (3) Measuring frequency range from 30MHz to 1000MHz or the 10th harmonic of highest fundamental frequency ◦ “F” denotes fundamental frequency; “ H” denotes spurious frequency. “E” denotes band edge frequency.
- (4) Radiated emissions measured in frequency range from 30 MHz to 1000 MHz were made with an instrument using Peak detector mode or QP detector mode of the emission ◦
- (5) Data of measurement within this frequency range shown “ - ” in the table above means the reading of emissions are attenuated more than 20dB below the permissible limits or the field strength is too small to be measured.

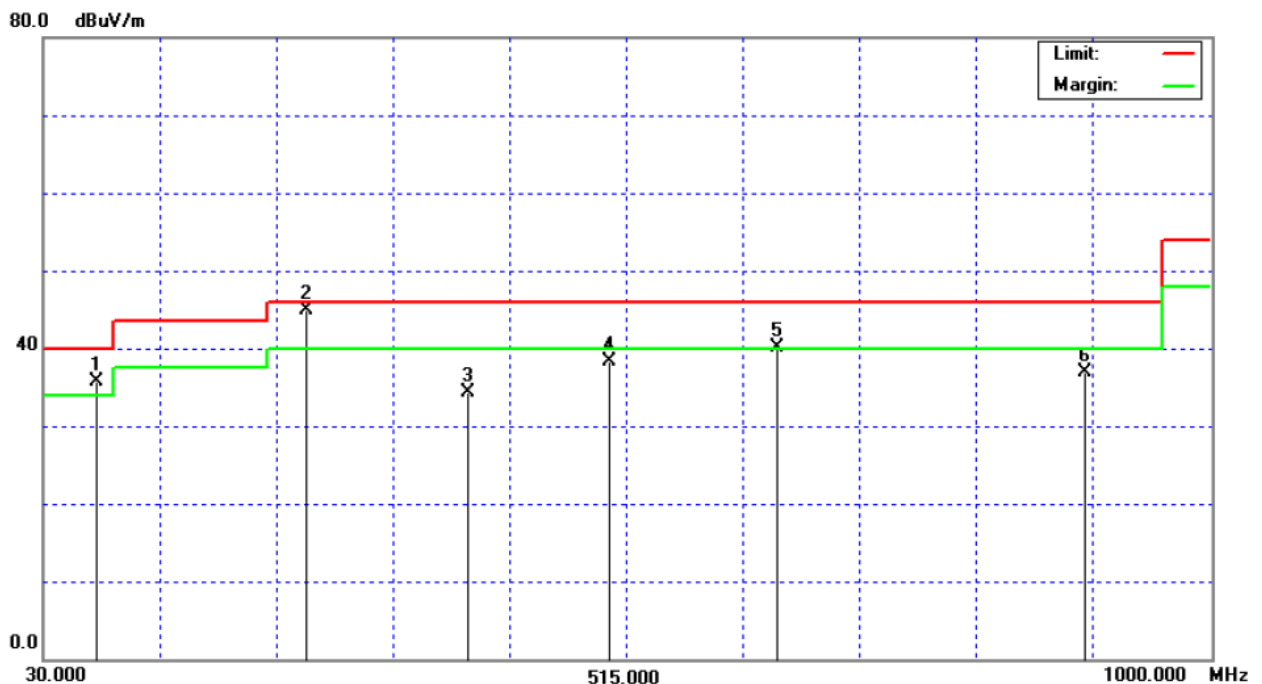



EUT :	N_Max Wireless Access Point	Model Name :	WAP-6010
Temperature :	14 °C	Relative Humidity :	64%
Test Voltage :	AC 120V/60Hz		
Test Mode :	802.11b/CH06		

Freq. (MHz)	Ant. H/V	Reading(RA) (dBuV)	Corr.Factor(CF) (dB)	Measured(FS) (dBuV/m)	Limits(QP) (dBuV/m)	Margin (dB)	Note
125.00	H	50.86	-15.36	35.50	43.50	- 8.00	
249.22	H	57.68	-13.67	44.01	46.00	- 1.99	
383.08	H	47.72	-8.47	39.25	46.00	- 6.75	
499.48	H	47.56	-5.33	42.23	46.00	- 3.77	
641.10	H	40.22	-2.24	37.98	46.00	- 8.02	
897.18	H	35.91	2.47	38.38	46.00	- 7.62	

**Remark :**

- (1) Spectrum Setting : 30MHz – 1000MHz , RBW= 100KHz, VBW=100KHz, Sweep time = 200 ms. 1GHz- 25GHz, RBW= 1MHz, VBW= 1MHz, Sweep time = Auto
- (2) All readings are Peak unless otherwise stated QP in column of 『Note』 . Peak denotes that the Peak reading compliance with the QP Limits and then QP Mode measurement didn't perform ◦
- (3) Measuring frequency range from 30MHz to 1000MHz or the 10th harmonic of highest fundamental frequency ◦ “F” denotes fundamental frequency; “ H” denotes spurious frequency. “E” denotes band edge frequency.
- (4) Radiated emissions measured in frequency range from 30 MHz to 1000 MHz were made with an instrument using Peak detector mode or QP detector mode of the emission ◦
- (5) Data of measurement within this frequency range shown “ - ” in the table above means the reading of emissions are attenuated more than 20dB below the permissible limits or the field strength is too small to be measured.

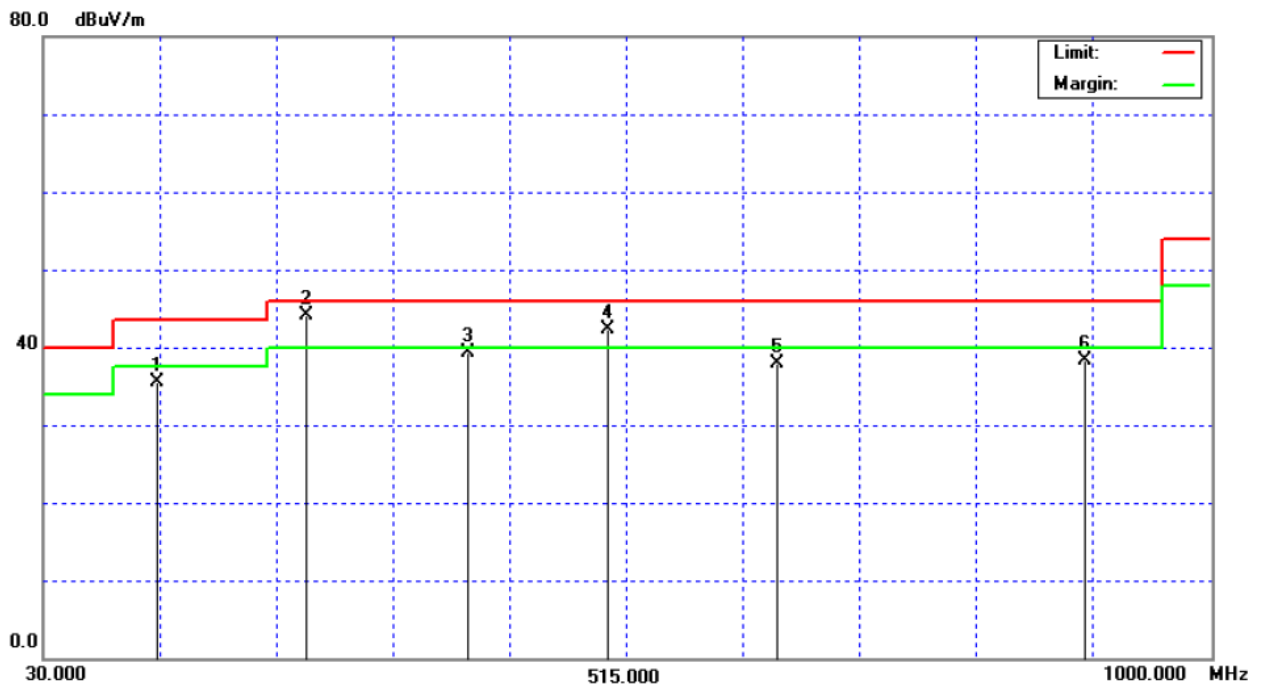



**4.2.8 TEST RESULTS - ABOVE 1000MHZ**

EUT :	N_Max Wireless Access Point	Model Name :	WAP-6010
Temperature :	13 °C	Relative Humidity :	64%
Test Voltage :	AC 120V/60Hz		
Test Mode :	802.11b/CH01		

Freq. (MHz)	Ant.Pol. H/V	Reading		Ant./CF CF(dB)	Act.		Limit		Note
		Peak (dBuV)	AV (dBuV)		Peak (dBuV/m)	AV (dBuV/m)	Peak (dBuV/m)	AV (dBuV/m)	
2386.60	V	25.92	15.81	32.55	58.47	48.36	74.00	54.00	X/H
2409.20	V	72.57	68.95	32.68	105.25	101.63			X/F
4823.96	V	55.87	49.44	4.04	59.91	53.48	74.00	54.00	X/H

**Remark :**

- (1) Spectrum Setting : 30MHz – 1000MHz , RBW= 100KHz, VBW=100KHz, Sweep time = 200 ms. 1GHz- 25GHz, RBW= 1MHz, VBW= 1MHz, Sweep time = Auto
- (2) All readings are Peak unless otherwise stated AV in column of 『Note』 . Peak denotes that the Peak reading compliance with the AV Limits and then AV Mode measurement didn't perform.
- (3) Measuring frequency range from 30MHz to 1000MHz or the 10th harmonic of highest fundamental frequency. "F" denotes fundamental frequency; "H" denotes spurious frequency. "E" denotes band edge frequency. (This judgment method includes the Band Edge Requirement.)
- (4) Radiated emissions measured in frequency range above 1000MHz were made with an instrument using Peak detector mode and AV detector mode of the emission .
- (5) Data of measurement within this frequency range shown " \* " in the table above means the reading of emissions are attenuated more than 20dB below the permissible limits or the field strength is too small to be measured.
- (6) A preamp and high pass filter were used for this test in order to provide sufficient measurement sensitivity.
- (7) EUT Orthogonal Axes :  
"X" - denotes Laid on Table ; "Y" - denotes Vertical Stand ; "Z" - denotes Side Stand
- (8) During the measurements above 1GHz it is taken care of that the EUT is always within the 3dB cone of radiation BW of the used antenna.





Orthogonal Axis : X  
802.11b/CH01(Above 1000 MHz, Vertical)

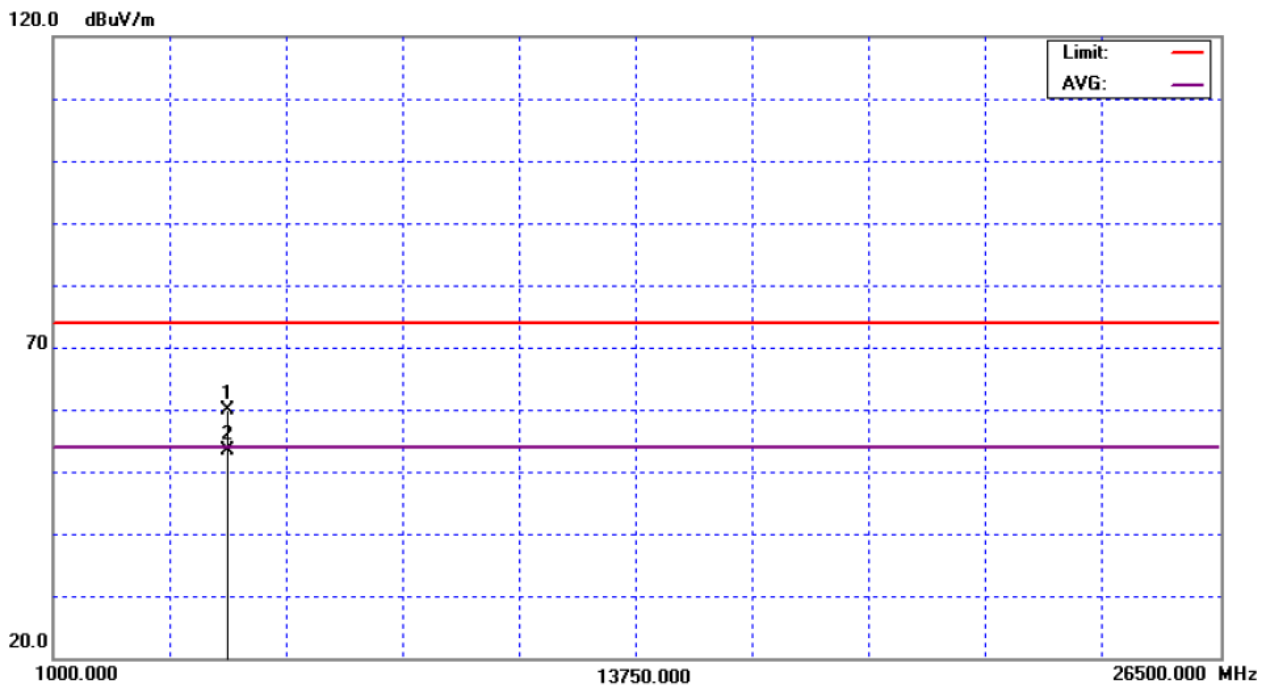
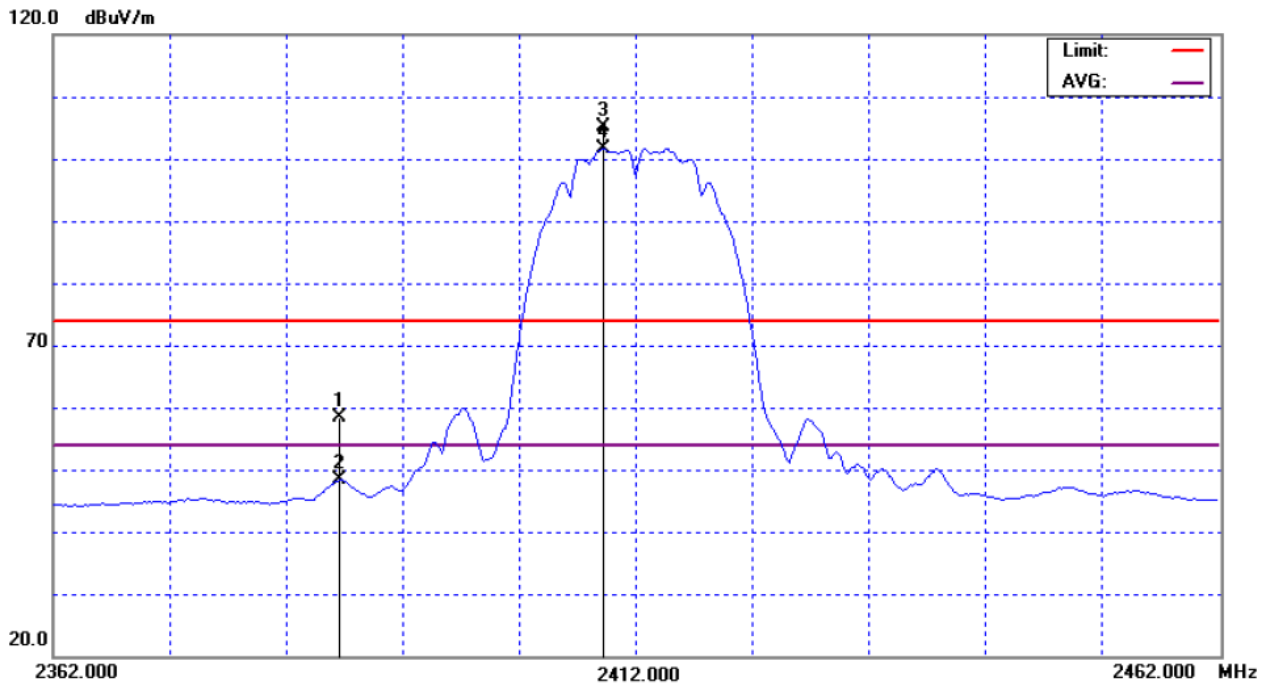



EUT :	N_Max Wireless Access Point	Model Name :	WAP-6010
Temperature :	13 ° C	Relative Humidity :	64%
Test Voltage :	AC 120V/60Hz		
Test Mode :	802.11b/CH01		

Freq. (MHz)	Ant.Pol. H/V	Reading		Ant./CF CF(dB)	Act.		Limit		Note
		Peak (dBuV)	AV (dBuV)		Peak (dBuV/m)	AV (dBuV/m)	Peak (dBuV/m)	AV (dBuV/m)	
2386.60	H	24.38	15.66	32.55	56.93	48.21	74.00	54.00	X/H
2409.20	H	68.96	66.38	32.68	101.64	99.06			X/F
4823.96	H	47.49	41.73	4.04	51.53	45.77	74.00	54.00	X/H

**Remark :**

- (1) Spectrum Setting : 30MHz – 1000MHz , RBW= 100KHz, VBW=100KHz, Sweep time = 200 ms. 1GHz- 25GHz, RBW= 1MHz, VBW= 1MHz, Sweep time = Auto
- (2) All readings are Peak unless otherwise stated AV in column of 『Note』 . Peak denotes that the Peak reading compliance with the AV Limits and then AV Mode measurement didn't perform.
- (3) Measuring frequency range from 30MHz to 1000MHz or the 10th harmonic of highest fundamental frequency. "F" denotes fundamental frequency; "H" denotes spurious frequency. "E" denotes band edge frequency. (This judgment method includes the Band Edge Requirement.)
- (4) Radiated emissions measured in frequency range above 1000MHz were made with an instrument using Peak detector mode and AV detector mode of the emission .
- (5) Data of measurement within this frequency range shown " \* " in the table above means the reading of emissions are attenuated more than 20dB below the permissible limits or the field strength is too small to be measured.
- (6) A preamp and high pass filter were used for this test in order to provide sufficient measurement sensitivity.
- (7) EUT Orthogonal Axes :  
"X" - denotes Laid on Table ; "Y" - denotes Vertical Stand ; "Z" - denotes Side Stand
- (8) During the measurements above 1GHz it is taken care of that the EUT is always within the 3dB cone of radiation BW of the used antenna.



Orthogonal Axis : X  
802.11b/CH01(Above 1000 MHz, Horizontal)

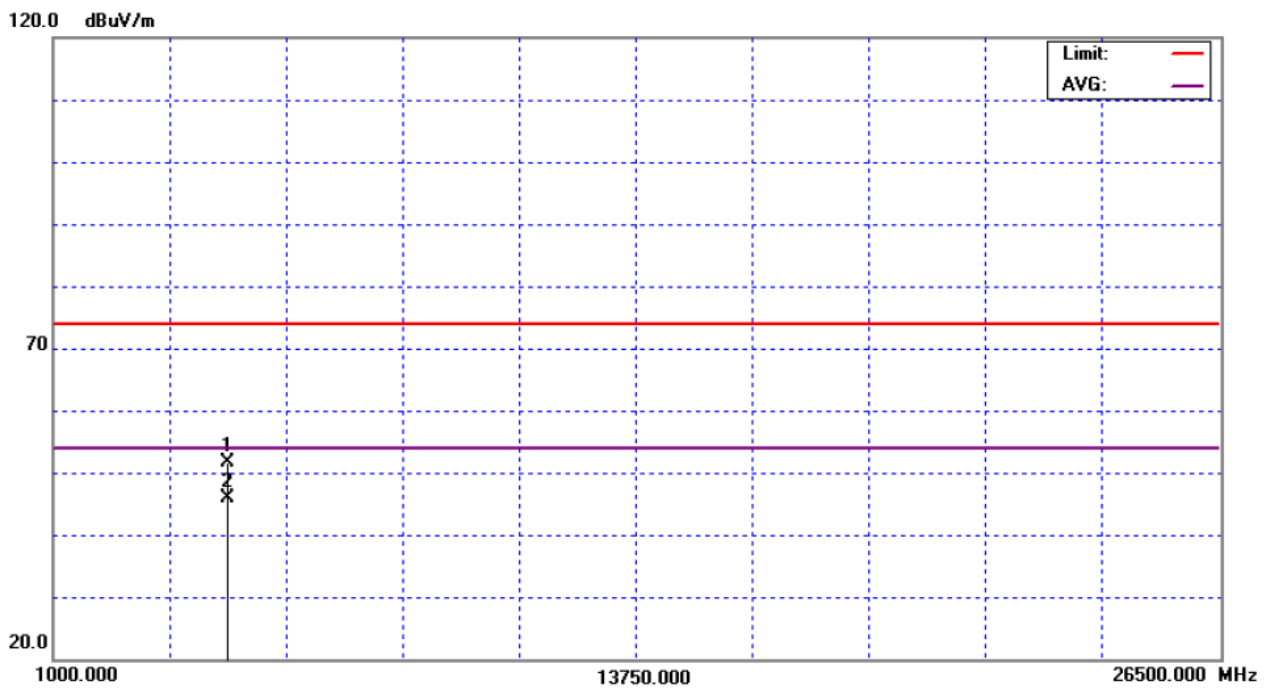
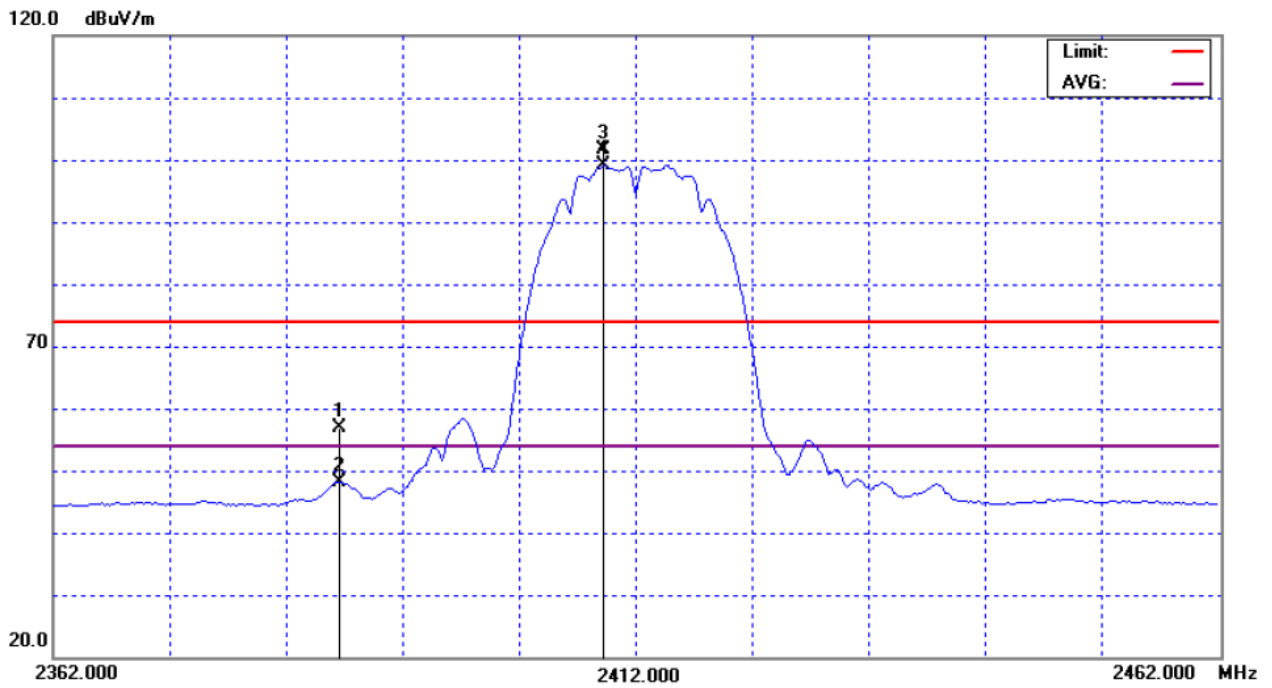



EUT :	N_Max Wireless Access Point	Model Name :	WAP-6010
Temperature :	13 °C	Relative Humidity :	64%
Test Voltage :	AC 120V/60Hz		
Test Mode :	802.11b/CH06		

Freq. (MHz)	Ant.Pol. H/V	Reading		Ant./CF CF(dB)	Act.		Limit		Note
		Peak (dBuV)	AV (dBuV)		Peak (dBuV/m)	AV (dBuV/m)	Peak (dBuV/m)	AV (dBuV/m)	
2436.20	V	73.77	70.30	32.83	106.60	103.13			X/F
4874.00	V	55.38	49.21	4.29	59.67	53.50	74.00	54.00	X/H

**Remark :**

- (1) Spectrum Setting : 30MHz – 1000MHz , RBW= 100KHz, VBW=100KHz, Sweep time = 200 ms. 1GHz- 25GHz, RBW= 1MHz, VBW= 1MHz, Sweep time = Auto
- (2) All readings are Peak unless otherwise stated AV in column of 『Note』 . Peak denotes that the Peak reading compliance with the AV Limits and then AV Mode measurement didn't perform.
- (3) Measuring frequency range from 30MHz to 1000MHz or the 10th harmonic of highest fundamental frequency. "F" denotes fundamental frequency; "H" denotes spurious frequency. "E" denotes band edge frequency. (This judgment method includes the Band Edge Requirement.)
- (4) Radiated emissions measured in frequency range above 1000MHz were made with an instrument using Peak detector mode and AV detector mode of the emission .
- (5) Data of measurement within this frequency range shown " \* " in the table above means the reading of emissions are attenuated more than 20dB below the permissible limits or the field strength is too small to be measured.
- (6) A preamp and high pass filter were used for this test in order to provide sufficient measurement sensitivity.
- (7) EUT Orthogonal Axes :  
 "X" - denotes Laid on Table ; "Y" - denotes Vertical Stand ; "Z" - denotes Side Stand
- (8) During the measurements above 1GHz it is taken care of that the EUT is always within the 3dB cone of radiation BW of the used antenna.



Orthogonal Axis : X  
802.11b/CH06(Above 1000 MHz, Vertical)

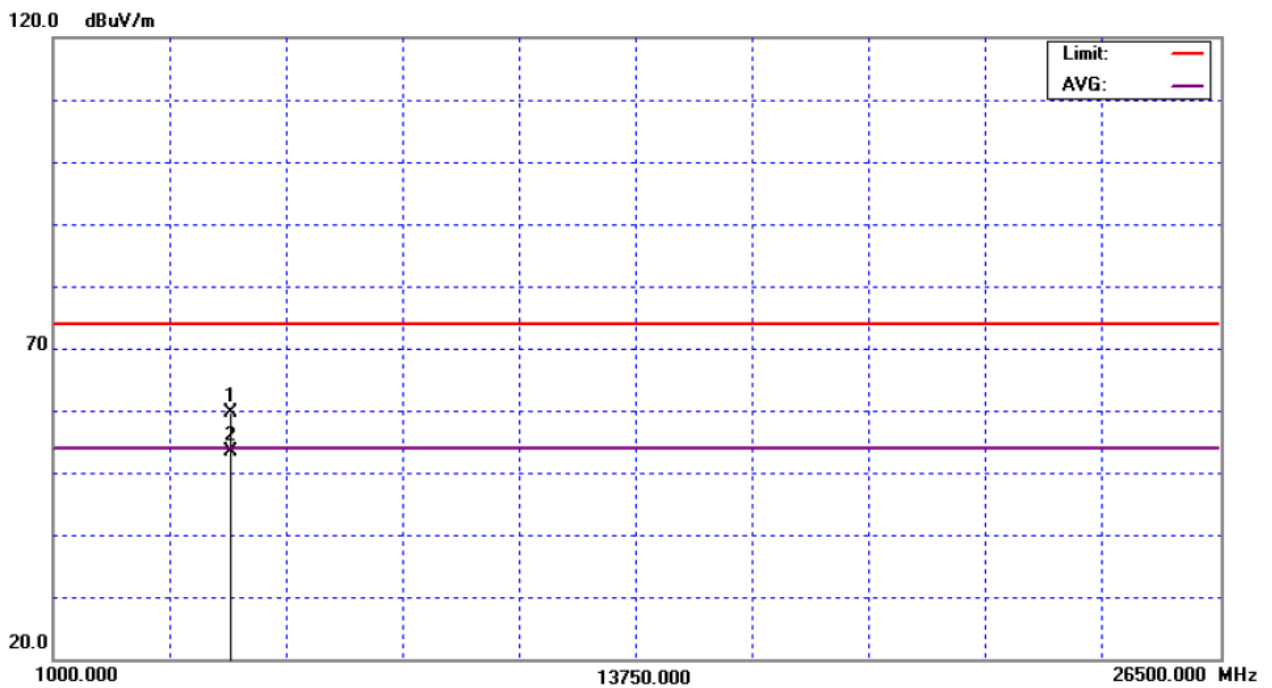
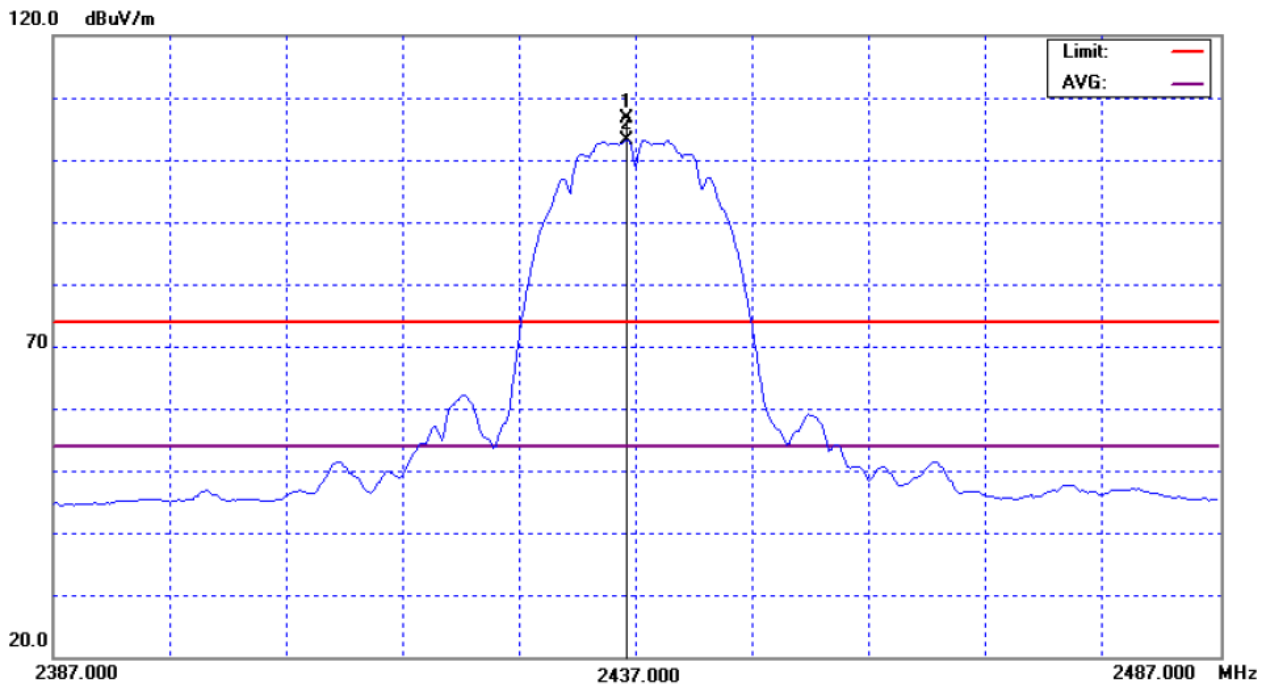



EUT :	N_Max Wireless Access Point	Model Name :	WAP-6010
Temperature :	13 °C	Relative Humidity :	64%
Test Voltage :	AC 120V/60Hz		
Test Mode :	802.11b/CH06		

Freq. (MHz)	Ant.Pol. H/V	Reading		Ant./CF CF(dB)	Act.		Limit		Note
		Peak (dBuV)	AV (dBuV)		Peak (dBuV/m)	AV (dBuV/m)	Peak (dBuV/m)	AV (dBuV/m)	
2439.80	H	70.57	67.44	32.85	103.42	100.29			X/F
4873.92	H	46.21	40.91	4.29	50.50	45.20	74.00	54.00	X/H

**Remark :**

- (1) Spectrum Setting : 30MHz – 1000MHz , RBW= 100KHz, VBW=100KHz, Sweep time = 200 ms. 1GHz- 25GHz, RBW= 1MHz, VBW= 1MHz, Sweep time = Auto
- (2) All readings are Peak unless otherwise stated AV in column of 『Note』 . Peak denotes that the Peak reading compliance with the AV Limits and then AV Mode measurement didn't perform.
- (3) Measuring frequency range from 30MHz to 1000MHz or the 10th harmonic of highest fundamental frequency. "F" denotes fundamental frequency; "H" denotes spurious frequency. "E" denotes band edge frequency. (This judgment method includes the Band Edge Requirement.)
- (4) Radiated emissions measured in frequency range above 1000MHz were made with an instrument using Peak detector mode and AV detector mode of the emission .
- (5) Data of measurement within this frequency range shown " \* " in the table above means the reading of emissions are attenuated more than 20dB below the permissible limits or the field strength is too small to be measured.
- (6) A preamp and high pass filter were used for this test in order to provide sufficient measurement sensitivity.
- (7) EUT Orthogonal Axes :  
"X" - denotes Laid on Table ; "Y" - denotes Vertical Stand ; "Z" - denotes Side Stand
- (8) During the measurements above 1GHz it is taken care of that the EUT is always within the 3dB cone of radiation BW of the used antenna.



Orthogonal Axis : X  
802.11b/CH06(Above 1000 MHz, Horizontal)

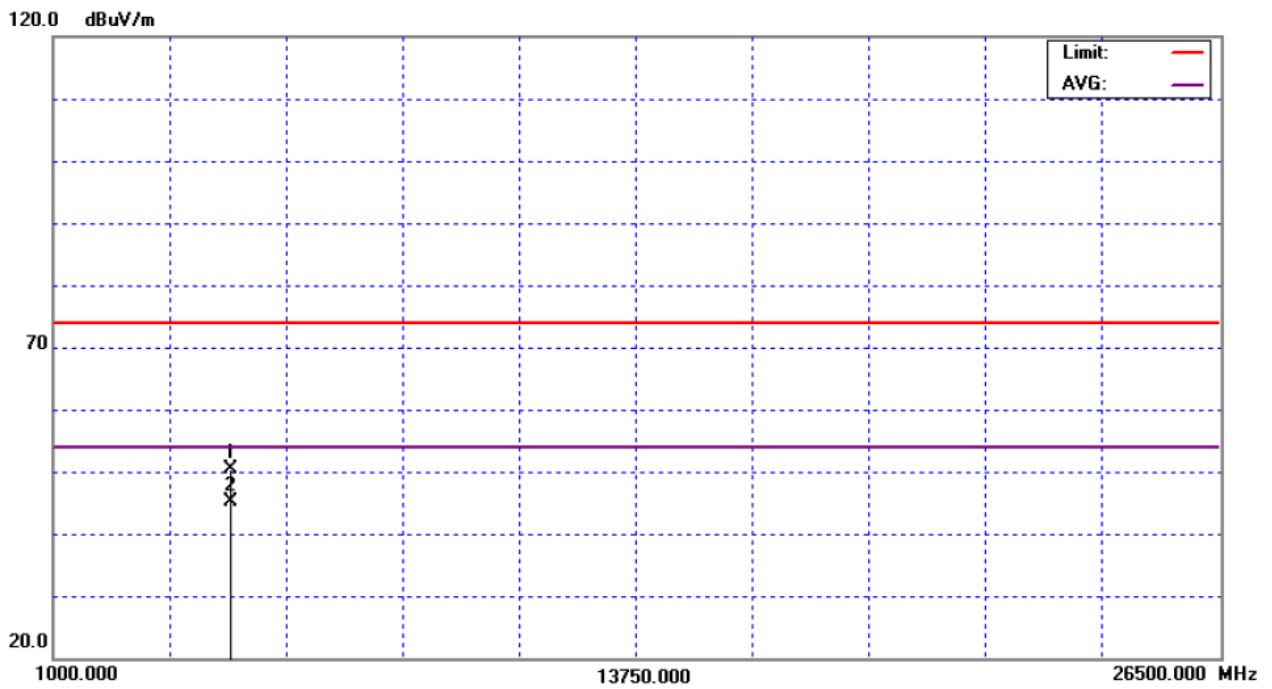
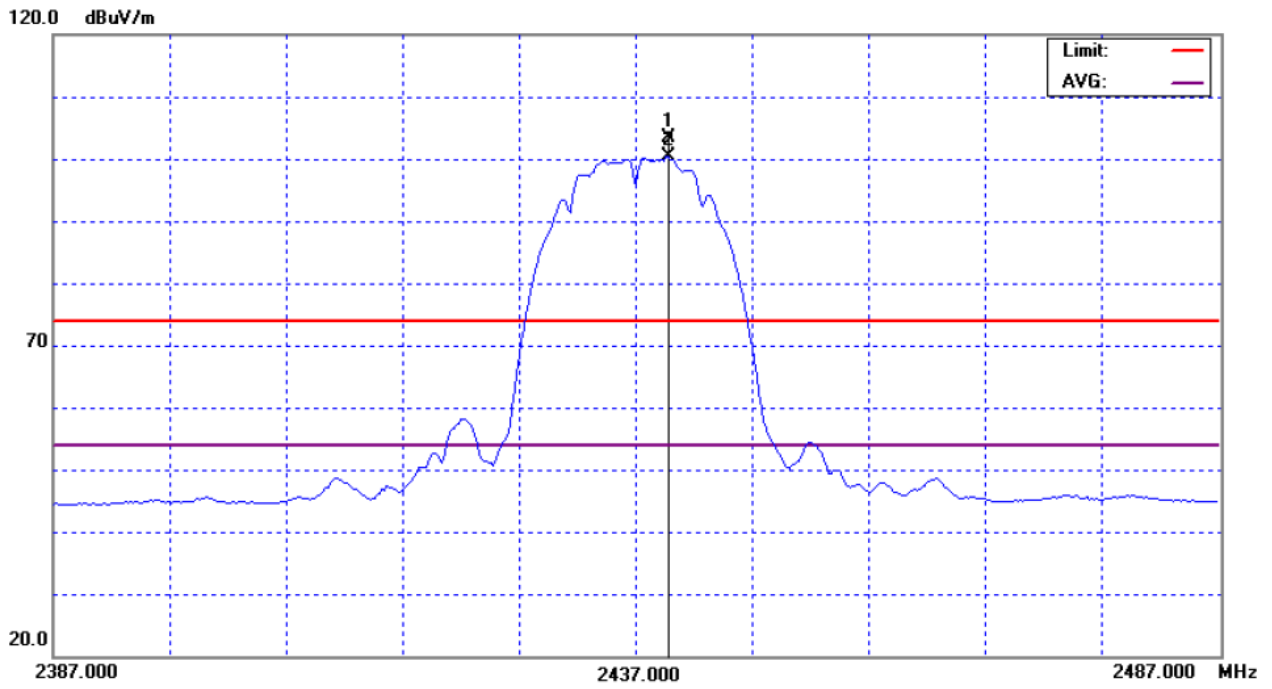



EUT :	N_Max Wireless Access Point	Model Name :	WAP-6010
Temperature :	13 °C	Relative Humidity :	64%
Test Voltage :	AC 120V/60Hz		
Test Mode :	802.11b/CH11		

Freq. (MHz)	Ant.Pol. H/V	Reading		Ant./CF CF(dB)	Act.		Limit		Note
		Peak (dBuV)	AV (dBuV)		Peak (dBuV/m)	AV (dBuV/m)	Peak (dBuV/m)	AV (dBuV/m)	
2459.20	V	73.26	70.64	32.96	106.22	103.60			X/F
2487.70	V	26.43	18.81	33.12	59.55	51.93	74.00	54.00	X/H
4923.94	V	54.39	48.89	4.53	58.92	53.42	74.00	54.00	X/H

**Remark :**

- (1) Spectrum Setting : 30MHz – 1000MHz , RBW= 100KHz, VBW=100KHz, Sweep time = 200 ms. 1GHz- 25GHz, RBW= 1MHz, VBW= 1MHz, Sweep time = Auto
- (2) All readings are Peak unless otherwise stated AV in column of 『Note』 . Peak denotes that the Peak reading compliance with the AV Limits and then AV Mode measurement didn't perform.
- (3) Measuring frequency range from 30MHz to 1000MHz or the 10th harmonic of highest fundamental frequency. "F" denotes fundamental frequency; "H" denotes spurious frequency. "E" denotes band edge frequency. (This judgment method includes the Band Edge Requirement.)
- (4) Radiated emissions measured in frequency range above 1000MHz were made with an instrument using Peak detector mode and AV detector mode of the emission .
- (5) Data of measurement within this frequency range shown " \* " in the table above means the reading of emissions are attenuated more than 20dB below the permissible limits or the field strength is too small to be measured.
- (6) A preamp and high pass filter were used for this test in order to provide sufficient measurement sensitivity.
- (7) EUT Orthogonal Axes :  
"X" - denotes Laid on Table ; "Y" - denotes Vertical Stand ; "Z" - denotes Side Stand
- (8) During the measurements above 1GHz it is taken care of that the EUT is always within the 3dB cone of radiation BW of the used antenna.





Orthogonal Axis : X  
802.11b/CH11(Above 1000 MHz, Vertical)

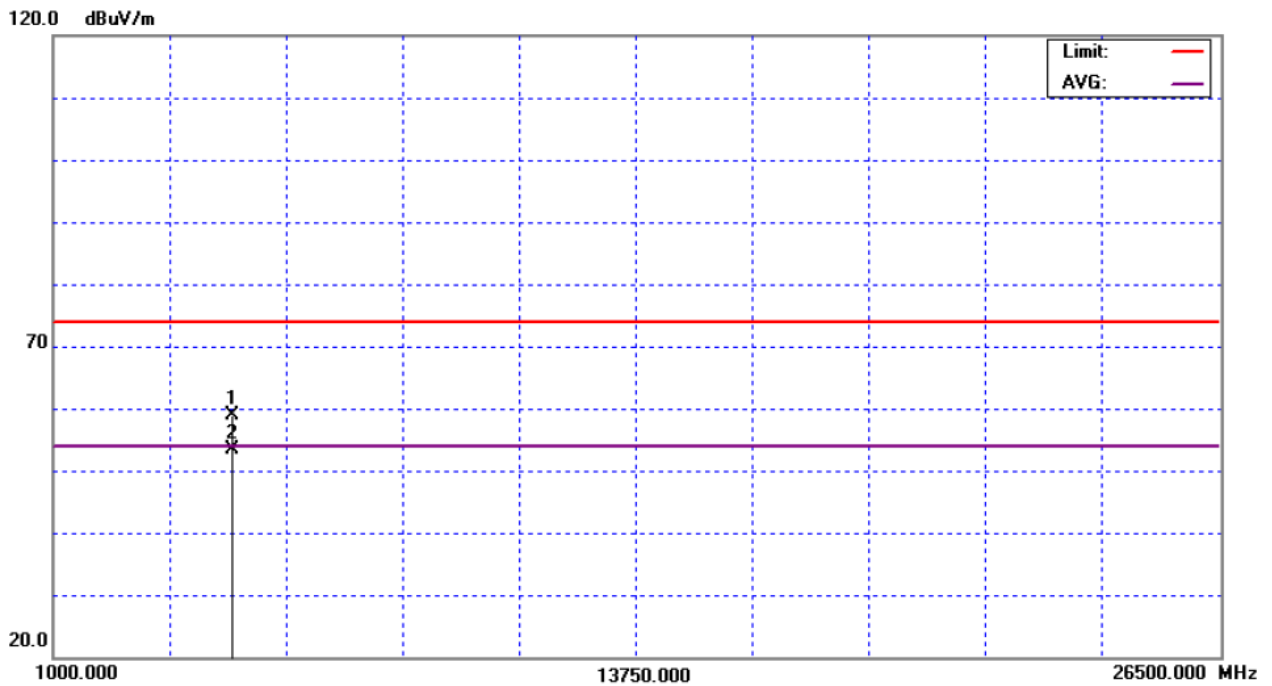
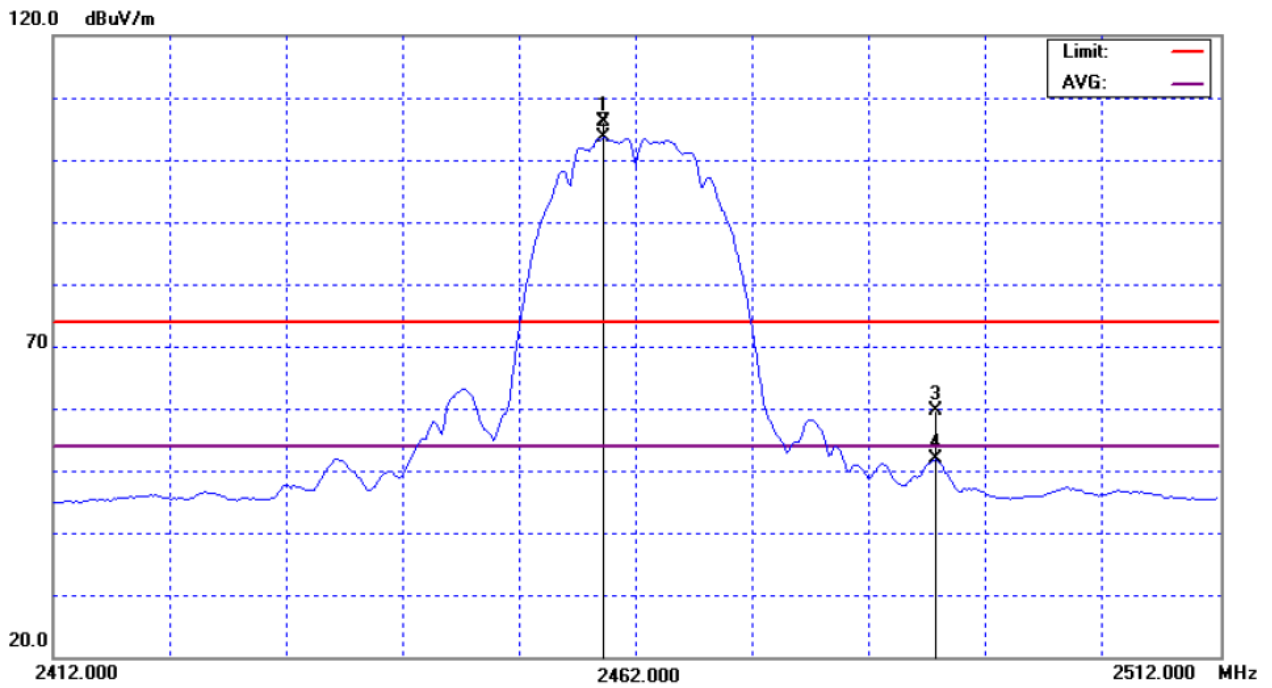



EUT :	N_Max Wireless Access Point	Model Name :	WAP-6010
Temperature :	13 ° C	Relative Humidity :	64%
Test Voltage :	AC 120V/60Hz		
Test Mode :	802.11b/CH11		

Freq. (MHz)	Ant.Pol. H/V	Reading		Ant./CF CF(dB)	Act.		Limit		Note
		Peak (dBuV)	AV (dBuV)		Peak (dBuV/m)	AV (dBuV/m)	Peak (dBuV/m)	AV (dBuV/m)	
2461.20	H	69.48	65.98	32.97	102.45	98.95			X/F
2487.70	H	25.35	15.48	33.12	58.47	48.60	74.00	54.00	X/H
4923.92	H	46.76	41.81	4.53	51.29	46.34	74.00	54.00	X/H

**Remark :**

- (1) Spectrum Setting : 30MHz – 1000MHz , RBW= 100KHz, VBW=100KHz, Sweep time = 200 ms. 1GHz- 25GHz, RBW= 1MHz, VBW= 1MHz, Sweep time = Auto
- (2) All readings are Peak unless otherwise stated AV in column of 『Note』 . Peak denotes that the Peak reading compliance with the AV Limits and then AV Mode measurement didn't perform.
- (3) Measuring frequency range from 30MHz to 1000MHz or the 10th harmonic of highest fundamental frequency. "F" denotes fundamental frequency; "H" denotes spurious frequency. "E" denotes band edge frequency. (This judgment method includes the Band Edge Requirement.)
- (4) Radiated emissions measured in frequency range above 1000MHz were made with an instrument using Peak detector mode and AV detector mode of the emission .
- (5) Data of measurement within this frequency range shown " \* " in the table above means the reading of emissions are attenuated more than 20dB below the permissible limits or the field strength is too small to be measured.
- (6) A preamp and high pass filter were used for this test in order to provide sufficient measurement sensitivity.
- (7) EUT Orthogonal Axes :  
"X" - denotes Laid on Table ; "Y" - denotes Vertical Stand ; "Z" - denotes Side Stand
- (8) During the measurements above 1GHz it is taken care of that the EUT is always within the 3dB cone of radiation BW of the used antenna.



Orthogonal Axis : X  
802.11b/CH11(Above 1000 MHz, Horizontal)

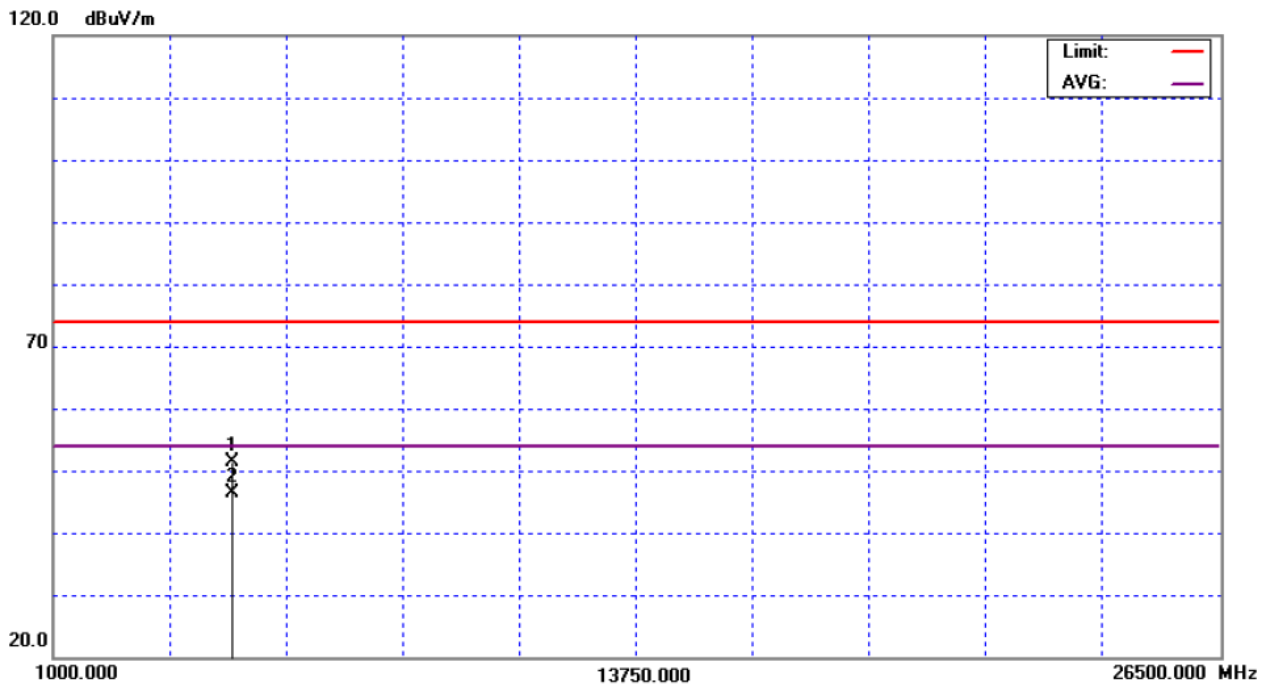
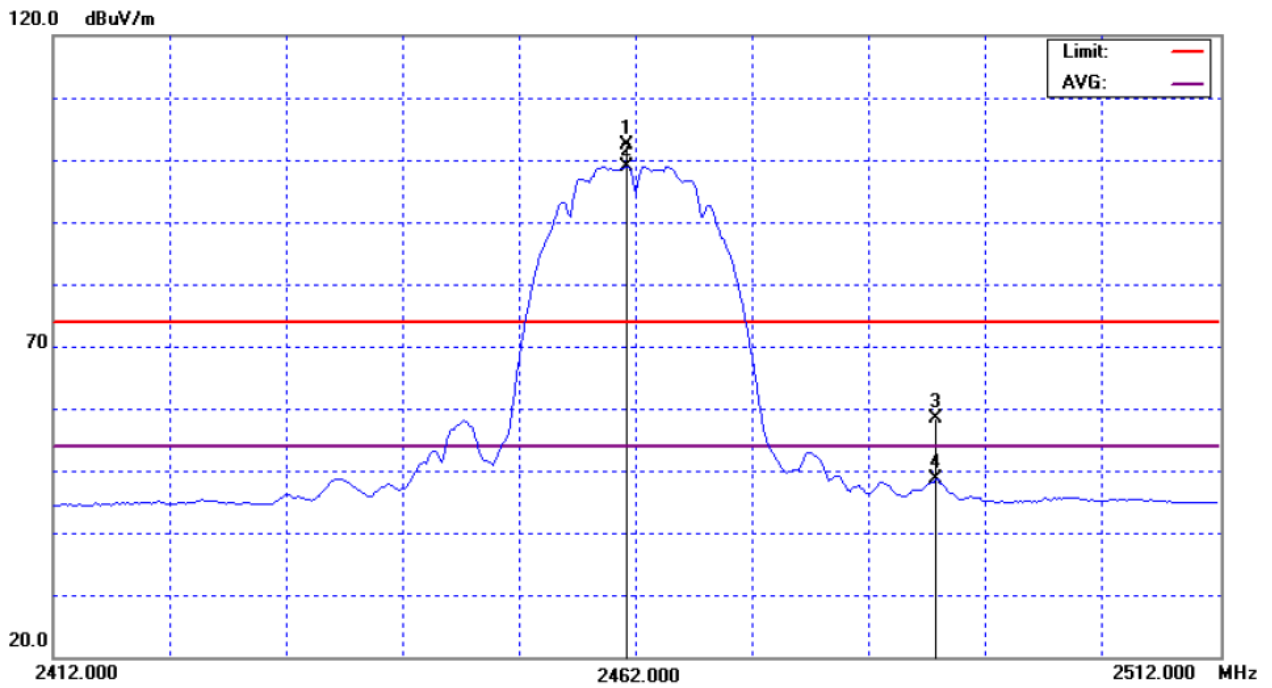



EUT :	N_Max Wireless Access Point	Model Name :	WAP-6010
Temperature :	13 °C	Relative Humidity :	64%
Test Voltage :	AC 120V/60Hz		
Test Mode :	802.11g/CH01		

Freq. (MHz)	Ant.Pol. H/V	Reading		Ant./CF CF(dB)	Act.		Limit		Note
		Peak (dBuV)	AV (dBuV)		Peak (dBuV/m)	AV (dBuV/m)	Peak (dBuV/m)	AV (dBuV/m)	
2390.00	V	28.43	16.27	32.57	61.00	48.84	74.00	54.00	X/H
2408.60	V	73.00	64.19	32.68	105.68	96.87			X/F
4824.00	V	52.17	39.33	4.05	56.22	43.38	74.00	54.00	X/H

**Remark :**

- (1) Spectrum Setting : 30MHz – 1000MHz , RBW= 100KHz, VBW=100KHz, Sweep time = 200 ms. 1GHz- 25GHz, RBW= 1MHz, VBW= 1MHz, Sweep time = Auto
- (2) All readings are Peak unless otherwise stated AV in column of 『Note』 . Peak denotes that the Peak reading compliance with the AV Limits and then AV Mode measurement didn't perform.
- (3) Measuring frequency range from 30MHz to 1000MHz or the 10th harmonic of highest fundamental frequency. "F" denotes fundamental frequency; "H" denotes spurious frequency. "E" denotes band edge frequency. (This judgment method includes the Band Edge Requirement.)
- (4) Radiated emissions measured in frequency range above 1000MHz were made with an instrument using Peak detector mode and AV detector mode of the emission .
- (5) Data of measurement within this frequency range shown " \* " in the table above means the reading of emissions are attenuated more than 20dB below the permissible limits or the field strength is too small to be measured.
- (6) A preamp and high pass filter were used for this test in order to provide sufficient measurement sensitivity.
- (7) EUT Orthogonal Axes :  
"X" - denotes Laid on Table ; "Y" - denotes Vertical Stand ; "Z" - denotes Side Stand
- (8) During the measurements above 1GHz it is taken care of that the EUT is always within the 3dB cone of radiation BW of the used antenna.



Orthogonal Axis : X  
802.11g/CH01(Above 1000 MHz, Vertical)

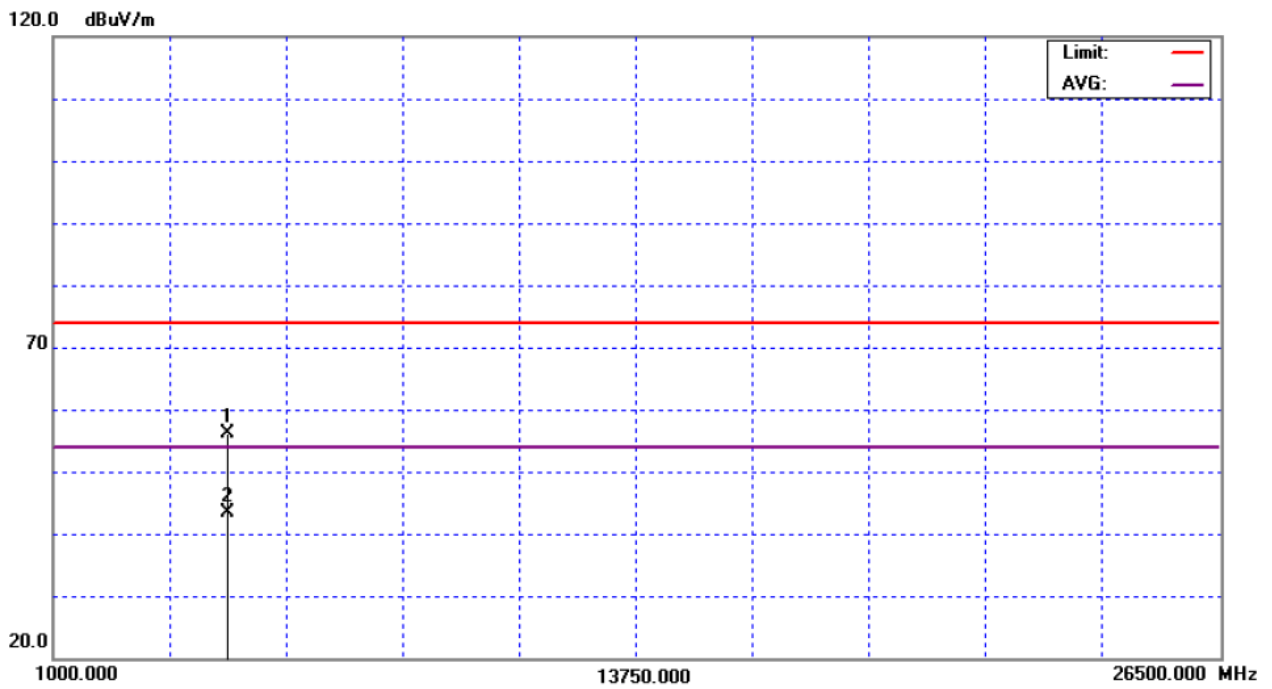
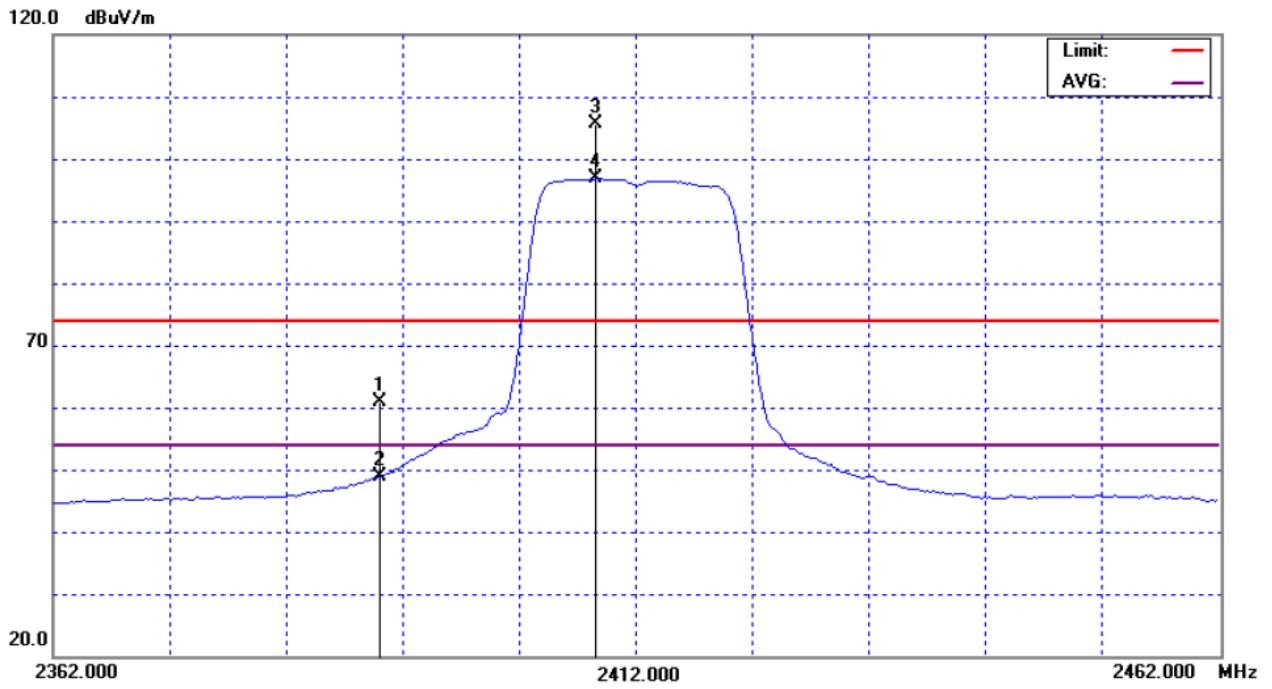



EUT :	N_Max Wireless Access Point	Model Name :	WAP-6010
Temperature :	13 ° C	Relative Humidity :	64%
Test Voltage :	AC 120V/60Hz		
Test Mode :	802.11g/CH01		

Freq. (MHz)	Ant.Pol. H/V	Reading		Ant./CF CF(dB)	Act.		Limit		Note
		Peak (dBuV)	AV (dBuV)		Peak (dBuV/m)	AV (dBuV/m)	Peak (dBuV/m)	AV (dBuV/m)	
2390.00	H	24.89	13.94	32.57	57.46	46.51	74.00	54.00	X/H
2410.80	H	69.77	60.99	32.69	102.46	93.68			X/F
823.80	H	48.14	35.48	4.04	52.18	39.52	66.00	46.00	X/H

**Remark :**

- (1) Spectrum Setting : 30MHz – 1000MHz , RBW= 100KHz, VBW=100KHz, Sweep time = 200 ms. 1GHz- 25GHz, RBW= 1MHz, VBW= 1MHz, Sweep time = Auto
- (2) All readings are Peak unless otherwise stated AV in column of 『Note』 . Peak denotes that the Peak reading compliance with the AV Limits and then AV Mode measurement didn't perform.
- (3) Measuring frequency range from 30MHz to 1000MHz or the 10th harmonic of highest fundamental frequency. "F" denotes fundamental frequency; "H" denotes spurious frequency. "E" denotes band edge frequency. (This judgment method includes the Band Edge Requirement.)
- (4) Radiated emissions measured in frequency range above 1000MHz were made with an instrument using Peak detector mode and AV detector mode of the emission .
- (5) Data of measurement within this frequency range shown " \* " in the table above means the reading of emissions are attenuated more than 20dB below the permissible limits or the field strength is too small to be measured.
- (6) A preamp and high pass filter were used for this test in order to provide sufficient measurement sensitivity.
- (7) EUT Orthogonal Axes :  
"X" - denotes Laid on Table ; "Y" - denotes Vertical Stand ; "Z" - denotes Side Stand
- (8) During the measurements above 1GHz it is taken care of that the EUT is always within the 3dB cone of radiation BW of the used antenna.



Orthogonal Axis : X  
802.11g/CH01(Above 1000 MHz, Horizontal)

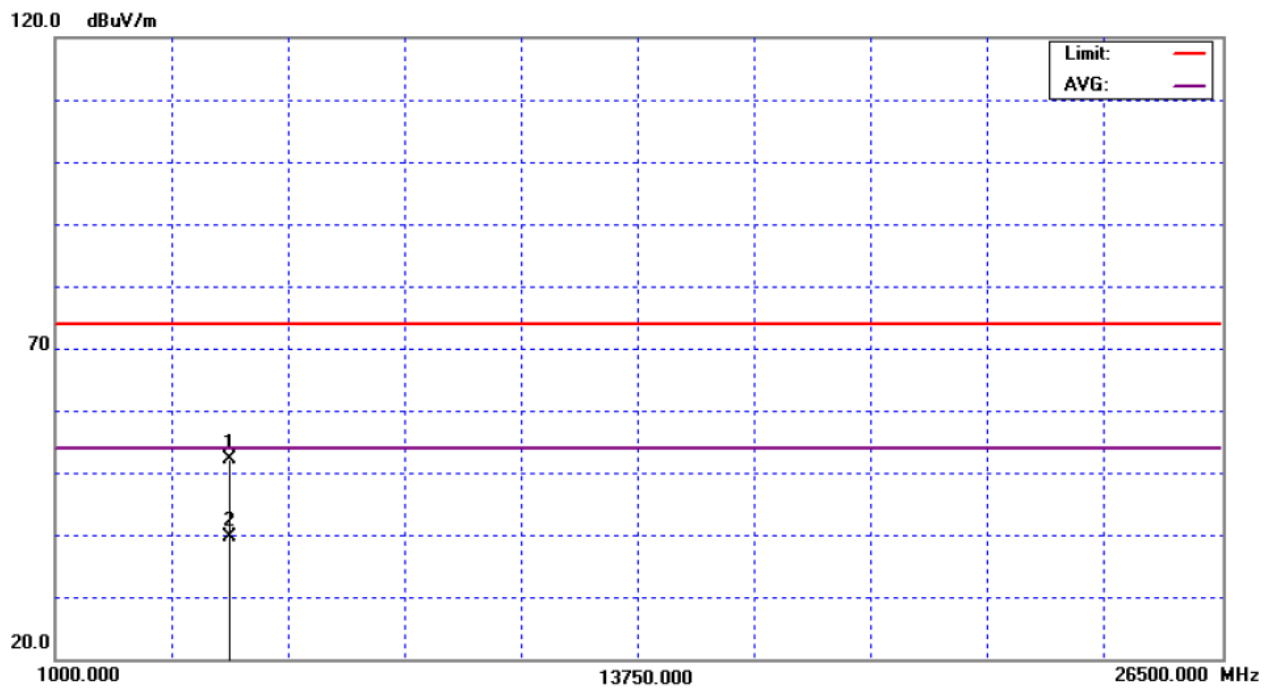
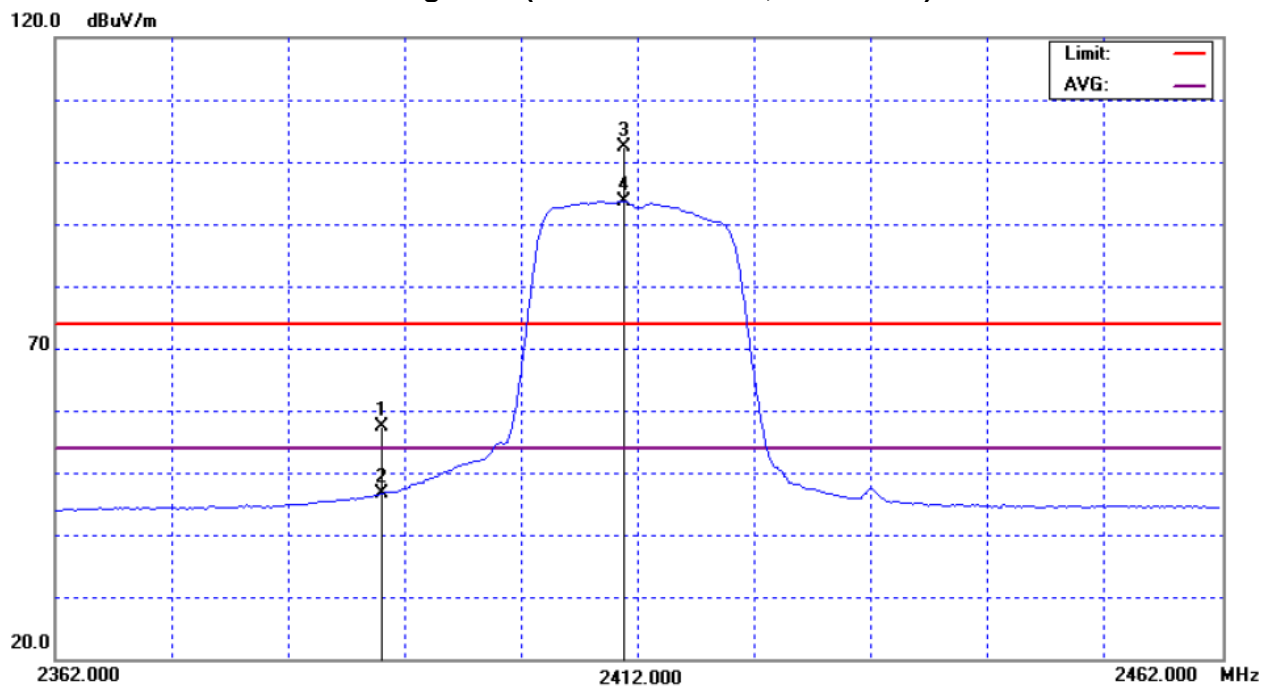



EUT :	N_Max Wireless Access Point	Model Name :	WAP-6010
Temperature :	13 °C	Relative Humidity :	64%
Test Voltage :	AC 120V/60Hz		
Test Mode :	802.11g/CH06		

Freq. (MHz)	Ant.Pol. H/V	Reading		Ant./CF CF(dB)	Act.		Limit		Note
		Peak (dBuV)	AV (dBuV)		Peak (dBuV/m)	AV (dBuV/m)	Peak (dBuV/m)	AV (dBuV/m)	
2432.40	V	76.53	65.80	32.81	109.34	98.61			X/F
4872.86	V	49.76	36.78	4.28	54.04	41.06	74.00	54.00	X/H

**Remark :**

- (1) Spectrum Setting : 30MHz – 1000MHz , RBW= 100KHz, VBW=100KHz, Sweep time = 200 ms. 1GHz- 25GHz, RBW= 1MHz, VBW= 1MHz, Sweep time = Auto
- (2) All readings are Peak unless otherwise stated AV in column of 『Note』 . Peak denotes that the Peak reading compliance with the AV Limits and then AV Mode measurement didn't perform.
- (3) Measuring frequency range from 30MHz to 1000MHz or the 10th harmonic of highest fundamental frequency. "F" denotes fundamental frequency; "H" denotes spurious frequency. "E" denotes band edge frequency. (This judgment method includes the Band Edge Requirement.)
- (4) Radiated emissions measured in frequency range above 1000MHz were made with an instrument using Peak detector mode and AV detector mode of the emission .
- (5) Data of measurement within this frequency range shown " \* " in the table above means the reading of emissions are attenuated more than 20dB below the permissible limits or the field strength is too small to be measured.
- (6) A preamp and high pass filter were used for this test in order to provide sufficient measurement sensitivity.
- (7) EUT Orthogonal Axes :  
"X" - denotes Laid on Table ; "Y" - denotes Vertical Stand ; "Z" - denotes Side Stand
- (8) During the measurements above 1GHz it is taken care of that the EUT is always within the 3dB cone of radiation BW of the used antenna.





Orthogonal Axis : X  
802.11g/CH06(Above 1000 MHz, Vertical)

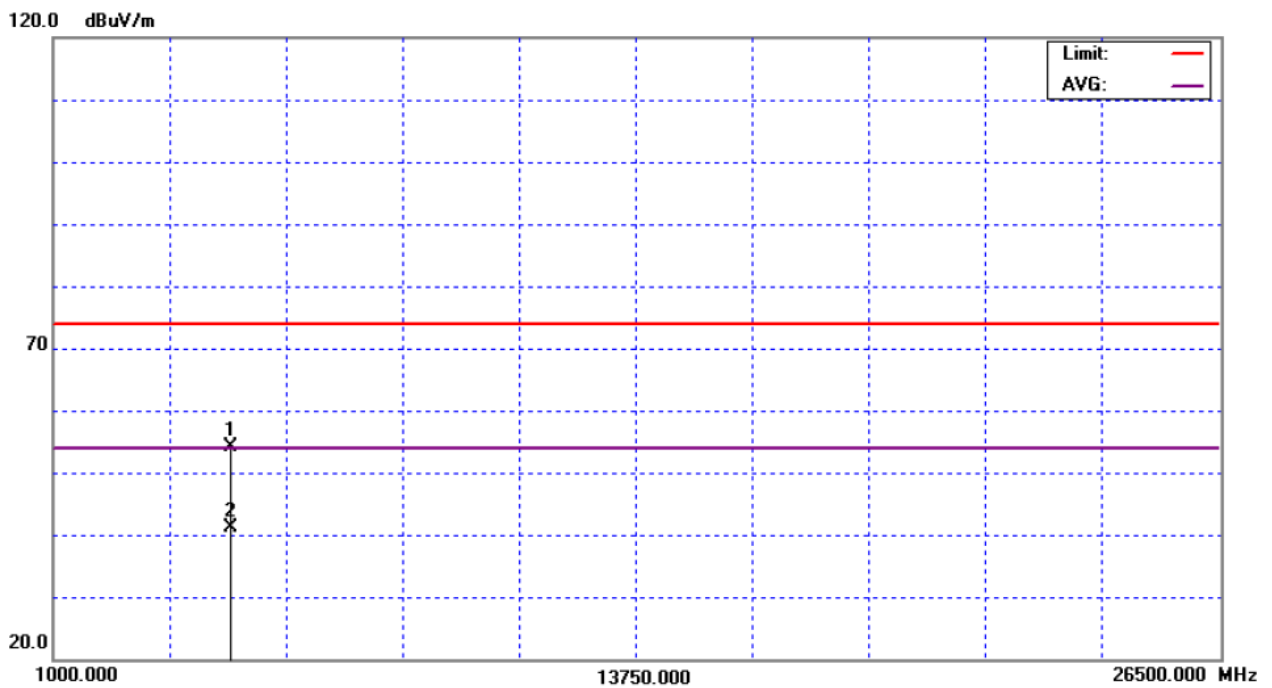
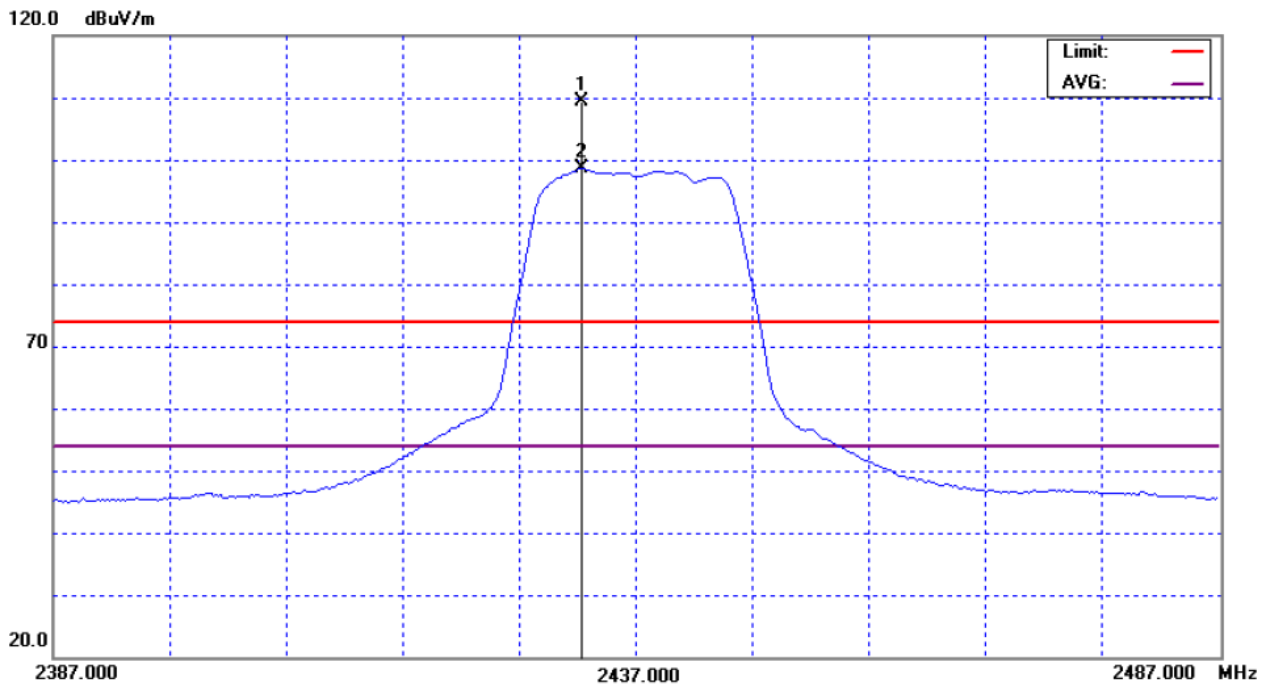



EUT :	N_Max Wireless Access Point	Model Name :	WAP-6010
Temperature :	13 °C	Relative Humidity :	64%
Test Voltage :	AC 120V/60Hz		
Test Mode :	802.11g/CH06		

Freq. (MHz)	Ant.Pol. H/V	Reading		Ant./CF CF(dB)	Act.		Limit		Note
		Peak (dBuV)	AV (dBuV)		Peak (dBuV/m)	AV (dBuV/m)	Peak (dBuV/m)	AV (dBuV/m)	
2432.40	H	71.30	59.99	32.81	104.11	92.80			X/F
4872.46	H	48.80	36.34	4.28	53.08	40.62	74.00	54.00	X/H

**Remark :**

- (1) Spectrum Setting : 30MHz – 1000MHz , RBW= 100KHz, VBW=100KHz, Sweep time = 200 ms. 1GHz- 25GHz, RBW= 1MHz, VBW= 1MHz, Sweep time = Auto
- (2) All readings are Peak unless otherwise stated AV in column of 『Note』 . Peak denotes that the Peak reading compliance with the AV Limits and then AV Mode measurement didn't perform.
- (3) Measuring frequency range from 30MHz to 1000MHz or the 10th harmonic of highest fundamental frequency. "F" denotes fundamental frequency; "H" denotes spurious frequency. "E" denotes band edge frequency. (This judgment method includes the Band Edge Requirement.)
- (4) Radiated emissions measured in frequency range above 1000MHz were made with an instrument using Peak detector mode and AV detector mode of the emission .
- (5) Data of measurement within this frequency range shown " \* " in the table above means the reading of emissions are attenuated more than 20dB below the permissible limits or the field strength is too small to be measured.
- (6) A preamp and high pass filter were used for this test in order to provide sufficient measurement sensitivity.
- (7) EUT Orthogonal Axes :  
"X" - denotes Laid on Table ; "Y" - denotes Vertical Stand ; "Z" - denotes Side Stand
- (8) During the measurements above 1GHz it is taken care of that the EUT is always within the 3dB cone of radiation BW of the used antenna.



Orthogonal Axis : X  
802.11g/CH06(Above 1000 MHz, Horizontal)

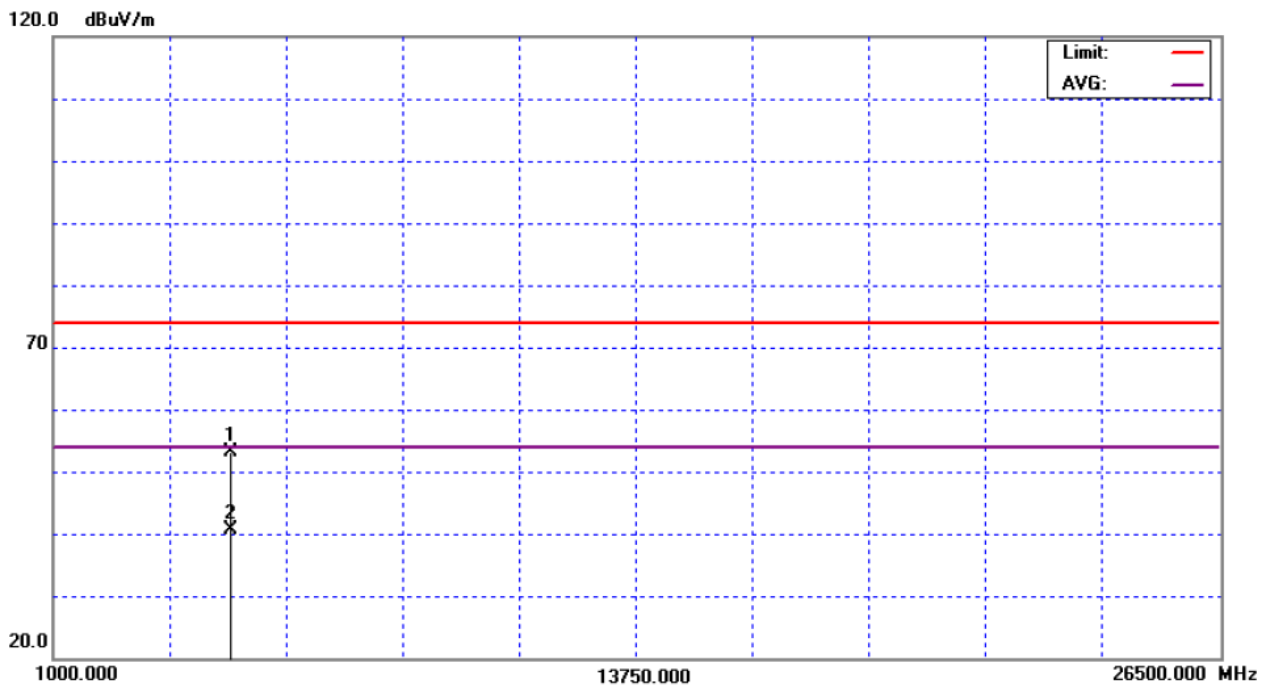
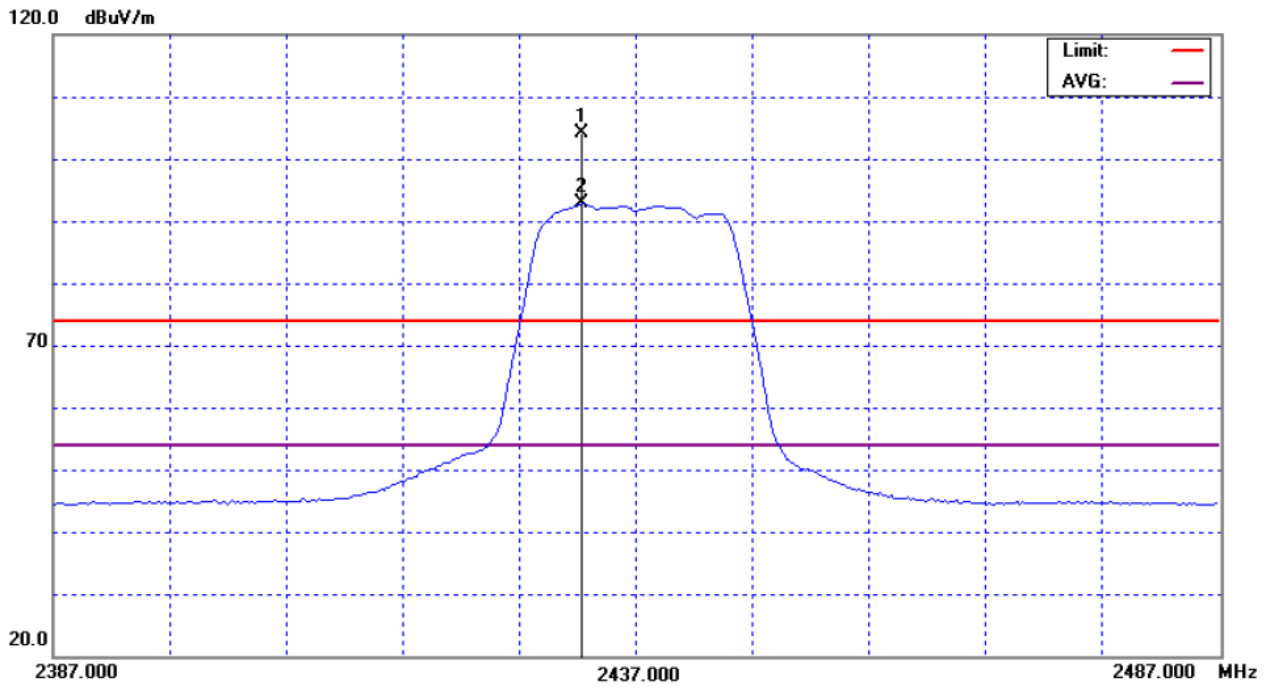



EUT :	N_Max Wireless Access Point	Model Name :	WAP-6010
Temperature :	13 °C	Relative Humidity :	64%
Test Voltage :	AC 120V/60Hz		
Test Mode :	802.11g/CH11		

Freq. (MHz)	Ant.Pol. H/V	Reading		Ant./CF CF(dB)	Act.		Limit		Note
		Peak (dBuV)	AV (dBuV)		Peak (dBuV/m)	AV (dBuV/m)	Peak (dBuV/m)	AV (dBuV/m)	
2463.80	V	77.56	65.88	32.99	110.55	98.87			X/F
2483.50	V	30.09	17.00	33.10	63.19	50.10	74.00	54.00	X/H
4925.44	V	49.91	37.79	4.54	54.45	42.33	74.00	54.00	X/H

**Remark :**

- (1) Spectrum Setting : 30MHz – 1000MHz , RBW= 100KHz, VBW=100KHz, Sweep time = 200 ms. 1GHz- 25GHz, RBW= 1MHz, VBW= 1MHz, Sweep time = Auto
- (2) All readings are Peak unless otherwise stated AV in column of 『Note』 . Peak denotes that the Peak reading compliance with the AV Limits and then AV Mode measurement didn't perform.
- (3) Measuring frequency range from 30MHz to 1000MHz or the 10th harmonic of highest fundamental frequency. "F" denotes fundamental frequency; "H" denotes spurious frequency. "E" denotes band edge frequency. (This judgment method includes the Band Edge Requirement.)
- (4) Radiated emissions measured in frequency range above 1000MHz were made with an instrument using Peak detector mode and AV detector mode of the emission .
- (5) Data of measurement within this frequency range shown " \* " in the table above means the reading of emissions are attenuated more than 20dB below the permissible limits or the field strength is too small to be measured.
- (6) A preamp and high pass filter were used for this test in order to provide sufficient measurement sensitivity.
- (7) EUT Orthogonal Axes :  
"X" - denotes Laid on Table ; "Y" - denotes Vertical Stand ; "Z" - denotes Side Stand
- (8) During the measurements above 1GHz it is taken care of that the EUT is always within the 3dB cone of radiation BW of the used antenna.



Orthogonal Axis : X  
802.11g/CH11(Above 1000 MHz, Vertical)

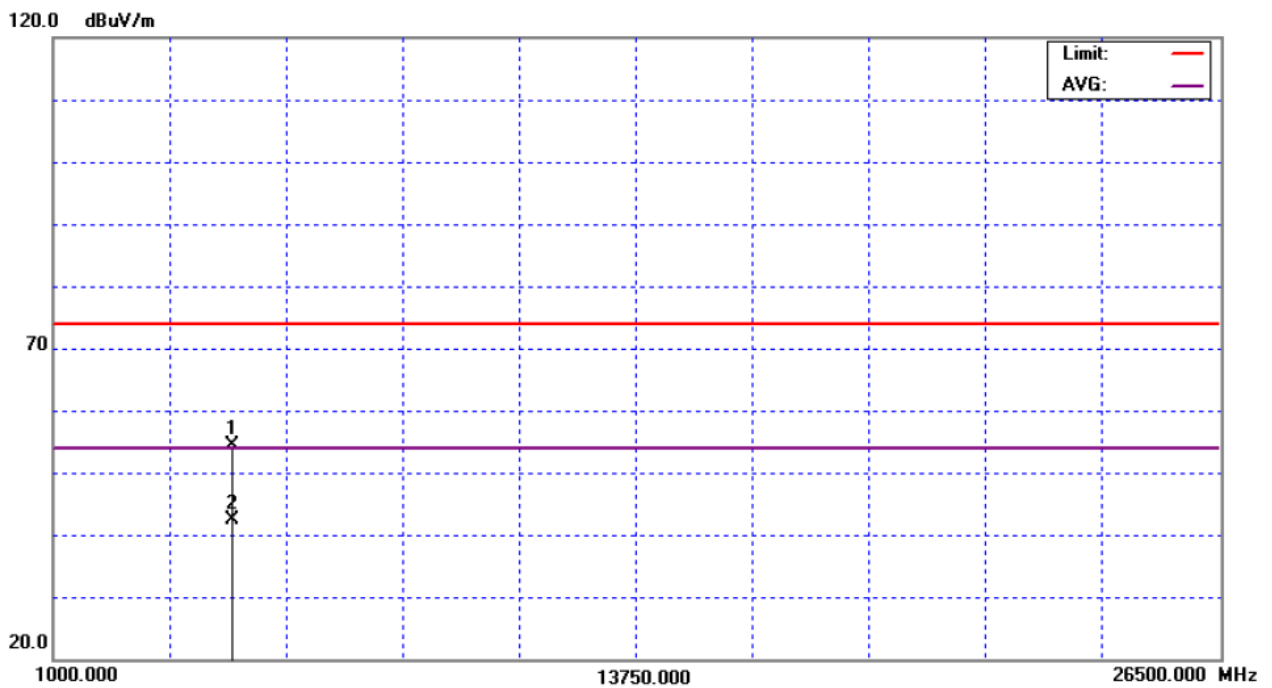
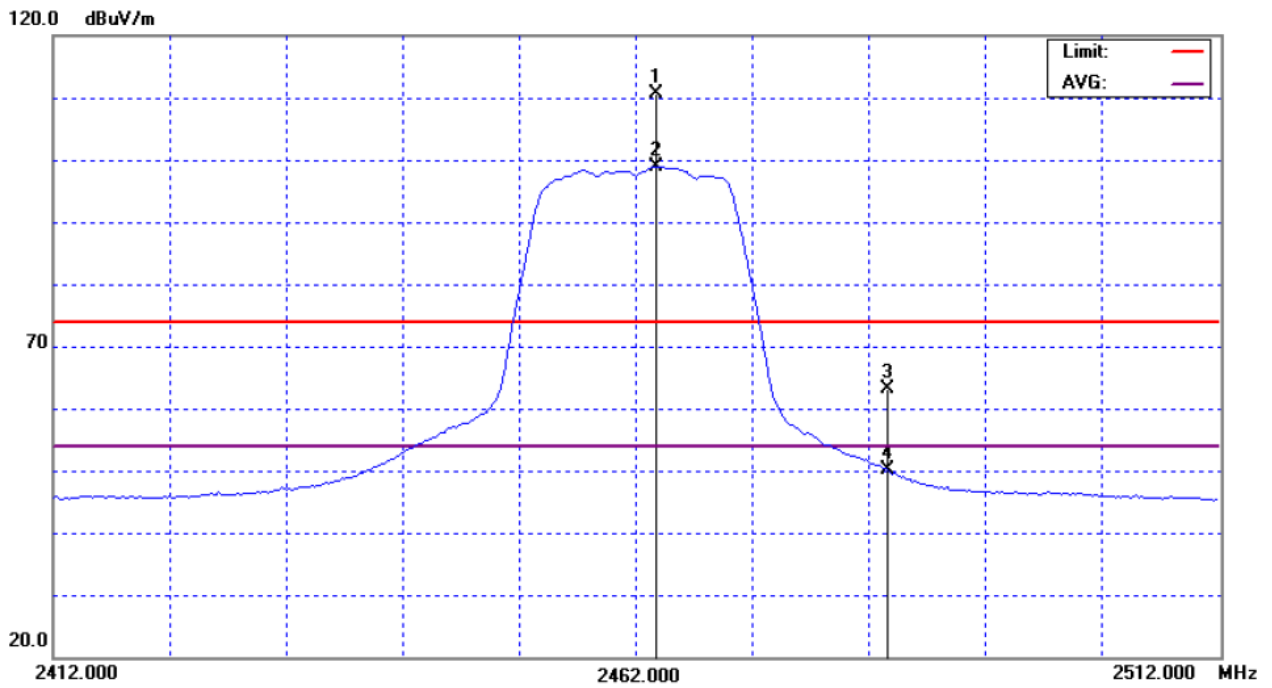



EUT :	N_Max Wireless Access Point	Model Name :	WAP-6010
Temperature :	13 ° C	Relative Humidity :	64%
Test Voltage :	AC 120V/60Hz		
Test Mode :	802.11g/CH11		

Freq. (MHz)	Ant.Pol. H/V	Reading		Ant./CF CF(dB)	Act.		Limit		Note
		Peak (dBuV)	AV (dBuV)		Peak (dBuV/m)	AV (dBuV/m)	Peak (dBuV/m)	AV (dBuV/m)	
2457.60	H	69.77	58.65	32.95	102.72	91.60			X/F
2483.50	H	22.95	13.23	33.10	56.05	46.33	74.00	54.00	X/H
4925.80	H	50.09	37.88	4.54	54.63	42.42	74.00	54.00	X/H

**Remark :**

- (1) Spectrum Setting : 30MHz – 1000MHz , RBW= 100KHz, VBW=100KHz, Sweep time = 200 ms. 1GHz- 25GHz, RBW= 1MHz, VBW= 1MHz, Sweep time = Auto
- (2) All readings are Peak unless otherwise stated AV in column of 『Note』 . Peak denotes that the Peak reading compliance with the AV Limits and then AV Mode measurement didn't perform.
- (3) Measuring frequency range from 30MHz to 1000MHz or the 10th harmonic of highest fundamental frequency. "F" denotes fundamental frequency; "H" denotes spurious frequency. "E" denotes band edge frequency. (This judgment method includes the Band Edge Requirement.)
- (4) Radiated emissions measured in frequency range above 1000MHz were made with an instrument using Peak detector mode and AV detector mode of the emission .
- (5) Data of measurement within this frequency range shown " \* " in the table above means the reading of emissions are attenuated more than 20dB below the permissible limits or the field strength is too small to be measured.
- (6) A preamp and high pass filter were used for this test in order to provide sufficient measurement sensitivity.
- (7) EUT Orthogonal Axes :  
"X" - denotes Laid on Table ; "Y" - denotes Vertical Stand ; "Z" - denotes Side Stand
- (8) During the measurements above 1GHz it is taken care of that the EUT is always within the 3dB cone of radiation BW of the used antenna.



Orthogonal Axis : X  
802.11g/CH11(Above 1000 MHz, Horizontal)

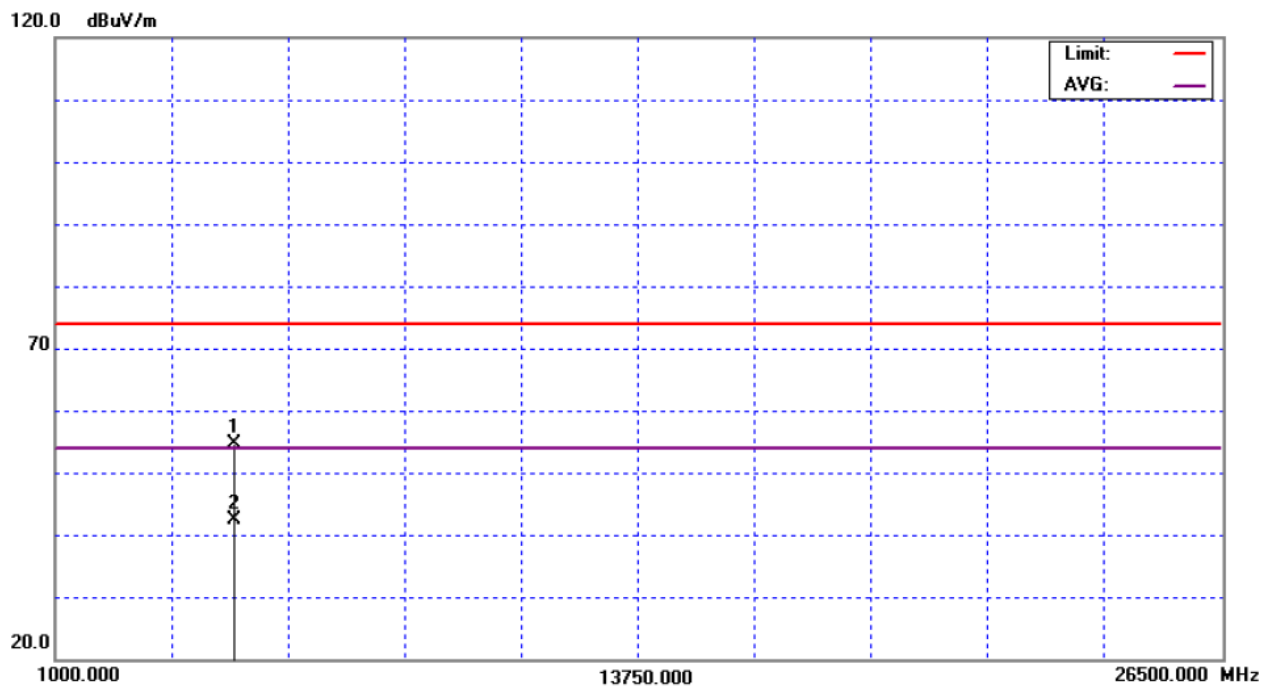
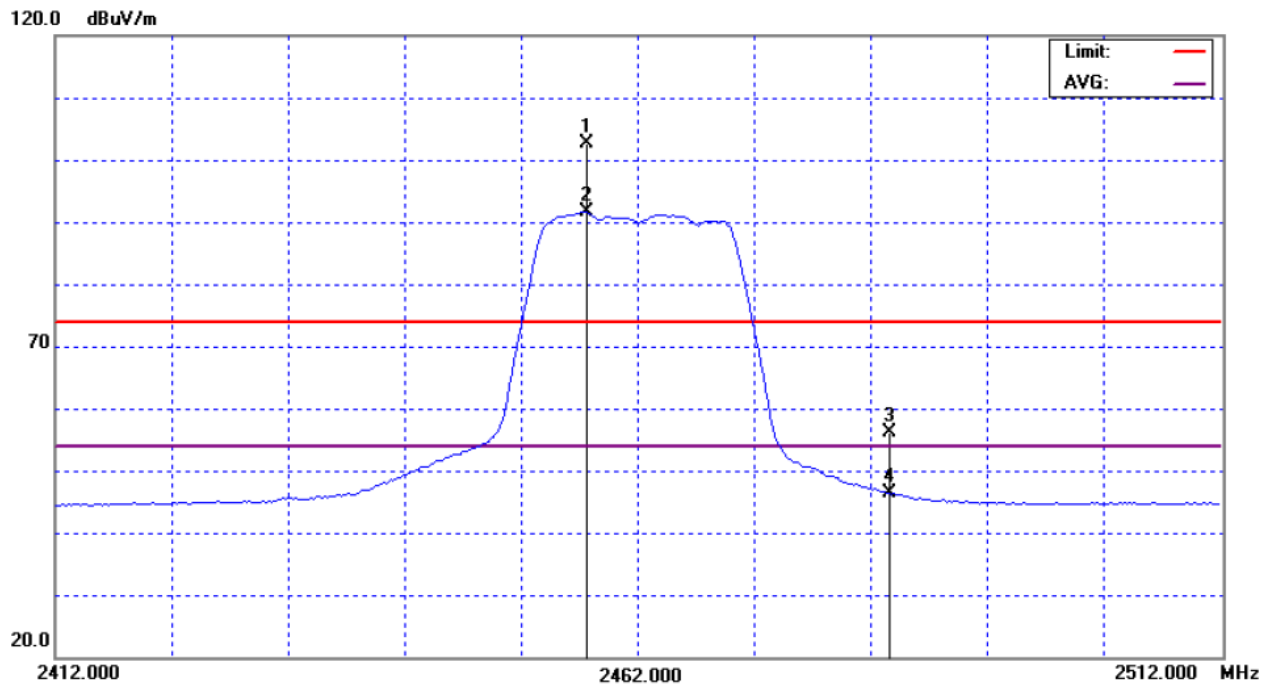



EUT :	N_Max Wireless Access Point	Model Name :	WAP-6010
Temperature :	13 °C	Relative Humidity :	64%
Test Voltage :	AC 120V/60Hz		
Test Mode :	802.11n/20M/CH01(Port. 0 + Port. 1)		

Freq. (MHz)	Ant.Pol. H/V	Reading		Ant./CF CF(dB)	Act.		Limit		Note
		Peak (dBuV)	AV (dBuV)		Peak (dBuV/m)	AV (dBuV/m)	Peak (dBuV/m)	AV (dBuV/m)	
2390.00	V	33.40	20.42	32.57	65.97	52.99	74.00	54.00	X/H
2413.80	V	80.49	70.12	32.71	113.20	102.83			X/F
4823.72	V	52.87	40.20	4.04	56.91	44.24	74.00	54.00	X/H

**Remark :**

- (1) Spectrum Setting : 30MHz – 1000MHz , RBW= 100KHz, VBW=100KHz, Sweep time = 200 ms. 1GHz- 25GHz, RBW= 1MHz, VBW= 1MHz, Sweep time = Auto
- (2) All readings are Peak unless otherwise stated AV in column of 『Note 』 . Peak denotes that the Peak reading compliance with the AV Limits and then AV Mode measurement didn't perform.
- (3) Measuring frequency range from 30MHz to 1000MHz or the 10th harmonic of highest fundamental frequency. "F" denotes fundamental frequency; "H" denotes spurious frequency. "E" denotes band edge frequency. (This judgment method includes the Band Edge Requirement.)
- (4) Radiated emissions measured in frequency range above 1000MHz were made with an instrument using Peak detector mode and AV detector mode of the emission .
- (5) Data of measurement within this frequency range shown " \* " in the table above means the reading of emissions are attenuated more than 20dB below the permissible limits or the field strength is too small to be measured.
- (6) A preamp and high pass filter were used for this test in order to provide sufficient measurement sensitivity.
- (7) EUT Orthogonal Axes :  
"X" - denotes Laid on Table ; "Y" - denotes Vertical Stand ; "Z" - denotes Side Stand
- (8) During the measurements above 1GHz it is taken care of that the EUT is always within the 3dB cone of radiation BW of the used antenna.





Orthogonal Axis : X  
802.11n/20M/CH01(Port 0 + Port 1) (Above 1000 MHz, Vertical)

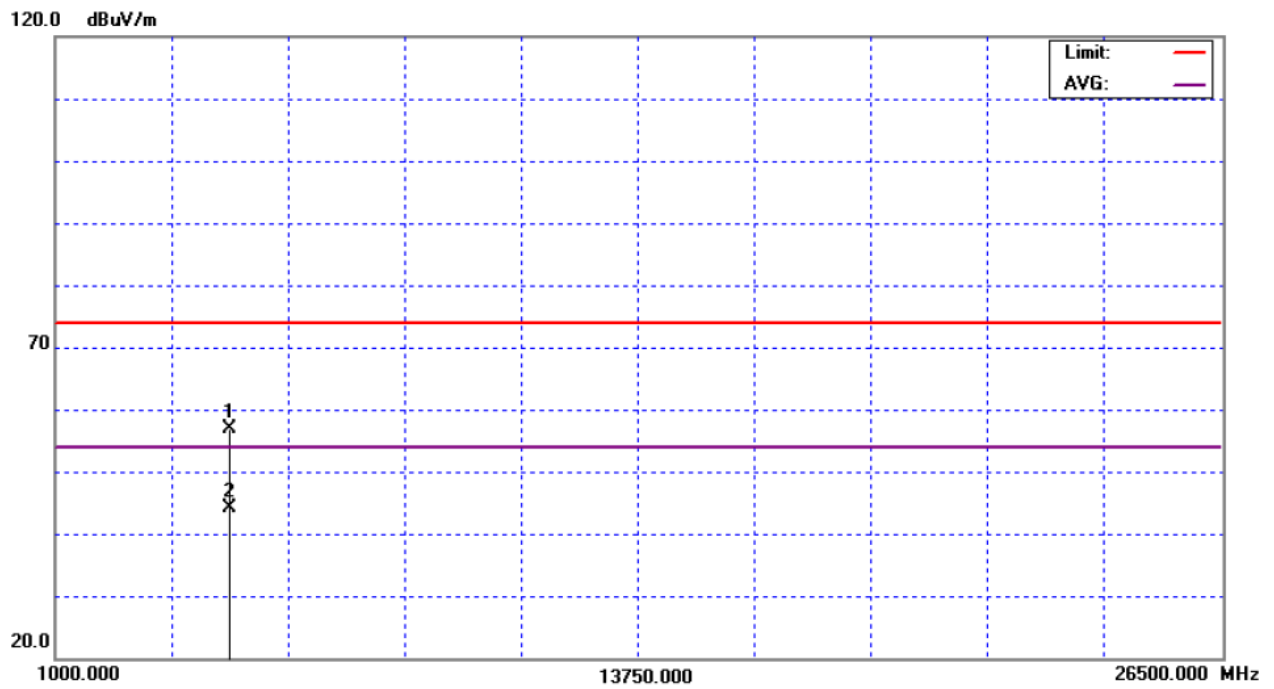
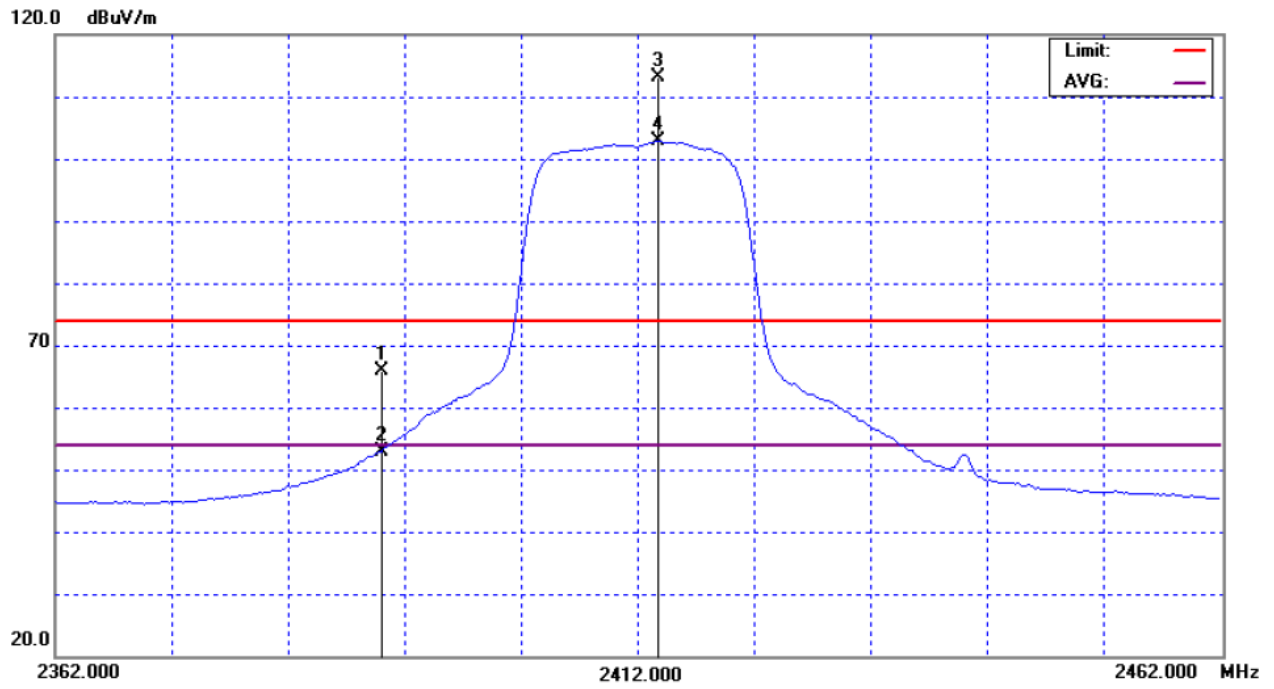



EUT :	N_Max Wireless Access Point	Model Name :	WAP-6010
Temperature :	13 °C	Relative Humidity :	64%
Test Voltage :	AC 120V/60Hz		
Test Mode :	802.11n/20M/CH01(Port. 0 + Port. 1)		

Freq. (MHz)	Ant.Pol. H/V	Reading		Ant./CF CF(dB)	Act.		Limit		Note
		Peak (dBuV)	AV (dBuV)		Peak (dBuV/m)	AV (dBuV/m)	Peak (dBuV/m)	AV (dBuV/m)	
2390.00	H	33.10	19.63	32.57	65.67	52.20	74.00	54.00	X/H
2410.20	H	77.60	67.12	32.69	110.29	99.81			X/F
4823.52	H	52.61	39.39	4.04	56.65	43.43	74.00	54.00	X/H

**Remark :**

- (1) Spectrum Setting : 30MHz – 1000MHz , RBW= 100KHz, VBW=100KHz, Sweep time = 200 ms. 1GHz- 25GHz, RBW= 1MHz, VBW= 1MHz, Sweep time = Auto
- (2) All readings are Peak unless otherwise stated AV in column of 『Note』 . Peak denotes that the Peak reading compliance with the AV Limits and then AV Mode measurement didn't perform.
- (3) Measuring frequency range from 30MHz to 1000MHz or the 10th harmonic of highest fundamental frequency. "F" denotes fundamental frequency; "H" denotes spurious frequency. "E" denotes band edge frequency. (This judgment method includes the Band Edge Requirement.)
- (4) Radiated emissions measured in frequency range above 1000MHz were made with an instrument using Peak detector mode and AV detector mode of the emission .
- (5) Data of measurement within this frequency range shown " \* " in the table above means the reading of emissions are attenuated more than 20dB below the permissible limits or the field strength is too small to be measured.
- (6) A preamp and high pass filter were used for this test in order to provide sufficient measurement sensitivity.
- (7) EUT Orthogonal Axes :  
"X" - denotes Laid on Table ; "Y" - denotes Vertical Stand ; "Z" - denotes Side Stand
- (8) During the measurements above 1GHz it is taken care of that the EUT is always within the 3dB cone of radiation BW of the used antenna.



Orthogonal Axis : X

802.11n/20M/CH01(Port 0 + Port 1) (Above 1000 MHz, Horizontal)

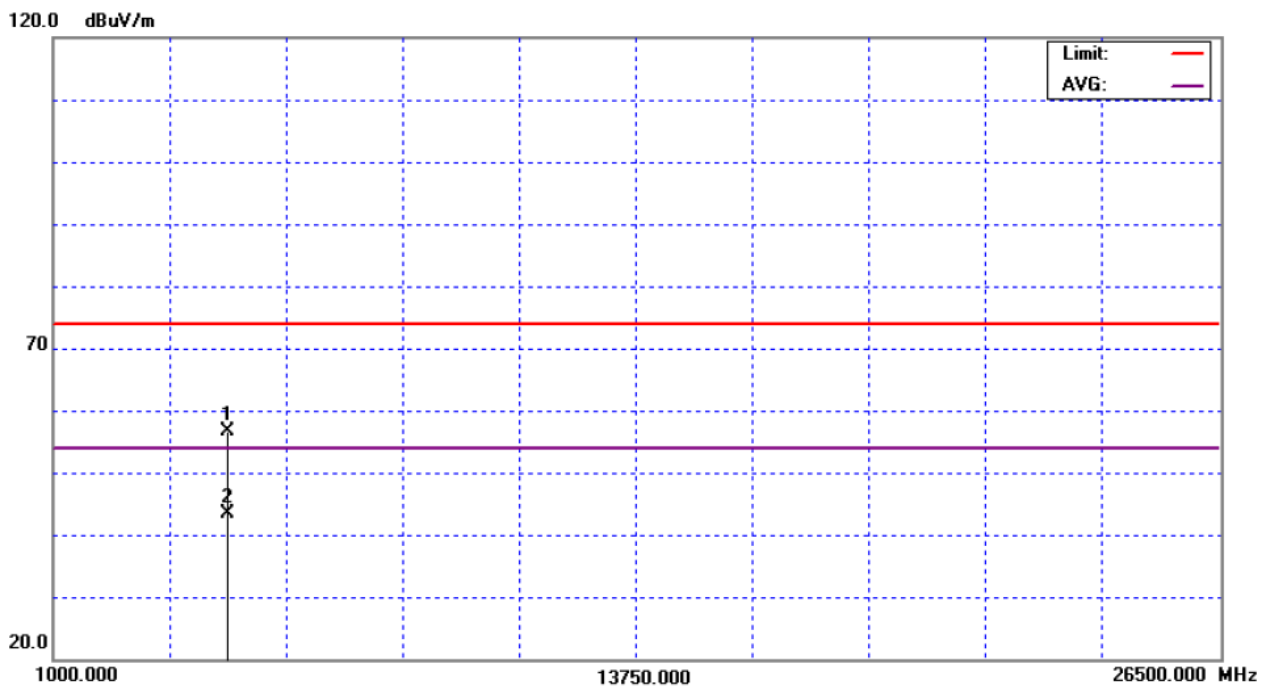
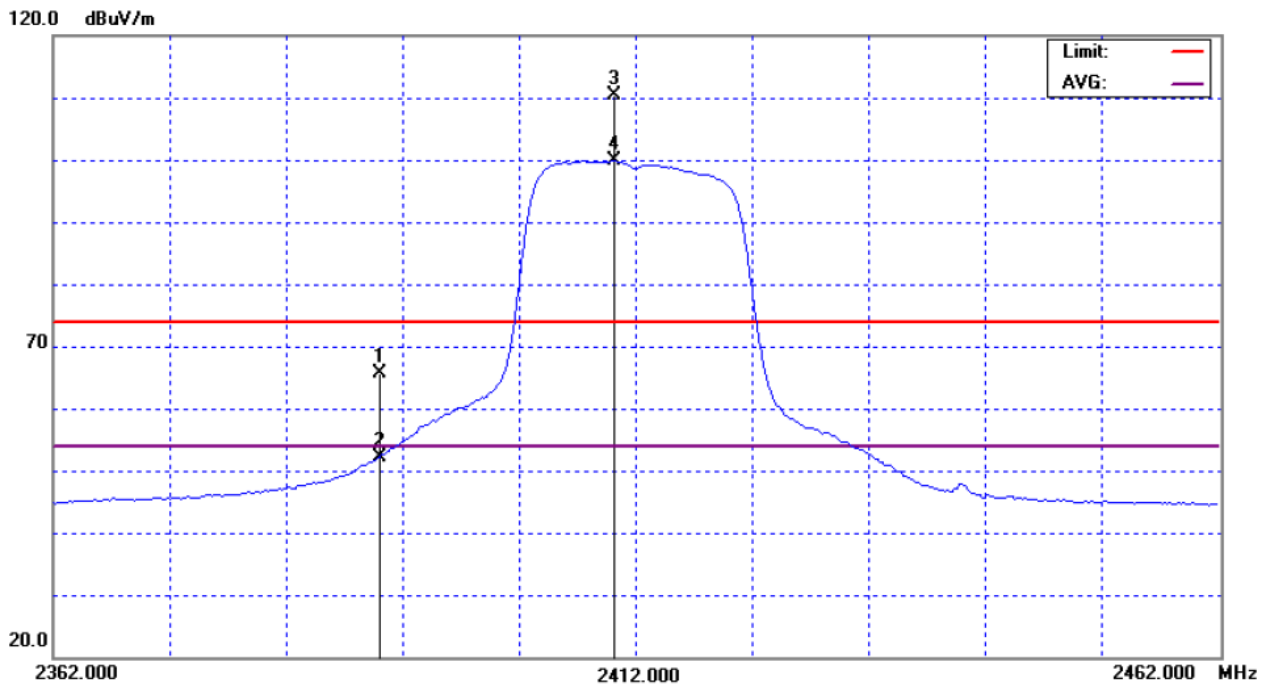



EUT :	N_Max Wireless Access Point	Model Name :	WAP-6010
Temperature :	13 °C	Relative Humidity :	64%
Test Voltage :	AC 120V/60Hz		
Test Mode :	802.11n/20M/CH06 (Port. 0 + Port. 1)		

Freq. (MHz)	Ant.Pol. H/V	Reading		Ant./CF CF(dB)	Act.		Limit		Note
		Peak (dBuV)	AV (dBuV)		Peak (dBuV/m)	AV (dBuV/m)	Peak (dBuV/m)	AV (dBuV/m)	
2439.20	V	81.64	71.67	32.85	114.49	104.52			X/F
4876.84	V	53.64	41.46	4.30	57.94	45.76	74.00	54.00	X/H

**Remark :**

- (1) Spectrum Setting : 30MHz – 1000MHz , RBW= 100KHz, VBW=100KHz, Sweep time = 200 ms. 1GHz- 25GHz, RBW= 1MHz, VBW= 1MHz, Sweep time = Auto
- (2) All readings are Peak unless otherwise stated AV in column of 『Note 』 . Peak denotes that the Peak reading compliance with the AV Limits and then AV Mode measurement didn't perform.
- (3) Measuring frequency range from 30MHz to 1000MHz or the 10th harmonic of highest fundamental frequency. "F" denotes fundamental frequency; "H" denotes spurious frequency. "E" denotes band edge frequency. (This judgment method includes the Band Edge Requirement.)
- (4) Radiated emissions measured in frequency range above 1000MHz were made with an instrument using Peak detector mode and AV detector mode of the emission .
- (5) Data of measurement within this frequency range shown " \* " in the table above means the reading of emissions are attenuated more than 20dB below the permissible limits or the field strength is too small to be measured.
- (6) A preamp and high pass filter were used for this test in order to provide sufficient measurement sensitivity.
- (7) EUT Orthogonal Axes :  
"X" - denotes Laid on Table ; "Y" - denotes Vertical Stand ; "Z" - denotes Side Stand
- (8) During the measurements above 1GHz it is taken care of that the EUT is always within the 3dB cone of radiation BW of the used antenna.



Orthogonal Axis : X  
802.11n/20M/CH06(Port 0 + Port 1) (Above 1000 MHz, Vertical)

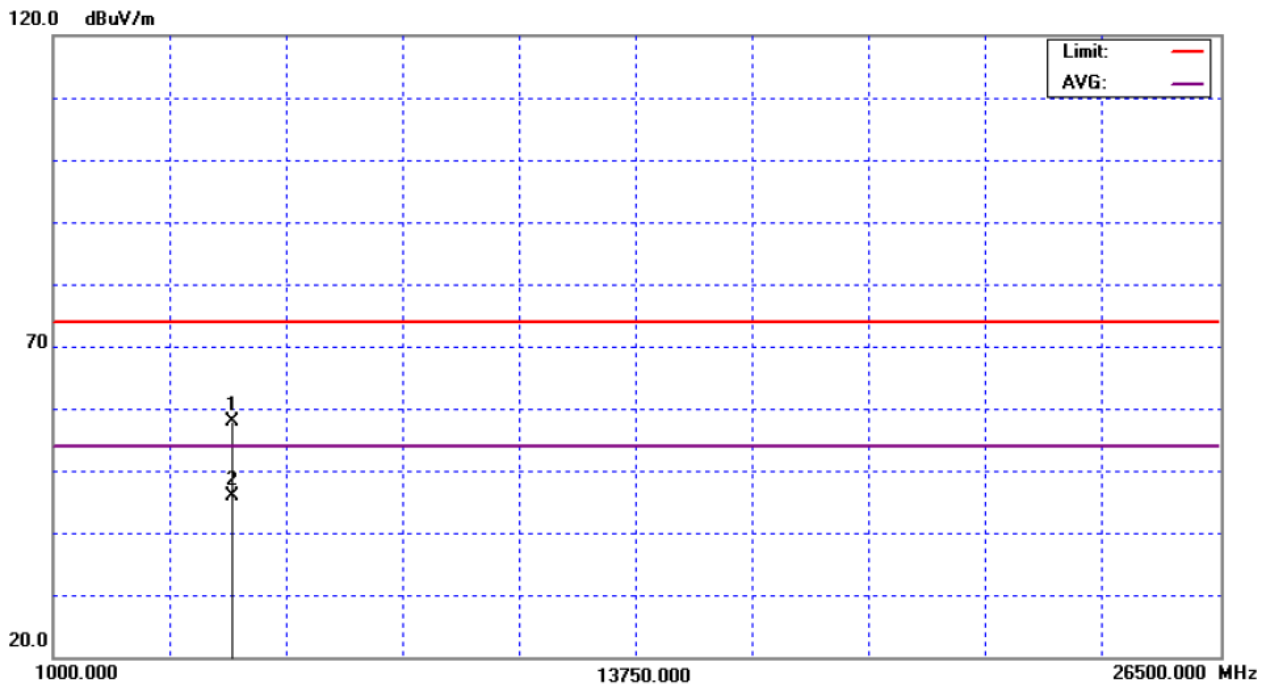
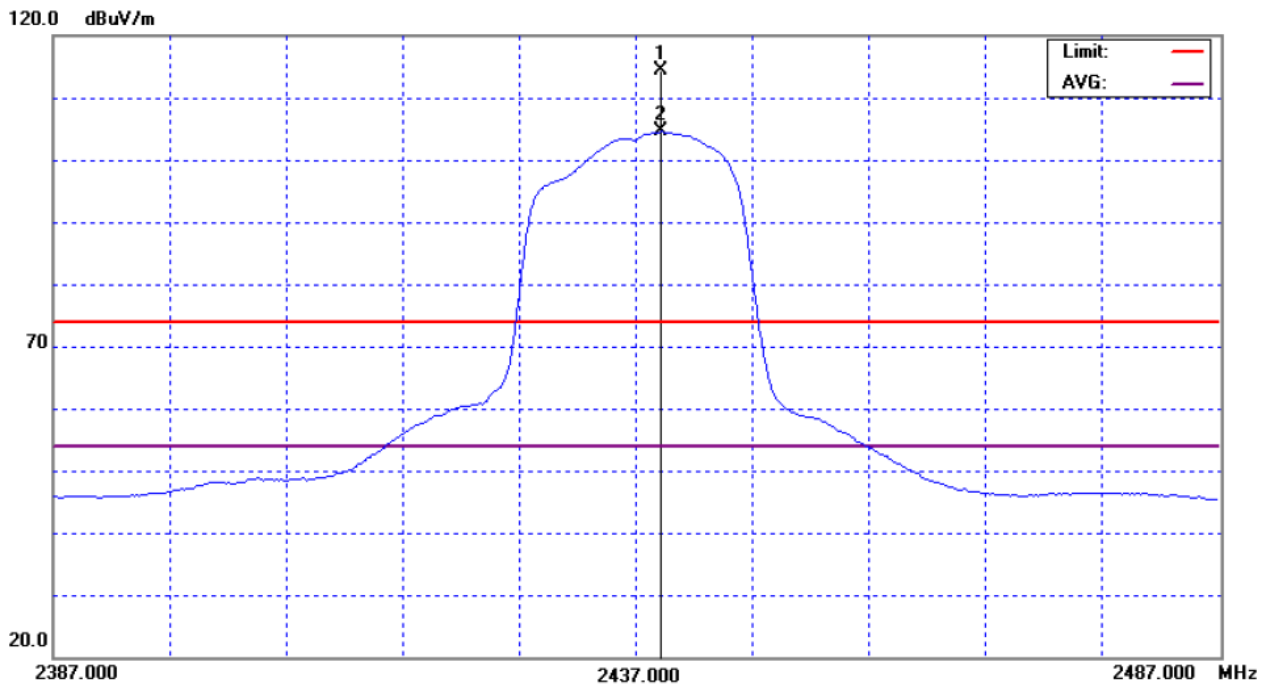



EUT :	N_Max Wireless Access Point	Model Name :	WAP-6010
Temperature :	13 °C	Relative Humidity :	64%
Test Voltage :	AC 120V/60Hz		
Test Mode :	802.11n/20M/CH06(Port. 0 + Port. 1)		

Freq. (MHz)	Ant.Pol. H/V	Reading		Ant./CF CF(dB)	Act.		Limit		Note
		Peak (dBuV)	AV (dBuV)		Peak (dBuV/m)	AV (dBuV/m)	Peak (dBuV/m)	AV (dBuV/m)	
2443.80	H	74.43	63.83	32.88	107.31	96.71			X/F
4871.00	H	52.50	40.83	4.28	56.78	45.11	74.00	54.00	X/H

**Remark :**

- (1) Spectrum Setting : 30MHz – 1000MHz , RBW= 100KHz, VBW=100KHz, Sweep time = 200 ms. 1GHz- 25GHz, RBW= 1MHz, VBW= 1MHz, Sweep time = Auto
- (2) All readings are Peak unless otherwise stated AV in column of 『Note』 . Peak denotes that the Peak reading compliance with the AV Limits and then AV Mode measurement didn't perform.
- (3) Measuring frequency range from 30MHz to 1000MHz or the 10th harmonic of highest fundamental frequency. "F" denotes fundamental frequency; "H" denotes spurious frequency. "E" denotes band edge frequency. (This judgment method includes the Band Edge Requirement.)
- (4) Radiated emissions measured in frequency range above 1000MHz were made with an instrument using Peak detector mode and AV detector mode of the emission .
- (5) Data of measurement within this frequency range shown " \* " in the table above means the reading of emissions are attenuated more than 20dB below the permissible limits or the field strength is too small to be measured.
- (6) A preamp and high pass filter were used for this test in order to provide sufficient measurement sensitivity.
- (7) EUT Orthogonal Axes :  
"X" - denotes Laid on Table ; "Y" - denotes Vertical Stand ; "Z" - denotes Side Stand
- (8) During the measurements above 1GHz it is taken care of that the EUT is always within the 3dB cone of radiation BW of the used antenna.



Orthogonal Axis : X

802.11n/20M/CH06(Port 0 + Port 1) (Above 1000 MHz, Horizontal)

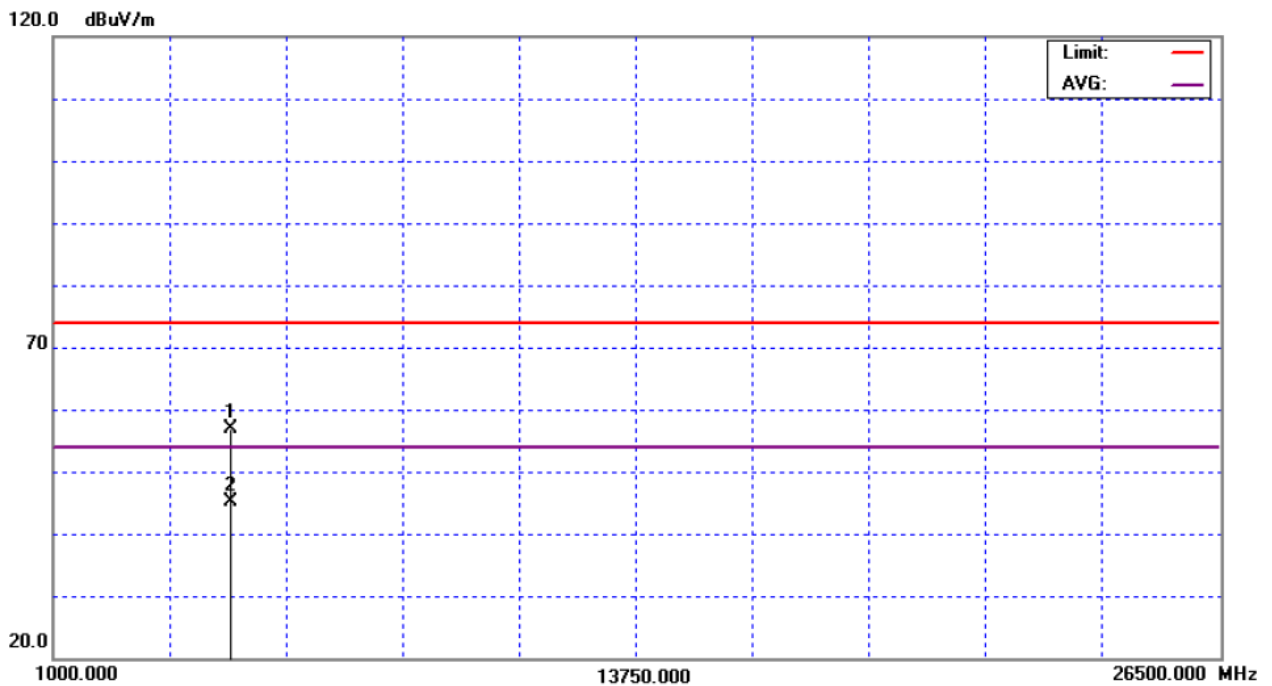
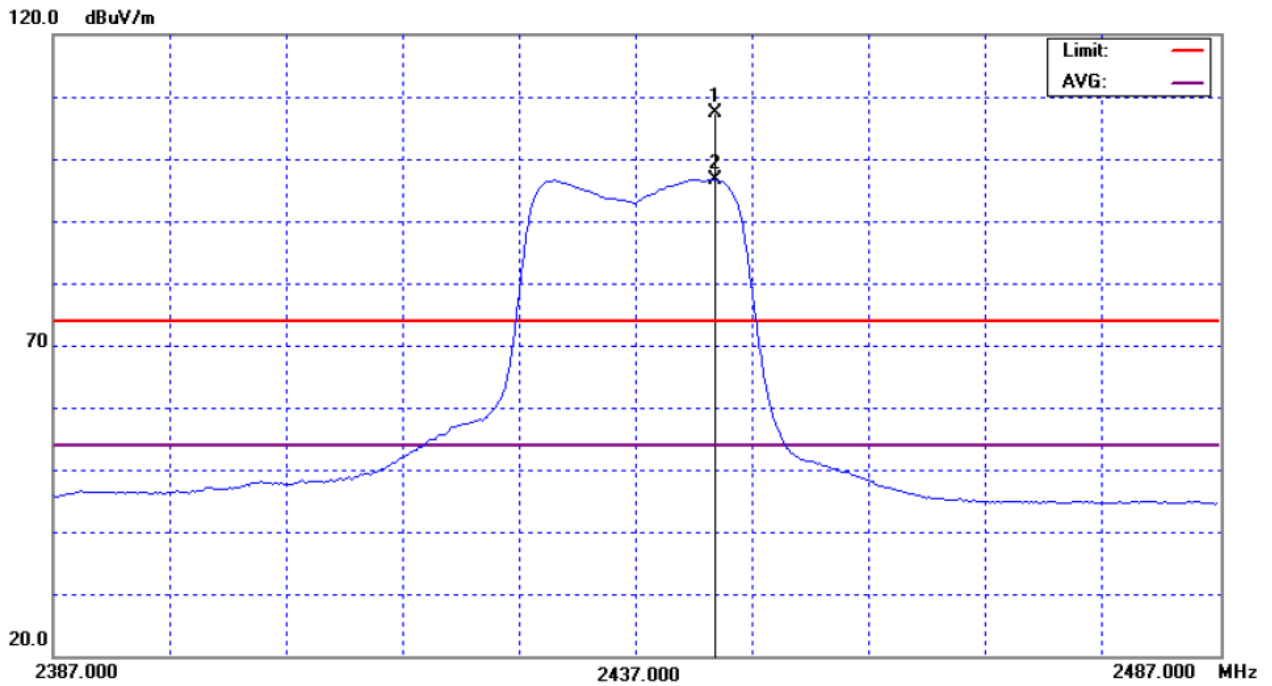



EUT :	N_Max Wireless Access Point	Model Name :	WAP-6010
Temperature :	13 °C	Relative Humidity :	64%
Test Voltage :	AC 120V/60Hz		
Test Mode :	802.11n/20M/CH11(Port. 0 + Port. 1)		

Freq. (MHz)	Ant.Pol. H/V	Reading		Ant./CF CF(dB)	Act.		Limit		Note
		Peak (dBuV)	AV (dBuV)		Peak (dBuV/m)	AV (dBuV/m)	Peak (dBuV/m)	AV (dBuV/m)	
2465.40	V	79.31	68.71	33.00	112.31	101.71			X/F
2483.50	V	32.82	17.19	33.10	65.92	50.29	74.00	54.00	X/H
4926.84	V	50.57	39.36	4.55	55.12	43.91	74.00	54.00	X/H

**Remark :**

- (1) Spectrum Setting : 30MHz – 1000MHz , RBW= 100KHz, VBW=100KHz, Sweep time = 200 ms. 1GHz- 25GHz, RBW= 1MHz, VBW= 1MHz, Sweep time = Auto
- (2) All readings are Peak unless otherwise stated AV in column of 『Note』 . Peak denotes that the Peak reading compliance with the AV Limits and then AV Mode measurement didn't perform.
- (3) Measuring frequency range from 30MHz to 1000MHz or the 10th harmonic of highest fundamental frequency. "F" denotes fundamental frequency; "H" denotes spurious frequency. "E" denotes band edge frequency. (This judgment method includes the Band Edge Requirement.)
- (4) Radiated emissions measured in frequency range above 1000MHz were made with an instrument using Peak detector mode and AV detector mode of the emission .
- (5) Data of measurement within this frequency range shown " \* " in the table above means the reading of emissions are attenuated more than 20dB below the permissible limits or the field strength is too small to be measured.
- (6) A preamp and high pass filter were used for this test in order to provide sufficient measurement sensitivity.
- (7) EUT Orthogonal Axes :  
"X" - denotes Laid on Table ; "Y" - denotes Vertical Stand ; "Z" - denotes Side Stand
- (8) During the measurements above 1GHz it is taken care of that the EUT is always within the 3dB cone of radiation BW of the used antenna.





Orthogonal Axis : X  
802.11n/20M/CH11(Port 0 + Port 1) (Above 1000 MHz, Vertical)

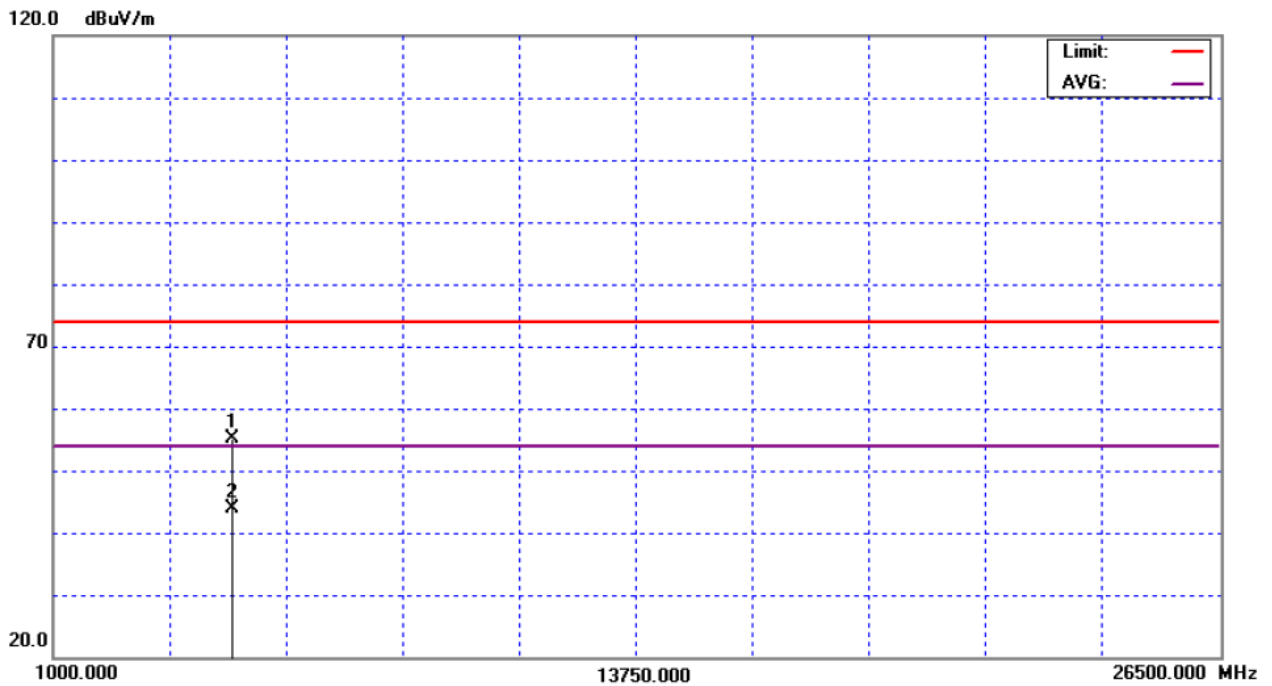
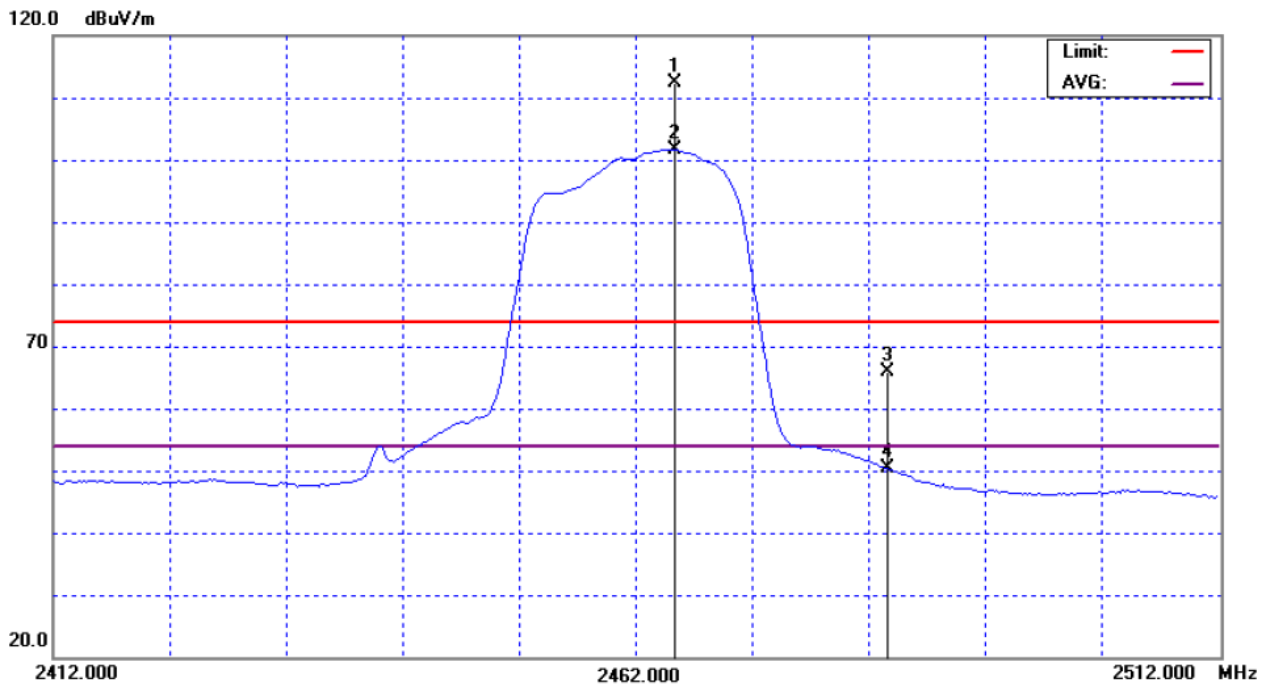



EUT :	N_Max Wireless Access Point	Model Name :	WAP-6010
Temperature :	13 ° C	Relative Humidity :	64%
Test Voltage :	AC 120V/60Hz		
Test Mode :	802.11n/20M/CH11 (Port. 0 + Port. 1)		

Freq. (MHz)	Ant.Pol. H/V	Reading		Ant./CF CF(dB)	Act.		Limit		Note
		Peak (dBuV)	AV (dBuV)		Peak (dBuV/m)	AV (dBuV/m)	Peak (dBuV/m)	AV (dBuV/m)	
2465.40	H	73.69	63.47	33.00	106.69	96.47			X/F
2483.50	H	28.32	13.88	33.10	61.42	46.98	74.00	54.00	X/H
4921.80	H	50.65	38.90	4.52	55.17	43.42	74.00	54.00	X/H

**Remark :**

- (1) Spectrum Setting : 30MHz – 1000MHz , RBW= 100KHz, VBW=100KHz, Sweep time = 200 ms. 1GHz- 25GHz, RBW= 1MHz, VBW= 1MHz, Sweep time = Auto
- (2) All readings are Peak unless otherwise stated AV in column of 『Note』 . Peak denotes that the Peak reading compliance with the AV Limits and then AV Mode measurement didn't perform.
- (3) Measuring frequency range from 30MHz to 1000MHz or the 10th harmonic of highest fundamental frequency. "F" denotes fundamental frequency; "H" denotes spurious frequency. "E" denotes band edge frequency. (This judgment method includes the Band Edge Requirement.)
- (4) Radiated emissions measured in frequency range above 1000MHz were made with an instrument using Peak detector mode and AV detector mode of the emission .
- (5) Data of measurement within this frequency range shown " \* " in the table above means the reading of emissions are attenuated more than 20dB below the permissible limits or the field strength is too small to be measured.
- (6) A preamp and high pass filter were used for this test in order to provide sufficient measurement sensitivity.
- (7) EUT Orthogonal Axes :  
"X" - denotes Laid on Table ; "Y" - denotes Vertical Stand ; "Z" - denotes Side Stand
- (8) During the measurements above 1GHz it is taken care of that the EUT is always within the 3dB cone of radiation BW of the used antenna.



Orthogonal Axis : X

802.11n/20M/CH11(Port 0 + Port 1) (Above 1000 MHz, Horizontal)

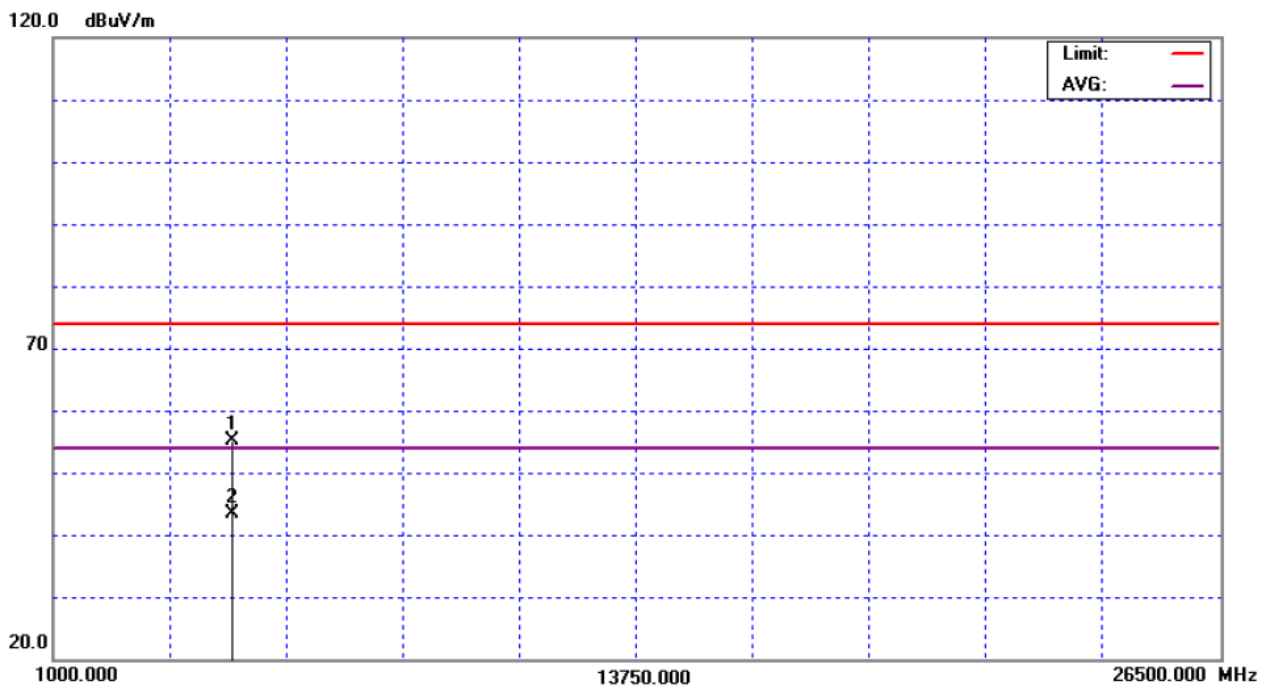
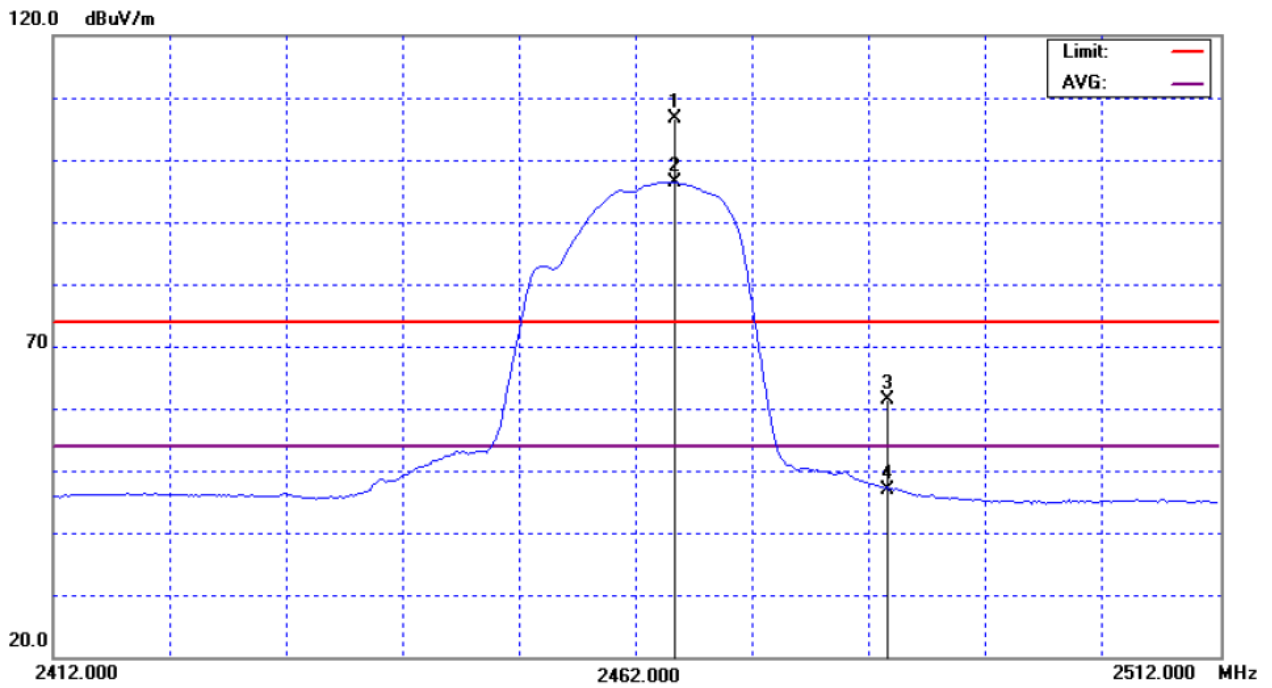



EUT :	N_Max Wireless Access Point	Model Name :	WAP-6010
Temperature :	13 °C	Relative Humidity :	64%
Test Voltage :	AC 120V/60Hz		
Test Mode :	802.11n/40M/CH03 (Port. 0 + Port. 1)		

Freq. (MHz)	Ant.Pol. H/V	Reading		Ant./CF CF(dB)	Act.		Limit		Note
		Peak (dBuV)	AV (dBuV)		Peak (dBuV/m)	AV (dBuV/m)	Peak (dBuV/m)	AV (dBuV/m)	
2390.00	V	33.47	20.65	32.57	66.04	53.22	74.00	54.00	X/H
2415.60	V	75.64	64.42	32.72	108.36	97.14			X/F
4841.72	V	48.08	35.09	4.13	52.21	39.22	74.00	54.00	X/H

**Remark :**

- (1) Spectrum Setting : 30MHz – 1000MHz , RBW= 100KHz, VBW=100KHz, Sweep time = 200 ms. 1GHz- 25GHz, RBW= 1MHz, VBW= 1MHz, Sweep time = Auto
- (2) All readings are Peak unless otherwise stated AV in column of 『Note』 . Peak denotes that the Peak reading compliance with the AV Limits and then AV Mode measurement didn't perform.
- (3) Measuring frequency range from 30MHz to 1000MHz or the 10th harmonic of highest fundamental frequency. "F" denotes fundamental frequency; "H" denotes spurious frequency. "E" denotes band edge frequency. (This judgment method includes the Band Edge Requirement.)
- (4) Radiated emissions measured in frequency range above 1000MHz were made with an instrument using Peak detector mode and AV detector mode of the emission .
- (5) Data of measurement within this frequency range shown " \* " in the table above means the reading of emissions are attenuated more than 20dB below the permissible limits or the field strength is too small to be measured.
- (6) A preamp and high pass filter were used for this test in order to provide sufficient measurement sensitivity.
- (7) EUT Orthogonal Axes :  
"X" - denotes Laid on Table ; "Y" - denotes Vertical Stand ; "Z" - denotes Side Stand
- (8) During the measurements above 1GHz it is taken care of that the EUT is always within the 3dB cone of radiation BW of the used antenna.



Orthogonal Axis : X  
802.11n/40M/CH03(Port 0 + Port 1) (Above 1000 MHz, Vertical)

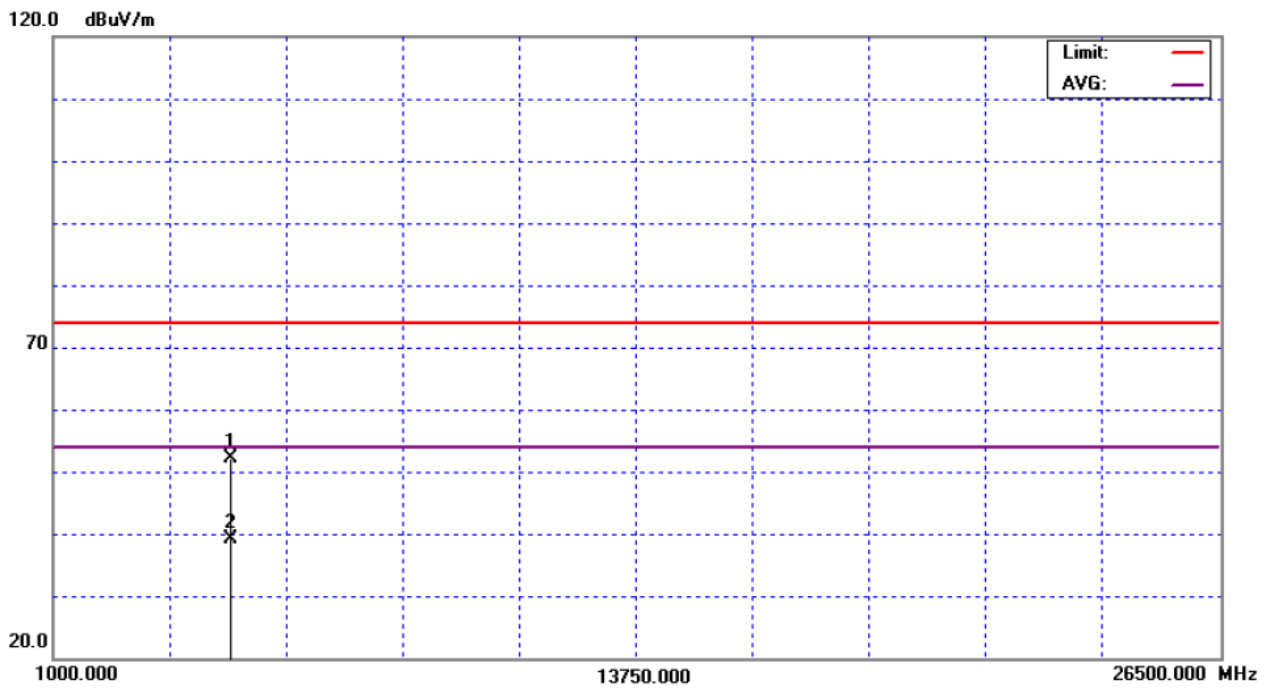
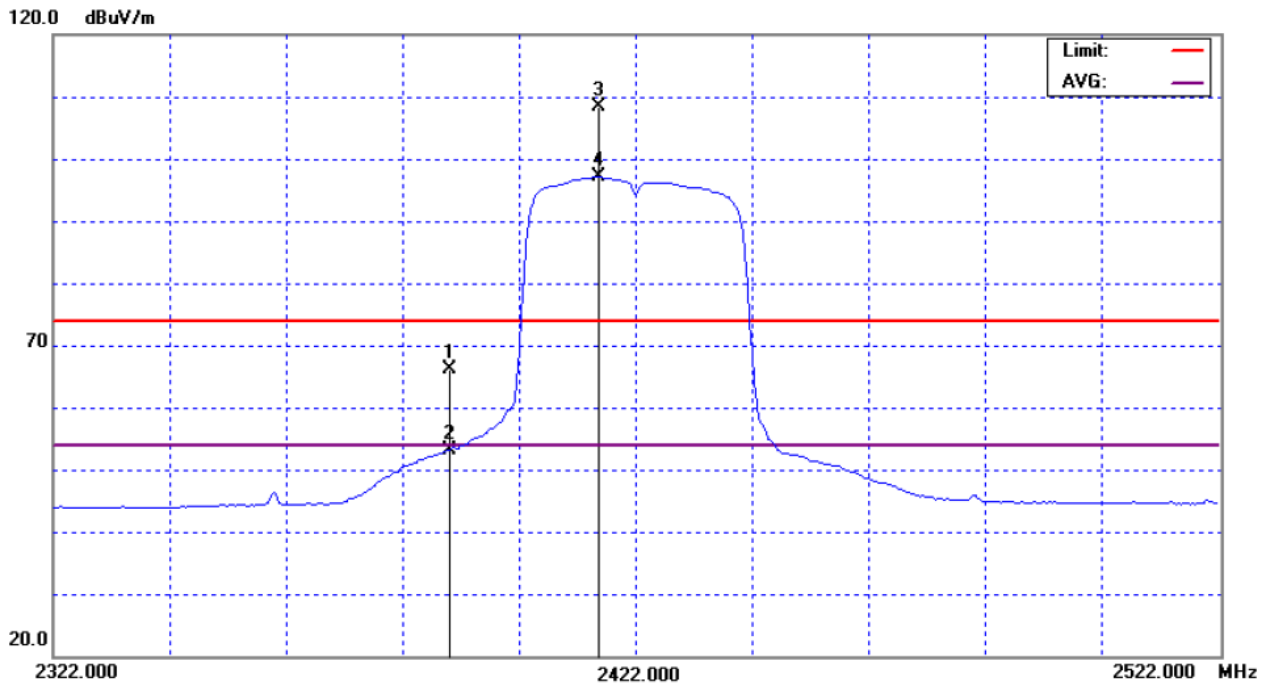



EUT :	N_Max Wireless Access Point	Model Name :	WAP-6010
Temperature :	13 °C	Relative Humidity :	64%
Test Voltage :	AC 120V/60Hz		
Test Mode :	802.11n/40M/CH03 (Port. 0 + Port. 1)		

Freq. (MHz)	Ant.Pol. H/V	Reading		Ant./CF CF(dB)	Act.		Limit		Note
		Peak (dBuV)	AV (dBuV)		Peak (dBuV/m)	AV (dBuV/m)	Peak (dBuV/m)	AV (dBuV/m)	
2390.00	H	32.29	20.82	32.57	64.86	53.39	74.00	54.00	X/H
2411.60	H	71.63	61.06	32.69	104.32	93.75			X/F
4839.40	H	49.10	35.88	4.12	53.22	40.00	74.00	54.00	X/H

**Remark :**

- (1) Spectrum Setting : 30MHz – 1000MHz , RBW= 100KHz, VBW=100KHz, Sweep time = 200 ms. 1GHz- 25GHz, RBW= 1MHz, VBW= 1MHz, Sweep time = Auto
- (2) All readings are Peak unless otherwise stated AV in column of 『Note』 . Peak denotes that the Peak reading compliance with the AV Limits and then AV Mode measurement didn't perform.
- (3) Measuring frequency range from 30MHz to 1000MHz or the 10th harmonic of highest fundamental frequency. "F" denotes fundamental frequency; "H" denotes spurious frequency. "E" denotes band edge frequency. (This judgment method includes the Band Edge Requirement.)
- (4) Radiated emissions measured in frequency range above 1000MHz were made with an instrument using Peak detector mode and AV detector mode of the emission .
- (5) Data of measurement within this frequency range shown " \* " in the table above means the reading of emissions are attenuated more than 20dB below the permissible limits or the field strength is too small to be measured.
- (6) A preamp and high pass filter were used for this test in order to provide sufficient measurement sensitivity.
- (7) EUT Orthogonal Axes :  
"X" - denotes Laid on Table ; "Y" - denotes Vertical Stand ; "Z" - denotes Side Stand
- (8) During the measurements above 1GHz it is taken care of that the EUT is always within the 3dB cone of radiation BW of the used antenna.



Orthogonal Axis : X

802.11n/40M/CH03(Port 0 + Port 1) (Above 1000 MHz, Horizontal)

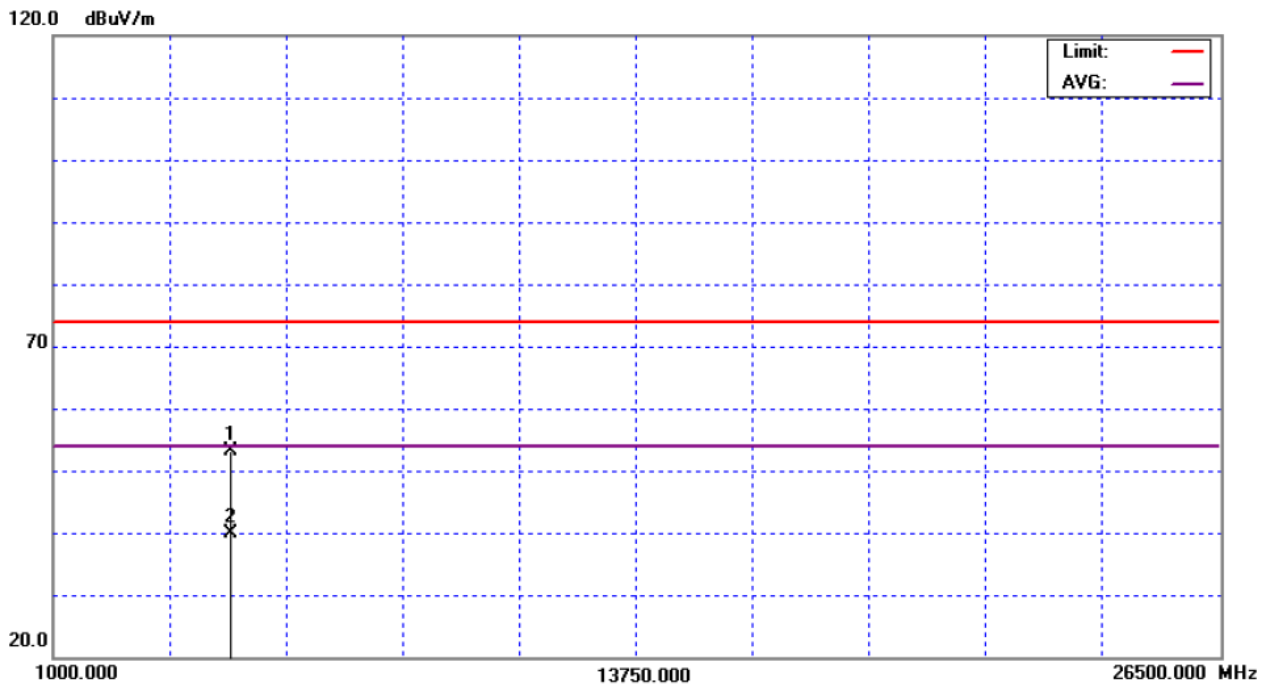
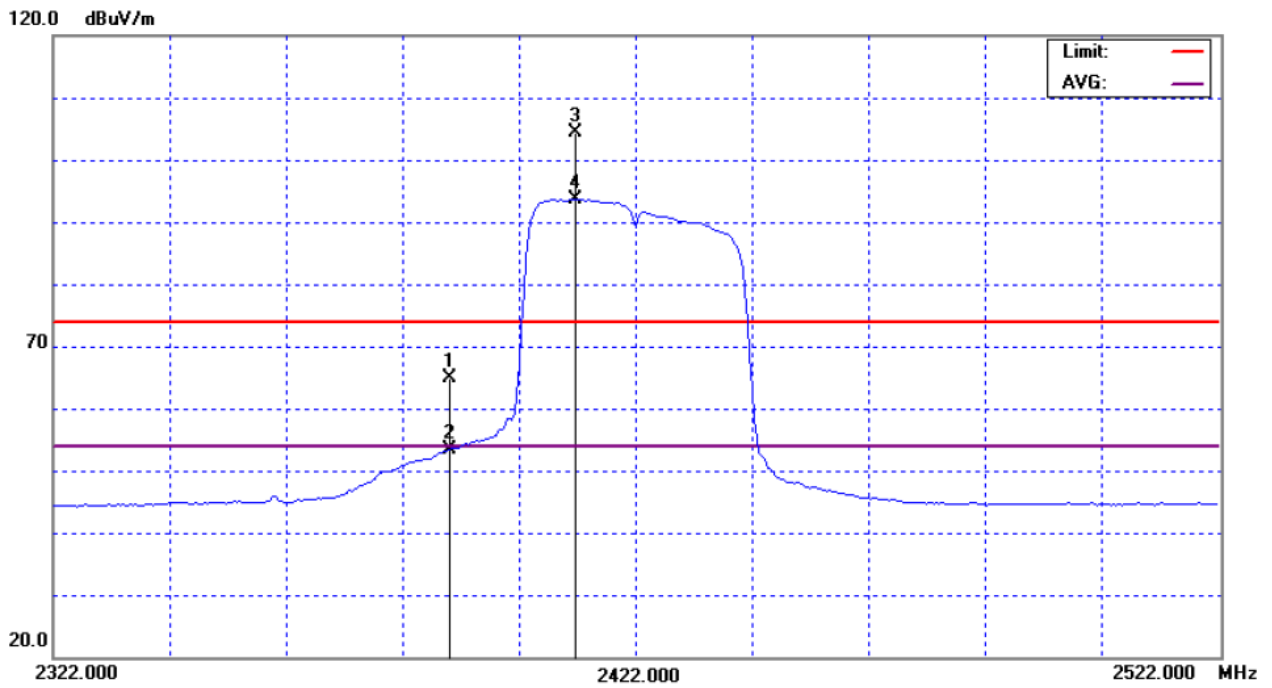



EUT :	N_Max Wireless Access Point	Model Name :	WAP-6010
Temperature :	13 °C	Relative Humidity :	64%
Test Voltage :	AC 120V/60Hz		
Test Mode :	802.11n/40M/CH06 (Port. 0 + Port. 1)		

Freq. (MHz)	Ant.Pol. H/V	Reading		Ant./CF CF(dB)	Act.		Limit		Note
		Peak (dBuV)	AV (dBuV)		Peak (dBuV/m)	AV (dBuV/m)	Peak (dBuV/m)	AV (dBuV/m)	
2432.60	V	76.50	65.95	32.81	109.31	98.76			X/F
4867.10	V	48.61	36.11	4.26	52.87	40.37	74.00	54.00	X/H

**Remark :**

- (1) Spectrum Setting : 30MHz – 1000MHz , RBW= 100KHz, VBW=100KHz, Sweep time = 200 ms. 1GHz- 25GHz, RBW= 1MHz, VBW= 1MHz, Sweep time = Auto
- (2) All readings are Peak unless otherwise stated AV in column of 『Note』 . Peak denotes that the Peak reading compliance with the AV Limits and then AV Mode measurement didn't perform.
- (3) Measuring frequency range from 30MHz to 1000MHz or the 10th harmonic of highest fundamental frequency. "F" denotes fundamental frequency; "H" denotes spurious frequency. "E" denotes band edge frequency. (This judgment method includes the Band Edge Requirement.)
- (4) Radiated emissions measured in frequency range above 1000MHz were made with an instrument using Peak detector mode and AV detector mode of the emission .
- (5) Data of measurement within this frequency range shown " \* " in the table above means the reading of emissions are attenuated more than 20dB below the permissible limits or the field strength is too small to be measured.
- (6) A preamp and high pass filter were used for this test in order to provide sufficient measurement sensitivity.
- (7) EUT Orthogonal Axes :  
"X" - denotes Laid on Table ; "Y" - denotes Vertical Stand ; "Z" - denotes Side Stand
- (8) During the measurements above 1GHz it is taken care of that the EUT is always within the 3dB cone of radiation BW of the used antenna.





Orthogonal Axis : X

802.11n/40M/CH06(Port 0 + Port 1) (Above 1000 MHz, Vertical)

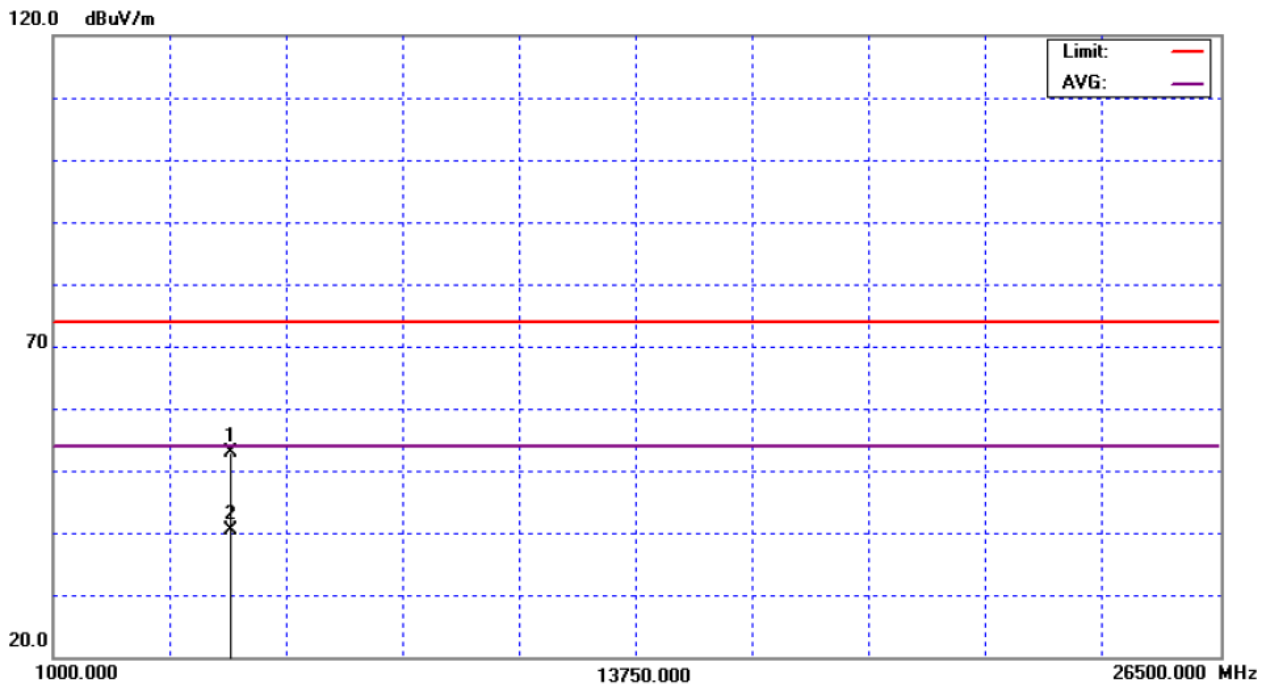
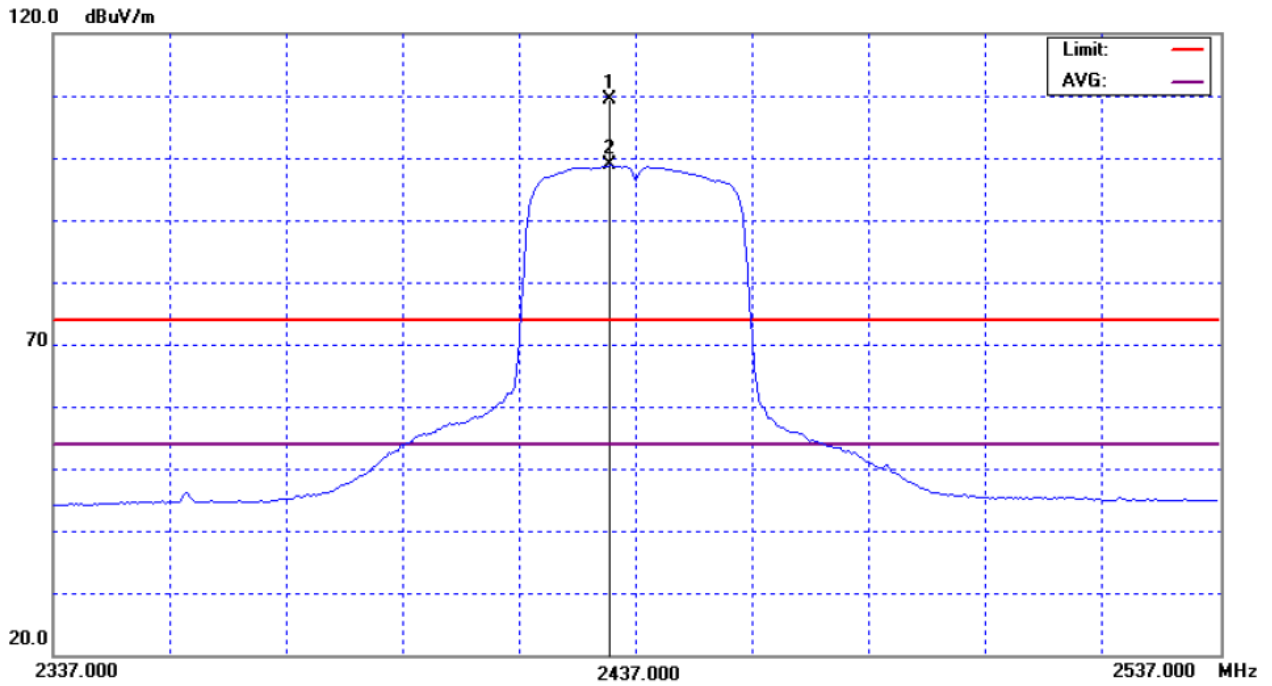



EUT :	N_Max Wireless Access Point	Model Name :	WAP-6010
Temperature :	13 °C	Relative Humidity :	64%
Test Voltage :	AC 120V/60Hz		
Test Mode :	802.11n/40M/CH06 (Port. 0 + Port. 1)		

Freq. (MHz)	Ant.Pol. H/V	Reading		Ant./CF CF(dB)	Act.		Limit		Note
		Peak (dBuV)	AV (dBuV)		Peak (dBuV/m)	AV (dBuV/m)	Peak (dBuV/m)	AV (dBuV/m)	
2426.60	H	72.13	61.77	32.78	104.91	94.55			X/F
4870.60	H	49.50	36.23	4.27	53.77	40.50	74.00	54.00	X/H

**Remark :**

- (1) Spectrum Setting : 30MHz – 1000MHz , RBW= 100KHz, VBW=100KHz, Sweep time = 200 ms. 1GHz- 25GHz, RBW= 1MHz, VBW= 1MHz, Sweep time = Auto
- (2) All readings are Peak unless otherwise stated AV in column of 『Note』 . Peak denotes that the Peak reading compliance with the AV Limits and then AV Mode measurement didn't perform.
- (3) Measuring frequency range from 30MHz to 1000MHz or the 10th harmonic of highest fundamental frequency. "F" denotes fundamental frequency; "H" denotes spurious frequency. "E" denotes band edge frequency. (This judgment method includes the Band Edge Requirement.)
- (4) Radiated emissions measured in frequency range above 1000MHz were made with an instrument using Peak detector mode and AV detector mode of the emission .
- (5) Data of measurement within this frequency range shown " \* " in the table above means the reading of emissions are attenuated more than 20dB below the permissible limits or the field strength is too small to be measured.
- (6) A preamp and high pass filter were used for this test in order to provide sufficient measurement sensitivity.
- (7) EUT Orthogonal Axes :  
 "X" - denotes Laid on Table ; "Y" - denotes Vertical Stand ; "Z" - denotes Side Stand
- (8) During the measurements above 1GHz it is taken care of that the EUT is always within the 3dB cone of radiation BW of the used antenna.



Orthogonal Axis : X

802.11g/40M/CH06(Port 0 + Port 1) (Above 1000 MHz, Horizontal)

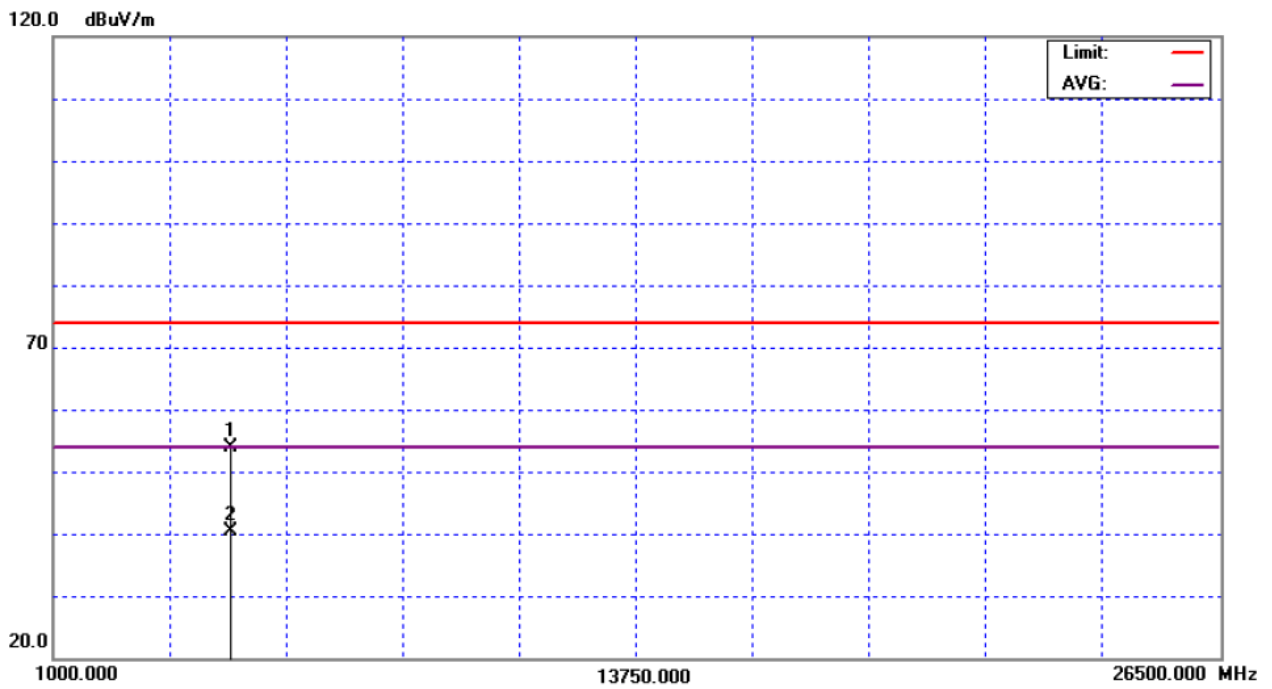
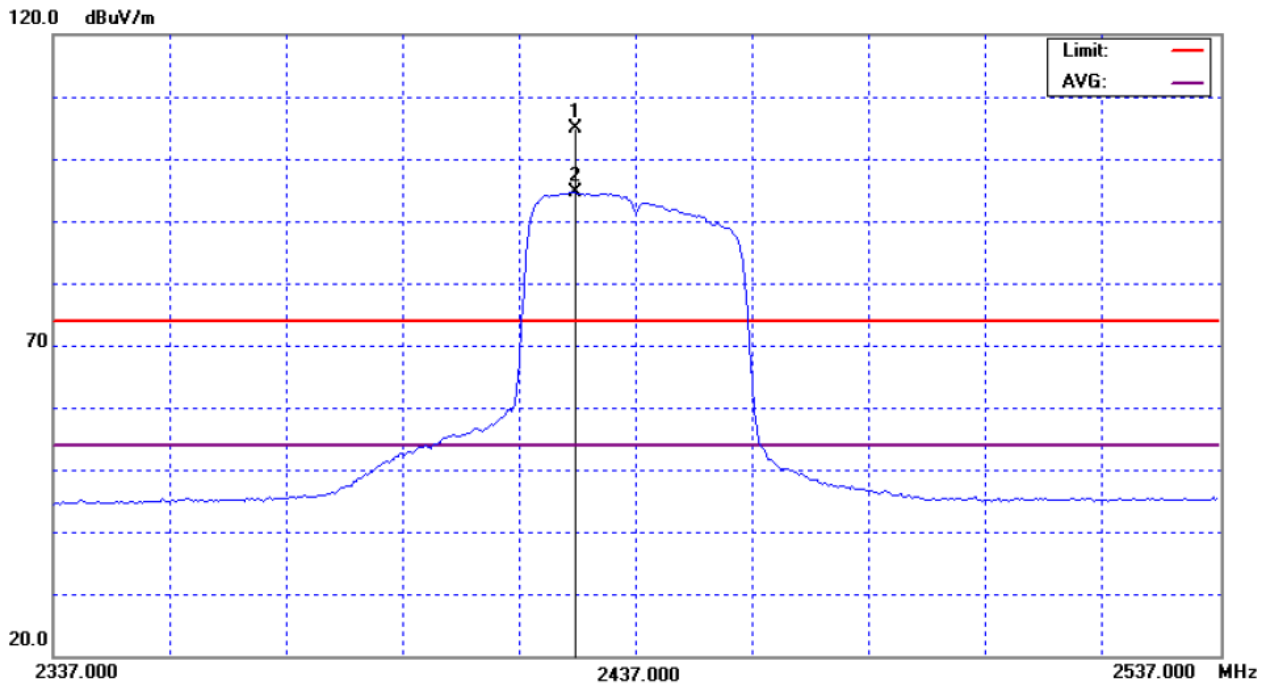



EUT :	N_Max Wireless Access Point	Model Name :	WAP-6010
Temperature :	13 °C	Relative Humidity :	64%
Test Voltage :	AC 120V/60Hz		
Test Mode :	802.11n/40M/CH09 (Port. 0 + Port. 1)		

Freq. (MHz)	Ant.Pol. H/V	Reading		Ant./CF CF(dB)	Act.		Limit		Note
		Peak (dBuV)	AV (dBuV)		Peak (dBuV/m)	AV (dBuV/m)	Peak (dBuV/m)	AV (dBuV/m)	
2448.80	V	74.68	64.50	32.90	107.58	97.40			X/F
2483.50	V	30.45	19.21	33.10	63.55	52.31	74.00	54.00	X/H
4913.68	V	46.78	34.86	4.48	51.26	39.34	74.00	54.00	X/H

**Remark :**

- (1) Spectrum Setting : 30MHz – 1000MHz , RBW= 100KHz, VBW=100KHz, Sweep time = 200 ms. 1GHz- 25GHz, RBW= 1MHz, VBW= 1MHz, Sweep time = Auto
- (2) All readings are Peak unless otherwise stated AV in column of 『Note』 . Peak denotes that the Peak reading compliance with the AV Limits and then AV Mode measurement didn't perform.
- (3) Measuring frequency range from 30MHz to 1000MHz or the 10th harmonic of highest fundamental frequency. "F" denotes fundamental frequency; "H" denotes spurious frequency. "E" denotes band edge frequency. (This judgment method includes the Band Edge Requirement.)
- (4) Radiated emissions measured in frequency range above 1000MHz were made with an instrument using Peak detector mode and AV detector mode of the emission .
- (5) Data of measurement within this frequency range shown " \* " in the table above means the reading of emissions are attenuated more than 20dB below the permissible limits or the field strength is too small to be measured.
- (6) A preamp and high pass filter were used for this test in order to provide sufficient measurement sensitivity.
- (7) EUT Orthogonal Axes :  
"X" - denotes Laid on Table ; "Y" - denotes Vertical Stand ; "Z" - denotes Side Stand
- (8) During the measurements above 1GHz it is taken care of that the EUT is always within the 3dB cone of radiation BW of the used antenna.



Orthogonal Axis : X  
802.11g/40M/CH09(Port 0 + Port 1) (Above 1000 MHz, Vertical)

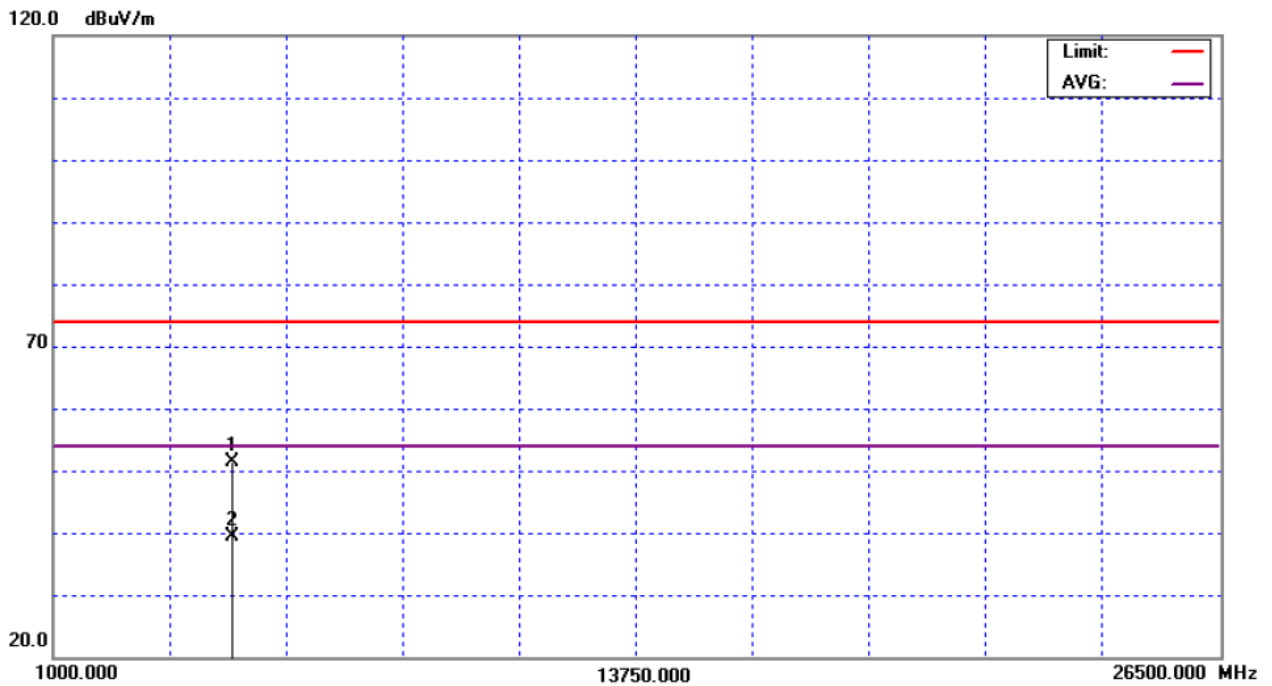
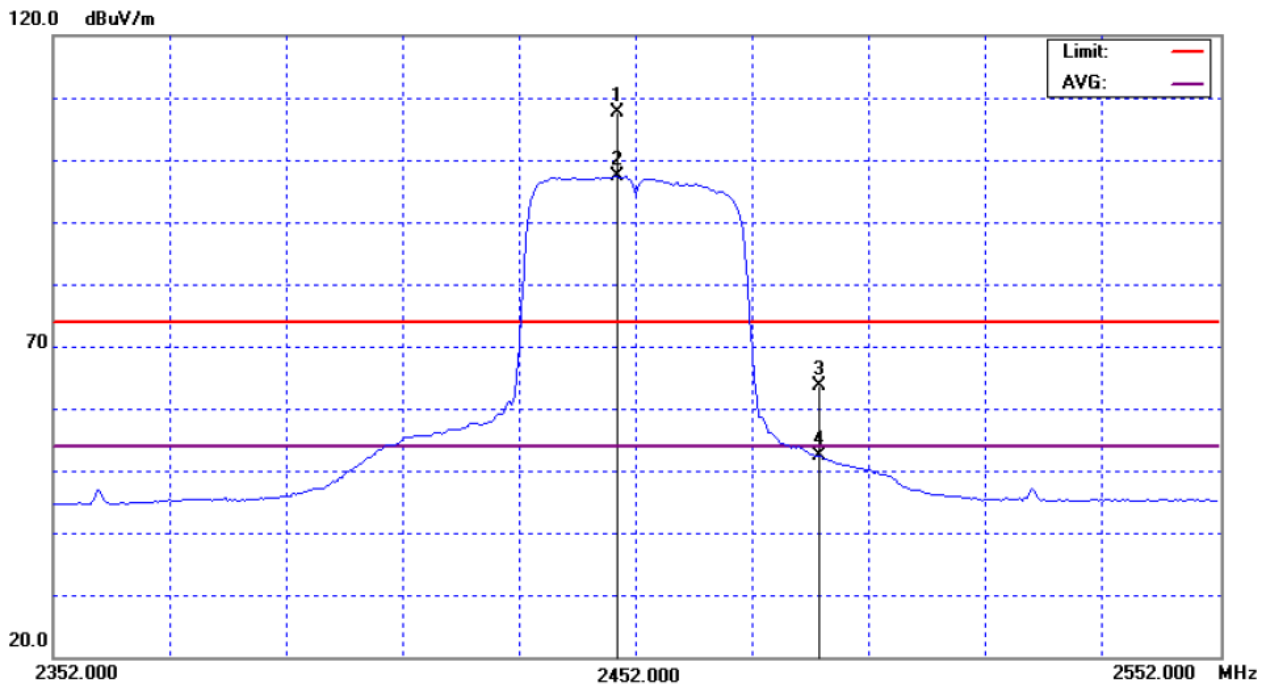



EUT :	N_Max Wireless Access Point	Model Name :	WAP-6010
Temperature :	13 ° C	Relative Humidity :	64%
Test Voltage :	AC 120V/60Hz		
Test Mode :	802.11n/40M/CH09 (Port. 0 + Port. 1)		

Freq. (MHz)	Ant.Pol. H/V	Reading		Ant./CF CF(dB)	Act.		Limit		Note
		Peak (dBuV)	AV (dBuV)		Peak (dBuV/m)	AV (dBuV/m)	Peak (dBuV/m)	AV (dBuV/m)	
2441.20	H	67.22	57.59	32.86	100.08	90.45			X/F
2483.50	H	25.53	13.72	33.10	58.63	46.82	74.00	54.00	X/H
4906.88	H	46.76	33.81	4.45	51.21	38.26	74.00	54.00	X/H

**Remark :**

- (1) Spectrum Setting : 30MHz – 1000MHz , RBW= 100KHz, VBW=100KHz, Sweep time = 200 ms. 1GHz- 25GHz, RBW= 1MHz, VBW= 1MHz, Sweep time = Auto
- (2) All readings are Peak unless otherwise stated AV in column of 『Note』 . Peak denotes that the Peak reading compliance with the AV Limits and then AV Mode measurement didn't perform.
- (3) Measuring frequency range from 30MHz to 1000MHz or the 10th harmonic of highest fundamental frequency. "F" denotes fundamental frequency; "H" denotes spurious frequency. "E" denotes band edge frequency. (This judgment method includes the Band Edge Requirement.)
- (4) Radiated emissions measured in frequency range above 1000MHz were made with an instrument using Peak detector mode and AV detector mode of the emission .
- (5) Data of measurement within this frequency range shown " \* " in the table above means the reading of emissions are attenuated more than 20dB below the permissible limits or the field strength is too small to be measured.
- (6) A preamp and high pass filter were used for this test in order to provide sufficient measurement sensitivity.
- (7) EUT Orthogonal Axes :  
"X" - denotes Laid on Table ; "Y" - denotes Vertical Stand ; "Z" - denotes Side Stand
- (8) During the measurements above 1GHz it is taken care of that the EUT is always within the 3dB cone of radiation BW of the used antenna.



Orthogonal Axis : X

802.11g/40M/CH09(Port 0 + Port 1) (Above 1000 MHz, Horizontal)

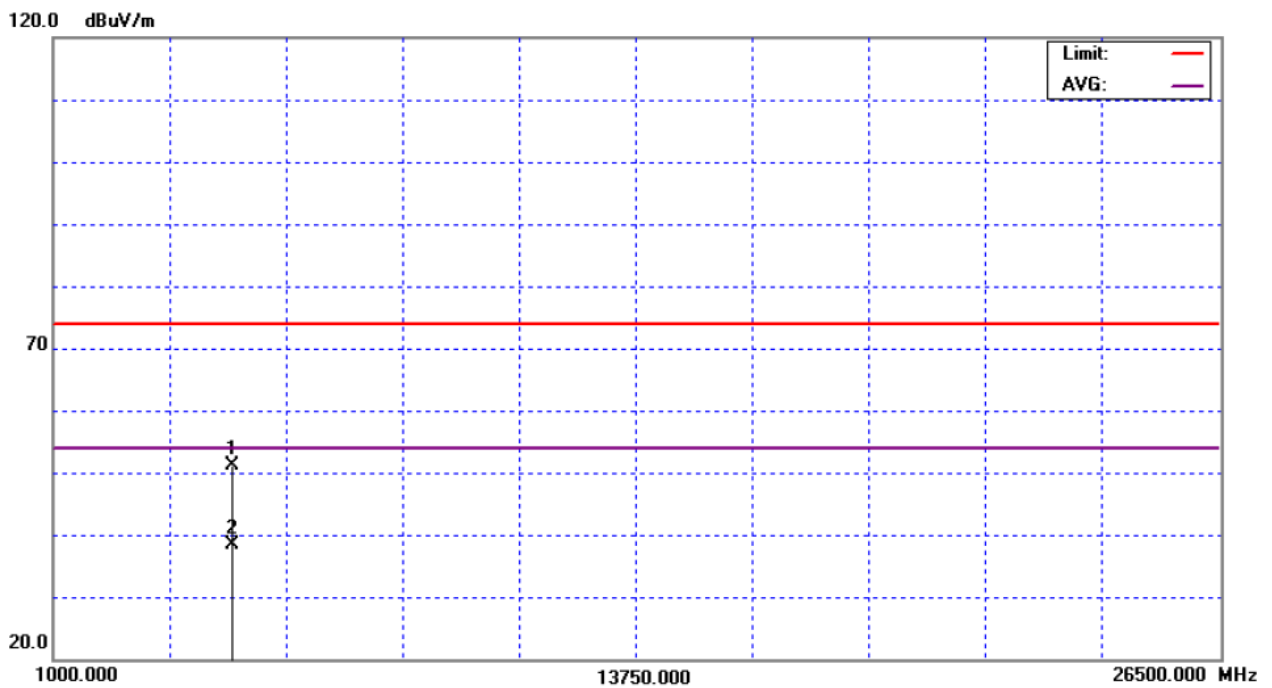
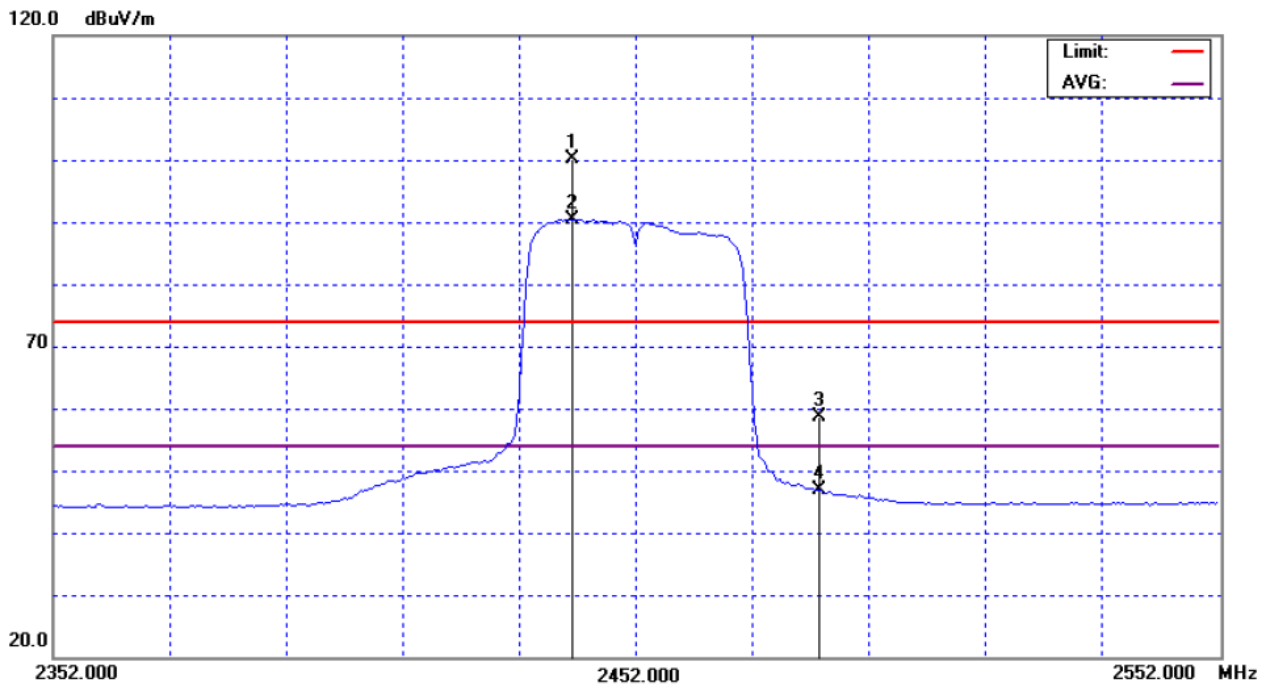



**4.2.9 TEST RESULTS-RESTRICTED BANDS REQUIREMENTS**

EUT :	N_Max Wireless Access Point	Model Name :	WAP-6010
Temperature :	13 °C	Relative Humidity :	64%
Test Voltage :	AC 120V/60Hz		
Test Mode :	802.11b(Vertical)		
Note :	<p>The emission of the carrier radiated field strength is measured for CH01/CH11 (Peak and AV) as following:</p> <ol style="list-style-type: none"> <li>1. The transmitter was then configured with the worst case antenna and setup to transmit at the lowest channel (CH01). Then the field strength was measured at 2310-2390 MHz.</li> <li>2. The transmitter was configured with the worst case antenna and setup to transmit at the highest channel (CH11). Then the field strength was measured at 2483.5-2500 MHz.</li> </ol>		

Freq. (MHz)	Ant.Pol. H/V	Reading		Ant./CF CF(dB)	Act.		Limit		Note
		Peak (dBuV)	AV (dBuV)		Peak (dBuV/m)	AV (dBuV/m)	Peak (dBuV/m)	AV (dBuV/m)	
2386.60	V	25.92	15.81	32.55	58.47	48.36	74.00	54.00	X
2487.70	V	26.43	18.81	33.12	59.55	51.93	74.00	54.00	X

**Remark :**

- (1) Spectrum Setting : 30MHz – 1000MHz , RBW= 100KHz, VBW=100KHz, Sweep time = 200 ms. 1GHz- 25GHz, RBW= 1MHz, VBW= 1MHz, Sweep time = Auto
- (2) Radiated emissions measured in frequency range above 1000MHz were made with an instrument using Peak detector mode and AV detector mode of the emission ◦
- (3) EUT Orthogonal Axes :  
 "X" - denotes Laid on Table ; "Y" - denotes Vertical Stand ; "Z" - denotes Side Stand





### 802.11b (Restricted Bands Requirements, Vertical)

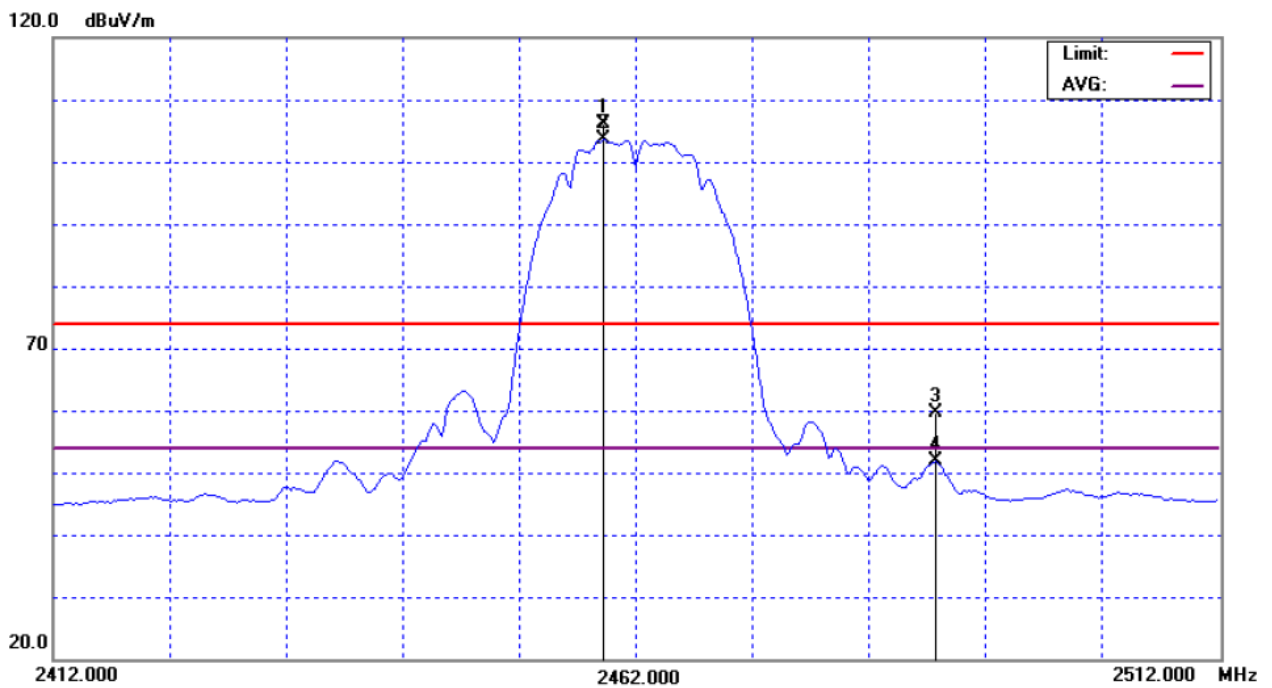
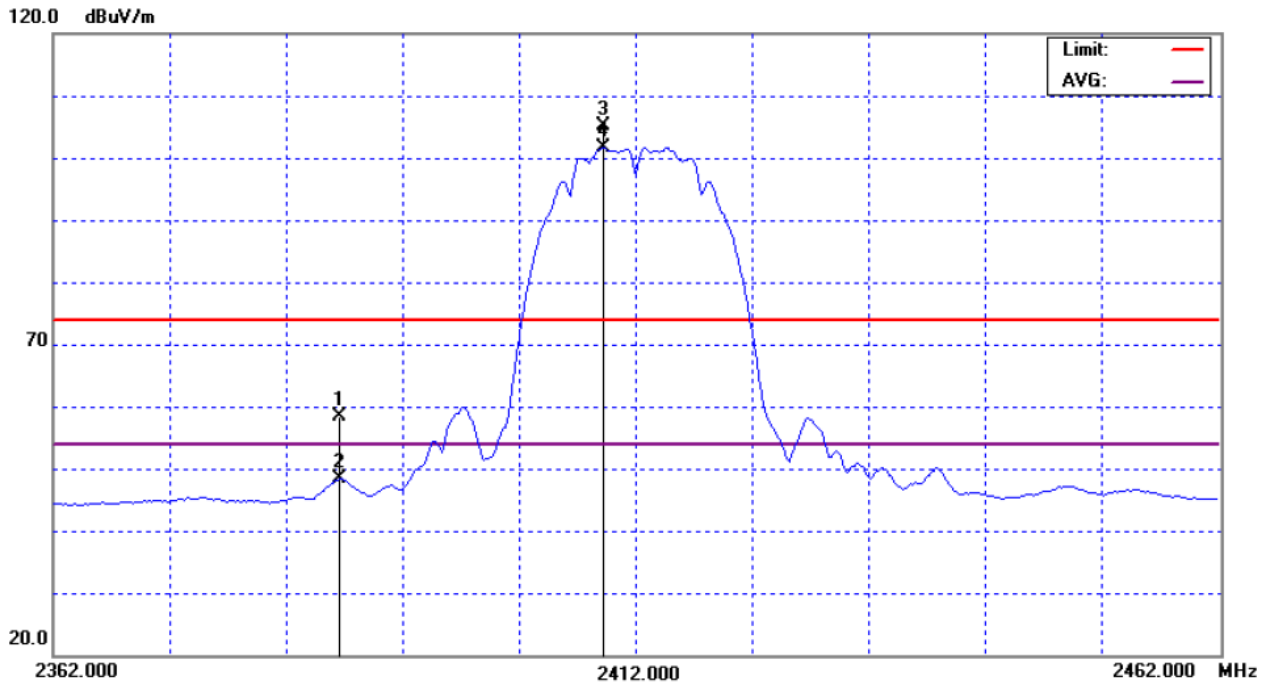



EUT :	N_Max Wireless Access Point	Model Name :	WAP-6010
Temperature :	13 °C	Relative Humidity :	64%
Test Voltage :	AC 120V/60Hz		
Test Mode :	802.11b(Horizontal)		
Note :	<p>The emission of the carrier radiated field strength is measured for CH01/CH11 (Peak and AV) as following:</p> <ol style="list-style-type: none"> <li>1. The transmitter was then configured with the worst case antenna and setup to transmit at the lowest channel (CH01). Then the field strength was measured at 2310-2390 MHz.</li> <li>2. The transmitter was configured with the worst case antenna and setup to transmit at the highest channel (CH11). Then the field strength was measured at 2483.5-2500 MHz.</li> </ol>		

Freq. (MHz)	Ant.Pol. H/V	Reading		Ant./CF CF(dB)	Act.		Limit		Note
		Peak (dBuV)	AV (dBuV)		Peak (dBuV/m)	AV (dBuV/m)	Peak (dBuV/m)	AV (dBuV/m)	
2386.60	H	24.38	15.66	32.55	56.93	48.21	74.00	54.00	X
2487.70	H	25.35	15.48	33.12	58.47	48.60	74.00	54.00	X

**Remark :**

- (1) Spectrum Setting : 30MHz – 1000MHz , RBW= 100KHz, VBW=100KHz, Sweep time = 200 ms. 1GHz- 25GHz, RBW= 1MHz, VBW= 1MHz, Sweep time = Auto
- (2) Radiated emissions measured in frequency range above 1000MHz were made with an instrument using Peak detector mode and AV detector mode of the emission ◦
- (3) EUT Orthogonal Axes :  
 "X" - denotes Laid on Table ; "Y" - denotes Vertical Stand ; "Z" - denotes Side Stand



### 802.11b (Restricted Bands Requirements, Horizontal)

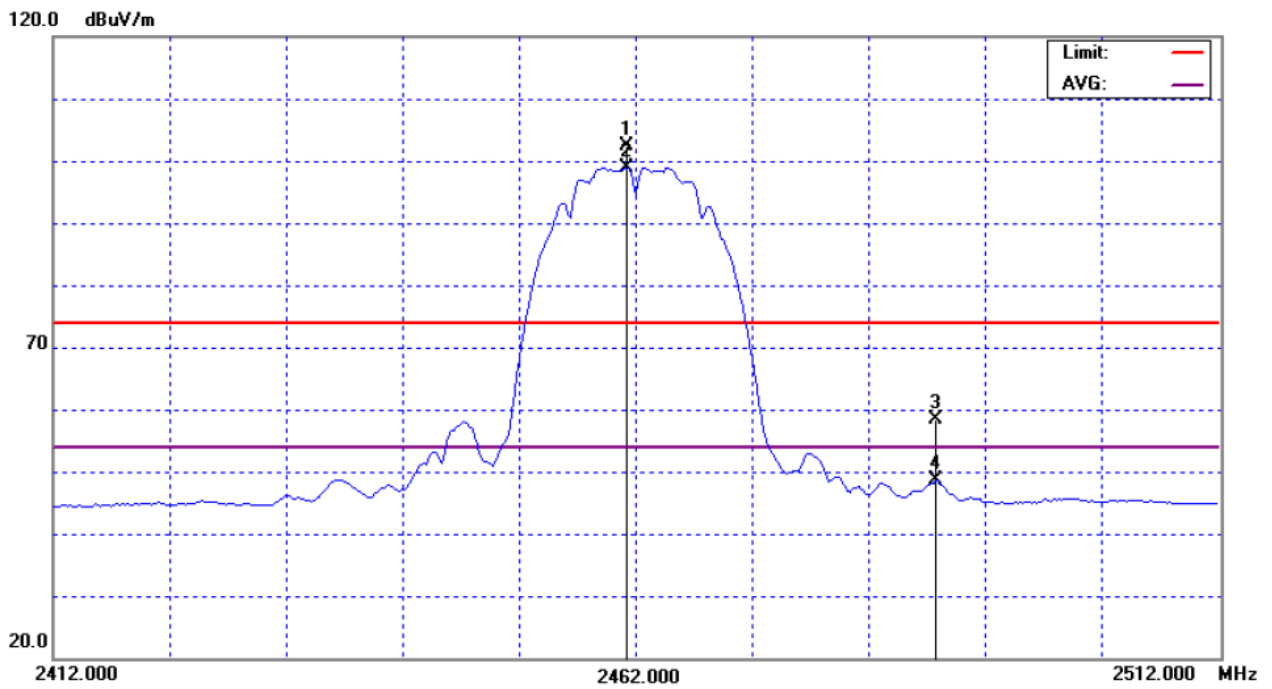
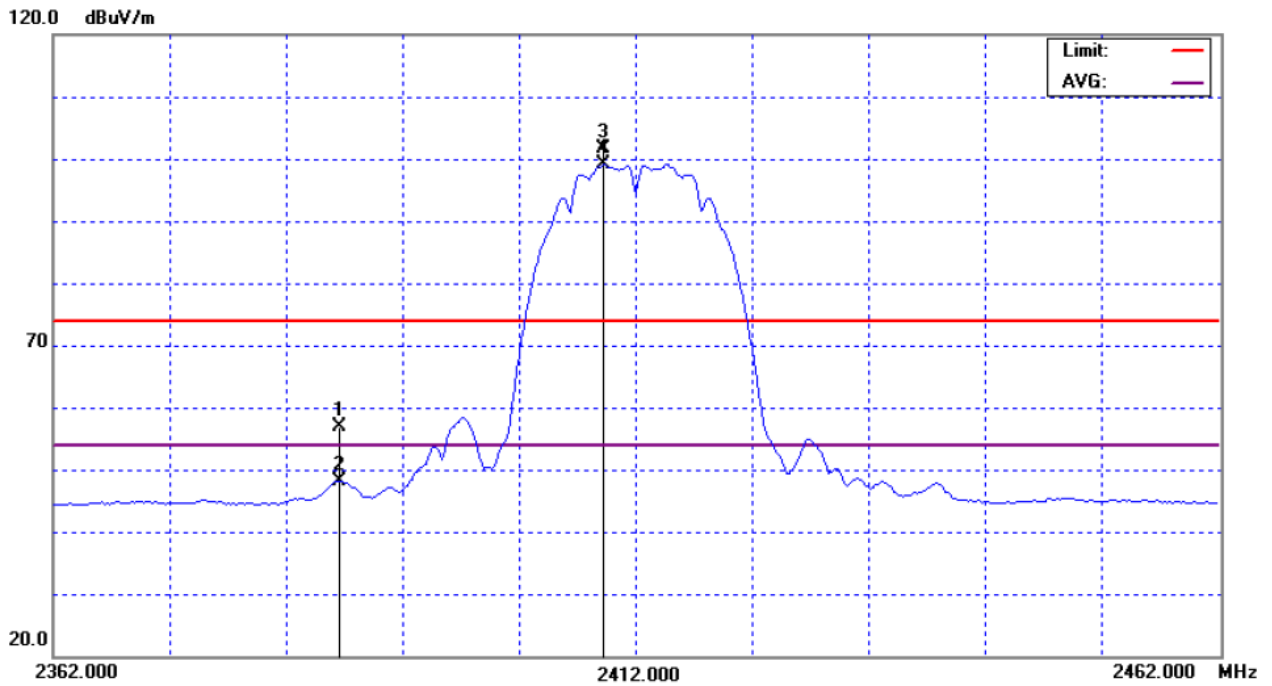



EUT :	N_Max Wireless Access Point	Model Name :	WAP-6010
Temperature :	13 °C	Relative Humidity :	64%
Test Voltage :	AC 120V/60Hz		
Test Mode :	802.11g(Vertical)		
Note :	<p>The emission of the carrier radiated field strength is measured for CH01/CH11 (Peak and AV) as following:</p> <ol style="list-style-type: none"> <li>1. The transmitter was then configured with the worst case antenna and setup to transmit at the lowest channel (CH01). Then the field strength was measured at 2310-2390 MHz.</li> <li>2. The transmitter was configured with the worst case antenna and setup to transmit at the highest channel (CH11). Then the field strength was measured at 2483.5-2500 MHz.</li> </ol>		

Freq. (MHz)	Ant.Pol. H/V	Reading		Ant./CF CF(dB)	Act.		Limit		Note
		Peak (dBuV)	AV (dBuV)		Peak (dBuV/m)	AV (dBuV/m)	Peak (dBuV/m)	AV (dBuV/m)	
2390.00	V	28.43	16.27	32.57	61.00	48.84	74.00	54.00	X
2483.50	V	30.09	17.00	33.10	63.19	50.10	74.00	54.00	X

**Remark :**

- (1) Spectrum Setting : 30MHz – 1000MHz , RBW= 100KHz, VBW=100KHz, Sweep time = 200 ms. 1GHz- 25GHz, RBW= 1MHz, VBW= 1MHz, Sweep time = Auto
- (2) Radiated emissions measured in frequency range above 1000MHz were made with an instrument using Peak detector mode and AV detector mode of the emission .
- (3) EUT Orthogonal Axes :  
 "X" - denotes Laid on Table ; "Y" - denotes Vertical Stand ; "Z" - denotes Side Stand



### 802.11g (Restricted Bands Requirements, Vertical)

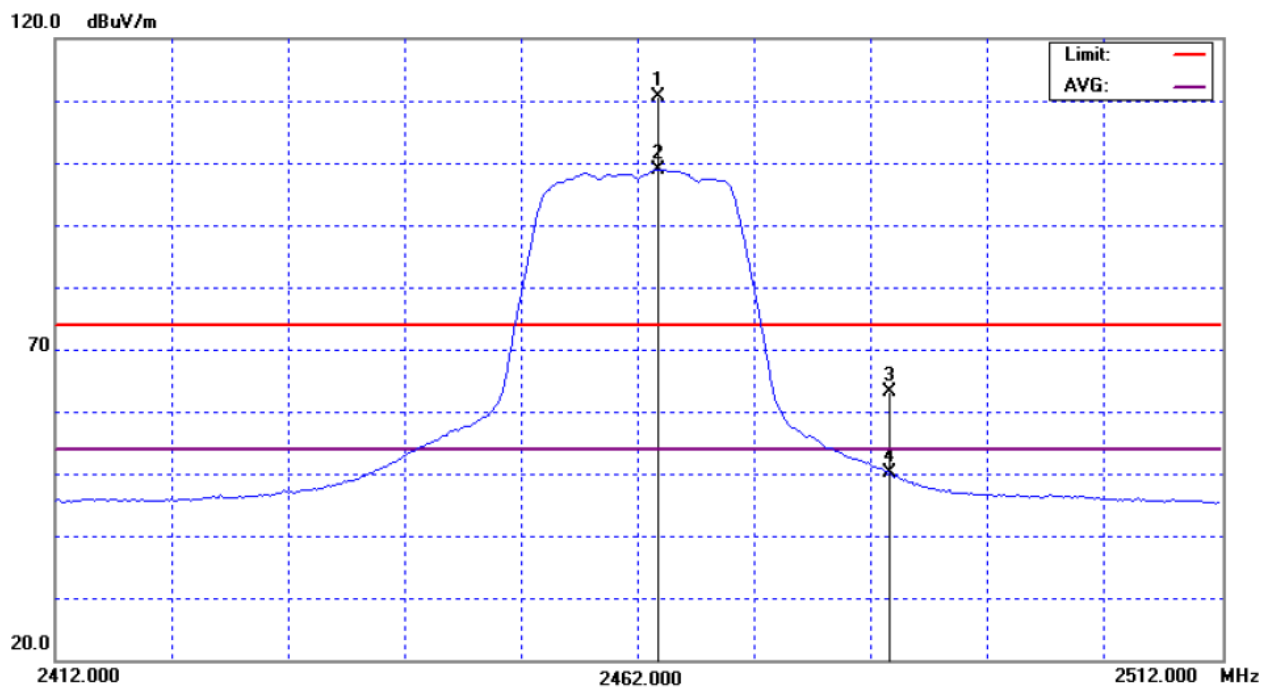
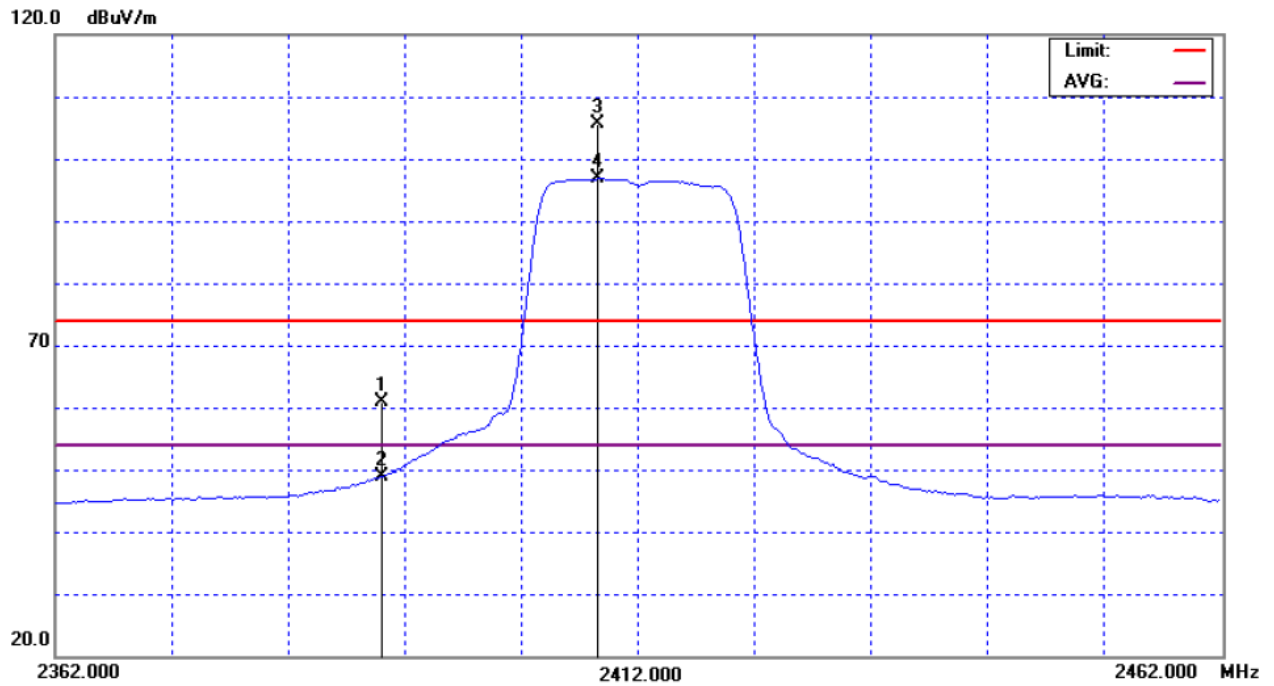



EUT :	N_Max Wireless Access Point	Model Name :	WAP-6010
Temperature :	13 °C	Relative Humidity :	64%
Test Voltage :	AC 120V/60Hz		
Test Mode :	802.11g(Horizontal)		
Note :	<p>The emission of the carrier radiated field strength is measured for CH01/CH11 (Peak and AV) as following:</p> <ol style="list-style-type: none"> <li>1. The transmitter was then configured with the worst case antenna and setup to transmit at the lowest channel (CH01). Then the field strength was measured at 2310-2390 MHz.</li> <li>2. The transmitter was configured with the worst case antenna and setup to transmit at the highest channel (CH11). Then the field strength was measured at 2483.5-2500 MHz.</li> </ol>		

Freq. (MHz)	Ant.Pol. H/V	Reading		Ant./CF CF(dB)	Act.		Limit		Note
		Peak (dBuV)	AV (dBuV)		Peak (dBuV/m)	AV (dBuV/m)	Peak (dBuV/m)	AV (dBuV/m)	
2390.00	H	24.89	13.94	32.57	57.46	46.51	74.00	54.00	X
2483.50	H	22.95	13.23	33.10	56.05	46.33	74.00	54.00	X

**Remark :**

- (1) Spectrum Setting : 30MHz – 1000MHz , RBW= 100KHz, VBW=100KHz, Sweep time = 200 ms. 1GHz- 25GHz, RBW= 1MHz, VBW= 1MHz, Sweep time = Auto
- (2) Radiated emissions measured in frequency range above 1000MHz were made with an instrument using Peak detector mode and AV detector mode of the emission ◦
- (3) EUT Orthogonal Axes :  
 "X" - denotes Laid on Table ; "Y" - denotes Vertical Stand ; "Z" - denotes Side Stand



### 802.11g (Restricted Bands Requirements, Horizontal)

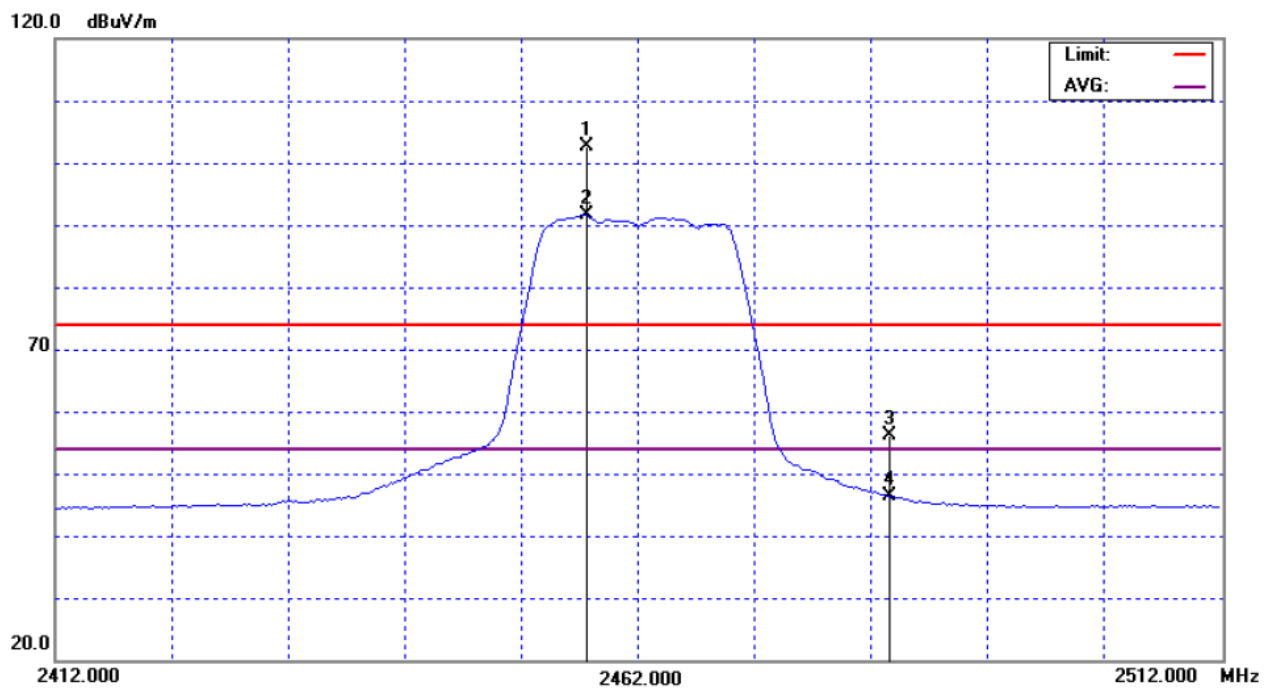
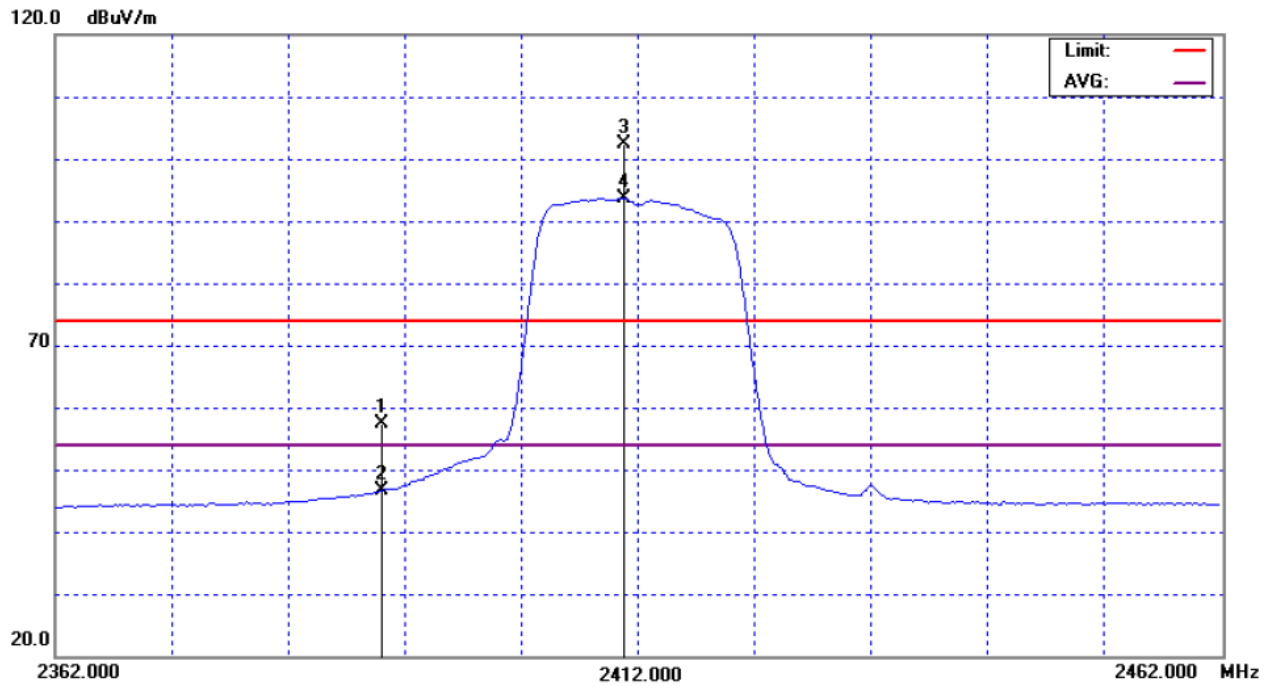



EUT :	N_Max Wireless Access Point	Model Name :	WAP-6010
Temperature :	13 °C	Relative Humidity :	64%
Test Voltage :	AC 120V/60Hz		
Test Mode :	802.11n/20M(Port. 0 + Port. 1) (Vertical)		
Note :	<p>The emission of the carrier radiated field strength is measured for CH01/CH11 (Peak and AV) as following:</p> <ol style="list-style-type: none"> <li>1. The transmitter was then configured with the worst case antenna and setup to transmit at the lowest channel (CH01). Then the field strength was measured at 2310-2390 MHz.</li> <li>2. The transmitter was configured with the worst case antenna and setup to transmit at the highest channel (CH11). Then the field strength was measured at 2483.5-2500 MHz.</li> </ol>		

Freq. (MHz)	Ant.Pol. H/V	Reading		Ant./CF CF(dB)	Act.		Limit		Note
		Peak (dBuV)	AV (dBuV)		Peak (dBuV/m)	AV (dBuV/m)	Peak (dBuV/m)	AV (dBuV/m)	
2390.00	V	33.40	20.42	32.57	65.97	52.99	74.00	54.00	X
2483.50	V	32.82	17.19	33.10	65.92	50.29	74.00	54.00	X

**Remark :**

- (1) Spectrum Setting : 30MHz – 1000MHz , RBW= 100KHz, VBW=100KHz, Sweep time = 200 ms. 1GHz- 25GHz, RBW= 1MHz, VBW= 1MHz, Sweep time = Auto
- (2) Radiated emissions measured in frequency range above 1000MHz were made with an instrument using Peak detector mode and AV detector mode of the emission ◦
- (3) EUT Orthogonal Axes :  
 "X" - denotes Laid on Table ; "Y" - denotes Vertical Stand ; "Z" - denotes Side Stand





802.11n/20M (Port 0 + Port 1) (Restricted Bands Requirements, Vertical)

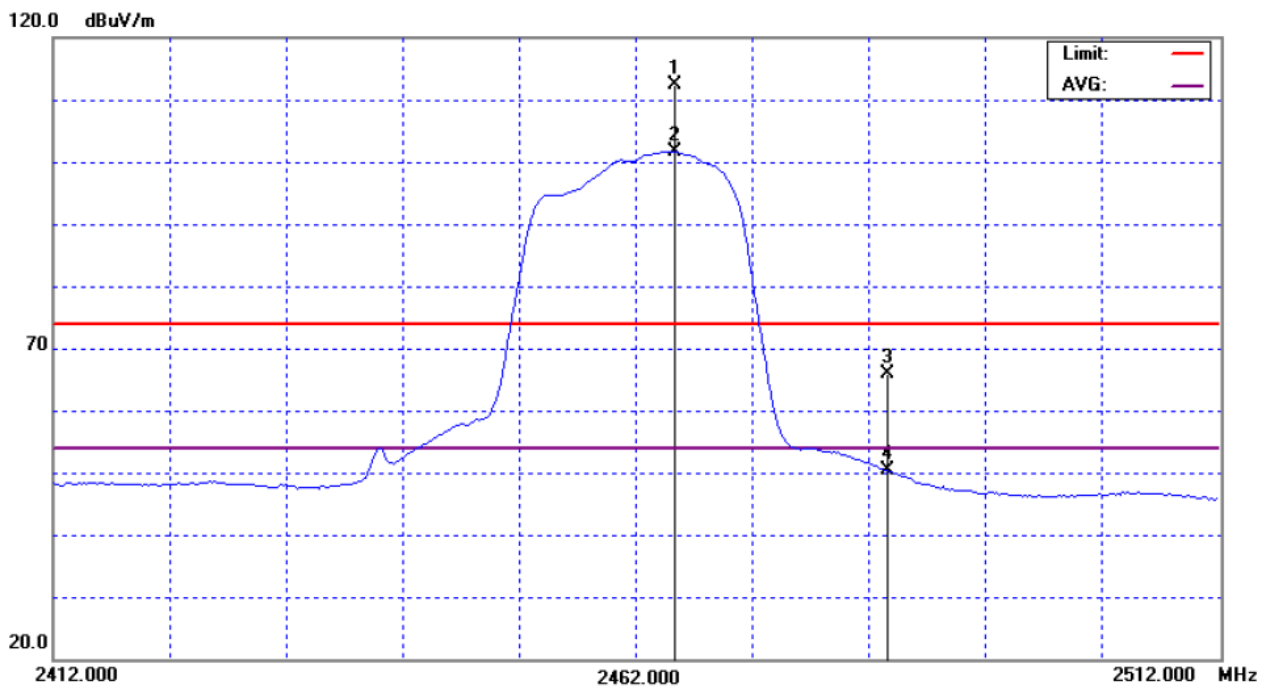
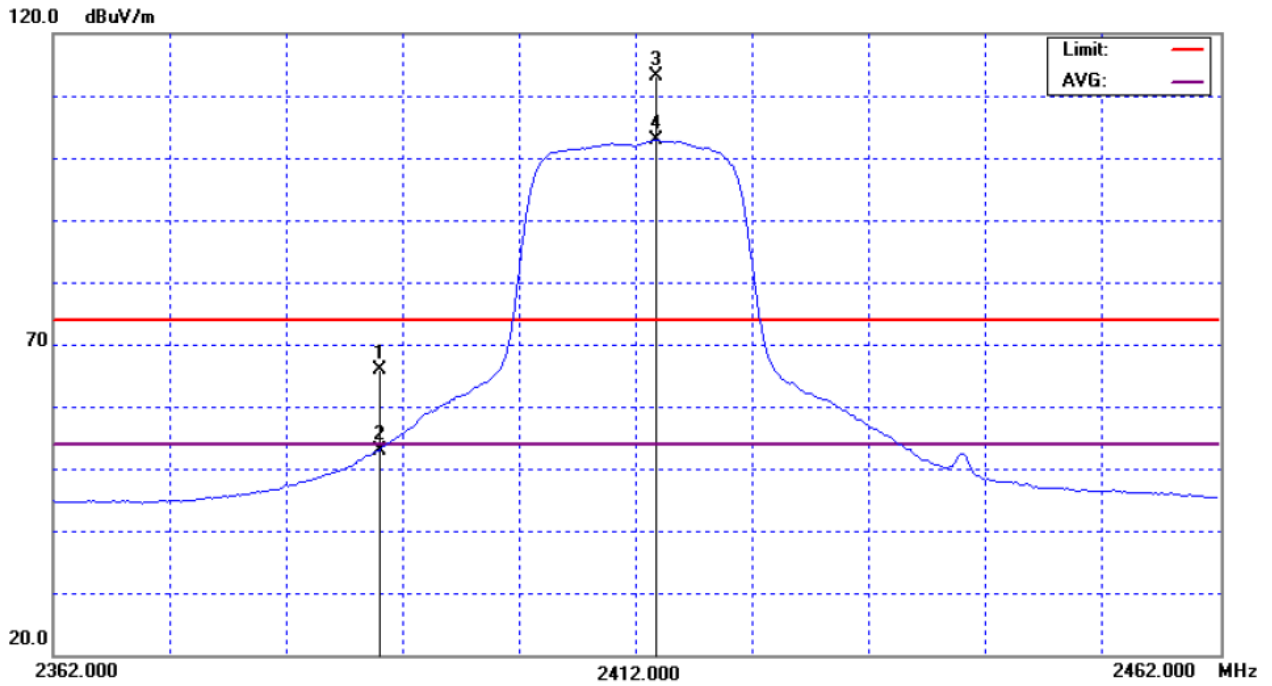



EUT :	N_Max Wireless Access Point	Model Name :	WAP-6010
Temperature :	13 °C	Relative Humidity :	64%
Test Voltage :	AC 120V/60Hz		
Test Mode :	802.11n/20M(Port. 0 + Port. 1) (Horizontal)		
Note :	<p>The emission of the carrier radiated field strength is measured for CH01/CH11 (Peak and AV) as following:</p> <ol style="list-style-type: none"> <li>1. The transmitter was then configured with the worst case antenna and setup to transmit at the lowest channel (CH01). Then the field strength was measured at 2310-2390 MHz.</li> <li>2. The transmitter was configured with the worst case antenna and setup to transmit at the highest channel (CH11). Then the field strength was measured at 2483.5-2500 MHz.</li> </ol>		

Freq. (MHz)	Ant.Pol. H/V	Reading		Ant./CF CF(dB)	Act.		Limit		Note
		Peak (dBuV)	AV (dBuV)		Peak (dBuV/m)	AV (dBuV/m)	Peak (dBuV/m)	AV (dBuV/m)	
2390.00	H	33.10	19.63	32.57	65.67	52.20	74.00	54.00	X
2483.50	H	28.32	13.88	33.10	61.42	46.98	74.00	54.00	X

**Remark :**

- (1) Spectrum Setting : 30MHz – 1000MHz , RBW= 100KHz, VBW=100KHz, Sweep time = 200 ms. 1GHz- 25GHz, RBW= 1MHz, VBW= 1MHz, Sweep time = Auto
- (2) Radiated emissions measured in frequency range above 1000MHz were made with an instrument using Peak detector mode and AV detector mode of the emission ◦
- (3) EUT Orthogonal Axes :  
 "X" - denotes Laid on Table ; "Y" - denotes Vertical Stand ; "Z" - denotes Side Stand



802.11n/20M (Port 0 + Port 1) (Restricted Bands Requirements, Horizontal)

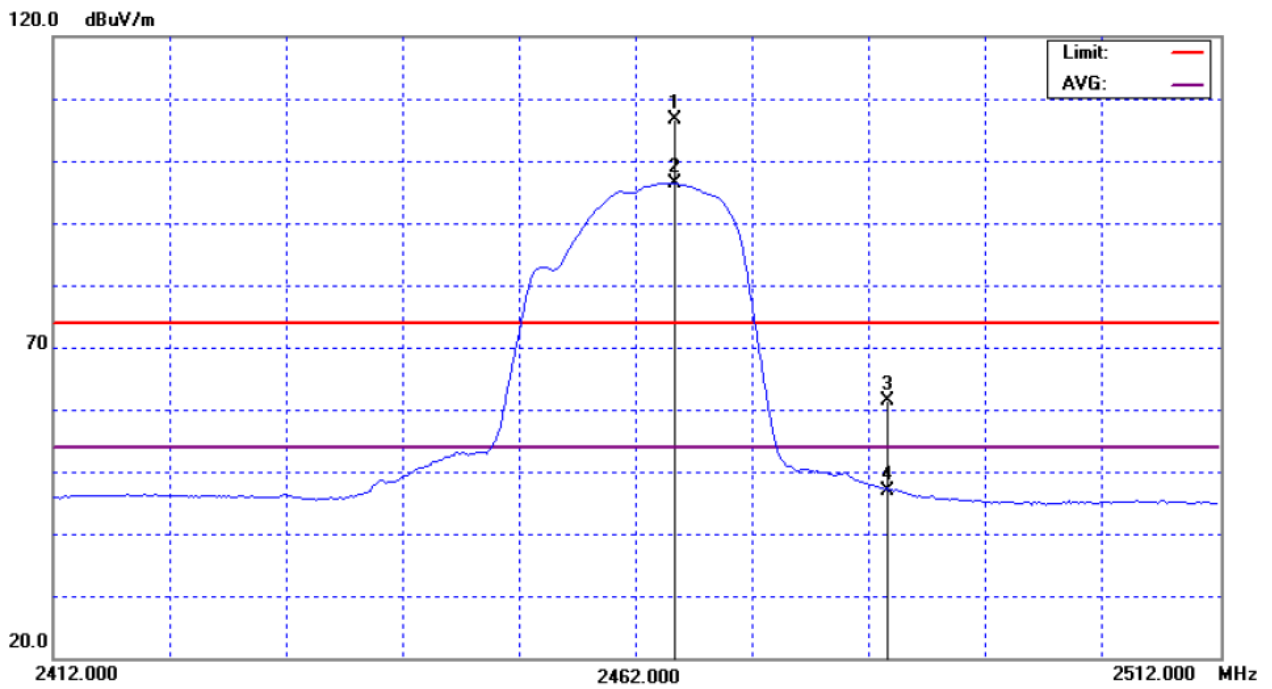
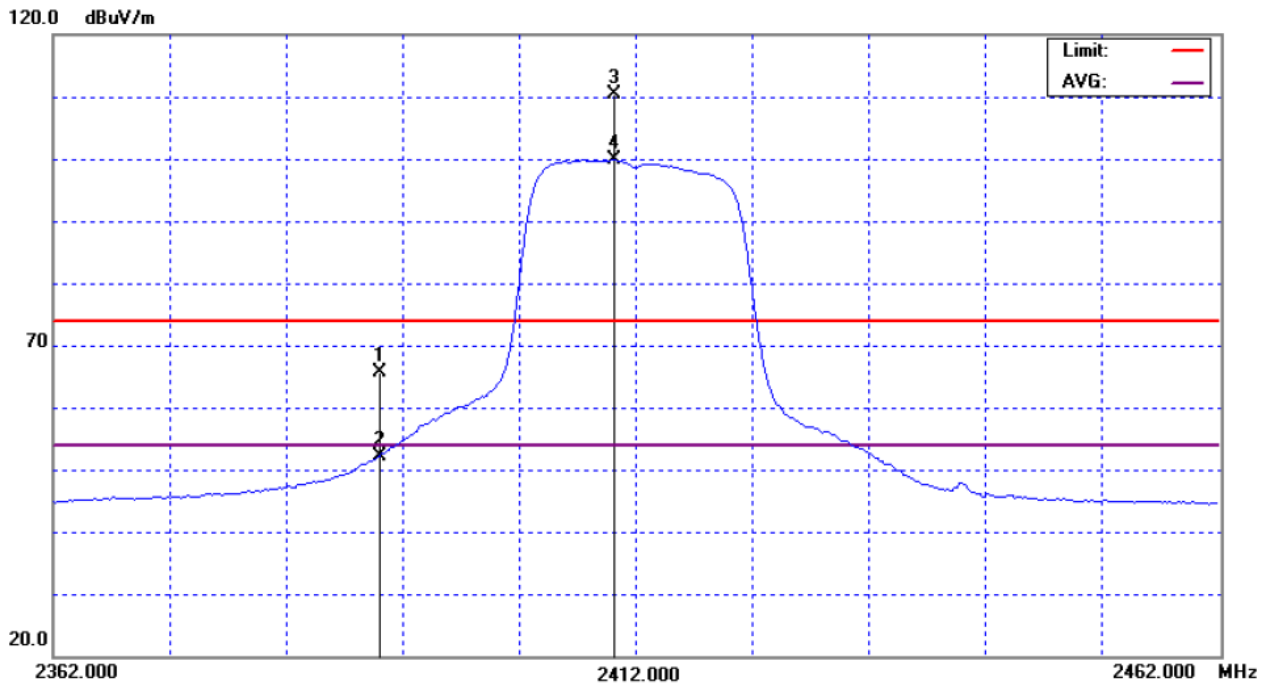



EUT :	N_Max Wireless Access Point	Model Name :	WAP-6010
Temperature :	13 °C	Relative Humidity :	64%
Test Voltage :	AC 120V/60Hz		
Test Mode :	802.11n/40M (Port. 0 + Port. 1) (Vertical)		
Note :	<p>The emission of the carrier radiated field strength is measured for CH03/CH09 (Peak and AV) as following:</p> <ol style="list-style-type: none"> <li>1. The transmitter was then configured with the worst case antenna and setup to transmit at the lowest channel (CH03). Then the field strength was measured at 2310-2390 MHz.</li> <li>2. The transmitter was configured with the worst case antenna and setup to transmit at the highest channel (CH09). Then the field strength was measured at 2483.5-2500 MHz.</li> </ol>		

Freq. (MHz)	Ant.Pol. H/V	Reading		Ant./CF CF(dB)	Act.		Limit		Note
		Peak (dBuV)	AV (dBuV)		Peak (dBuV/m)	AV (dBuV/m)	Peak (dBuV/m)	AV (dBuV/m)	
2390.00	V	33.47	20.65	32.57	66.04	53.22	74.00	54.00	X
2483.50	V	30.45	19.21	33.10	63.55	52.31	74.00	54.00	X

**Remark :**

- (1) Spectrum Setting : 30MHz – 1000MHz , RBW= 100KHz, VBW=100KHz, Sweep time = 200 ms. 1GHz- 25GHz, RBW= 1MHz, VBW= 1MHz, Sweep time = Auto
- (2) Radiated emissions measured in frequency range above 1000MHz were made with an instrument using Peak detector mode and AV detector mode of the emission ◦
- (3) EUT Orthogonal Axes :  
 "X" - denotes Laid on Table ; "Y" - denotes Vertical Stand ; "Z" - denotes Side Stand



802.11n/40M (Port 0 + Port 1) (Restricted Bands Requirements, Vertical)

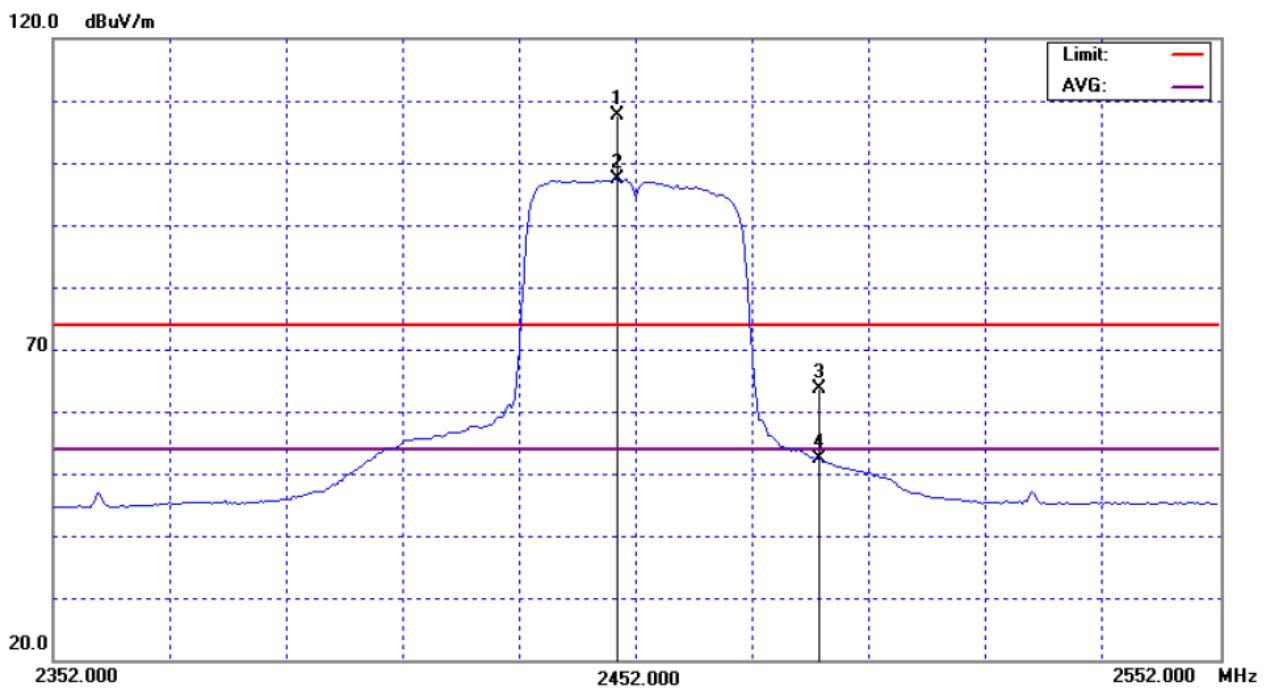
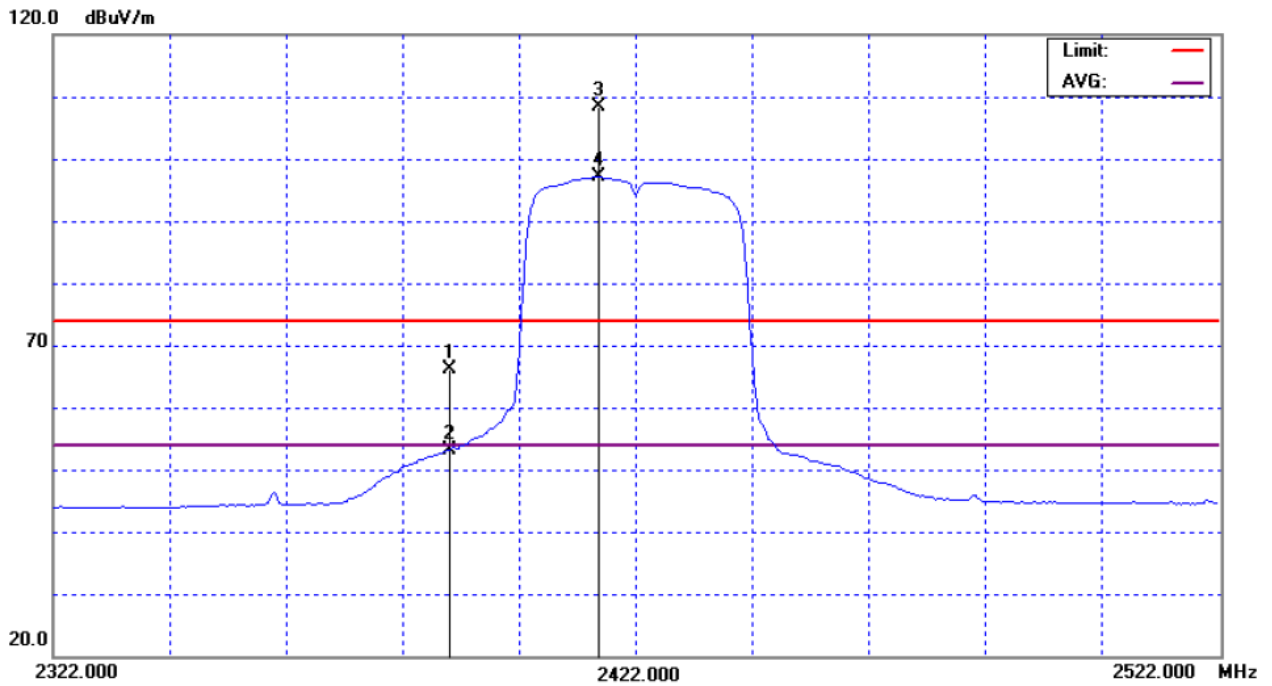



EUT :	N_Max Wireless Access Point	Model Name :	WAP-6010
Temperature :	13 °C	Relative Humidity :	64%
Test Voltage :	AC 120V/60Hz		
Test Mode :	802.11n/40M(Port. 0 + Port. 1) (Horizontal)		
Note :	<p>The emission of the carrier radiated field strength is measured for CH01/CH11 (Peak and AV) as following:</p> <ol style="list-style-type: none"> <li>1. The transmitter was then configured with the worst case antenna and setup to transmit at the lowest channel (CH01). Then the field strength was measured at 2310-2390 MHz.</li> <li>2. The transmitter was configured with the worst case antenna and setup to transmit at the highest channel (CH11). Then the field strength was measured at 2483.5-2500 MHz.</li> </ol>		

Freq. (MHz)	Ant.Pol. H/V	Reading		Ant./CF CF(dB)	Act.		Limit		Note
		Peak (dBuV)	AV (dBuV)		Peak (dBuV/m)	AV (dBuV/m)	Peak (dBuV/m)	AV (dBuV/m)	
2390.00	H	32.29	20.82	32.57	64.86	53.39	74.00	54.00	X
2483.50	H	25.53	13.72	33.10	58.63	46.82	74.00	54.00	X

**Remark :**

- (1) Spectrum Setting : 30MHz – 1000MHz , RBW= 100KHz, VBW=100KHz, Sweep time = 200 ms. 1GHz- 25GHz, RBW= 1MHz, VBW= 1MHz, Sweep time = Auto
- (2) Radiated emissions measured in frequency range above 1000MHz were made with an instrument using Peak detector mode and AV detector mode of the emission ◦
- (3) EUT Orthogonal Axes :  
 "X" - denotes Laid on Table ; "Y" - denotes Vertical Stand ; "Z" - denotes Side Stand



802.11n/40M (Port 0 + Port 1) (Restricted Bands Requirements, Horizontal)

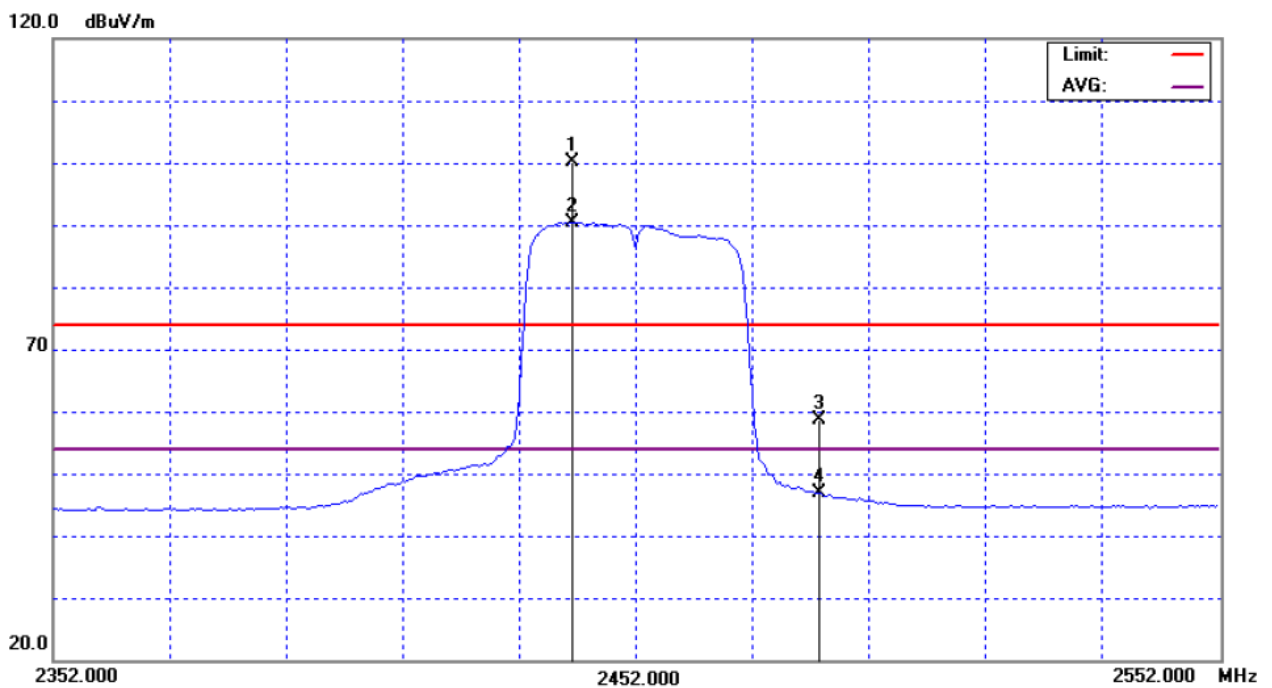
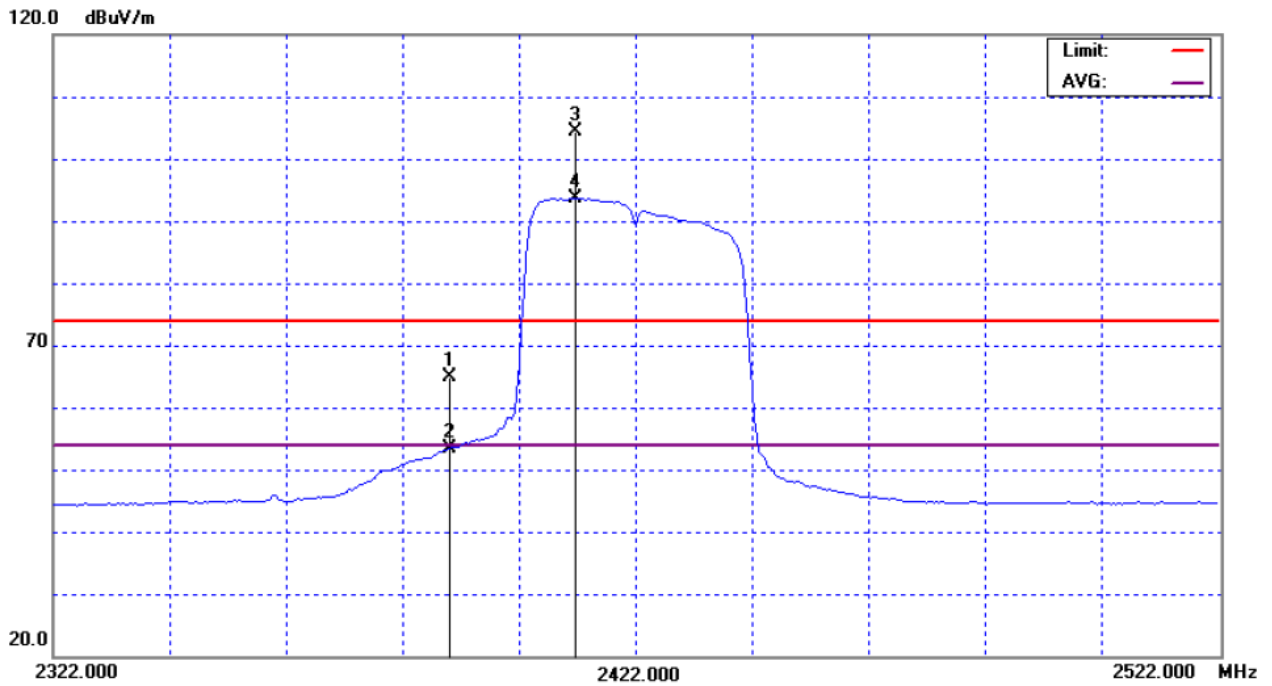



**5. BANDWIDTH TEST**

**5.1 APPLIED PROCEDURES / LIMIT**

FCC Part15, Subpart C			
Test Item	Limit	Frequency Range (MHz)	Result
Bandwidth	>= 500KHz (6dB bandwidth)	2400-2483.5	PASS

**5.1.1 MEASUREMENT INSTRUMENTS LIST**

Item	Kind of Equipment	Manufacturer	Type No.	Serial No.	Calibrated until
1	Spectrum Analyzer	R&S	FSP-40	100129	Sep. 9, 2009

Remark: " N/A" denotes No Model Name , Serial No. or No Calibration specified.

**5.1.2 TEST PROCEDURE**

- a. The EUT was directly connected to the spectrum analyzer and antenna output port as show in the block diagram below,
- b. Spectrum Setting : RBW= 100KHz, VBW=100KHz, Sweep time = Auto.

**5.1.3 DEVIATION FROM STANDARD**

No deviation.

**5.1.4 TEST SETUP**

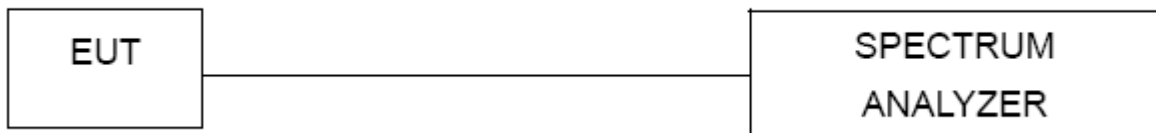

**5.1.5 EUT OPERATION CONDITIONS**

The EUT tested system was configured as the statements of 4.1.6 Unless otherwise a special operating condition is specified in the follows during the testing.





**5.1.6 TEST RESULTS**

EUT :	N_Max Wireless Access Point	Model Name :	WAP-6010
Temperature :	13 °C	Relative Humidity :	64 %
Test Voltage :	AC 120V/60Hz		
Test Mode :	802.11b/CH01, CH06, CH11		

Test Channel	Frequency (MHz)	Bandwidth (MHz)	LIMIT (MHz)
CH01	2412	12.20	>=500KHz
CH06	2437	12.24	>=500KHz
CH11	2462	12.16	>=500KHz

**CH01**

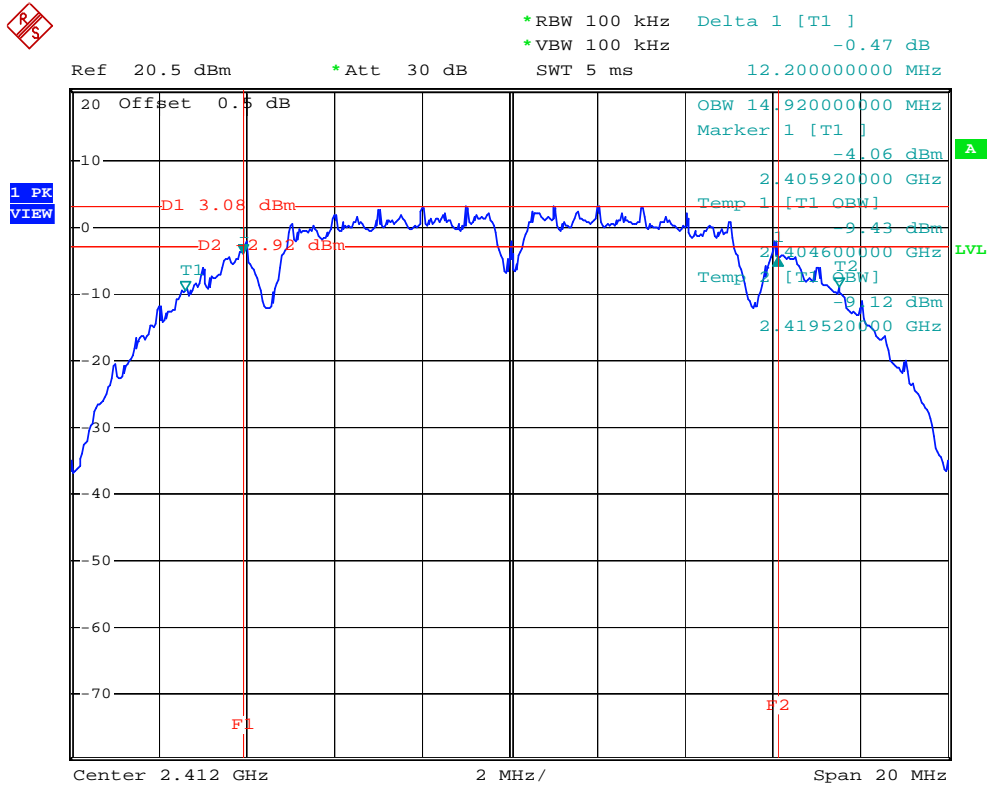



CH06



\*RBW 100 kHz Delta 1 [T1 ]  
 \*VBW 100 kHz -0.01 dB  
 Ref 20.5 dBm \*Att 30 dB SWT 5 ms 12.24000000 MHz

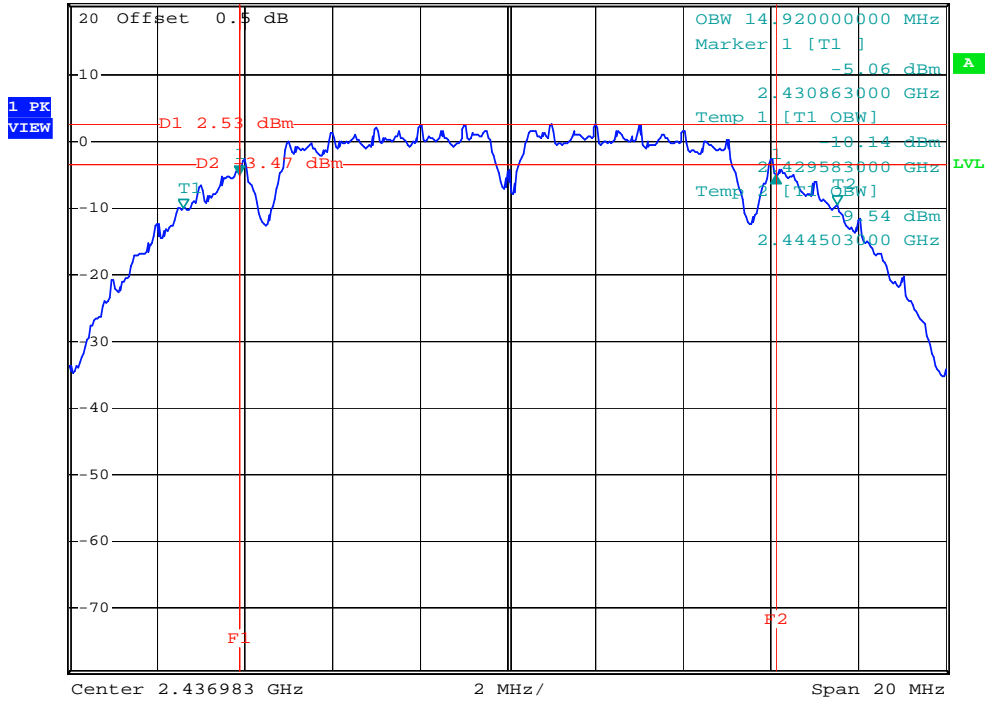

CH11



\*RBW 100 kHz Delta 1 [T1 ]  
 \*VBW 100 kHz -0.50 dB  
 Ref 20.5 dBm \*Att 30 dB SWT 5 ms 12.16000000 MHz

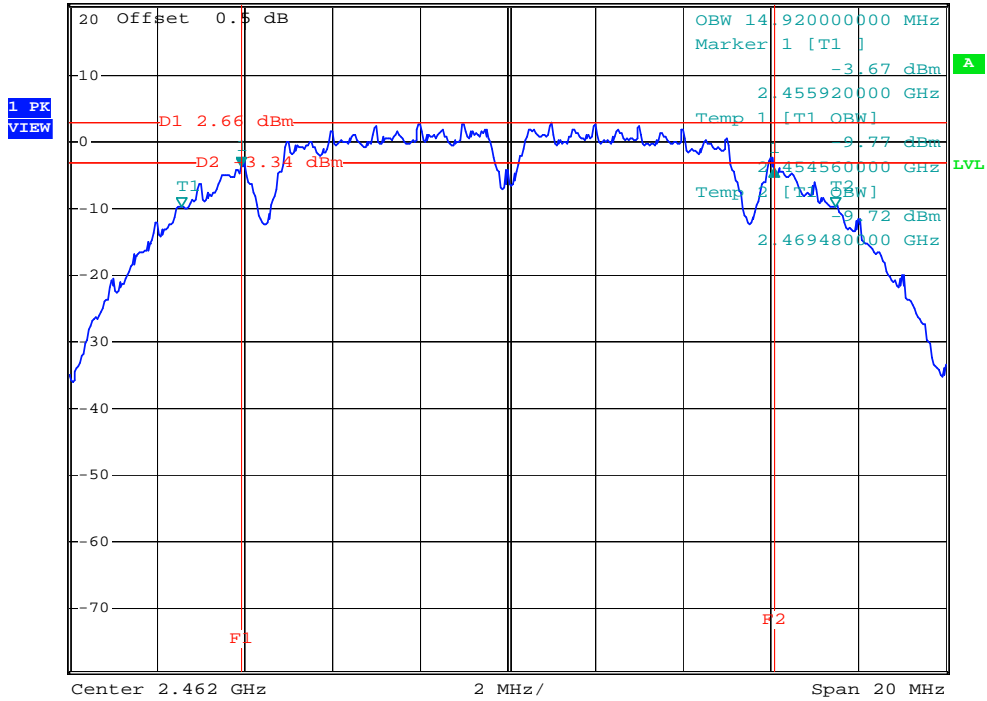



EUT :	N_Max Wireless Access Point	Model Name :	WAP-6010
Temperature :	13 °C	Relative Humidity :	64 %
Test Voltage :	AC 120V/60Hz		
Test Mode :	802.11g/CH01, CH06, CH11		

Test Channel	Frequency (MHz)	Bandwidth (MHz)	LIMIT (MHz)
CH01	2412	16.40	>=500KHz
CH06	2437	16.40	>=500KHz
CH11	2462	16.44	>=500KHz

**CH01**

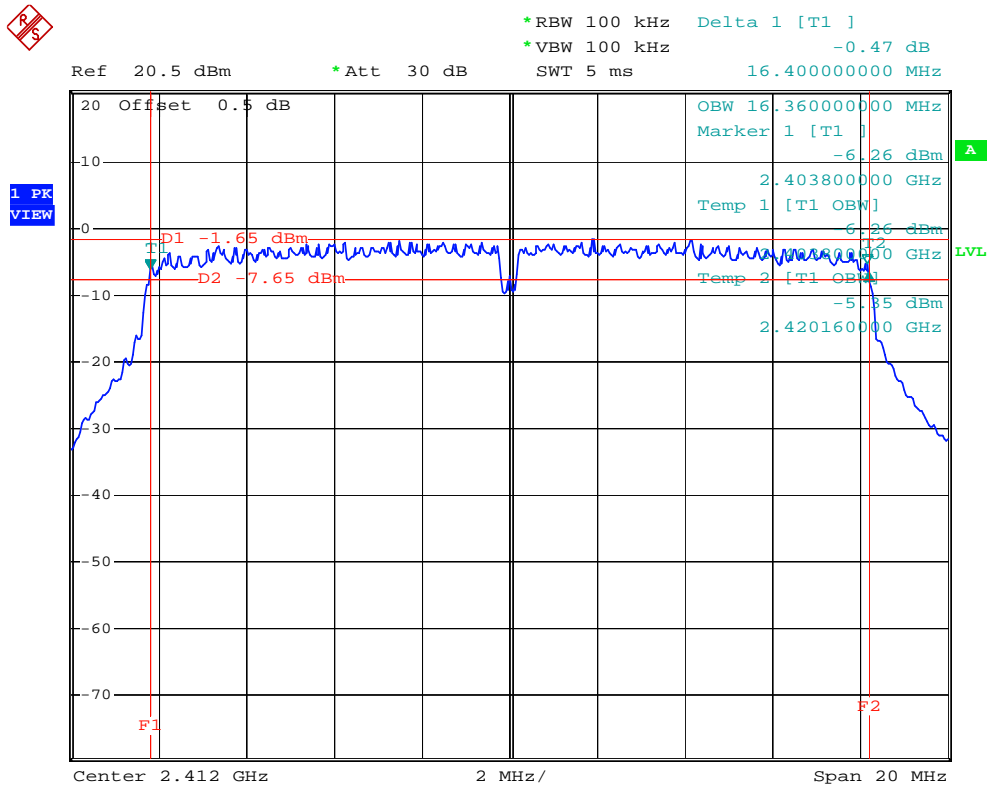



CH06



\*RBW 100 kHz Delta 1 [T1 ]  
 \*VBW 100 kHz 0.43 dB  
 Ref 20.5 dBm \*Att 30 dB SWT 5 ms 16.400000000 MHz

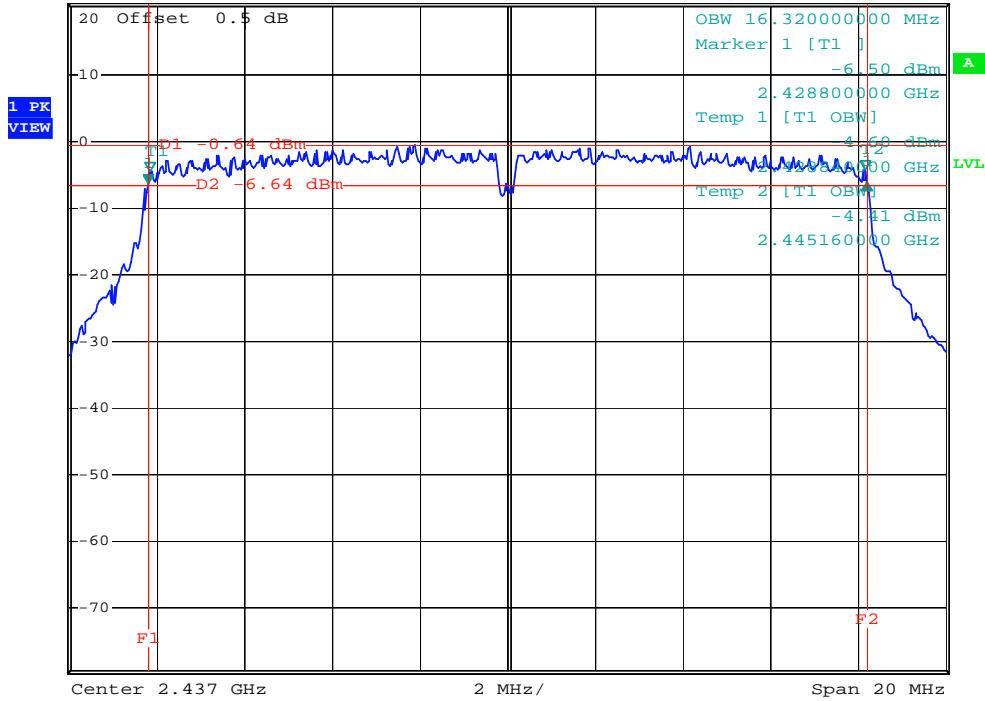

CH11



\*RBW 100 kHz Delta 1 [T1 ]  
 \*VBW 100 kHz 0.15 dB  
 Ref 20.5 dBm \*Att 30 dB SWT 5 ms 16.440000000 MHz

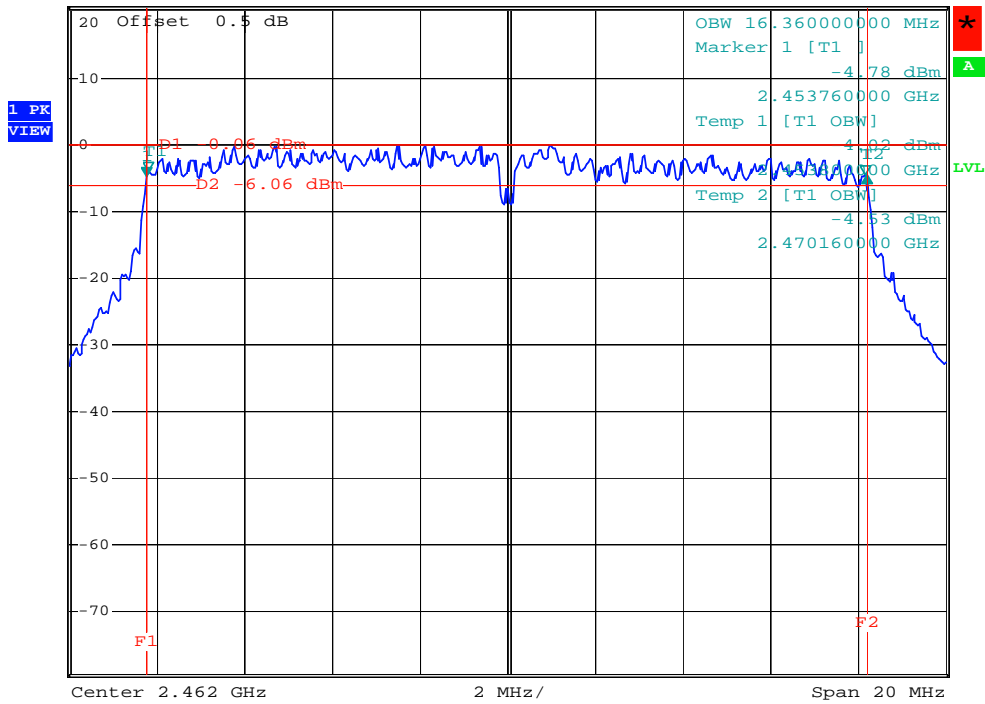



EUT :	N_Max Wireless Access Point	Model Name :	WAP-6010
Temperature :	13 °C	Relative Humidity :	64 %
Test Voltage :	AC 120V/60Hz		
Test Mode :	802.11n/20M/CH01, CH06, CH11 (Port. 0)		

Test Channel	Frequency (MHz)	Bandwidth (MHz)	LIMIT (MHz)
CH01	2412	17.60	>=500KHz
CH06	2437	17.56	>=500KHz
CH11	2462	17.56	>=500KHz

**CH01**

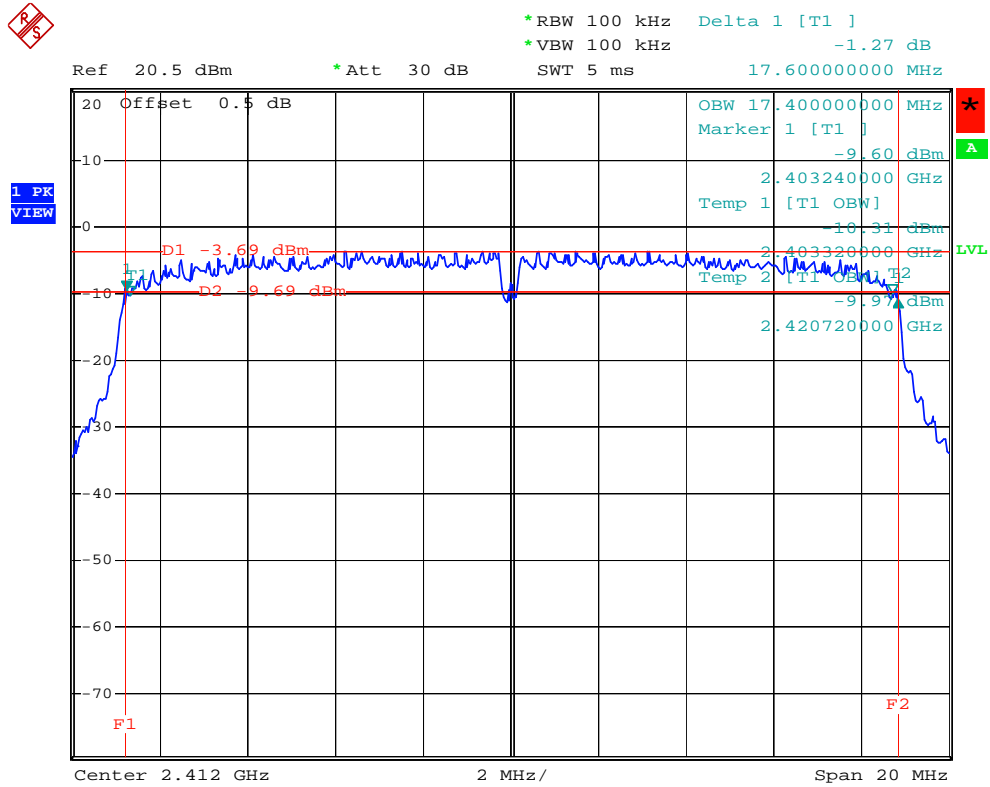



### CH06



\*RBW 100 kHz Delta 1 [T1 ]  
\*VBW 100 kHz -0.14 dB  
Ref 20.5 dBm \*Att 30 dB SWT 5 ms 17.560000000 MHz

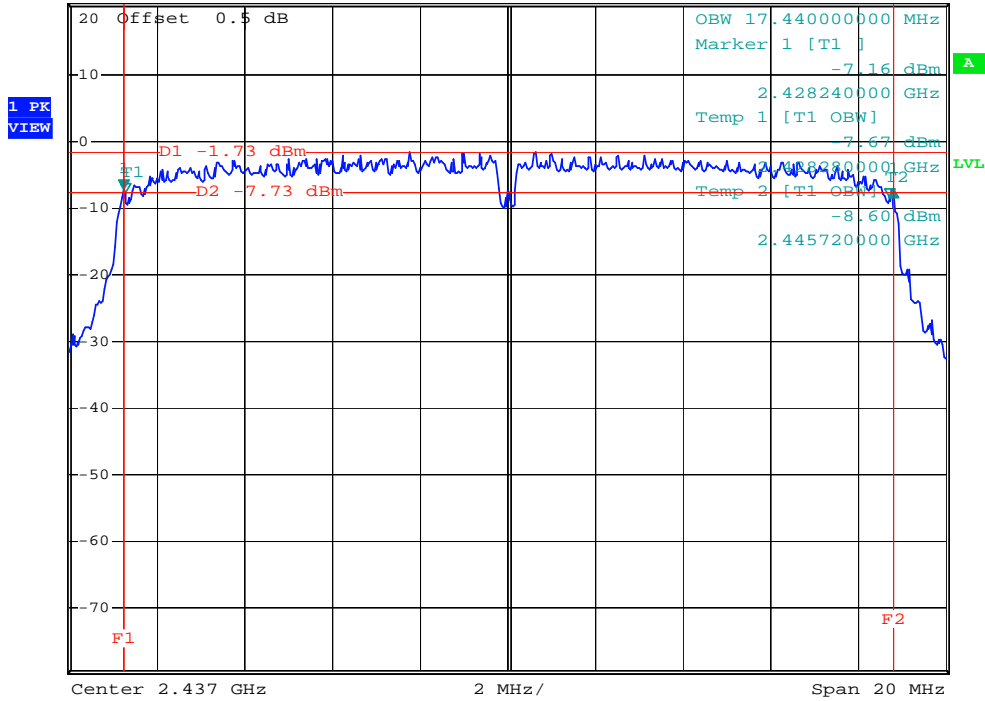

### CH11



\*RBW 100 kHz Delta 1 [T1 ]  
\*VBW 100 kHz 0.64 dB  
Ref 20.5 dBm \*Att 30 dB SWT 5 ms 17.560000000 MHz

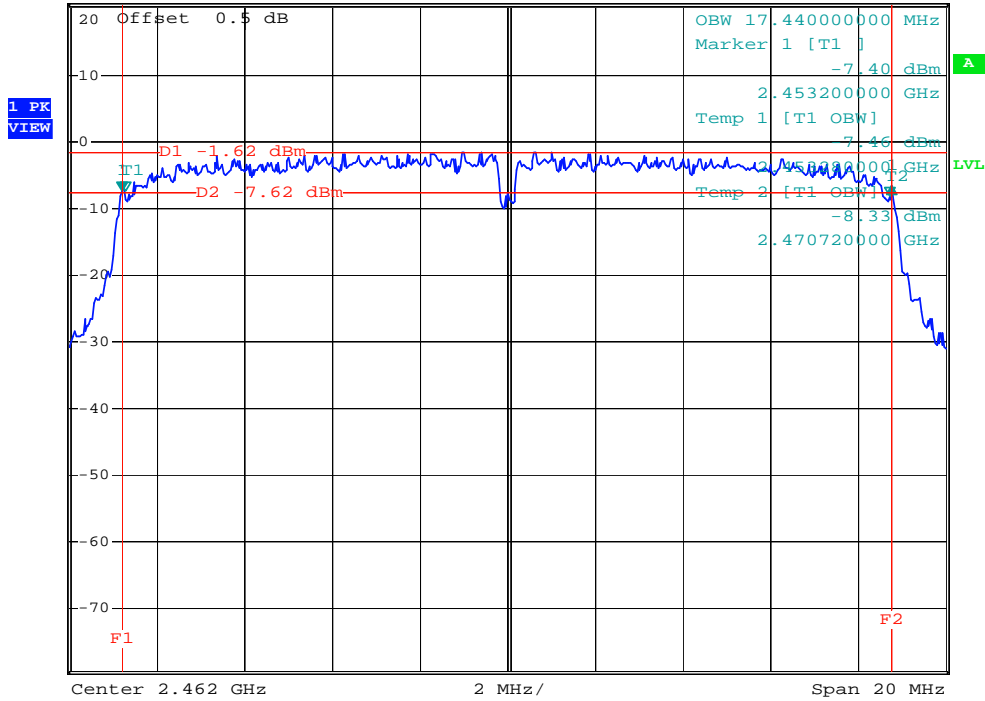



EUT :	N_Max Wireless Access Point	Model Name :	WAP-6010
Temperature :	13 °C	Relative Humidity :	64 %
Test Voltage :	AC 120V/60Hz		
Test Mode :	802.11n/20M/CH01, CH06, CH11 (Port. 1)		

Test Channel	Frequency (MHz)	Bandwidth (MHz)	LIMIT (MHz)
CH01	2412	17.00	>=500KHz
CH06	2437	17.32	>=500KHz
CH11	2462	17.52	>=500KHz

**CH01**

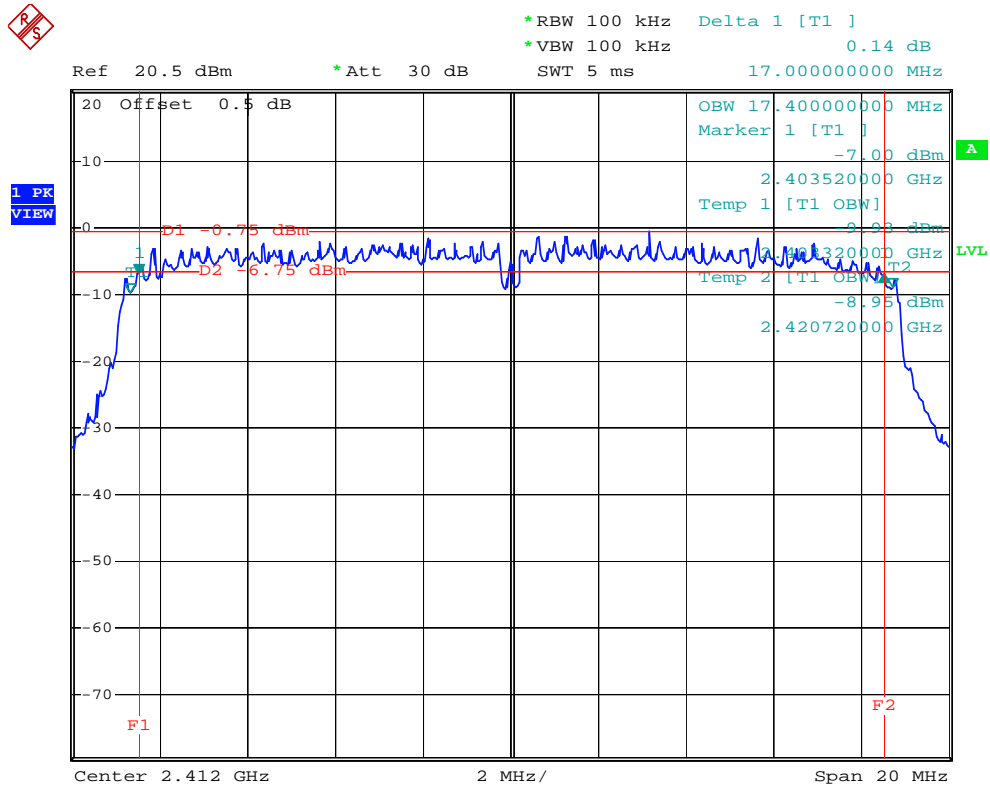



CH06



\*RBW 100 kHz Delta 1 [T1 ]  
 \*VBW 100 kHz -0.40 dB  
 Ref 20.5 dBm \*Att 30 dB SWT 5 ms 17.32000000 MHz

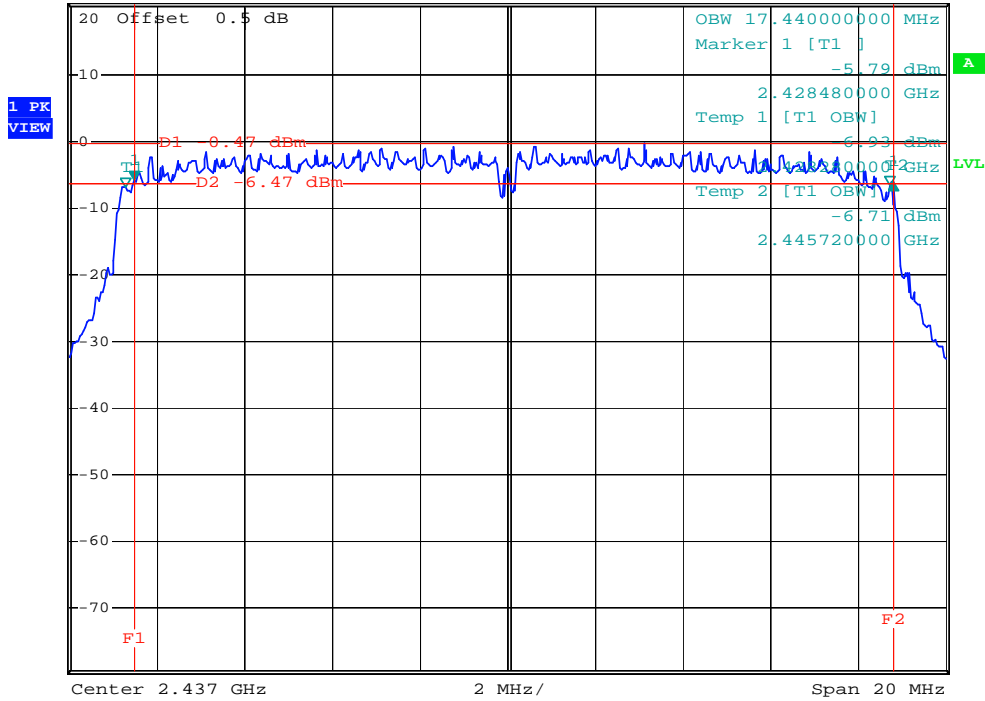

CH11



\*RBW 100 kHz Delta 1 [T1 ]  
 \*VBW 100 kHz 0.03 dB  
 Ref 20.5 dBm \*Att 30 dB SWT 5 ms 17.52000000 MHz

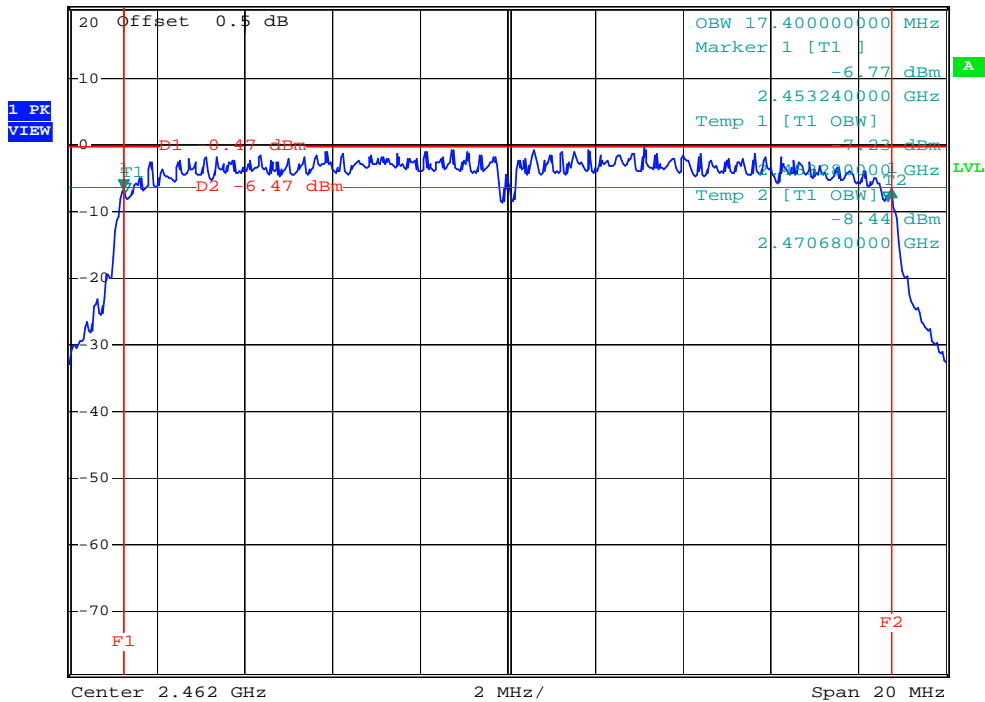





EUT :	N_Max Wireless Access Point	Model Name :	WAP-6010
Temperature :	13 °C	Relative Humidity :	64 %
Test Voltage :	AC 120V/60Hz		
Test Mode :	802.11n/40M/CH03, CH06, CH09 (Port. 0)		

Test Channel	Frequency (MHz)	Bandwidth (MHz)	LIMIT (MHz)
CH03	2422	35.84	>=500KHz
CH06	2437	35.68	>=500KHz
CH09	2452	35.76	>=500KHz

**CH03**

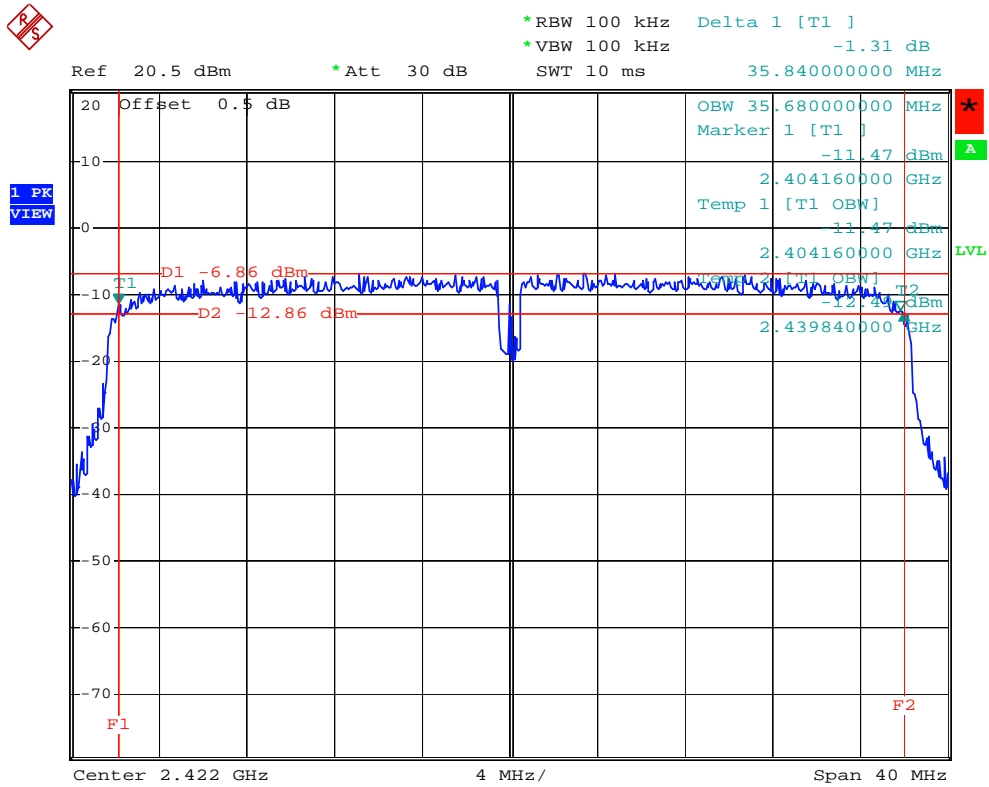



CH06



\*RBW 100 kHz Delta 1 [T1 ]  
 \*VBW 100 kHz -0.36 dB  
 Ref 20.5 dBm \*Att 30 dB SWT 10 ms 35.680000000 MHz

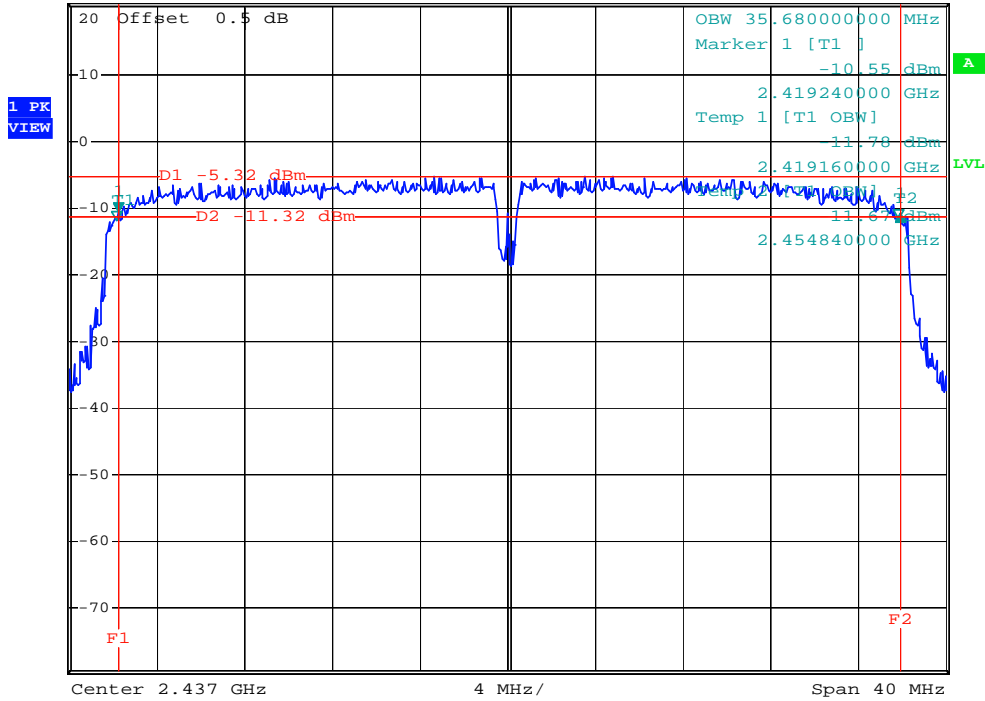

CH09



\*RBW 100 kHz Delta 1 [T1 ]  
 \*VBW 100 kHz -1.78 dB  
 Ref 20.5 dBm \*Att 30 dB SWT 10 ms 35.760000000 MHz

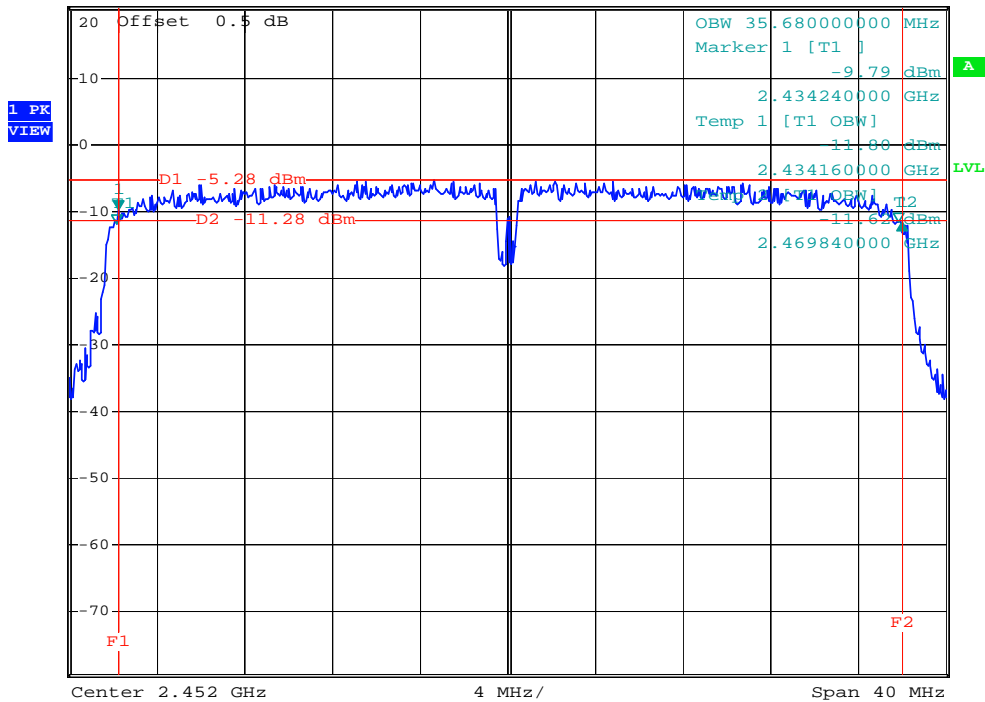



EUT :	N_Max Wireless Access Point	Model Name :	WAP-6010
Temperature :	13 °C	Relative Humidity :	64 %
Test Voltage :	AC 120V/60Hz		
Test Mode :	802.11n/40M/CH03, CH06, CH09 (Port. 1)		

Test Channel	Frequency (MHz)	Bandwidth (MHz)	LIMIT (MHz)
CH03	2422	35.12	>=500KHz
CH06	2437	35.20	>=500KHz
CH09	2452	35.20	>=500KHz

**CH03**

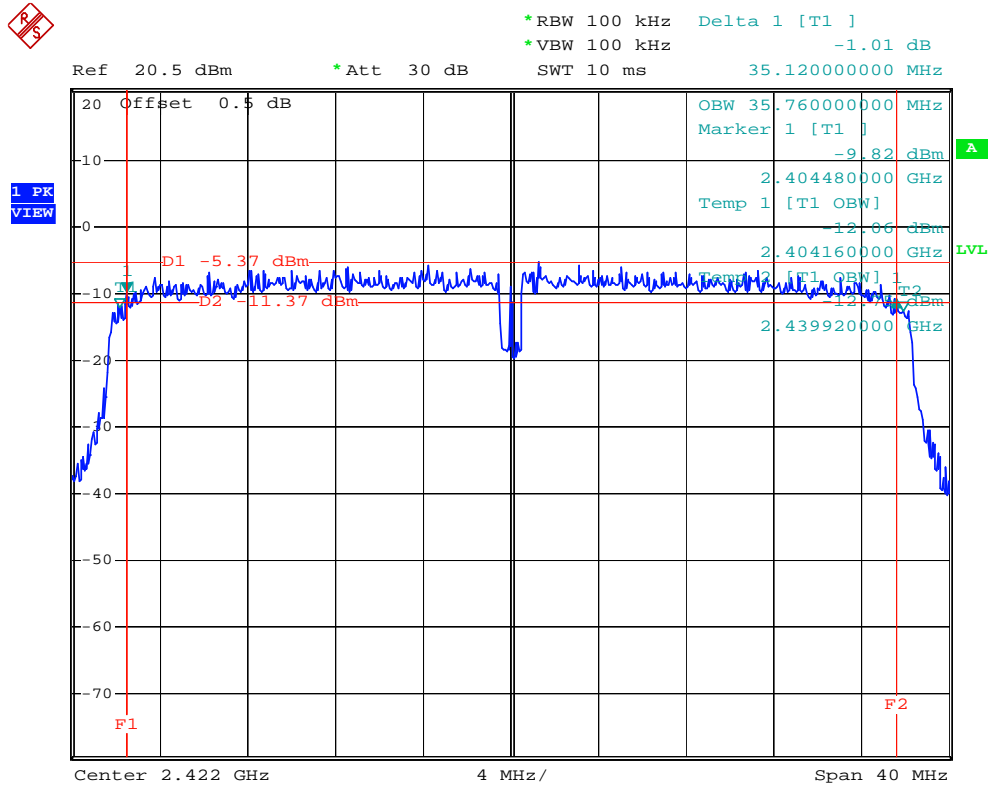



CH06



\*RBW 100 kHz Delta 1 [T1 ]  
 \*VBW 100 kHz 0.33 dB  
 Ref 20.5 dBm \*Att 30 dB SWT 10 ms 35.20000000 MHz

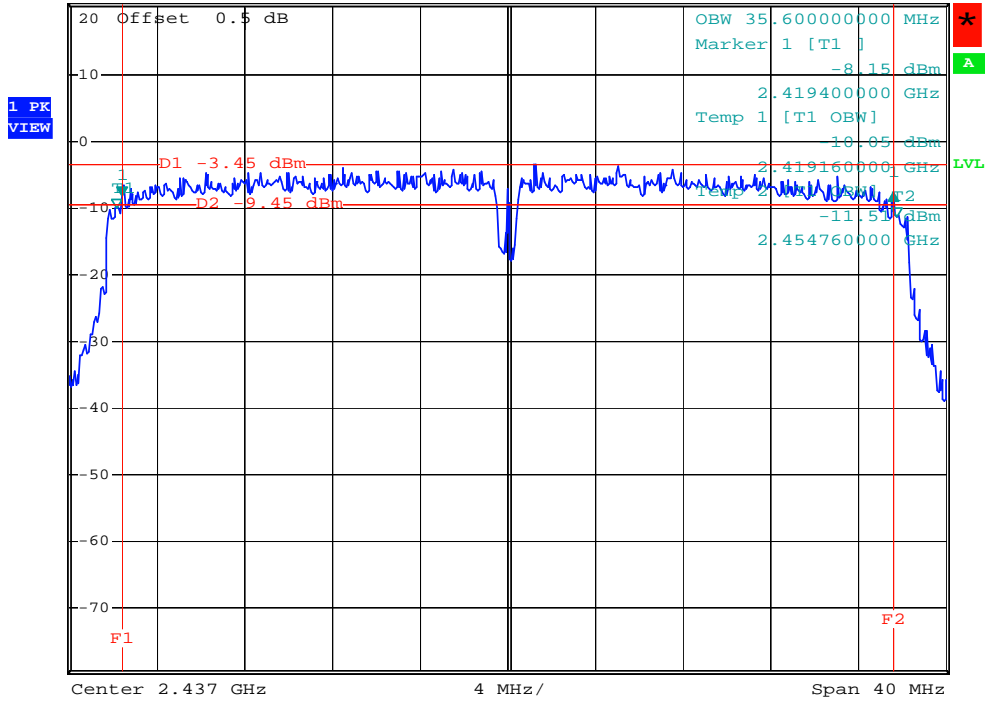

CH09



\*RBW 100 kHz Delta 1 [T1 ]  
 \*VBW 100 kHz -2.24 dB  
 Ref 20.5 dBm \*Att 30 dB SWT 10 ms 35.20000000 MHz

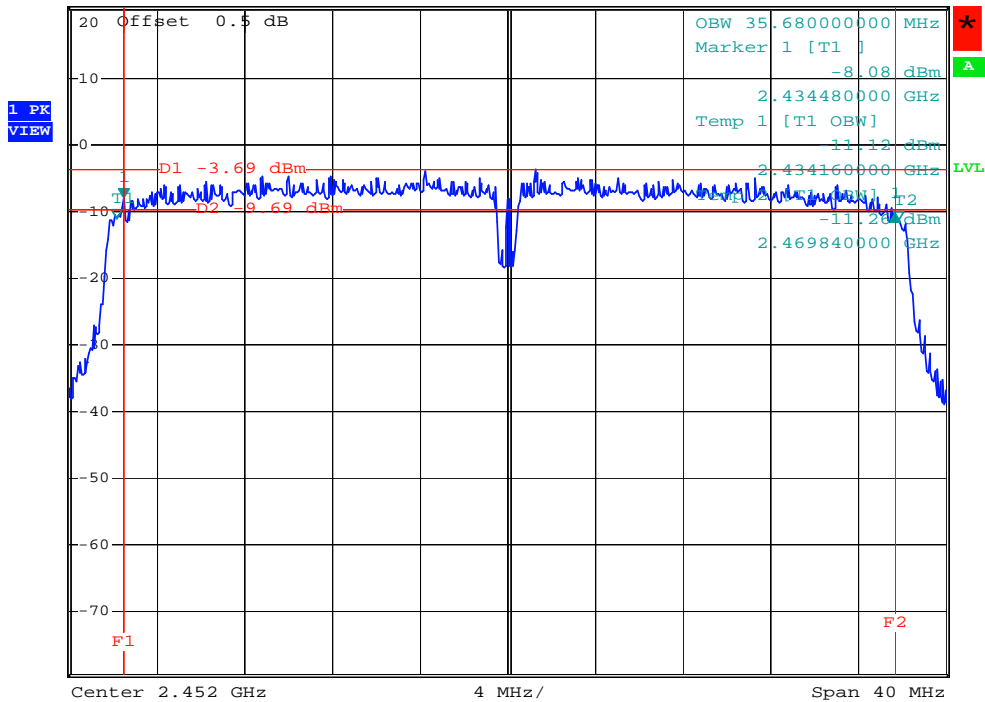



**6. PEAK OUTPUT POWER TEST**

**6.1 APPLIED PROCEDURES / LIMIT**

FCC Part15, Subpart C			
Test Item	Limit	Frequency Range (MHz)	Result
Peak Output Power	1 watt or 30dBm	2400-2483.5	PASS

**6.1.1 MEASUREMENT INSTRUMENTS LIST**

Item	Kind of Equipment	Manufacturer	Type No.	Serial No.	Calibrated until
1	Power Meter	Anritsu	ML2487A	6K00004714	Feb. 12, 2009
2	Power Meter Sensor	Anritsu	MA2491A	34138	Feb. 12, 2009

Remark: " N/A" denotes No Model Name , Serial No. or No Calibration specified.

**6.1.2 TEST PROCEDURE**

- a. The EUT was directly connected to the spectrum analyzer and antenna output port as show in the block diagram below,
- b. Spectrum Setting : RBW= 1MHz, VBW= 1MHz, Sweep time = Auto.

**6.1.3 DEVIATION FROM STANDARD**

No deviation.

**6.1.4 TEST SETUP**

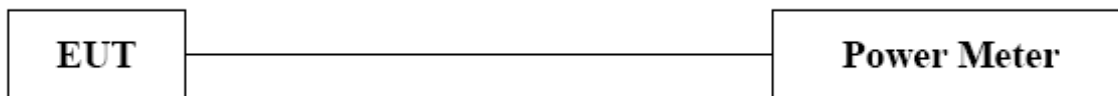

**6.1.5 EUT OPERATION CONDITIONS**

The EUT tested system was configured as the statements of 4.1.6 Unless otherwise a special operating condition is specified in the follows during the testing.



**6.1.6 TEST RESULTS**

EUT :	N_Max Wireless Access Point	Model Name :	WAP-6010
Temperature :	13 °C	Relative Humidity :	64 %
Test Voltage :	AC 120V/60Hz		
Test Mode :	802.11b/CH01, CH06, CH11		

Test Channel	Frequency (MHz)	Peak Output Power (dBm)	LIMIT (dBm)	LIMIT (W)
CH01	2412	18.50	30	1
CH06	2437	18.60	30	1
CH11	2462	18.68	30	1

EUT :	N_Max Wireless Access Point	Model Name :	WAP-6010
Temperature :	13 °C	Relative Humidity :	64 %
Test Voltage :	AC 120V/60Hz		
Test Mode :	802.11g/CH01, CH06, CH11		

Test Channel	Frequency (MHz)	Peak Output Power (dBm)	LIMIT (dBm)	LIMIT (W)
CH01	2412	24.52	30	1
CH06	2437	25.82	30	1
CH11	2462	25.27	30	1



EUT :	N_Max Wireless Access Point	Model Name :	WAP-6010
Temperature :	13 °C	Relative Humidity :	64 %
Test Voltage :	AC 120V/60Hz		
Test Mode :	802.11n/20M/CH01, CH06, CH11		

<b>Port. 0</b>					
Test Channel	Frequency (MHz)	Peak Output Power		LIMIT (dBm)	LIMIT (W)
		(dBm)	(W)		
CH01	2412	21.94	0.1563	30	1
CH06	2437	23.25	0.2113	30	1
CH11	2462	24.26	0.2667	30	1

<b>Port. 1</b>					
Test Channel	Frequency (MHz)	Peak Output Power		LIMIT (dBm)	LIMIT (W)
		(dBm)	(W)		
CH01	2412	22.51	0.1782	30	1
CH06	2437	23.54	0.2259	30	1
CH11	2462	23.73	0.2360	30	1

<b>Total (Port. 0 + Port. 1)</b>					
Test Channel	Frequency (MHz)	Peak Output Power		LIMIT (dBm)	LIMIT (W)
		(dBm)	(W)		
CH01	2412	25.24	0.3346	30	1
CH06	2437	26.41	0.4373	30	1
CH11	2462	27.01	0.5027	30	1

Remark :

- (1) **The MIMO test requirement, RF conducted output power shall measure each transmitter chain by using channel power method.**  
**And after obtain each individual transmitter chain power, then sum the output power by using the following formula:**  

$$((\text{dBm}/\text{Chain 1})/10^{\text{Log}}) + ((\text{dBm}/\text{Chain 2})/10^{\text{log}}) + ((\text{dBm}/\text{ChainN})/10^{\text{log}}) =$$
**Combined peak output power in mW.**
- (2) **Antenna Gain=2dBi.**



EUT :	N_Max Wireless Access Point	Model Name :	WAP-6010
Temperature :	13 °C	Relative Humidity :	64 %
Test Voltage :	AC 120V/60Hz		
Test Mode :	802.11n/40M/CH03, CH06, CH09		

Port. 0					
Test Channel	Frequency (MHz)	Peak Output Power		LIMIT (dBm)	LIMIT (W)
		(dBm)	(W)		
CH03	2422	20.66	0.1164	29.42	0.8750
CH06	2437	22.48	0.1770	29.42	0.8750
CH09	2452	22.75	0.1884	29.42	0.8750

Port. 1					
Test Channel	Frequency (MHz)	Peak Output Power		LIMIT (dBm)	LIMIT (W)
		(dBm)	(W)		
CH03	2422	20.56	0.1138	29.42	0.8750
CH06	2437	22.87	0.1936	29.42	0.8750
CH09	2452	22.04	0.1600	29.42	0.8750

Total (Port. 0 + Port. 1)					
Test Channel	Frequency (MHz)	Peak Output Power		LIMIT (dBm)	LIMIT (W)
		(dBm)	(W)		
CH03	2422	23.62	0.2302	30	1
CH06	2437	25.69	0.3707	30	1
CH09	2452	25.42	0.3483	30	1

Remark :

- (1) The MIMO test requirement, RF conducted output power shall measure each transmitter chain by using channel power method.  
And after obtain each individual transmitter chain power, then sum the output power by using the following formula:  

$$((\text{dBm}/\text{Chain 1})/10^{\text{Log}}) + ((\text{dBm}/\text{Chain 2})/10^{\text{Log}}) + ((\text{dBm}/\text{Chain N})/10^{\text{Log}}) =$$
**Combined peak output power in mW.**
- (2) Antenna Gain=2dBi.





**7. ANTENNA CONDUCTED SPURIOUS EMISSION**

**7.1 APPLIED PROCEDURES / LIMIT**

FCC Part15, Subpart C			
Test Item	Limit	Frequency Range (MHz)	Result
Antenna conducted Spurious Emission	20dB less than the peak value of fundamental frequency	30-25000	PASS

**7.1.1 MEASUREMENT INSTRUMENTS LIST**

Item	Kind of Equipment	Manufacturer	Type No.	Serial No.	Calibrated until
1	Spectrum Analyzer	R&S	FSP-40	100129	Sep. 9, 2009

Remark: " N/A" denotes No Model Name , Serial No. or No Calibration specified.

**7.1.2 TEST PROCEDURE**

- a. The EUT was directly connected to the spectrum analyzer and antenna output port as show in the block diagram below,
- b. Spectrum Setting : RBW= 100KHz, VBW=100KHz, Sweep time = Auto.

**7.1.3 DEVIATION FROM STANDARD**

No deviation.

**7.1.4 TEST SETUP**

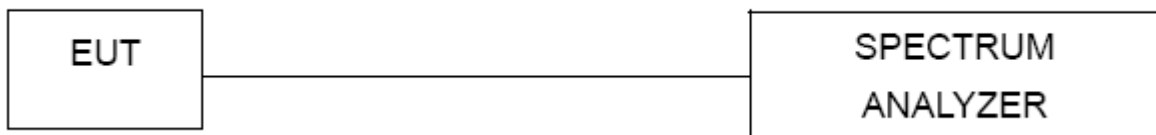

**7.1.5 EUT OPERATION CONDITIONS**

The EUT tested system was configured as the statements of 4.1.6 Unless otherwise a special operating condition is specified in the follows during the testing.



**7.1.6 TEST RESULTS**

EUT :	N_Max Wireless Access Point	Model Name :	WAP-6010
Temperature :	13 °C	Relative Humidity :	64 %
Test Voltage :	AC 120V/60Hz		
Test Mode :	802.11b/CH01, CH11		

Channel of Worst Data: CH1,CH11			
The max. radio frequency power in any 100kHz bandwidth outside the frequency band		The max. radio frequency power in any 100 kHz bandwidth within the frequency band.	
FREQUENCY(MHz)	POWER(dBm)	FREQUENCY(MHz)	POWER(dBm)
2386.8	-46.60	2487.1	-45.26
Result			
In any 100kHz bandwidth outside the frequency band, the radio frequency power is at least 20dB below that in the 100kHz bandwidth within the band that contains the highest level of the desired power.			

**CH01**

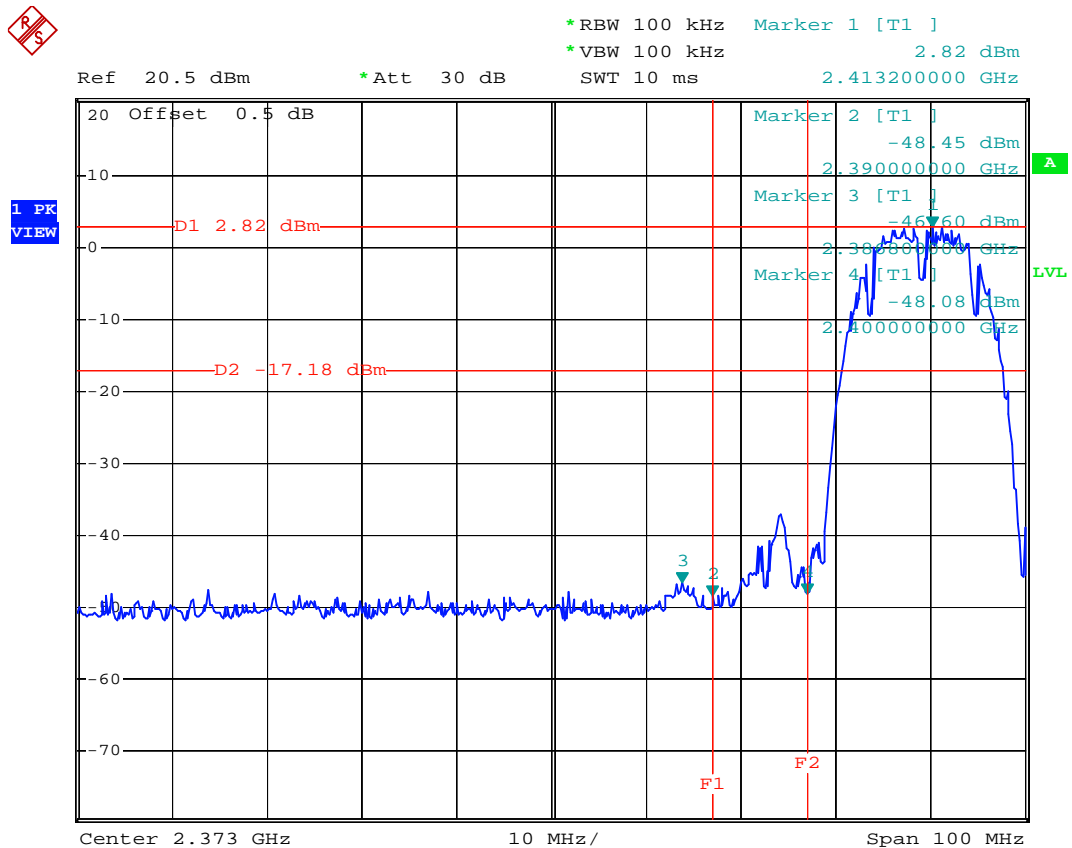



CH11



\*RBW 100 kHz Marker 1 [T1 ]  
\*VBW 100 kHz 2.99 dBm  
SWT 10 ms 2.463000000 GHz

Ref 20.5 dBm \*Att 30 dB

1 PK VIEW

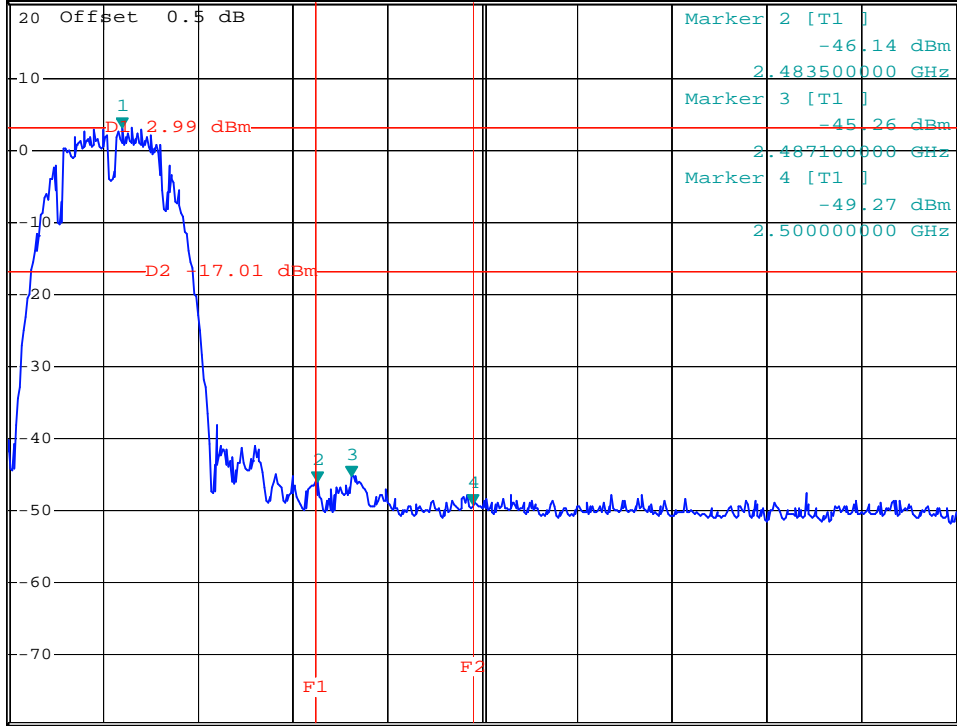

Center 2.501 GHz 10 MHz/ Span 100 MHz



EUT :	N_Max Wireless Access Point	Model Name :	WAP-6010
Temperature :	13 °C	Relative Humidity :	64 %
Test Voltage :	AC 120V/60Hz		
Test Mode :	802.11g/CH01, CH11		

Channel of Worst Data: CH1,CH11			
The max. radio frequency power in any 100kHz bandwidth outside the frequency band		The max. radio frequency power in any 100 kHz bandwidth within the frequency band.	
FREQUENCY(MHz)	POWER(dBm)	FREQUENCY(MHz)	POWER(dBm)
2390.0	-46.82	2483.5	-47.73

**Result**

In any 100kHz bandwidth outside the frequency band, the radio frequency power is at least 20dB below that in the 100kHz bandwidth within the band that contains the highest level of the desired power.

**CH01**

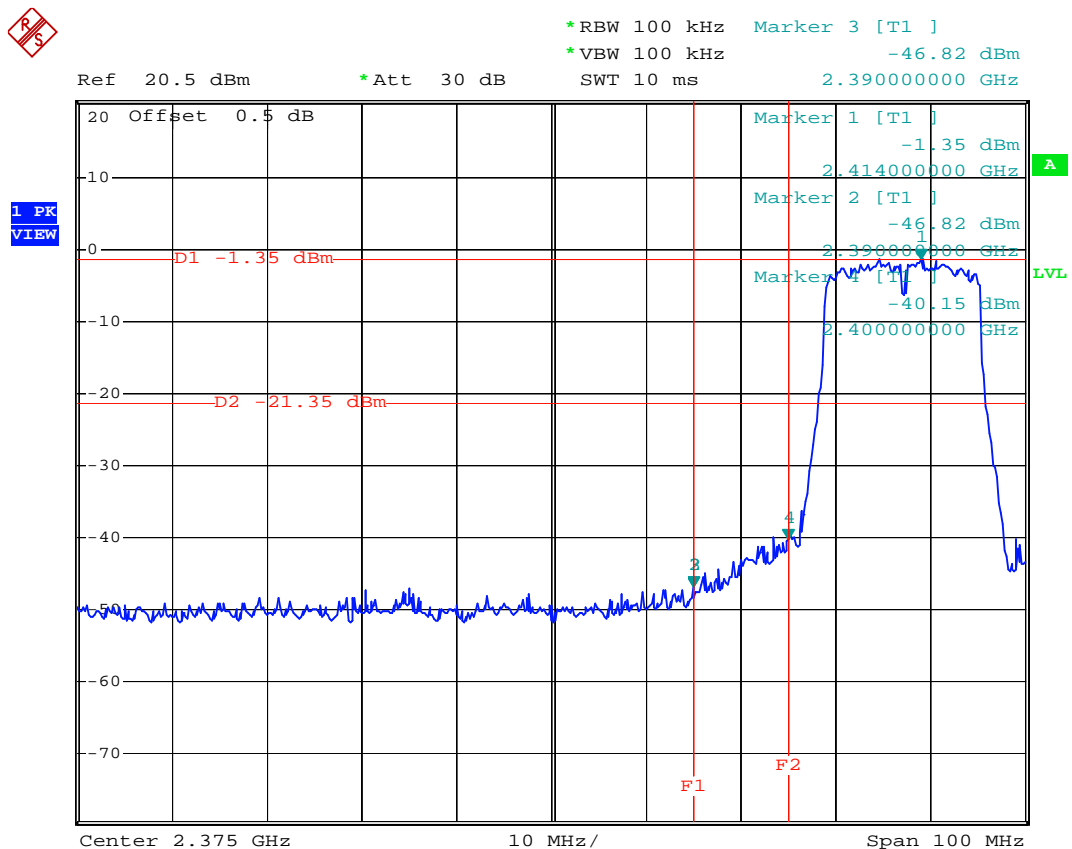



CH11



\*RBW 100 kHz Marker 3 [T1 ]  
\*VBW 100 kHz -45.41 dBm  
SWT 10 ms 2.486300000 GHz

Ref 20.5 dBm \*Att 30 dB

1 PK VIEW

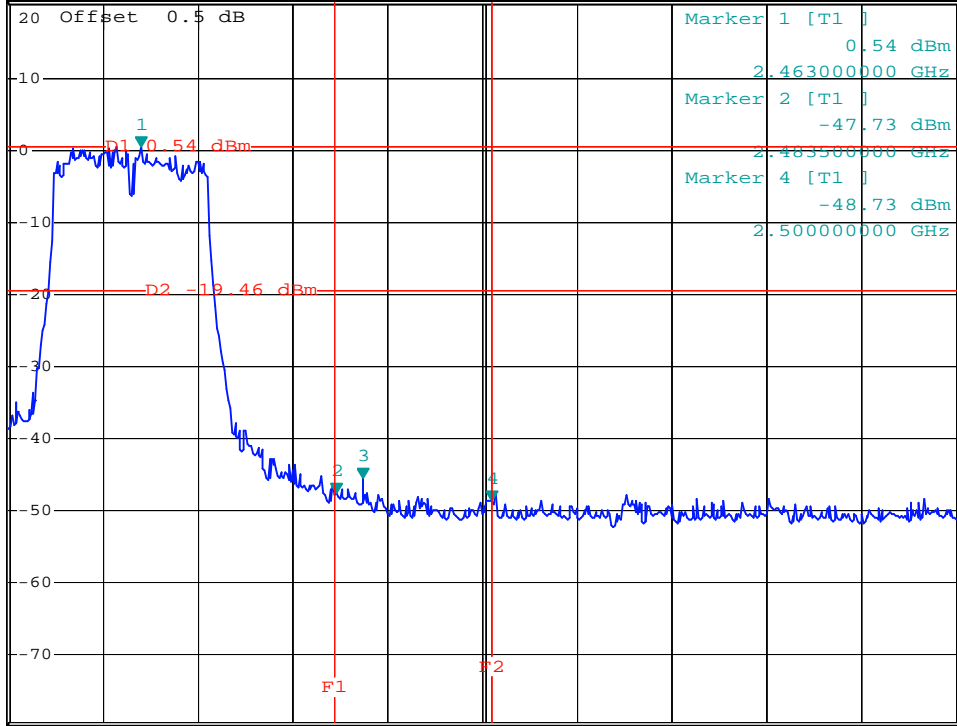

Center 2.499 GHz 10 MHz/ Span 100 MHz



EUT :	N_Max Wireless Access Point	Model Name :	WAP-6010
Temperature :	13 °C	Relative Humidity :	64 %
Test Voltage :	AC 120V/60Hz		
Test Mode :	802.11n/20M/CH01, CH11 (Port 0 + Port 1 )		

Channel of Worst Data: CH1,CH11			
The max. radio frequency power in any 100kHz bandwidth outside the frequency band		The max. radio frequency power in any 100 kHz bandwidth within the frequency band.	
FREQUENCY(MHz)	POWER(dBm)	FREQUENCY(MHz)	POWER(dBm)
2390.0	-48.92	2483.5	-46.62
Result			

In any 100kHz bandwidth outside the frequency band, the radio frequency power is at least 20dB below that in the 100kHz bandwidth within the band that contains the highest level of the desired power.

**CH01(Port 0 + Port 1 )**

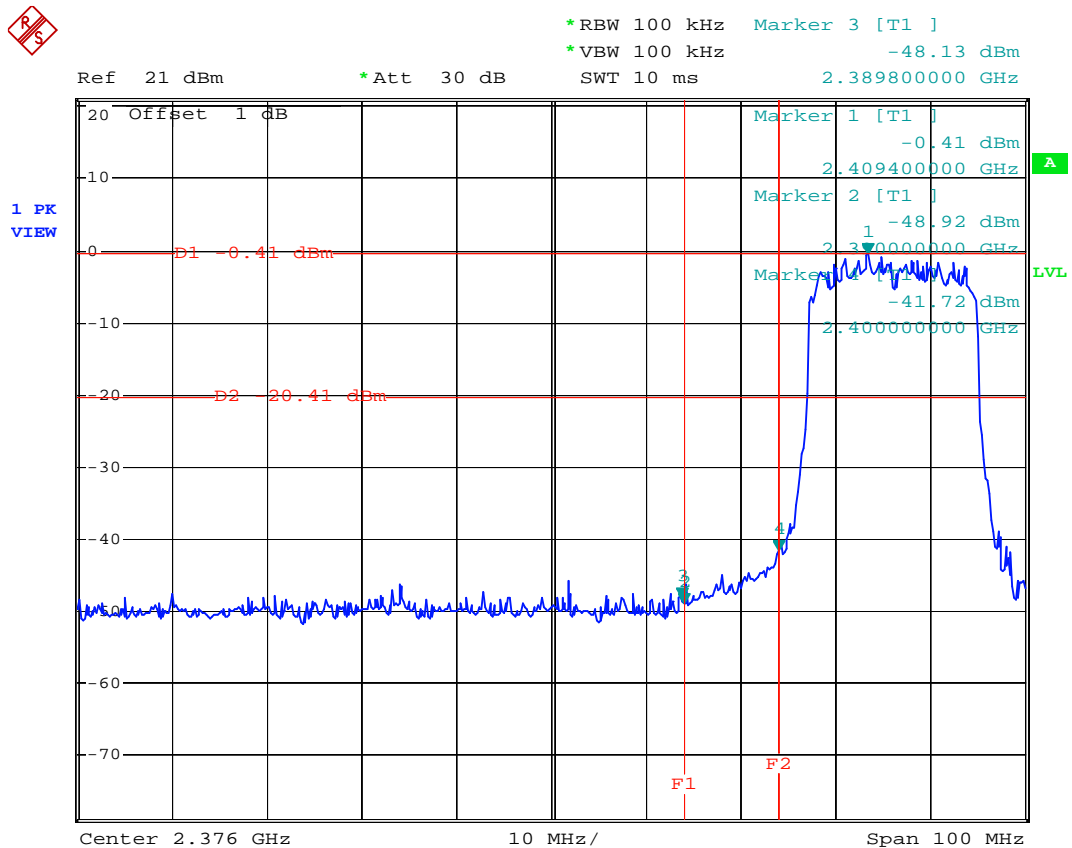



### CH11(Port 0 + Port 1)



\*RBW 100 kHz    Marker 3 [T1 ]  
\*VBW 100 kHz    -47.17 dBm  
SWT 10 ms        2.485900000 GHz

Ref 21 dBm

\*Att 30 dB

1 PK  
VIEW

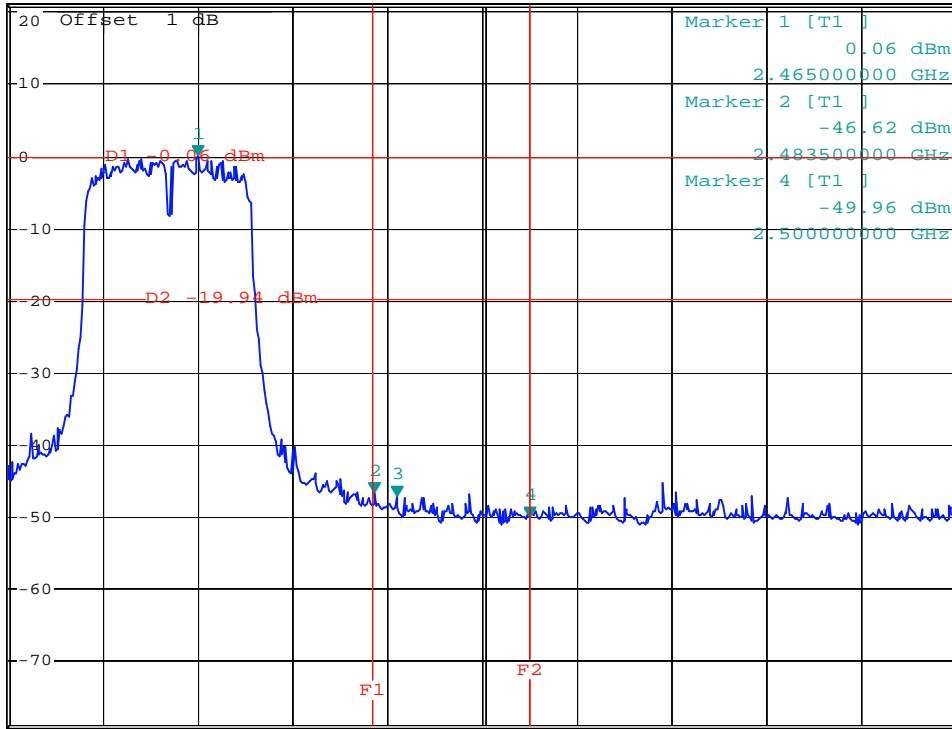

Center 2.495 GHz

10 MHz/

Span 100 MHz



EUT :	N_Max Wireless Access Point	Model Name :	WAP-6010
Temperature :	13 °C	Relative Humidity :	64 %
Test Voltage :	AC 120V/60Hz		
Test Mode :	802.11n/40M/CH03, CH09 (Port 0 + Port 1 )		

Channel of Worst Data: CH1,CH11			
The max. radio frequency power in any 100kHz bandwidth outside the frequency band		The max. radio frequency power in any 100 kHz bandwidth within the frequency band.	
FREQUENCY(MHz)	POWER(dBm)	FREQUENCY(MHz)	POWER(dBm)
2390.0	-43.98	2483.5	-47.19

Result

In any 100kHz bandwidth outside the frequency band, the radio frequency power is at least 20dB below that in the 100kHz bandwidth within the band that contains the highest level of the desired power.

**CH03 (Port 0 + Port 1 )**

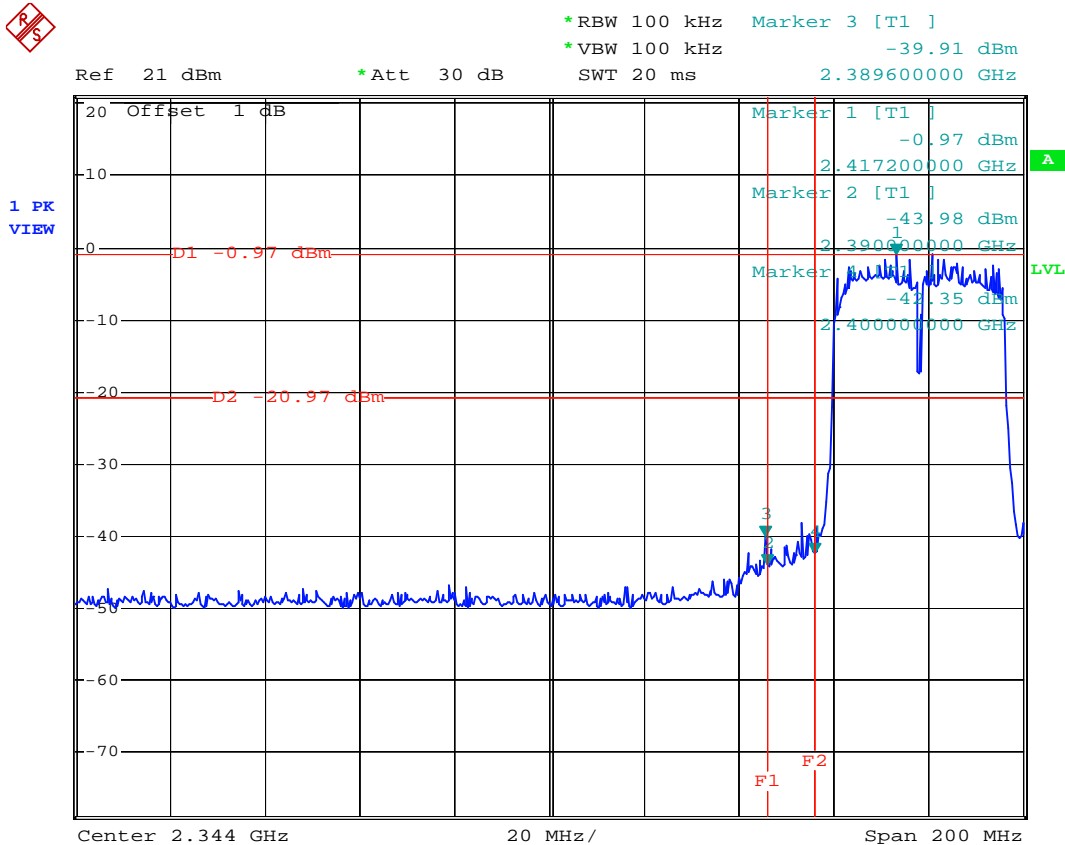





CH09 (Port 0 + Port 1)



\*RBW 100 kHz Marker 3 [T1 ]  
 \*VBW 100 kHz -45.79 dBm  
 SWT 20 ms 2.483900000 GHz

Ref 21 dBm

\*Att 30 dB

1 PK  
VIEW

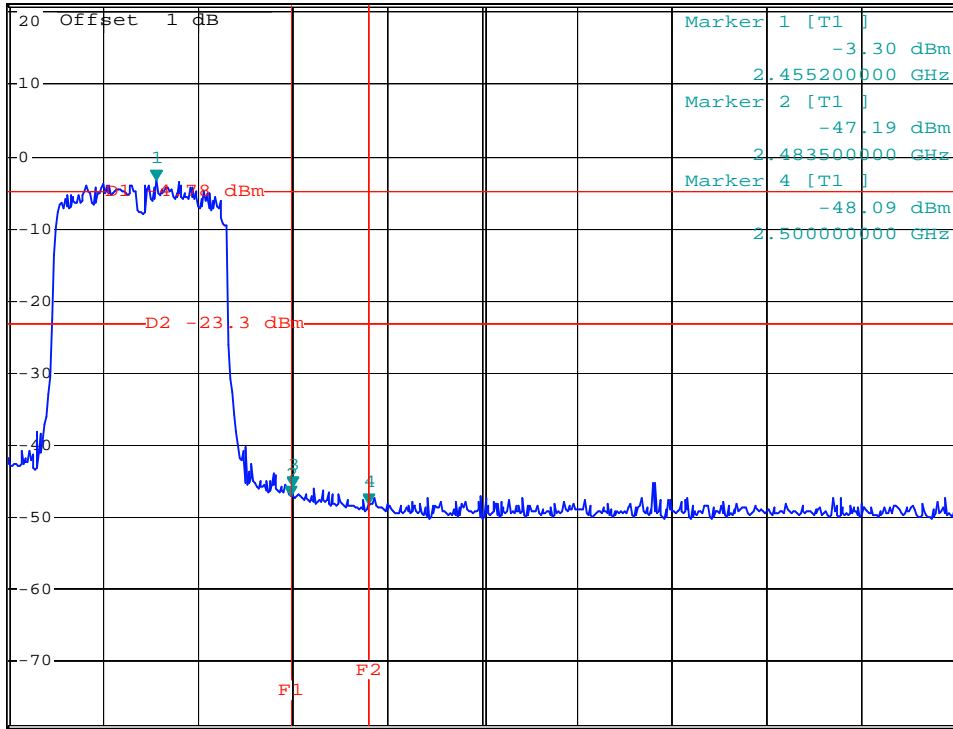

Center 2.524 GHz 20 MHz/ Span 200 MHz



**8. POWER SPECTRAL DENSITY TEST**

**8.1 APPLIED PROCEDURES / LIMIT**

FCC Part15, Subpart C			
Test Item	Limit	Frequency Range (MHz)	Result
Power Spectral Density	8 dBm (in any 3KHz)	2400-2483.5	PASS

**8.1.1 MEASUREMENT INSTRUMENTS LIST**

Item	Kind of Equipment	Manufacturer	Type No.	Serial No.	Calibrated until
1	Spectrum Analyzer	R&S	FSP-40	100129	Sep. 9, 2009

Remark: " N/A" denotes No Model Name, Serial No. or No Calibration specified.

**8.1.2 TEST PROCEDURE**

- a. The EUT was directly connected to the spectrum analyzer and antenna output port as show in the block diagram below,
- b. Spectrum Setting : RBW=3KHz, VBW=30KHz, Sweep time = 500s.

**8.1.3 DEVIATION FROM STANDARD**

No deviation.

**8.1.4 TEST SETUP**

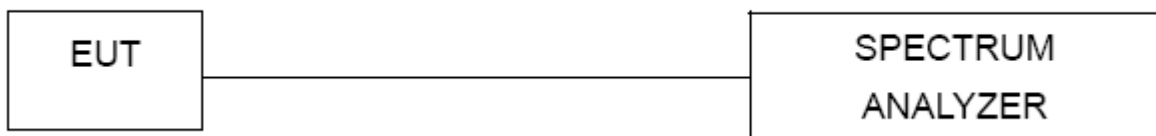

**8.1.5 EUT OPERATION CONDITIONS**

The EUT tested system was configured as the statements of 4.1.6 Unless otherwise a special operating condition is specified in the follows during the testing.



**8.1.6 TEST RESULTS**

EUT :	N_Max Wireless Access Point	Model Name :	WAP-6010
Temperature :	13 °C	Relative Humidity :	64 %
Test Voltage :	AC 120V/60Hz		
Test Mode :	802.11b/CH01, CH06, CH11		

Test Channel	Frequency (MHz)	Power Density (dBm)	LIMIT (dBm)
CH01	2412	-14.93	8
CH06	2437	-14.44	8
CH11	2462	-14.31	8

**CH01**

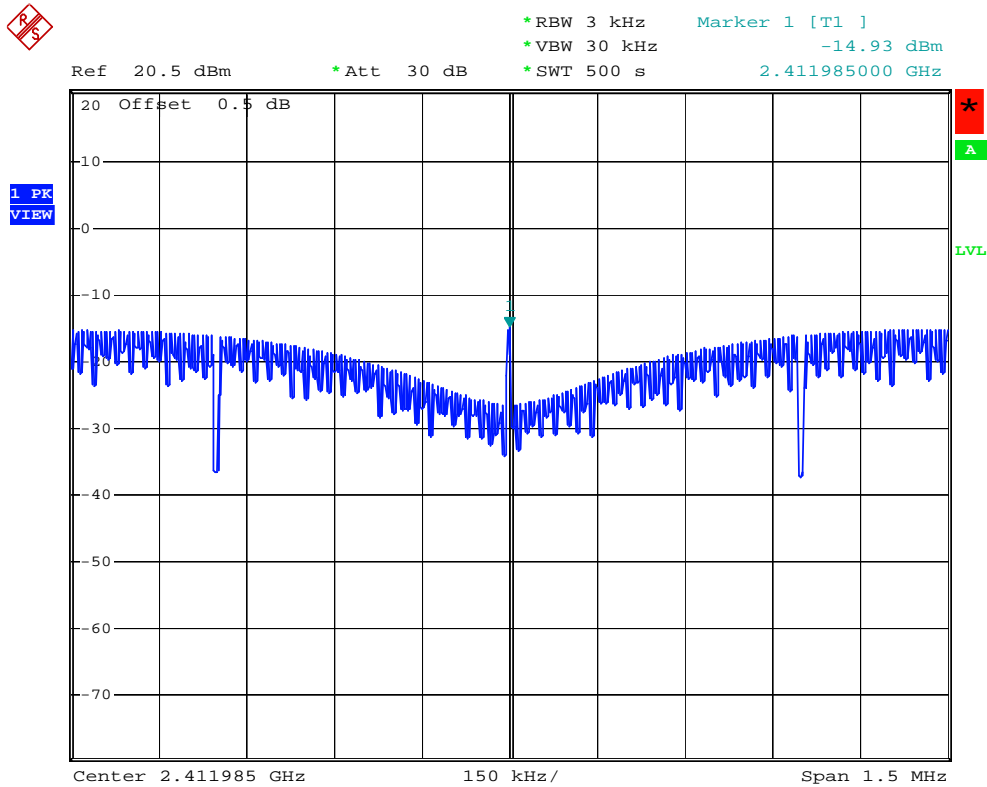



### CH06



\*RBW 3 kHz      Marker 1 [T1 ]  
\*VBW 30 kHz      -14.44 dBm  
\*SWT 500 s      2.436983000 GHz

Ref 20.5 dBm

\*Att 30 dB

1 PK  
VIEW

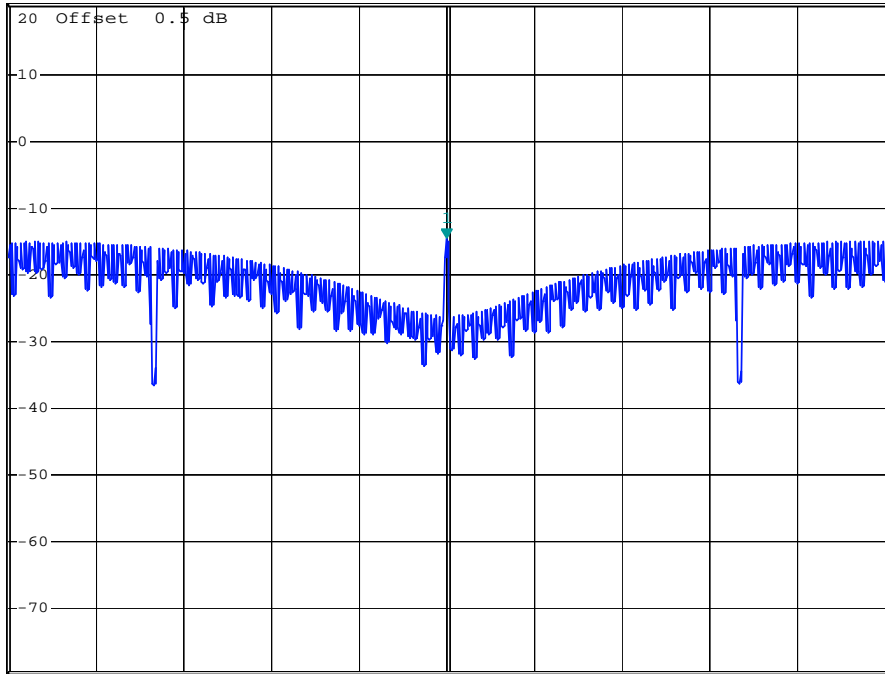

Center 2.436983 GHz      150 kHz/      Span 1.5 MHz

### CH11



\*RBW 3 kHz      Marker 1 [T1 ]  
\*VBW 30 kHz      -14.31 dBm  
\*SWT 500 s      2.461985000 GHz

Ref 20.5 dBm

\*Att 30 dB

1 PK  
VIEW

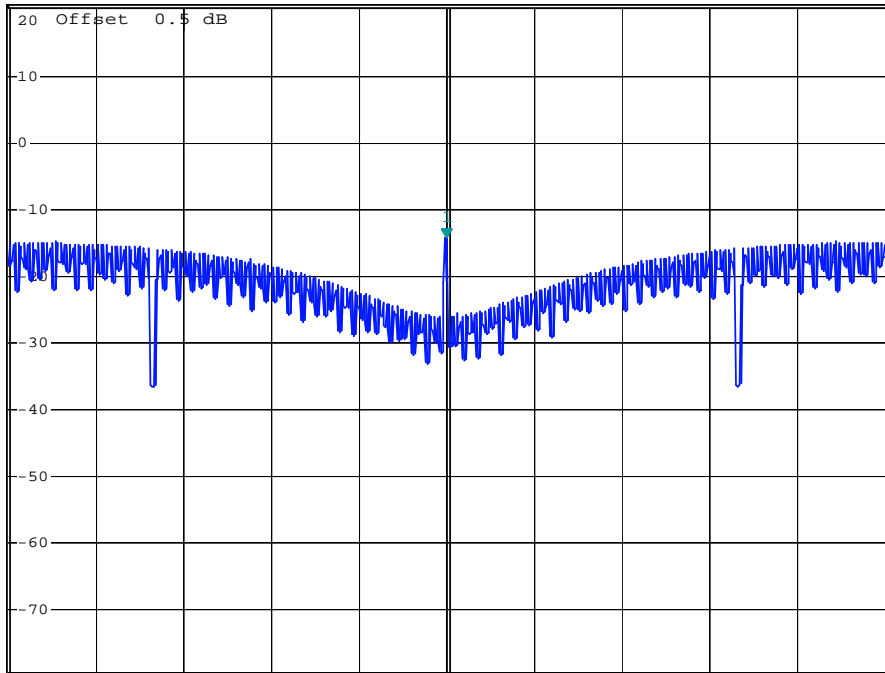

Center 2.461985 GHz      150 kHz/      Span 1.5 MHz



EUT :	N_Max Wireless Access Point	Model Name :	WAP-6010
Temperature :	13 °C	Relative Humidity :	64 %
Test Voltage :	AC 120V/60Hz		
Test Mode :	802.11g/CH01, CH06, CH11		

Test Channel	Frequency (MHz)	Power Density (dBm)	LIMIT (dBm)
CH01	2412	-13.15	8
CH06	2437	-11.34	8
CH11	2462	-12.04	8

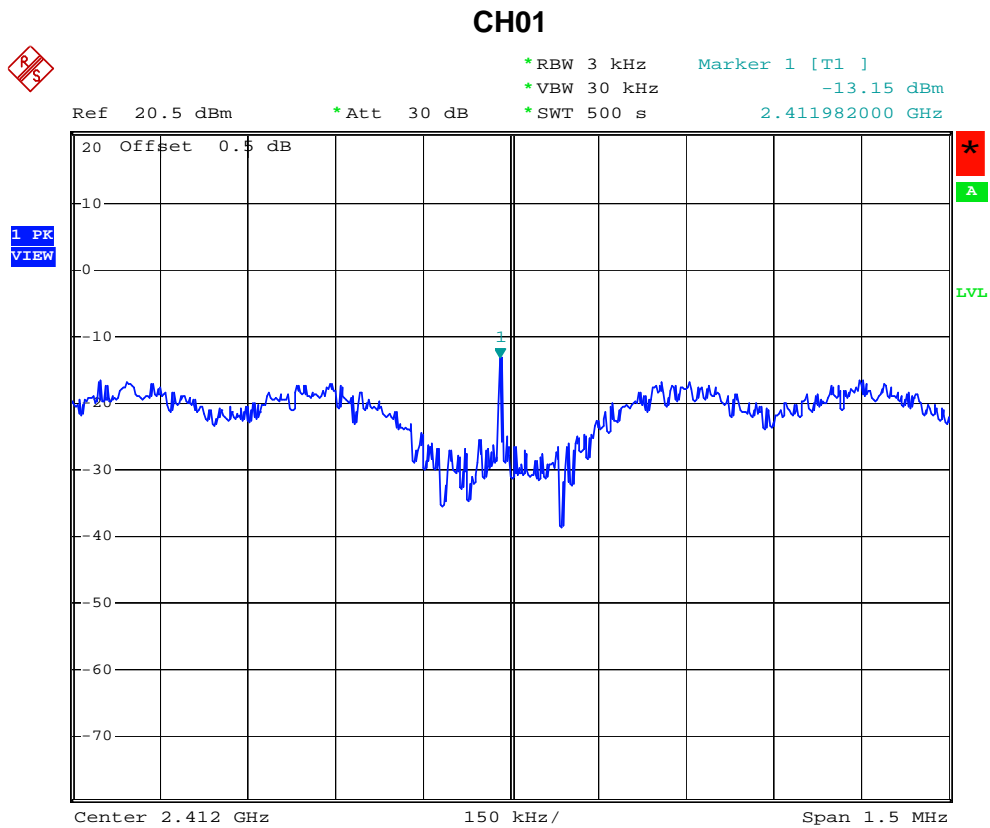



### CH06



\*RBW 3 kHz    Marker 1 [T1 ]  
\*VBW 30 kHz    -11.34 dBm  
\*SWT 500 s    2.436982000 GHz

Ref 20.5 dBm

\*Att 30 dB

1 PK  
VIEW

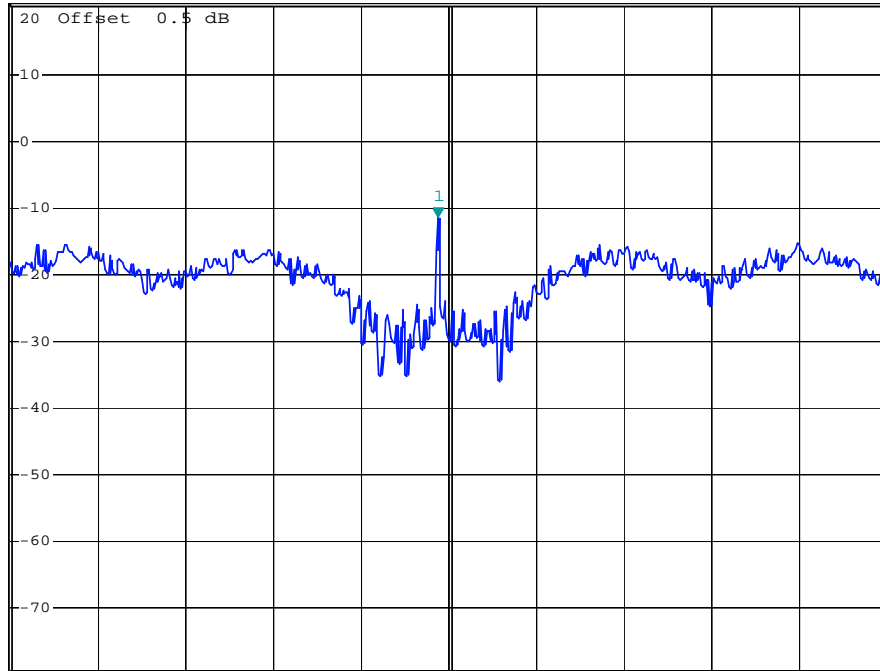

Center 2.437 GHz

150 kHz/

Span 1.5 MHz

### CH11



\*RBW 3 kHz    Marker 1 [T1 ]  
\*VBW 30 kHz    -12.04 dBm  
\*SWT 500 s    2.461982000 GHz

Ref 20.5 dBm

\*Att 30 dB

1 PK  
VIEW

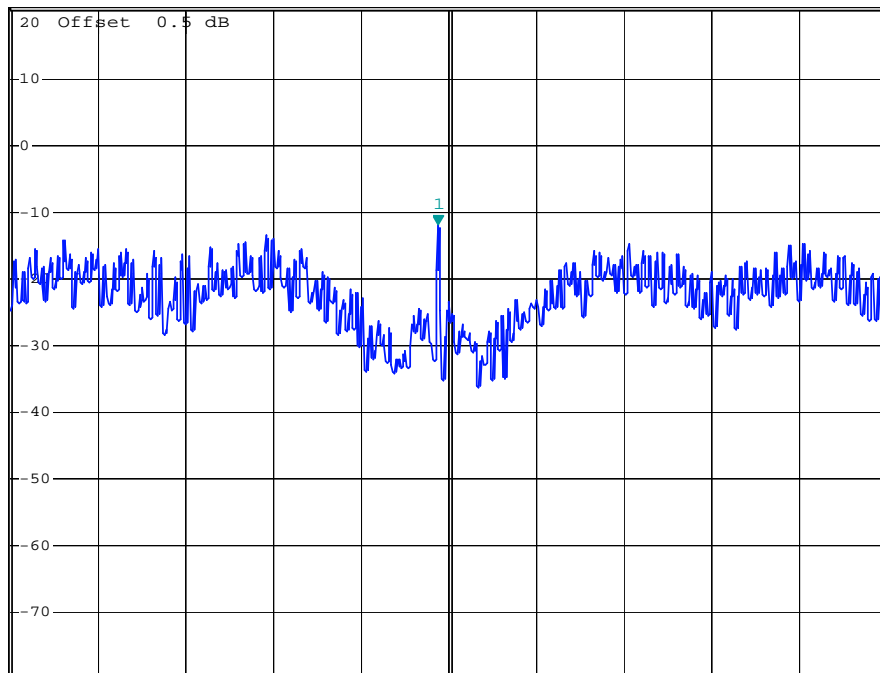

Center 2.462 GHz

150 kHz/

Span 1.5 MHz



EUT :	N_Max Wireless Access Point	Model Name :	WAP-6010
Temperature :	13 °C	Relative Humidity :	64 %
Test Voltage :	AC 120V/60Hz		
Test Mode :	802.11n/20M/CH01, CH06, CH11(Port. 0)		

Test Channel	Frequency (MHz)	Power Density (dBm/3kHz)	Power Density (mW/3kHz)	LIMIT (dBm)
CH01	2412	21.94	0.1563	8
CH06	2437	23.25	0.2113	8
CH11	2462	24.26	0.2667	8

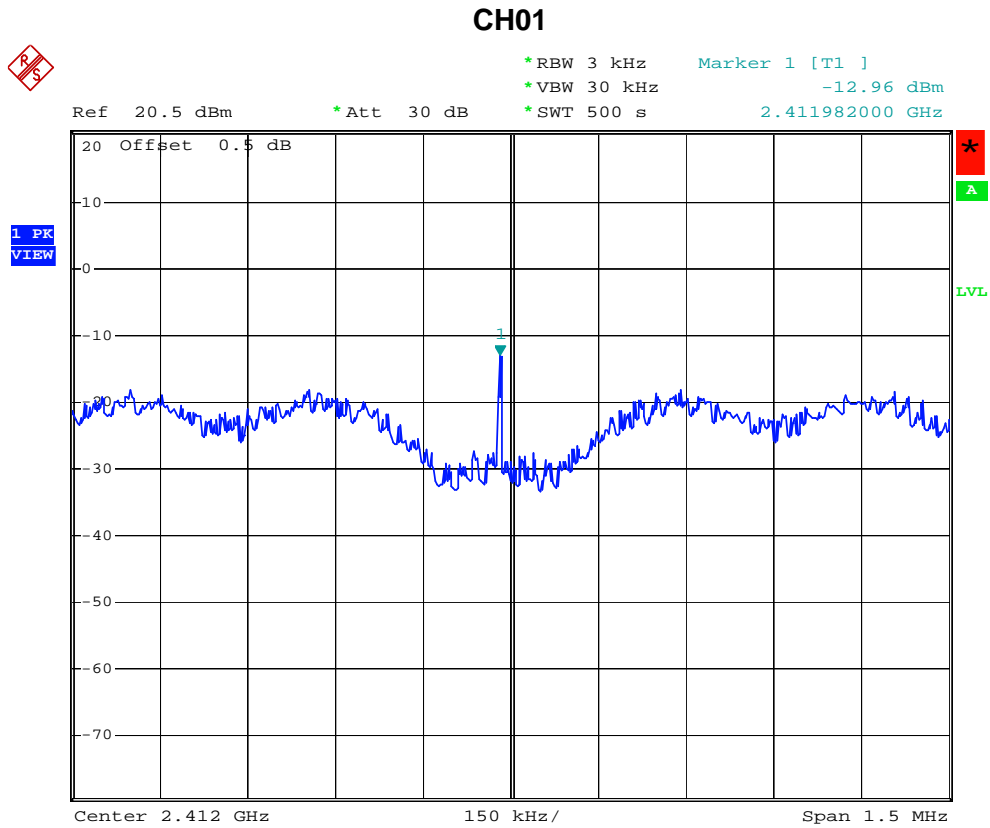



### CH06



\*RBW 3 kHz    Marker 1 [T1 ]  
\*VBW 30 kHz    -13.21 dBm  
\*SWT 500 s    2.436982000 GHz

Ref 20.5 dBm

\*Att 30 dB

1 PK  
VIEW

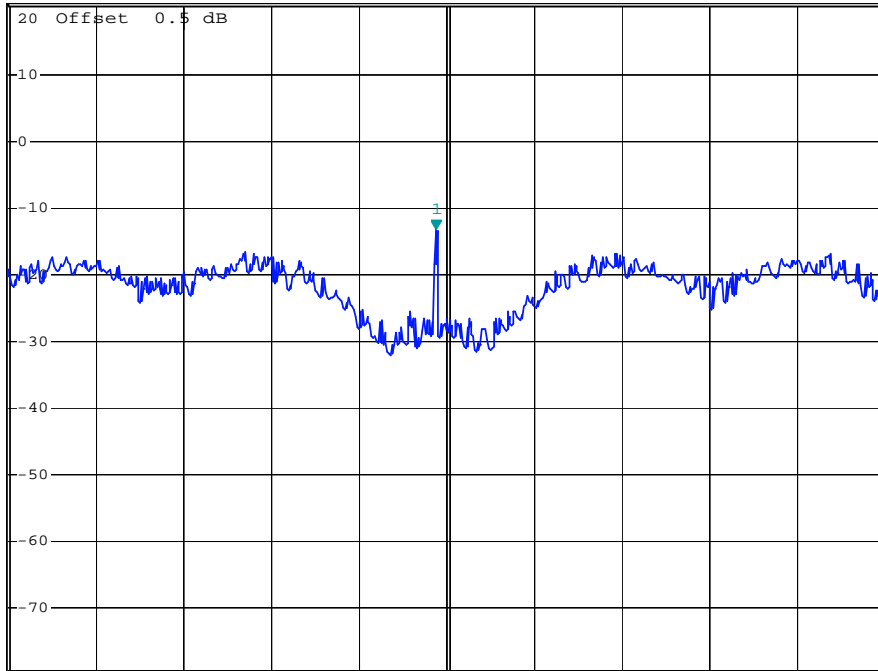

Center 2.437 GHz

150 kHz/

Span 1.5 MHz

### CH11



\*RBW 3 kHz    Marker 1 [T1 ]  
\*VBW 30 kHz    -13.49 dBm  
\*SWT 500 s    2.461982000 GHz

Ref 20.5 dBm

\*Att 30 dB

1 PK  
VIEW

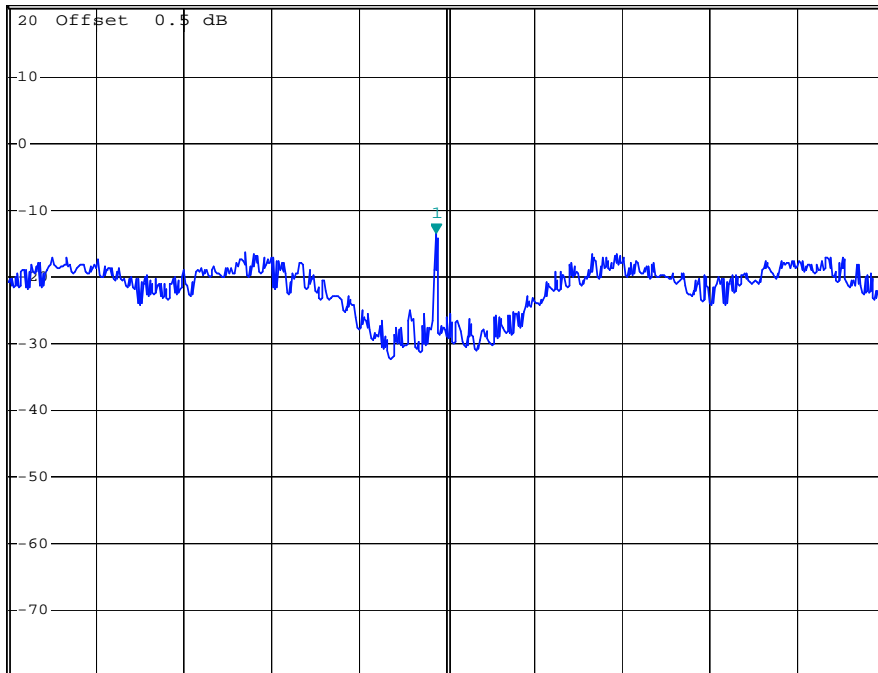

Center 2.462 GHz

150 kHz/

Span 1.5 MHz





EUT :	N_Max Wireless Access Point	Model Name :	WAP-6010
Temperature :	13 °C	Relative Humidity :	64 %
Test Voltage :	AC 120V/60Hz		
Test Mode :	802.11n/20M/CH01, CH06, CH11(Port. 1)		

Test Channel	Frequency (MHz)	Power Density (dBm/3kHz)	Power Density (mW/3kHz)	LIMIT (dBm)
CH01	2412	22.51	0.1782	8
CH06	2437	23.54	0.2259	8
CH11	2462	23.73	0.2360	8

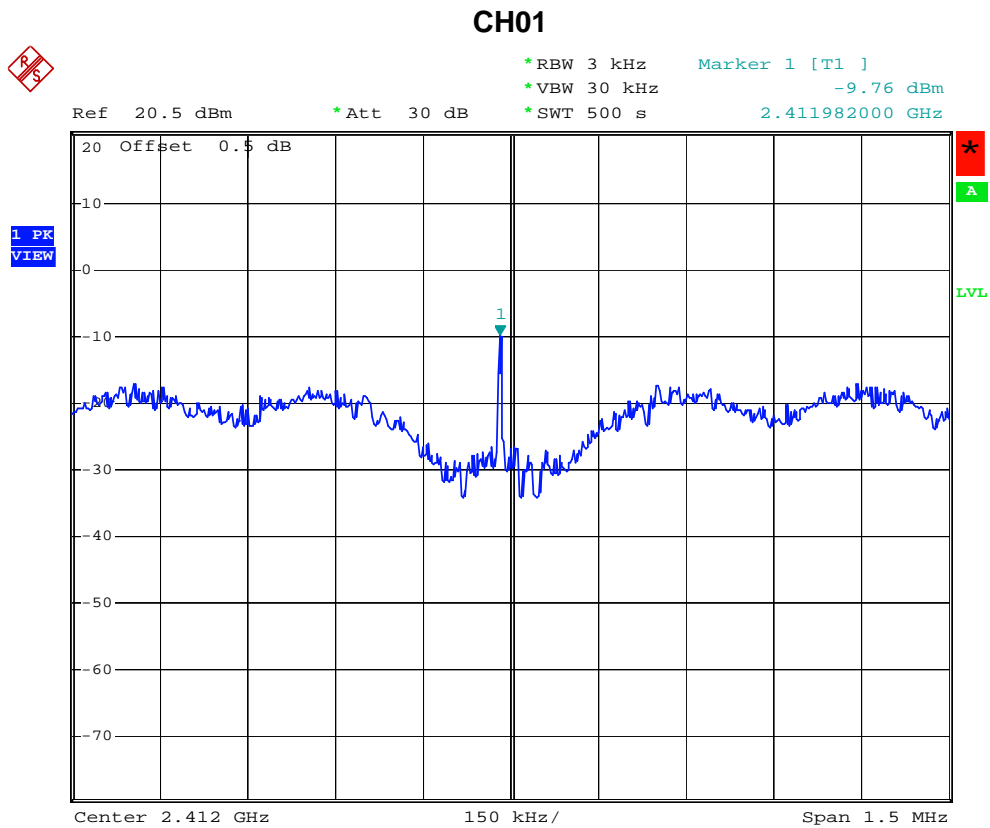



### CH06



\*RBW 3 kHz    Marker 1 [T1 ]  
\*VBW 30 kHz    -8.36 dBm  
\*SWT 500 s    2.436985000 GHz

Ref 20.5 dBm

\*Att 30 dB

1 PK  
VIEW

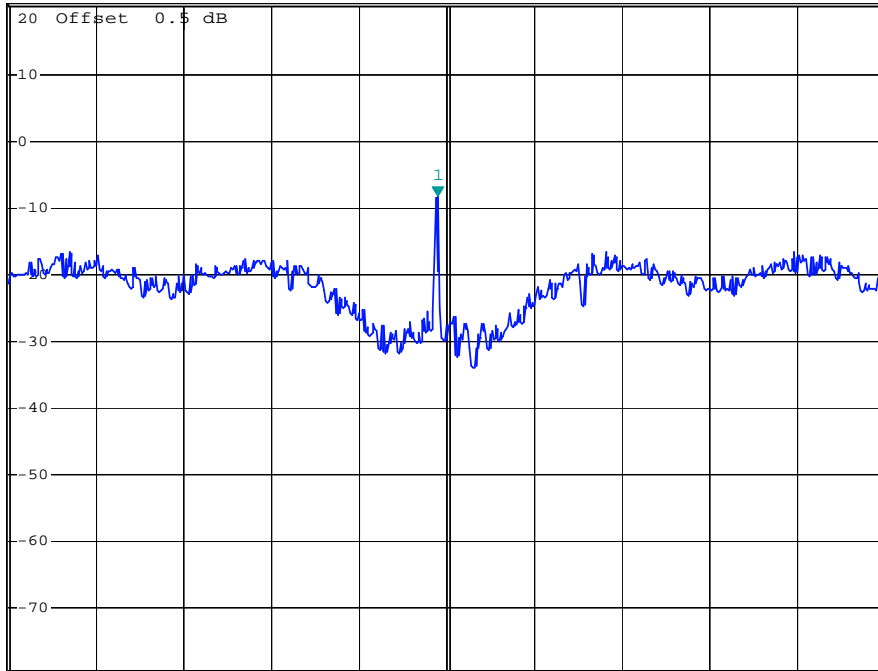

Center 2.437 GHz

150 kHz/

Span 1.5 MHz

### CH11



\*RBW 3 kHz    Marker 1 [T1 ]  
\*VBW 30 kHz    -9.58 dBm  
\*SWT 500 s    2.461982000 GHz

Ref 20.5 dBm

\*Att 30 dB

1 PK  
VIEW

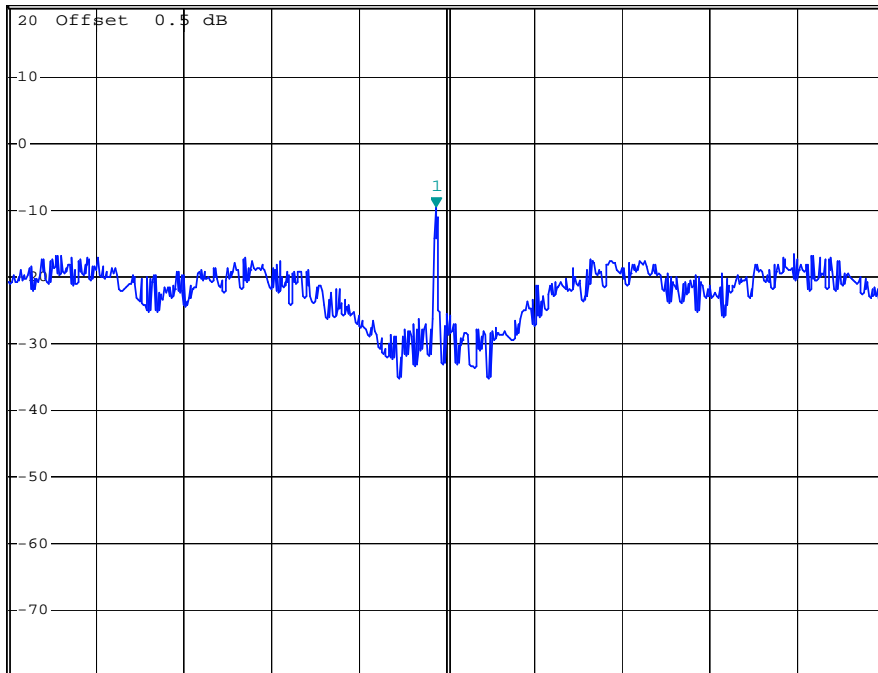

Center 2.462 GHz

150 kHz/

Span 1.5 MHz



EUT :	N_Max Wireless Access Point	Model Name :	WAP-6010
Temperature :	13 °C	Relative Humidity :	64 %
Test Voltage :	AC 120V/60Hz		
Test Mode :	802.11n/40M/CH03, CH06, CH09(Port. 0)		

Test Channel	Frequency (MHz)	Power Density (dBm/3kHz)	Power Density (mW/3kHz)	LIMIT (dBm)
CH01	2412	20.66	0.1164	8
CH06	2437	22.48	0.1770	8
CH11	2462	22.75	0.1884	8

**CH03**

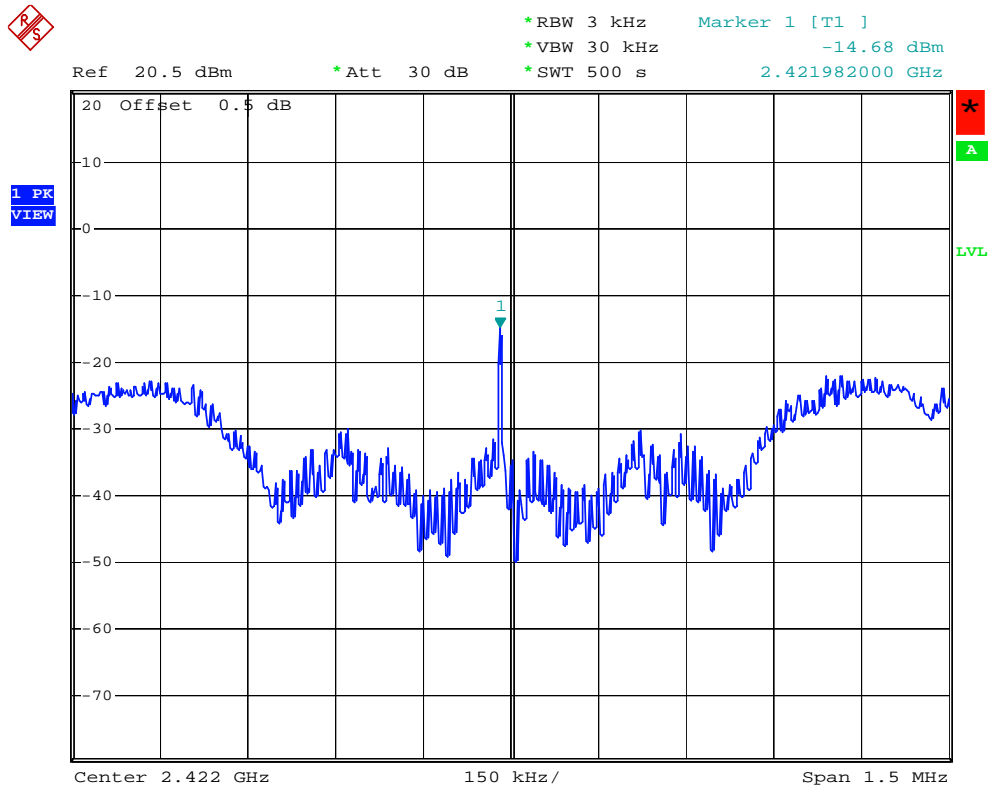



### CH06



\*RBW 3 kHz      Marker 1 [T1 ]  
\*VBW 30 kHz      -14.72 dBm  
\*Att 30 dB      \*SWT 500 s      2.436982000 GHz

Ref 20.5 dBm

1 PK  
VIEW

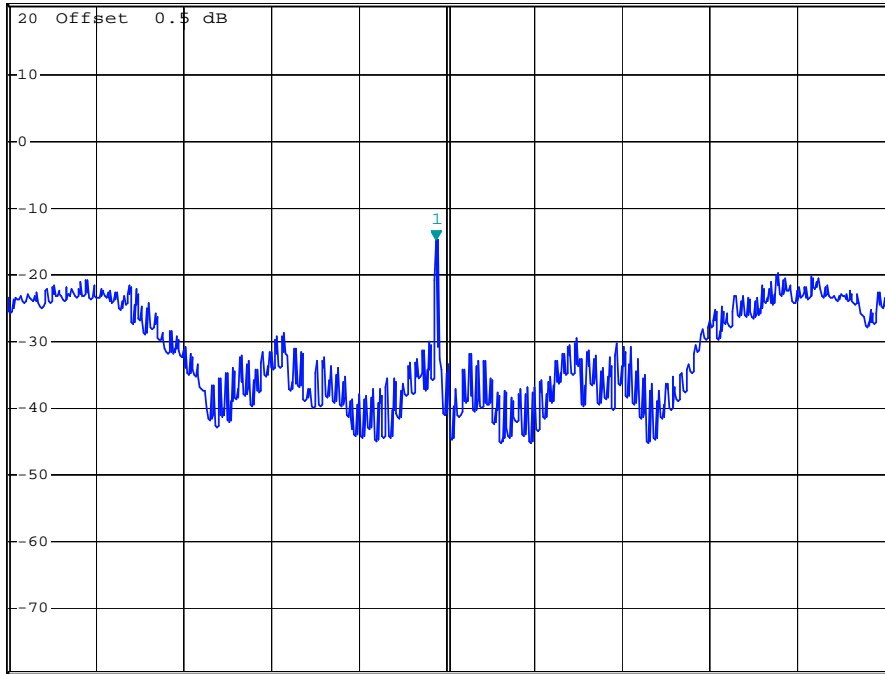

Center 2.437 GHz      150 kHz/      Span 1.5 MHz

### CH09



\*RBW 3 kHz      Marker 1 [T1 ]  
\*VBW 30 kHz      -14.25 dBm  
\*Att 30 dB      \*SWT 500 s      2.451982000 GHz

Ref 20.5 dBm

1 PK  
VIEW

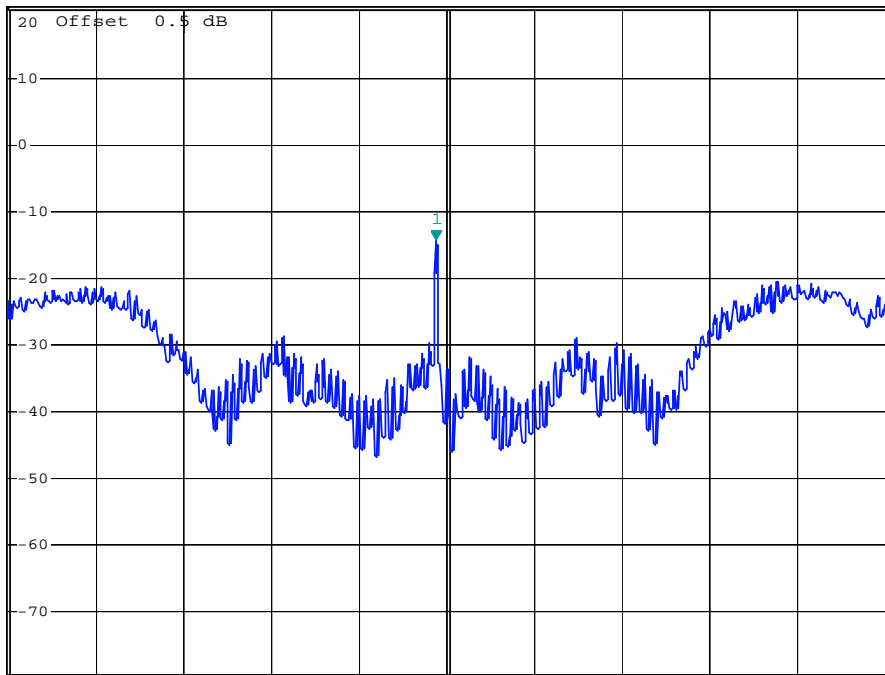

Center 2.452 GHz      150 kHz/      Span 1.5 MHz



EUT :	N_Max Wireless Access Point	Model Name :	WAP-6010
Temperature :	13 °C	Relative Humidity :	64 %
Test Voltage :	AC 120V/60Hz		
Test Mode :	802.11n/40M/CH03, CH06, CH09(Port. 1)		

Test Channel	Frequency (MHz)	Power Density (dBm/3kHz)	Power Density (mW/3kHz)	LIMIT (dBm)
CH01	2412	20.56	0.1138	8
CH06	2437	22.87	0.1936	8
CH11	2462	22.04	0.1600	8

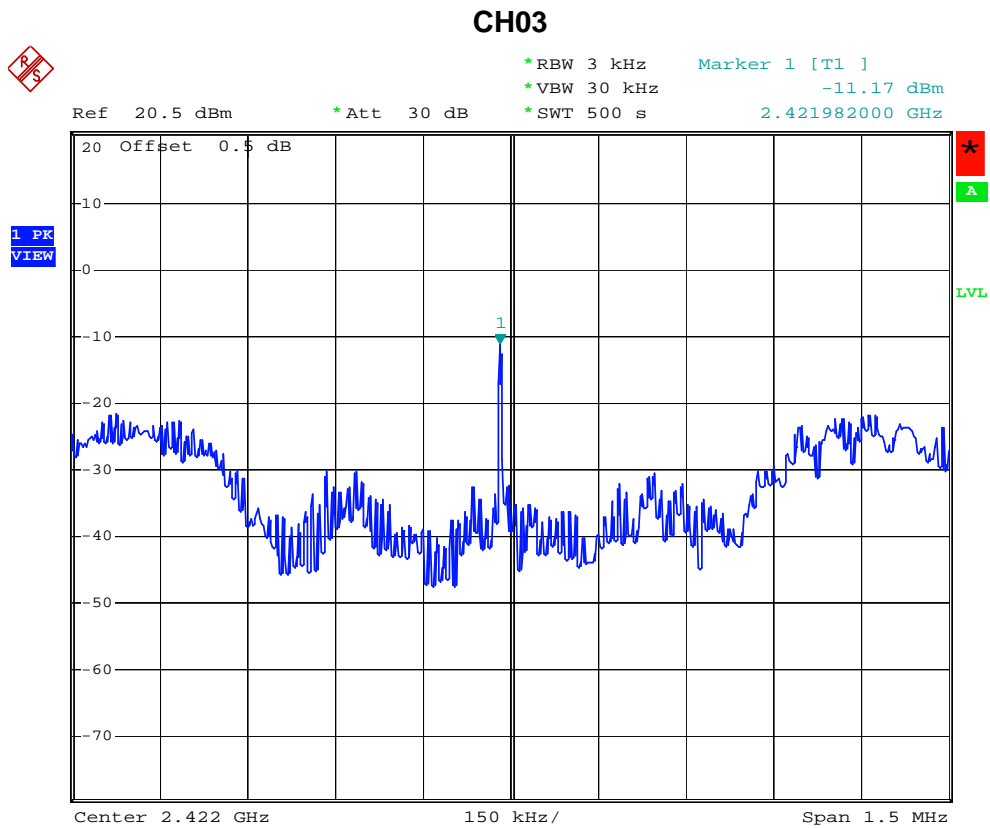



### CH06



\*RBW 3 kHz    Marker 1 [T1 ]  
\*VBW 30 kHz    -9.04 dBm  
\*SWT 500 s    2.436982000 GHz

Ref 20.5 dBm

\*Att 30 dB

1 PK  
VIEW

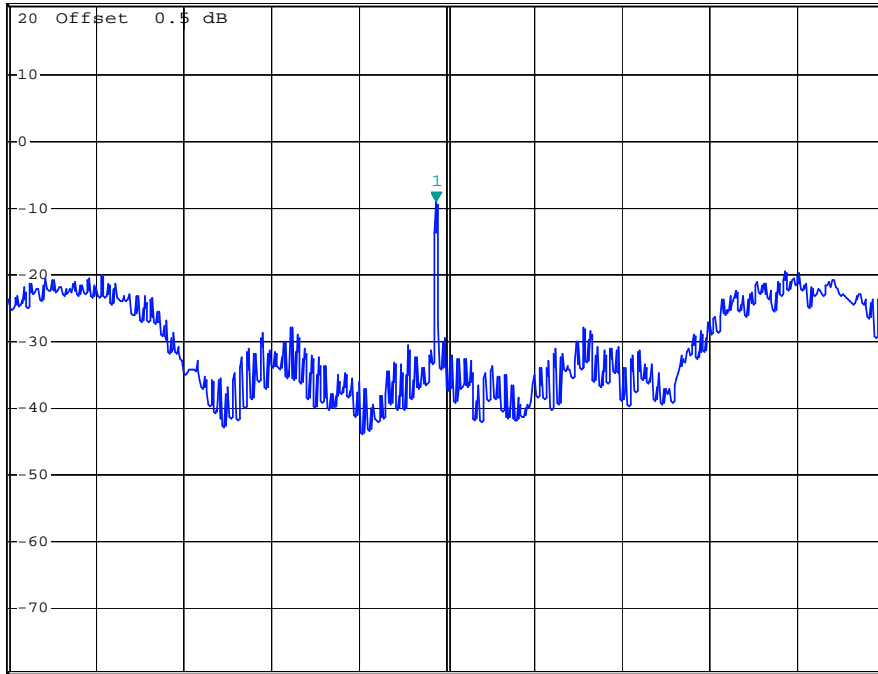

Center 2.437 GHz

150 kHz/

Span 1.5 MHz



LVL

### CH09



\*RBW 3 kHz    Marker 1 [T1 ]  
\*VBW 30 kHz    -10.74 dBm  
\*SWT 500 s    2.451985000 GHz

Ref 20.5 dBm

\*Att 30 dB

1 PK  
VIEW

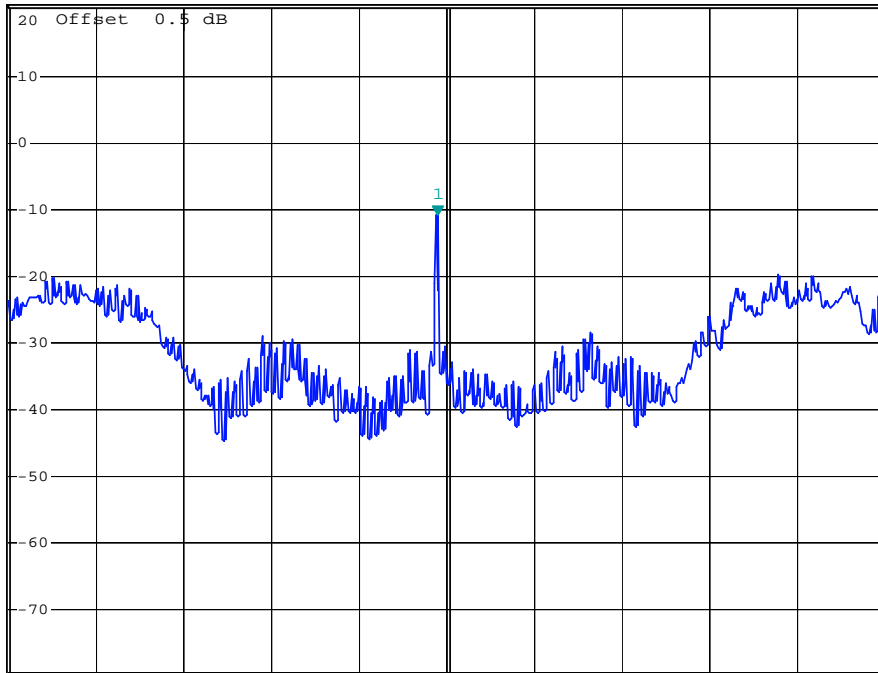

Center 2.452 GHz

150 kHz/

Span 1.5 MHz



LVL