

FCC PART 15C TEST REPORT FOR CERTIFICATION
On Behalf of

PLANET Technology Corporation

150Mbps 802.11n Wireless Broadband Router

Model No.: WNRT-617

FCC ID: UL9WNRT617V1

Prepared for : PLANET Technology Corporation
10F., No.96, Minquan Rd., Xindian Dist., New Taipei
City 231, Taiwan (R.O.C.)

Prepared By : Audix Technology (Shenzhen) Co., Ltd.
No. 6, Ke Feng Rd., 52 Block,
Shenzhen Science & Industrial Park,
Nantou, Shenzhen, Guangdong, China

Tel: (0755) 26639496

Report Number : ACS-F11084
Date of Test : Apr.27, 2011
Date of Report : Apr.28, 2011

TABLE OF CONTENTS

<u>Description</u>	<u>Page</u>
1. SUMMARY OF STANDARDS AND RESULTS.....	1-1
1.1. Description of Standards and Results	1-1
2. GENERAL INFORMATION	2-1
2.1. Description of Device (EUT)	2-1
2.2. Test Information.....	2-2
2.3. Tested Supporting System Details	2-3
2.4. Block diagram of connection between the EUT and simulators	2-3
2.5. Test Facility	2-4
2.6. Measurement Uncertainty (95% confidence levels, k=2)	2-4
3. POWER LINE CONDUCTED EMISSION TEST	3-1
3.1. Test Equipments.....	3-1
3.2. Block Diagram of Test Setup.....	3-1
3.3. Power Line Conducted Emission Test Limits.....	3-1
3.4. Configuration of EUT on Test	3-2
3.5. Operating Condition of EUT.....	3-2
3.6. Test Procedure.....	3-2
3.7. Power Line Conducted Emission Test Results	3-2
4. RADIATED EMISSION TEST	4-5
4.1. Test Equipment	4-5
4.2. Block Diagram of Test Setup.....	4-5
4.3. Radiated Emission Limit.....	4-6
4.4. EUT Configuration on Test.....	4-7
4.5. Operating Condition of EUT.....	4-7
4.6. Test Procedure.....	4-7
4.7. Radiated Emission Test Results	4-8
5. CONDUCTED SPURIOUS EMISSIONS.....	5-83
5.1. Test Equipment	5-83
5.2. Limit.....	5-83
5.3. Test Procedure.....	5-83
5.4. Test result.....	5-83
6. BAND EDGE COMPLIANCE TEST	6-106
6.1. Test Equipment	6-106
6.2. Limit.....	6-106
6.3. Test Produce	6-106
6.4. Test Results	6-106
7. 6dB Bandwidth Test.....	7-139
7.1. Test Equipment	7-139
7.2. Limit.....	7-139
7.3. Test Procedure.....	7-139
7.4. Test Results	7-139
8. OUTPUT POWER TEST.....	8-146
8.1. Test Equipment	8-146
8.2. Limit (FCC Part 15C 15.247 b(3)).....	8-146
8.3. Test Procedure.....	8-146
8.4. Test Results	8-147
9. POWER SPECTRAL DENSITY TEST	9-3
9.1. Test Equipment	9-3

FCC ID: UL9WNRT617V1

9.2.	Limit.....	9-3
9.3.	Test Procedure.....	9-3
9.4.	Test Results	9-4
10.	ANTENNA REQUIREMENT	10-11
10.1.	STANDARD APPLICABLE.....	10-11
10.2.	ANTENNA CONNECTED CONSTRUCTION	10-11
11.	MPE ESTIMATION.....	11-12
11.1.	Limit for General Population/ Uncontrolled Exposures	11-12
11.2.	2, Estimation Result	11-12
12.	DEVIATION TO TEST SPECIFICATIONS.....	12-1
13.	PHOTOGRAPH OF TEST	13-1
13.1.	Photos of Power Line Conducted Emission Test	13-1
13.2.	Photos of Radiated Emission Test.....	13-2
14.	PHOTOS OF THE EUT.....	14-1

FCC ID:UL9WNRT617V1

TEST REPORT CERTIFICATION

Applicant : PLANET Technology Corporation
Manufacturer : PLANET Technology Corporation
EUT Description : 150Mbps 802.11n Wireless Broadband Router
FCC ID : UL9WNRT617V1
(A) MODEL NO. : WNRT-617
(B) SERIAL NO. : N/A
(C) POWER SUPPLY : DC 9V From Adapter Input
AC 120V/60Hz
(D) TEST VOLTAGE : DC 9V from adapter input AC 120V/60Hz

Tested for comply with:
FCC Rules and Regulations Part 15 Subpart C: 2008

Test procedure used:
ANSI C63.10:2009

The device described above is tested by AUDIX TECHNOLOGY (SHENZHEN) CO., LTD. to confirm comply with all the FCC Part 15 Subpart C requirements.

The test results are contained in this test report and AUDIX TECHNOLOGY (SHENZHEN) CO., LTD. is assumed full responsibility for the accuracy and completeness of these tests. Also, this report shows that the Equipment Under Test (EUT) is to be technically compliant with the FCC and IC requirements.

This Report is made under FCC Part 2.1075. No modifications were required during testing to bring this product into compliance.

This report applies to above tested sample only. This report shall not be reproduced in part without written approval of AUDIX TECHNOLOGY (SHENZHEN) CO., LTD.

Date of Test : Apr.27, 2011 Report of date: Apr.28, 2011

Prepared by : Blove Ye Reviewer by : Sunny Lu
Blove Ye / Assistant Sunny Lu / Senior Assistant

Approved & Authorized Signer : Ken Lu
Ken Lu / Manager



1. SUMMARY OF STANDARDS AND RESULTS

1.1. Description of Standards and Results

The EUT have been tested according to the applicable standards as referenced below.

EMISSION		
Description of Test Item	Standard	Results
Power Line Conducted Emission	FCC Part 15: 15.207 ANSI C63.10: 2009	PASS
Radiated Emission	FCC Part 15: 15.209 ANSI C63.10: 2009	PASS
Band Edge Compliance	FCC Part 15: 15.247 ANSI C63.10: 2009	PASS
Conducted spurious emissions	FCC Part 15: 15.247 ANSI C63.10: 2009	PASS
6dB Bandwidth	FCC Part 15: 15.247 ANSI C63.10: 2009	PASS
Peak Output Power	FCC Part 15: 15.247 ANSI C63.10: 2009	PASS
Power Spectral Density	FCC Part 15: 15.247 ANSI C63.10: 2009	PASS
Antenna requirement	FCC Part 15: 15.203	PASS

2. GENERAL INFORMATION

2.1. Description of Device (EUT)

Product Name	:	150Mbps 802.11n Wireless Broadband Router
Model Number	:	WNRT-617
FCC ID	:	UL9WNRT617V1
Operation Frequency	:	IEEE 802.11b: 2412MHz—2462MHz IEEE 802.11g: 2412MHz—2462MHz IEEE802.11n HT20: 2412MHz—2462MHz IEEE802.11n HT40: 2422MHz—2452MHz
Channel Number	:	IEEE 802.11b/g, IEEE 802.11n HT20: 11 Channels IEEE 802.11n HT40: 7Channels
Modulation Technology	:	IEEE 802.11b: DSSS(CCK,DQPSK,DBPSK) IEEE 802.11g: OFDM(64QAM, 16QAM, QPSK, BPSK) IEEE 802.11n HT20, HT40: OFDM (64QAM, 16QAM, QPSK,BPSK)
Antenna Assembly Gain	:	One Dipole Antenna, One integrated PCB antenna, SIMO 1Tx2R, 5dBi Peak gain for dipole antenna Note: The integrated PCB antenna only used for receive.
Applicant	:	PLANET Technology Corporation 10F., No.96, Minquan Rd., Xindian Dist., New Taipei City 231, Taiwan (R.O.C.)
Manufacturer	:	PLANET Technology Corporation 10F., No.96, Minquan Rd., Xindian Dist., New Taipei City 231, Taiwan (R.O.C.)
Adapter	:	Manufacture: VASATA M/N: P060060-2B1 Unshielded, Undetachable,1.5m
Date of Test	:	Apr.27, 2011
Date of Receipt	:	Apr.19, 2011
Sample Type	:	Prototype production

2.2. Test Information

A special test software was used to control EUT work in Continuous TX mode(100% duty cycle), and select test channel, wireless mode and data rate.

Tested mode, channel, and data rate information			
Mode	data rate (Mbps)(see Note)	Channel	Frequency (MHz)
IEEE 802.11b	11	Low :CH1	2412
	11	Middle: CH6	2437
	11	High: CH11	2462
IEEE 802.11g	54	Low :CH1	2412
	54	Middle: CH6	2437
	54	High: CH11	2462
IEEE 802.11n HT20	6.5	Low :CH1	2412
	6.5	Middle: CH6	2437
	6.5	High: CH11	2462
IEEE 802.11n HT40	13.5	Low :CH1	2422
	13.5	Middle: CH4	2437
	13.5	High: CH7	2452

Note1: According exploratory test, EUT will have maximum PK output power in those data rate, so those data rate were used for all test.

2.3. Tested Supporting System Details

No.	Description	ACS No.	Manufacturer	Model	Serial Number	Approved type
1	Personal Computer	Test PC P	DELL	Studio 540	124XK2X	<input checked="" type="checkbox"/> FCC DoC <input checked="" type="checkbox"/> BSMI ID:R33002
		Power Cord: Unshielded, Detachable, 1.8m Display Card: HD3450 (DVI+VGA+HDMI)				
2	USB Keyboard	ACS-EMC- K02R	DELL	SK-8115	CN-ORH656-658 90-686-007J	<input checked="" type="checkbox"/> FCC DoC <input checked="" type="checkbox"/> BSMI ID: T3A002
		Power Cord: shielded, Undetachable, 2.0m				
3.	USB Mouse	ACS-EMC-M02R	DELL	M056UO	512024264	<input checked="" type="checkbox"/> FCC DoC <input checked="" type="checkbox"/> BSMI ID: R41108
		Data Cable: shielded, Undetachable, 1.8m				
4.	Monitor	ACS-EMC-LM04R	DELL	1907FPt	CN-009759-71618 -6AP-ACPP	<input checked="" type="checkbox"/> FCC DoC <input checked="" type="checkbox"/> BSMI ID: R3A002
		Power Cord: Unshielded, Detachable, 1.8m VGA Cable: Shielded, Detachable, 2.0m (with two cores) DVI Cable: Shielded, Detachable, 2.0m (with two cores)				

2.4. Block diagram of connection between the EUT and simulators

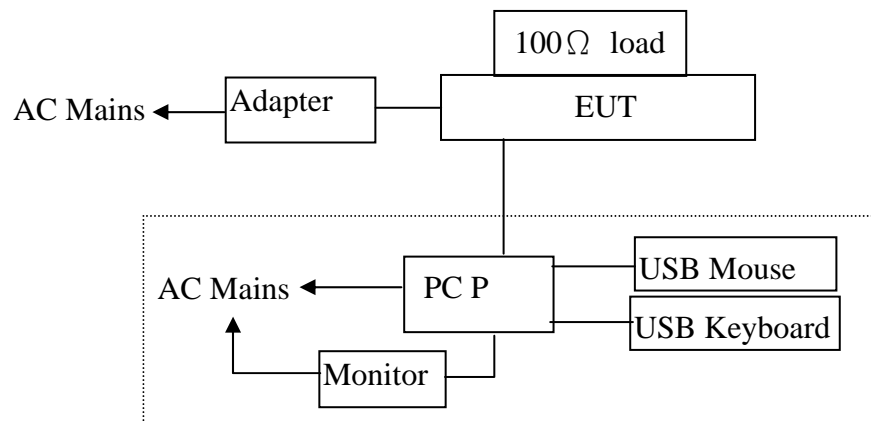

PC P run test software to control EUT work in Tx mode

2.5. Test Facility

Site Description

- Name of Firm : Audix Technology (Shenzhen) Co., Ltd.
No. 6, Ke Feng Rd., 52 Block, Shenzhen
Science & Industrial Park,Nantou,
Shenzhen, Guangdong, China
- 3m Anechoic Chamber : Mar.31, 2009 File on Federal
Communication Commission
Registration Number: 90454
- 3m & 10m Anechoic Chamber : Dec. 30, 2009 File on Federal
Communication Commission
Registration Number: 794232
- EMC Lab. : Certificated by Industry Canada
Registration Number: IC 5183A-1
Jul. 03, 2009
- : Accredited by DATech, German
Registration Number: DAT-P-091/99-01
Feb. 02, 2009
- Accredited by NVLAP, USA
NVLAP Code: 200372-0
Mar.31, 2011

2.6.Measurement Uncertainty (95% confidence levels, k=2)

Test Item	Uncertainty
Uncertainty for Conduction emission test in No. 1 Conduction	3.64 dB (9kHz to 150kHz)
	3.22 dB(150kHz to 30MHz)
Uncertainty for Radiation Emission test in 3m chamber	4.20 dB (Polarize: V)
	4.66 dB (Polarize: H)
Uncertainty for Radiated Spurious Emission test in RF chamber	2.70 dB(Bilog antenna 30M~1000MHz)
	2.27 dB(Horn antenna 1000M~12750MHz)
Uncertainty for Conduction Spurious emission test	2.12 dB
Uncertainty for Output power test	0.97 dB
Uncertainty for Power density test	2.21 dB
Uncertainty for Frequency range test	1x10 ⁻⁹
Uncertainty for Bandwidth test	1x10 ⁻⁹
Uncertainty for DC power test	0.038 %
Uncertainty for test site temperature and humidity	0.3°C
	2%

3. POWER LINE CONDUCTED EMISSION TEST

3.1. Test Equipments

Item	Equipment	Manufacturer	Model No.	Serial No.	Last Cal.	Cal. Interval
1.	Test Receiver	Rohde & Schwarz	ESHS10	838693/001	Nov.05, 10	1 Year
2.	L.I.S.N.#1	Rohde & Schwarz	ESH2-Z5	834066/011	Nov.05, 10	1 Year
3.	L.I.S.N.#3	Kyoritsu	KNW-242C	8-1920-1	May.08, 10	1 Year
4.	Terminator	Hubersuhner	50Ω	No. 1	May.08, 10	1 Year
5.	Terminator	Hubersuhner	50Ω	No. 2	May.08, 10	1 Year
6.	RF Cable	Fujikura	3D-2W	LISN Cable 1#	May.08, 10	1Year
7.	Coaxial Switch	Anritsu	MP59B	M55367	May.08, 10	1 Year
8.	Passive Probe	Rohde & Schwarz	ESH2-Z3	299.7810.52	May.08, 10	1 Year
9.	Pulse Limiter	Rohde & Schwarz	ESH3-Z2	100341	May.08, 10	1 Year
10.	Oscilloscope	Tektronix	TDS3052B	B026036	May.08, 10	1 Year

3.2. Block Diagram of Test Setup

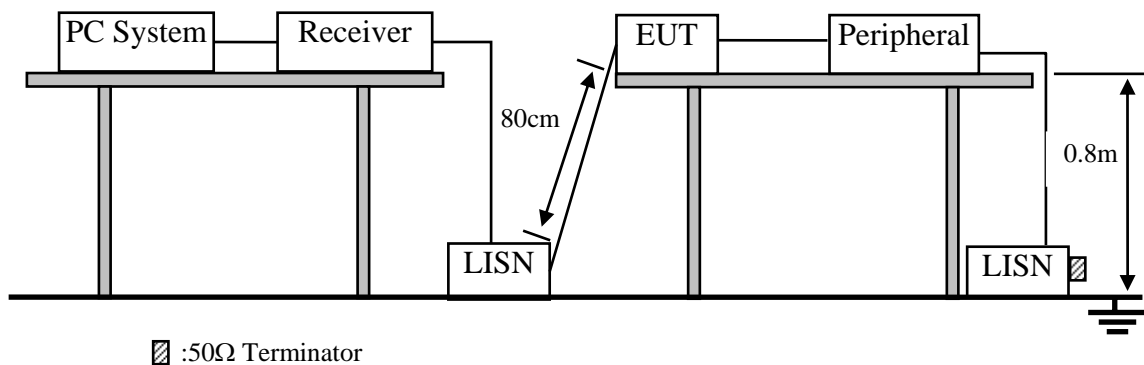

3.3. Power Line Conducted Emission Test Limits

Frequency	Maximum RF Line Voltage	
	Quasi-Peak Level dB(μV)	Average Level dB(μV)
150kHz ~ 500kHz	66 ~ 56*	56 ~ 46*
500kHz ~ 5MHz	56	46
5MHz ~ 30MHz	60	50

Notes: 1. * Decreasing linearly with logarithm of frequency.

2. The lower limit shall apply at the transition frequencies.

3.4. Configuration of EUT on Test

The following equipment are installed on Power Line Conducted Emission Test to meet the commission requirement and operating regulations in a manner which tends to maximize its emission characteristics in a normal application.

3.4.1. 150Mbps 802.11n Wireless Broadband Router (EUT)

Model Number : WNRT-617
Serial Number : N/A

3.4.2. Support Equipment: As Tested Supporting System Details, in Section 2.3.

3.5. Operating Condition of EUT

3.5.1. Setup the EUT and simulator as shown as Section 2.4.

3.5.2. Turned on the power of all equipment.

3.5.3. PC run test software to control EUT work in Tx mode.

3.6. Test Procedure

The EUT was placed on a non-metallic table, 80cm above the ground plane. The EUT Power connected to the power mains through a line impedance stabilization network (L.I.S.N. 1#). This provides a 50 ohm coupling impedance for the EUT (Please refer the block diagram of the test setup and photographs). The AC line are checked to find out the maximum conducted emission. In order to find the maximum emission levels, the relative positions of equipment and all of the interface cables shall be changed according to ANSI C63.10: 2009 on Conducted Emission Test.

The bandwidth of test receiver (R & S ESHS10) is set at 10kHz.

The frequency range from 150kHz to 30MHz is checked.

3.7. Power Line Conducted Emission Test Results

PASS. (All emissions not reported below are too low against the prescribed limits.)

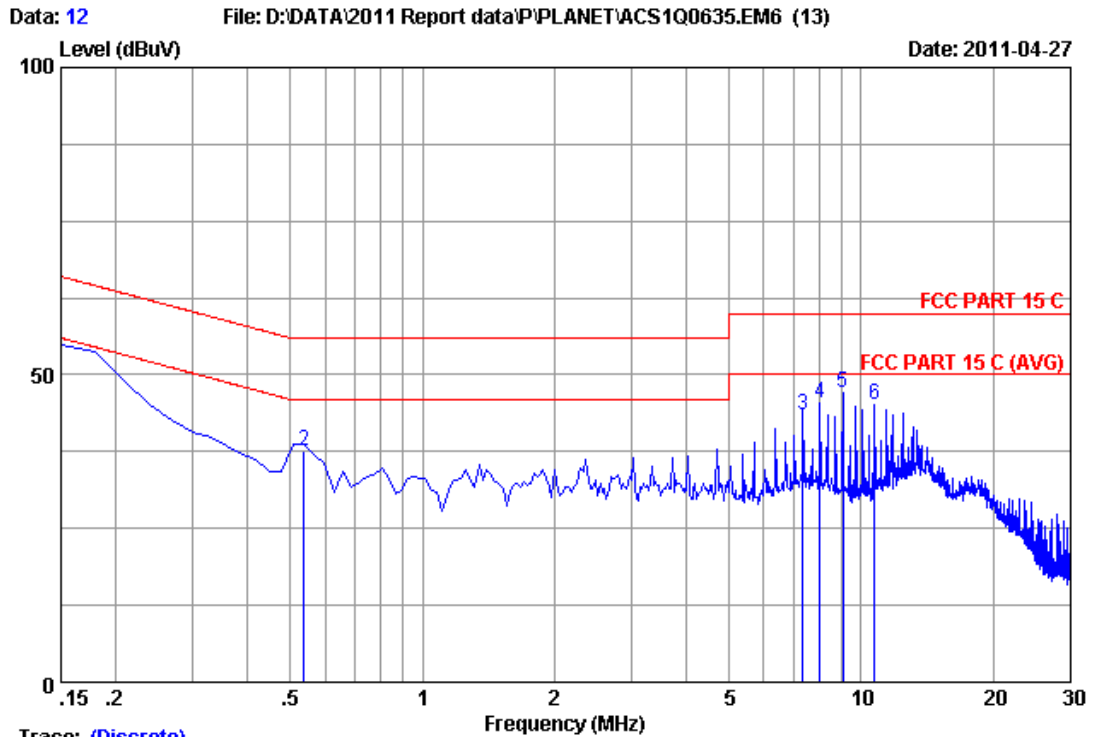

Trace: (Discrete)

Site no :1#conduction Data No :12
 Dis./Ant. :** 2011 ESH2-25 NEUTRAL
 Limit :FCC PART 15 C
 Env./Ins. :29.5*C/55% Engineer :Restar
 EUT :150Mbps 802.11n Wireless Broadband Router
 Power Rating :DC 9V From Adapter Input AC 120V/60Hz
 Test Mode :Tx Mode
 M/N:WNRT-617

No	Freq (MHz)	LISN Factor (dB)	Cable Loss (dB)	Reading (dBuV)	Emission Level (dBuV)	Limits (dBuV)	Margin (dB)	Remark
1	0.15000	0.21	9.88	43.92	54.01	66.00	11.99	QP
2	0.53805	0.22	9.88	27.54	37.64	56.00	18.36	QP
3	7.374	0.40	9.97	33.03	43.40	60.00	16.60	QP
4	8.060	0.41	9.98	35.00	45.39	60.00	14.61	QP
5	9.075	0.43	9.99	36.67	47.09	60.00	12.91	QP
6	10.747	0.47	9.99	34.55	45.01	60.00	14.99	QP

Remarks: 1.Emission Level=LISN Factor+Cable Loss(Include 10dB pulse limit)+Reading.
 2.If the average limit is met when using a quasi-peak detector, the EUT shall be deemed to meet both limits and measurement with average detector is unnecessary.

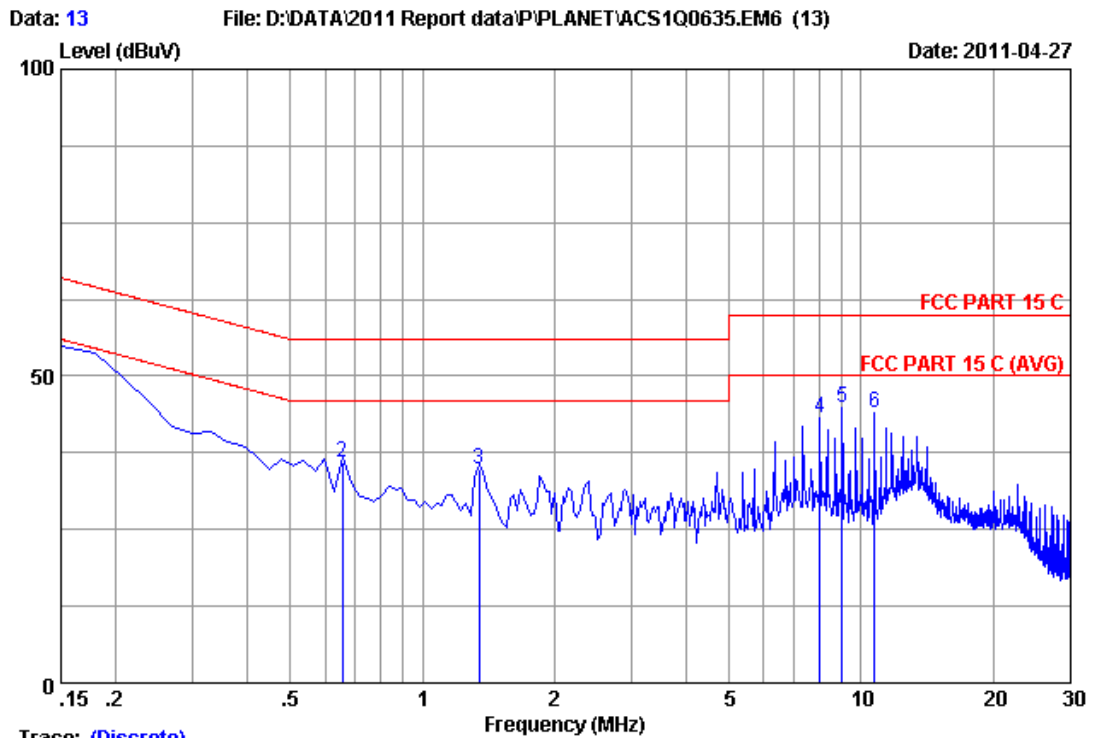

Trace: (Discrete)

Site no :1#conduction Data No :13
 Dis./Ant. **: 2011 ESH2-25 NEUTRAL
 Limit :FCC PART 15 C
 Env./Ins. :29.5*C/55% Engineer :Restar
 EUT :150Mbps 802.11n Wireless Broadband Router
 Power Rating :DC 9V From Adapter Input AC 120V/60Hz
 Test Mode :Tx Mode
 M/N:WNRT-617

No	Freq (MHz)	LISN Factor (dB)	Cable Loss (dB)	Reading (dBuV)	Emission Level (dBuV)	Limits (dBuV)	Margin (dB)	Remark
1	0.15000	0.21	9.88	43.75	53.84	66.00	12.16	QP
2	0.65745	0.23	9.89	25.70	35.82	56.00	20.18	QP
3	1.344	0.25	9.89	24.58	34.72	56.00	21.28	QP
4	8.060	0.41	9.98	32.88	43.27	60.00	16.73	QP
5	9.045	0.43	9.99	34.31	44.73	60.00	15.27	QP
6	10.717	0.47	9.99	33.65	44.11	60.00	15.89	QP

Remarks: 1.Emission Level=LISN Factor+Cable Loss(Include 10dB pulse limit)+Reading.
 2.If the average limit is met when using a quasi-peak detector, the EUT shall be deemed to meet both limits and measurement with average detector is unnecessary.

4. RADIATED EMISSION TEST

4.1. Test Equipment

Frequency rang: 30~1000MHz

Item	Equipment	Manufacturer	Model No.	Serial No.	Last Cal.	Cal. Interval
1	3#Chamber	AUDIX	N/A	N/A	Dec.06,10	1 Year
2	EMI Spectrum	Agilent	E4407B	MY41440292	May.08, 10	1 Year
3	Test Receiver	Rohde & Schwarz	ESVS10	834468/011	May.08, 10	1 Year
4	Amplifier	HP	8447D	2648A04738	May.08, 10	1 Year
5	Bilog Antenna	Schaffner	CBL6111C	2598	Oct.26, 10	1 Year
6	RF Cable	MIYAZAKI	8D-FB	3# Chamber No.1	May.08, 10	1 Year
7	Coaxial Switch	Anritsu	MP59B	M73989	May.08, 10	1 Year

Frequency rang: above 1000MHz

Item	Equipment	Manufacturer	Model No.	Serial No.	Last Cal.	Cal. Interval
1	Spectrum Analyzer	Agilent	E4446A	US44300459	May.08, 10	1 Year
2	Horn Antenna	EMCO	3115	9607-4877	Nov.25, 09	1.5 Year
3	Horn Antenna	EMCO	3116	00060089	Nov.25, 09	1.5 Year
4	Amplifier	Agilent	8449B	3008A00863	May.08, 10	1 Year
5	RF Cable	Hubersuhner	SUCOFLEX102	28620/2	May.08, 10	1 Year
6	RF Cable	Hubersuhner	SUCOFLEX102	29091/2	May.08, 10	1 Year

4.2. Block Diagram of Test Setup

For frequency range 30MHz-1000MHz

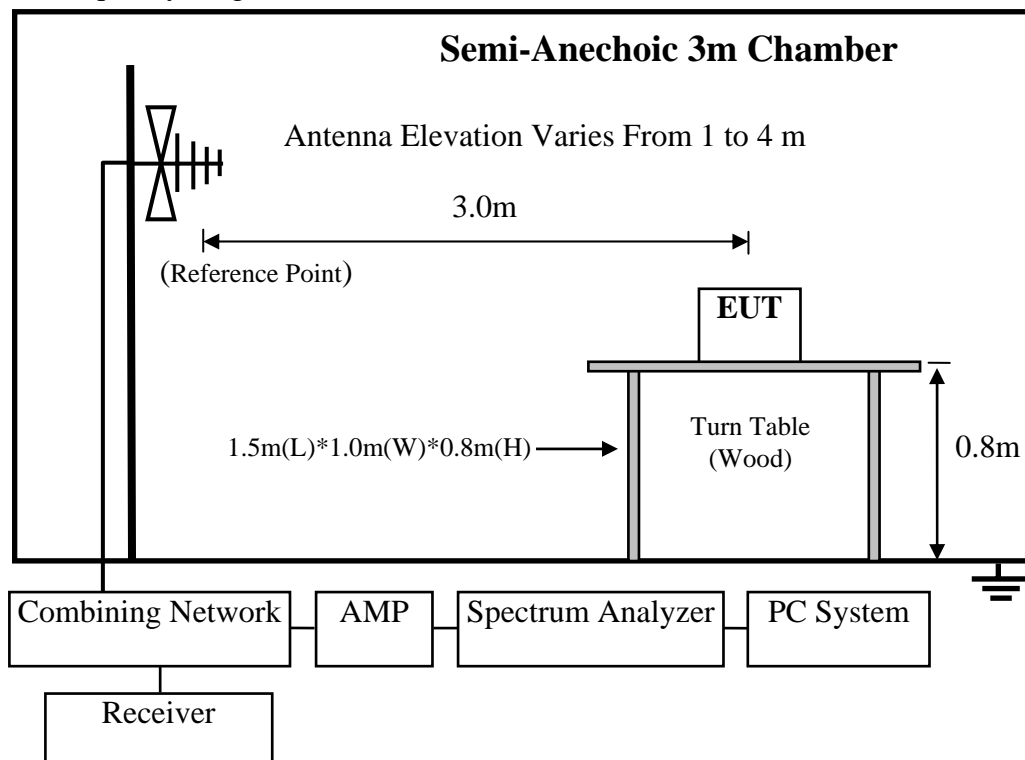

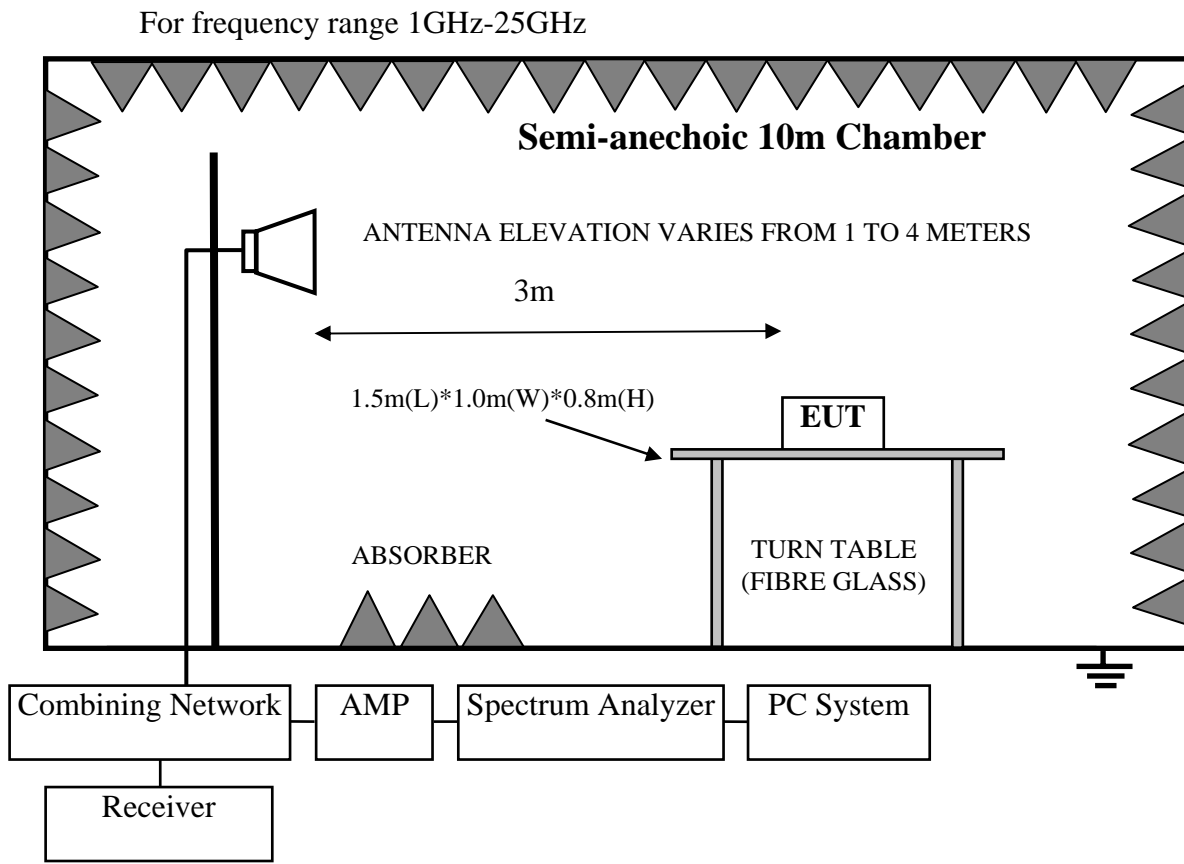

4.3. Radiated Emission Limit

4.3.1.15.209 limits

FREQUENCY MHz	DISTANCE Meters	FIELD STRENGTHS LIMIT	
		$\mu\text{V}/\text{m}$	$\text{dB}(\mu\text{V})/\text{m}$
30 ~ 88	3	100	40.0
88 ~ 216	3	150	43.5
216 ~ 960	3	200	46.0
960 ~ 1000	3	500	54.0
Above 1000	3	74.0 $\text{dB}(\mu\text{V})/\text{m}$ (Peak) 54.0 $\text{dB}(\mu\text{V})/\text{m}$ (Average)	

- Remark :
- (1) Emission level $\text{dB}\mu\text{V} = 20 \log$ Emission level $\mu\text{V}/\text{m}$
 - (2) The smaller limit shall apply at the cross point between two frequency bands.
 - (3) Distance is the distance in meters between the measuring instrument, antenna and the closest point of any part of the device or system.

4.3.2.15.205 Restricted bands of operation

MHz	MHz	MHz	GHz
0.090 - 0.110	16.42 - 16.423	399.9 - 410	4.5 - 5.15
¹ 0.495 - 0.505	16.69475 - 16.69525	608 - 614	5.35 - 5.46
2.1735 - 2.1905	16.80425 - 16.80475	960 - 1240	7.25 - 7.75
4.125 - 4.128	25.5 - 25.67	1300 - 1427	8.025 - 8.5
4.17725 - 4.17775	37.5 - 38.25	1435 - 1626.5	9.0 - 9.2
4.20725 - 4.20775	73 - 74.6	1645.5 - 1646.5	9.3 - 9.5
6.215 - 6.218	74.8 - 75.2	1660 - 1710	10.6 - 12.7
6.26775 - 6.26825	108 - 121.94	1718.8 - 1722.2	13.25 - 13.4
6.31175 - 6.31225	123 - 138	2200 - 2300	14.47 - 14.5
8.291 - 8.294	149.9 - 150.05	2310 - 2390	15.35 - 16.2
8.362 - 8.366	156.52475 - 156.52525	2483.5 - 2500	17.7 - 21.4
8.37625 - 8.38675	156.7 - 156.9	2690 - 2900	22.01 - 23.12
8.41425 - 8.41475	162.0125 - 167.17	3260 - 3267	23.6 - 24.0
12.29 - 12.293	167.72 - 173.2	3332 - 3339	31.2 - 31.8
12.51975 - 12.52025	240 - 285	3345.8 - 3358	36.43 - 36.5
12.57675 - 12.57725	322 - 335.4	3600 - 4400	(²)

All the emissions appearing within 15.205 restricted frequency bands shall not exceed the limits shown in 15.209, all the other emissions shall be at least 20dB below the fundamental emissions, or comply with 15.209 limits.

4.4.EUT Configuration on Test

The configurations of EUT are listed in Section 3.5.

4.5.Operating Condition of EUT

Same as Conducted Emission test that is listed in Section 3.6. except the test set up replaced by Section 4.2.

4.6.Test Procedure

EUT and its simulators are placed on a turn table, which is 0.8 meter high above ground. The turn table can rotate 360 degrees to determine the position of the maximum emission level. Power on the EUT and let it working in test mode, then test it. EUT is set 3 meters away from the receiving antenna, which is mounted on a antenna tower. The antenna can be moved up and down between 1 meter and 4 meters to find out the maximum emission level. Broadband antenna (calibrated bilog antenna) is used as receiving antenna. Both horizontal and vertical polarization of the antenna are set on test.

The bandwidth of the EMI test receiver (R&S ESVS10) is set at 120kHz for frequency range from 30MHz to 1000 MHz.

The bandwidth of the Spectrum's VBW is set at 3MHz and RBW is set at 1MHz for peak emissions measurement above 1GHz and 1MHz RBW, 10Hz VBW for average emissions measure above 1GHz

The frequency range from 30MHz to 10th harmonic (25GHz) are checked. and no any emissions were found from 18GHz to 25 GHz, So the radiated emissions from 18GHz to 25GHz were not record.

4.7.Radiated Emission Test Results

PASS.

All the emissions from 30MHz to 25 GHz were comply with 15.209 limits.

Note: For emissions above 1GHz, if peak level comply with average limit, then the average level is deemed to comply with average limit.

Frequency: 30MHz~1GHz

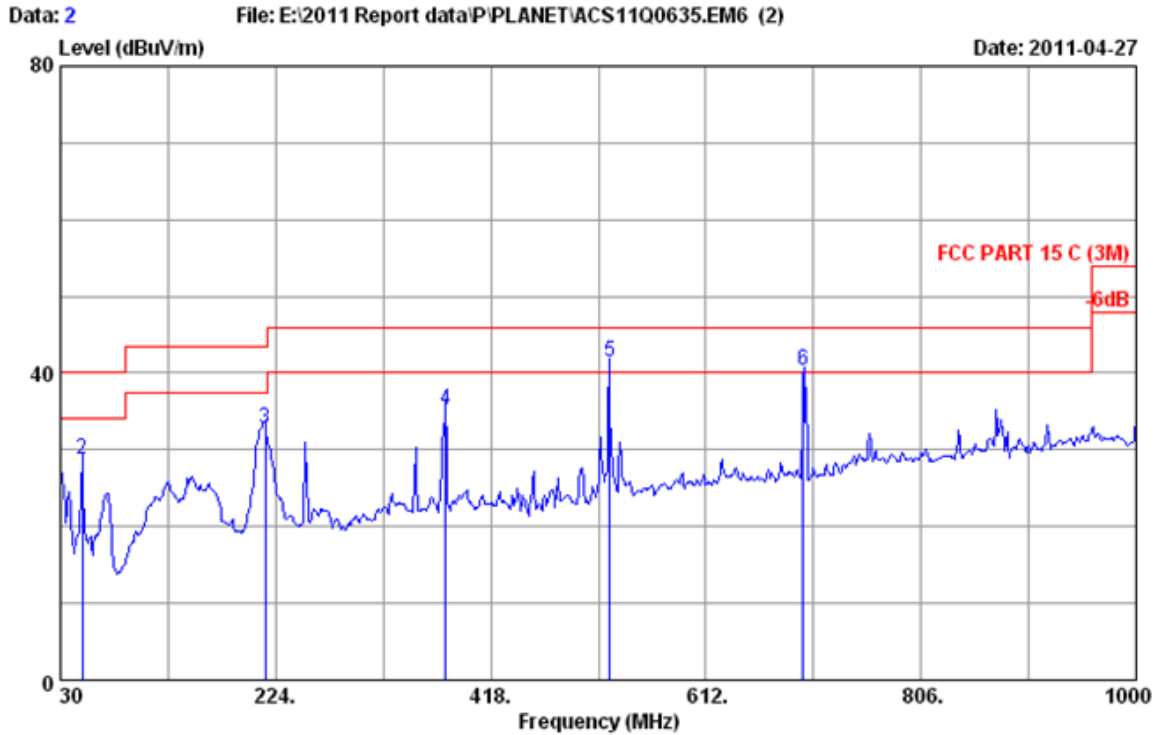

Site no. : 3m Chamber Data no. : 2
 Dis. / Ant. : 3m 2010 CBL6111C Ant. pol. : HORIZONTAL
 Limit : FCC PART 15 C (3M)
 Env. / Ins. : 24°C/56% Engineer : Sunny-lu
 EUT : 150Mbps 802.11n Wireless Broadband Router
 Power rating : DC 9V From Adapter input AC 120V/60Hz
 Test Mode : Tx Mode
 WNRT-617

No.	Freq. (MHz)	Ant. Factor (dB/m)	Cable Loss (dB)	Reading (dBuV)	Emission Level (dBuV/m)	Limits (dBuV/m)	Margin (dB)	Remark
1	30.000	20.00	0.61	5.74	26.35	40.00	13.65	QP
2	49.400	9.72	0.77	18.19	28.68	40.00	11.32	QP
3	214.300	10.02	1.85	20.92	32.79	43.50	10.71	QP
4	377.260	15.64	2.81	16.84	35.29	46.00	10.71	QP
5	525.030	18.35	3.69	19.30	41.34	46.00	4.66	QP
6	700.000	20.80	4.50	15.10	40.40	46.00	5.60	QP

Remarks: 1. Emission Level= Antenna Factor + Cable Loss + Reading.
 2. The emission levels that are 20dB below the official limit are not reported.

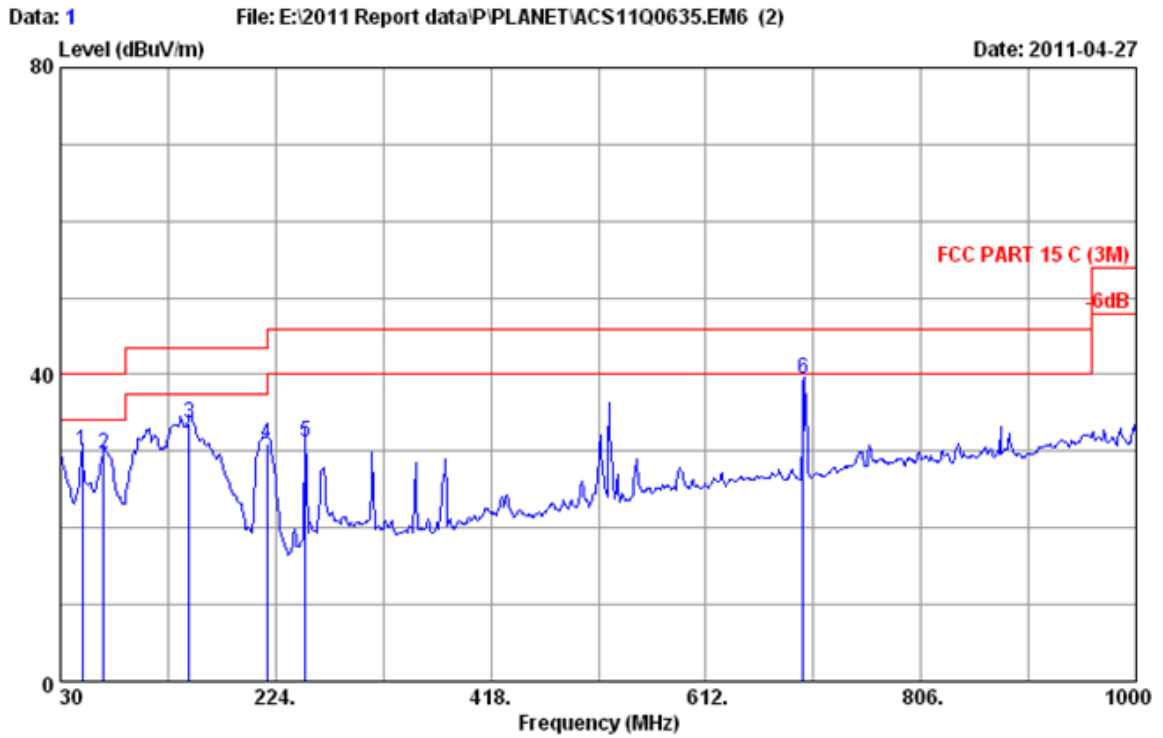

Site no. : 3m Chamber Data no. : 1
 Dis. / Ant. : 3m 2010 CBL6111C Ant. pol. : VERTICAL
 Limit : FCC PART 15 C (3M)
 Env. / Ins. : 24°C/56% Engineer : Sunny-lu
 EUT : 150Mbps 802.11n Wireless Broadband Router
 Power rating : DC 9V From Adapter input AC 120V/60Hz
 Test Mode : Tx Mode
 WNRT-617

No.	Freq. (MHz)	Ant. Factor (dB/m)	Cable Loss (dB)	Reading (dBuV)	Emission Level (dBuV/m)	Limits (dBuV/m)	Margin (dB)	Remark
1	49.400	9.72	0.77	19.58	30.07	40.00	9.93	QP
2	68.800	6.48	0.91	22.25	29.64	40.00	10.36	QP
3	146.400	11.84	1.14	20.78	33.76	43.50	9.74	QP
4	216.240	10.04	1.87	19.09	31.00	46.00	15.00	QP
5	251.160	12.90	2.18	16.05	31.13	46.00	14.87	QP
6	700.000	20.80	4.50	14.10	39.40	46.00	6.60	QP

Remarks: 1. Emission Level= Antenna Factor + Cable Loss + Reading.
 2. The emission levels that are 20dB below the official limit are not reported.

Frequency: 1GHz~18GHz

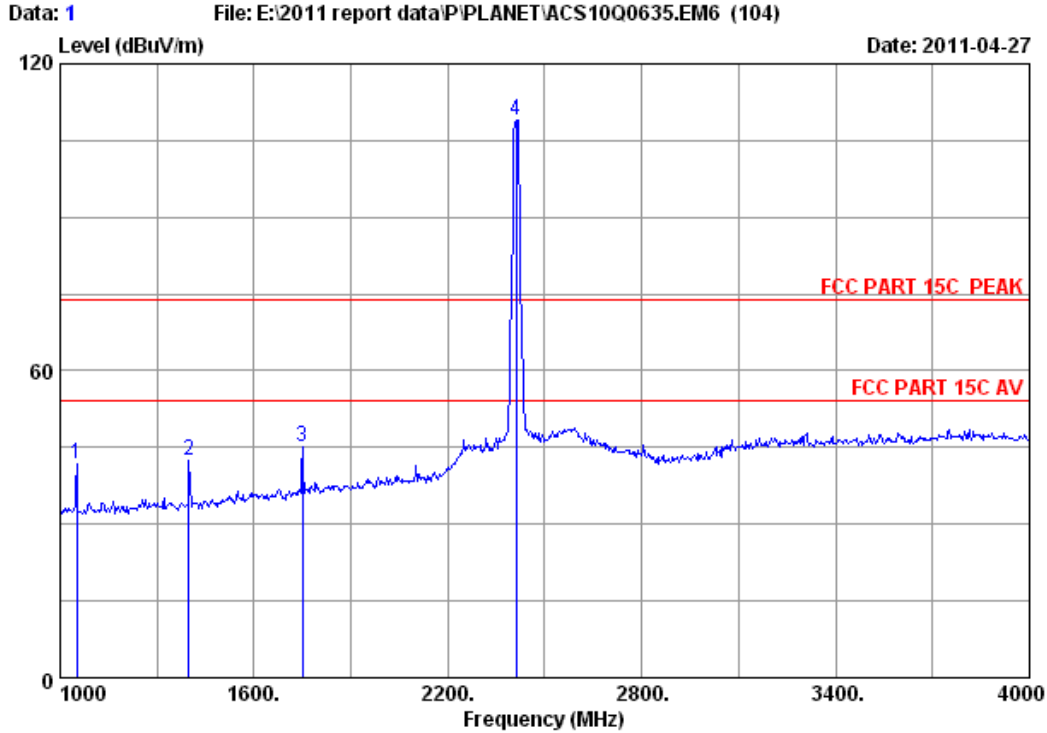

Site no. : 3m Chamber Data no. : 1
 Dis. / Ant. : 3m 3115(0911) Ant. pol. : VERTICAL
 Limit : FCC PART 15C PEAK
 Env. / Ins. : 23*C/54% Engineer : Leo-Li
 EUT : 150Mbps 802.11n Wireless Broadband Router
 Power : DC 9V From Adapter input AC 120V/60Hz
 Test mode : IEEE802.11b CH1 2412MHz Tx
 M/N : WNRT-617

	Ant.	Cable	Amp.	Emission					
Freq.	Factor	loss	Factor	Reading	Level	Limits	Margin	Remark	
(MHz)	(dB/m)	(dB)	(dB)	(dBuV)	(dBuV/m)	(dBuV/m)	(dB)		
1	1051.000	25.50	4.86	37.81	49.20	41.75	74.00	32.25	Peak
2	1399.000	26.19	5.50	37.18	47.97	42.48	74.00	31.52	Peak
3	1750.000	27.80	6.18	36.86	48.05	45.17	74.00	28.83	Peak
4	2412.000	29.45	7.43	36.62	108.79	109.05	74.00	-35.05	Peak

Remarks:

1. Emission Level= Antenna Factor + Cable Loss -Amp Factor + Reading.
2. The emission levels that are 20dB below the official limit are not reported.

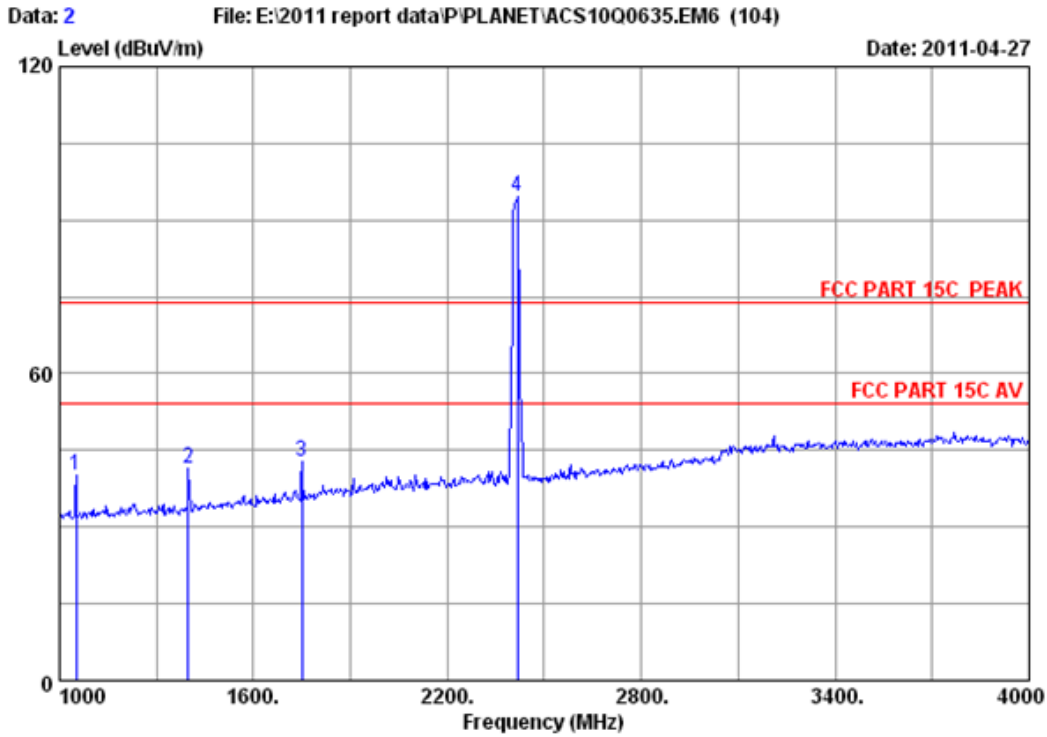

Site no. : 3m Chamber Data no. : 2
 Dis. / Ant. : 3m 3115(0911) Ant. pol. : HORIZONTAL
 Limit : FCC PART 15C PEAK
 Env. / Ins. : 23°C/54% Engineer : Leo-Li
 EUT : 150Mbps 802.11n Wireless Broadband Router
 Power : DC 9V From Adapter input AC 120V/60Hz
 Test mode : IEEE802.11b CH1 2412MHz Tx
 M/N : WNRT-617

	Ant. Freq. (MHz)	Ant. Factor (dB/m)	Cable loss (dB)	Amp. Factor (dB)	Reading (dBuV)	Emission Level (dBuV/m)	Limits (dBuV/m)	Margin (dB)	Remark
1	1051.000	25.50	4.86	37.81	47.68	40.23	74.00	33.77	Peak
2	1399.000	26.19	5.50	37.18	46.97	41.48	74.00	32.52	Peak
3	1750.000	27.80	6.18	36.86	45.79	42.91	74.00	31.09	Peak
4	2416.000	29.45	7.43	36.61	94.41	94.68	74.00	-20.68	Peak

Remarks:

1. Emission Level= Antenna Factor + Cable Loss -Amp Factor + Reading.
2. The emission levels that are 20dB below the official limit are not reported.

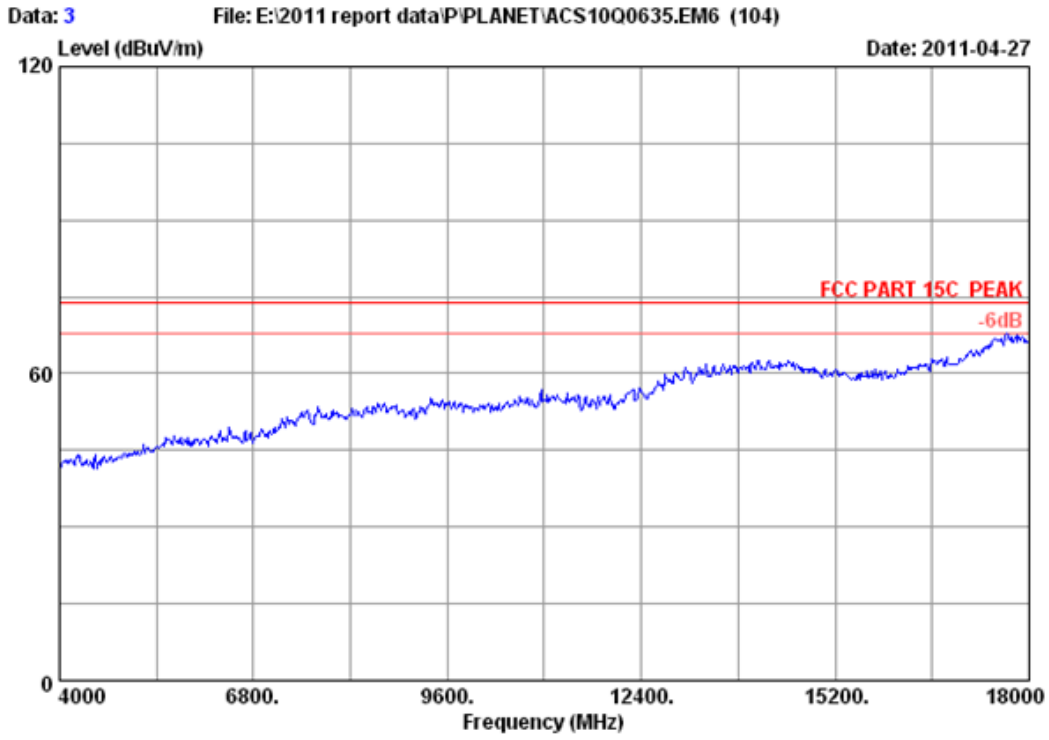

Site no.	: 3m Chamber	Data no. :	3
Dis. / Ant.	: 3m 3115(0911)	Ant. pol. :	HORIZONTAL
Limit	: FCC PART 15C PEAK		
Env. / Ins.	: 23°C/54%	Engineer :	Leo-Li
EUT	: 150Mbps 802.11n Wireless Broadband Router		
Power	: DC 9V From Adapter input AC 120V/60Hz		
Test mode	: IEEE802.11b CH1 2412MHz Tx		
M/N	: WNRT-617		

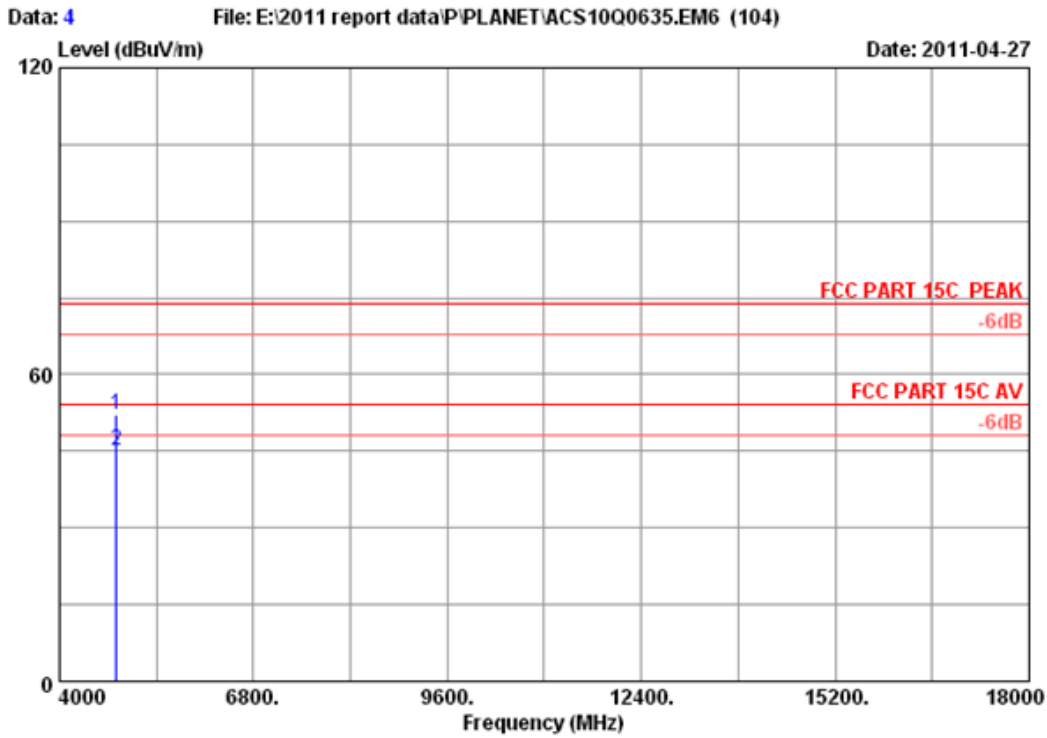

Site no. : 3m Chamber Data no. : 4
 Dis. / Ant. : 3m 3115(0911) Ant. pol. : HORIZONTAL
 Limit : FCC PART 15C PEAK
 Env. / Ins. : 23°C/54% Engineer : Leo-Li
 EUT : 150Mbps 802.11n Wireless Broadband Router
 Power : DC 9V From Adapter input AC 120V/60Hz
 Test mode : IEEE802.11b CH1 2412MHz Tx
 M/N : WNRT-617

	Freq. (MHz)	Ant. Factor (dB/m)	Cable loss (dB)	Amp. Factor (dB)	Reading (dBuV)	Emission Level (dBuV/m)	Limits (dBuV/m)	Margin (dB)	Remark
1	4824.000	34.32	10.64	35.08	42.37	52.25	74.00	21.75	Peak
2	4824.000	34.32	10.64	35.08	35.27	45.15	54.00	8.85	Average

Remarks:

1. Emission Level= Antenna Factor + Cable Loss -Amp Factor + Reading.
2. The emission levels that are 20dB below the official limit are not reported.

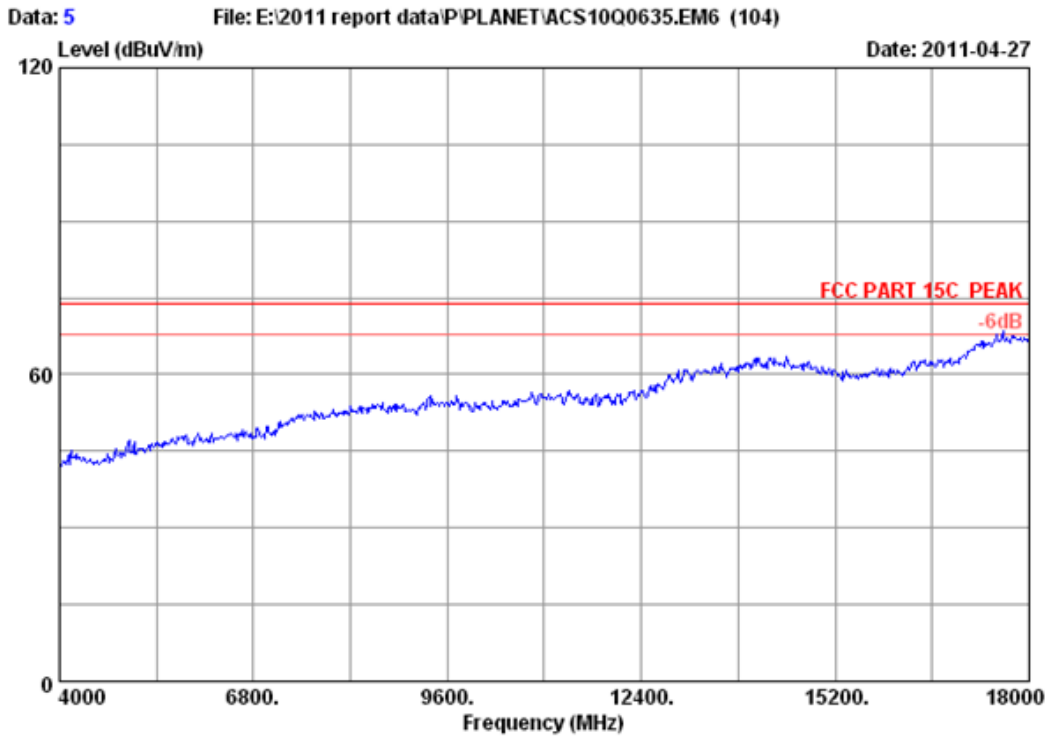

Site no. : 3m Chamber Data no. : 5
Dis. / Ant. : 3m 3115(0911) Ant. pol. : VERTICAL
Limit : FCC PART 15C PEAK
Env. / Ins. : 23°C/54% Engineer : Leo-Li
EUT : 150Mbps 802.11n Wireless Broadband Router
Power : DC 9V From Adapter input AC 120V/60Hz
Test mode : IEEE802.11b CH1 2412MHz Tx
M/N : WNRT-617

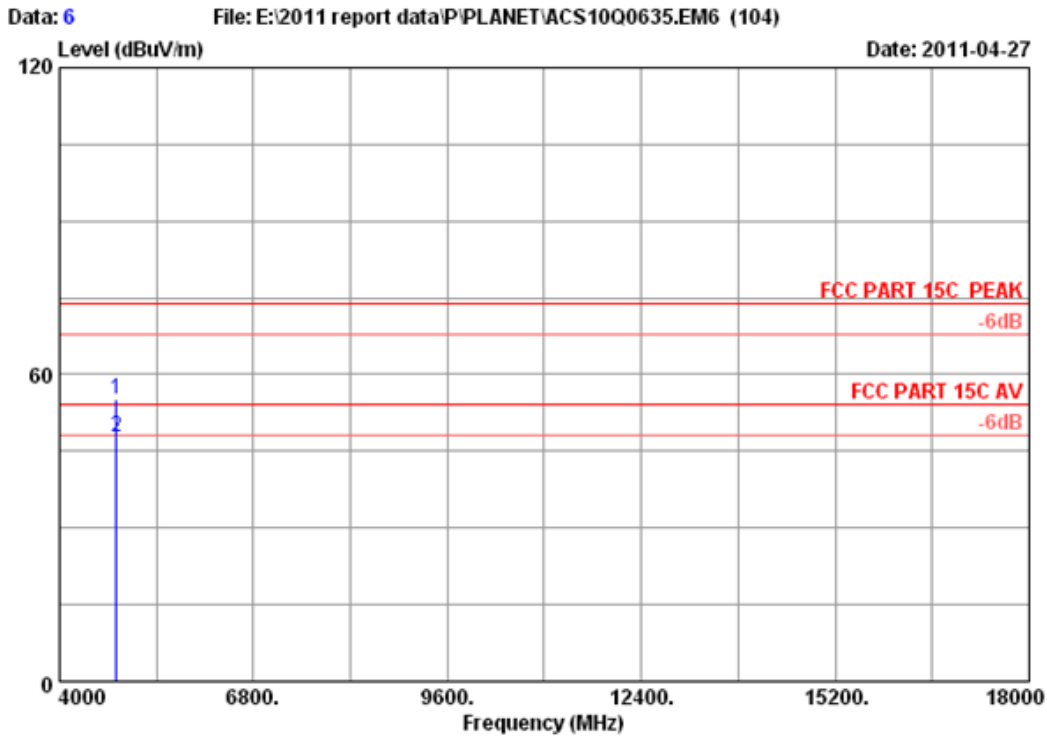

Site no. : 3m Chamber Data no. : 6
 Dis. / Ant. : 3m 3115(0911) Ant. pol. : VERTICAL
 Limit : FCC PART 15C PEAK
 Env. / Ins. : 23*C/54% Engineer : Leo-Li
 EUT : 150Mbps 802.11n Wireless Broadband Router
 Power : DC 9V From Adapter input AC 120V/60Hz
 Test mode : IEEE802.11b CH1 2412MHz Tx
 M/N : WNRT-617

	Freq. (MHz)	Ant. Factor (dB/m)	Cable loss (dB)	Amp. Factor (dB)	Reading (dBuV)	Emission Level (dBuV/m)	Limits (dBuV/m)	Margin (dB)	Remark
1	4824.000	34.32	10.64	35.08	45.26	55.14	74.00	18.86	Peak
2	4824.000	34.32	10.64	35.08	37.85	47.73	54.00	6.27	Average

Remarks:
 1. Emission Level= Antenna Factor + Cable Loss -Amp Factor + Reading.
 2. The emission levels that are 20dB below the official limit are not reported.

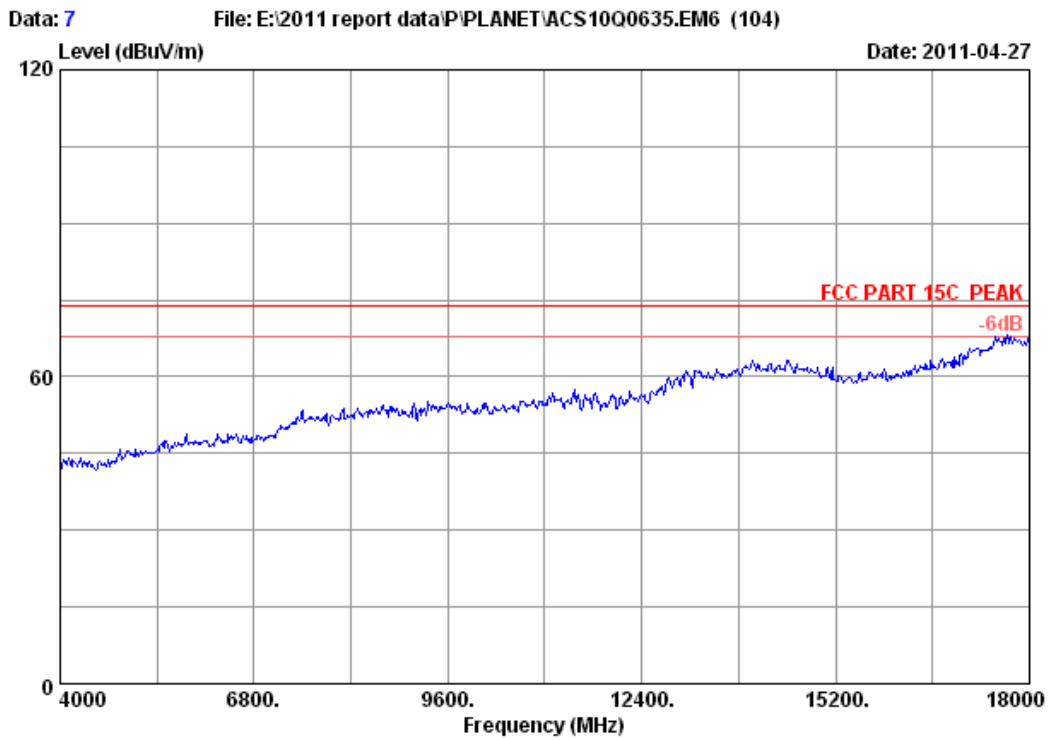

Site no. : 3m Chamber Data no. : 7
Dis. / Ant. : 3m 3115(0911) Ant. pol. : VERTICAL
Limit : FCC PART 15C PEAK
Env. / Ins. : 23*C/54% Engineer : Leo-Li
EUT : 150Mbps 802.11n Wireless Broadband Router
Power : DC 9V From Adapter input AC 120V/60Hz
Test mode : IEEE802.11b CH6 2437MHz Tx
M/N : WNRT-617

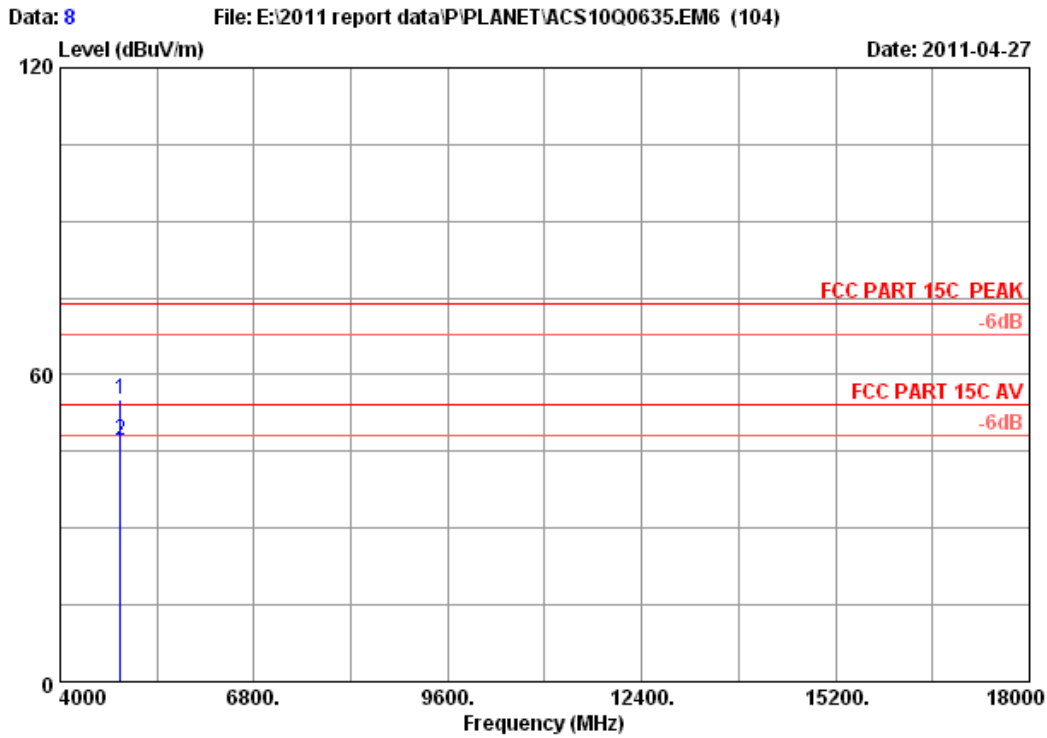

Site no. : 3m Chamber Data no. : 8
 Dis. / Ant. : 3m 3115(0911) Ant. pol. : VERTICAL
 Limit : FCC PART 15C PEAK
 Env. / Ins. : 23*C/54% Engineer : Leo-Li
 EUT : 150Mbps 802.11n Wireless Broadband Router
 Power : DC 9V From Adapter input AC 120V/60Hz
 Test mode : IEEE802.11b CH6 2437MHz Tx
 M/N : WNRT-617

	Freq. (MHz)	Ant. Factor (dB/m)	Cable loss (dB)	Amp. Factor (dB)	Reading (dBuV)	Emission Level (dBuV/m)	Limits (dBuV/m)	Margin (dB)	Remark
1	4874.000	34.41	10.69	35.03	45.13	55.20	74.00	18.80	Peak
2	4874.000	34.41	10.69	35.03	37.16	47.23	54.00	6.77	Average

Remarks:

1. Emission Level= Antenna Factor + Cable Loss -Amp Factor + Reading.
2. The emission levels that are 20dB below the official limit are not reported.

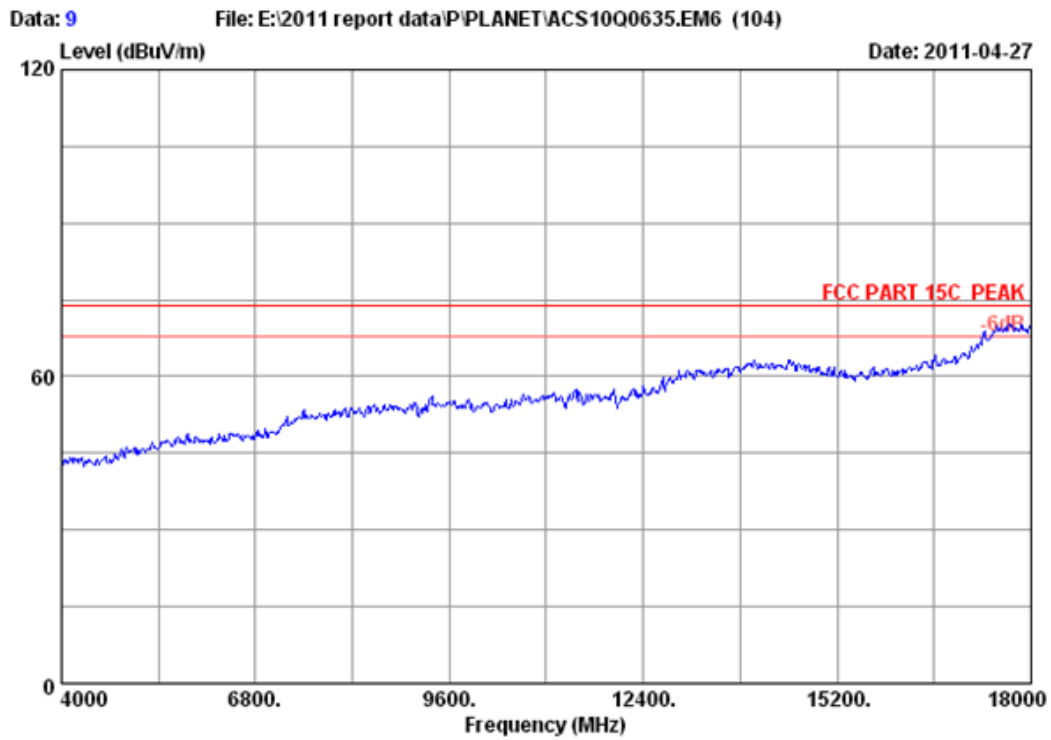

Site no. : 3m Chamber Data no. : 9
Dis. / Ant. : 3m 3115(0911) Ant. pol. : HORIZONTAL
Limit : FCC PART 15C PEAK
Env. / Ins. : 23*C/54% Engineer : Leo-Li
EUT : 150Mbps 802.11n Wireless Broadband Router
Power : DC 9V From Adapter input AC 120V/60Hz
Test mode : IEEE802.11b CH6 2437MHz Tx
M/N : WNRT-617

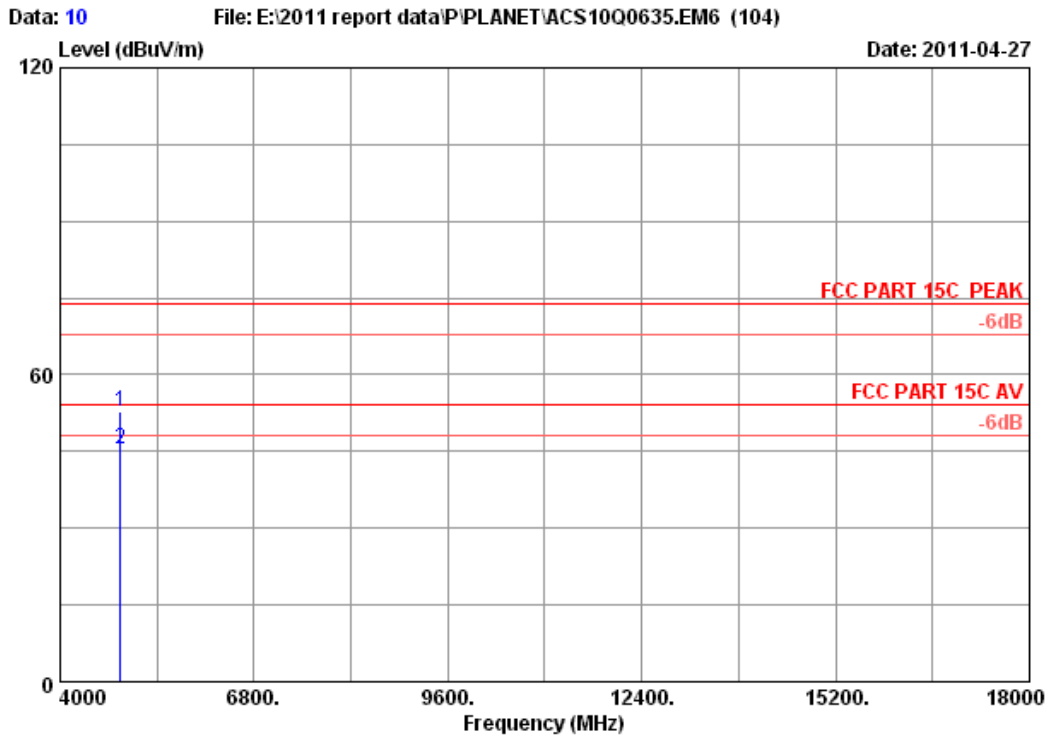

Site no. : 3m Chamber Data no. : 10
 Dis. / Ant. : 3m 3115(0911) Ant. pol. : HORIZONTAL
 Limit : FCC PART 15C PEAK
 Env. / Ins. : 23*C/54% Engineer : Leo-Li
 EUT : 150Mbps 802.11n Wireless Broadband Router
 Power : DC 9V From Adapter input AC 120V/60Hz
 Test mode : IEEE802.11b CH6 2437MHz Tx
 M/N : WNRT-617

	Freq. (MHz)	Ant. Factor (dB/m)	Cable loss (dB)	Amp. Factor (dB)	Reading (dBUV)	Emission Level (dBUV/m)	Limits (dBUV/m)	Margin (dB)	Remark
1	4874.000	34.41	10.69	35.03	42.68	52.75	74.00	21.25	Peak
2	4874.000	34.41	10.69	35.03	35.42	45.49	54.00	8.51	Average

Remarks:

1. Emission Level= Antenna Factor + Cable Loss -Amp Factor + Reading.
2. The emission levels that are 20dB below the official limit are not reported.

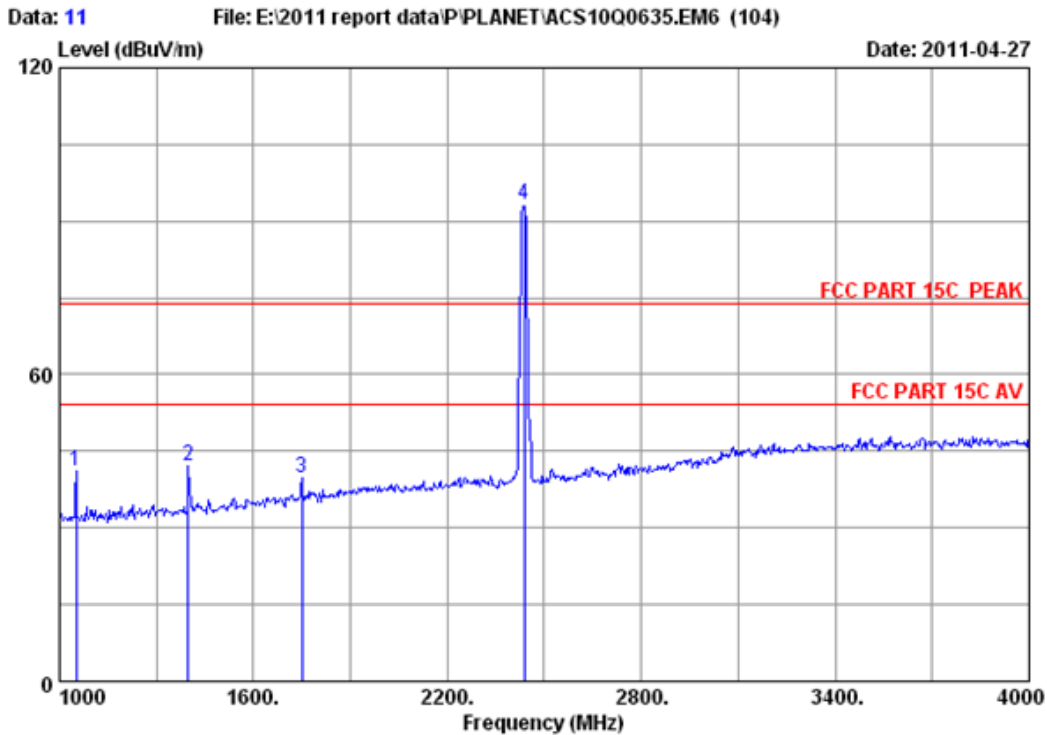

Site no. : 3m Chamber Data no. : 11
 Dis. / Ant. : 3m 3115(0911) Ant. pol. : HORIZONTAL
 Limit : FCC PART 15C PEAK
 Env. / Ins. : 23°C/54% Engineer : Leo-Li
 EUT : 150Mbps 802.11n Wireless Broadband Router
 Power : DC 9V From Adapter input AC 120V/60Hz
 Test mode : IEEE802.11b CH6 2437MHz Tx
 M/N : WNRT-617

	Ant. Freq. (MHz)	Ant. Factor (dB/m)	Cable loss (dB)	Amp. Factor (dB)	Reading (dBuV)	Emission Level (dBuV/m)	Limits (dBuV/m)	Margin (dB)	Remark
1	1051.000	25.50	4.86	37.81	48.55	41.10	74.00	32.90	Peak
2	1399.000	26.19	5.50	37.18	47.52	42.03	74.00	31.97	Peak
3	1750.000	27.80	6.18	36.86	42.53	39.65	74.00	34.35	Peak
4	2437.000	29.47	7.46	36.61	92.89	93.21	74.00	-19.21	Peak

Remarks:

1. Emission Level= Antenna Factor + Cable Loss -Amp Factor + Reading.
2. The emission levels that are 20dB below the official limit are not reported.

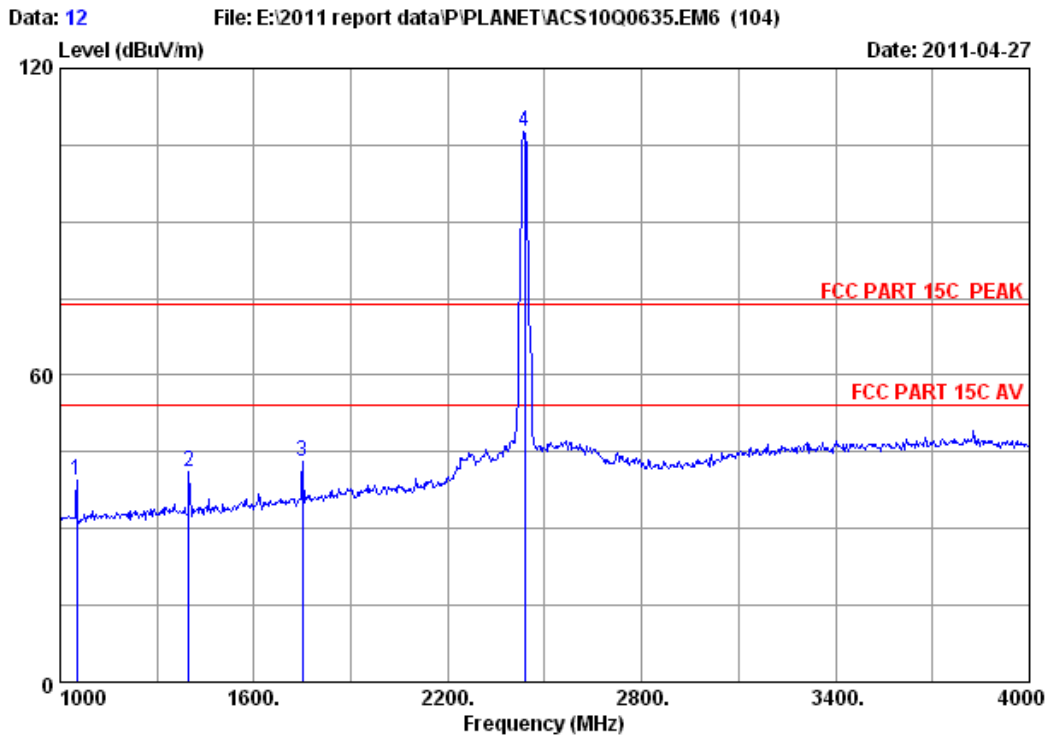

Site no. : 3m Chamber Data no. : 12
 Dis. / Ant. : 3m 3115(0911) Ant. pol. : VERTICAL
 Limit : FCC PART 15C PEAK
 Env. / Ins. : 23°C/54% Engineer : Leo-Li
 EUT : 150Mbps 802.11n Wireless Broadband Router
 Power : DC 9V From Adapter input AC 120V/60Hz
 Test mode : IEEE802.11b CH6 2437MHz Tx
 M/N : WNRT-617

	Ant. Freq. (MHz)	Ant. Factor (dB/m)	Cable loss (dB)	Amp. Factor (dB)	Reading (dBuV)	Emission Level (dBuV/m)	Limits (dBuV/m)	Margin (dB)	Remark
1	1051.000	25.50	4.86	37.81	46.84	39.39	74.00	34.61	Peak
2	1399.000	26.19	5.50	37.18	46.65	41.16	74.00	32.84	Peak
3	1750.000	27.80	6.18	36.86	46.14	43.26	74.00	30.74	Peak
4	2437.000	29.47	7.46	36.61	107.22	107.54	74.00	-33.54	Peak

Remarks:

1. Emission Level= Antenna Factor + Cable Loss -Amp Factor + Reading.
2. The emission levels that are 20dB below the official limit are not reported.

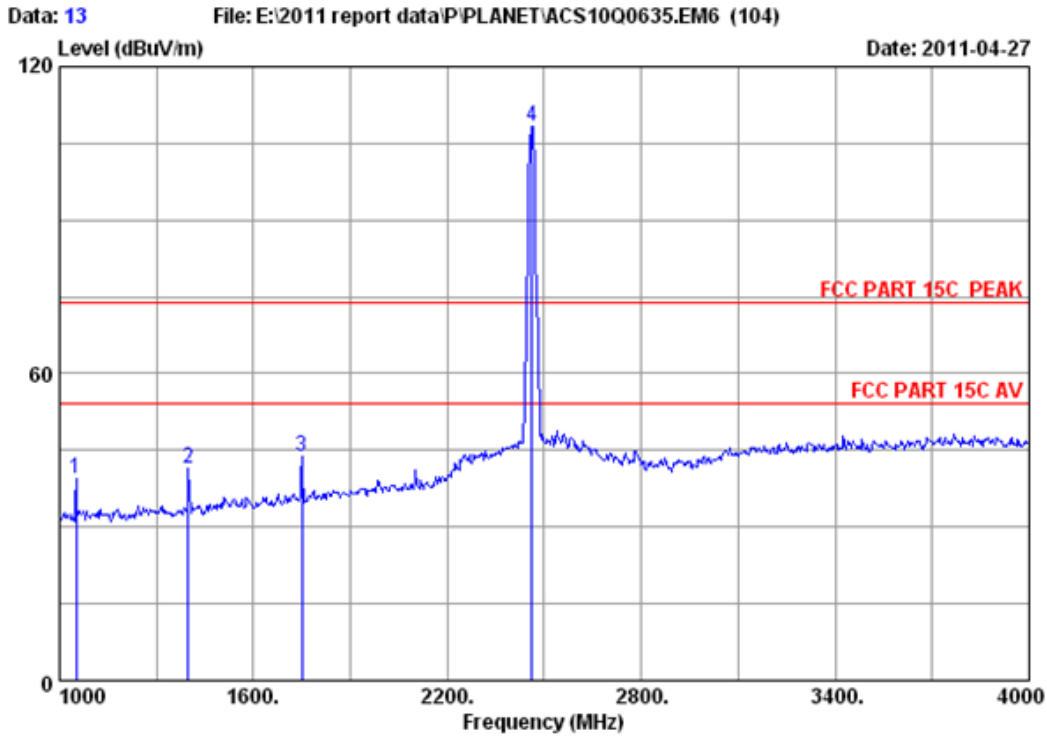

Site no. : 3m Chamber Data no. : 13
 Dis. / Ant. : 3m 3115(0911) Ant. pol. : VERTICAL
 Limit : FCC PART 15C PEAK
 Env. / Ins. : 23°C/54% Engineer : Leo-Li
 EUT : 150Mbps 802.11n Wireless Broadband Router
 Power : DC 9V From Adapter input AC 120V/60Hz
 Test mode : IEEE802.11b CH11 2462MHz Tx
 M/N : WNRT-617

	Ant. Freq. (MHz)	Ant. Factor (dB/m)	Cable loss (dB)	Amp. Factor (dB)	Reading (dBuV)	Emission Level (dBuV/m)	Limits (dBuV/m)	Margin (dB)	Remark
1	1051.000	25.50	4.86	37.81	46.83	39.38	74.00	34.62	Peak
2	1399.000	26.19	5.50	37.18	47.05	41.56	74.00	32.44	Peak
3	1750.000	27.80	6.18	36.86	46.73	43.85	74.00	30.15	Peak
4	2462.000	29.48	7.54	36.61	107.98	108.39	74.00	-34.39	Peak

Remarks:

1. Emission Level= Antenna Factor + Cable Loss -Amp Factor + Reading.
2. The emission levels that are 20dB below the official limit are not reported.

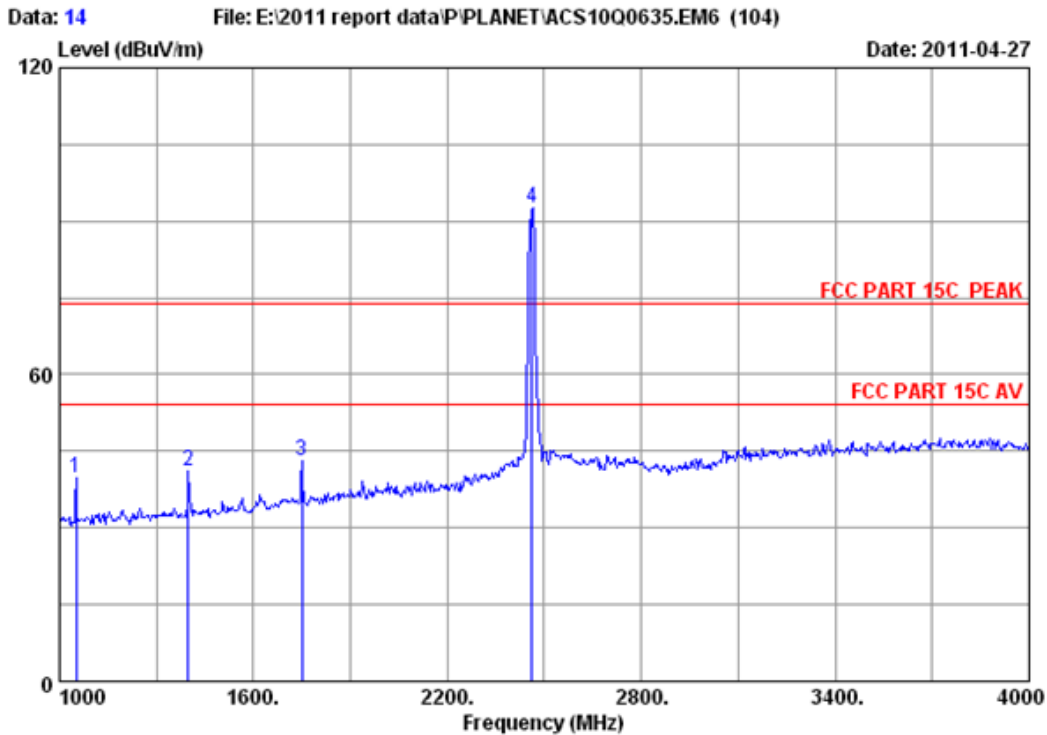

Site no. : 3m Chamber Data no. : 14
 Dis. / Ant. : 3m 3115(0911) Ant. pol. : HORIZONTAL
 Limit : FCC PART 15C PEAK
 Env. / Ins. : 23°C/54% Engineer : Leo-Li
 EUT : 150Mbps 802.11n Wireless Broadband Router
 Power : DC 9V From Adapter input AC 120V/60Hz
 Test mode : IEEE802.11b CH11 2462MHz Tx
 M/N : WNRT-617

	Ant. Freq. (MHz)	Ant. Factor (dB/m)	Cable loss (dB)	Amp. Factor (dB)	Reading (dBuV)	Emission Level (dBuV/m)	Limits (dBuV/m)	Margin (dB)	Remark
1	1051.000	25.50	4.86	37.81	47.08	39.63	74.00	34.37	Peak
2	1399.000	26.19	5.50	37.18	46.69	41.20	74.00	32.80	Peak
3	1750.000	27.80	6.18	36.86	46.05	43.17	74.00	30.83	Peak
4	2462.000	29.48	7.54	36.61	92.17	92.58	74.00	-18.58	Peak

Remarks:

1. Emission Level= Antenna Factor + Cable Loss -Amp Factor + Reading.
2. The emission levels that are 20dB below the official limit are not reported.

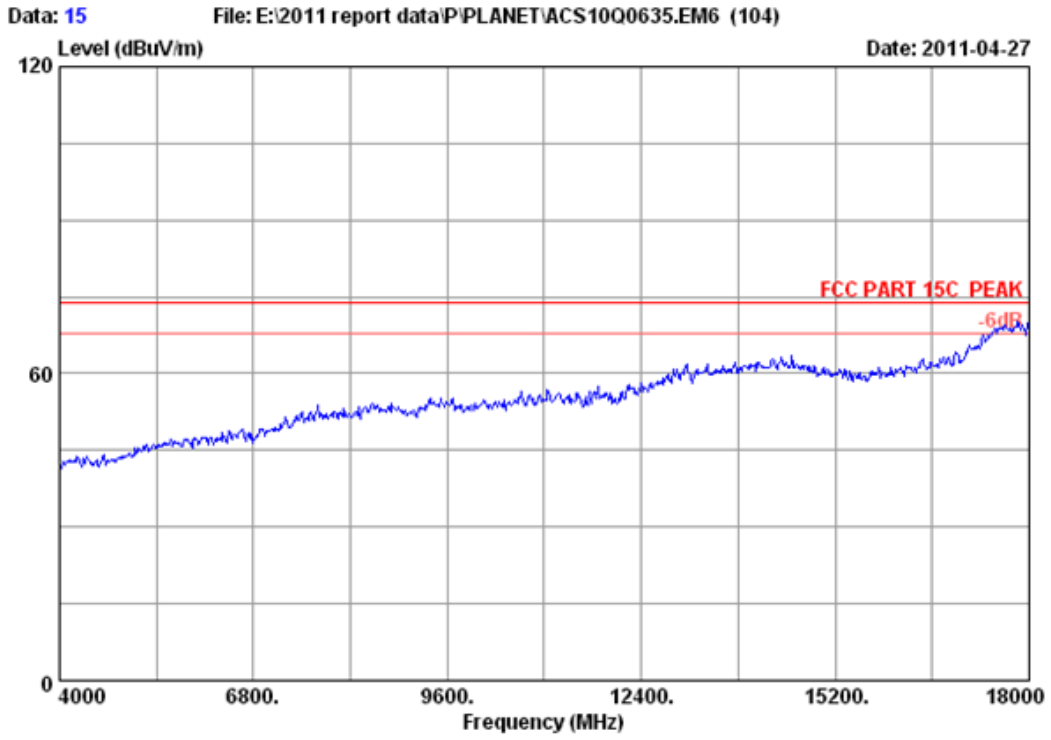

Site no.	: 3m Chamber	Data no. :	15
Dis. / Ant.	: 3m 3115(0911)	Ant. pol. :	HORIZONTAL
Limit	: FCC PART 15C PEAK		
Env. / Ins.	: 23°C/54%	Engineer :	Leo-Li
EUT	: 150Mbps 802.11n Wireless Broadband Router		
Power	: DC 9V From Adapter input AC 120V/60Hz		
Test mode	: IEEE802.11b CH11 2462MHz Tx		
M/N	: WNRT-617		

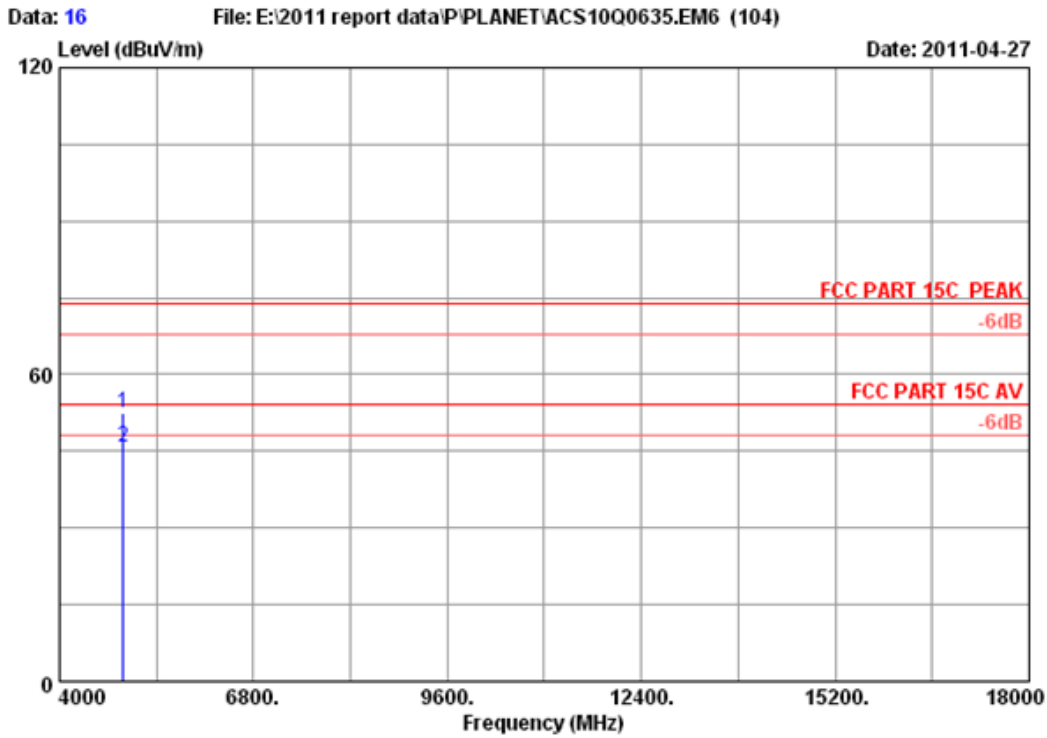

Site no. : 3m Chamber Data no. : 16
 Dis. / Ant. : 3m 3115(0911) Ant. pol. : HORIZONTAL
 Limit : FCC PART 15C PEAK
 Env. / Ins. : 23*C/54% Engineer : Leo-Li
 EUT : 150Mbps 802.11n Wireless Broadband Router
 Power : DC 9V From Adapter input AC 120V/60Hz
 Test mode : IEEE802.11b CH11 2462MHz Tx
 M/N : WNRT-617

	Ant. Freq. (MHz)	Ant. Factor (dB/m)	Cable loss (dB)	Amp. Factor (dB)	Reading (dBuV)	Emission Level (dBuV/m)	Limits (dBuV/m)	Margin (dB)	Remark
1	4924.000	34.49	10.76	34.98	42.13	52.40	74.00	21.60	Peak
2	4924.000	34.49	10.76	34.98	35.42	45.69	54.00	8.31	Average

Remarks:

1. Emission Level= Antenna Factor + Cable Loss -Amp Factor + Reading.
2. The emission levels that are 20dB below the official limit are not reported.

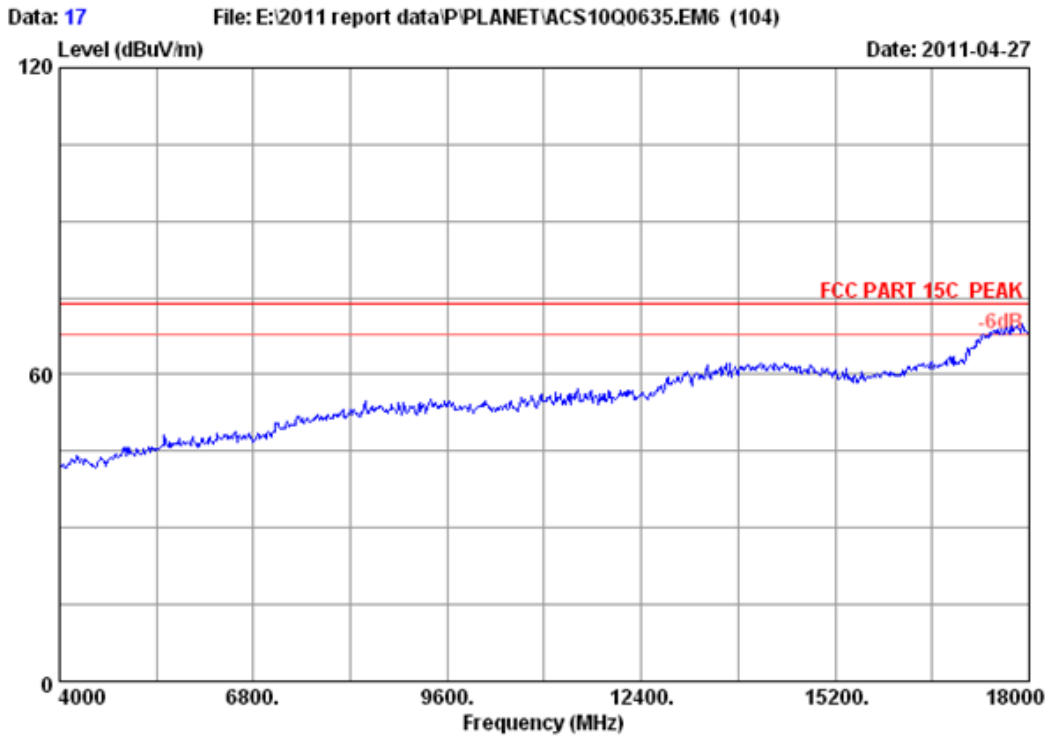

Site no.	: 3m Chamber	Data no. :	17
Dis. / Ant.	: 3m 3115(0911)	Ant. pol. :	VERTICAL
Limit	: FCC PART 15C PEAK		
Env. / Ins.	: 23°C/54%	Engineer :	Leo-Li
EUT	: 150Mbps 802.11n Wireless Broadband Router		
Power	: DC 9V From Adapter input AC 120V/60Hz		
Test mode	: IEEE802.11b CH11 2462MHz Tx		
M/N	: WNRT-617		

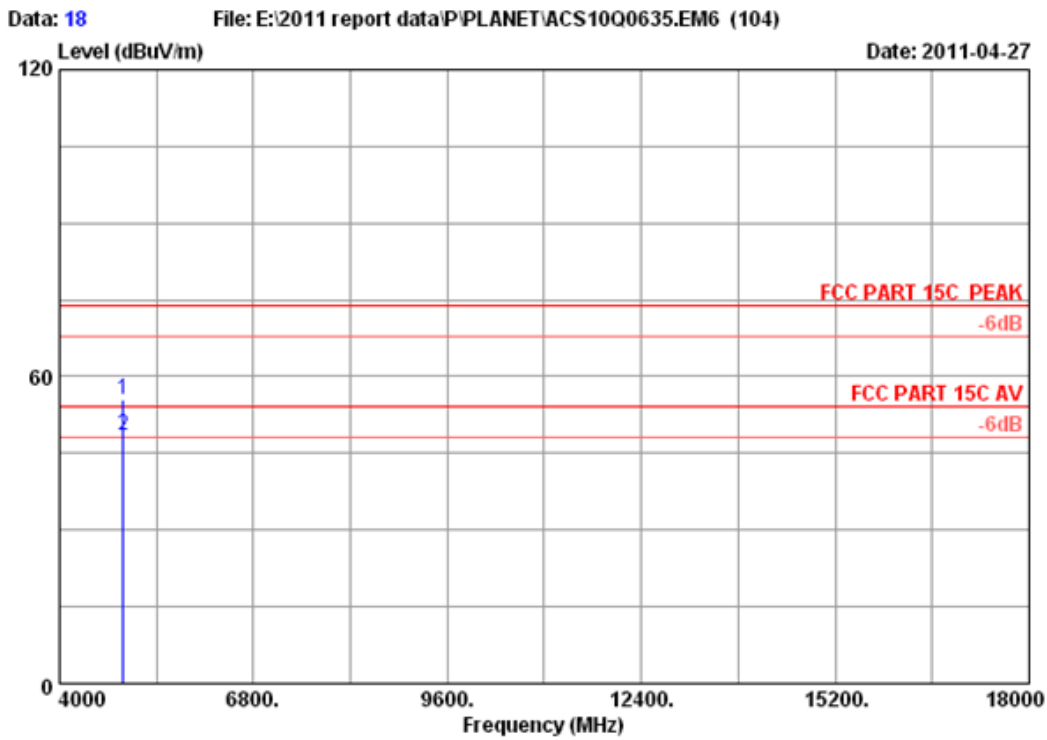

Site no. : 3m Chamber Data no. : 18
 Dis. / Ant. : 3m 3115(0911) Ant. pol. : VERTICAL
 Limit : FCC PART 15C PEAK
 Env. / Ins. : 23°C/54% Engineer : Leo-Li
 EUT : 150Mbps 802.11n Wireless Broadband Router
 Power : DC 9V From Adapter input AC 120V/60Hz
 Test mode : IEEE802.11b CH11 2462MHz Tx
 M/N : WNRT-617

	Freq. (MHz)	Ant. Factor (dB/m)	Cable loss (dB)	Amp. Factor (dB)	Reading (dBuV)	Emission Level (dBuV/m)	Limits (dBuV/m)	Margin (dB)	Remark
1	4924.000	34.49	10.76	34.98	45.32	55.59	74.00	18.41	Peak
2	4924.000	34.49	10.76	34.98	38.14	48.41	54.00	5.59	Average

Remarks:

1. Emission Level= Antenna Factor + Cable Loss -Amp Factor + Reading.
2. The emission levels that are 20dB below the official limit are not reported.

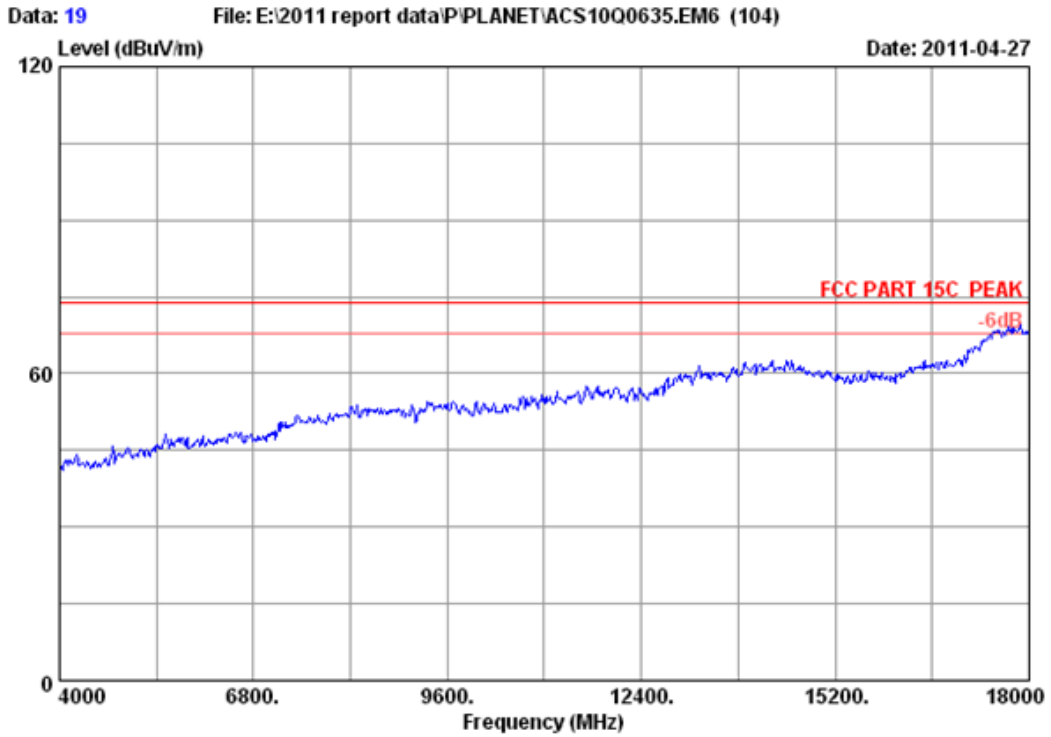

Site no.	: 3m Chamber	Data no. :	19
Dis. / Ant.	: 3m 3115(0911)	Ant. pol. :	VERTICAL
Limit	: FCC PART 15C PEAK		
Env. / Ins.	: 23°C/54%	Engineer :	Leo-Li
EUT	: 150Mbps 802.11n Wireless Broadband Router		
Power	: DC 9V From Adapter input AC 120V/60Hz		
Test mode	: IEEE802.11g CH1 2412MHz Tx		
M/N	: WNRT-617		

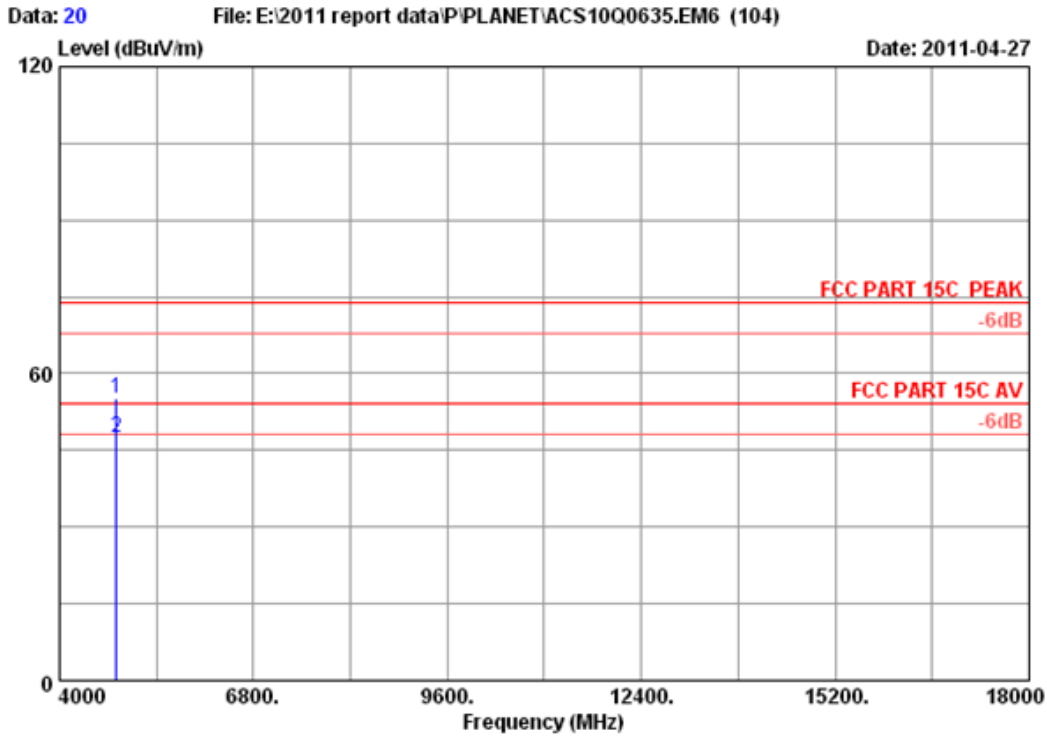

Site no. : 3m Chamber Data no. : 20
 Dis. / Ant. : 3m 3115(0911) Ant. pol. : VERTICAL
 Limit : FCC PART 15C PEAK
 Env. / Ins. : 23°C/54% Engineer : Leo-Li
 EUT : 150Mbps 802.11n Wireless Broadband Router
 Power : DC 9V From Adapter input AC 120V/60Hz
 Test mode : IEEE802.11g CH1 2412MHz Tx
 M/N : WNRT-617

	Freq. (MHz)	Ant. Factor (dB/m)	Cable loss (dB)	Amp. Factor (dB)	Reading (dBuV)	Emission Level (dBuV/m)	Limits (dBuV/m)	Margin (dB)	Remark
1	4824.000	34.32	10.64	35.08	45.37	55.25	74.00	18.75	Peak
2	4824.000	34.32	10.64	35.08	37.43	47.31	54.00	6.69	Average

Remarks:

1. Emission Level= Antenna Factor + Cable Loss -Amp Factor + Reading.
2. The emission levels that are 20dB below the official limit are not reported.

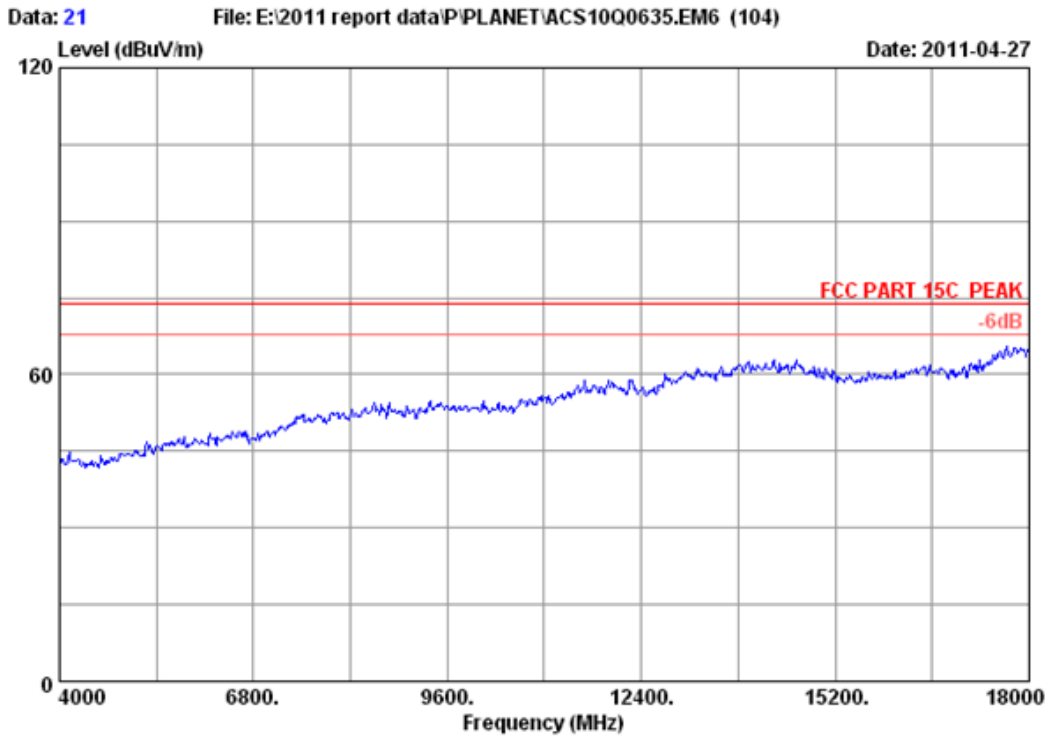

Site no.	: 3m Chamber	Data no. :	21
Dis. / Ant.	: 3m 3115(0911)	Ant. pol. :	HORIZONTAL
Limit	: FCC PART 15C PEAK		
Env. / Ins.	: 23°C/54%	Engineer :	Leo-Li
EUT	: 150Mbps 802.11n Wireless Broadband Router		
Power	: DC 9V From Adapter input AC 120V/60Hz		
Test mode	: IEEE802.11g CH1 2412MHz Tx		
M/N	: WNRT-617		

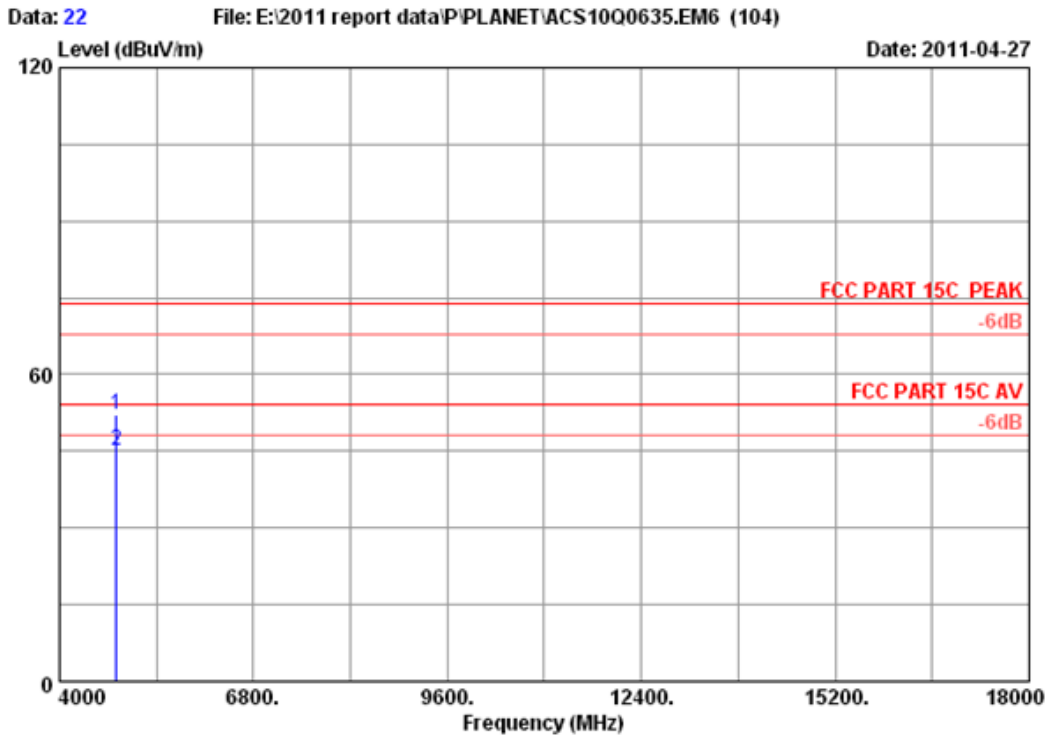

Site no. : 3m Chamber Data no. : 22
 Dis. / Ant. : 3m 3115(0911) Ant. pol. : HORIZONTAL
 Limit : FCC PART 15C PEAK
 Env. / Ins. : 23*C/54% Engineer : Leo-Li
 EUT : 150Mbps 802.11n Wireless Broadband Router
 Power : DC 9V From Adapter input AC 120V/60Hz
 Test mode : IEEE802.11g CH1 2412MHz Tx
 M/N : WNRT-617

	Freq. (MHz)	Ant. Factor (dB/m)	Cable loss (dB)	Amp. Factor (dB)	Reading (dBuV)	Emission Level (dBuV/m)	Limits (dBuV/m)	Margin (dB)	Remark
1	4824.000	34.32	10.64	35.08	42.37	52.25	74.00	21.75	Peak
2	4824.000	34.32	10.64	35.08	35.28	45.16	54.00	8.84	Average

Remarks:

1. Emission Level= Antenna Factor + Cable Loss -Amp Factor + Reading.
2. The emission levels that are 20dB below the official limit are not reported.

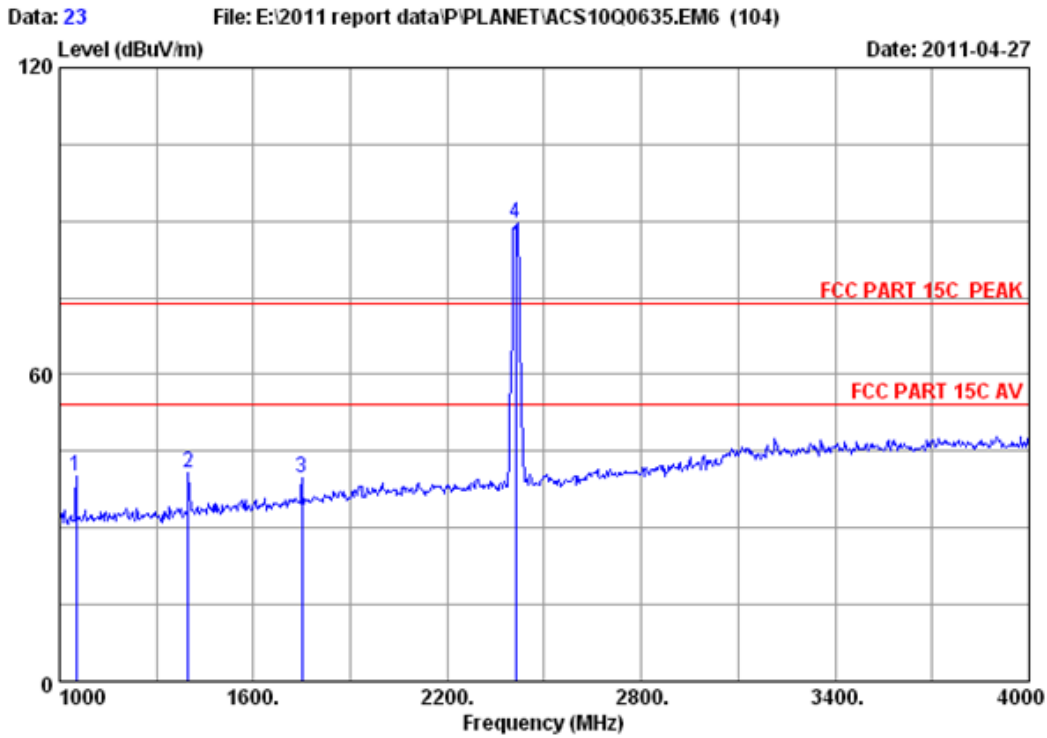

Site no. : 3m Chamber Data no. : 23
 Dis. / Ant. : 3m 3115(0911) Ant. pol. : HORIZONTAL
 Limit : FCC PART 15C PEAK
 Env. / Ins. : 23°C/54% Engineer : Leo-Li
 EUT : 150Mbps 802.11n Wireless Broadband Router
 Power : DC 9V From Adapter input AC 120V/60Hz
 Test mode : IEEE802.11g CH1 2412MHz Tx
 M/N : WNRT-617

	Ant. Freq. (MHz)	Ant. Factor (dB/m)	Cable loss (dB)	Amp. Factor (dB)	Reading (dBuV)	Emission Level (dBuV/m)	Limits (dBuV/m)	Margin (dB)	Remark
1	1051.000	25.50	4.86	37.81	47.59	40.14	74.00	33.86	Peak
2	1399.000	26.19	5.50	37.18	46.40	40.91	74.00	33.09	Peak
3	1750.000	27.80	6.18	36.86	42.54	39.66	74.00	34.34	Peak
4	2412.000	29.45	7.43	36.62	89.33	89.59	74.00	-15.59	Peak

Remarks:

1. Emission Level= Antenna Factor + Cable Loss -Amp Factor + Reading.
2. The emission levels that are 20dB below the official limit are not reported.

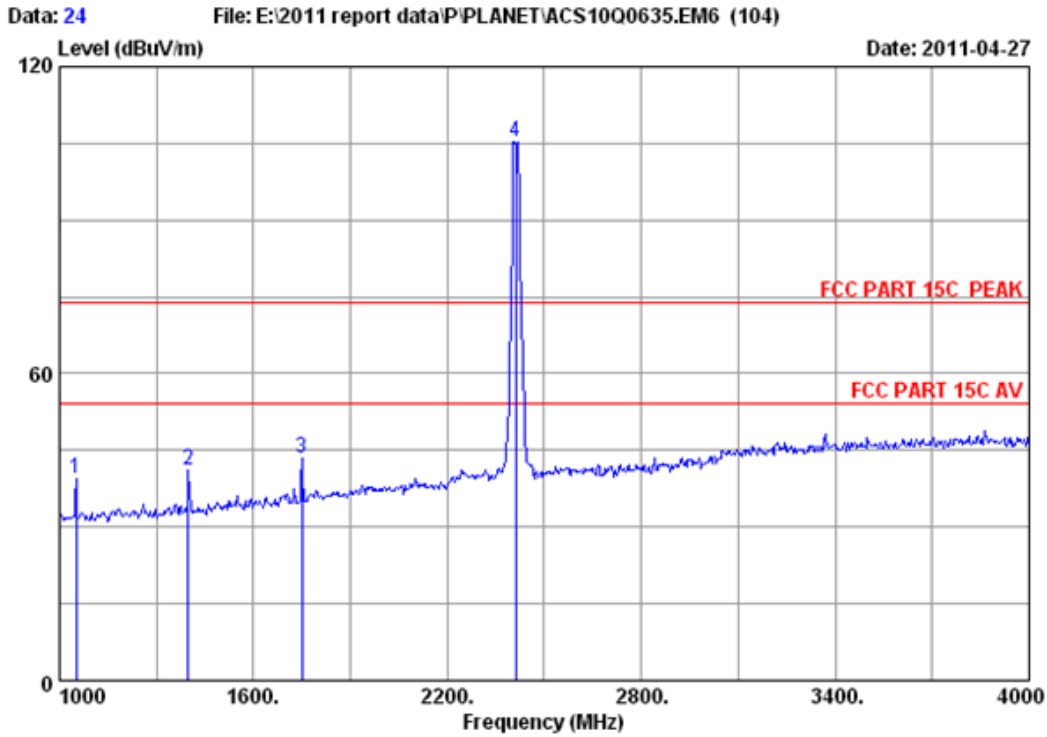

Site no. : 3m Chamber Data no. : 24
 Dis. / Ant. : 3m 3115(0911) Ant. pol. : VERTICAL
 Limit : FCC PART 15C PEAK
 Env. / Ins. : 23°C/54% Engineer : Leo-Li
 EUT : 150Mbps 802.11n Wireless Broadband Router
 Power : DC 9V From Adapter input AC 120V/60Hz
 Test mode : IEEE802.11g CH1 2412MHz Tx
 M/N : WNRT-617

	Ant. Freq. (MHz)	Ant. Factor (dB/m)	Cable loss (dB)	Amp. Factor (dB)	Reading (dBuV)	Emission Level (dBuV/m)	Limits (dBuV/m)	Margin (dB)	Remark
1	1051.000	25.50	4.86	37.81	46.80	39.35	74.00	34.65	Peak
2	1399.000	26.19	5.50	37.18	46.61	41.12	74.00	32.88	Peak
3	1750.000	27.80	6.18	36.86	46.33	43.45	74.00	30.55	Peak
4	2412.000	29.45	7.43	36.62	105.16	105.42	74.00	-31.42	Peak

Remarks:

1. Emission Level= Antenna Factor + Cable Loss -Amp Factor + Reading.
2. The emission levels that are 20dB below the official limit are not reported.

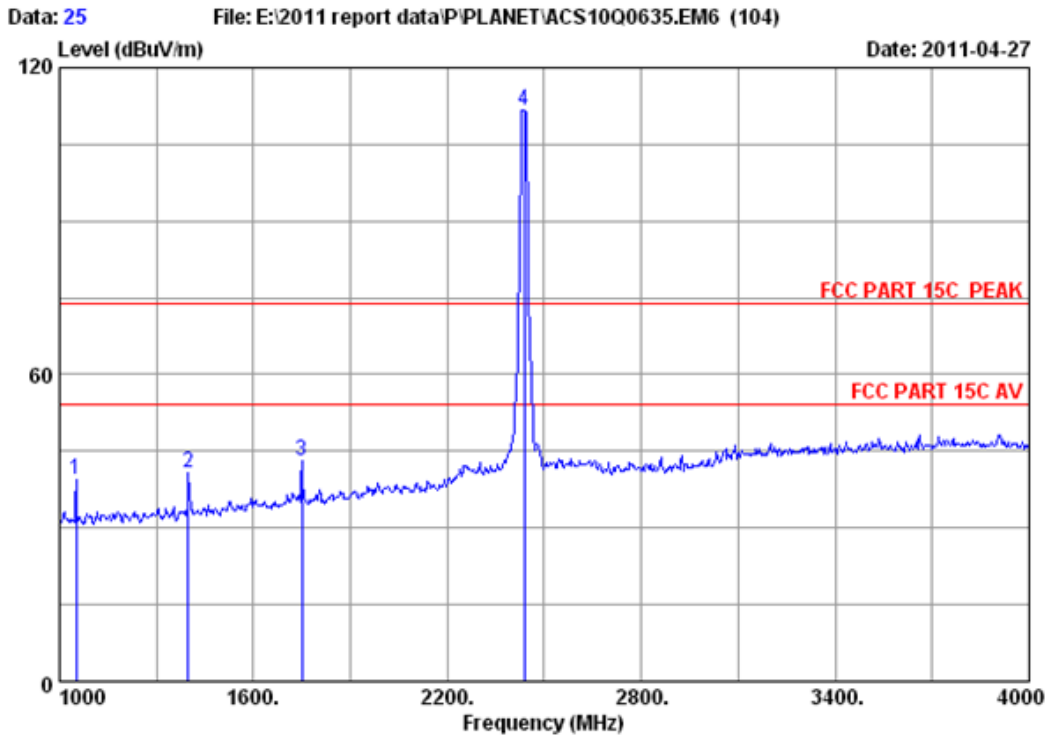

Site no. : 3m Chamber Data no. : 25
 Dis. / Ant. : 3m 3115(0911) Ant. pol. : VERTICAL
 Limit : FCC PART 15C PEAK
 Env. / Ins. : 23*C/54% Engineer : Leo-Li
 EUT : 150Mbps 802.11n Wireless Broadband Router
 Power : DC 9V From Adapter input AC 120V/60Hz
 Test mode : IEEE802.11g CH6 2437MHz Tx
 M/N : WNRT-617

	Ant. Freq. (MHz)	Ant. Factor (dB/m)	Cable loss (dB)	Amp. Factor (dB)	Reading (dBuV)	Emission Level (dBuV/m)	Limits (dBuV/m)	Margin (dB)	Remark
1	1051.000	25.50	4.86	37.81	46.81	39.36	74.00	34.64	Peak
2	1399.000	26.19	5.50	37.18	46.38	40.89	74.00	33.11	Peak
3	1750.000	27.80	6.18	36.86	46.04	43.16	74.00	30.84	Peak
4	2437.000	29.47	7.46	36.61	111.35	111.67	74.00	-37.67	Peak

Remarks:

1. Emission Level= Antenna Factor + Cable Loss -Amp Factor + Reading.
2. The emission levels that are 20dB below the official limit are not reported.

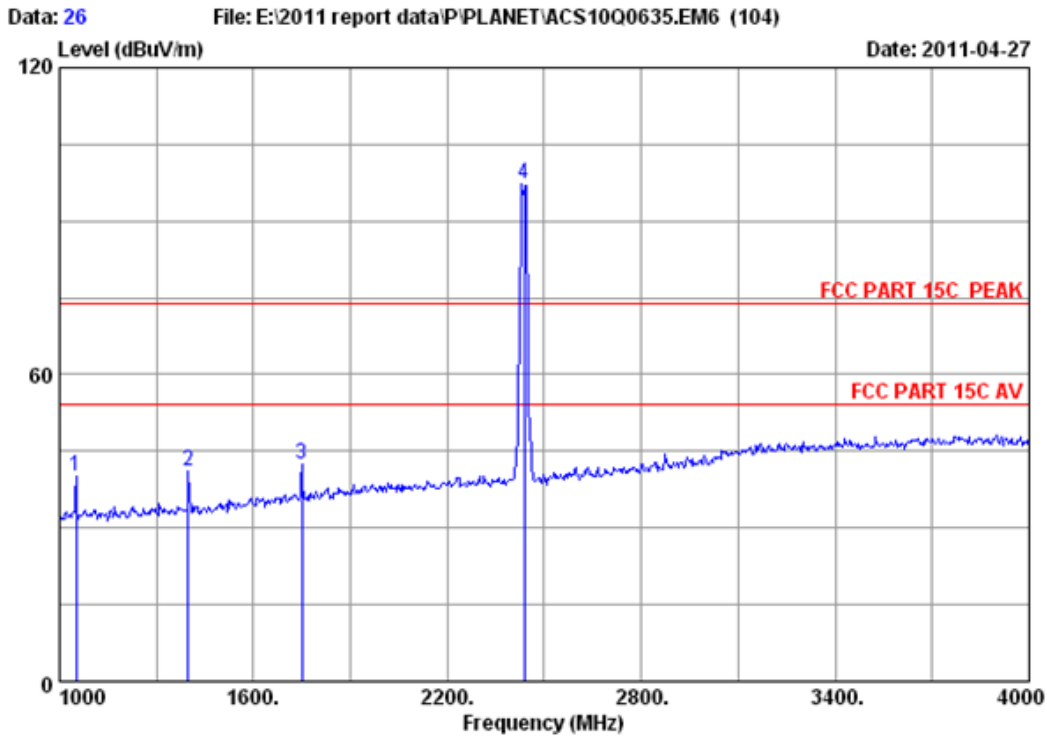

Site no. : 3m Chamber Data no. : 26
 Dis. / Ant. : 3m 3115(0911) Ant. pol. : HORIZONTAL
 Limit : FCC PART 15C PEAK
 Env. / Ins. : 23°C/54% Engineer : Leo-Li
 EUT : 150Mbps 802.11n Wireless Broadband Router
 Power : DC 9V From Adapter input AC 120V/60Hz
 Test mode : IEEE802.11g CH6 2437MHz Tx
 M/N : WNRT-617

	Ant. Freq. (MHz)	Ant. Factor (dB/m)	Cable loss (dB)	Amp. Factor (dB)	Reading (dBuV)	Emission Level (dBuV/m)	Limits (dBuV/m)	Margin (dB)	Remark
1	1051.000	25.50	4.86	37.81	47.65	40.20	74.00	33.80	Peak
2	1399.000	26.19	5.50	37.18	46.69	41.20	74.00	32.80	Peak
3	1750.000	27.80	6.18	36.86	45.23	42.35	74.00	31.65	Peak
4	2437.000	29.47	7.46	36.61	96.98	97.30	74.00	-23.30	Peak

Remarks:

1. Emission Level= Antenna Factor + Cable Loss -Amp Factor + Reading.
2. The emission levels that are 20dB below the official limit are not reported.

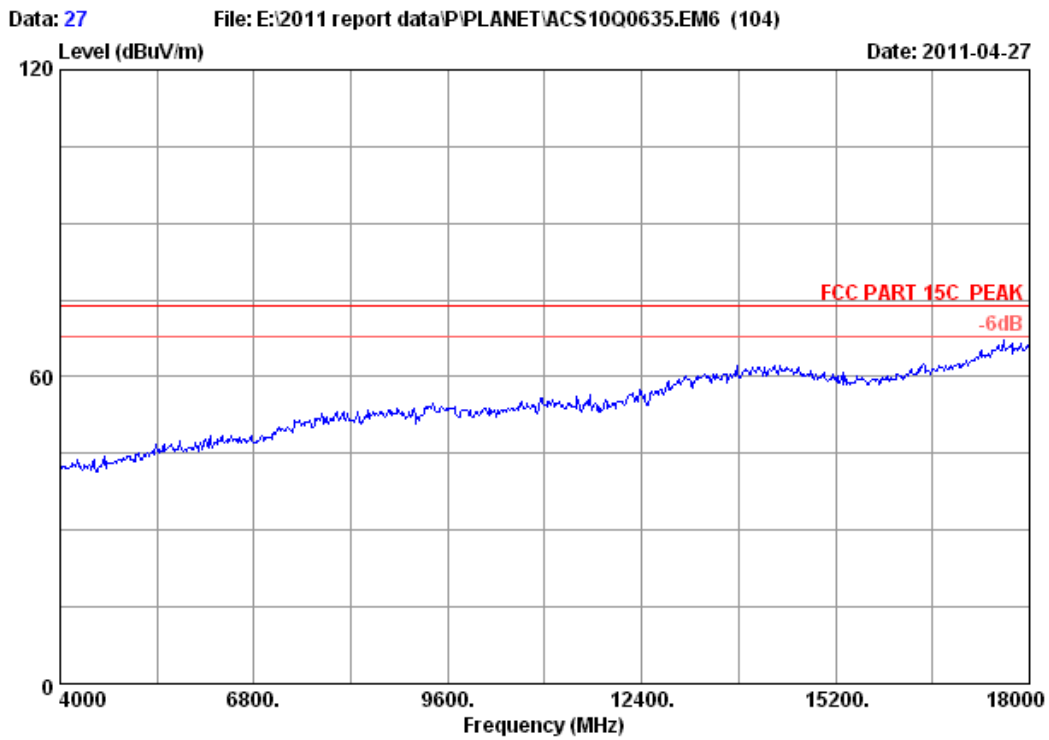

Site no. : 3m Chamber Data no. : 27
Dis. / Ant. : 3m 3115(0911) Ant. pol. : HORIZONTAL
Limit : FCC PART 15C PEAK
Env. / Ins. : 23*C/54% Engineer : Leo-Li
EUT : 150Mbps 802.11n Wireless Broadband Router
Power : DC 9V From Adapter input AC 120V/60Hz
Test mode : IEEE802.11g CH6 2437MHz Tx
M/N : WNRT-617

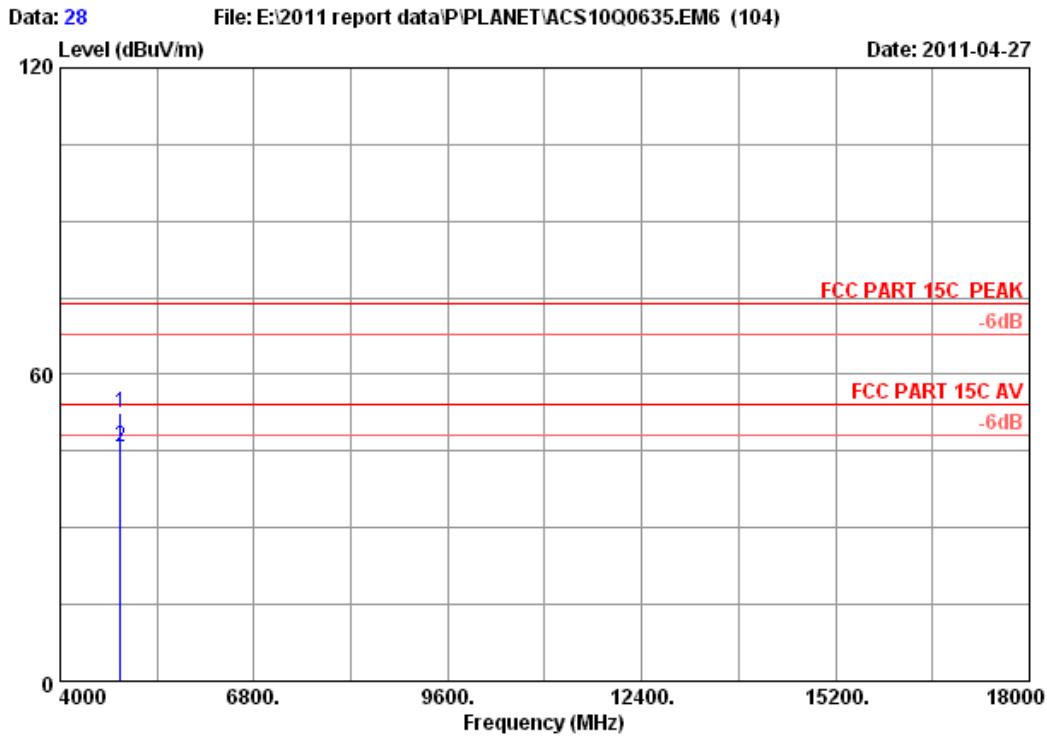

Site no. : 3m Chamber Data no. : 28
 Dis. / Ant. : 3m 3115(0911) Ant. pol. : HORIZONTAL
 Limit : FCC PART 15C PEAK
 Env. / Ins. : 23°C/54% Engineer : Leo-Li
 EUT : 150Mbps 802.11n Wireless Broadband Router
 Power : DC 9V From Adapter input AC 120V/60Hz
 Test mode : IEEE802.11g CH6 2437MHz Tx
 M/N : WNRT-617

	Ant.	Cable	Amp.	Emission					
Freq.	Factor	loss	Factor	Reading	Level	Limits	Margin	Remark	
(MHz)	(dB/m)	(dB)	(dB)	(dBuV)	(dBuV/m)	(dBuV/m)	(dB)		
1 4874.000	34.41	10.69	35.03	42.56	52.63	74.00	21.37	Peak	
2 4874.000	34.41	10.69	35.03	35.84	45.91	54.00	8.09	Average	

- Remarks:
1. Emission Level= Antenna Factor + Cable Loss -Amp Factor + Reading.
 2. The emission levels that are 20dB below the official limit are not reported.

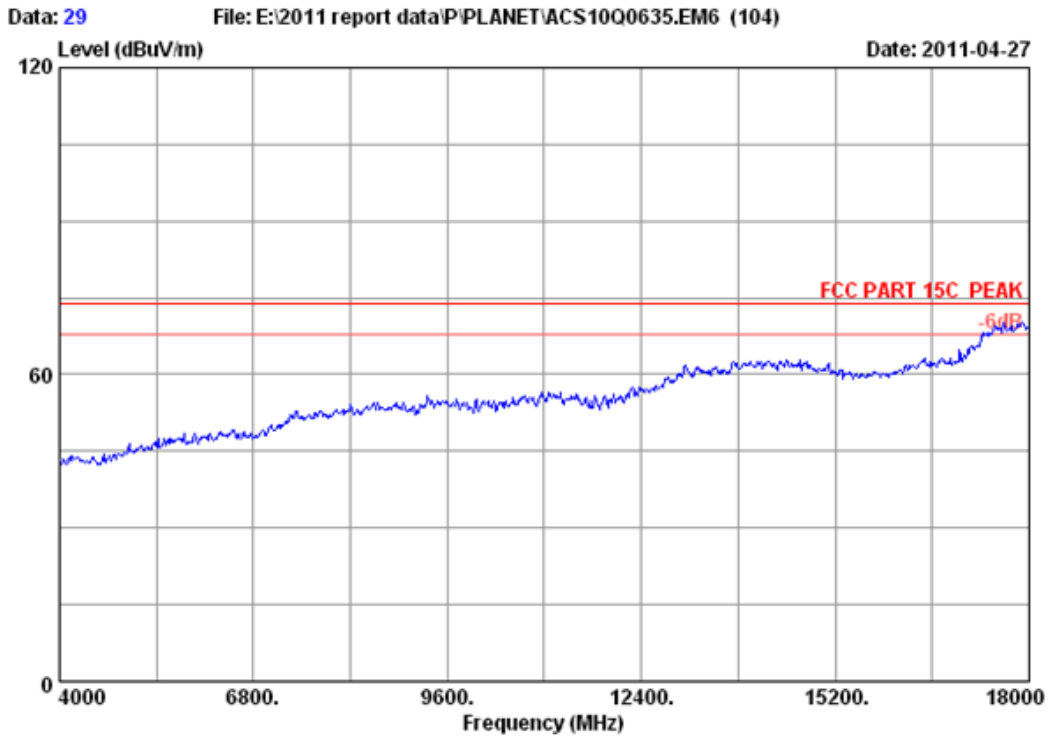

Site no.	: 3m Chamber	Data no. :	29
Dis. / Ant.	: 3m 3115(0911)	Ant. pol. :	VERTICAL
Limit	: FCC PART 15C PEAK		
Env. / Ins.	: 23°C/54%	Engineer :	Leo-Li
EUT	: 150Mbps 802.11n Wireless Broadband Router		
Power	: DC 9V From Adapter input AC 120V/60Hz		
Test mode	: IEEE802.11g CH6 2437MHz Tx		
M/N	: WNRT-617		

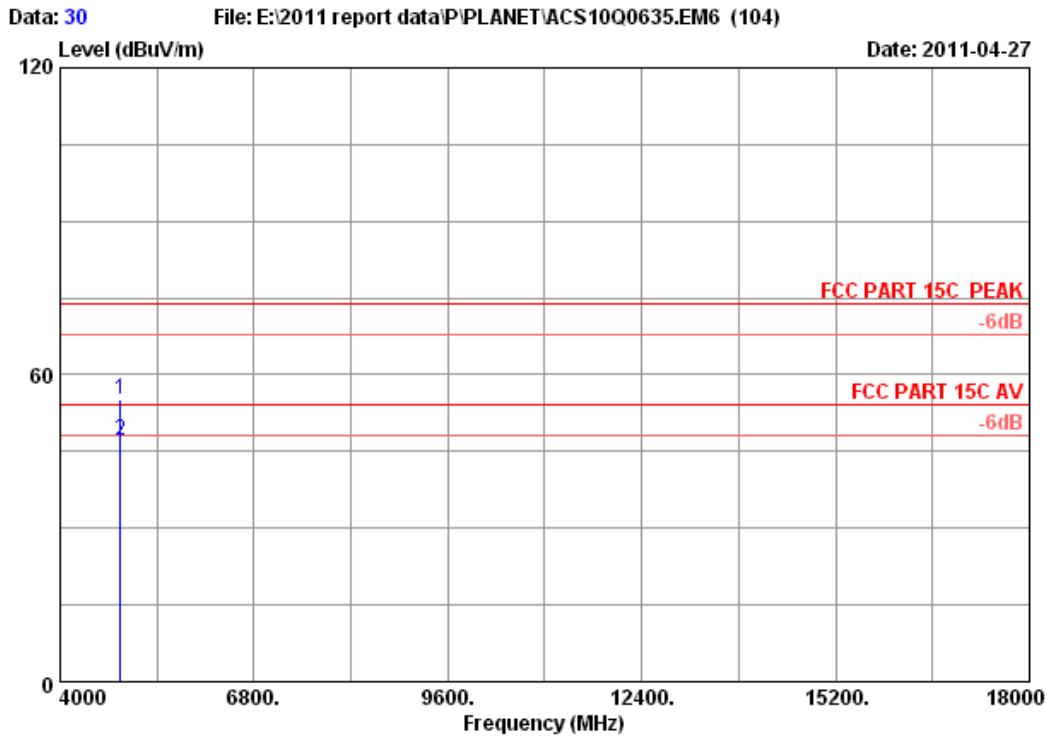

Site no. : 3m Chamber Data no. : 30
 Dis. / Ant. : 3m 3115(0911) Ant. pol. : VERTICAL
 Limit : FCC PART 15C PEAK
 Env. / Ins. : 23*C/54% Engineer : Leo-Li
 EUT : 150Mbps 802.11n Wireless Broadband Router
 Power : DC 9V From Adapter input AC 120V/60Hz
 Test mode : IEEE802.11g CH6 2437MHz Tx
 M/N : WNRT-617

	Freq. (MHz)	Ant. Factor (dB/m)	Cable loss (dB)	Amp. Factor (dB)	Reading (dBUV)	Emission Level (dBUV/m)	Limits (dBUV/m)	Margin (dB)	Remark
1	4874.000	34.41	10.69	35.03	45.23	55.30	74.00	18.70	Peak
2	4874.000	34.41	10.69	35.03	36.98	47.05	54.00	6.95	Average

Remarks:

1. Emission Level= Antenna Factor + Cable Loss -Amp Factor + Reading.
2. The emission levels that are 20dB below the official limit are not reported.

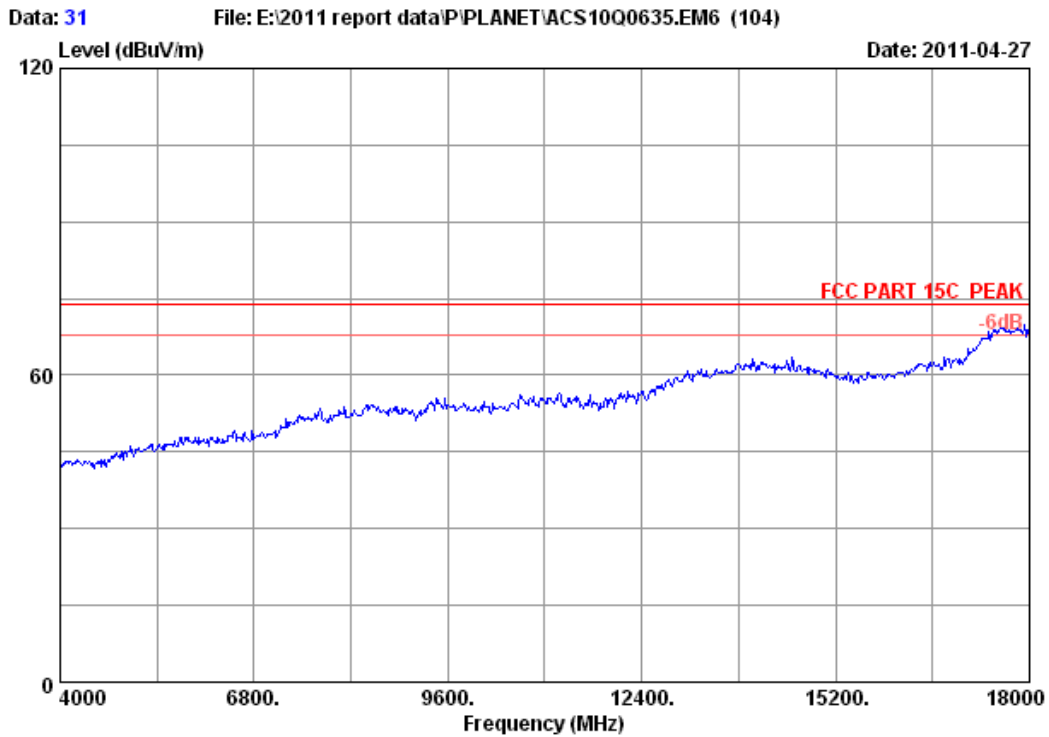

Site no. : 3m Chamber Data no. : 31
Dis. / Ant. : 3m 3115(0911) Ant. pol. : VERTICAL
Limit : FCC PART 15C PEAK
Env. / Ins. : 23°C/54% Engineer : Leo-Li
EUT : 150Mbps 802.11n Wireless Broadband Router
Power : DC 9V From Adapter input AC 120V/60Hz
Test mode : IEEE802.11g CH11 2462MHz Tx
M/N : WNRT-617

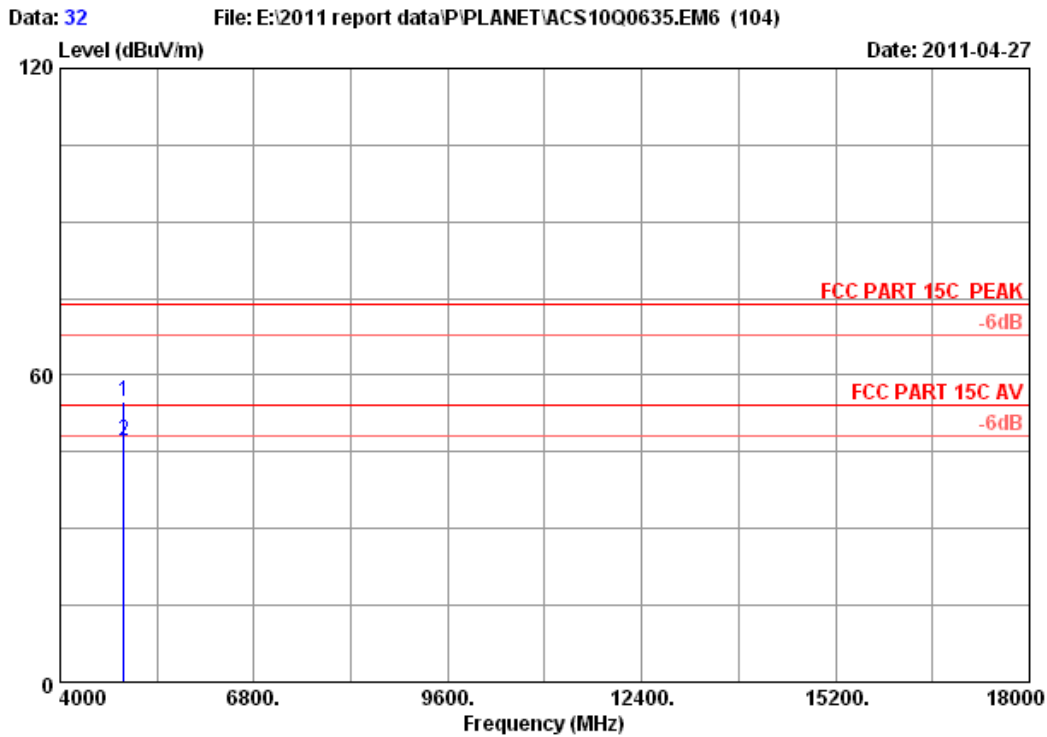

Site no. : 3m Chamber Data no. : 32
 Dis. / Ant. : 3m 3115(0911) Ant. pol. : VERTICAL
 Limit : FCC PART 15C PEAK
 Env. / Ins. : 23*C/54% Engineer : Leo-Li
 EUT : 150Mbps 802.11n Wireless Broadband Router
 Power : DC 9V From Adapter input AC 120V/60Hz
 Test mode : IEEE802.11g CH11 2462MHz Tx
 M/N : WNRT-617

	Ant. Freq. (MHz)	Ant. Factor (dB/m)	Cable loss (dB)	Amp. Factor (dB)	Reading (dBuV)	Emission Level (dBuV/m)	Limits (dBuV/m)	Margin (dB)	Remark
1	4924.000	34.49	10.76	34.98	44.62	54.89	74.00	19.11	Peak
2	4924.000	34.49	10.76	34.98	36.87	47.14	54.00	6.86	Average

Remarks:

1. Emission Level= Antenna Factor + Cable Loss -Amp Factor + Reading.
2. The emission levels that are 20dB below the official limit are not reported.

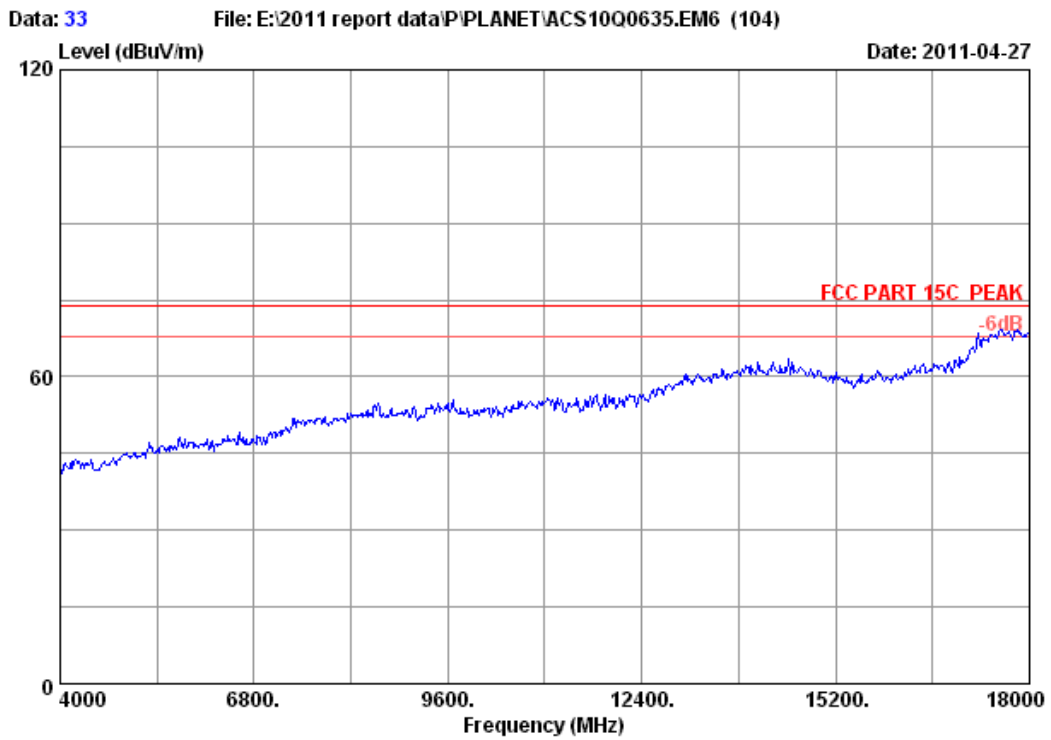

Site no.	: 3m Chamber	Data no. :	33
Dis. / Ant.	: 3m 3115(0911)	Ant. pol. :	HORIZONTAL
Limit	: FCC PART 15C PEAK		
Env. / Ins.	: 23°C/54%	Engineer :	Leo-Li
EUT	: 150Mbps 802.11n Wireless Broadband Router		
Power	: DC 9V From Adapter input AC 120V/60Hz		
Test mode	: IEEE802.11g CH11 2462MHz Tx		
M/N	: WNRT-617		

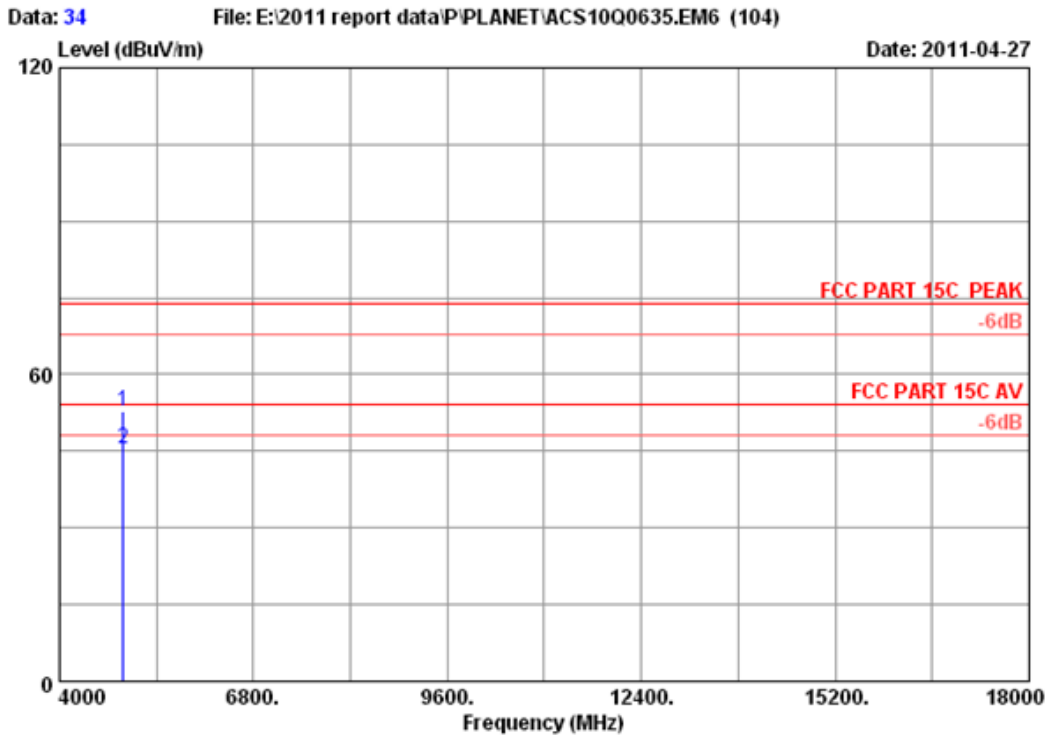

Site no. : 3m Chamber Data no. : 34
 Dis. / Ant. : 3m 3115(0911) Ant. pol. : HORIZONTAL
 Limit : FCC PART 15C PEAK
 Env. / Ins. : 23°C/54% Engineer : Leo-Li
 EUT : 150Mbps 802.11n Wireless Broadband Router
 Power : DC 9V From Adapter input AC 120V/60Hz
 Test mode : IEEE802.11g CH11 2462MHz Tx
 M/N : WNRT-617

	Ant. Freq. (MHz)	Ant. Factor (dB/m)	Cable loss (dB)	Amp. Factor (dB)	Reading (dBuV)	Emission Level (dBuV/m)	Limits (dBuV/m)	Margin (dB)	Remark
1	4924.000	34.49	10.76	34.98	42.68	52.95	74.00	21.05	Peak
2	4924.000	34.49	10.76	34.98	35.27	45.54	54.00	8.46	Average

Remarks:

1. Emission Level= Antenna Factor + Cable Loss -Amp Factor + Reading.
2. The emission levels that are 20dB below the official limit are not reported.

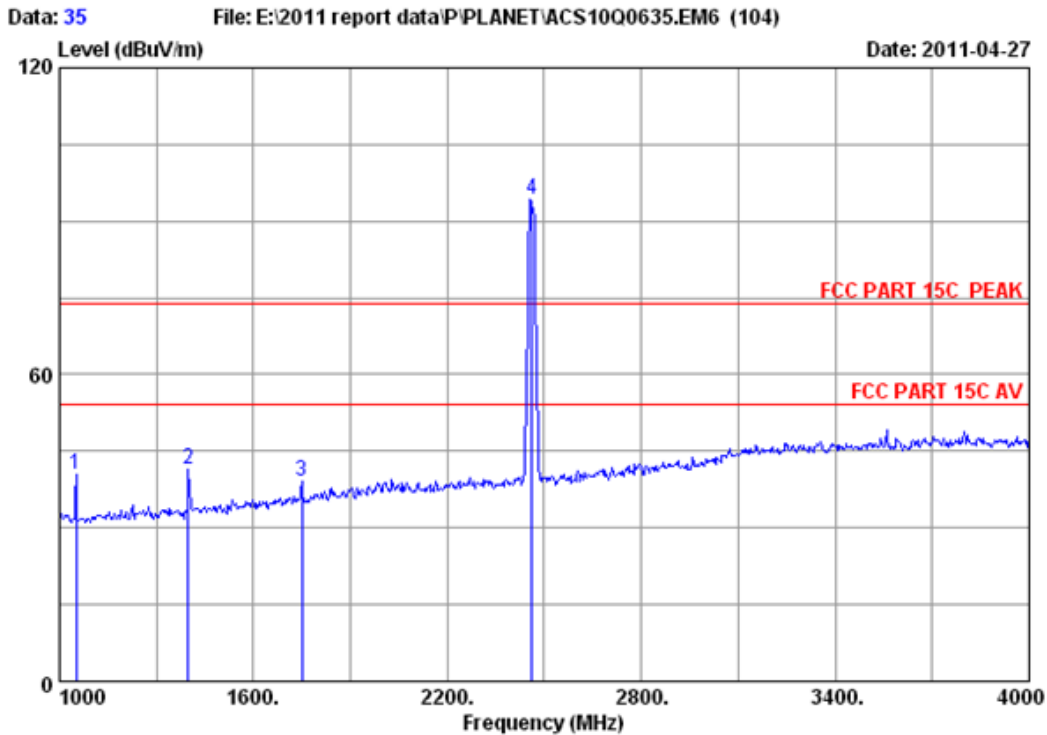

Site no. : 3m Chamber Data no. : 35
 Dis. / Ant. : 3m 3115(0911) Ant. pol. : HORIZONTAL
 Limit : FCC PART 15C PEAK
 Env. / Ins. : 23°C/54% Engineer : Leo-Li
 EUT : 150Mbps 802.11n Wireless Broadband Router
 Power : DC 9V From Adapter input AC 120V/60Hz
 Test mode : IEEE802.11g CH11 2462MHz Tx
 M/N : WNRT-617

	Ant. Freq. (MHz)	Ant. Factor (dB/m)	Cable loss (dB)	Amp. Factor (dB)	Reading (dBuV)	Emission Level (dBuV/m)	Limits (dBuV/m)	Margin (dB)	Remark
1	1051.000	25.50	4.86	37.81	48.01	40.56	74.00	33.44	Peak
2	1399.000	26.19	5.50	37.18	46.79	41.30	74.00	32.70	Peak
3	1750.000	27.80	6.18	36.86	41.90	39.02	74.00	34.98	Peak
4	2462.000	29.48	7.54	36.61	93.77	94.18	74.00	-20.18	Peak

Remarks:

1. Emission Level= Antenna Factor + Cable Loss -Amp Factor + Reading.
2. The emission levels that are 20dB below the official limit are not reported.

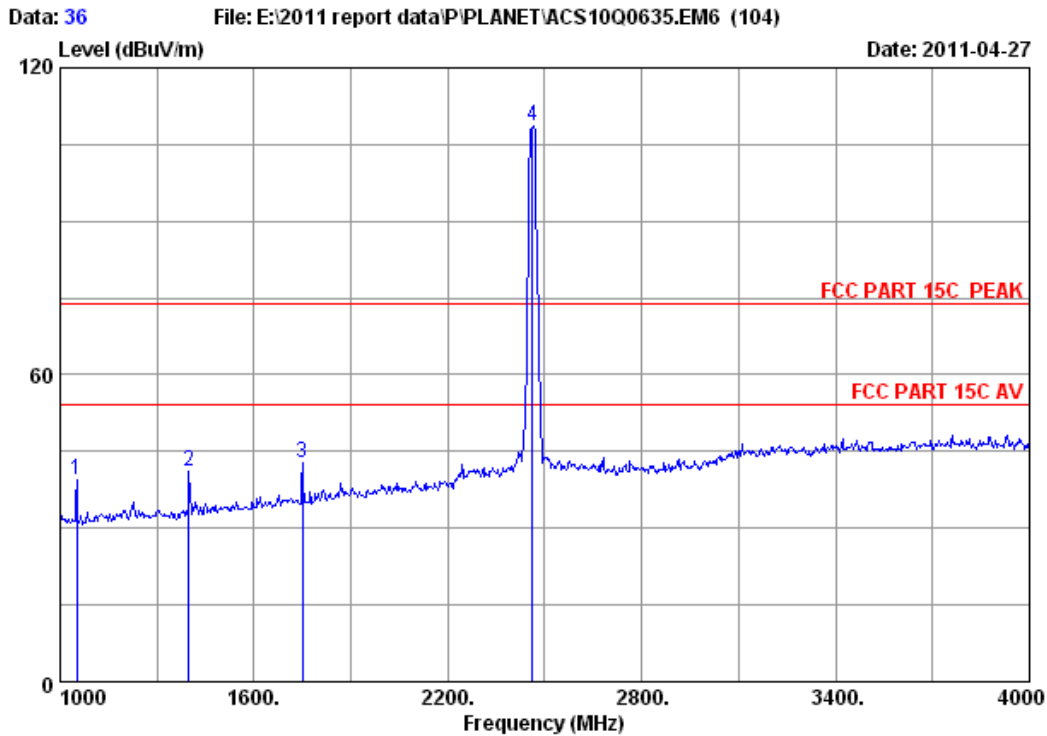

Site no. : 3m Chamber Data no. : 36
 Dis. / Ant. : 3m 3115(0911) Ant. pol. : VERTICAL
 Limit : FCC PART 15C PEAK
 Env. / Ins. : 23°C/54% Engineer : Leo-Li
 EUT : 150Mbps 802.11n Wireless Broadband Router
 Power : DC 9V From Adapter input AC 120V/60Hz
 Test mode : IEEE802.11g CH11 2462MHz Tx
 M/N : WNRT-617

	Ant. Freq. (MHz)	Ant. Factor (dB/m)	Cable loss (dB)	Amp. Factor (dB)	Reading (dBuV)	Emission Level (dBuV/m)	Limits (dBuV/m)	Margin (dB)	Remark
1	1051.000	25.50	4.86	37.81	46.87	39.42	74.00	34.58	Peak
2	1399.000	26.19	5.50	37.18	46.70	41.21	74.00	32.79	Peak
3	1750.000	27.80	6.18	36.86	45.69	42.81	74.00	31.19	Peak
4	2462.000	29.48	7.54	36.61	108.07	108.48	74.00	-34.48	Peak

Remarks:

1. Emission Level= Antenna Factor + Cable Loss -Amp Factor + Reading.
2. The emission levels that are 20dB below the official limit are not reported.

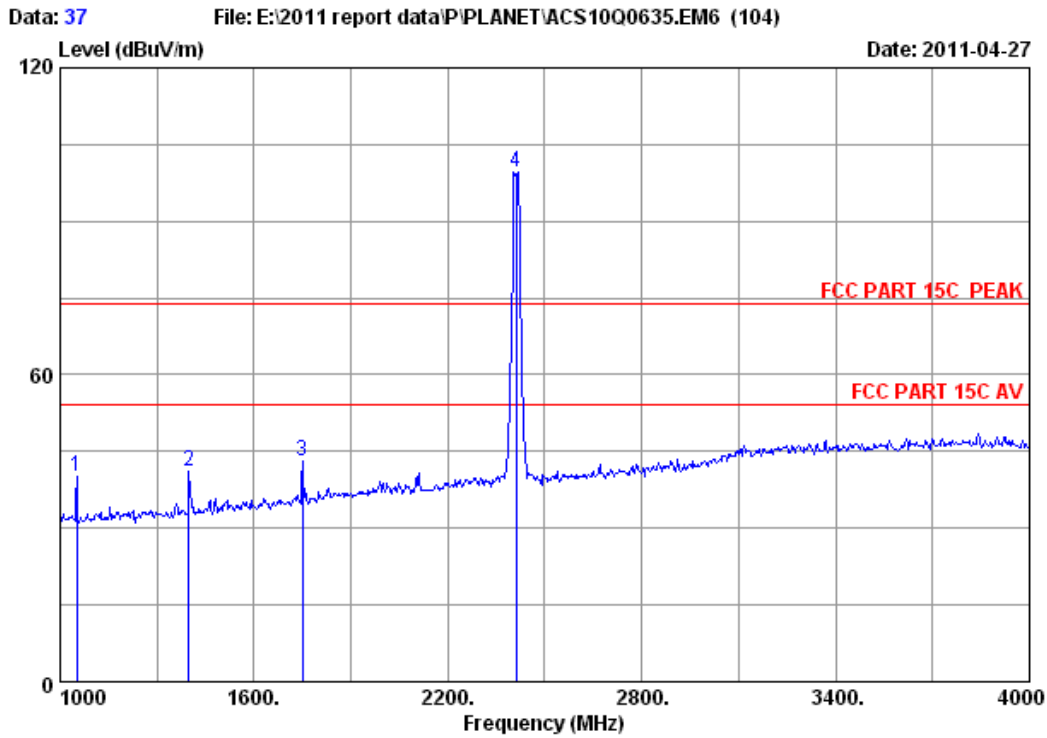

Site no. : 3m Chamber Data no. : 37
 Dis. / Ant. : 3m 3115(0911) Ant. pol. : VERTICAL
 Limit : FCC PART 15C PEAK
 Env. / Ins. : 23*C/54% Engineer : Leo-Li
 EUT : 150Mbps 802.11n Wireless Broadband Router
 Power : DC 9V From Adapter input AC 120V/60Hz
 Test mode : IEEE802.11nHT20 CH1 2412MHz Tx
 M/N : WNRT-617

	Ant. Freq. (MHz)	Ant. Factor (dB/m)	Cable loss (dB)	Amp. Factor (dB)	Reading (dBuV)	Emission Level (dBuV/m)	Limits (dBuV/m)	Margin (dB)	Remark
1	1051.000	25.50	4.86	37.81	47.43	39.98	74.00	34.02	Peak
2	1399.000	26.19	5.50	37.18	46.74	41.25	74.00	32.75	Peak
3	1750.000	27.80	6.18	36.86	45.94	43.06	74.00	30.94	Peak
4	2412.000	29.45	7.43	36.62	99.39	99.65	74.00	-25.65	Peak

Remarks:

1. Emission Level= Antenna Factor + Cable Loss -Amp Factor + Reading.
2. The emission levels that are 20dB below the official limit are not reported.

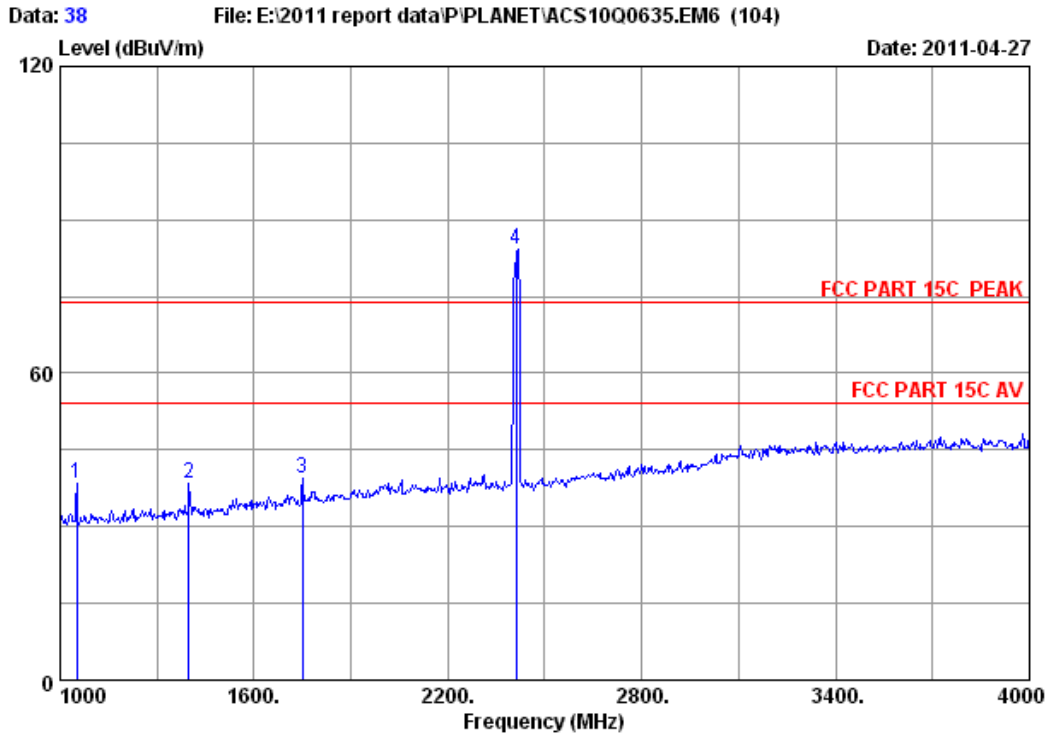

Site no. : 3m Chamber Data no. : 38
 Dis. / Ant. : 3m 3115(0911) Ant. pol. : HORIZONTAL
 Limit : FCC PART 15C PEAK
 Env. / Ins. : 23°C/54% Engineer : Leo-Li
 EUT : 150Mbps 802.11n Wireless Broadband Router
 Power : DC 9V From Adapter input AC 120V/60Hz
 Test mode : IEEE802.11nHT20 CH1 2412MHz Tx
 M/N : WNRT-617

	Freq. (MHz)	Ant. Factor (dB/m)	Cable loss (dB)	Amp. Factor (dB)	Reading (dBuV)	Emission Level (dBuV/m)	Limits (dBuV/m)	Margin (dB)	Remark
1	1051.000	25.50	4.86	37.81	45.74	38.29	74.00	35.71	Peak
2	1399.000	26.19	5.50	37.18	43.79	38.30	74.00	35.70	Peak
3	1750.000	27.80	6.18	36.86	42.48	39.60	74.00	34.40	Peak
4	2412.000	29.45	7.43	36.62	83.83	84.09	74.00	-10.09	Peak

Remarks:

1. Emission Level= Antenna Factor + Cable Loss -Amp Factor + Reading.
2. The emission levels that are 20dB below the official limit are not reported.

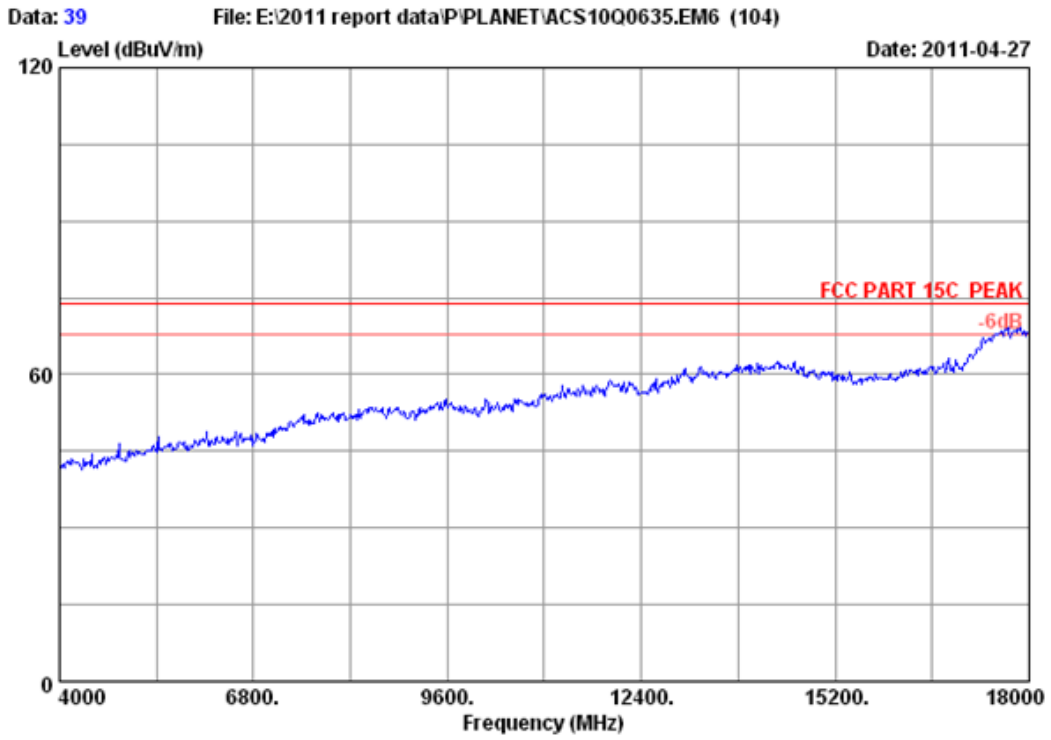

Site no. : 3m Chamber Data no. : 39
Dis. / Ant. : 3m 3115(0911) Ant. pol. : VERTICAL
Limit : FCC PART 15C PEAK
Env. / Ins. : 23*C/54% Engineer : Leo-Li
EUT : 150Mbps 802.11n Wireless Broadband Router
Power : DC 9V From Adapter input AC 120V/60Hz
Test mode : IEEE802.11nHT20 CH1 2412MHz Tx
M/N : WNRT-617

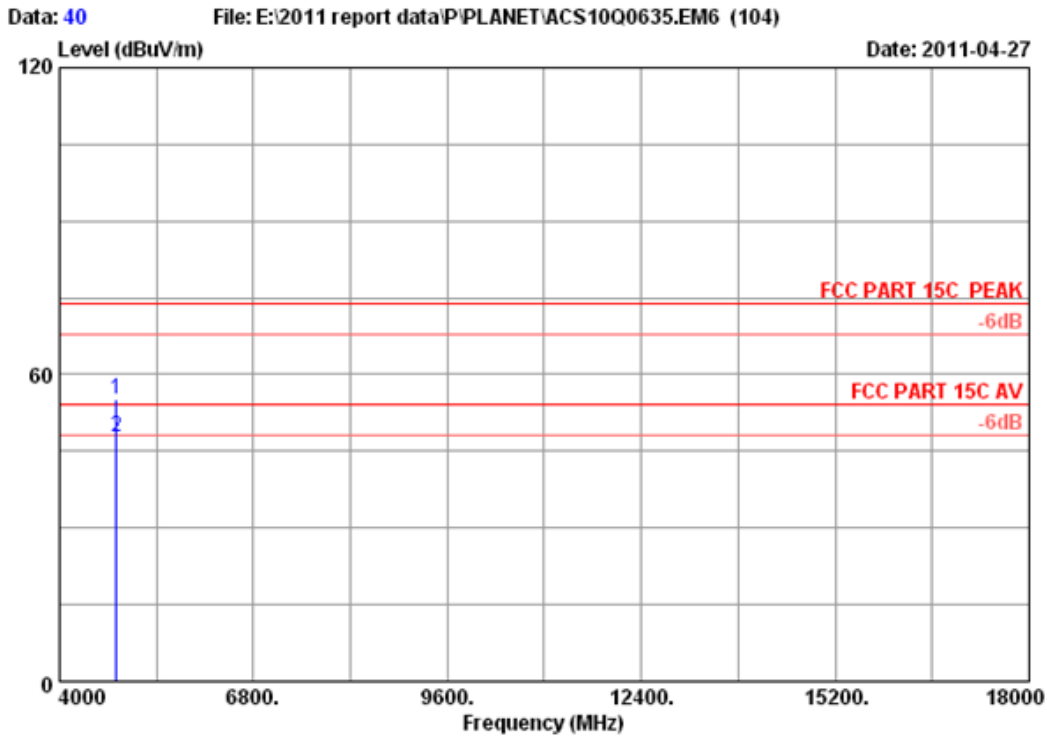

Site no. : 3m Chamber Data no. : 40
 Dis. / Ant. : 3m 3115(0911) Ant. pol. : VERTICAL
 Limit : FCC PART 15C PEAK
 Env. / Ins. : 23*C/54% Engineer : Leo-Li
 EUT : 150Mbps 802.11n Wireless Broadband Router
 Power : DC 9V From Adapter input AC 120V/60Hz
 Test mode : IEEE802.11nHT20 CH1 2412MHz Tx
 M/N : WNRT-617

	Freq. (MHz)	Ant. Factor (dB/m)	Cable loss (dB)	Amp. Factor (dB)	Reading (dBuV)	Emission Level (dBuV/m)	Limits (dBuV/m)	Margin (dB)	Remark
1	4824.000	34.32	10.64	35.08	45.33	55.21	74.00	18.79	Peak
2	4824.000	34.32	10.64	35.08	37.86	47.74	54.00	6.26	Average

Remarks:

1. Emission Level= Antenna Factor + Cable Loss -Amp Factor + Reading.
2. The emission levels that are 20dB below the official limit are not reported.

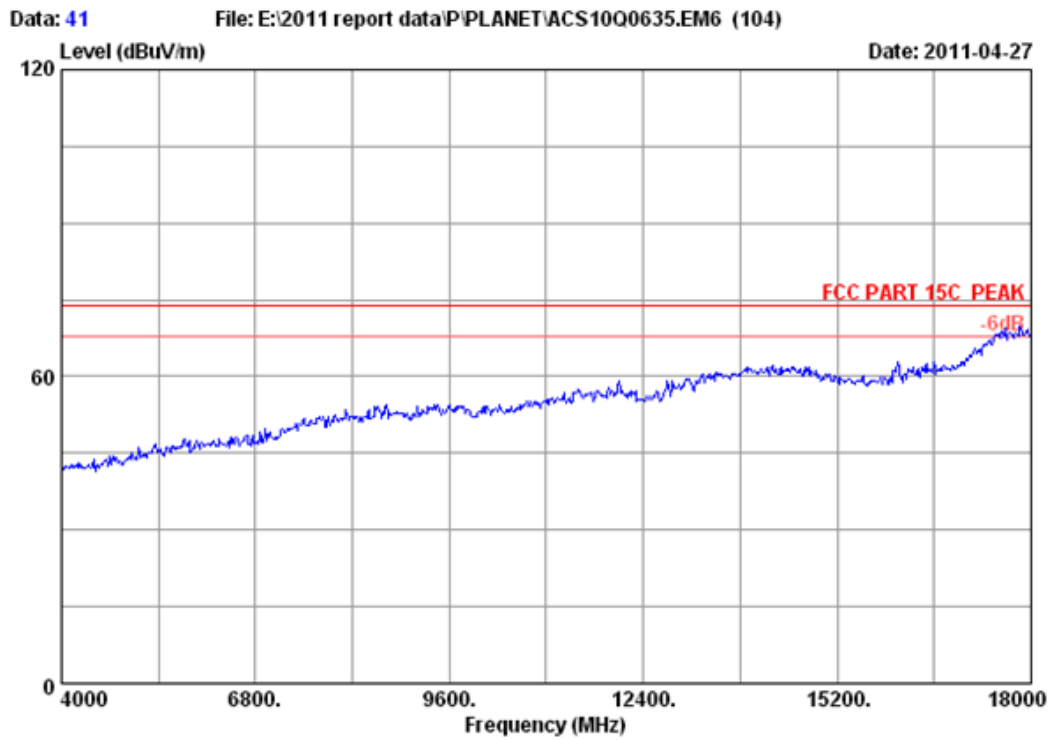

Site no.	: 3m Chamber	Data no. :	41
Dis. / Ant.	: 3m 3115(0911)	Ant. pol. :	HORIZONTAL
Limit	: FCC PART 15C PEAK		
Env. / Ins.	: 23°C/54%	Engineer :	Leo-Li
EUT	: 150Mbps 802.11n Wireless Broadband Router		
Power	: DC 9V From Adapter input AC 120V/60Hz		
Test mode	: IEEE802.11nHT20 CH1 2412MHz Tx		
M/N	: WNRT-617		

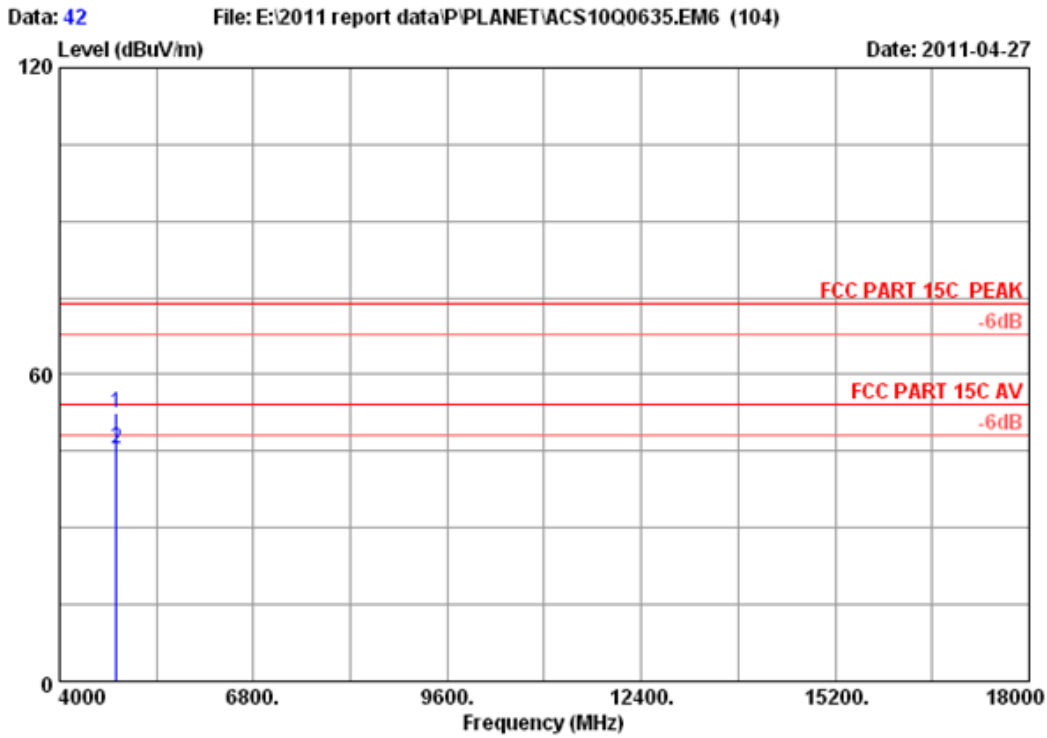

Site no. : 3m Chamber Data no. : 42
 Dis. / Ant. : 3m 3115(0911) Ant. pol. : HORIZONTAL
 Limit : FCC PART 15C PEAK
 Env. / Ins. : 23°C/54% Engineer : Leo-Li
 EUT : 150Mbps 802.11n Wireless Broadband Router
 Power : DC 9V From Adapter input AC 120V/60Hz
 Test mode : IEEE802.11nHT20 CH1 2412MHz Tx
 M/N : WNRT-617

	Ant. Freq. (MHz)	Ant. Factor (dB/m)	Cable loss (dB)	Amp. Factor (dB)	Reading (dBuV)	Emission Level (dBuV/m)	Limits (dBuV/m)	Margin (dB)	Remark
1	4824.000	34.32	10.64	35.08	42.66	52.54	74.00	21.46	Peak
2	4824.000	34.32	10.64	35.08	35.48	45.36	54.00	8.64	Average

Remarks:

1. Emission Level= Antenna Factor + Cable Loss - Amp Factor + Reading.
2. The emission levels that are 20dB below the official limit are not reported.

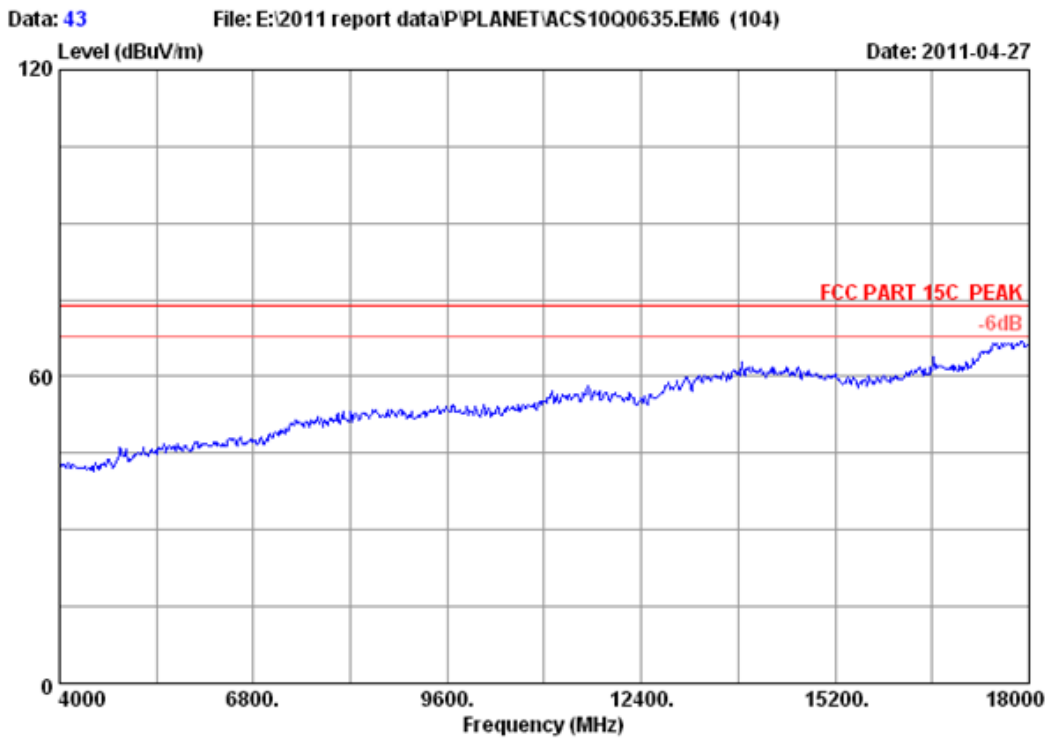

Site no.	: 3m Chamber	Data no. :	43
Dis. / Ant.	: 3m 3115(0911)	Ant. pol. :	HORIZONTAL
Limit	: FCC PART 15C PEAK		
Env. / Ins.	: 23°C/54%	Engineer :	Leo-Li
EUT	: 150Mbps 802.11n Wireless Broadband Router		
Power	: DC 9V From Adapter input AC 120V/60Hz		
Test mode	: IEEE802.11nHT20 CH6 2437MHz Tx		
M/N	: WNRT-617		

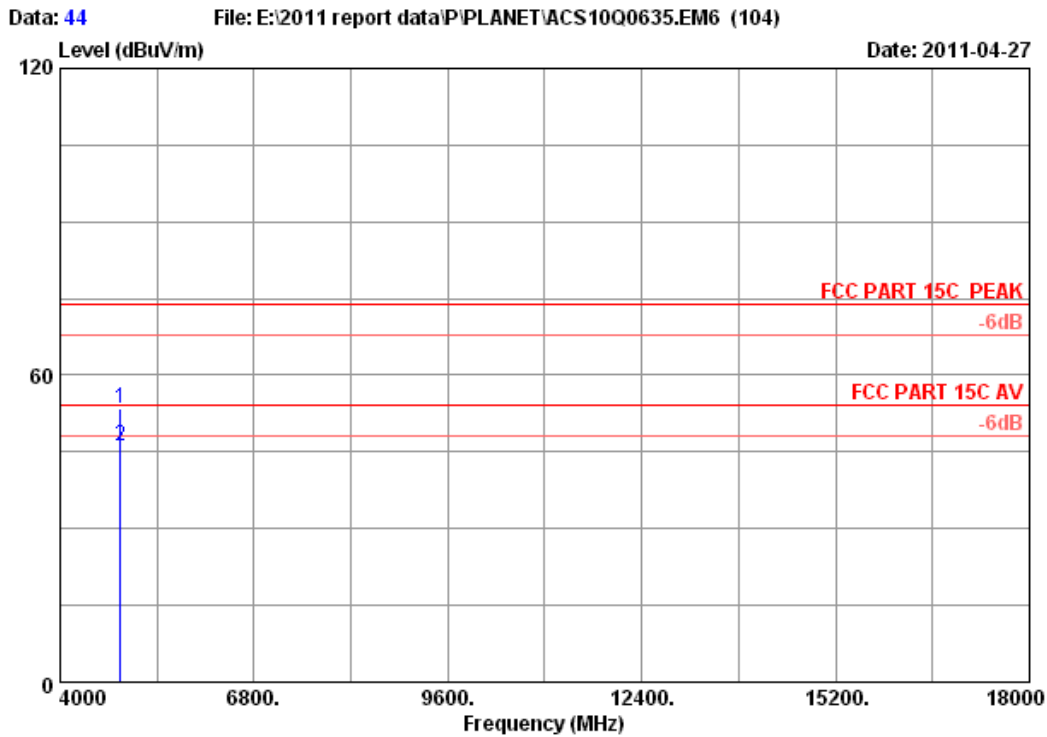

Site no. : 3m Chamber Data no. : 44
 Dis. / Ant. : 3m 3115(0911) Ant. pol. : HORIZONTAL
 Limit : FCC PART 15C PEAK
 Env. / Ins. : 23*C/54% Engineer : Leo-Li
 EUT : 150Mbps 802.11n Wireless Broadband Router
 Power : DC 9V From Adapter input AC 120V/60Hz
 Test mode : IEEE802.11nHT20 CH6 2437MHz Tx
 M/N : WNRT-617

	Ant.	Cable	Amp.	Emission					
Freq.	Factor	loss	Factor	Reading	Level	Limits	Margin	Remark	
(MHz)	(dB/m)	(dB)	(dB)	(dBuV)	(dBuV/m)	(dBuV/m)	(dB)		
1	4874.000	34.41	10.69	35.03	43.26	53.33	74.00	20.67	Peak
2	4874.000	34.41	10.69	35.03	36.14	46.21	54.00	7.79	Average

Remarks:

1. Emission Level= Antenna Factor + Cable Loss -Amp Factor + Reading.
2. The emission levels that are 20dB below the official limit are not reported.

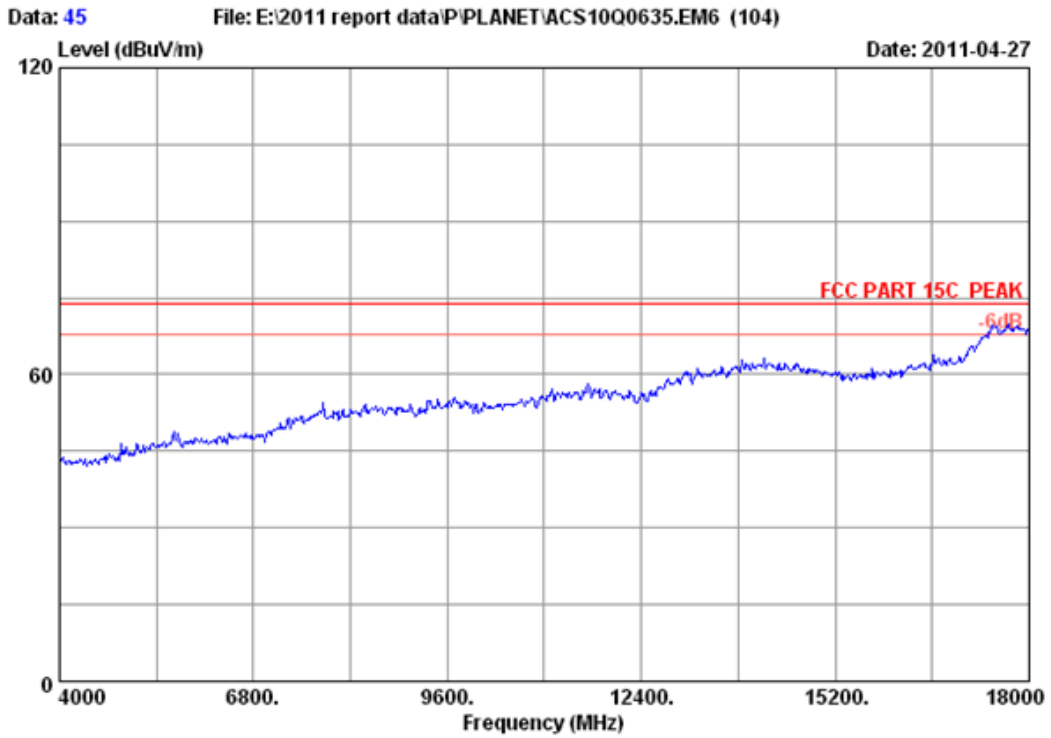

Site no.	: 3m Chamber	Data no. :	45
Dis. / Ant.	: 3m 3115(0911)	Ant. pol. :	VERTICAL
Limit	: FCC PART 15C PEAK		
Env. / Ins.	: 23°C/54%	Engineer :	Leo-Li
EUT	: 150Mbps 802.11n Wireless Broadband Router		
Power	: DC 9V From Adapter input AC 120V/60Hz		
Test mode	: IEEE802.11nHT20 CH6 2437MHz Tx		
M/N	: WNRT-617		

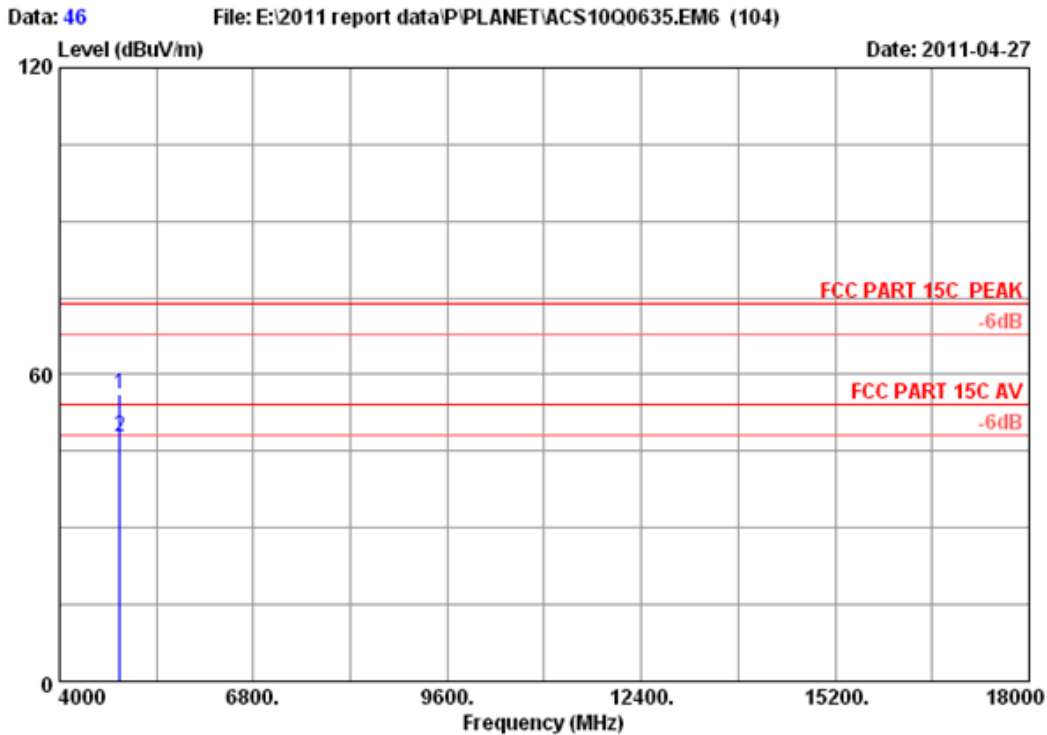

Site no. : 3m Chamber Data no. : 46
 Dis. / Ant. : 3m 3115(0911) Ant. pol. : VERTICAL
 Limit : FCC PART 15C PEAK
 Env. / Ins. : 23°C/54% Engineer : Leo-Li
 EUT : 150Mbps 802.11n Wireless Broadband Router
 Power : DC 9V From Adapter input AC 120V/60Hz
 Test mode : IEEE802.11nHT20 CH6 2437MHz Tx
 M/N : WNRT-617

	Ant. Freq. (MHz)	Ant. Factor (dB/m)	Cable loss (dB)	Amp. Factor (dB)	Reading (dBuV)	Emission Level (dBuV/m)	Limits (dBuV/m)	Margin (dB)	Remark
1	4874.000	34.41	10.69	35.03	46.25	56.32	74.00	17.68	Peak
2	4874.000	34.41	10.69	35.03	37.84	47.91	54.00	6.09	Average

Remarks:

1. Emission Level= Antenna Factor + Cable Loss -Amp Factor + Reading.
2. The emission levels that are 20dB below the official limit are not reported.

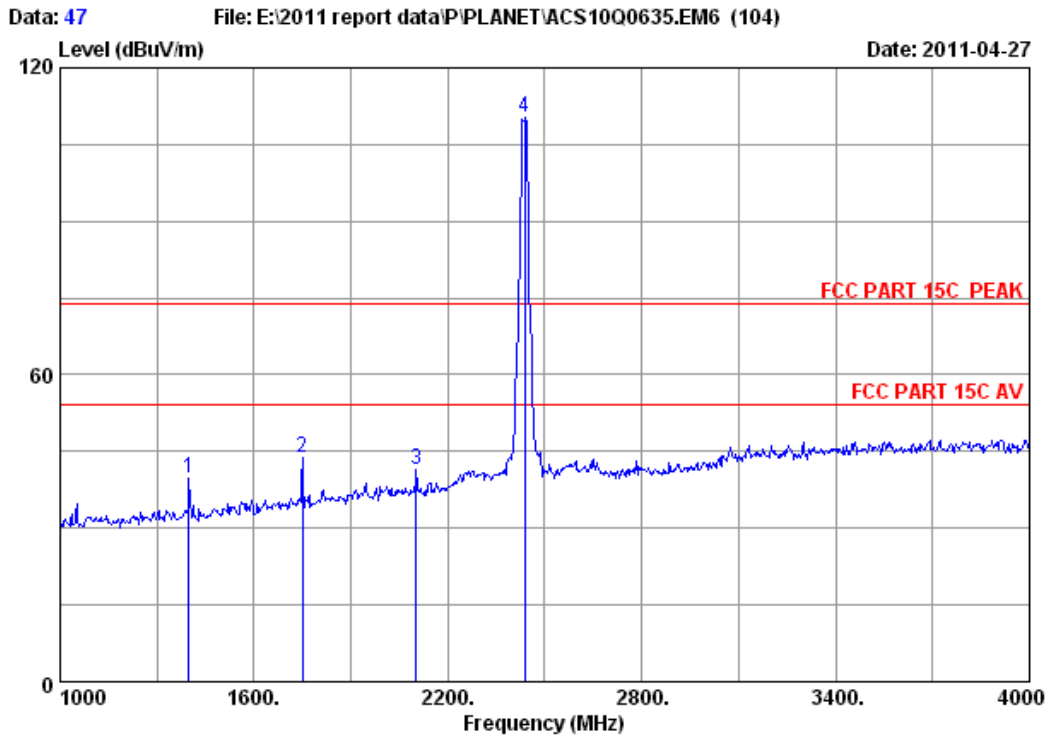

Site no. : 3m Chamber Data no. : 47
 Dis. / Ant. : 3m 3115(0911) Ant. pol. : VERTICAL
 Limit : FCC PART 15C PEAK
 Env. / Ins. : 23*C/54% Engineer : Leo-Li
 EUT : 150Mbps 802.11n Wireless Broadband Router
 Power : DC 9V From Adapter input AC 120V/60Hz
 Test mode : IEEE802.11nHT20 CH6 2437MHz Tx
 M/N : WNRT-617

	Ant. Freq. (MHz)	Ant. Factor (dB/m)	Cable loss (dB)	Amp. Factor (dB)	Reading (dBuV)	Emission Level (dBuV/m)	Limits (dBuV/m)	Margin (dB)	Remark
1	1399.000	26.19	5.50	37.18	45.26	39.77	74.00	34.23	Peak
2	1750.000	27.80	6.18	36.86	46.52	43.64	74.00	30.36	Peak
3	2101.000	29.26	6.86	36.68	41.86	41.30	74.00	32.70	Peak
4	2437.000	29.47	7.46	36.61	109.87	110.19	74.00	-36.19	Peak

Remarks:

1. Emission Level= Antenna Factor + Cable Loss -Amp Factor + Reading.
2. The emission levels that are 20dB below the official limit are not reported.

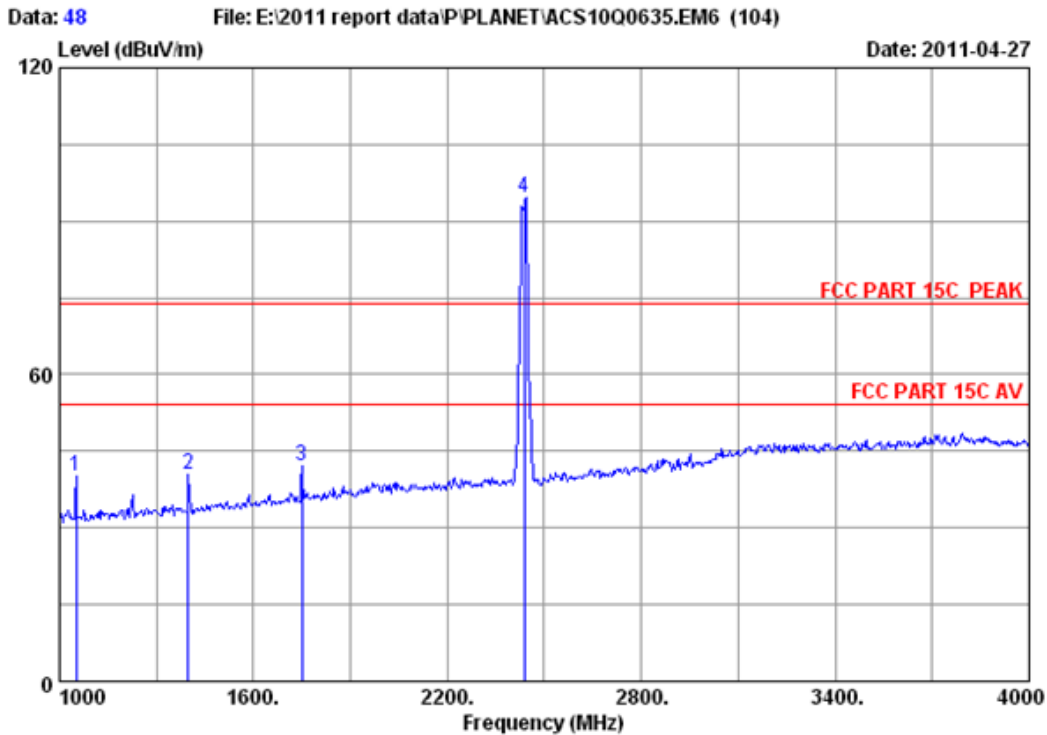

Site no. : 3m Chamber Data no. : 48
 Dis. / Ant. : 3m 3115(0911) Ant. pol. : HORIZONTAL
 Limit : FCC PART 15C PEAK
 Env. / Ins. : 23°C/54% Engineer : Leo-Li
 EUT : 150Mbps 802.11n Wireless Broadband Router
 Power : DC 9V From Adapter input AC 120V/60Hz
 Test mode : IEEE802.11nHT20 CH6 2437MHz Tx
 M/N : WNRT-617

	Ant. Freq. (MHz)	Ant. Factor (dB/m)	Cable loss (dB)	Amp. Factor (dB)	Reading (dBuV)	Emission Level (dBuV/m)	Limits (dBuV/m)	Margin (dB)	Remark
1	1051.000	25.50	4.86	37.81	47.59	40.14	74.00	33.86	Peak
2	1399.000	26.19	5.50	37.18	45.91	40.42	74.00	33.58	Peak
3	1750.000	27.80	6.18	36.86	44.95	42.07	74.00	31.93	Peak
4	2437.000	29.47	7.46	36.61	94.27	94.59	74.00	-20.59	Peak

Remarks:

1. Emission Level= Antenna Factor + Cable Loss -Amp Factor + Reading.
2. The emission levels that are 20dB below the official limit are not reported.

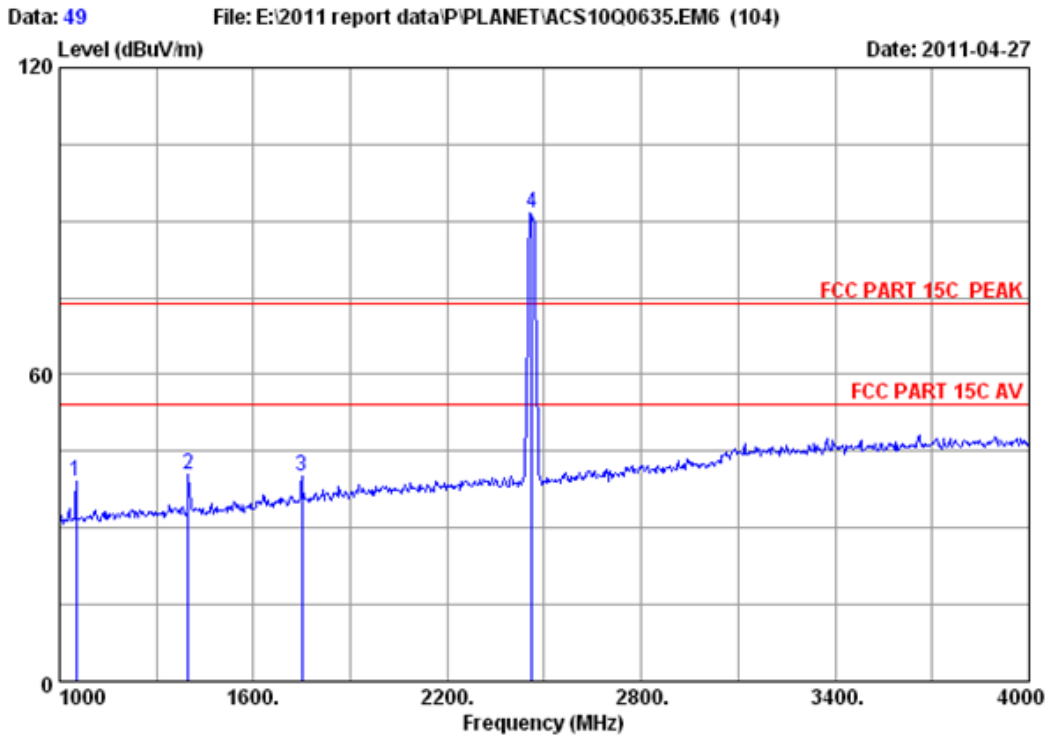

Site no. : 3m Chamber Data no. : 49
 Dis. / Ant. : 3m 3115(0911) Ant. pol. : HORIZONTAL
 Limit : FCC PART 15C PEAK
 Env. / Ins. : 23°C/54% Engineer : Leo-Li
 EUT : 150Mbps 802.11n Wireless Broadband Router
 Power : DC 9V From Adapter input AC 120V/60Hz
 Test mode : IEEE802.11nHT20 CH11 2462MHz Tx
 M/N : WNRT-617

	Ant. Freq. (MHz)	Ant. Factor (dB/m)	Cable loss (dB)	Amp. Factor (dB)	Reading (dBuV)	Emission Level (dBuV/m)	Limits (dBuV/m)	Margin (dB)	Remark
1	1051.000	25.50	4.86	37.81	46.62	39.17	74.00	34.83	Peak
2	1399.000	26.19	5.50	37.18	45.85	40.36	74.00	33.64	Peak
3	1750.000	27.80	6.18	36.86	42.92	40.04	74.00	33.96	Peak
4	2462.000	29.48	7.54	36.61	91.28	91.69	74.00	-17.69	Peak

Remarks:

1. Emission Level= Antenna Factor + Cable Loss -Amp Factor + Reading.
2. The emission levels that are 20dB below the official limit are not reported.

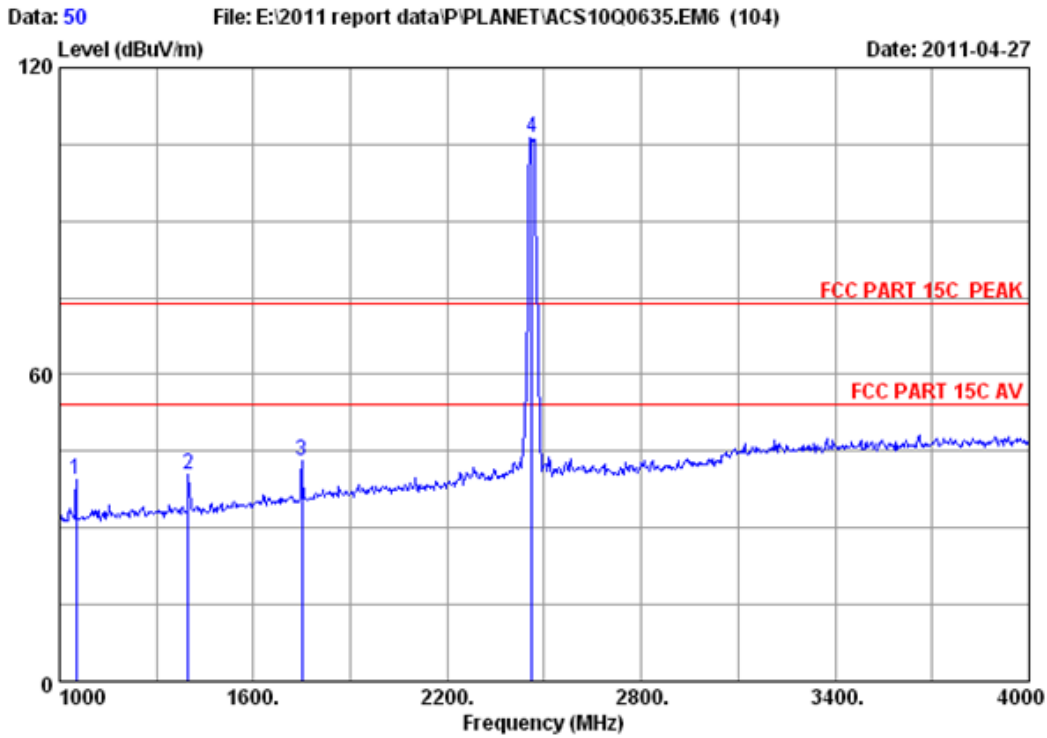

Site no. : 3m Chamber Data no. : 50
 Dis. / Ant. : 3m 3115(0911) Ant. pol. : VERTICAL
 Limit : FCC PART 15C PEAK
 Env. / Ins. : 23*C/54% Engineer : Leo-Li
 EUT : 150Mbps 802.11n Wireless Broadband Router
 Power : DC 9V From Adapter input AC 120V/60Hz
 Test mode : IEEE802.11nHT20 CH11 2462MHz Tx
 M/N : WNRT-617

	Ant. Freq. (MHz)	Ant. Factor (dB/m)	Cable loss (dB)	Amp. Factor (dB)	Reading (dBuV)	Emission Level (dBuV/m)	Limits (dBuV/m)	Margin (dB)	Remark
1	1051.000	25.50	4.86	37.81	47.06	39.61	74.00	34.39	Peak
2	1399.000	26.19	5.50	37.18	45.85	40.36	74.00	33.64	Peak
3	1750.000	27.80	6.18	36.86	46.14	43.26	74.00	30.74	Peak
4	2462.000	29.48	7.54	36.61	105.85	106.26	74.00	-32.26	Peak

Remarks:

1. Emission Level= Antenna Factor + Cable Loss -Amp Factor + Reading.
2. The emission levels that are 20dB below the official limit are not reported.

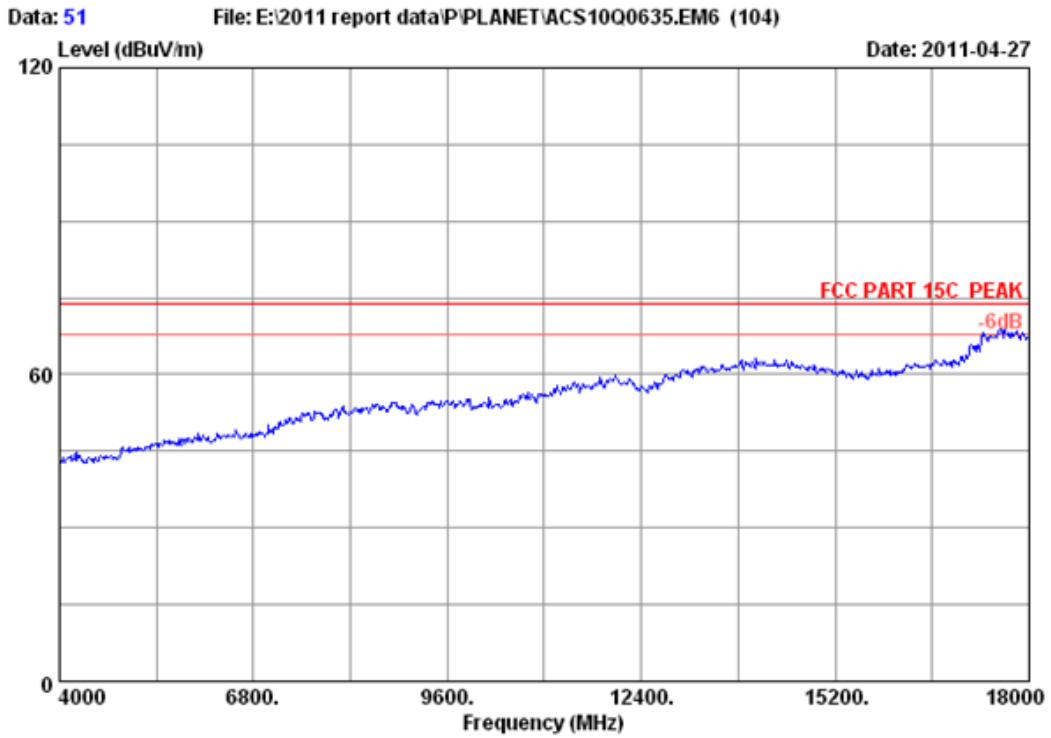

Site no. : 3m Chamber Data no. : 51
Dis. / Ant. : 3m 3115(0911) Ant. pol. : HORIZONTAL
Limit : FCC PART 15C PEAK
Env. / Ins. : 23°C/54% Engineer : Leo-Li
EUT : 150Mbps 802.11n Wireless Broadband Router
Power : DC 9V From Adapter input AC 120V/60Hz
Test mode : IEEE802.11nHT20 CH11 2462MHz Tx
M/N : WNRT-617

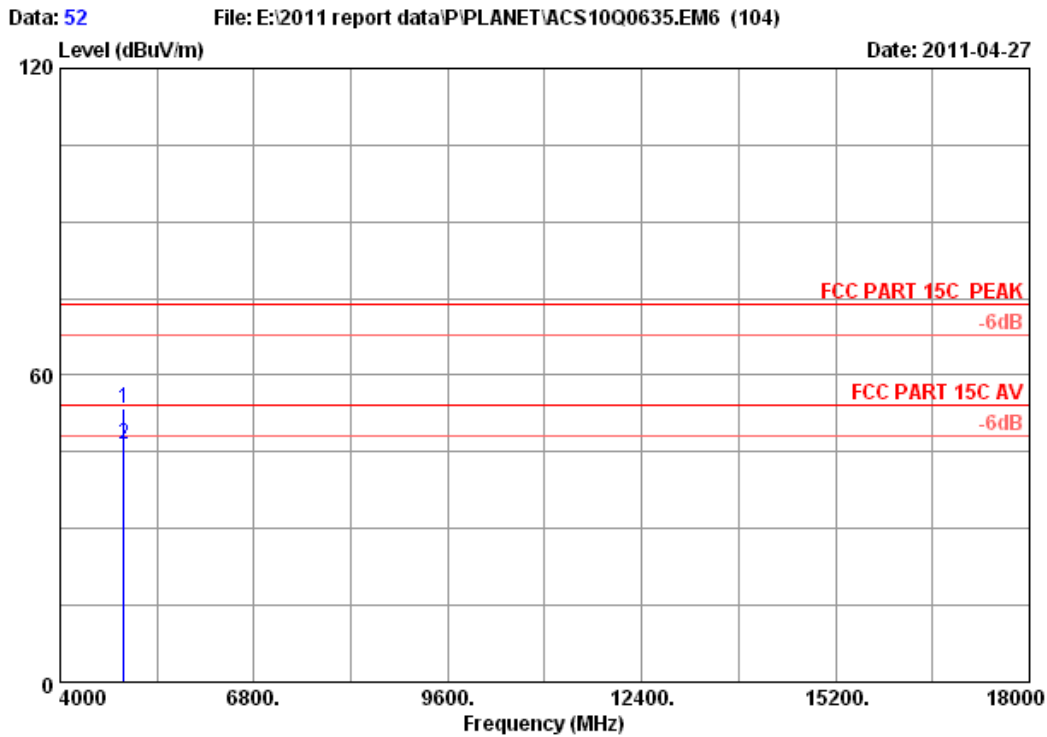

Site no. : 3m Chamber Data no. : 52
 Dis. / Ant. : 3m 3115(0911) Ant. pol. : HORIZONTAL
 Limit : FCC PART 15C PEAK
 Env. / Ins. : 23*C/54% Engineer : Leo-Li
 EUT : 150Mbps 802.11n Wireless Broadband Router
 Power : DC 9V From Adapter input AC 120V/60Hz
 Test mode : IEEE802.11nHT20 CH11 2462MHz Tx
 M/N : WNRT-617

	Freq. (MHz)	Ant. Factor (dB/m)	Cable loss (dB)	Amp. Factor (dB)	Reading (dBuV)	Emission Level (dBuV/m)	Limits (dBuV/m)	Margin (dB)	Remark
1	4924.000	34.49	10.76	34.98	43.26	53.53	74.00	20.47	Peak
2	4924.000	34.49	10.76	34.98	36.14	46.41	54.00	7.59	Average

Remarks:

1. Emission Level= Antenna Factor + Cable Loss -Amp Factor + Reading.
2. The emission levels that are 20dB below the official limit are not reported.

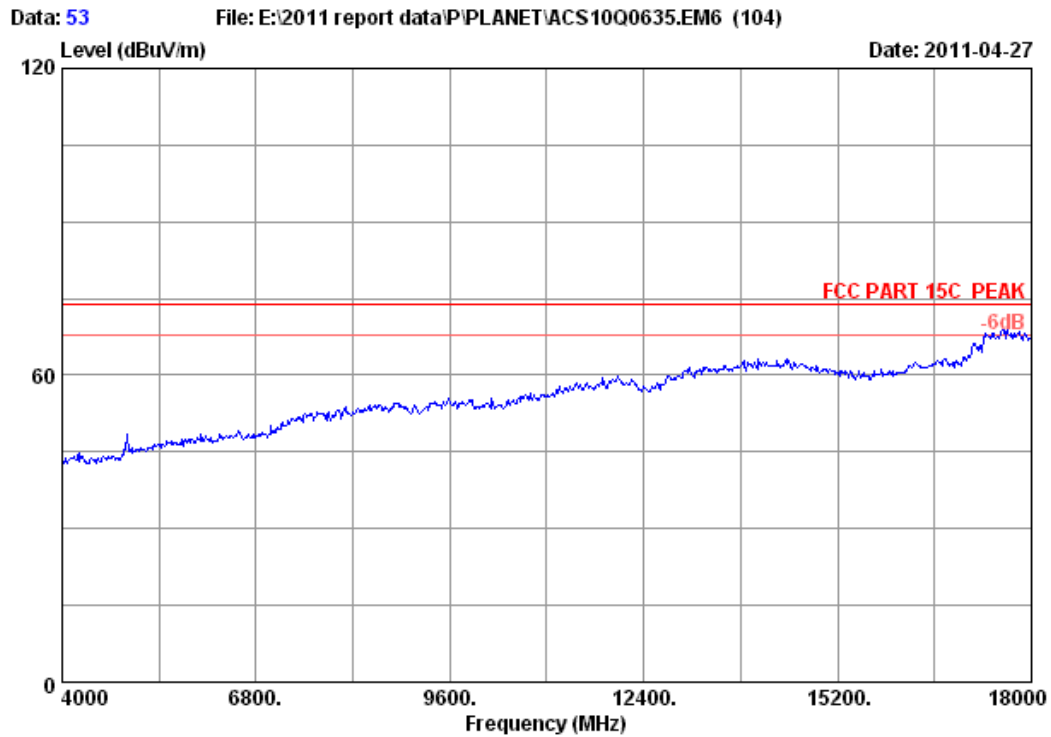

Site no. : 3m Chamber Data no. : 53
Dis. / Ant. : 3m 3115(0911) Ant. pol. : VERTICAL
Limit : FCC PART 15C PEAK
Env. / Ins. : 23°C/54% Engineer : Leo-Li
EUT : 150Mbps 802.11n Wireless Broadband Router
Power : DC 9V From Adapter input AC 120V/60Hz
Test mode : IEEE802.11nHT20 CH11 2462MHz Tx
M/N : WNRT-617

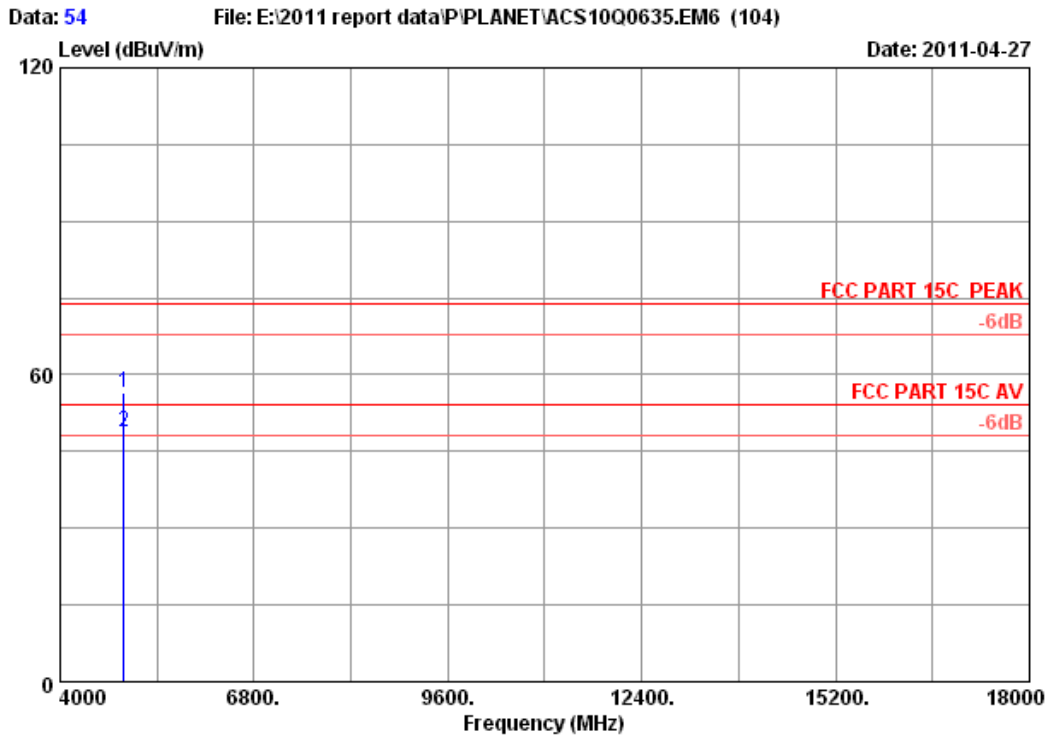

Site no. : 3m Chamber Data no. : 54
 Dis. / Ant. : 3m 3115(0911) Ant. pol. : VERTICAL
 Limit : FCC PART 15C PEAK
 Env. / Ins. : 23*C/54% Engineer : Leo-Li
 EUT : 150Mbps 802.11n Wireless Broadband Router
 Power : DC 9V From Adapter input AC 120V/60Hz
 Test mode : IEEE802.11nHT20 CH11 2462MHz Tx
 M/N : WNRT-617

	Ant. Freq. (MHz)	Ant. Factor (dB/m)	Cable loss (dB)	Amp. Factor (dB)	Reading (dBuV)	Emission Level (dBuV/m)	Limits (dBuV/m)	Margin (dB)	Remark
1	4924.000	34.49	10.76	34.98	46.25	56.52	74.00	17.48	Peak
2	4924.000	34.49	10.76	34.98	38.47	48.74	54.00	5.26	Average

Remarks:

1. Emission Level= Antenna Factor + Cable Loss -Amp Factor + Reading.
2. The emission levels that are 20dB below the official limit are not reported.

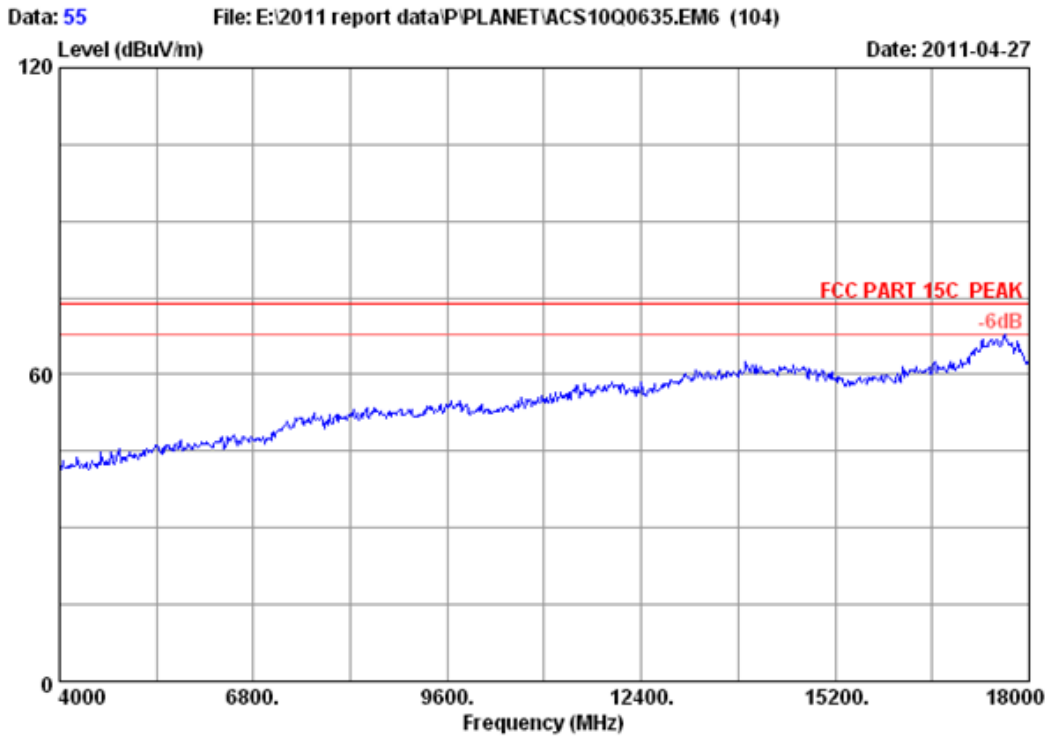

Site no.	: 3m Chamber	Data no. :	55
Dis. / Ant.	: 3m 3115(0911)	Ant. pol. :	VERTICAL
Limit	: FCC PART 15C PEAK		
Env. / Ins.	: 23°C/54%	Engineer :	Leo-Li
EUT	: 150Mbps 802.11n Wireless Broadband Router		
Power	: DC 9V From Adapter input AC 120V/60Hz		
Test mode	: IEEE802.11nHT40 CH1 2422MHz Tx		
M/N	: WNRT-617		

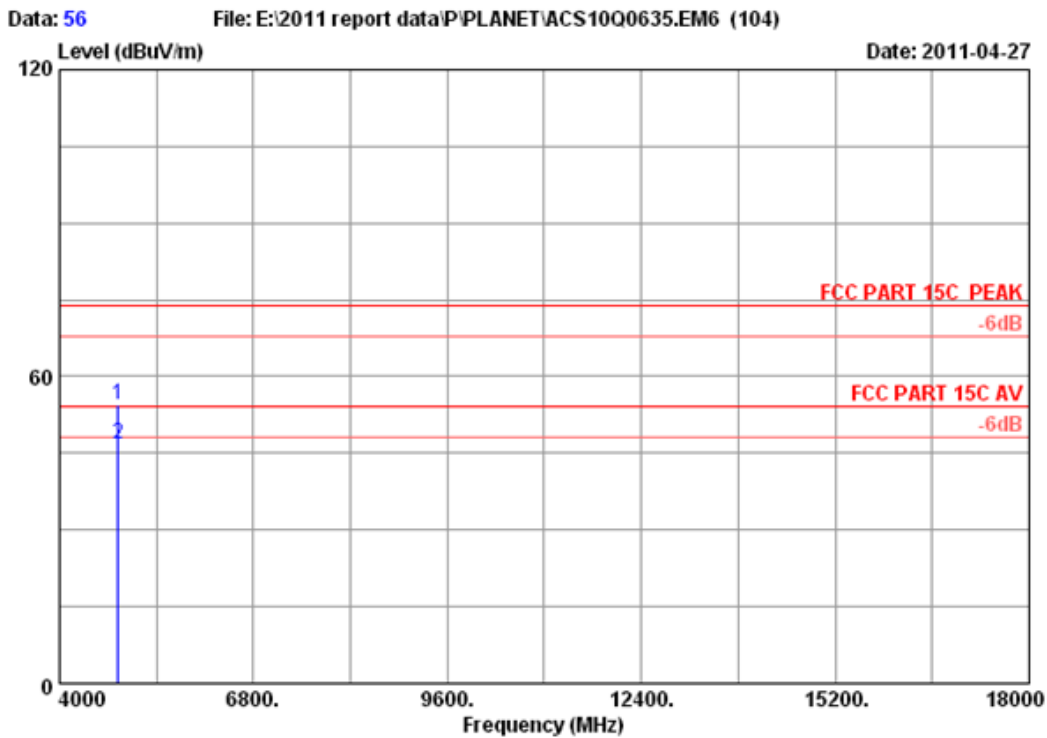

Site no. : 3m Chamber Data no. : 56
 Dis. / Ant. : 3m 3115(0911) Ant. pol. : VERTICAL
 Limit : FCC PART 15C PEAK
 Env. / Ins. : 23*C/54% Engineer : Leo-Li
 EUT : 150Mbps 802.11n Wireless Broadband Router
 Power : DC 9V From Adapter input AC 120V/60Hz
 Test mode : IEEE802.11nHT40 CH1 2422MHz Tx
 M/N : WNRT-617

	Freq. (MHz)	Ant. Factor (dB/m)	Cable loss (dB)	Amp. Factor (dB)	Reading (dBuV)	Emission Level (dBuV/m)	Limits (dBuV/m)	Margin (dB)	Remark
1	4844.000	34.35	10.67	35.05	44.63	54.60	74.00	19.40	Peak
2	4844.000	34.35	10.67	35.05	36.98	46.95	54.00	7.05	Average

Remarks:

1. Emission Level= Antenna Factor + Cable Loss -Amp Factor + Reading.
2. The emission levels that are 20dB below the official limit are not reported.

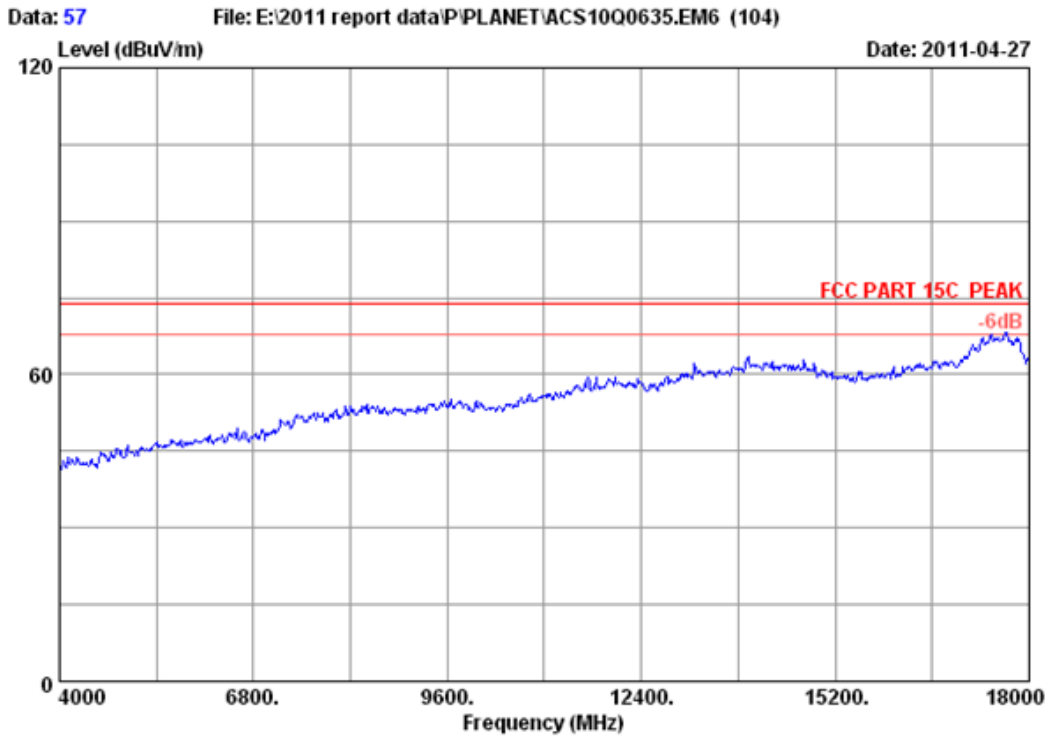

Site no.	: 3m Chamber	Data no. :	57
Dis. / Ant.	: 3m 3115(0911)	Ant. pol. :	HORIZONTAL
Limit	: FCC PART 15C PEAK		
Env. / Ins.	: 23°C/54%	Engineer :	Leo-Li
EUT	: 150Mbps 802.11n Wireless Broadband Router		
Power	: DC 9V From Adapter input AC 120V/60Hz		
Test mode	: IEEE802.11nHT40 CH1 2422MHz Tx		
M/N	: WNRT-617		

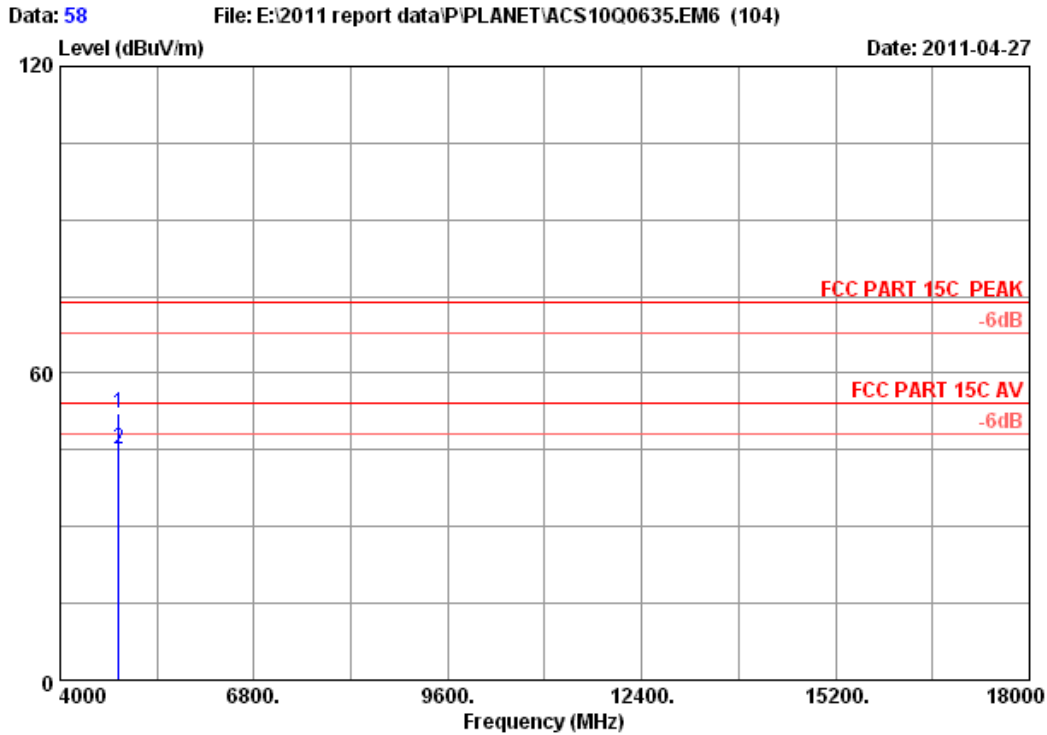

Site no. : 3m Chamber Data no. : 58
 Dis. / Ant. : 3m 3115(0911) Ant. pol. : HORIZONTAL
 Limit : FCC PART 15C PEAK
 Env. / Ins. : 23°C/54% Engineer : Leo-Li
 EUT : 150Mbps 802.11n Wireless Broadband Router
 Power : DC 9V From Adapter input AC 120V/60Hz
 Test mode : IEEE802.11nHT40 CH1 2422MHz Tx
 M/N : WNRT-617

	Ant. Freq. (MHz)	Ant. Factor (dB/m)	Cable loss (dB)	Amp. Factor (dB)	Reading (dBuV)	Emission Level (dBuV/m)	Limits (dBuV/m)	Margin (dB)	Remark
1	4844.000	34.35	10.67	35.05	42.32	52.29	74.00	21.71	Peak
2	4844.000	34.35	10.67	35.05	35.17	45.14	54.00	8.86	Average

Remarks:

1. Emission Level= Antenna Factor + Cable Loss -Amp Factor + Reading.
2. The emission levels that are 20dB below the official limit are not reported.

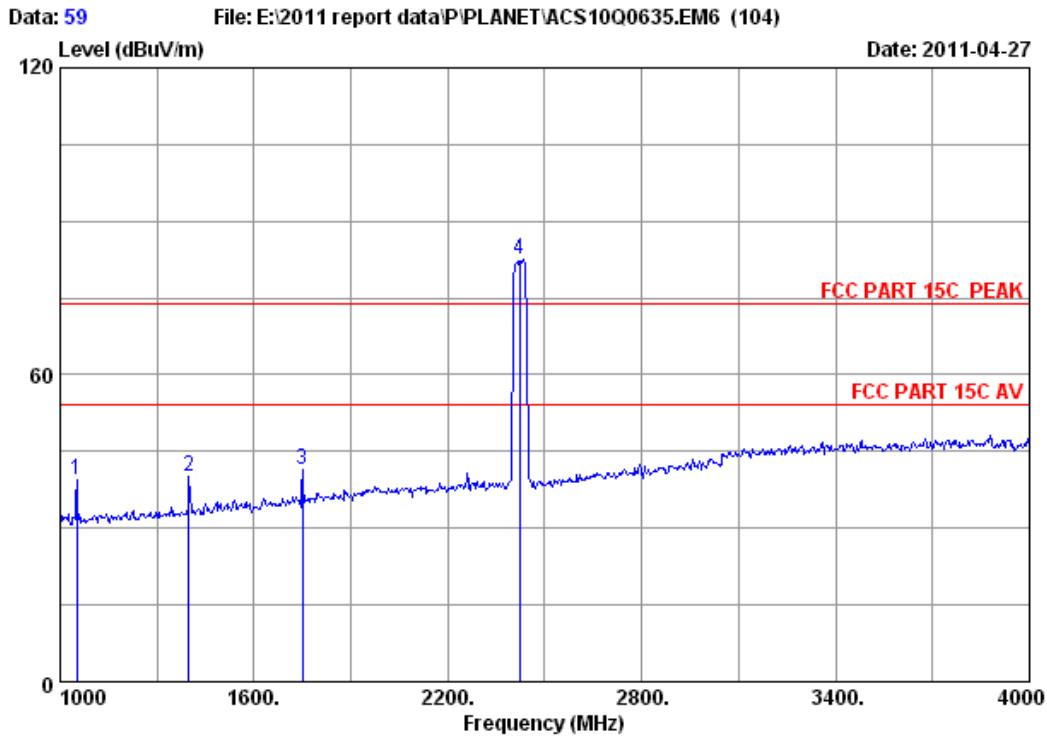

Site no. : 3m Chamber Data no. : 59
 Dis. / Ant. : 3m 3115(0911) Ant. pol. : HORIZONTAL
 Limit : FCC PART 15C PEAK
 Env. / Ins. : 23*C/54% Engineer : Leo-Li
 EUT : 150Mbps 802.11n Wireless Broadband Router
 Power : DC 9V From Adapter input AC 120V/60Hz
 Test mode : IEEE802.11nHT40 CH1 2422MHz Tx
 M/N : WNRT-617

	Ant. Freq. (MHz)	Ant. Factor (dB/m)	Cable loss (dB)	Amp. Factor (dB)	Reading (dBuV)	Emission Level (dBuV/m)	Limits (dBuV/m)	Margin (dB)	Remark
1	1051.000	25.50	4.86	37.81	46.77	39.32	74.00	34.68	Peak
2	1399.000	26.19	5.50	37.18	45.71	40.22	74.00	33.78	Peak
3	1750.000	27.80	6.18	36.86	44.41	41.53	74.00	32.47	Peak
4	2422.000	29.46	7.46	36.61	82.37	82.68	74.00	-8.68	Peak

Remarks:

1. Emission Level= Antenna Factor + Cable Loss -Amp Factor + Reading.
2. The emission levels that are 20dB below the official limit are not reported.

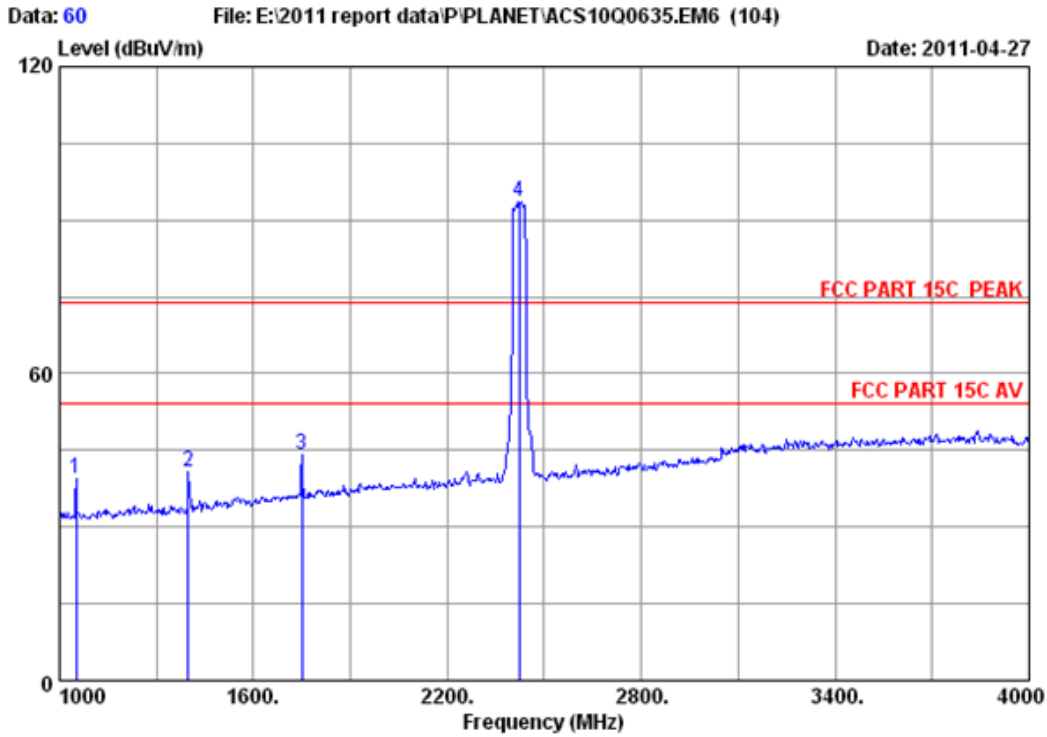

Site no. : 3m Chamber Data no. : 60
 Dis. / Ant. : 3m 3115(0911) Ant. pol. : VERTICAL
 Limit : FCC PART 15C PEAK
 Env. / Ins. : 23°C/54% Engineer : Leo-Li
 EUT : 150Mbps 802.11n Wireless Broadband Router
 Power : DC 9V From Adapter input AC 120V/60Hz
 Test mode : IEEE802.11nHT40 CH1 2422MHz Tx
 M/N : WNRT-617

	Ant. Freq. (MHz)	Ant. Factor (dB/m)	Cable loss (dB)	Amp. Factor (dB)	Reading (dBuV)	Emission Level (dBuV/m)	Limits (dBuV/m)	Margin (dB)	Remark
1	1051.000	25.50	4.86	37.81	46.77	39.32	74.00	34.68	Peak
2	1399.000	26.19	5.50	37.18	46.38	40.89	74.00	33.11	Peak
3	1750.000	27.80	6.18	36.86	46.88	44.00	74.00	30.00	Peak
4	2422.000	29.46	7.46	36.61	93.20	93.51	74.00	-19.51	Peak

Remarks:

1. Emission Level= Antenna Factor + Cable Loss -Amp Factor + Reading.
2. The emission levels that are 20dB below the official limit are not reported.

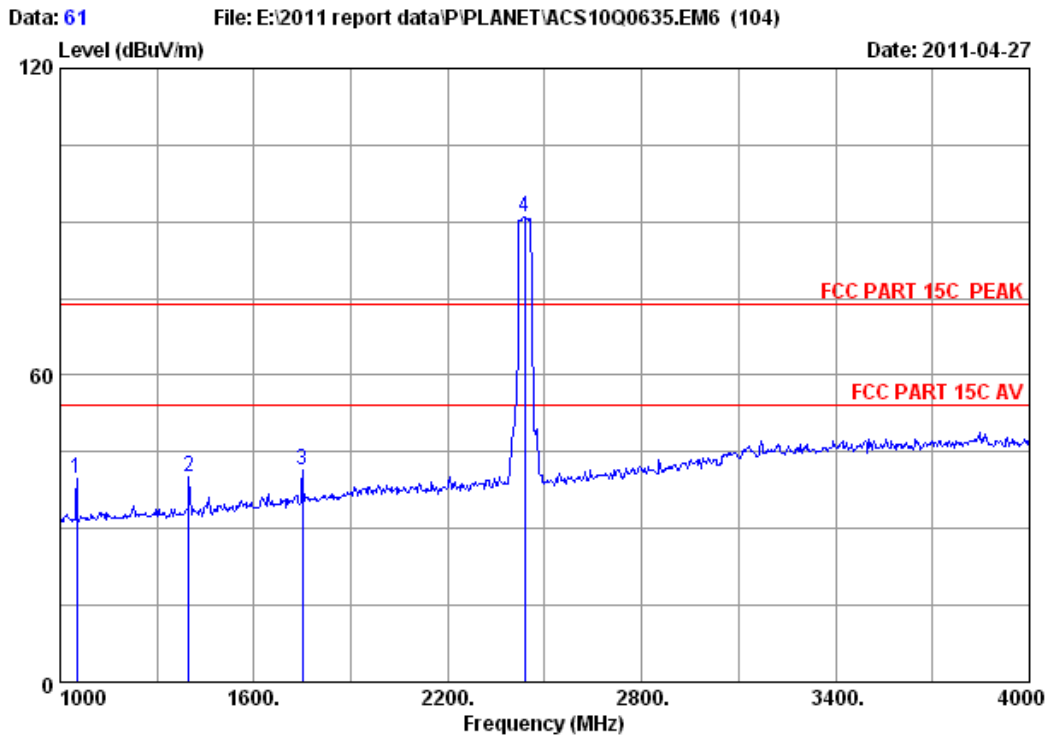

Site no. : 3m Chamber Data no. : 61
 Dis. / Ant. : 3m 3115(0911) Ant. pol. : HORIZONTAL
 Limit : FCC PART 15C PEAK
 Env. / Ins. : 23°C/54% Engineer : Leo-Li
 EUT : 150Mbps 802.11n Wireless Broadband Router
 Power : DC 9V From Adapter input AC 120V/60Hz
 Test mode : IEEE802.11nHT40 CH4 2437MHz Tx
 M/N : WNRT-617

	Ant. Freq. (MHz)	Ant. Factor (dB/m)	Cable loss (dB)	Amp. Factor (dB)	Reading (dBuV)	Emission Level (dBuV/m)	Limits (dBuV/m)	Margin (dB)	Remark
1	1051.000	25.50	4.86	37.81	47.14	39.69	74.00	34.31	Peak
2	1399.000	26.19	5.50	37.18	45.65	40.16	74.00	33.84	Peak
3	1750.000	27.80	6.18	36.86	44.36	41.48	74.00	32.52	Peak
4	2437.000	29.47	7.46	36.61	90.52	90.84	74.00	-16.84	Peak

Remarks:

1. Emission Level= Antenna Factor + Cable Loss -Amp Factor + Reading.
2. The emission levels that are 20dB below the official limit are not reported.

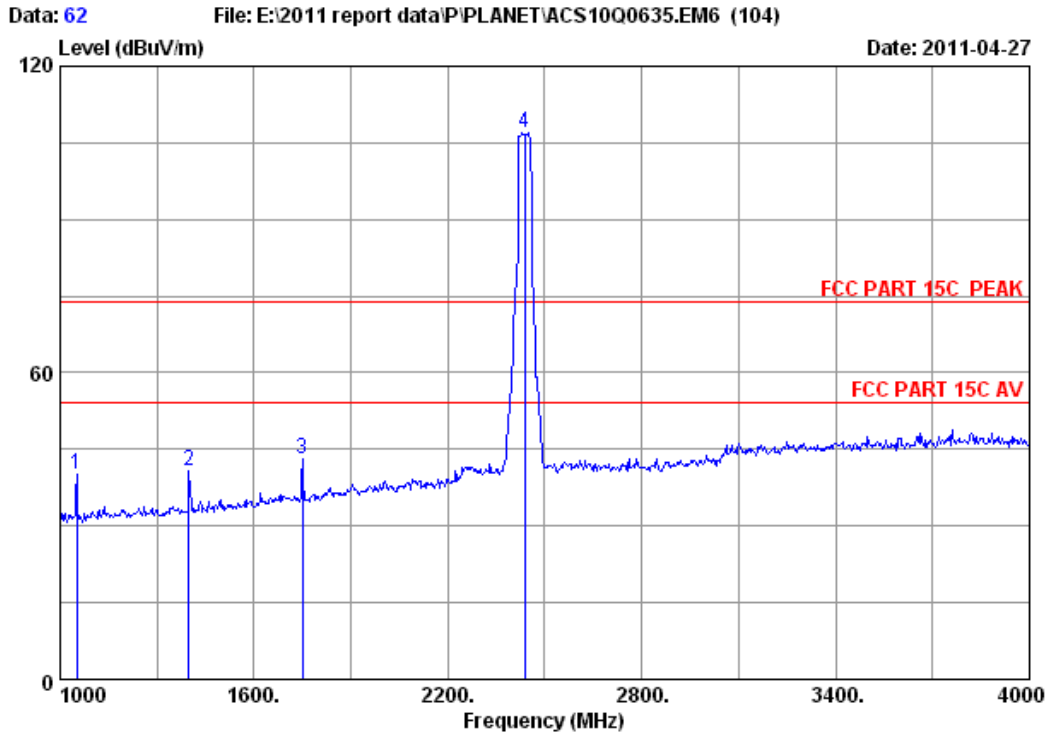

Site no. : 3m Chamber Data no. : 62
 Dis. / Ant. : 3m 3115(0911) Ant. pol. : VERTICAL
 Limit : FCC PART 15C PEAK
 Env. / Ins. : 23°C/54% Engineer : Leo-Li
 EUT : 150Mbps 802.11n Wireless Broadband Router
 Power : DC 9V From Adapter input AC 120V/60Hz
 Test mode : IEEE802.11nHT40 CH4 2437MHz Tx
 M/N : WNRT-617

	Ant. Freq. (MHz)	Ant. Factor (dB/m)	Cable loss (dB)	Amp. Factor (dB)	Reading (dBuV)	Emission Level (dBuV/m)	Limits (dBuV/m)	Margin (dB)	Remark
1	1051.000	25.50	4.86	37.81	47.56	40.11	74.00	33.89	Peak
2	1399.000	26.19	5.50	37.18	46.23	40.74	74.00	33.26	Peak
3	1750.000	27.80	6.18	36.86	45.98	43.10	74.00	30.90	Peak
4	2437.000	29.47	7.46	36.61	106.68	107.00	74.00	-33.00	Peak

Remarks:

1. Emission Level= Antenna Factor + Cable Loss -Amp Factor + Reading.
2. The emission levels that are 20dB below the official limit are not reported.

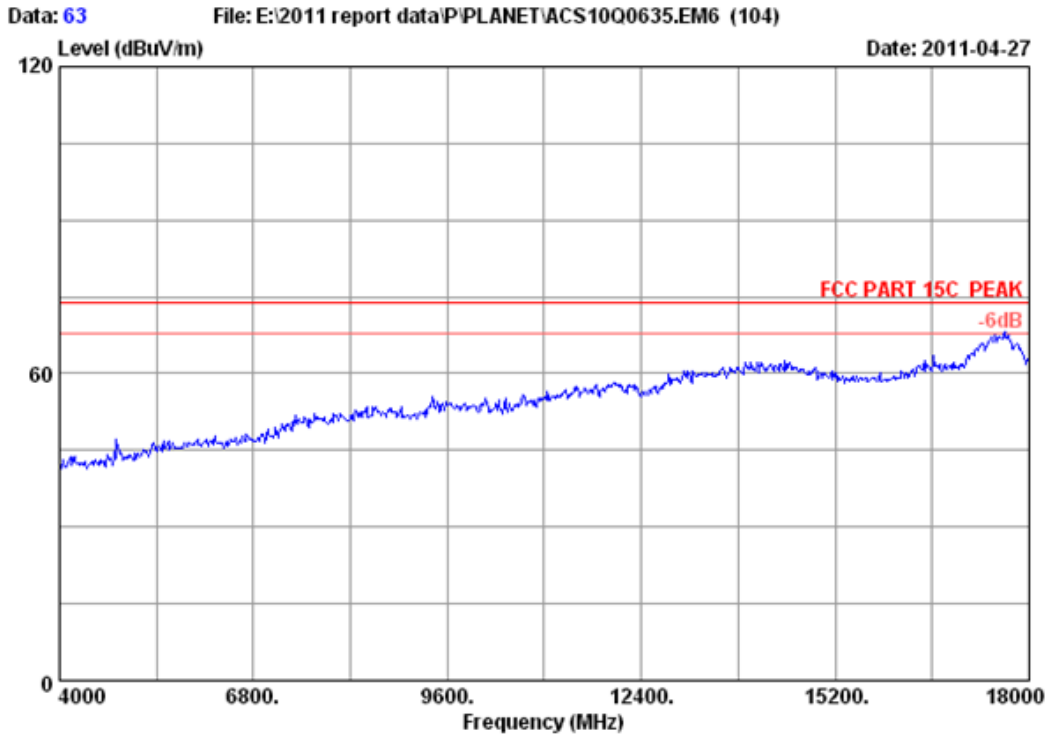

Site no.	: 3m Chamber	Data no. :	63
Dis. / Ant.	: 3m 3115(0911)	Ant. pol. :	VERTICAL
Limit	: FCC PART 15C PEAK		
Env. / Ins.	: 23°C/54%	Engineer :	Leo-Li
EUT	: 150Mbps 802.11n Wireless Broadband Router		
Power	: DC 9V From Adapter input AC 120V/60Hz		
Test mode	: IEEE802.11nHT40 CH4 2437MHz Tx		
M/N	: WNRT-617		

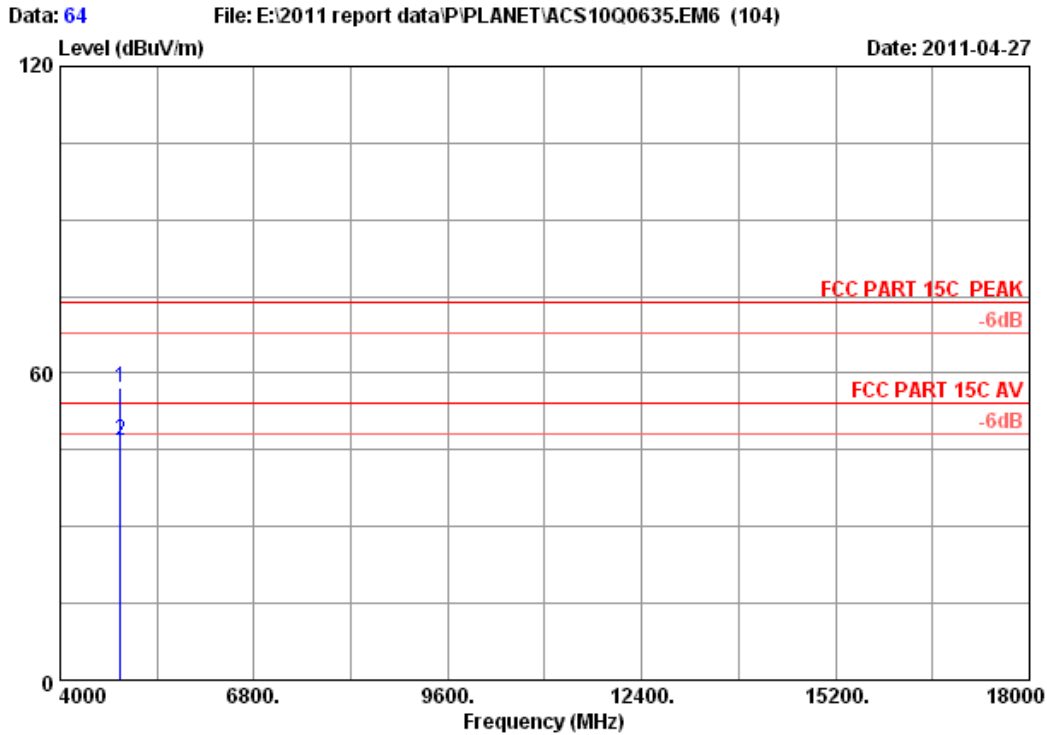

Site no. : 3m Chamber Data no. : 64
 Dis. / Ant. : 3m 3115(0911) Ant. pol. : VERTICAL
 Limit : FCC PART 15C PEAK
 Env. / Ins. : 23°C/54% Engineer : Leo-Li
 EUT : 150Mbps 802.11n Wireless Broadband Router
 Power : DC 9V From Adapter input AC 120V/60Hz
 Test mode : IEEE802.11nHT40 CH4 2437MHz Tx
 M/N : WNRT-617

	Freq. (MHz)	Ant. Factor (dB/m)	Cable loss (dB)	Amp. Factor (dB)	Reading (dBuV)	Emission Level (dBuV/m)	Limits (dBuV/m)	Margin (dB)	Remark
1	4874.000	34.41	10.69	35.03	46.98	57.05	74.00	16.95	Peak
2	4874.000	34.41	10.69	35.03	36.78	46.85	54.00	7.15	Average

Remarks:

1. Emission Level= Antenna Factor + Cable Loss -Amp Factor + Reading.
2. The emission levels that are 20dB below the official limit are not reported.

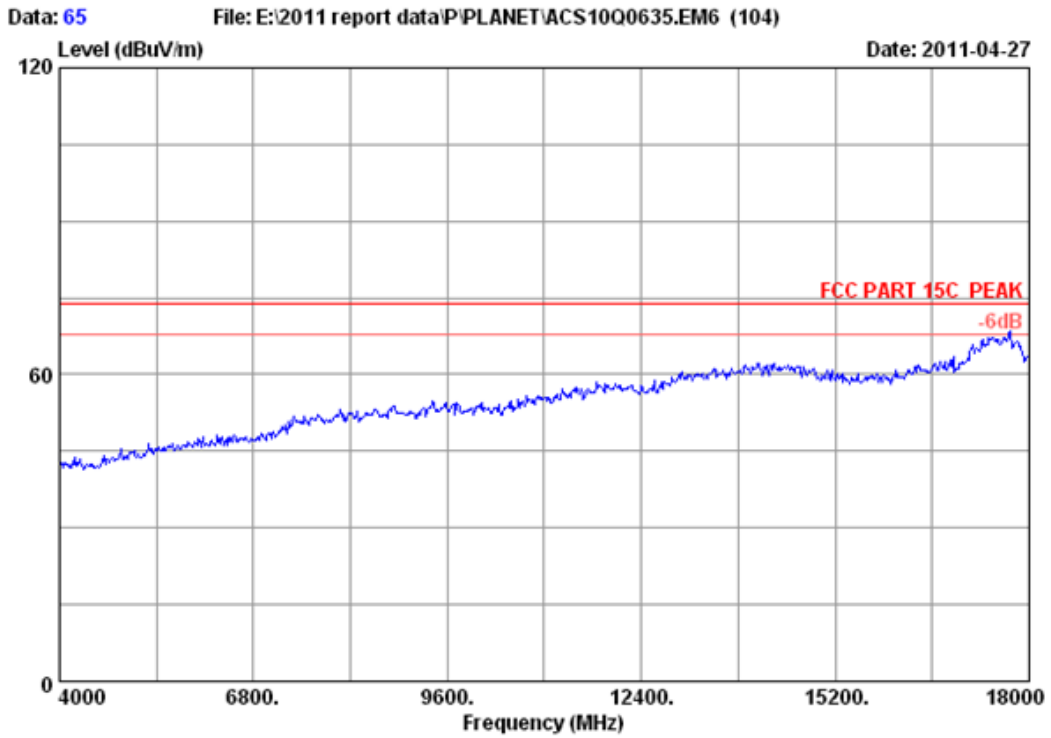

Site no.	: 3m Chamber	Data no. :	65
Dis. / Ant.	: 3m 3115(0911)	Ant. pol. :	HORIZONTAL
Limit	: FCC PART 15C PEAK		
Env. / Ins.	: 23°C/54%	Engineer :	Leo-Li
EUT	: 150Mbps 802.11n Wireless Broadband Router		
Power	: DC 9V From Adapter input AC 120V/60Hz		
Test mode	: IEEE802.11nHT40 CH4 2437MHz Tx		
M/N	: WNRT-617		

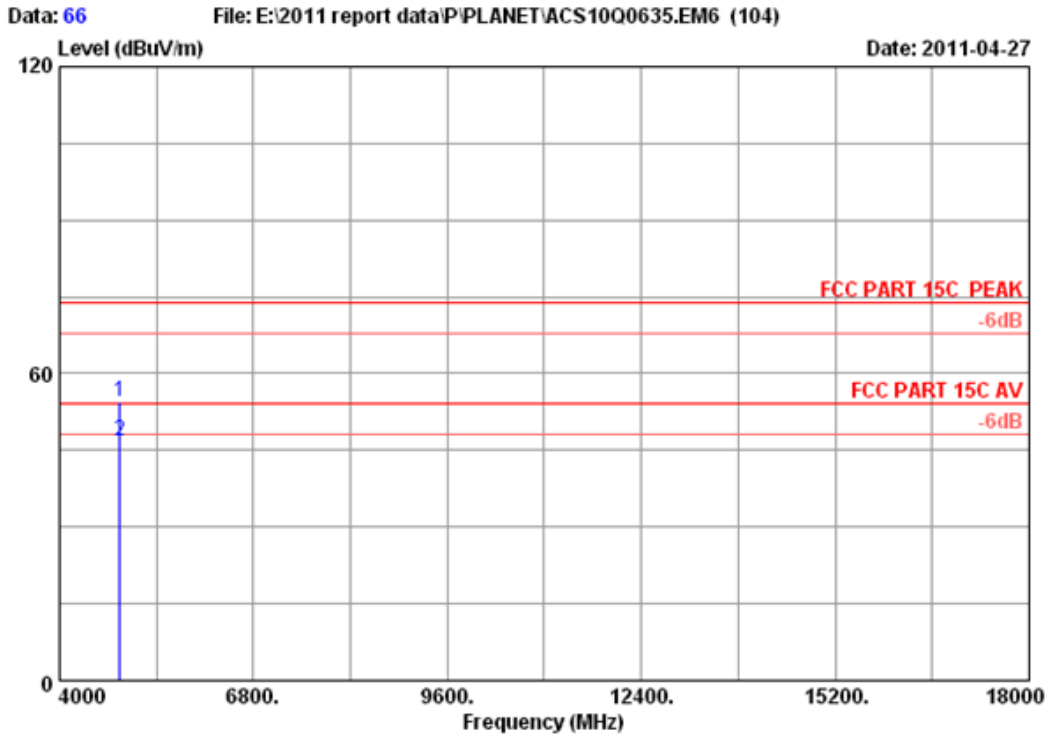

Site no. : 3m Chamber Data no. : 66
 Dis. / Ant. : 3m 3115(0911) Ant. pol. : HORIZONTAL
 Limit : FCC PART 15C PEAK
 Env. / Ins. : 23°C/54% Engineer : Leo-Li
 EUT : 150Mbps 802.11n Wireless Broadband Router
 Power : DC 9V From Adapter input AC 120V/60Hz
 Test mode : IEEE802.11nHT40 CH4 2437MHz Tx
 M/N : WNRT-617

	Freq. (MHz)	Ant. Factor (dB/m)	Cable loss (dB)	Amp. Factor (dB)	Reading (dBuV)	Emission Level (dBuV/m)	Limits (dBuV/m)	Margin (dB)	Remark
1	4874.000	34.41	10.69	35.03	44.36	54.43	74.00	19.57	Peak
2	4874.000	34.41	10.69	35.03	36.84	46.91	54.00	7.09	Average

Remarks:

1. Emission Level= Antenna Factor + Cable Loss -Amp Factor + Reading.
2. The emission levels that are 20dB below the official limit are not reported.

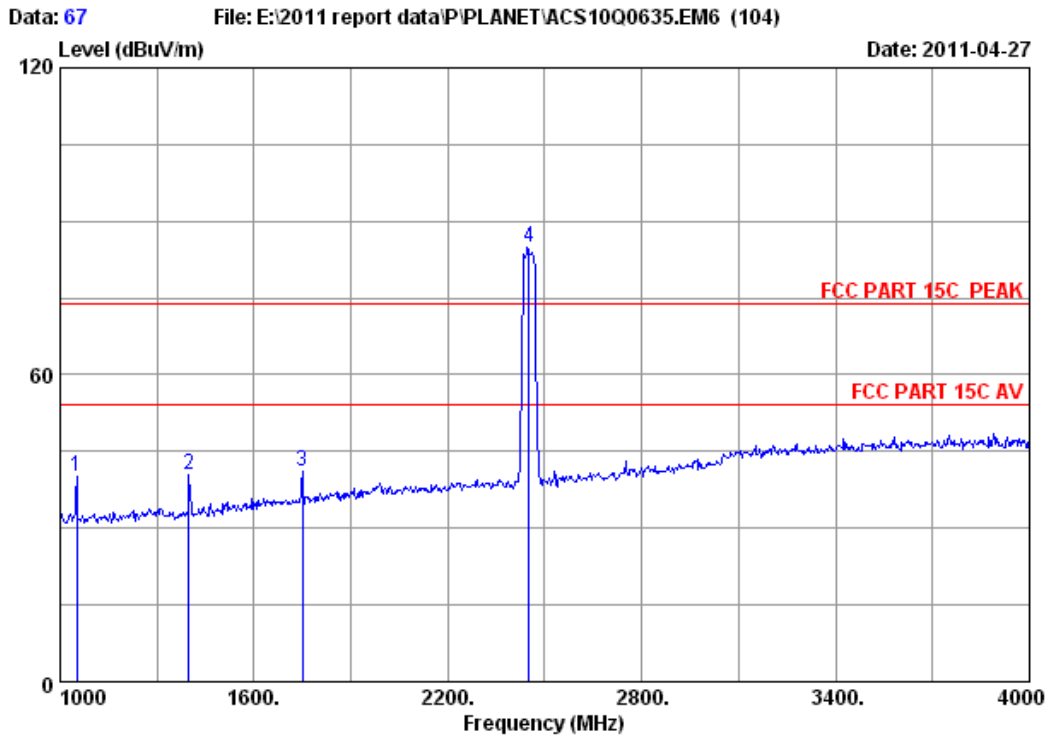

Site no. : 3m Chamber Data no. : 67
 Dis. / Ant. : 3m 3115(0911) Ant. pol. : HORIZONTAL
 Limit : FCC PART 15C PEAK
 Env. / Ins. : 23*C/54% Engineer : Leo-Li
 EUT : 150Mbps 802.11n Wireless Broadband Router
 Power : DC 9V From Adapter input AC 120V/60Hz
 Test mode : IEEE802.11nHT40 CH7 2452MHz Tx
 M/N : WNRT-617

	Ant. Freq. (MHz)	Ant. Factor (dB/m)	Cable loss (dB)	Amp. Factor (dB)	Reading (dBUV)	Emission Level (dBUV/m)	Limits (dBUV/m)	Margin (dB)	Remark
1	1051.000	25.50	4.86	37.81	47.50	40.05	74.00	33.95	Peak
2	1399.000	26.19	5.50	37.18	45.92	40.43	74.00	33.57	Peak
3	1750.000	27.80	6.18	36.86	44.15	41.27	74.00	32.73	Peak
4	2452.000	29.47	7.50	36.61	84.62	84.98	74.00	-10.98	Peak

Remarks:

1. Emission Level= Antenna Factor + Cable Loss -Amp Factor + Reading.
2. The emission levels that are 20dB below the official limit are not reported.

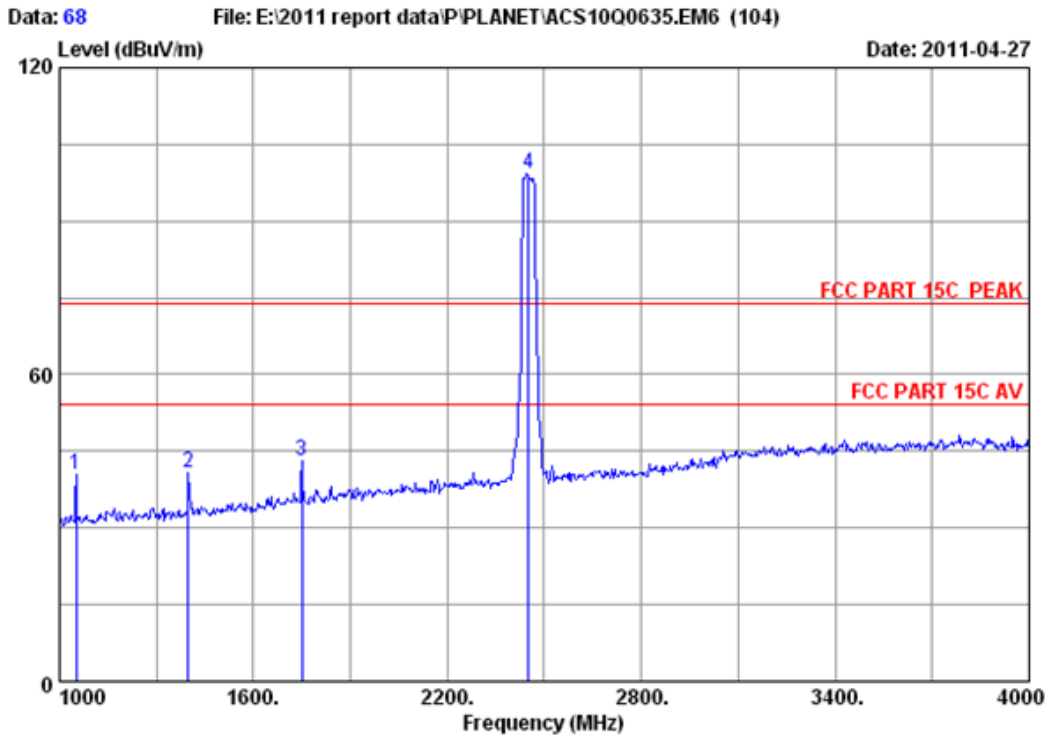

Site no. : 3m Chamber Data no. : 68
 Dis. / Ant. : 3m 3115(0911) Ant. pol. : VERTICAL
 Limit : FCC PART 15C PEAK
 Env. / Ins. : 23°C/54% Engineer : Leo-Li
 EUT : 150Mbps 802.11n Wireless Broadband Router
 Power : DC 9V From Adapter input AC 120V/60Hz
 Test mode : IEEE802.11nHT40 CH7 2452MHz Tx
 M/N : WNRT-617

	Ant. Freq. (MHz)	Ant. Factor (dB/m)	Cable loss (dB)	Amp. Factor (dB)	Reading (dBuV)	Emission Level (dBuV/m)	Limits (dBuV/m)	Margin (dB)	Remark
1	1051.000	25.50	4.86	37.81	47.75	40.30	74.00	33.70	Peak
2	1399.000	26.19	5.50	37.18	46.34	40.85	74.00	33.15	Peak
3	1750.000	27.80	6.18	36.86	46.06	43.18	74.00	30.82	Peak
4	2452.000	29.47	7.50	36.61	98.80	99.16	74.00	-25.16	Peak

Remarks:

1. Emission Level= Antenna Factor + Cable Loss -Amp Factor + Reading.
2. The emission levels that are 20dB below the official limit are not reported.

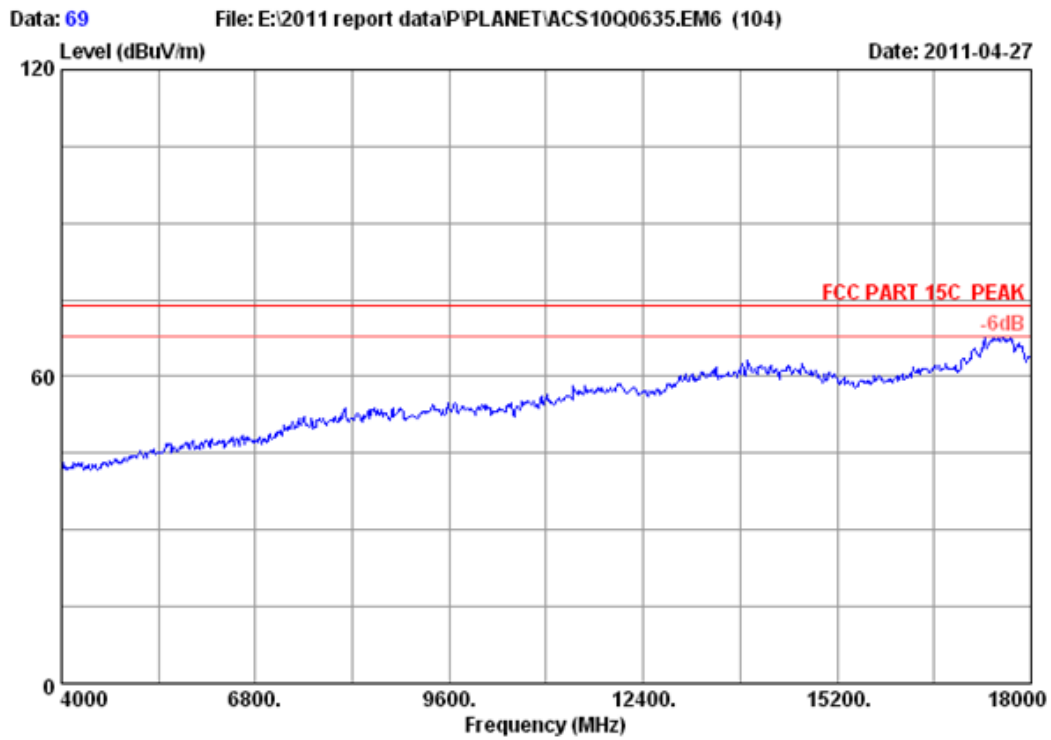

Site no.	: 3m Chamber	Data no. :	69
Dis. / Ant.	: 3m 3115(0911)	Ant. pol. :	HORIZONTAL
Limit	: FCC PART 15C PEAK		
Env. / Ins.	: 23°C/54%	Engineer :	Leo-Li
EUT	: 150Mbps 802.11n Wireless Broadband Router		
Power	: DC 9V From Adapter input AC 120V/60Hz		
Test mode	: IEEE802.11nHT40 CH7 2452MHz Tx		
M/N	: WNRT-617		

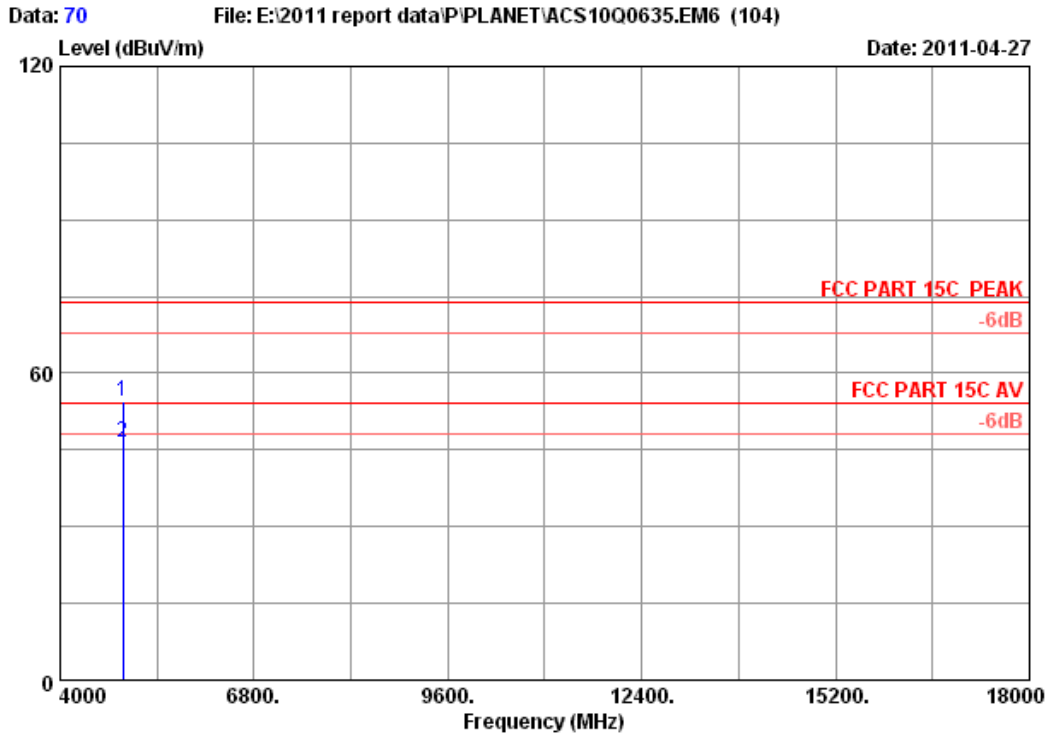

Site no. : 3m Chamber Data no. : 70
 Dis. / Ant. : 3m 3115(0911) Ant. pol. : HORIZONTAL
 Limit : FCC PART 15C PEAK
 Env. / Ins. : 23°C/54% Engineer : Leo-Li
 EUT : 150Mbps 802.11n Wireless Broadband Router
 Power : DC 9V From Adapter input AC 120V/60Hz
 Test mode : IEEE802.11nHT40 CH7 2452MHz Tx
 M/N : WNRT-617

	Freq. (MHz)	Ant. Factor (dB/m)	Cable loss (dB)	Amp. Factor (dB)	Reading (dBuV)	Emission Level (dBuV/m)	Limits (dBuV/m)	Margin (dB)	Remark
1	4904.000	34.46	10.74	35.00	44.26	54.46	74.00	19.54	Peak
2	4904.000	34.46	10.74	35.00	36.24	46.44	54.00	7.56	Average

Remarks:

1. Emission Level= Antenna Factor + Cable Loss -Amp Factor + Reading.
2. The emission levels that are 20dB below the official limit are not reported.

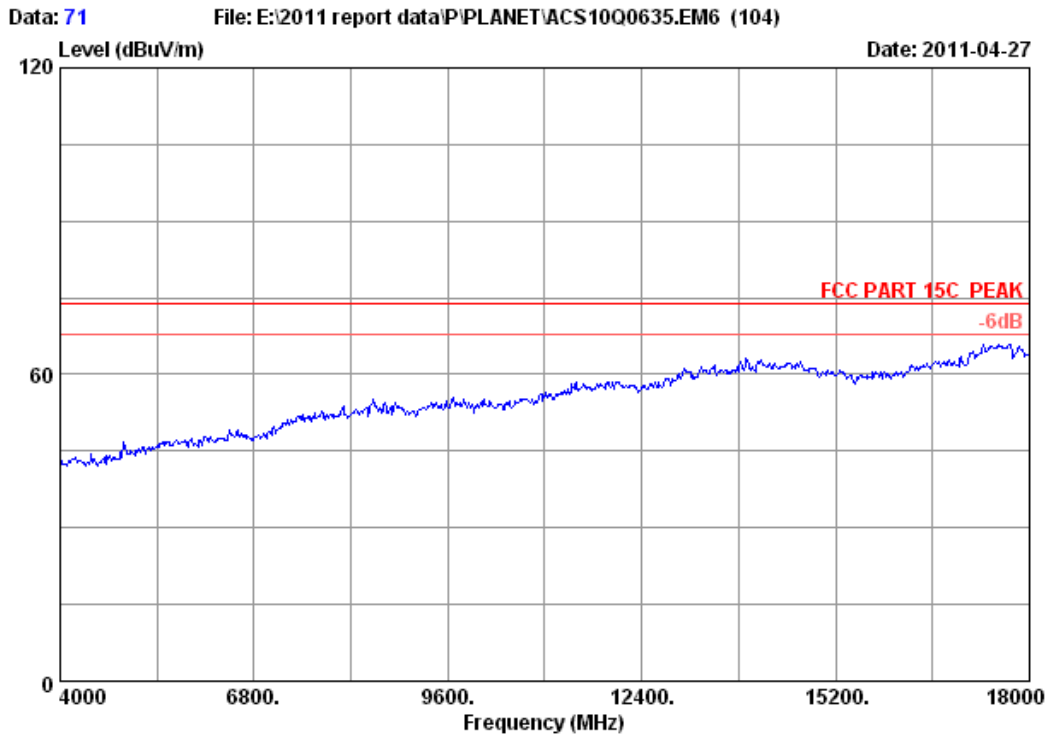

Site no.	: 3m Chamber	Data no. :	71
Dis. / Ant.	: 3m 3115(0911)	Ant. pol. :	VERTICAL
Limit	: FCC PART 15C PEAK		
Env. / Ins.	: 23°C/54%	Engineer :	Leo-Li
EUT	: 150Mbps 802.11n Wireless Broadband Router		
Power	: DC 9V From Adapter input AC 120V/60Hz		
Test mode	: IEEE802.11nHT40 CH7 2452MHz Tx		
M/N	: WNRT-617		