



Spectrum Research & Testing Lab., Inc.

No. 101-10, Ling 8,
Shan-Tong LI, Chung-Li
City, Taoyuan, Taiwan

TEST REPORT

Reference No.: A06082902
Report No.: FCCA06082902
FCCID: UKT95025-MF001
Page: 1 of 44
Date: Sep. 11, 2006

Product Name: Wireless Guitar Controller
Model Number: 95025;MF001
Applicant: Mayflash Ltd.
5/F, Block A3, HuaFeng KeJi Yuan, 82 Zone, Baoan
Shenzhen, China
Date of Receipt: Aug. 29, 2006
Finished date of Test: Sep. 11, 2006
Applicable Standards: 47 CFR Part 15, Subpart C
47 CFR Part 15, Subpart B
ANSI C63.4: 2003

We, **Spectrum Research & Testing Laboratory Inc.**, hereby certify that one sample of the above was tested in our laboratory with positive results according to the above-mentioned standards. The records in the report are an accurate account of the results. Details of the results are given in the subsequent pages of this report.

Tested By : Mao Feng Hsu , Date: Sep. 11, 2006
(Mao Feng Hsu)

Approved By : JCF , Date: Sep. 11, 2006
(Johnson Ho, Director)

NVLAQ[®]

Lab Code: 200099-0



TABLE OF CONTENTS

1. DOCUMENT POLICY AND TEST STATEMENT	4
1.1 DOCUMENT POLICY	4
1.2 TEST STATEMENT	4
1.3 EUT MODIFICATION	4
2. DESCRIPTION OF EUT AND TEST MODE	5
2.1 GENERAL DESCRIPTION OF EUT	5
2.2 DESCRIPTION OF SUPPORT UNIT	6
2.3 DESCRIPTION OF TEST MODE	6
3. DESCRIPTION OF APPLIED STANDARDS	7
4. TECHNICAL CHARACTERISTICS TEST	8
4.1 20DB BANDWIDTH.....	8
4.1.1 LIMIT	8
4.1.2 TEST EQUIPMENT	8
4.1.3 TEST SET-UP	8
4.1.4 TEST PROCEDURE	8
4.1.5 EUT OPERATING CONDITION	8
4.1.6 TEST RESULT	9
4.2 PEAK POWER TEST	13
4.2.1 LIMIT	13
4.2.2 TEST EQUIPMENT	13
4.2.3 TEST SET-UP	14
4.2.4 TEST PROCEDURE	14
4.2.5 EUT OPERATING CONDITION	14
4.2.6 TEST RESULT	15
4.3 BAND EDGE TEST	19
4.3.1 LIMIT	19
4.3.2 TEST EQUIPMENT	20
4.3.3 TEST SET-UP.....	21
4.3.4 TEST PROCEDURE.....	22
4.3.5 EUT OPERATING CONDITION.....	22
4.3.6 TEST RESULT.....	22
4.4 SPURIOUS RADIATED EMISSION TEST	25
4.4.1 LIMIT	25
4.4.2 TEST EQUIPMENT	26
4.4.3 TEST SET-UP	27
4.4.4 TEST PROCEDURE	29
4.4.5 EUT OPERATING CONDITION	29
4.4.6 TEST RESULT	30
4.5 CONDUCTED EMISSION TEST FOR POWER PORT	37
4.5.1 CONDUCTED EMISSION LIMIT.....	37
4.5.2 TEST EQUIPMENT	37
4.5.3 TEST SETUP	38
4.5.4 TEST PROCEDURE	38



**Spectrum Research &
Testing Lab., Inc.**
No. 101-10, Ling 8,
Shan-Tong Li, Chung-Li
City, Taoyuan, Taiwan

TEST REPORT

Reference No.: A06082902
Report No.: FCCA06082902
FCCID: UKT95025-MF001
Page:3 of 44
Date: Sep. 11, 2006

4.5.5 TEST RESULT	39
5. ANTENNA APPLICATION	40
5.1 ANTENNA REQUIREMENT	40
5.2 RESULT	40
6. PHOTOS OF TESTING.....	41
7. TERMS OF ABBREVIATION.....	44



**Spectrum Research &
Testing Lab., Inc.**
No. 101-10, Ling 8,
Shan-Tong Li, Chung-Li
City, Taoyuan, Taiwan

TEST REPORT

Reference No.: A06082902
Report No.: FCCA06082902
FCCID: UKT95025-MF001
Page:4 of 44
Date: Sep. 11, 2006

1. DOCUMENT POLICY AND TEST STATEMENT

1.1 DOCUMENT POLICY

- The report shall not be reproduced except in full, without the written approval of SRT Lab, Inc.

1.2 TEST STATEMENT

- The test results in the report apply only to the unit tested by SRT Lab.
- There was no deviation from the requirements of test standards during the test.
- AC power source, 120 VAC/60 Hz, was used during the test.
- DC 4.5V from battery was used during the test.

1.3 EUT MODIFICATION

- No modification in SRT Lab.



Spectrum Research & Testing Lab., Inc.
No. 101-10, Ling 8,
Shan-Tong Li, Chung-Li
City, Taoyuan, Taiwan

TEST REPORT

Reference No.: A06082902
Report No.: FCCA06082902
FCCID: UKT95025-MF001
Page:5 of 44
Date: Sep. 11, 2006

2. DESCRIPTION OF EUT AND TEST MODE

2.1 GENERAL DESCRIPTION OF EUT

PRODUCT	Wireless Guitar Controller
MODEL NO.	95025;MF001
POWER SUPPLY	Transmitter: DC 4.5 V
FREQUENCY BAND	2.400~2.4835GHz
CARRIER FREQUENCY	2.406GHz~2.478GHz
NUMBER OF CHANNEL	32
CHANNEL SPACING	2MHz
RATED RF OUTPUT POWER	0dBm (1mW)
I.F. & L.O.	I.F.: 2MHz, L.O.: 1604-1652 MHz
MODULATION TYPE	FSK
BIT RATE OF TRANSMISSION	250Kbps
DUTY CYCLE	2%
ANTENNA TYPE	PCB Antenna
ANTENNA GAIN	Max 2 dBi
OPERATING TEMPERATURE	-10-70°C
CHANNEL BANDWIDTH	5.12MHz

NOTE :

The EUT has two model numbers, one is transmitter part, and the other is receiver part.



2.2 DESCRIPTION OF SUPPORT UNIT

The transmitter part of EUT was tested with a Game system(Play station 2) and configured by the requirement of ANSI C63.4. All interface ports were connected to the appropriate support units via specific cables. The support units and cables are listed below.

NO	DEVICE	BRAND	MODEL #	FCC ID/DOC	CABLE
1	PLAY STATION 2	SONY	SCPH-15000	N/A	1.5m unshielded power cord 1.5m unshielded data cable
2	TV	TECO	TL2009FM	N/A	1.5m shielded data cable

NOTE :

For the actual test configuration, please refer to the photos of testing.

2.3 DESCRIPTION OF TEST MODE

32 channels are provided by EUT. The 3 channels of lower, medium and higher were chosen for test..

Channel	Frequency(MHz)
0	2406
17	2440
31	2478

NOTE :

1. Below 1 GHz, the channel 0, 17 and 31 were pre-tested in chamber. The channel 31, worst case one, was chosen for radiated emission test.
2. Above 1 GHz, the channel 0, 17 and 31 were tested individually.



**Spectrum Research &
Testing Lab., Inc.**
No. 101-10, Ling 8,
Shan-Tong Li, Chung-Li
City, Taoyuan, Taiwan

TEST REPORT

Reference No.: A06082902
Report No.: FCCA06082902
FCCID: UKT95025-MF001
Page:7 of 44
Date: Sep. 11, 2006

3. DESCRIPTION OF APPLIED STANDARDS

The EUT is a kind of wireless product and to be connected with a Game system for normal use. According to the specifications provided by the applicant, it must comply with the requirements of the following standards:

47 CFR Part 15, Subpart C

47 CFR Part 15, Subpart B

ANSI C63.4: 2003

Public DA00-705 (March 2000)

All tests have been performed and recorded as the above standards.



4. TECHNICAL CHARACTERISTICS TEST

4.1 20dB Bandwidth

4.1.1 LIMIT

Frequency Range (MHz)	Quantity of Hopping Channel	Limit(kHz)			
		50	25	15	75
902-928		<250	>250	NA	NA
2400-2483.5		NA	NA	>1000	<1000

4.1.2 TEST EQUIPMENT

The following test equipment was used during the test:

EQUIPMENT/FACILITIES	SPECIFICATIONS	MANUFACTURER	MODEL#/SERIAL#	DUE DATE OF CAL. & CAL. CENTER
SPECTRUM	9kHz-7GHz	ROHDE & SCHWARZ	FSP7/ 839511/010	APR. 2007 R&S

NOTE: The calibration interval of the above test equipment is one year and the calibrations are traceable to NML/ROC and NIST/USA.

4.1.3 TEST SET-UP

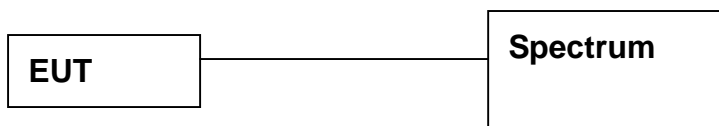

The EUT was connected to a spectrum through a 50Ω RF cable.

4.1.4 TEST PROCEDURE

The EUT was operating in hopping mode or could be controlled its channel. Printed out the test result from the spectrum by hard copy function.

4.1.5 EUT OPERATING CONDITION

Set the EUT under transmission condition continuously at a specific channel frequency.



Spectrum Research & Testing Lab., Inc.
No. 101-10, Ling 8,
Shan-Tong Li, Chung-Li
City, Taoyuan, Taiwan

TEST REPORT

Reference No.: A06082902
Report No.: FCCA06082902
FCCID: UKT95025-MF001
Page:9 of 44
Date: Sep. 11, 2006

4.1.6 TEST RESULT

Temperature: 24°C Humidity: 55%RH
Spectrum Detector: PK Tested by: Mao Feng Hsu
Test Result: PASS Tested Date: Sep. 01, 2006
Guitar Controller:TX

CHANNEL NUMBER	CHANNEL FREQUENCY (MHz)	20dB DOWN BW (kHz)
0	2406	5180
17	2440	5200
31	2478	5160



gain as controller = 1 X
Bandwidth

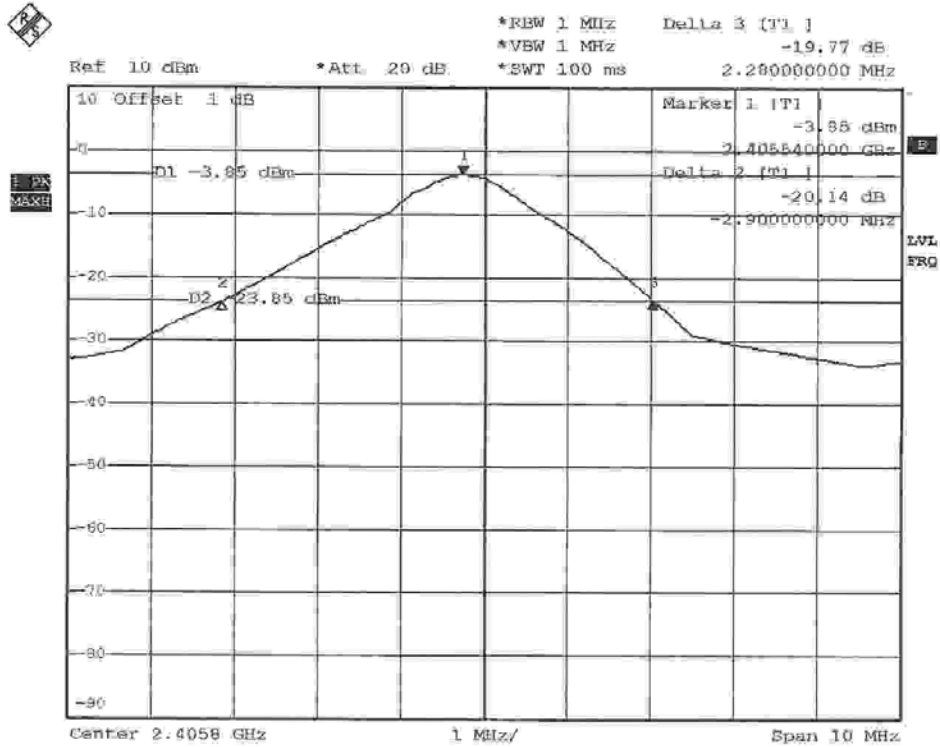

Date: 1.SEP.2006 11:51:54

CHO. 20dB bandwidth = 5.18 MHz

M.F. Hsu



*Guitar controller = 1x
 Bandwidth*

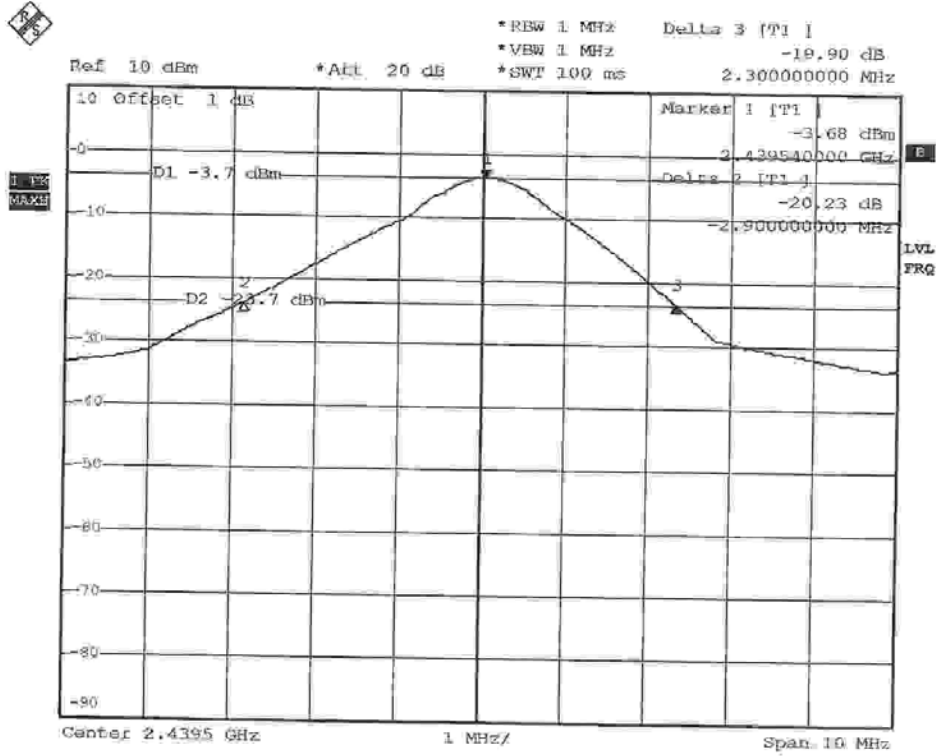

Date: 1.SEP.2006 11:43:16

CH17. 20dB bandwidth = 5.2 MHz

M.F.Hsu



Spectrum Research & Testing Lab., Inc.
 No. 101-10, Ling 8,
 Shan-Tong Li, Chung-Li
 City, Taoyuan, Taiwan

TEST REPORT

Reference No.: A06082902
 Report No.: FCCA06082902
 FCCID: UKT95025-MF001
 Page:12 of 44
 Date: Sep. 11, 2006

guitar controller = 1 X
Bandwidth

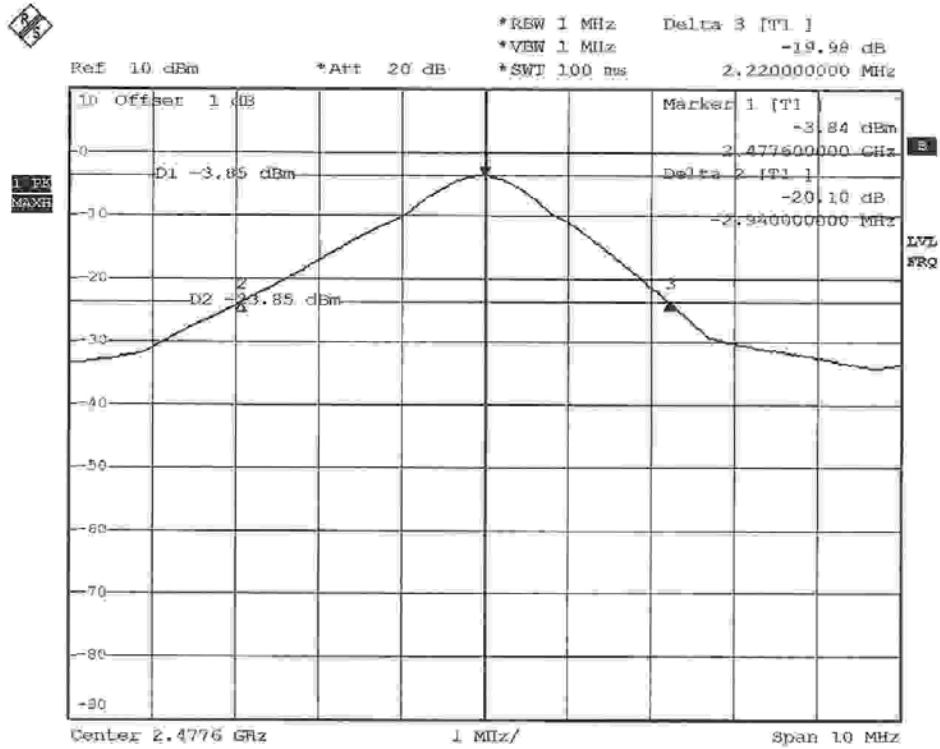

Date: 1.SEP.2006 11:34:22

CH31. 20dB bandwidth = 5.16 MHz

M.F. Hsu



Spectrum Research & Testing Lab., Inc.
 No. 101-10, Ling 8,
 Shan-Tong Li, Chung-Li
 City, Taoyuan, Taiwan

TEST REPORT

Reference No.: A06082902
 Report No.: FCCA06082902
 FCCID: UKT95025-MF001
 Page:13 of 44
 Date: Sep. 11, 2006

4.2 PEAK POWER TEST

4.2.1 LIMIT

FCC Part15, Subpart C Section 15.247.

FREQUENCY RANGE (MHz)	Quantity of Hopping Channel	LIMIT (W)			
		50	25	15	75
902-928		1(30dBm)	0.125(21dBm)	NA	NA
2400-2483.5		NA	NA	0.125(21dBm)	1(30dBm)
5725-5850		NA	NA	NA	1(30dBm)

4.2.2 TEST EQUIPMENT

The following test equipment was used during the test :

EQUIPMENT/FACILITIES	SPECIFICATIONS	MANUFACTURER	MODEL#/SERIAL#	DUE DATE OF CAL. & CAL. CENTER
SPECTRUM	9kHz-7GHz	ROHDE & SCHWARZ	FSP7/ 839511/010	APR. 2007 R&S
POWER METER	N/A	BOONTON	4232A/ 29001	MAY 2007 ETC
POWER SENSOR	DC-18GHz 0.3 μ W-100mW 50 Ω	BOONTON	51011-EMC/ 31184	JUN. 2007 ETC

NOTE: The calibration interval of the above test equipment is one year and the calibrations are traceable to NML/ROC and NIST/USA.



4.2.3 TEST SET-UP

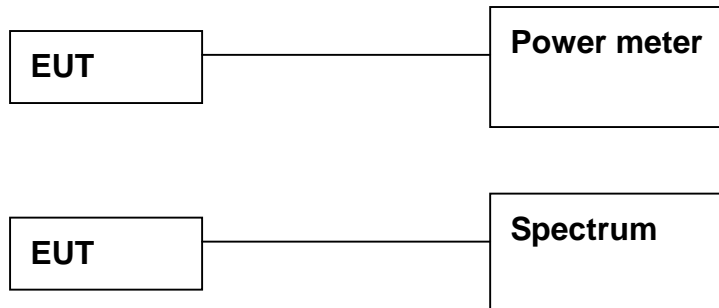

The EUT was connected to a spectrum through a 50 Ω RF cable.

4.2.4 TEST PROCEDURE

The EUT was operating in hopping mode or could control its channel.
Printed out the test result from the spectrum by hard copy function.
Recorded the read value of the power meter.

4.2.5 EUT OPERATING CONDITION

Same as section 4.1.5 of this report.



Spectrum Research & Testing Lab., Inc.
No. 101-10, Ling 8,
Shan-Tong Li, Chung-Li
City, Taoyuan, Taiwan

TEST REPORT

Reference No.: A06082902
Report No.: FCCA06082902
FCCID: UKT95025-MF001
Page:15 of 44
Date: Sep. 11, 2006

4.2.6 TEST RESULT

Temperature: 24°C Humidity: 55%RH
Spectrum Detector: PK Tested by: Mao Feng Hsu
Test Result: PASS Tested Date: Sep. 01, 2006
Guitar Controller:TX

CHANNEL NUMBER	CHANNEL FREQUENCY (MHz)	PEAK POWER OUTPUT (dBm)	PEAK POWER LIMIT (dBm)
0	2406.0000	-5.53	21
17	2440.0000	-4.96	21
31	2478.0000	-5.14	21



Spectrum Research & Testing Lab., Inc.
 No. 101-10, Ling 8,
 Shan-Tong Li, Chung-Li
 City, Taoyuan, Taiwan

TEST REPORT

Reference No.: A06082902
 Report No.: FCCA06082902
 FCCID: UKT95025-MF001
 Page:16 of 44
 Date: Sep. 11, 2006

*gain/att controller: 1X
 output power*

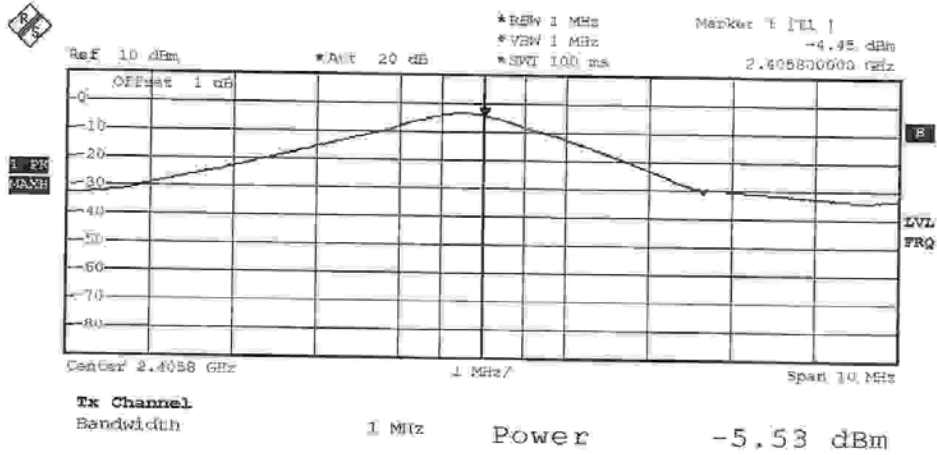

CHO

M.F. Hsu.

Date: 1.SEP.2006 11:49:17



Spectrum Research & Testing Lab., Inc.
 No. 101-10, Ling 8,
 Shan-Tong Li, Chung-Li
 City, Taoyuan, Taiwan

TEST REPORT

Reference No.: A06082902
 Report No.: FCCA06082902
 FCCID: UKT95025-MF001
 Page: 17 of 44
 Date: Sep. 11, 2006

*guitar controller TX
 output power*

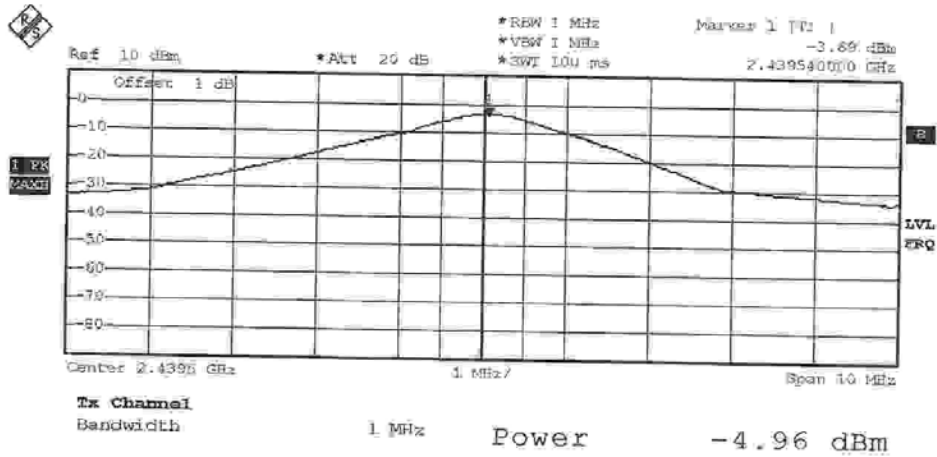

CH17

M. F. Hsu

Date: 1.SEP.2006 11:45:22



Spectrum Research & Testing Lab., Inc.
 No. 101-10, Ling 8,
 Shan-Tong Li, Chung-Li
 City, Taoyuan, Taiwan

TEST REPORT

Reference No.: A06082902
 Report No.: FCCA06082902
 FCCID: UKT95025-MF001
 Page: 18 of 44
 Date: Sep. 11, 2006

*guitar controller = 1X
 output power*

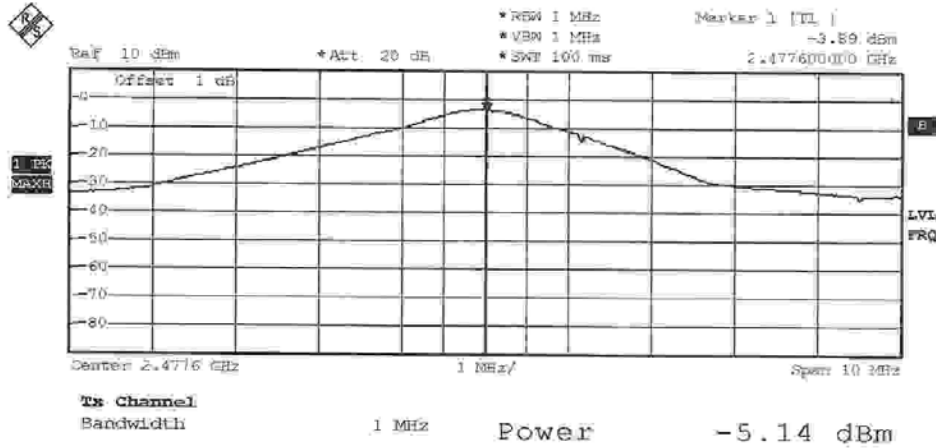

CH3/ 2478

M.F. Hsu

Date: 1.SEP.2006 11:36:08



4.3 BAND EDGE TEST

4.3.1 LIMIT

FCC Part15, Subpart C Section 15.247. In any 100 kHz bandwidth outside the frequency band in which the spread spectrum intentional radiator is operating, the radio frequency power that is produced by the intentional radiator shall be at least 20 dB below that in the 100 kHz bandwidth within the band that contains the highest level of the desired power, based on either an RF conducted or a radiated measurement. Attenuation below the general limits specified in Section 15.209(a) is not required. In addition, radiated emissions which fall in the restricted bands, as defined in Section 15.205(a), must also comply with the radiated emission limits specified in Section 15.209(a) (see Section 15.205(c)).

OPERATING FREQUENCY RANGE (MHz)	SPURIOUS EMISSION FREQUENCY (MHz)	LIMIT	
		Peak power ration to emission(dBc)	Emission level(dBuV/m)
902-928	<902	>20	NA
	>928	>20	NA
	960-1240	NA	54
2400-2483.5	<2400	>20	NA
	>2483.5-2500	NA	54
5725-5850	<5350-5460	NA	54
	<5725	>20	NA
	>5850	>20	NA



Spectrum Research & Testing Lab., Inc.
No. 101-10, Ling 8,
Shan-Tong Li, Chung-Li
City, Taoyuan, Taiwan

TEST REPORT

Reference No.: A06082902
Report No.: FCCA06082902
FCCID: UKT95025-MF001
Page:20 of 44
Date: Sep. 11, 2006

4.3.2 TEST EQUIPMENT

The following test equipment was used during the test :

EQUIPMENT/ FACILITIES	SPECIFICATIONS	MANUFACTURER	MODEL#/ SERIAL#	DUE DATE OF CAL. & CAL. CENTER
SPECTRUM	9kHz-7GHz	ROHDE & SCHWARZ	FSP7/ 839511/010	APR. 2007 R&S
EMI TEST RECEIVER	9 kHz TO 2750 MHz	ROHDE & SCHWARZ	ESCS30/ 830245/012	AUG. 2007 R&S
SPECTRUM	9KHz-26.5GHz	HP	8593E/ 3710A03220	MAY 2007 ETC
PRE-AMPLIFIER	1GHz-26.5GHz Gain:30dB	HP	8449B/ 3008A01019	NOV. 2006 ETC
BI-LOG ANTENNA	25 MHz TO 2 GHz	EMCO	3142/ 9701-1124	FEB. 2007 SRT
HORN ANTENNA	1GHz to 18GHz	EMCO	3115/ 9602-4681	DEC. 2006 ETC
OATS	3 - 10 M measurement	SRT	SRT-1	APR. 2007 SRT

NOTE: The calibration interval of the above test equipment is one year and the calibrations are traceable to NML/ROC and NIST/USA.



4.3.3 TEST SET-UP

FOR RADIATED EMISSION TEST

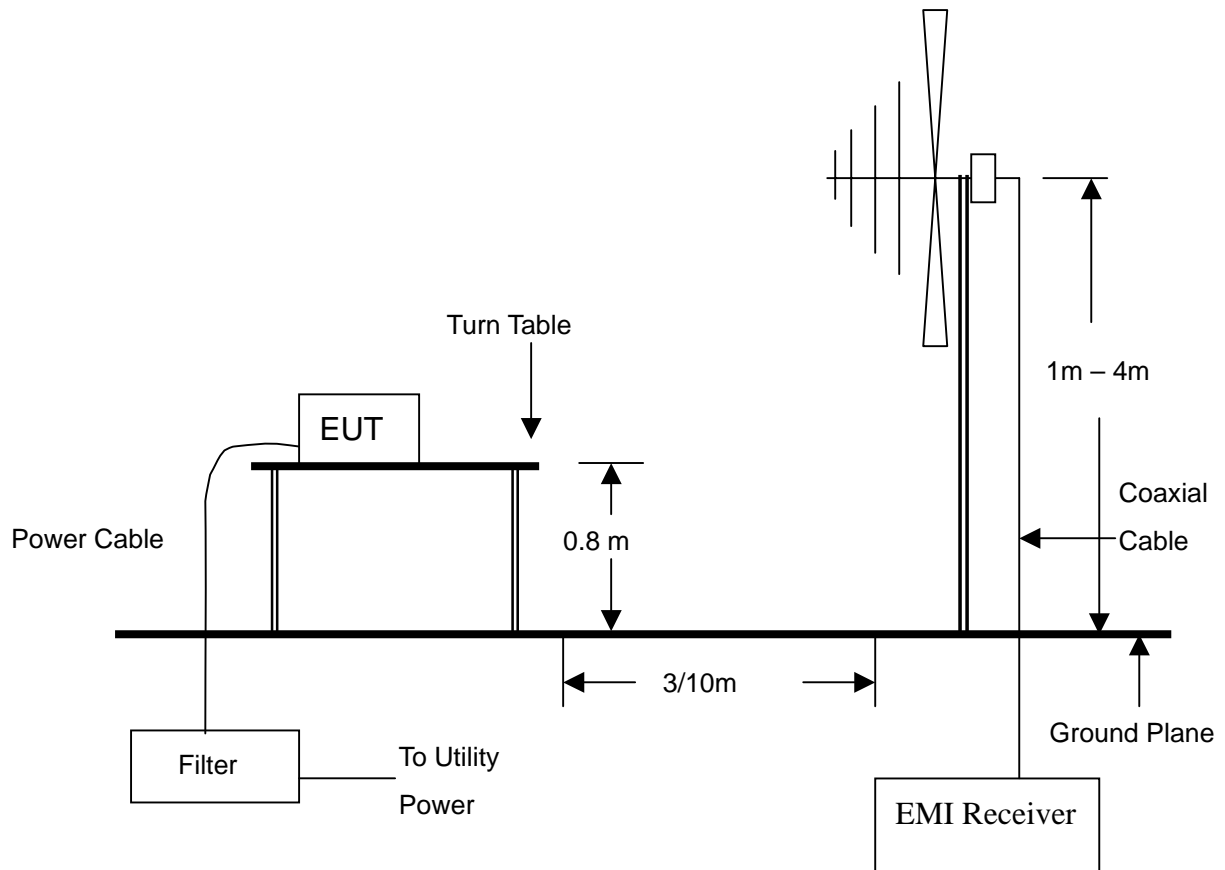

NOTE :

1. The EUT system was put on a wooden table with 0.8m heights above a ground plane.
2. For the actual test configuration, please refer to the photos of testing.



4.3.4 TEST PROCEDURE

1. The EUT was operating in hopping mode or could be controlled its channel.
Printed out the test result from the spectrum by hard copy function.
2. The EUT was tested according to the requirement of ANSI C63.4 and CISPR 22.
The measurements were made at an open area test site with 10 meter measurement distance under 1 GHz and with 3m distance above 1GHz. The frequency spectrum measured started from 30 MHz. Under 1 GHz. All readings were quasi-peak values with 120 kHz resolution bandwidth of the test receiver. Above 1 GHz, the measurements were made at an open area test site with 3 meter measurement distance and all readings were peak and average values with 1 MHz resolution bandwidth of the test receiver. The EUT system was operated in all typical methods by users. The cables connected to EUT and support units were moved to find the maximum emission levels for each frequency.

4.3.5 EUT OPERATING CONDITION

Same as section 4.1.5 of this report.

4.3.6 TEST RESULT

Temperature:	<u>20°C</u>	Humidity:	<u>56%RH</u>
Spectrum Detector:	<u>PK & AV</u>	Tested by:	<u>Mao Feng Hsu</u>
Test Result:	<u>PASS</u>	Tested Date:	<u>Sep. 11, 2006</u>

Radiated emission test-TX

Frequency (MHz)	Antenna polarization (H/V)	Reading (dBuV)		Emission (dBuV/m)		Band edge Limit (dBuV/m)	
		PK	AV	PK	AV	PK	AV
<2400	H	47.4	37.4	43.2	33.3	74.0	54.0
>2483.5	V	48.6	37.3	44.6	33.3	74.0	54.0



Spectrum Research & Testing Lab., Inc.
No. 101-10, Ling 8,
Shan-Tong Li, Chung-Li
City, Taoyuan, Taiwan

TEST REPORT

Reference No.: A06082902
Report No.: FCCA06082902
FCCID: UKT95025-MF001
Page:23 of 44
Date: Sep. 11, 2006

TX
<2400MHz:

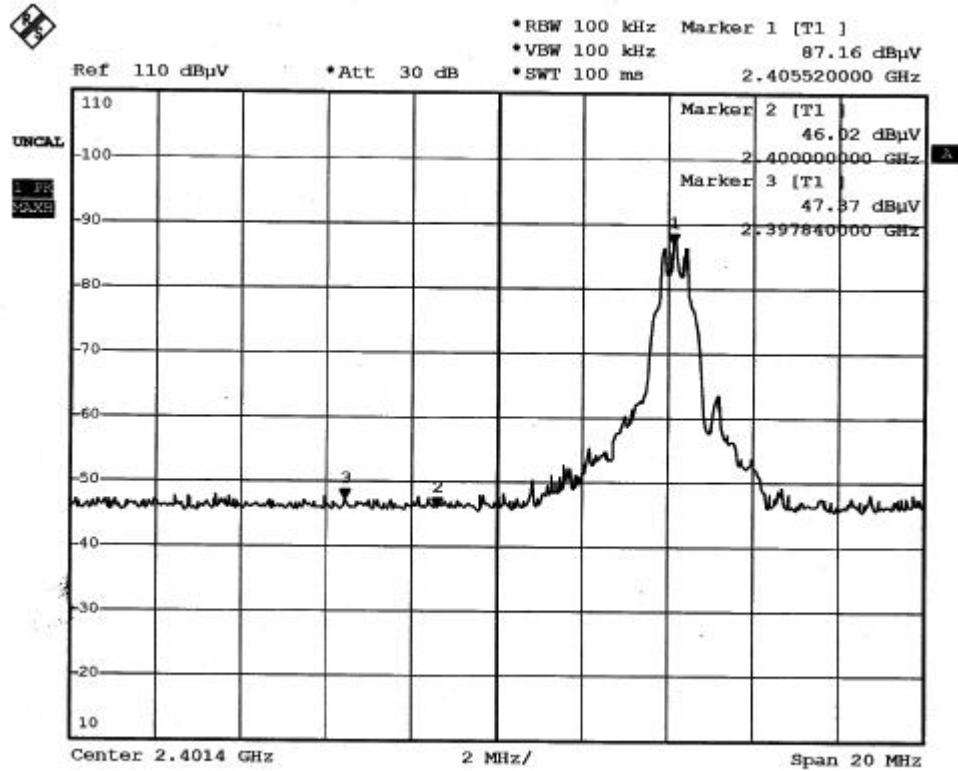



Spectrum Research & Testing Lab., Inc.
No. 101-10, Ling 8,
Shan-Tong Li, Chung-Li
City, Taoyuan, Taiwan

TEST REPORT

Reference No.: A06082902
Report No.: FCCA06082902
FCCID: UKT95025-MF001
Page:24 of 44
Date: Sep. 11, 2006

>2483.5MHz

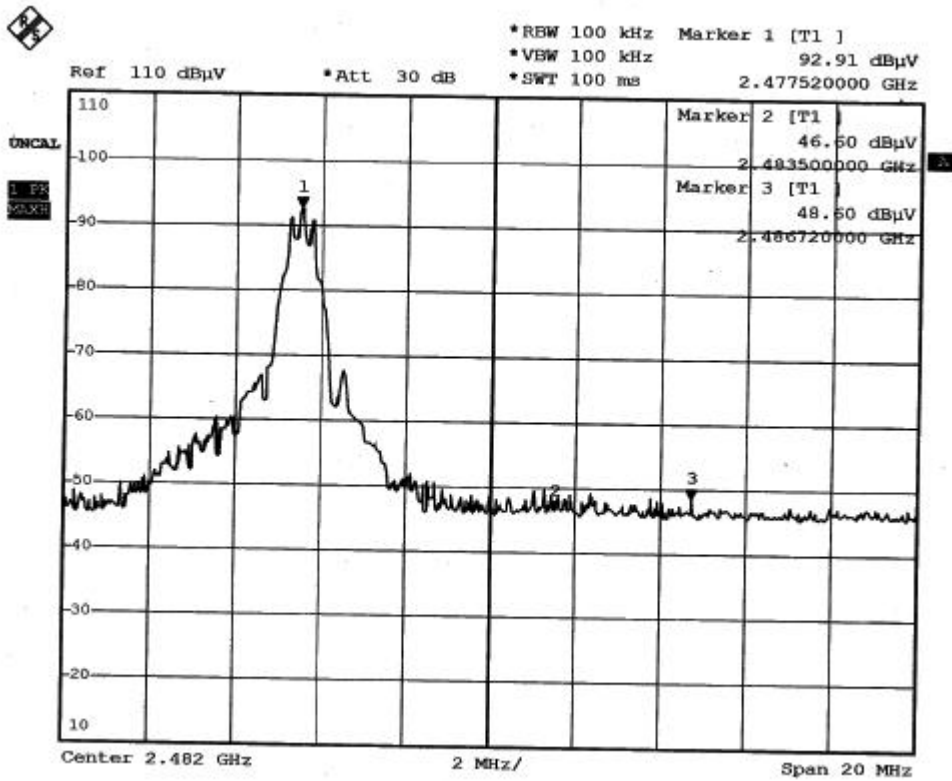



4.4 SPURIOUS RADIATED EMISSION TEST

4.4.1 LIMIT

FCC Part15, Subpart C Section 15.209 limit of radiated emission for frequency below1000MHz. The emissions from an intentional radiator shall not exceed the field strength levels specified in the following table:

FREQUENCY (MHz)	DISTANCE (m)	FIELD STRENGTH (dB μ V/m)
30 - 88	3	40.0
88 - 216	3	43.5
216 - 960	3	46.0
ABOVE 960	3	54.0

- NOTE** :
1. In the emission tables above , the tighter limit applies at the band edges.
 2. Distance refers to the distance between measuring instrument , antenna , and the closest point of any part of the device or system.

FCC Part 15, Section15.35(b) limit of radiated emission for frequency above 1000 MHz

FREQUENCY (MHz)	Class A (dBuV/m) (at 3m)		Class B (dBuV/m) (at 3m)	
	PEAK	AVERAGE	PEAK	AVERAGE
Above 1000	80.0	60.0	74.0	54.0

FCC Part 15, Subpart C Section 15.249. The field strength of emissions from intentional radiators operated within these frequency bands shall comply with the following:

FUNDAMENTAL FREQUENCY (MHz)	FIELD STRENGTH OF FUNDAMENTAL (dBuV/m) (at 3m)		FIELD STRENGTH OF HARMONICS (dBuV/m) (at 3m)	
	PEAK	AVERAGE	PEAK	AVERAGE
902-928	114	94	74.0	54.0
2400-2483.5	114	94	74.0	54.0
5725-5875	114	94	74.0	54.0
24000-24250	128	108	88.0	68.0



4.4.2 TEST EQUIPMENT

The following test equipment was used during the radiated emission test :

EQUIPMENT/ FACILITIES	SPECIFICATIONS	MANUFACTURER	MODEL#/ SERIAL#	DUE DATE OF CAL. & CAL. CENTER
EMI TEST RECEIVER	20 kHz TO 1 GHz	ROHDE & SCHWARZ	ESCS30/ 830245/012	OCT. 2006 ETC
SPECTRUM ANALYZER	9KHz TO 26.5GHz	HP	8593E/ 3710A03220	MAY 10,2007 ETC
HORN ANTENNA	18GHz TO 40GHz	ETS	3116/00028513	OCT 05,2006 DBN
HORN ANTENNA	1GHz TO 18GHz	EMCO	3115/9012-3619	JAN. 09,2007 ETC
PREAMPLIFIER	1GHz TO 26.5GHz	HP	8449B/ 3008A01019	NOV. 15,2006 ETC
BI-LOG ANTENNA	25 MHz TO 2 GHz	EMCO	3143/ 9509-1141	SEP. 2006 SRT
OATS	3 – 10 M MEASUREMENT	SRT	SRT-1	DEC. 2006 SRT
COAXIAL CABLE	25M	SUNCITY	J400/ 25M	AUG. 2007 SRT
FILTER	2 LINE, 30A	FIL.COIL	FC-943/ 869	N/A
FREQUENCY CONVERTER	N/A	APC	AFC-2KBB/ F100030031	AUG. 2007 SRT

NOTE:

1. The calibration interval of the above test equipment is one year and the calibrations are traceable to NML/ROC and NIST/USA.
2. The Open Area Test Site (SRT-1) is registered by FCC with No. 90957 and VCCI with No. R-1081.
3. The Open Area Test Site (SRT-2) is registered by FCC with No. 98458 and VCCI with No. R-1168.



4.4.3 TEST SET-UP

(30-1000MHz)

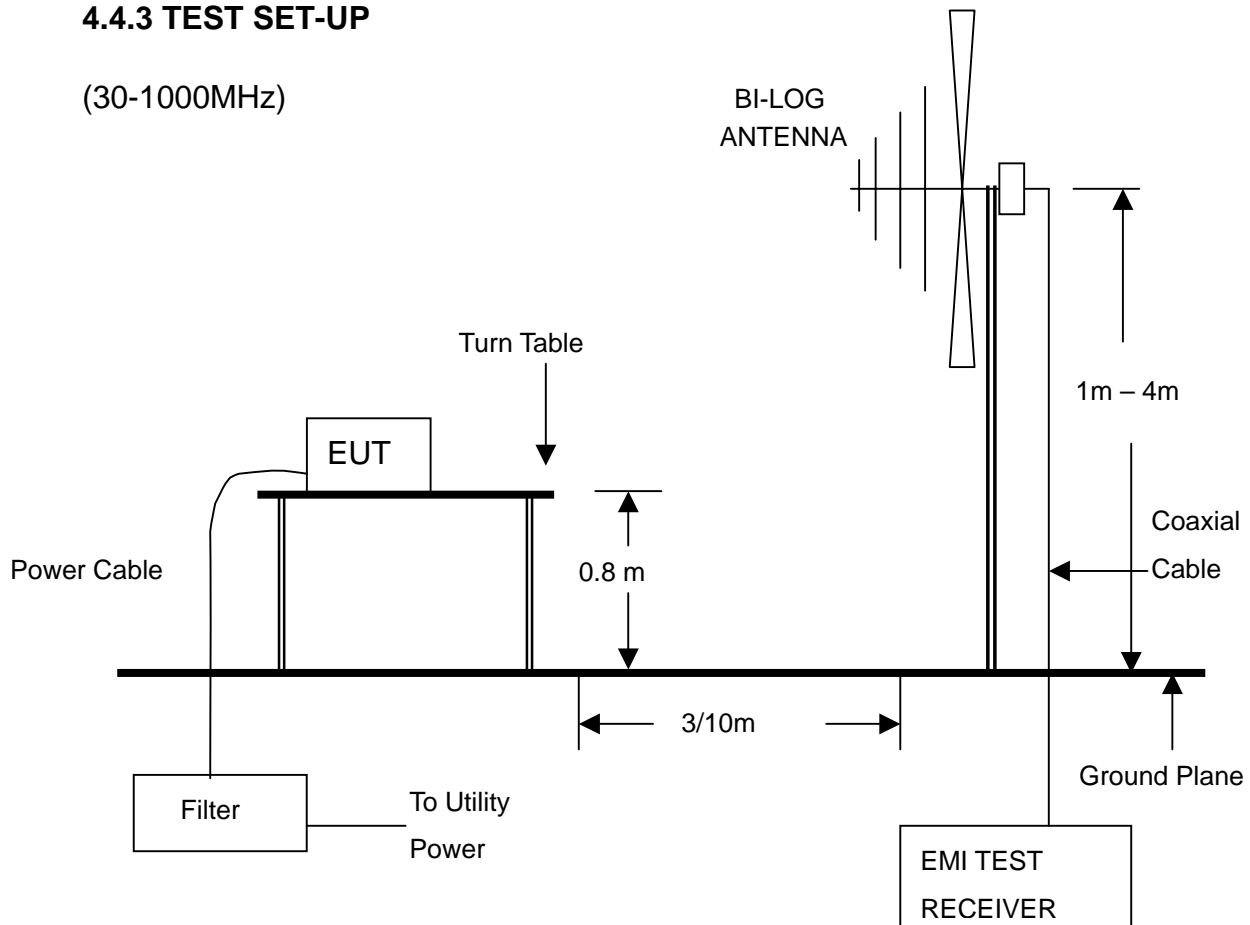

NOTE :

1. The EUT system was put on a wooden table with 0.8m heights above a ground plane.
2. For the actual test configuration, please refer to the photos of testing.



(1-25GHz)

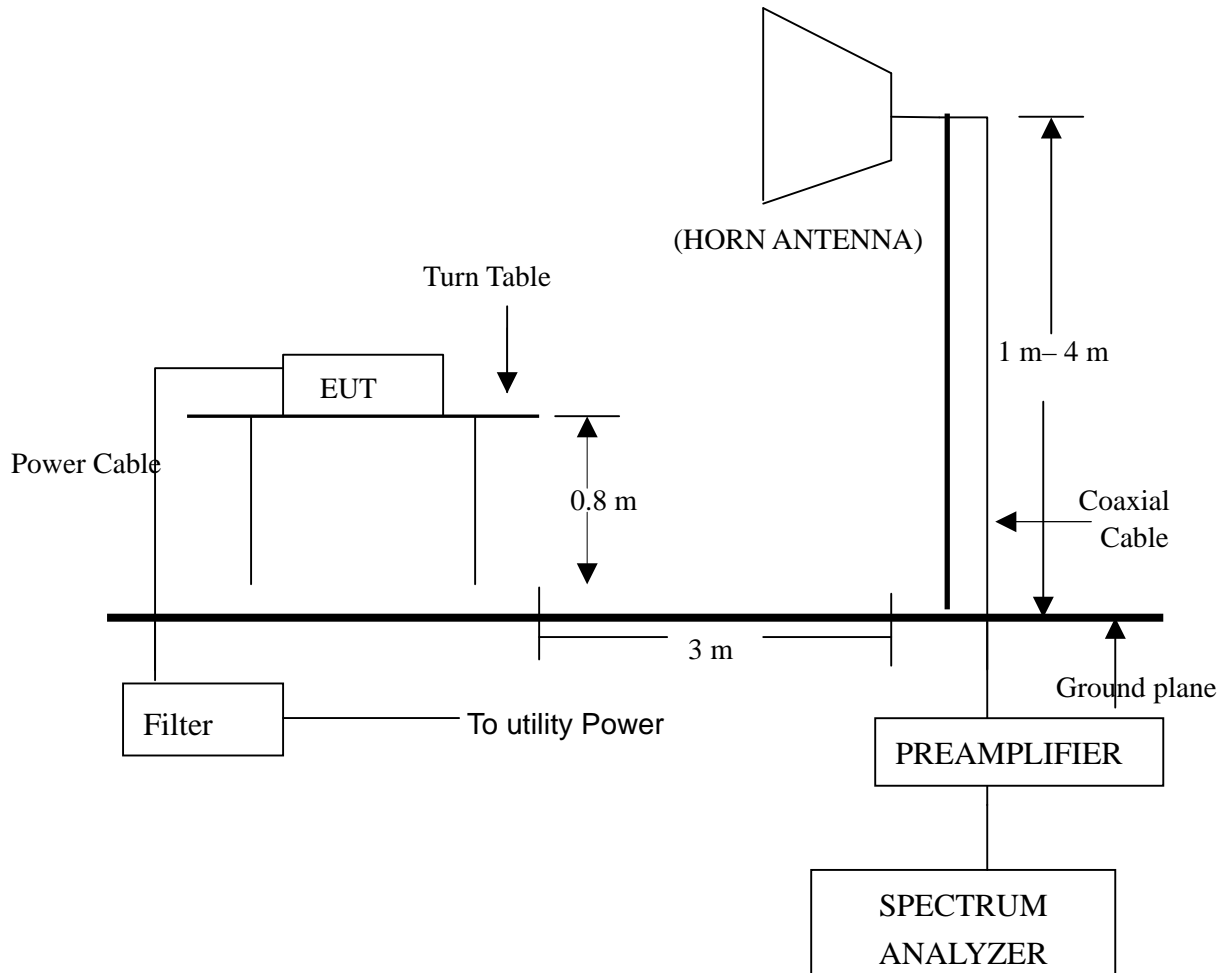

NOTE :

1. The EUT system was put on a wooden table with 0.8m heights above a ground plane.
2. For the actual test configuration, please refer to the photos of testing.



**Spectrum Research &
Testing Lab., Inc.**
No. 101-10, Ling 8,
Shan-Tong Li, Chung-Li
City, Taoyuan, Taiwan

TEST REPORT

Reference No.: A06082902
Report No.: FCCA06082902
FCCID: UKT95025-MF001
Page:29 of 44
Date: Sep. 11, 2006

4.4.4 TEST PROCEDURE

The EUT was tested according to the requirement of ANSI C63.4 and CISPR 22. The measurements were made at an open area test site with 10 meters measurement distance under 1 GHz and with 3m distance above 1GHz. The frequency spectrum measured started from 30 MHz. Under 1 GHz. All readings were quasi-peak values with 120 kHz resolution bandwidth of the test receiver. Above 1 GHz, the measurements were made at an open area test site with 3 meter measurement distance and all readings were peak and average values with 1 MHz resolution bandwidth of the test receiver. The EUT system was operated in all typical methods by users. The cables connected to EUT and support units were moved to find the maximum emission levels for each frequency.

4.4.5 EUT OPERATING CONDITION

Same as section 4.1.5 of this report.



4.4.6 TEST RESULT

Temperature:	31°C	Humidity:	70 %RH
Frequency Range:	30 – 1000 MHz	Measured Distance:	3m
Receiver Detector:	Q.P.	Tested Mode:	Link
Tested By:	Mao Feng Hsu	Tested Date:	Sep. 01, 2006

Antenna Polarization: Horizontal

Frequency (MHz)	Cable Loss (dB)	Antenna Factor (dB/m)	Reading Data (dBμV)	Emission Level (dBμV/m)	Limit (dBμV/m)	Margin (dB)	AZ(°)	EL(m)
313.3400	2.59	14.37	19.0	36.0	46.0	-10.0	5	1.1
350.2000	3.29	15.15	7.8	26.2	46.0	-19.8	20	2.1
393.2000	3.14	16.05	15.4	34.6	46.0	-11.4	357	2.0
589.8100	3.71	19.01	14.8	37.5	46.0	-8.5	10	2.1
600.0600	3.72	19.20	7.6	30.5	46.0	-15.5	50	1.2
840.0870	4.69	22.52	7.6	34.8	46.0	-11.2	350	1.3

Antenna Polarization: Vertical

Frequency (MHz)	Cable Loss (dB)	Antenna Factor (dB/m)	Reading Data (dBμV)	Emission Level (dBμV/m)	Limit (dBμV/m)	Margin (dB)	AZ(°)	EL(m)
40.2750	0.95	9.50	13.3	23.8	40.0	-16.3	2	1.0
54.5250	0.99	4.98	19.5	25.5	40.0	-14.5	350	1.8
313.2400	2.59	14.37	14.3	31.3	46.0	-14.7	15	1.2
393.2120	3.14	16.05	16.0	35.2	46.0	-10.8	20	1.1
637.8625	4.50	19.94	10.0	34.4	46.0	-11.6	10	1.3
786.4125	4.94	21.37	8.8	35.1	46.0	-10.9	0	1.6

NOTE :

1. Measurement uncertainty is +/-2dB.
2. "*": Measurement does not apply for this frequency.
3. Emission Level = Reading Value + Ant. Factor + Cable Loss.
4. The field strength of other emission frequencies were very low against the limit.



Spectrum Research & Testing Lab., Inc.
No. 101-10, Ling 8,
Shan-Tong Li, Chung-Li
City, Taoyuan, Taiwan

TEST REPORT

Reference No.: A06082902
Report No.: FCCA06082902
FCCID: UKT95025-MF001
Page:31 of 44
Date: Sep. 11, 2006

Temperature:	<u>30 °C</u>	Humidity:	<u>70 %RH</u>
Frequency Range:	<u>1 – 25 GHz</u>	Test mode:	<u>TX:CH0</u>
Receiver Detector:	<u>PK. or AV.</u>	Measured Distance:	<u>3m</u>
Tested by:	<u>Mao Feng Hsu</u>	Tested Date:	<u>Sep. 01, 2006</u>

Antenna Polarization: Horizontal

Frequency (MHz)	Cable Loss (dB)	Antenna Factor (dB/m)	Reading Data (dBμV)		Emission Level (dBμV/m)		Limit (dBμV/m)		Margin (dB)		AZ(°)	EL(m)
			PK.	AV.	PK.	AV.	PK.	AV.	PK.	AV.		
2406.00	-32.17	28.55	88.6	86.1	85.0	82.5	N/A	N/A	N/A	N/A	215	1.2
4812.00	-30.45	33.65	49.4	39.9	52.6	43.1	74.0	54.0	-21.4	-10.9	14	2.6
7218.00	-28.93	36.27	54.5	41.6	61.9	48.9	74.0	54.0	-12.1	-5.1	75	18
2325.00	-32.35	27.85	55.8	*	51.3	*	74.0	54.0	-22.7	*	36	2
2476.00	-32.20	28.15	49.8	*	45.7	*	74.0	54.0	-28.3	*	275	2
4825.00	-30.41	33.66	51.8	39.8	55.0	43.0	74.0	54.0	-19.0	-11.0	45	2.6
9624.00	*	*	*	*	*	*	*	*	*	*	*	*
12030.00	*	*	*	*	*	*	*	*	*	*	*	*
14436.00	*	*	*	*	*	*	*	*	*	*	*	*
16842.00	*	*	*	*	*	*	*	*	*	*	*	*
19248.00	*	*	*	*	*	*	*	*	*	*	*	*
21654.00	*	*	*	*	*	*	*	*	*	*	*	*
24060.00	*	*	*	*	*	*	*	*	*	*	*	*

NOTE :

1. Measurement uncertainty is +/-2dB.
2. "*": Measurement does not apply for this frequency.
3. Emission Level = Reading Value + Ant. Factor + Cable Loss.
4. Margin=Emission-Limit
5. The field strength of other emission frequencies (Above 8GHz)were very low against the limit.



Spectrum Research & Testing Lab., Inc.
 No. 101-10, Ling 8,
 Shan-Tong Li, Chung-Li
 City, Taoyuan, Taiwan

TEST REPORT

Reference No.: A06082902
 Report No.: FCCA06082902
 FCCID: UKT95025-MF001
 Page:32 of 44
 Date: Sep. 11, 2006

Temperature:	<u>30 °C</u>	Humidity:	<u>70 %RH</u>
Frequency Range:	<u>1 – 25 GHz</u>	Test mode:	<u>TX:CH0</u>
Receiver Detector:	<u>PK. or AV.</u>	Measured Distance:	<u>3m</u>
Tested by:	<u>Mao Feng Hsu</u>	Tested Date:	<u>Sep. 01, 2006</u>

Antenna Polarization: Vertical

Frequency (MHz)	Cable Loss (dB)	Antenna Factor (dB/m)	Reading Data (dB μ V)		Emission Level (dB μ V/m)		Limit (dB μ V/m)		Margin (dB)		AZ(°)	EL(m)
			PK.	AV.	PK.	AV.	PK.	AV.	PK.	AV.		
2406.00	-32.17	28.01	88.1	85.9	83.9	81.7	N/A	N/A	N/A	N/A	135	1
4813.00	-30.44	33.65	50.4	39.3	53.6	42.5	74.0	54.0	-20.4	-11.5	47	2.9
7218.00	-28.93	36.27	54.4	41.3	61.7	48.6	74.0	54.0	-12.3	-5.4	98	1.6
2325.00	-32.35	27.85	50.8	*	46.3	*	74.0	54.0	-27.7	*	35	1.3
2478.00	-32.20	28.16	49.5	*	45.4	*	74.0	54.0	-28.6	*	69	2.6
4793.00	-30.47	33.63	49.5	40.0	52.6	43.2	74.0	54.0	-21.4	-10.8	72	1.5
9624.00	*	*	*	*	*	*	*	*	*	*	*	*
12030.00	*	*	*	*	*	*	*	*	*	*	*	*
14436.00	*	*	*	*	*	*	*	*	*	*	*	*
16842.00	*	*	*	*	*	*	*	*	*	*	*	*
19248.00	*	*	*	*	*	*	*	*	*	*	*	*
21654.00	*	*	*	*	*	*	*	*	*	*	*	*
24060.00	*	*	*	*	*	*	*	*	*	*	*	*

NOTE :

1. Measurement uncertainty is +/-2dB.
2. "*": Measurement does not apply for this frequency.
3. Emission Level = Reading Value + Ant. Factor + Cable Loss.
4. Margin=Emission-Limit
5. The field strength of other emission frequencies (Above 8GHz)were very low against the limit.



Spectrum Research & Testing Lab., Inc.
 No. 101-10, Ling 8,
 Shan-Tong Li, Chung-Li
 City, Taoyuan, Taiwan

TEST REPORT

Reference No.: A06082902
 Report No.: FCCA06082902
 FCCID: UKT95025-MF001
 Page:33 of 44
 Date: Sep. 11, 2006

Temperature:	<u>30°C</u>	Humidity:	<u>70 %RH</u>
Frequency Range:	<u>1 – 25 GHz</u>	Test mode:	<u>TX:CH17</u>
Receiver Detector:	<u>PK. or AV.</u>	Measured Distance:	<u>3m</u>
Tested by:	<u>Mao Feng Hsu</u>	Tested Date:	<u>Sep. 01, 2006</u>

Antenna Polarization: Horizontal

Frequency (MHz)	Cable Loss (dB)	Antenna Factor (dB/m)	Reading Data (dBµV)		Emission Level (dBµV/m)		Limit (dBµV/m)		Margin (dB)		AZ(°)	EL(m)
			PK.	AV.	PK.	AV.	PK.	AV.	PK.	AV.		
2440.00	-32.22	28.62	92.9	89.1	89.3	85.5	N/A	N/A	N/A	N/A	25	1.5
4876.00	-30.28	33.70	50.8	39.3	54.3	42.7	74.0	54.0	-19.7	-11.3	201	2
7320.00	-29.05	36.36	54.1	40.7	61.4	48.0	74.0	54.0	-12.6	-6.0	86	1.1
2376.00	-32.25	27.95	50.1	*	45.8	*	74.0	54.0	-28.2	*	41	1.4
2467.00	-32.21	28.13	51.7	*	47.6	*	74.0	54.0	-26.4	*	69	2.1
4899.00	-30.22	33.72	50.5	39.5	54.0	43.0	74.0	54.0	-20.0	-11.0	25	1.6
9760.00	*	*	*	*	*	*	*	*	*	*	*	*
12200.00	*	*	*	*	*	*	*	*	*	*	*	*
14640.00	*	*	*	*	*	*	*	*	*	*	*	*
17080.00	*	*	*	*	*	*	*	*	*	*	*	*
19520.00	*	*	*	*	*	*	*	*	*	*	*	*
21960.00	*	*	*	*	*	*	*	*	*	*	*	*
24400.00	*	*	*	*	*	*	*	*	*	*	*	*

NOTE :

1. Measurement uncertainty is +/-2dB.
2. "*": Measurement does not apply for this frequency.
3. Emission Level = Reading Value + Ant. Factor + Cable Loss.
4. Margin=Emission-Limit
5. The field strength of other emission frequencies (Above 8GHz)were very low against the limit.



Spectrum Research & Testing Lab., Inc.
 No. 101-10, Ling 8,
 Shan-Tong Li, Chung-Li
 City, Taoyuan, Taiwan

TEST REPORT

Reference No.: A06082902
 Report No.: FCCA06082902
 FCCID: UKT95025-MF001
 Page:34 of 44
 Date: Sep. 11, 2006

Temperature:	30°C	Humidity:	70 %RH
Frequency Range:	1 – 25 GHz	Test mode:	TX:CH17
Receiver Detector:	PK. or AV.	Measured Distance:	3m
Tested by:	Mao Feng Hsu	Tested Date:	Sep. 01, 2006

Antenna Polarization: Vertical

Frequency (MHz)	Cable Loss (dB)	Antenna Factor (dB/m)	Reading Data (dBμV)		Emission Level (dBμV/m)		Limit (dBμV/m)		Margin (dB)		AZ(°)	EL(m)
			PK.	AV.	PK.	AV.	PK.	AV.	PK.	AV.		
2440.00	-32.22	28.08	89.1	86.9	84.9	82.8	N/A	N/A	N/A	N/A	104	2.1
4879.00	-30.27	33.70	48.8	39.2	52.2	42.6	74.0	54.0	-21.8	-11.4	69	1.1
7321.00	-29.04	36.36	54.0	40.5	61.3	47.8	74.0	54.0	-12.7	-6.2	98	3
2420.00	-32.19	28.04	50.0	*	45.9	*	74.0	54.0	-28.1	*	10	2.8
2460.00	-32.22	28.12	49.0	*	44.9	*	74.0	54.0	-29.1	*	87	1.5
4855.00	-30.33	33.68	50.7	40.2	54.0	43.6	74.0	54.0	-20.0	-10.4	60	2.5
9760.00	*	*	*	*	*	*	*	*	*	*	*	*
12200.00	*	*	*	*	*	*	*	*	*	*	*	*
14640.00	*	*	*	*	*	*	*	*	*	*	*	*
17080.00	*	*	*	*	*	*	*	*	*	*	*	*
19520.00	*	*	*	*	*	*	*	*	*	*	*	*
21960.00	*	*	*	*	*	*	*	*	*	*	*	*
24400.00	*	*	*	*	*	*	*	*	*	*	*	*

NOTE :

1. Measurement uncertainty is +/-2dB.
2. "*": Measurement does not apply for this frequency.
3. Emission Level = Reading Value + Ant. Factor + Cable Loss.
4. Margin=Emission-Limit
5. The field strength of other emission frequencies (Above 8GHz)were very low against the limit.



Spectrum Research & Testing Lab., Inc.
 No. 101-10, Ling 8,
 Shan-Tong Li, Chung-Li
 City, Taoyuan, Taiwan

TEST REPORT

Reference No.: A06082902
 Report No.: FCCA06082902
 FCCID: UKT95025-MF001
 Page:35 of 44
 Date: Sep. 11, 2006

Temperature:	<u>30°C</u>	Humidity:	<u>70 %RH</u>
Frequency Range:	<u>1 – 25 GHz</u>	Test mode:	<u>TX:CH31</u>
Receiver Detector:	<u>PK. or AV.</u>	Measured Distance:	<u>3m</u>
Tested by:	<u>Mao Feng Hsu</u>	Tested Date:	<u>Sep. 01, 2006</u>

Antenna Polarization: Horizontal

Frequency (MHz)	Cable Loss (dB)	Antenna Factor (dB/m)	Reading Data (dBμV)		Emission Level (dBμV/m)		Limit (dBμV/m)		Margin (dB)		AZ(°)	EL(m)
			PK.	AV.	PK.	AV.	PK.	AV.	PK.	AV.		
2478.00	-32.20	28.73	89.8	86.5	86.3	83.0	N/A	N/A	N/A	N/A	15	1.4
4962.00	-30.26	33.77	48.8	39.6	52.3	43.1	74.0	54.0	-21.7	-10.9	196	1.2
7441.00	-28.95	36.45	53.1	40.2	60.6	47.7	74.0	54.0	-13.4	-6.3	82	1.1
2438.00	-32.22	28.08	50.8	*	46.7	*	74.0	54.0	-27.3	*	65	1.3
2504.00	-32.13	28.22	51.2	*	47.3	*	74.0	54.0	-26.7	*	35	1.1
4804.00	-30.47	33.64	49.9	40.0	53.1	43.1	74.0	54.0	-20.9	-10.9	20	1.2
9912.00	*	*	*	*	*	*	*	*	*	*	*	*
12390.00	*	*	*	*	*	*	*	*	*	*	*	*
14868.00	*	*	*	*	*	*	*	*	*	*	*	*
17346.00	*	*	*	*	*	*	*	*	*	*	*	*
19824.00	*	*	*	*	*	*	*	*	*	*	*	*
22302.00	*	*	*	*	*	*	*	*	*	*	*	*
24780.00	*	*	*	*	*	*	*	*	*	*	*	*

NOTE :

1. Measurement uncertainty is +/-2dB.
2. "**": Measurement does not apply for this frequency.
3. Emission Level = Reading Value + Ant. Factor + Cable Loss.
4. Margin=Emission-Limit
5. The field strength of other emission frequencies (Above 8GHz)were very low against the limit.



Spectrum Research & Testing Lab., Inc.
 No. 101-10, Ling 8,
 Shan-Tong Li, Chung-Li
 City, Taoyuan, Taiwan

TEST REPORT

Reference No.: A06082902
 Report No.: FCCA06082902
 FCCID: UKT95025-MF001
 Page:36 of 44
 Date: Sep. 11, 2006

Temperature:	<u>30°C</u>	Humidity:	<u>70 %RH</u>
Frequency Range:	<u>1 – 25 GHz</u>	Test mode:	<u>TX:CH31</u>
Receiver Detector:	<u>PK. or AV.</u>	Measured Distance:	<u>3m</u>
Tested by:	<u>Mao Feng Hsu</u>	Tested Date:	<u>Sep. 01, 2006</u>

Antenna Polarization: Vertical

Frequency (MHz)	Cable Loss (dB)	Antenna Factor (dB/m)	Reading Data (dBμV)		Emission Level (dBμV/m)		Limit (dBμV/m)		Margin (dB)		AZ(°)	EL(m)
			PK.	AV.	PK.	AV.	PK.	AV.	PK.	AV.		
2478.00	-32.20	28.16	85.1	83.6	81.1	79.6	N/A	N/A	N/A	N/A	112	1.4
4962.00	-30.26	33.77	47.8	*	51.3	*	74.0	54.0	-22.7	*	85	1.3
7441.00	-28.95	36.45	54.5	40.1	62.0	47.6	74.0	54.0	-12.0	-6.4	55	1.2
2419.00	-32.19	28.04	51.4	*	47.2	*	74.0	54.0	-26.8	*	15	1.3
2655.00	-32.06	29.07	50.0	*	47.0	*	74.0	54.0	-27.0	*	10	1.2
4881.00	-30.27	33.70	49.7	39.9	53.1	43.3	74.0	54.0	-20.9	-10.7	75	1.4
9912.00	*	*	*	*	*	*	*	*	*	*	*	*
12390.00	*	*	*	*	*	*	*	*	*	*	*	*
14868.00	*	*	*	*	*	*	*	*	*	*	*	*
17346.00	*	*	*	*	*	*	*	*	*	*	*	*
19824.00	*	*	*	*	*	*	*	*	*	*	*	*
22302.00	*	*	*	*	*	*	*	*	*	*	*	*
24780.00	*	*	*	*	*	*	*	*	*	*	*	*

NOTE :

1. Measurement uncertainty is +/-2dB.
2. "**": Measurement does not apply for this frequency.
5. Emission Level = Reading Value + Ant. Factor + Cable Loss.
6. Margin=Emission-Limit
5. The field strength of other emission frequencies (Above 8GHz)were very low against the limit.



4.5 CONDUCTED EMISSION TEST FOR POWER PORT

4.5.1 CONDUCTED EMISSION LIMIT

FREQUENCY (MHz)	Class A (dB μ V)		Class B (dB μ V)	
	Quasi-peak	Average	Quasi-peak	Average
0.15 - 0.5	79	66	66 - 56	56 - 46
0.5 - 5.0	73	60	56	46
5.0 - 30.0	73	60	60	50

NOTE:

1. The lower limit shall apply at the transition frequencies.
2. The limit decreases in line with the logarithm of the frequency in the range of 0.15 to 0.50 MHz.

4.5.2 TEST EQUIPMENT

The following test equipment was used for the test:

EQUIPMENT/ FACILITIES	SPECIFICATIONS	MANUFACTURER	MODEL#/ SERIAL#	DUE DATE OF CAL. & CAL. CENTER
EMI TEST RECEIVER	9 kHz TO 30 MHz	ROHDE & SCHWARZ	ESHS30/ 826003/008	AUG. 2007 ETC
LISN (for EUT)	50 μ H, 50 ohm	SOLAR ELECTRONICS	8012-50-R-24-BNC / 924839	JUN. 2007 ETC
LISN (for Peripheral)	50 μ H, 50 ohm	SOLAR ELECTRONICS	9252-50-R-24-BNC / 951318	JUN. 2007 ETC
50 ohm TERMINATOR	50 ohm	HP	11593A/ 2	JUN. 2007 ETC
COAXIAL CABLE	3m	SUNCITY	J400/ 3M	JUL. 2007 SRT
ISOLATION TRANSFORMER	N/A	APC	AFC-11015/ F102040016	N/A
FILTER	2 LINE, 30A	FIL.COIL	FC-943/ 771	N/A
GROUND PLANE	2.3M (H) x 2.4M (W)	SRT	N/A	APR. 2007 SRT
GROUND PLANE	2.4M (H) x 2.4M (W)	SRT	N/A	APR. 2007 SRT

NOTE: The calibration interval of the above test equipment is one year and the calibrations are traceable to NML/ROC and NIST/USA.



4.5.3 TEST SETUP

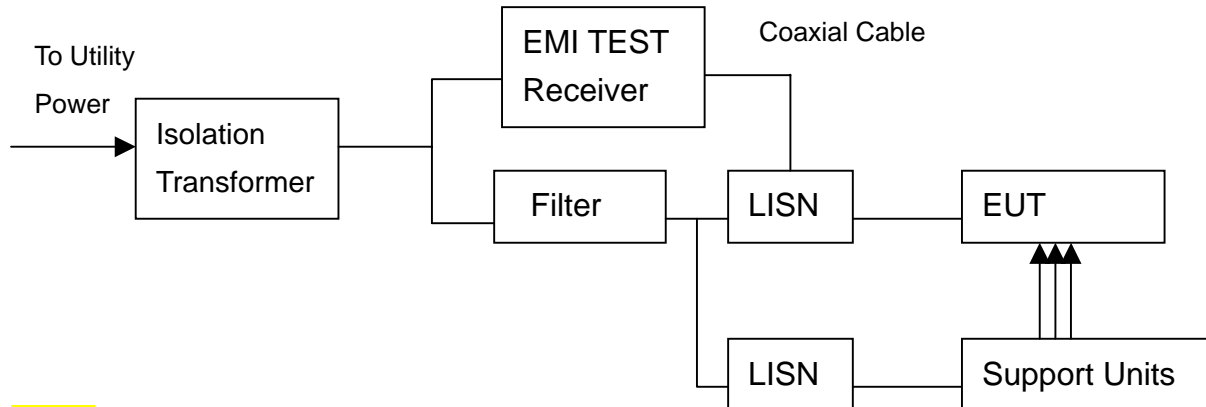

NOTE:

1. The EUT was put on a wooden table with 0.8m heights above ground plane, and 0.4m away from reference ground plane (> 2mx2m).
2. For the actual test configuration, please refer to the photos of testing.
3. The serial no. of the LISN connected to EUT is 01017.
4. The serial no. of the LISN connected to support units is 01018.

4.5.4 TEST PROCEDURE

The EUT was tested according to the requirement of ANSI C63.4:2003 and CISPR22:2003. The frequency spectrum from 0.15 MHz to 30 MHz was investigated. The LISN used was 50 ohm/50 μ H as specified. All readings were quasi-peak and average values with 10 kHz resolution bandwidth of the test receiver. The EUT system was operated in all typical methods by users. Both lines of the power mains of EUT were measured and the cables connected to EUT and support units were moved to find the maximum emission levels for each frequency.

First, find the margin or higher points at least 6 points by software, then use manual to find the maximum data. The procedure is referred on the test procedure of SRT LAB.



4.5.5 TEST RESULT

Temperature:	24 °C	Humidity:	68 %RH
Frequency Range:	0.15 – 30 MHz	Tested Mode:	Link
Receiver Detector:	Q.P. and AV.	Tested By:	Mao Feng Hsu
Tested Result:	Pass	Tested Date:	Aug. 31, 2006

Power Line Measured : Line

Freq. (MHz)	Correct. Factor (dB)	Reading Value (dB μ V)		Emission Level (dB μ V)		Limit (dB μ V)		Margin (dB)	
		Q.P.	AV.	Q.P.	AV.	Q.P.	AV.	Q.P.	AV.
0.189	0.30	49.86	35.97	50.16	36.27	64.06	54.06	-13.90	-17.79
0.198	0.30	48.58	31.79	48.88	32.09	63.68	53.68	-14.80	-21.59
0.572	0.24	38.70	27.15	38.94	27.39	56.00	46.00	-17.06	-18.61
4.695	0.21	31.52	28.64	31.73	28.85	56.00	46.00	-24.27	-17.15
4.883	0.22	32.58	30.81	32.80	31.03	56.00	46.00	-23.20	-14.97
5.832	0.22	31.60	28.85	31.82	29.07	60.00	50.00	-28.18	-20.93

Power Line Measured : Neutral

Freq. (MHz)	Correct. Factor (dB)	Reading Value (dB μ V)		Emission Level (dB μ V)		Limit (dB μ V)		Margin (dB)	
		Q.P.	AV.	Q.P.	AV.	Q.P.	AV.	Q.P.	AV.
0.186	0.30	48.60	34.58	48.90	34.88	64.20	54.20	-15.30	-19.32
0.189	0.30	50.14	38.17	50.44	38.47	64.06	54.06	-13.62	-15.59
0.577	0.24	35.88	18.70	36.12	18.94	56.00	46.00	-19.88	-27.06
3.487	0.19	32.96	31.44	33.15	31.63	56.00	46.00	-22.85	-14.37
3.804	0.20	33.02	31.64	33.22	31.84	56.00	46.00	-22.78	-14.16
7.994	0.23	31.86	26.98	32.09	27.21	60.00	50.00	-27.91	-22.79

NOTE :

1. Measurement uncertainty is +/-1.32dB
2. Emission level = Reading value + Correction factor
3. Correction Factor = Cable loss + Insertion loss of LISN
4. Margin value = Emission level - Limit
5. The emission of other frequencies were very low against the limit.
6. "-": The Quasi-peak reading value also meets average limit and measurement with the average detector is unnecessary.



**Spectrum Research &
Testing Lab., Inc.**
No. 101-10, Ling 8,
Shan-Tong Li, Chung-Li
City, Taoyuan, Taiwan

TEST REPORT

Reference No.: A06082902
Report No.: FCCA06082902
FCCID: UKT95025-MF001
Page:40 of 44
Date: Sep. 11, 2006

5. Antenna application

5.1 Antenna requirement

The EUT's antenna is met the requirement of FCC part15C section15.203 and 15.204.

FCC part15C section15.247 requirement:

Systems operating in the 2400-2483.5 MHz band that are used exclusively for fixed, point-to-point operations may employ transmitting antennas with directional gain greater than 6 dBi provided the maximum peak output power of the intentional radiator is reduced by 1 dB for every 3 dB that the directional gain of the antenna exceeds 6 dBi.

5.2 Result

The EUT's antenna used a dipole antenna and integrated on PCB. The antenna's gain is 2dBi and meets the requirement.



6. PHOTOS OF TESTING

- Radiated test –below 1GHz (LINK)





- Radiated test-Above 1GHz





- Conducted test (Link)





Spectrum Research & Testing Lab., Inc.
No. 101-10, Ling 8,
Shan-Tong Li, Chung-Li
City, Taoyuan, Taiwan

TEST REPORT

Reference No.: A06082902
Report No.: FCCA06082902
FCCID: UKT95025-MF001
Page:44 of 44
Date: Sep. 11, 2006

7. TERMS OF ABBREVIATION

AV.	Average detection
AZ(°)	Turn table azimuth
Correct.	Correction
EL(m)	Antenna height (meter)
EUT	Equipment Under Test
Horiz.	Horizontal direction
LISN	Line Impedance Stabilization Network
NSA	Normalized Site Attenuation
Q.P.	Quasi-peak detection
SRT Lab	Spectrum Research & Testing Laboratory, Inc.
Vert.	Vertical direction