

ISED CABid: ES1909

Test Report No:

Lab. Company Number: 4621A

NIE: 73050RRF.005

## Test Report

USA FCC Part 15.225, 15.209

CANADA RSS-210, RSS-Gen

(*) Identification of item tested	Modular XS Reader
(*) Trademark	SALTO
(*) Model and/or type reference	WRM0M (Type reference: P0506)
Other identification of the product	Contains FCC ID: 2AAQS-ISP1807 Contains IC: 11306A-ISP1807
(*) Features	Features: Contains a certified Bluetooth LE module HW version: 1.0 SW version: 0194 (Control FW)
Applicant	SALTO SYSTEMS, S.L. Arkotz 9, Polígono Lanbarren 20180, Oiartzun, Gipuzkoa, SPAIN
Test method requested, standard	USA FCC Part 15.225 (10-1-21 Edition): Operation within the band 13.110 -14.010. USA FCC Part 15.209 (10-1-21 Edition): Radiated emission limits, general requirements. CANADA RSS-210 Issue 10 (December 2019). CANADA RSS-Gen Issue 5 (March 2019). ANSI C63.10-2013: American National Standard for Testing Unlicensed Wireless Devices.
Summary	IN COMPLIANCE
Approved by (name / position & signature)	Rafael López EMC Consumer & RF Lab. Manager
Date of issue	2023-01-12
Report template No	FDT08_24 (* "Data provided by the client")

# Index

Competences and guarantees .....	3
General conditions .....	3
Uncertainty .....	3
Data provided by the client .....	4
Usage of samples .....	4
Test sample description .....	5
Identification of the client .....	6
Testing period and place .....	6
Document history .....	6
Environmental conditions .....	6
Remarks and comments .....	7
Testing verdicts .....	8
Summary .....	8
Appendix A: Test results .....	9

## Competences and guarantees

---

DEKRA Testing and Certification S.A.U. is a testing laboratory accredited by the National Accreditation Body (ENAC -Entidad Nacional de Acreditación), to perform the tests indicated in the Certificate No. 51/LE 147.

DEKRA Testing and Certification is a FCC-recognized accredited testing laboratory with appropriate scope of accreditation that covers the performed tests in this report.

DEKRA Testing and Certification is an ISED-recognized accredited testing laboratory, CABid: ES1909, Company Number: 4621A, with the appropriate scope of accreditation that covers the performed tests in this report.

In order to assure the traceability to other national and international laboratories, DEKRA Testing and Certification has a calibration and maintenance program for its measurement equipment.

DEKRA Testing and Certification guarantees the reliability of the data presented in this report, which is the result of the measurements and the tests performed to the item under test on the date and under the conditions stated on the report and, it is based on the knowledge and technical facilities available at DEKRA Testing and Certification at the time of performance of the test.

DEKRA Testing and Certification is liable to the client for the maintenance of the confidentiality of all information related to the item under test and the results of the test.

The results presented in this Test Report apply only to the particular item under test established in this document.

**IMPORTANT:** No parts of this report may be reproduced or quoted out of context, in any form or by any means, except in full, without the previous written permission of DEKRA Testing and Certification.

## General conditions

---

1. This report is only referred to the item that has undergone the test.
2. This report does not constitute or imply on its own an approval of the product by the Certification Bodies or competent Authorities.
3. This document is only valid if complete; no partial reproduction can be made without previous written permission of DEKRA Testing and Certification.
4. This test report cannot be used partially or in full for publicity and/or promotional purposes without previous written permission of DEKRA Testing and Certification and the Accreditation Bodies.

## Uncertainty

---

Uncertainty (factor  $k=2$ ) was calculated according to the DEKRA Testing and Certification internal document PODT000.

The total uncertainty of the measurement system for the radiated emissions of EUT from 9 kHz to 30 MHz is:  
Measurement uncertainty  $\leq \pm 3.08$  dB (with factor  $k = 2$ ).

The total uncertainty of the measurement system for the radiated emissions of EUT from 30 MHz to 200 MHz is:  
Measurement uncertainty  $\leq \pm 5.35$  dB (with factor  $k = 2$ ).

The total uncertainty of the measurement system for the conducted testing of EUT is:  
Frequency Tolerance of the Carrier Signal: Measurement uncertainty  $\leq \pm 12.3$  kHz  
Occupied Bandwidth  $\leq \pm 1.70$  kHz  
Field strength of emissions within the band  $\leq \pm 3.44$  dB

## Data provided by the client

The following data has been provided by the client:

1. Information relating to the description of the sample ("Identification of the item tested", "Trademark", "Model and/or type reference tested").
2. The sample consists of a Modular XS Reader with RFID Mifare (ISO 14443A & ISO 15693 standard based), Bluetooth LE and RS-485 technology.

DEKRA Testing and Certification S.A.U. declines any responsibility with respect to the information provided by the client and that may affect the validity of results.

## Usage of samples

Samples undergoing test have been selected by: The client.

Id	Control Number	Description	Model	Serial N°	Date of Reception	Application
S/01	73050_2.1	Modular XS Reader	WRM0M	--	2022-08-26	Element Under Test
S/01	71412B_11.1	Control Unit	CU4200	--	2022-03-11	Auxiliary Element
S/01	71412B_14.1	Power Supply	6A-181WP12	--	2022-03-11	Auxiliary Element
S/01	71412B_16.1	USB-RS485-WE	--	--	2022-03-11	Auxiliary Element
S/02	73050_11.1	Modular XS Reader	WRM0M	--	2022-09-05	Element Under Test
S/02	71412B_9.1	Control Unit	CU4200	--	2022-03-11	Auxiliary Element
S/02	71412B_14.1	Power Supply	6A-181WP12	--	2022-03-11	Auxiliary Element
S/02	71412B_16.1	USB-RS485-WE	--	--	2022-03-11	Auxiliary Element

Notes referenced to samples during the project:

Id	Type
S/01	Sample used for radiated test
S/02	Sample used for conducted test

## Test sample description

Ports..... :	Port name and description	Cable				
		Specified max length [m]	Attached during test	Shielded	Coupled to patient <sup>(3)</sup>	
	--		[ ]	[ ]	[ ]	
Supplementary information to the ports..... :	--					
Rated power supply .....	Voltage and Frequency		Reference poles			
			L1	L2	L3	N
	[ ]	AC:	[ ]	[ ]	[ ]	[ ]
	[X]	DC: 12 Vdc from CU42xx				
Rated Power .....	-					
Clock frequencies .....	N/A					
Other parameters..... :	RS-485					
Software version .....	0194 (Control FW)					
Hardware version..... :	1.0					
Dimensions in cm (W x H x D)..... :	8.3 x 8.3 x 3.4 cm					
Mounting position..... :	[ ]	Table top equipment				
	[X]	Wall/Ceiling mounted equipment				
	[ ]	Floor standing equipment				
	[ ]	Hand-held equipment				
	[ ]	Other:				
Modules/parts .....	Module/parts of test item		Type	Manufacturer		
	Bluetooth LE certified module		BLE	INSIGHT		
Accessories (not part of the test item) .....	Description		Type	Manufacturer		
Documents as provided by the applicant..... :	Description		File name	Issue date		
	User manual					
	FW Explanation					

<sup>(3)</sup> Only for Medical Equipment

## Identification of the client

SALTO SYSTEMS, S.L.  
Arkotz 9, Polígono Lanbarren  
20180, Oiartzun, Gipuzkoa, SPAIN

## Testing period and place

<b>Test Location</b>	DEKRA Testing and Certification S.A.U.
<b>Date (start)</b>	2022-09-19
<b>Date (finish)</b>	2022-11-30

## Document history

Report number	Date	Description
73050RRF.005	2023-01-12	First release.

## Environmental conditions

In the control chamber, the following limits were not exceeded during the test:

<b>Temperature</b>	Min. = 15 °C Max. = 35 °C
<b>Relative humidity</b>	Min. = 20 % Max. = 75 %

In the semianechoic chamber, the following limits were not exceeded during the test.

<b>Temperature</b>	Min. = 15 °C Max. = 35 °C
<b>Relative humidity</b>	Min. = 20 % Max. = 75 %

In the chamber for conducted measurements, the following limits were not exceeded during the test:

<b>Temperature</b>	Min. = 15 °C Max. = 35 °C
<b>Relative humidity</b>	Min. = 20 % Max. = 75 %

## Remarks and comments

The tests have been performed by the technical personnel: Jose Manuel Jimenez and Francisco Javier Fernandez.

Used instrumentation:

Control No.	Equipment	Model	Manufacturer	Next Calibration
4825	SEMIANECHOIC ABSORBER LINED CHAMBER	FACT 3 200 STP	ETS LINDGREN	N/A
4826	SHIELDED ROOM	S101	ETS LINDGREN	N/A
0242	ACTIVE LOOP ANTENNA 9 KHZ-30 MHz	11966A	HEWLETT PACKARD	2024-08-18
4578	HYBRID BILOG ANTENNA 30MHz-6GHz	3142E	ETS LINDGREN	2023-04-30
6142	PRE-AMPLIFIER G>38dB 30MHz-6GHz	BLNA 0360-01N	BONN ELEKTRONIK	2023-06-16
6165	EMI TEST RECEIVER 9kHz-7GHz	ESR7	ROHDE AND SCHWARZ	2023-11-08
6092	DC POWER SUPPLY 30 V / 5 A	U8002A	KEYSIGHT TECHNOLOGIES	N/A
7758	DIGITAL MULTIMETER	175	FLUKE	2023-11-14
8002	TEMPERATURE CHAMBER	MK 56	BINDER	2023-03-22
6157	SIGNAL AND SPECTRUM ANALYZER 10Hz-40GHz	FSV40	ROHDE AND SCHWARZ	2023-10-11

## Testing verdicts

Fail	F
Inconclusive	I
Not applicable	N/A
Not measured	N/M
Pass	P

## Summary

FCC PART 15 PARAGRAPH / RSS-247		
Requirement – Test case	Verdict	Remark
FCC 15.225 (a) / RSS-210 B.6 (a)(i) Field strength of emissions within the band 13.553 MHz -13.567 MHz	P	--
FCC 15.225 (b) / RSS-210 B.6 (a)(ii) Field strength of emissions within the band 13.410 - 13.553 MHz and 13.567 – 13.710 MHz	P	--
FCC 15.225 (c) / RSS-210 B.6 (a)(iii) Field strength of emissions within the band 13.110 - 13.410 MHz and 13.710 – 14.010 MHz	P	--
FCC 15.225 (d) / RSS-210 B.6 (a)(iv) Field strength of emissions outside of the band 13.110 MHz -14.010 MHz	P	--
FCC 15.225 (e) / RSS-210 B.6 (b) Frequency tolerance of the carrier signal	P	--
<u>Supplementary information and remarks:</u> None.		



## Appendix A: Test results

## INDEX

TEST CONDITIONS .....	11
Occupied Bandwidth .....	14
FCC 15.225 (a) / RSS-210 B.6 (a). Field strength of emissions within the band 13.553 -13.567 MHz .....	15
FCC 15.225 (b) / RSS-210 B.6 (b). Field strength of emissions within the band 13.410 - 13.553 MHz and 13.567 - 13.710 MHz .....	17
FCC 15.225 (c) / RSS-210 B.6 (c). Field strength of emissions within the band 13.110 - 13.410 MHz and 13.710 - 14.010 MHz.....	21
FCC 15.225 (d) / RSS-210 B.6 (a)(iv) Field Strength of Emissions outside of the band 13.110 MHz - 14.010 MHz .....	25
FCC 15.225 (e) / RSS-210 B.6 (b) Frequency Tolerance of the Carrier Signal .....	30

## TEST CONDITIONS

(\*) Data provided by the Applicant.

### POWER SUPPLY (\*):

Vnominal:	12 Vdc
Vminimum:	10.2 Vdc
Vmaximum:	15.594 Vdc
Type of Power Supply:	External power supply (from CU42xx)

### ANTENNA (\*):

Type of Antenna:	Integral, PCB.
Maximum Declared Antenna Gain:	N/A

### TEST FREQUENCY (\*):

Nominal Operating Frequency: 13.56 MHz

### CONDUCTED MEASUREMENTS:

The equipment under test was set up in a shielded room and it is directly connected to the spectrum analyzer.

For frequency stability test the EUT was placed inside a climatic chamber and connected to a frequency meter using a low loss cable. An external DC power supply was connected to the EUT for voltage variation test.

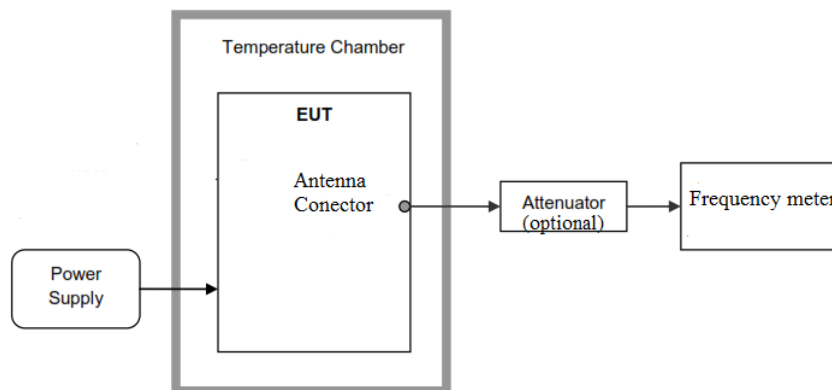

**RADIATED MEASUREMENTS:**

All radiated tests were performed in a semi-anechoic chamber. The measurement antenna (Loop antenna for the range between 9 kHz to 30 MHz and Bilog antenna for the range between 30 MHz to 200 MHz) is situated at a distance of 3 m.

For radiated emissions in the range 9 kHz to 30 MHz that is performed at a distance closer than the specified distance, an inverse proportionality factor of 40 dB per decade is used to normalize the measured data for determining compliance.

The equipment under test was set up on a non-conductive platform above the ground plane and the situation and orientation was varied to find the maximum radiated emission. It was also rotated 360° and in the range between 30 MHz and 200 MHz the antenna height was varied from 1 to 4 meters to find the maximum radiated emission. In the range between 9 kHz and 30 MHz the measurements were made in the three different orientation planes of the loop antenna to determine the maximum received field. In the range between 30 MHz and 200 MHz the measurements were made in both horizontal and vertical planes of polarization.

Radiated measurements setup 9 kHz to 30 MHz:

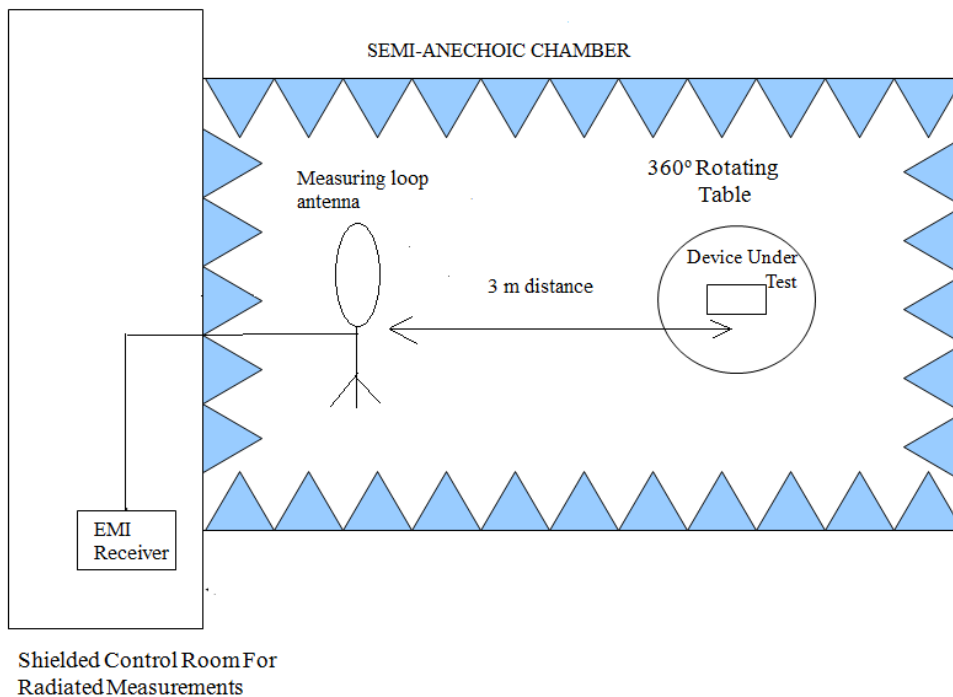

Radiated measurements setup 30 MHz to 200 MHz:

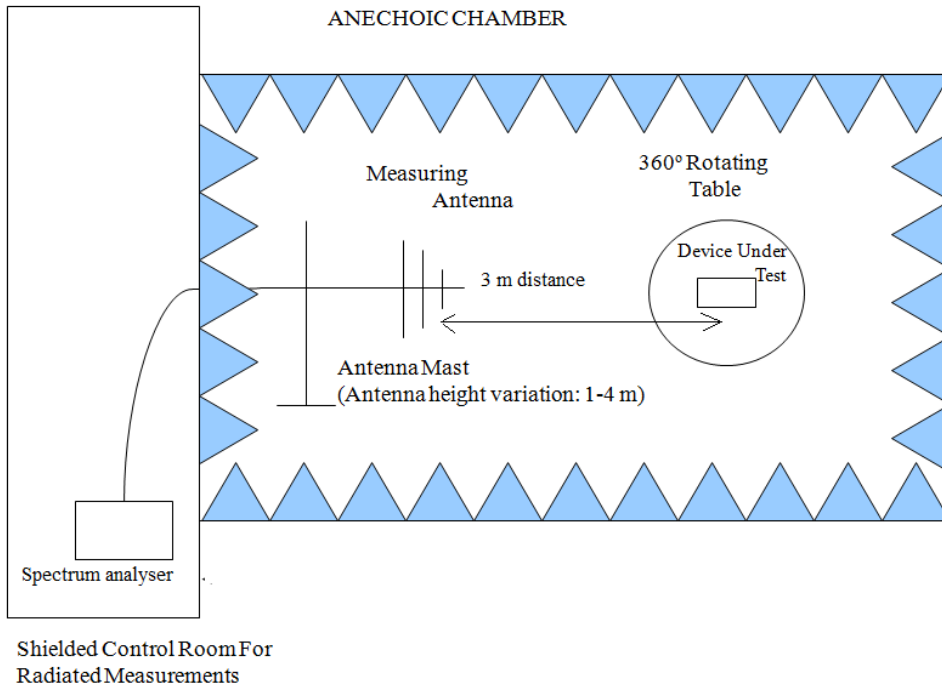

## Occupied Bandwidth

### RESULTS:

99 % Occupied Bandwidth and 20 dB Bandwidth.

- **NFC mode ISO 14443A:**

Operation mode	99% Occupied Bandwidth (kHz)	20 dB Bandwidth (kHz)
NFC 13.56 MHz mode ISO 14443A	629.21	26.60

- **NFC mode ISO 15693:**

Operation mode	99% Occupied Bandwidth (kHz)	20 dB Bandwidth (kHz)
NFC 13.56 MHz mode ISO 15693	628.09	23.60

Verdict: PASS

## FCC 15.225 (a) / RSS-210 B.6 (a). Field strength of emissions within the band 13.553 -13.567 MHz

**SPECIFICATION:**

The field strength of any emissions within the band 13.553 – 13.567 MHz shall not exceed 15,848 microvolts/meter (84 dBµV/m) at 30 meters.

**RESULTS:**

Measurement distance: 3 meters.

- **NFC mode ISO 14443A:**

The maximum field strength of fundamental emission:

Frequency (MHz)	Maximum field strength (dBµV/m) measured at 3 m (quasi-peak detector)	Maximum field strength (dBµV/m) extrapolated to 30 m (40 dB/decade)
13.561	63.12	23.12

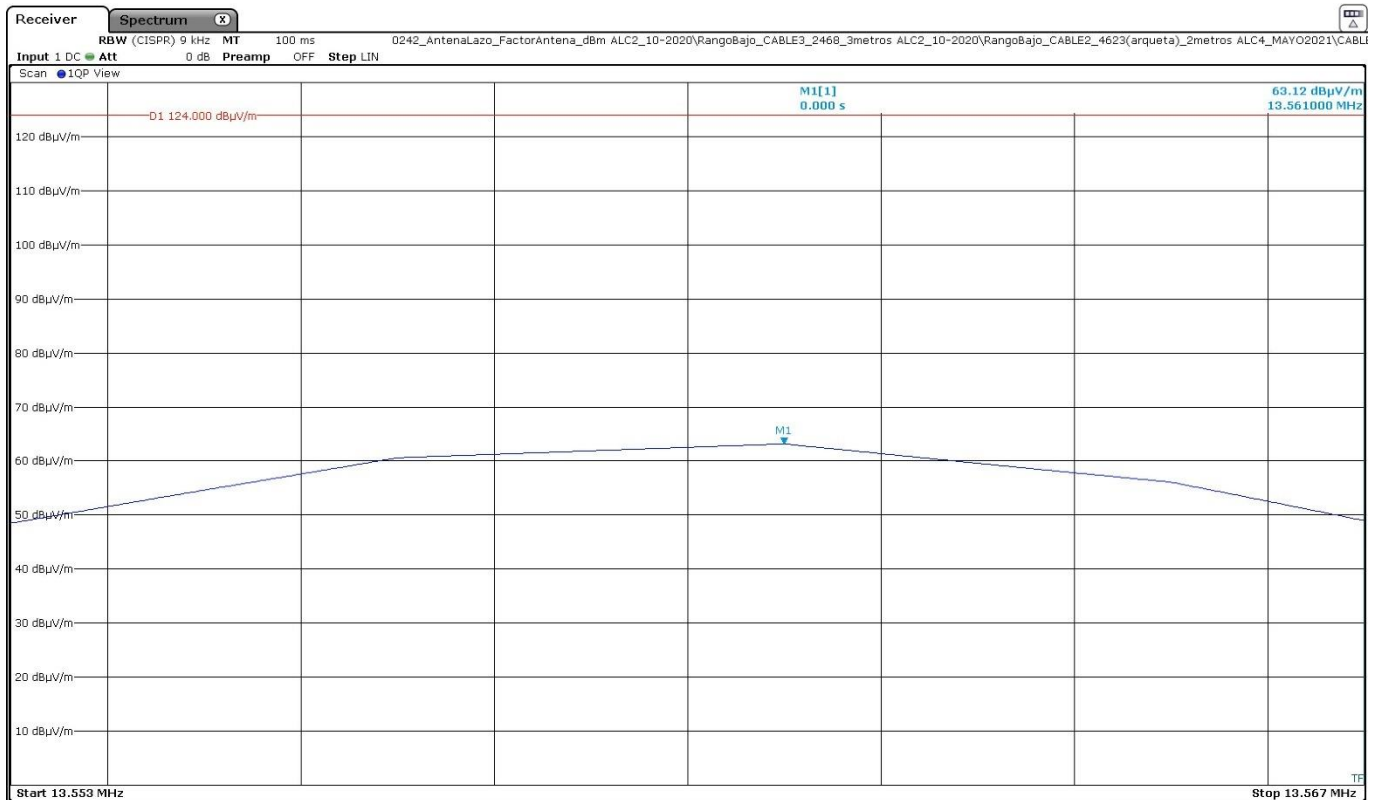

The limit shown in the above plot is extrapolated to 3 meters

Verdict: PASS

- **NFC mode ISO 15693:**

The maximum field strength of fundamental emission:

Frequency (MHz)	Maximum field strength (dBµV/m) measured at 3 m (quasi-peak detector)	Maximum field strength (dBµV/m) extrapolated to 30 m (40 dB/decade)
13.561	62.82	22.82

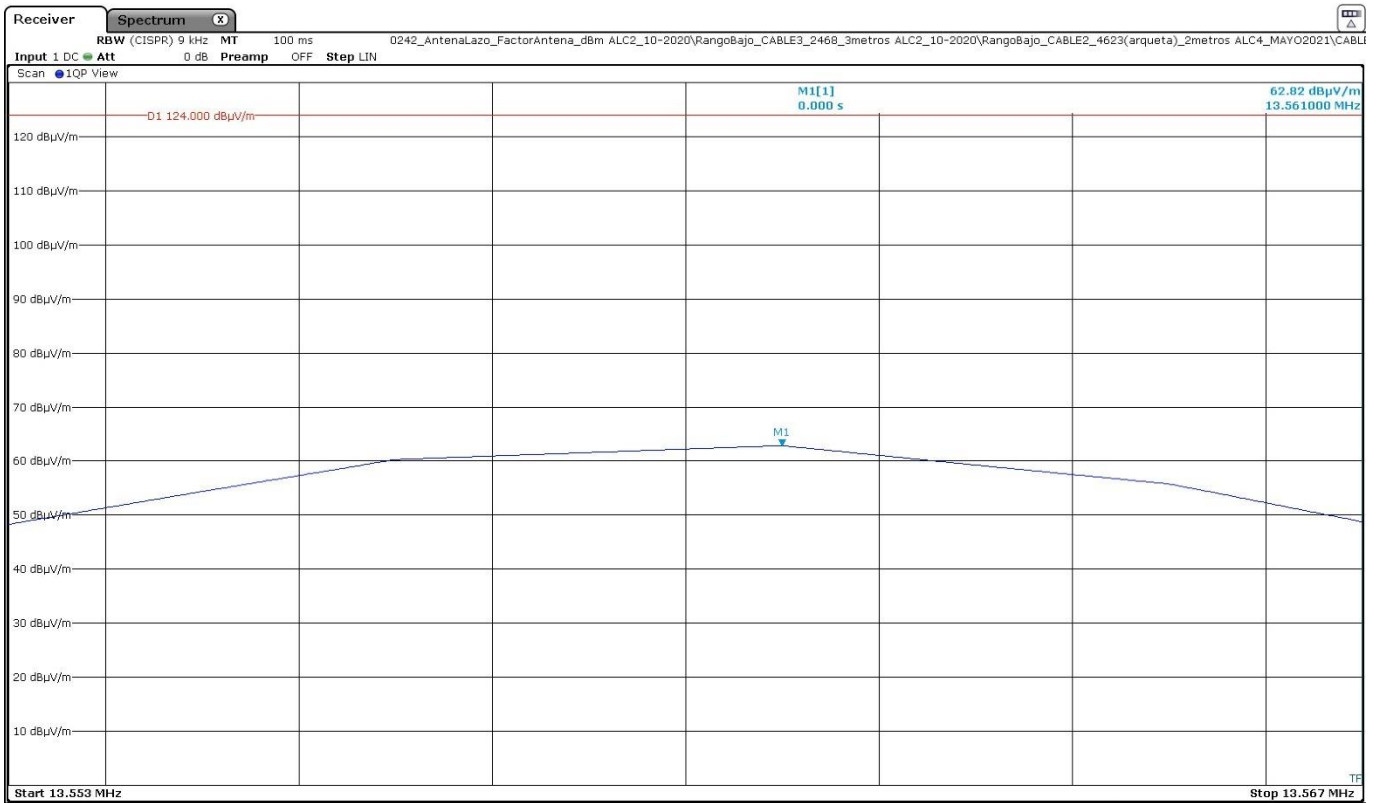

The limit shown in the above plot is extrapolated to 3 meters

Verdict: PASS



## FCC 15.225 (b) / RSS-210 B.6 (b). Field strength of emissions within the band 13.410 - 13.553 MHz and 13.567 - 13.710 MHz

**SPECIFICATION:**

Within the bands 13.410-13.553 MHz and 13.567-13.710 MHz, the field strength of any emissions shall not exceed 334 microvolts/meter (50.47 dBµV/m) at 30 meters.

**RESULTS:**

Measurement distance: 3 meters.

**- Band 13.410 - 13.553 MHz**

- **NFC mode ISO 14443A:**

Frequency (MHz)	Maximum field strength (dBµV/m) measured at 3 m (quasi-peak detector)	Maximum field strength (dBµV/m) extrapolated to 30 m (40 dB/decade)
13.553	48.50	8.50

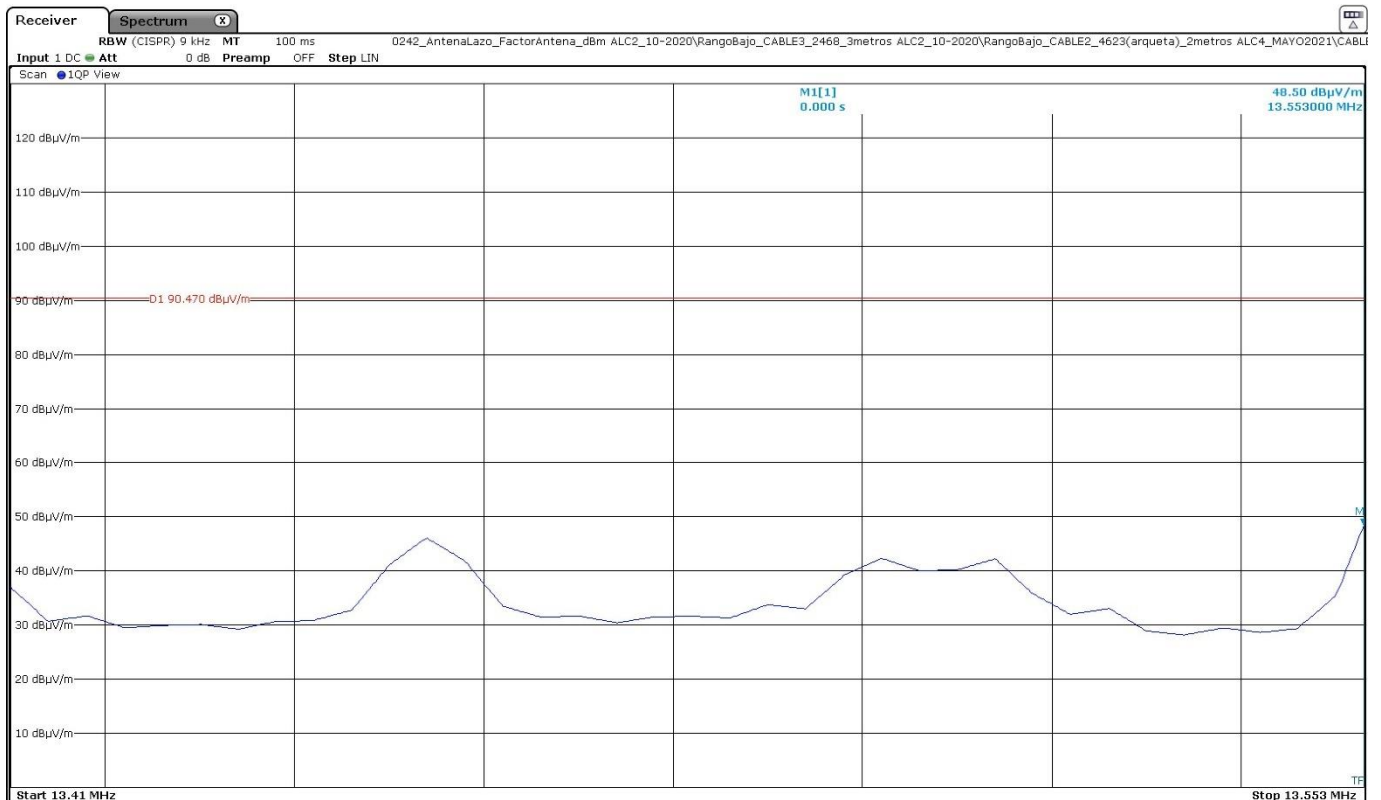

The limit shown in the above plot is extrapolated to 3 meters

Verdict: PASS

- **NFC mode ISO 15693:**

Frequency (MHz)	Maximum field strength (dBµV/m) measured at 3 m (quasi-peak detector)	Maximum field strength (dBµV/m) extrapolated to 30 m (40 dB/decade)
13.553	48.33	8.33

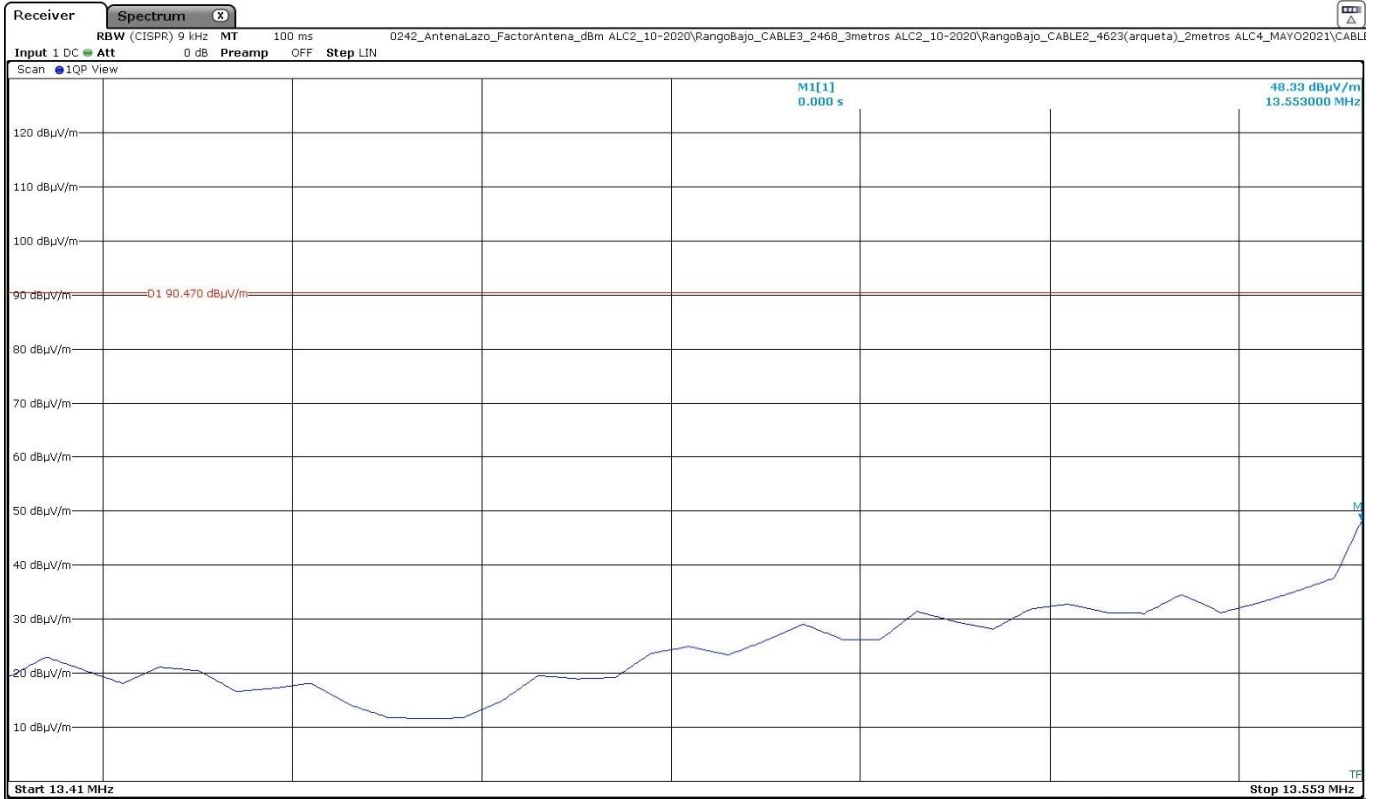

The limit shown in the above plot is extrapolated to 3 meters

Verdict: PASS

**- Band 13.567-13.710 MHz**

- **NFC mode ISO 14443A:**

Frequency (MHz)	Maximum field strength (dBµV/m) measured at 3 m (quasi-peak detector)	Maximum field strength (dBµV/m) extrapolated to 30 m (40 dB/decade)
13.567	48.98	8.98

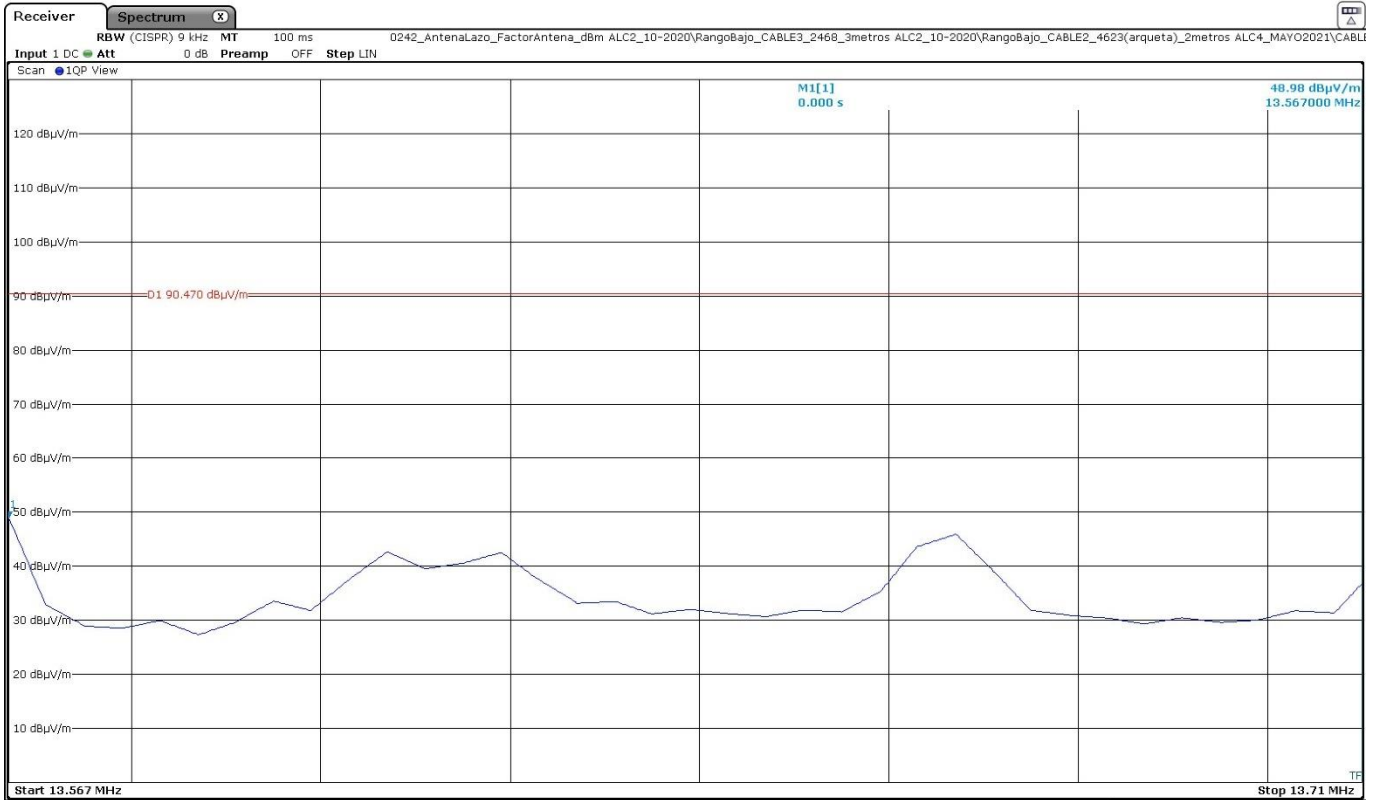

The limit shown in the above plot is extrapolated to 3 meters

Verdict: PASS

- **NFC mode ISO 15693:**

Frequency (MHz)	Maximum field strength (dBµV/m) measured at 3 m (quasi-peak detector)	Maximum field strength (dBµV/m) extrapolated to 30 m (40 dB/decade)
13.567	48.79	8.79

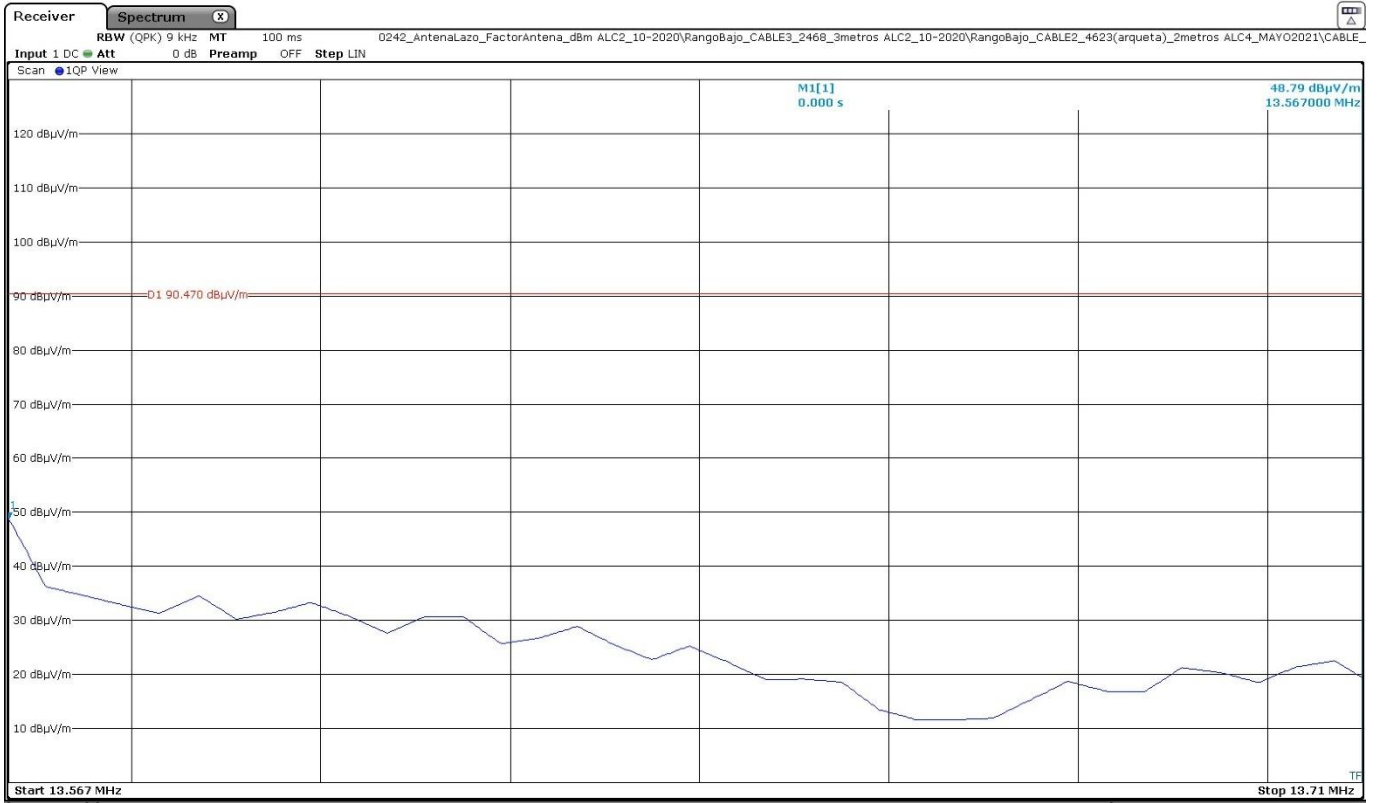

The limit shown in the above plot is extrapolated to 3 meters

Verdict: PASS

## FCC 15.225 (c) / RSS-210 B.6 (c). Field strength of emissions within the band 13.110 - 13.410 MHz and 13.710 - 14.010 MHz

**SPECIFICATION:**

Within the bands 13.110-13.410 MHz and 13.710-14.010 MHz, the field strength of any emissions shall not exceed 106 microvolts/meter (40.51 dBµV/m) at 30 meters.

**RESULTS:**

Measurement distance: 3 meters.

**- Band 13.110-13.410 MHz**

- **NFC mode ISO 14443A:**

Frequency (MHz)	Maximum field strength (dBµV/m) measured at 3 m (quasi-peak detector)	Maximum field strength (dBµV/m) extrapolated to 30 m (40 dB/decade)
13.350	40.00	0.00

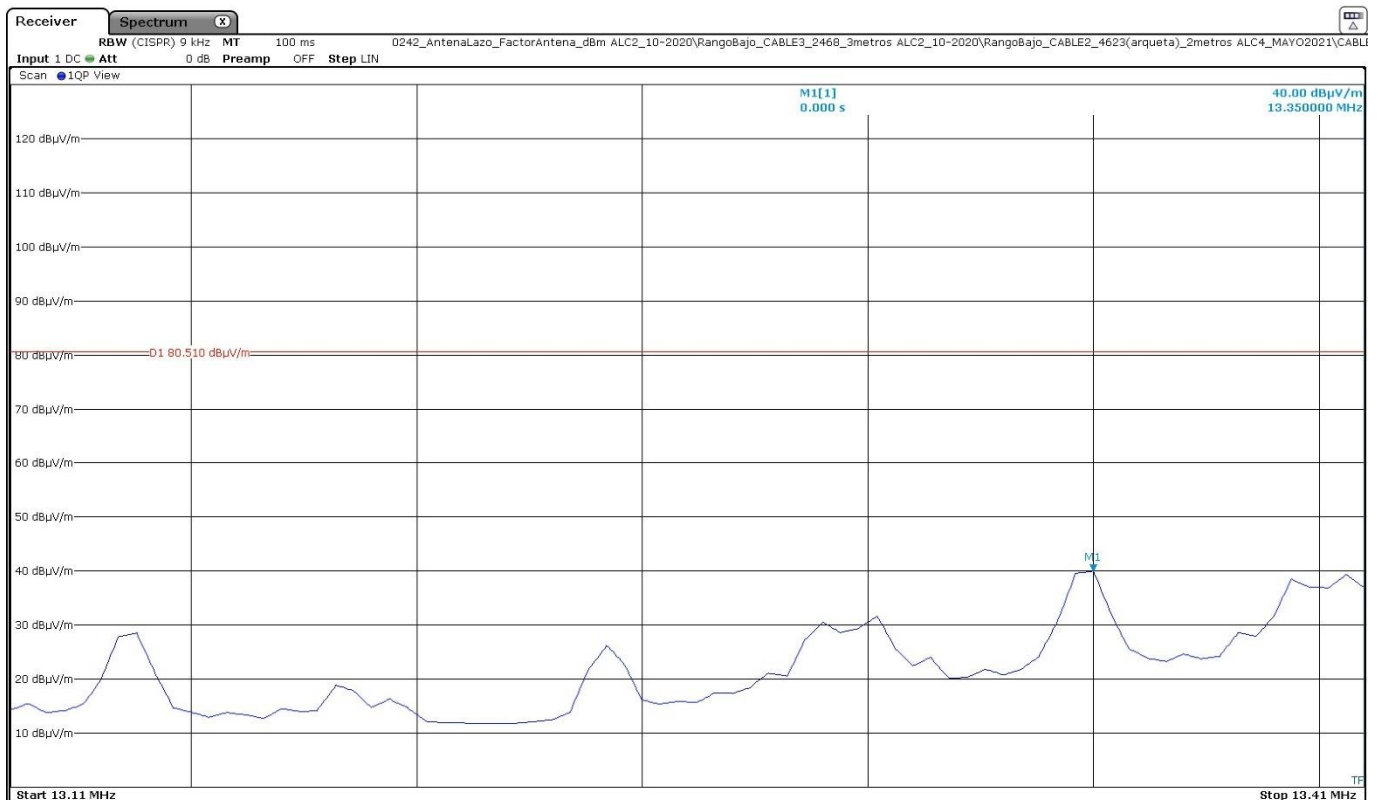

The limit shown in the above plot is extrapolated to 3 meters

Verdict: PASS

- **NFC mode ISO 15693:**

Frequency (MHz)	Maximum field strength (dBµV/m) measured at 3 m (quasi-peak detector)	Maximum field strength (dBµV/m) extrapolated to 30 m (40 dB/decade)
13.402	22.85	-17.15

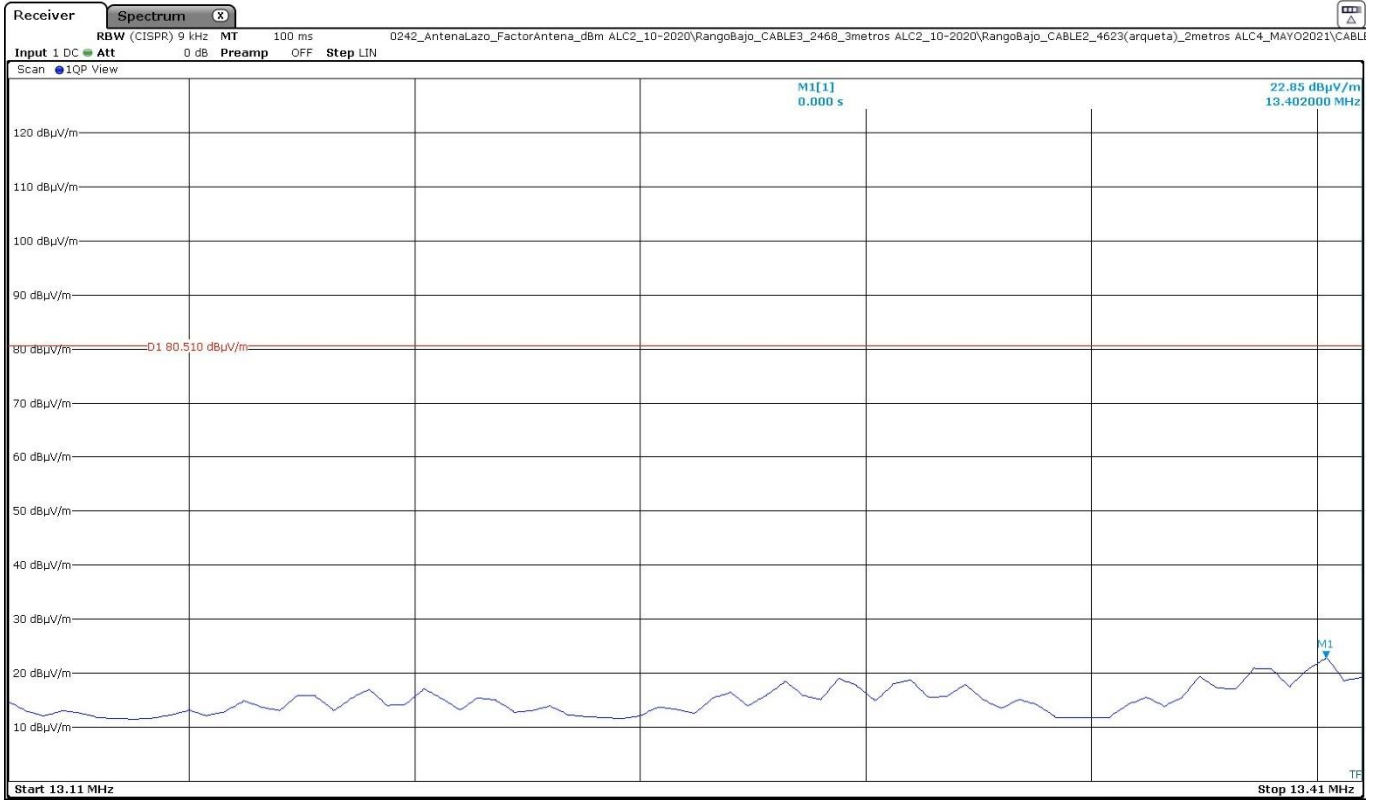

The limit shown in the above plot is extrapolated to 3 meters

Verdict: PASS

**- Band 13.710-14.010 MHz**

- **NFC mode ISO 14443A:**

Frequency (MHz)	Maximum field strength (dBµV/m) measured at 3 m (quasi-peak detector)	Maximum field strength (dBµV/m) extrapolated to 30 m (40 dB/decade)
13.770	39.86	-0.14

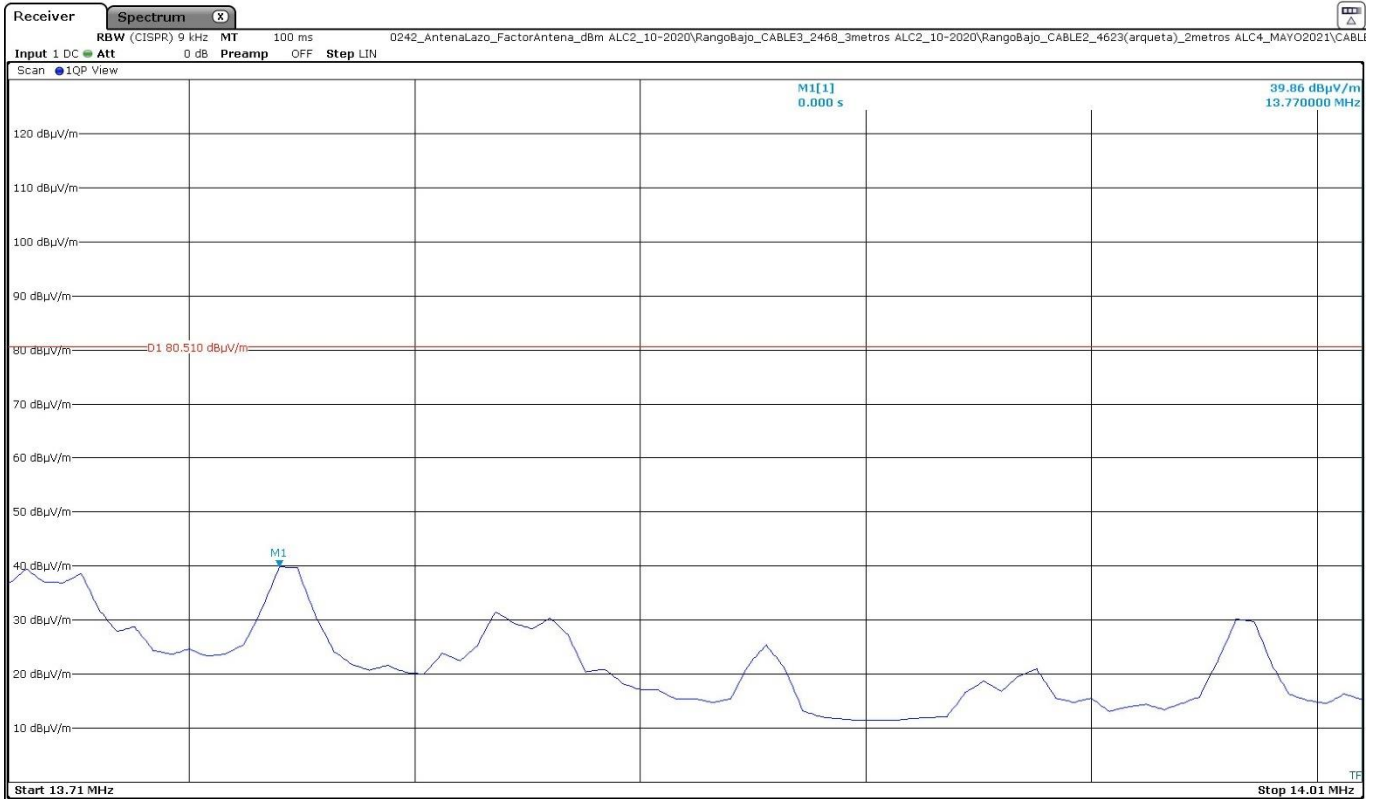

The limit shown in the above plot is extrapolated to 3 meters

Verdict: PASS

- **NFC mode ISO 15693:**

Frequency (MHz)	Maximum field strength (dBµV/m) measured at 3 m (quasi-peak detector)	Maximum field strength (dBµV/m) extrapolated to 30 m (40 dB/decade)
13.718	22.59	-17.41

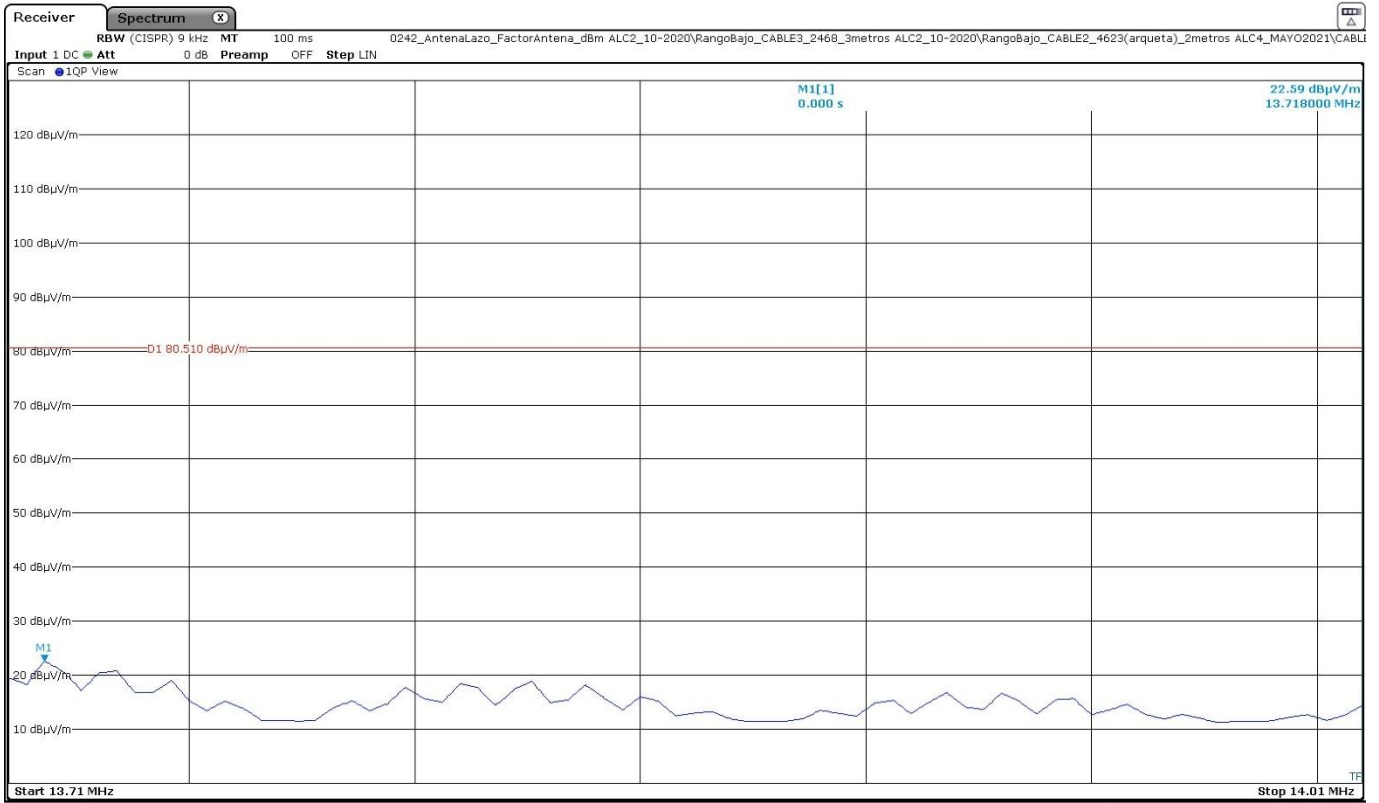

The limit shown in the above plot is extrapolated to 3 meters

Verdict: PASS



## FCC 15.225 (d) / RSS-210 B.6 (a)(iv) Field Strength of Emissions outside of the band 13.110 MHz - 14.010 MHz

### SPECIFICATION:

Field strength of any emissions appearing outside of the band 13.110 MHz - 14.010 MHz band shall not exceed the general radiated emission limits in 15.209/RSS-Gen:

Frequency Range (MHz)	Field strength ( $\mu\text{V/m}$ )	Field strength ( $\text{dB}\mu\text{V/m}$ )	Measurement distance (m)
0.009-0.490	2400/F(kHz)	-	300
0.490-1.705	24000/F(kHz)	-	30
1.705 - 30.0	30	29.54	30
30 - 88	100	40	3
88 - 216	150	43.5	3
216 - 960	200	46	3
Above 960	500	54	3

### RESULTS:

All tests were performed in a semi-anechoic chamber at a distance of 3 m.

The spectrum was inspected from 9 kHz to 200 MHz searching for spurious signals.

The field strength is calculated by adding correction factor to the measured level from the spectrum analyzer. This correction factor includes antenna factor, cable loss and pre-amplifier gain.

- Frequency range 9 kHz - 30 MHz:

- NFC mode ISO 14443A:

No spurious frequencies were found at less than 20 dB of the limit.

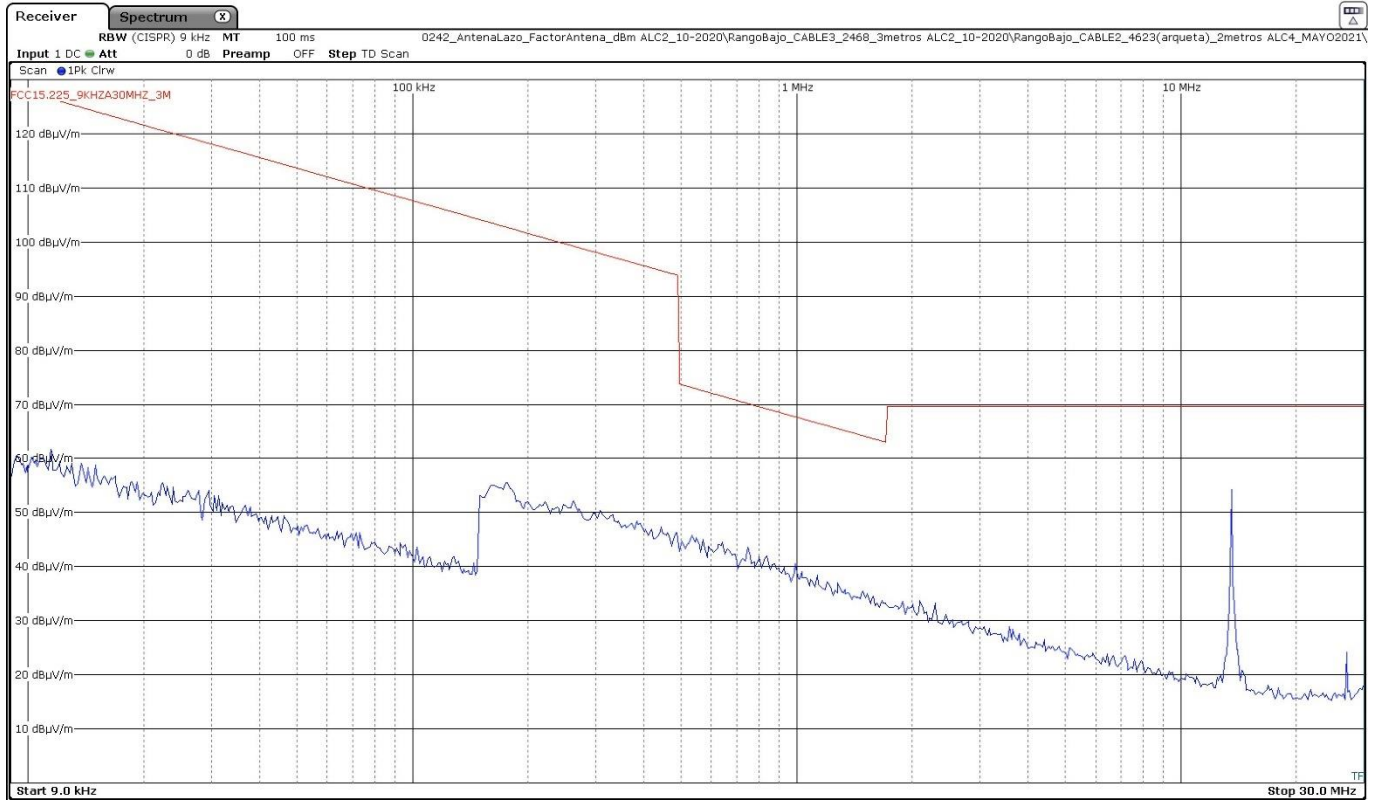

The limits shown in the above plot are extrapolated to 3 meters. The highest peak corresponds to the carrier level.

Resolution bandwidth:  
200 Hz for  $9 \text{ kHz} \leq f \leq 150 \text{ kHz}$   
9 kHz for  $150 \text{ kHz} \leq f \leq 30 \text{ MHz}$

- **NFC mode ISO 15693:**

No spurious frequencies were found at less than 20 dB of the limit.

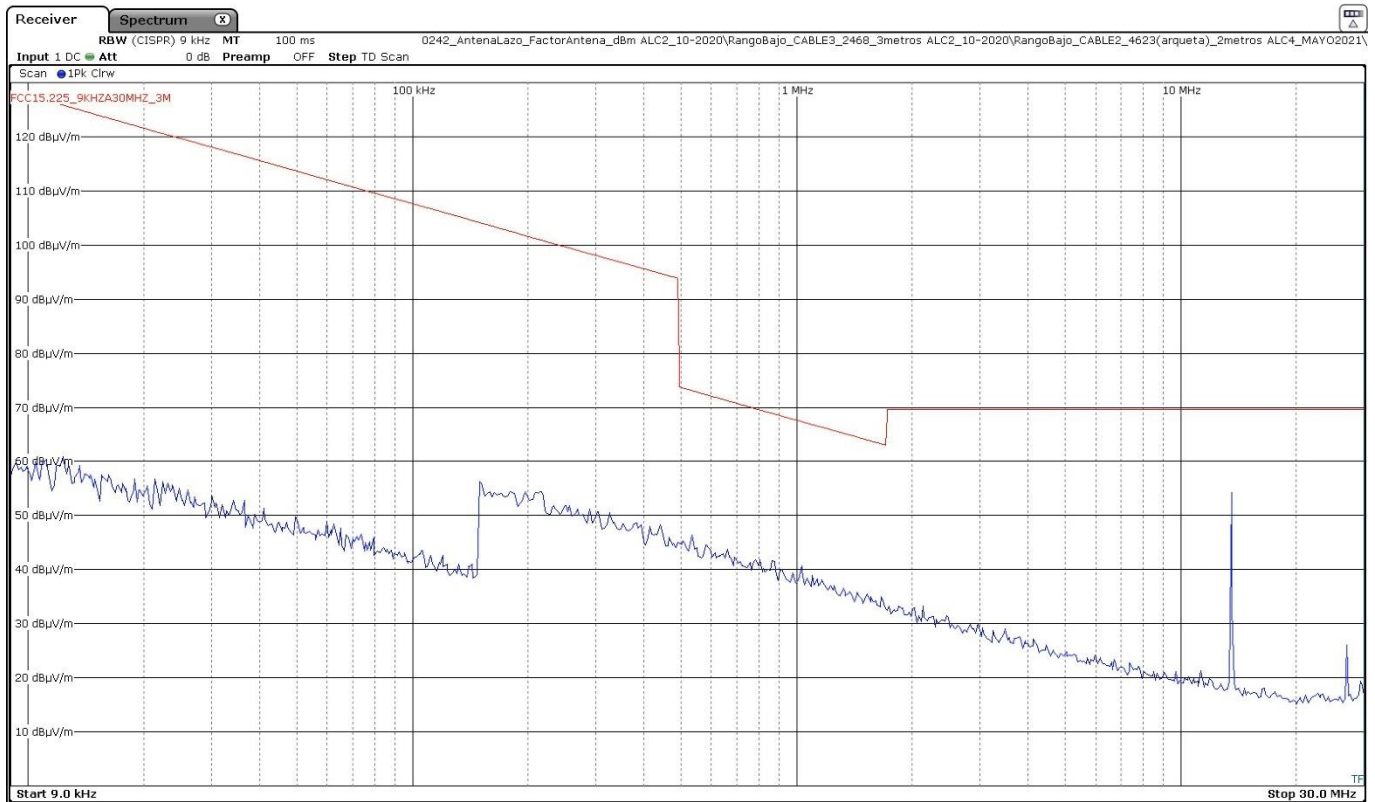

The limits shown in the above plot are extrapolated to 3 meters. The highest peak corresponds to the carrier level.

Resolution bandwidth:  
200 Hz for  $9 \text{ kHz} \leq f \leq 150 \text{ kHz}$   
9 kHz for  $150 \text{ kHz} \leq f \leq 30 \text{ MHz}$

- Frequency range 30 - 200 MHz:

- NFC mode ISO 14443A:

Spurious frequency (MHz)	Emission Level (dBµV/m)	Polarization	Detector
63.9915	20.56	V	Quasi peak
67.7995	21.01	V	Quasi peak

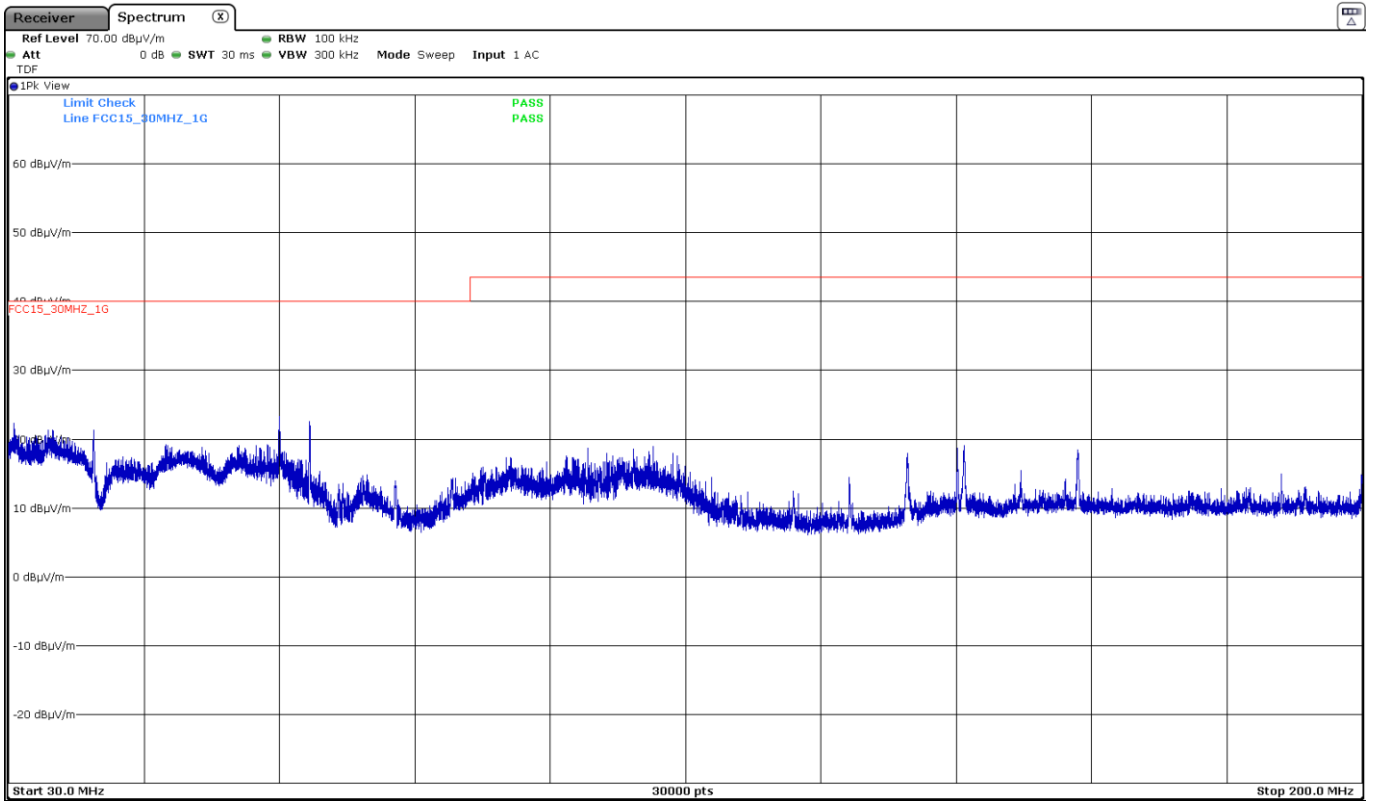

The above plot shows the results of the scan using peak detector.

Verdict: PASS

- **NFC mode ISO 15693:**

No spurious frequencies were found at less than 20 dB of the limit.

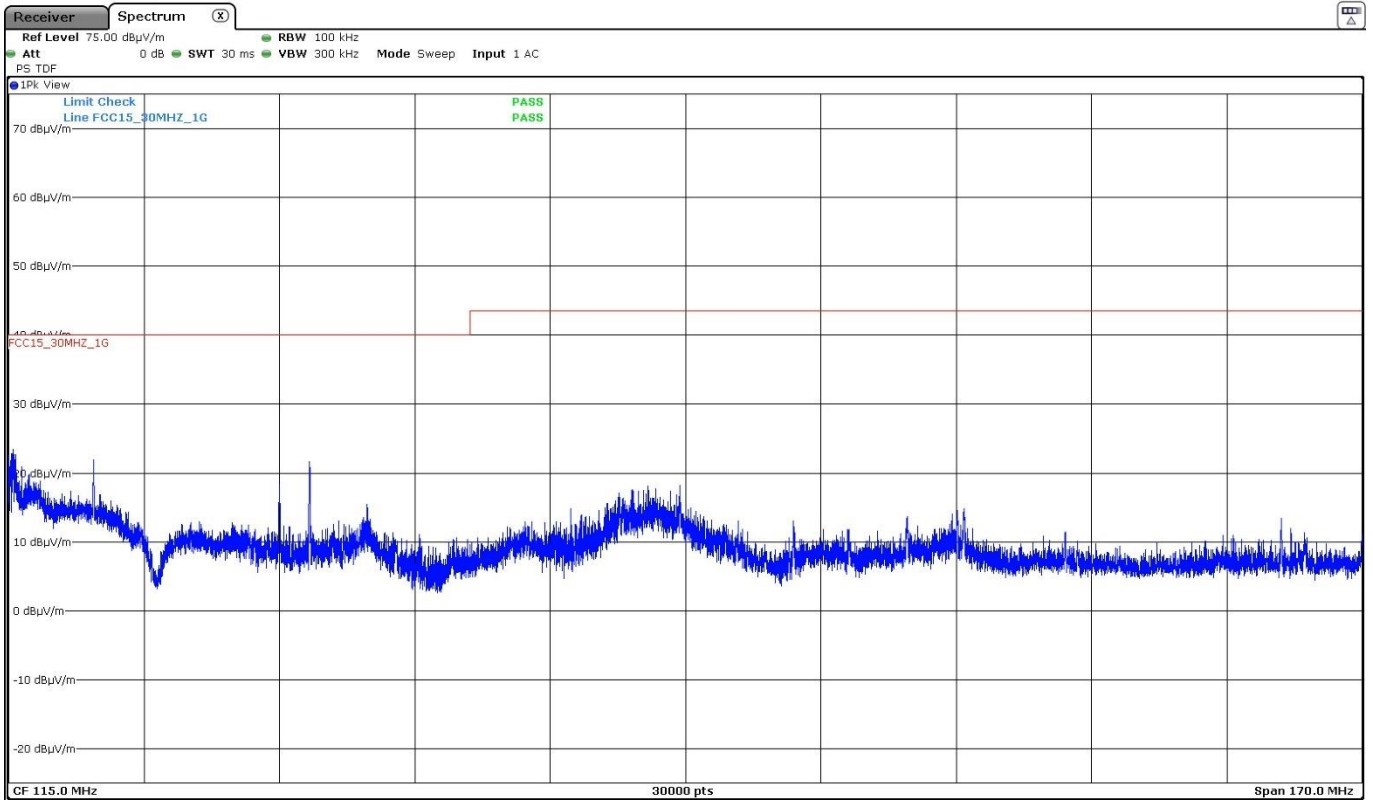

The above plot shows the results of the scan using peak detector.

Verdict: PASS

## FCC 15.225 (e) / RSS-210 B.6 (b) Frequency Tolerance of the Carrier Signal

**SPECIFICATION:**

The frequency tolerance of the carrier signal shall be maintained within +/- 0.01% of the operating frequency over a temperature variation of -20 degrees to +50 degrees C at normal supply voltage, and for a variation in the primary supply voltage from 85% to 115% of the rated supply voltage at a temperature of 20 degrees C. For hand carried, battery powered equipment, reduce primary supply voltage to the battery operating end point which shall be specified by the manufacturer.

**RESULTS:**

Nominal Operating Frequency: 13.56 MHz.

- **NFC mode ISO 14443A:**

**Frequency Stability over Temperature Variations:**

Temperature (°C)	Frequency Error (kHz)	Frequency Error (%)
+50	0.097500	0.000719
+40	0.061500	0.000454
+30	0.028500	0.000210
+20	0.022500	0.000166
+10	0.013500	0.000100
0	0.007500	0.000055
-10	0.024000	0.000177
-20	0.030000	0.000221

**Frequency Stability over Voltage Variations:**

DC Voltage	Voltage (V)	Temperature (°C)	Frequency Error (kHz)	Frequency Error (%)
Vmax	15.594	20	0.024000	0.000177
Vmin	10.20	20	0.024000	0.000177

Verdict: PASS

- **NFC mode ISO 15693:**

**Frequency Stability over Temperature Variations:**

Temperature (°C)	Frequency Error (kHz)	Frequency Error (%)
+50	0.097500	0.000719
+40	0.055500	0.000409
+30	0.039000	0.000288
+20	0.036000	0.000265
+10	0.021000	0.000155
0	0.015000	0.000111
-10	0.021000	0.000155
-20	0.028500	0.000210

**Frequency Stability over Voltage Variations:**

DC Voltage	Voltage (V)	Temperature (°C)	Frequency Error (kHz)	Frequency Error (%)
Vmax	15.594	20	0.034500	0.000254
Vmin	10.20	20	0.033000	0.000243

Verdict: PASS