

ISED CABid: ES1909  
 Lab. Company Number: 4621A

Test Report No:  
 NIE: 72449RRF.009

## Test Report

USA FCC 15.225, 15.209

CANADA RSS-210, RSS-Gen

(*) Identification of item tested	XS4 Original+ Electronic Lock Series including all mechanical variants
(*) Trademark	SALTO
(*) Model and /or type reference	W61M / Type reference: E2131
(*) Derived model not tested	XS4 One+ sfc Electronic Lock Series including all mechanical variants.
Other identification of the product	FCC ID: UKCW61M IC ID: 10088A-W61M
(*) Features	Bluetooth LE HW version: 1.0 SW version: 0174 (Control FW) + 0186 (FUS FW) + 0187 (BLE FW) + 0202 (Motor FW)
Applicant	SALTO SYSTEMS, S.L. Arkotz 9, Polígono Lanbarren 20180, Oiartzun, Guipúzcoa, Spain
Test method requested, standard	USA FCC Part 15.225 (10-1-21 Edition): Operation within the band 13.110 -14.010. USA FCC Part 15.209 (10-1-21 Edition): Radiated emission limits, general requirements. CANADA RSS-210 Issue 10 (December 2019). CANADA RSS-Gen Issue 5 (March 2019). ANSI C63.10-2020: American National Standard Of Procedures For Compliance Testing Of Unlicensed Wireless Devices.
Summary	IN COMPLIANCE
Approved by (name / position & signature)	José Manuel Gómez Galván EMC Consumer & RF Lab. Manager
Date of issue	2022-02-24
Report template No	FDT08_24 (* "Data provided by the client")

# Index

Competences and guarantees .....	3
General conditions .....	3
Uncertainty .....	3
Data provided by the client .....	3
Usage of samples .....	4
Test sample description .....	5
Identification of the client .....	5
Testing period and place .....	5
Document history .....	6
Environmental conditions .....	6
Remarks and comments .....	6
Testing verdicts .....	8
Summary .....	8
Appendix A: Test results .....	9

## Competences and guarantees

---

DEKRA Testing and Certification S.A.U. is a testing laboratory accredited by the National Accreditation Body (ENAC - Entidad Nacional de Acreditación), to perform the tests indicated in the Certificate No. 51/LE 147.

DEKRA Testing and Certification S.A.U. is an FCC-recognized accredited testing laboratory with appropriate scope of accreditation that include testing performed in this test report.

DEKRA Testing and Certification S.A.U. is an ISED-recognized accredited testing laboratory, CABid: ES1909, Company Number: 4621A, with the appropriate scope of accreditation that covers the performed tests in this report.

In order to assure the traceability to other national and international laboratories, DEKRA Testing and Certification S.A.U. has a calibration and maintenance program for its measurement equipment.

DEKRA Testing and Certification S.A.U. guarantees the reliability of the data presented in this report, which is the result of the measurements and the tests performed to the item under test on the date and under the conditions stated on the report and, it is based on the knowledge and technical facilities available at DEKRA Testing and Certification S.A.U. at the time of performance of the test.

DEKRA Testing and Certification S.A.U. is liable to the client for the maintenance of the confidentiality of all information related to the item under test and the results of the test.

The results presented in this Test Report apply only to the particular item under test established in this document.

**IMPORTANT:** No parts of this report may be reproduced or quoted out of context, in any form or by any means, except in full, without the previous written permission of DEKRA Testing and Certification S.A.U.

## General conditions

---

1. This report is only referred to the item that has undergone the test.
2. This report does not constitute or imply on its own an approval of the product by the Certification Bodies or competent Authorities.
3. This document is only valid if complete; no partial reproduction can be made without previous written permission of DEKRA Testing and Certification S.A.U.
4. This test report cannot be used partially or in full for publicity and/or promotional purposes without previous written permission of DEKRA Testing and Certification and the Accreditation Bodies.

## Uncertainty

---

Uncertainty (factor  $k=2$ ) was calculated according to the DEKRA Testing and Certification S.A.U. internal document PODT000.

## Data provided by the client

---

The following data has been provided by the client:

1. Information relating to the description of the sample ("Identification of the item tested", "Trademark", "Model and/or type reference tested").
2. The sample model 'W61M / Type reference: E2131' is a XS4 Original+ Electronic Lock Series with RFID Mifare (ISO 14443A & ISO 15693 standard based) and Bluetooth LE technology.

DEKRA Testing and Certification S.A.U. declines any responsibility with respect to the information provided by the client and that may affect the validity of results.

## Usage of samples

---

Samples undergoing test have been selected by: The client.

- Sample S/01 is composed of the following elements:

Control Nº	Description	Model	Serial Nº	Reception
72449/005	XS4 Original+ Electronic Lock	W61M / Type reference: E2131	-	21-10-2022

---

Sample S/01 has undergone the test(s): The Conducted tests indicated in the Appendix A.

- Sample S/02 is composed of the following elements:

Control Nº	Description	Model	Serial Nº	Reception
73050/008	XS4 Original+ Electronic Lock	W61M / Type reference: E2131	-	05-09-2022

---

Sample S/02 has undergone the test(s): The Radiated tests indicated in the Appendix A.

---

## Test sample description

Ports.....:	Port name and description	Cable					
		Specified max length [m]	Attached during test	Shielded	Coupled to patient <sup>(3)</sup>		
	-	-	<input type="checkbox"/>	<input type="checkbox"/>	<input type="checkbox"/>		
Supplementary information to the ports.....:	-						
Rated power supply .....	Voltage and Frequency		Reference poles				
			L1	L2	L3	N	PE
	<input type="checkbox"/>	AC:	<input type="checkbox"/>	<input type="checkbox"/>	<input type="checkbox"/>	<input type="checkbox"/>	<input type="checkbox"/>
	<input type="checkbox"/>	AC:	<input type="checkbox"/>	<input type="checkbox"/>	<input type="checkbox"/>	<input type="checkbox"/>	<input type="checkbox"/>
	<input checked="" type="checkbox"/>	DC: 4.5 Vdc (3 x LR06 batteries)					
<input type="checkbox"/>	DC:						
Rated Power .....	-						
Clock frequencies .....	27.12 MHz, 32 MHz, 32.768 KHz						
Other parameters.....:	N/A						
Software version .....	0174 (Control FW) + 0186 (FUS FW) + 0187 (BLE FW) + 0202 (Motor FW)						
Hardware version.....:	1.0						
Dimensions in cm (W x H x D).....:	6.7 x 29.0 x 2.0 cm						
Mounting position.....:	<input type="checkbox"/>	Table top equipment					
	<input type="checkbox"/>	Wall/Ceiling mounted equipment					
	<input type="checkbox"/>	Floor standing equipment					
	<input type="checkbox"/>	Hand-held equipment					
	<input checked="" type="checkbox"/>	Other: Door mounting					
Modules/parts .....	Module/parts of test item		Type	Manufacturer			
	SoC + Antenna		BLE	ST + JOHANSON			
Accessories (not part of the test item) .....	Description		Type	Manufacturer			
	-		-	-			
Documents as provided by the applicant.....:	Description		File name	Issue date			
	User manual		-	-			
	FW Explanation		-	-			

<sup>(3)</sup> Only for Medical Equipment

## Identification of the client

SALTO SYSTEMS, S.L.

Arkotz 9, Polígono Lanbarren, 20180, Oiartzun, Guipúzcoa, Spain

## Testing period and place

Test Location	DEKRA Testing and Certification S.A.U.
Date (start)	11-09-2022
Date (finish)	17-12-2022

## Document history

Report number	Date	Description
72449RRF.009	2022-02-24	First release.

## Environmental conditions

In the control chamber, the following limits were not exceeded during the test:

Temperature	Min. = 15 °C Max. = 35 °C
Relative humidity	Min. = 20 % Max. = 75 %

In the semianechoic chamber, the following limits were not exceeded during the test.

Temperature	Min. = 15 °C Max. = 35 °C
Relative humidity	Min. = 20 % Max. = 75 %

In the chamber for conducted measurements, the following limits were not exceeded during the test:

Temperature	Min. = 15 °C Max. = 35 °C
Relative humidity	Min. = 20 % Max. = 75 %

## Remarks and comments

The tests have been performed by the technical personnel: Miguel Manuel, Pablo Redondo, Francisco Javier Fernández.

Used instrumentation:

### Conducted Measurements:

	Last Calibration	Due Calibration
1. Climatic Chamber BINDER MK 56	2022-03	2023-03
2. DC Power Supply 40V/40A Rohde & Schwarz NGPE40	N/A	N/A
3. Signal and Spectrum Analyzer 10 Hz - 40 GHz ROHDE AND SCHWARZ FSV40	2021-02	2023-02
4. Near Field Probe ETS LINDGREN 7405-901	N/A	N/A
5. EMC/RF Testing SW ROHDE AND SCHWARZ WMS32	N/A	N/A

### Radiated Measurements:

	Last Calibration	Due Calibration
1. Semianechoic Absorber Lined Chamber ETS LINDGREN FACT 3 200 STP	N/A	N/A
2. Shielded Room ETS LINDGREN S101	N/A	N/A
3. Active Loop Antenna HEWLETT PACKARD	2022-08	2024-08

	11966A		
4.	EMI Test Receiver 2 Hz - 44 GHz, ROHDE AND SCHWARZ ESW44	2021-12	2023-12
5.	Digital Multimeter, FLUKE 175	2022-11	2023-11
6.	Biconical/Log Antenna 30 MHz - 6 GHz ETS LINDGREN 3142E	2020-10	2023-10
7.	RF Preamplifier, G>38dB 30MHz-6GHz BONN ELEKTRONIK BLNA 0360-01N	2022-06	2023-06
8.	EMC/RF Testing SW ROHDE AND SCHWARZ EMC32	N/A	N/A

## Testing verdicts

Not applicable:	N/A
Pass:	P
Fail:	F
Not measured:	N/M

## Summary

### RFID (NFC 13.56 MHz) ISO 14443A, ISO 15693:

FCC PART 15 PARAGRAPH / RSS-210			
Requirement – Test case		Verdict	Remark
FCC 15.225 (a) / RSS-210 B.6 (a)(i)	Field strength of emissions within the band 13.553 MHz -13.567 MHz	P	
FCC 15.225 (b) / RSS-210 B.6 (a)(ii)	Field strength of emissions within the band 13.410 - 13.553 MHz and 13.567 – 13.710 MHz	P	
FCC 15.225 (c) / RSS-210 B.6 (a)(iii)	Field strength of emissions within the band 13.110 - 13.410 MHz and 13.710 – 14.010 MHz	P	
FCC 15.225 (d) / RSS-210 B.6 (a)(iv)	Field strength of emissions outside of the band 13.110 MHz -14.010 MHz	P	
FCC 15.225 (e) / RSS-210 B.6 (b)	Frequency tolerance of the carrier signal	P	
<u>Supplementary information and remarks:</u>			
None.			



## Appendix A: Test results

## INDEX

TEST CONDITIONS .....	11
Occupied Bandwidth .....	14
FCC 15.225 (a) / RSS-210 B.6 (a)(i) Field Strength of Emissions within the band 13.553 MHz - 13.567 MHz .....	16
FCC 15.225 (b) / RSS-210 B.6 (a)(ii) Field Strength of Emissions within the band 13.410 MHz -13.553 MHz and 13.567 MHz -13.710 MHz .....	18
FCC 15.225 (c) / RSS-210 B.6 (a)(iii) Field Strength of Emissions within the band 13.110 MHz - 13.410 MHz and 13.710 MHz - 14.010 MHz .....	22
FCC 15.225 (d) / RSS-210 B.6 (a)(iv) Field Strength of Emissions outside of the band 13.110 MHz - 14.010 MHz .....	26
FCC 15.225 (e) / RSS-210 B.6 (b) Frequency Tolerance of the Carrier Signal.....	31

## TEST CONDITIONS

(\*) Data provided by the Applicant.

### POWER SUPPLY (\*):

Vnominal: 4.5 Vdc  
Vminimum: 3.825 Vdc  
Vmaximum: 4.95 Vdc  
Type of Power Supply: DC (3 x LR06 batteries)

### ANTENNA (\*):

Type of Antenna: Integral (PCB).  
Maximum Declared Antenna Gain: N/A

### TEST FREQUENCY (\*):

Nominal Operating Frequency: 13.56 MHz  
Types: ISO 14443A, ISO 15693.

### CONDUCTED MEASUREMENTS:

The equipment under test was set up in a shielded room and it is directly connected to the spectrum analyzer.

For frequency stability test the EUT was placed inside a climatic chamber and connected to a frequency meter using a low loss cable. An external DC power supply was connected to the EUT for voltage variation test.

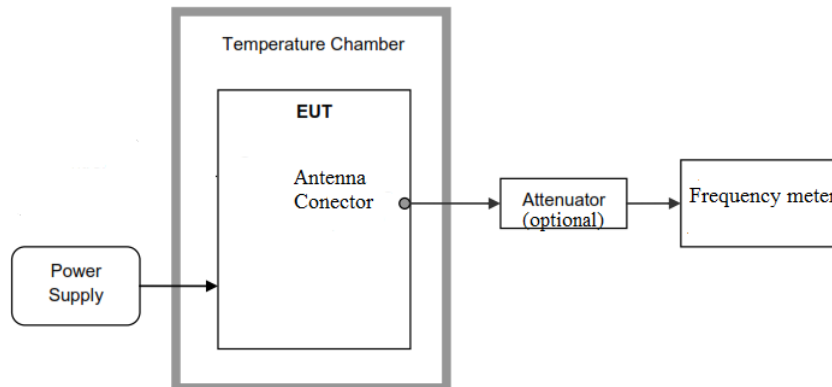

**RADIATED MEASUREMENTS:**

All radiated tests were performed in a semi-anechoic chamber. The measurement antenna (Loop antenna for the range between 9 kHz to 30 MHz and Bilog antenna for the range between 30 MHz to 200 MHz) is situated at a distance of 3 m.

For radiated emissions in the range 9 kHz to 30 MHz that is performed at a distance closer than the specified distance, an inverse proportionality factor of 40 dB per decade is used to normalize the measured data for determining compliance.

The equipment under test was set up on a non-conductive platform above the ground plane and the situation and orientation was varied to find the maximum radiated emission. It was also rotated 360° and in the range between 30 MHz and 200 MHz the antenna height was varied from 1 to 4 meters to find the maximum radiated emission. In the range between 9 kHz and 30 MHz the measurements were made in the three different orientation planes of the loop antenna to determine the maximum received field. In the range between 30 MHz and 200 MHz the measurements were made in both horizontal and vertical planes of polarization.

Radiated measurements setup 9 kHz to 30 MHz:

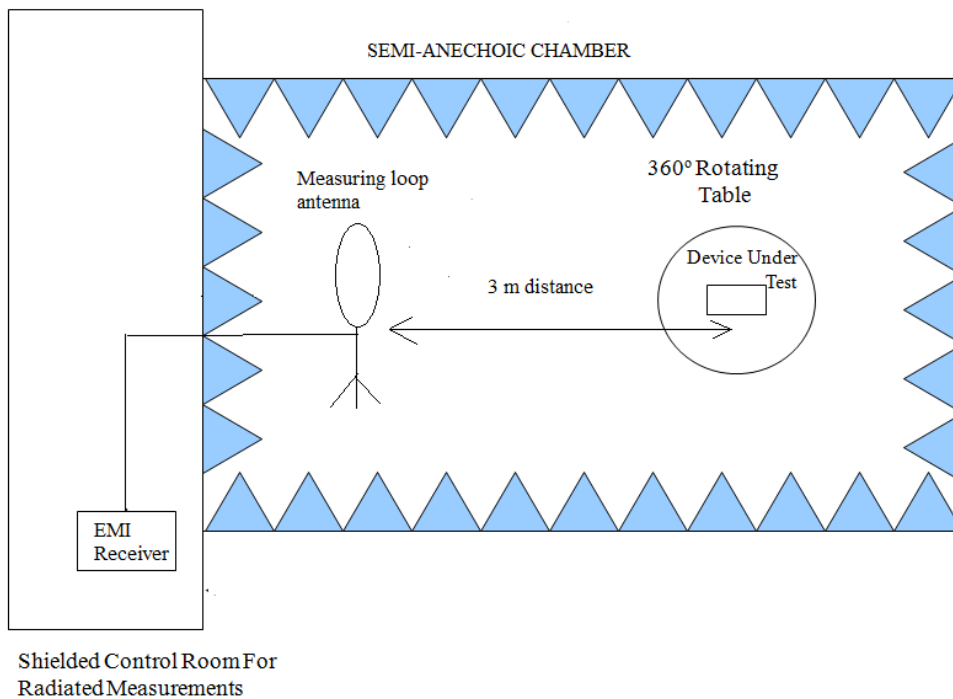

Radiated measurements setup 30 MHz to 200 MHz:

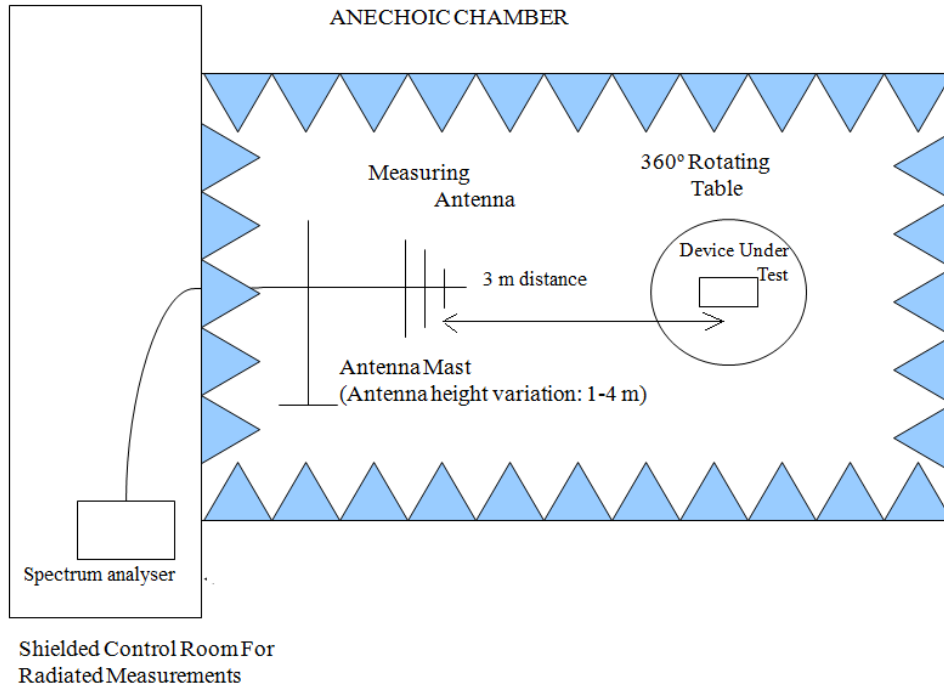

## Occupied Bandwidth

### RESULTS:

99 % Occupied Bandwidth and 20 dB Bandwidth.

- **NFC mode ISO 14443A:**

Operation mode	99% Occupied Bandwidth (kHz)	20 dB Bandwidth (kHz)
NFC mode ISO 14443A	745.65	272.3
Measurement uncertainty (kHz)	$<\pm 0.38$	

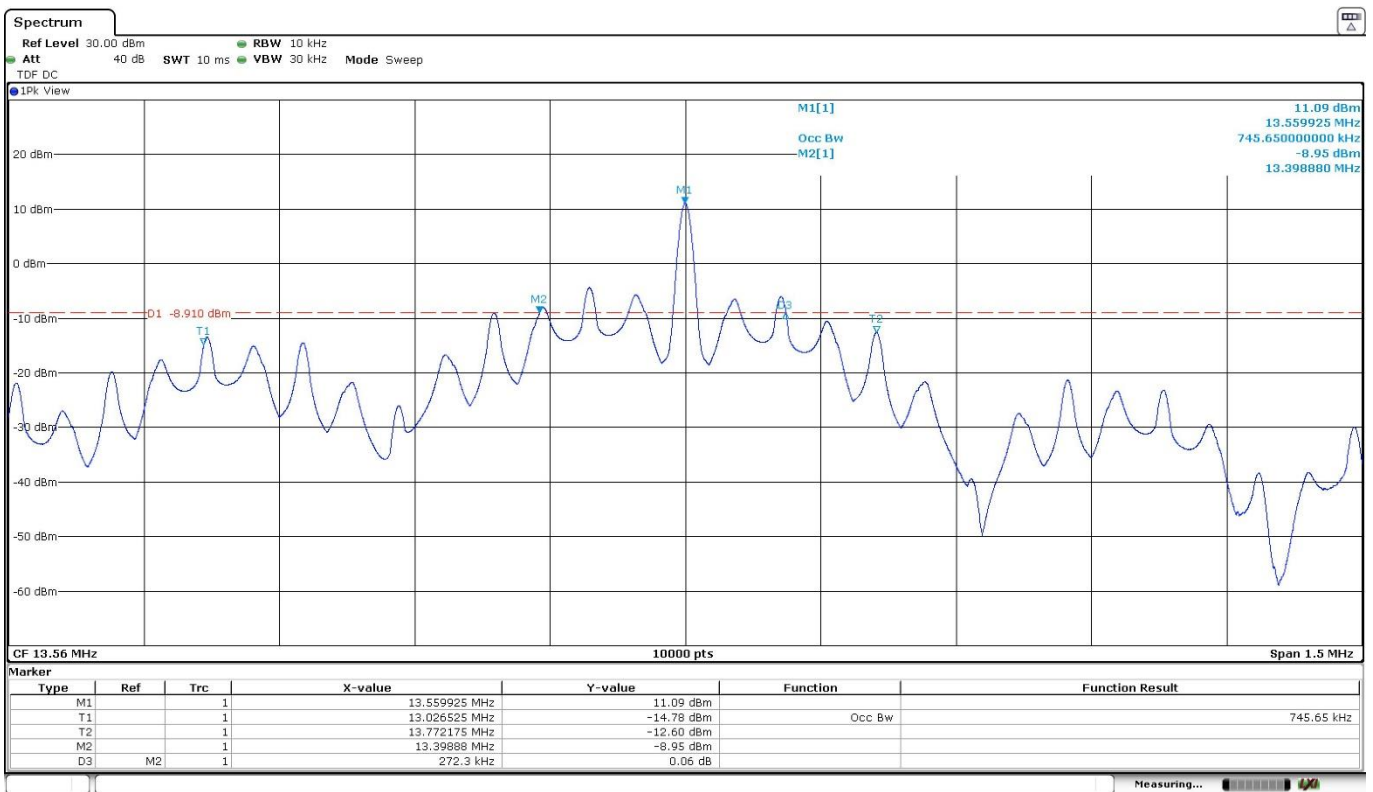

- NFC mode ISO 15693:**

Operation mode	99% Occupied Bandwidth (kHz)	20 dB Bandwidth (kHz)
NFC mode ISO 15693	34.51	2.646
Measurement uncertainty (kHz)	<±0.38	

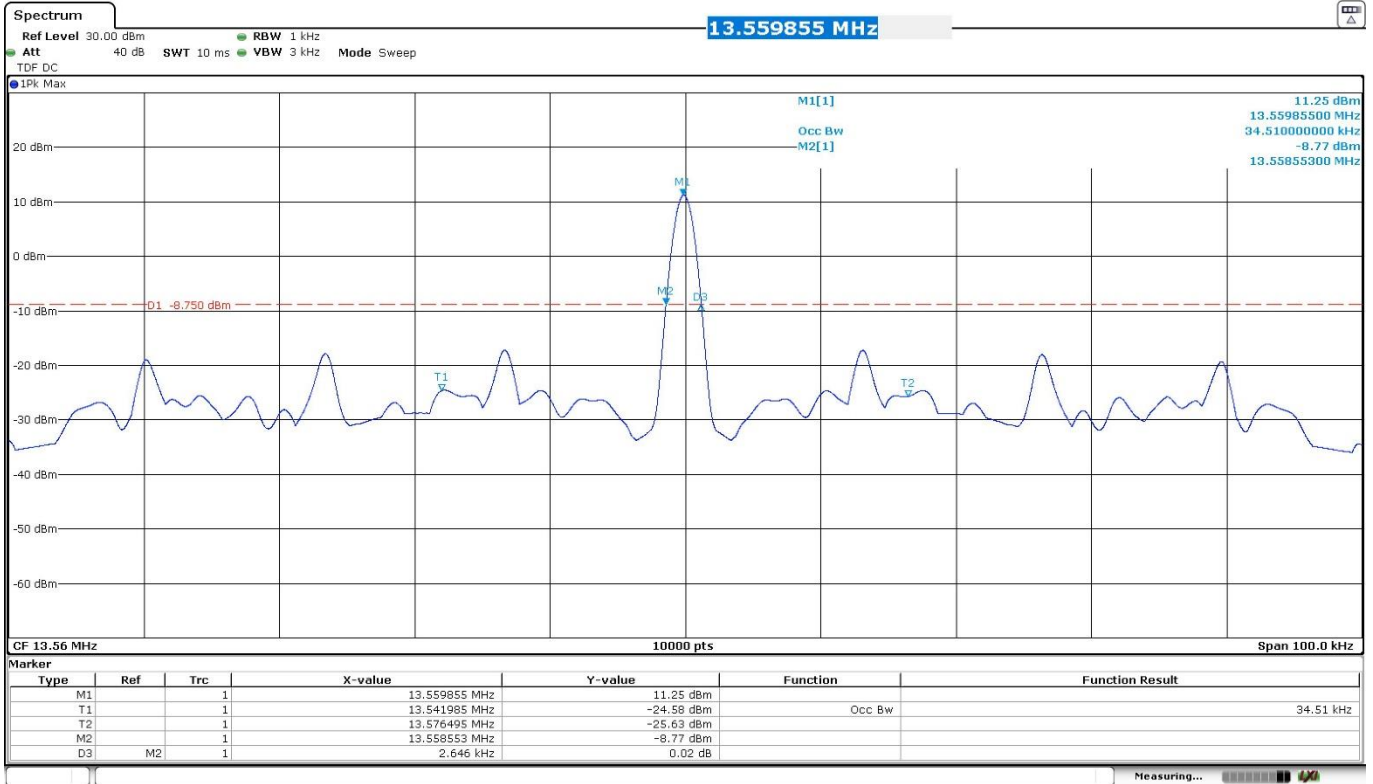

Verdict: PASS

## FCC 15.225 (a) / RSS-210 B.6 (a)(i) Field Strength of Emissions within the band 13.553 MHz - 13.567 MHz

### SPECIFICATION:

The field strength of any emissions within the band 13.553 - 13.567 MHz shall not exceed 15,848 microvolts/meter (84 dB $\mu$ V/m) at 30 meters.

### RESULTS:

Measurement distance: 3 meters.

- **NFC mode ISO 14443A:**

#### Band 13.553 - 13.567 MHz:

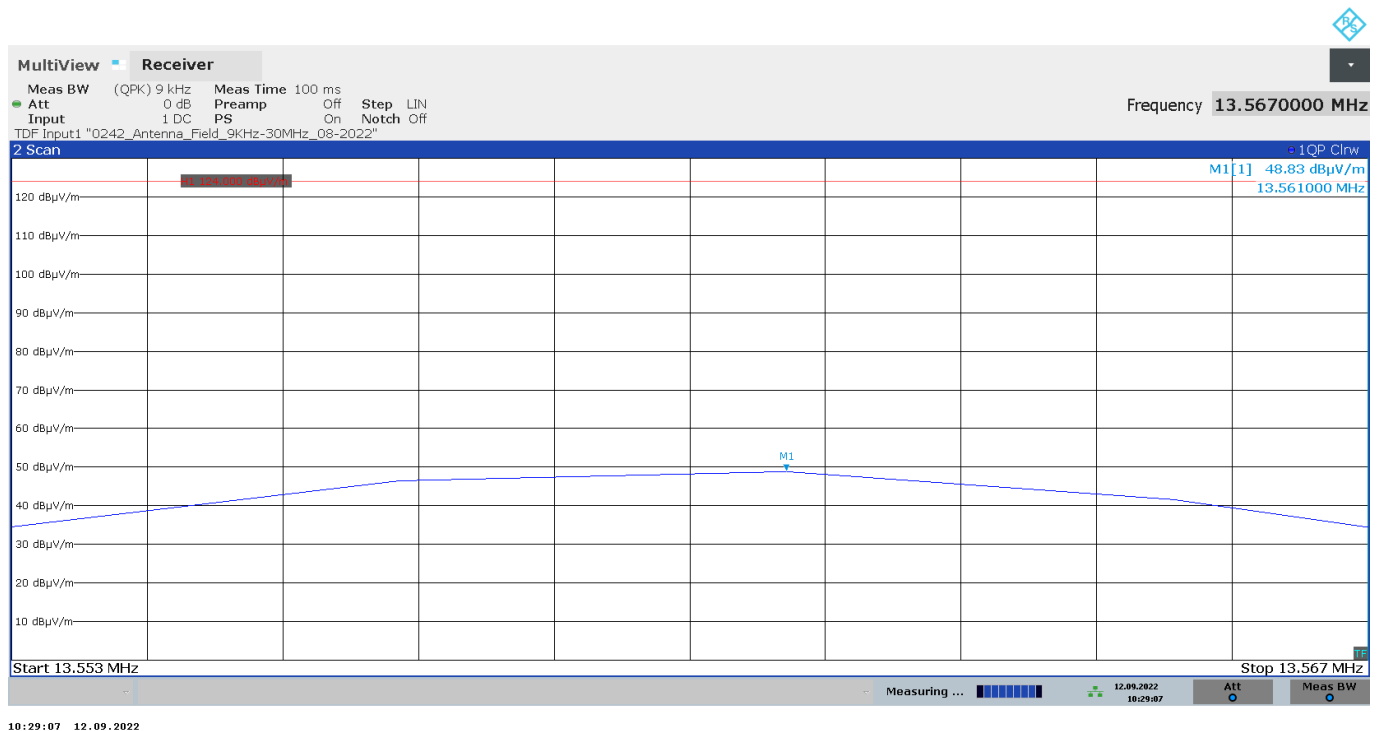

The limit shown in the above plot is extrapolated to 3 meters.

Frequency (MHz)	Maximum field strength (dB $\mu$ V/m) measured at 3 m (quasi-peak detector)	Maximum field strength (dB $\mu$ V/m) extrapolated to 30 m (40 dB/decade)
13.561	48.83	8.83
Measurement uncertainty (dB)	$\pm 3.04$	

Verdict: PASS



- **NFC mode ISO 15693:**

**Band 13.553 - 13.567 MHz:**

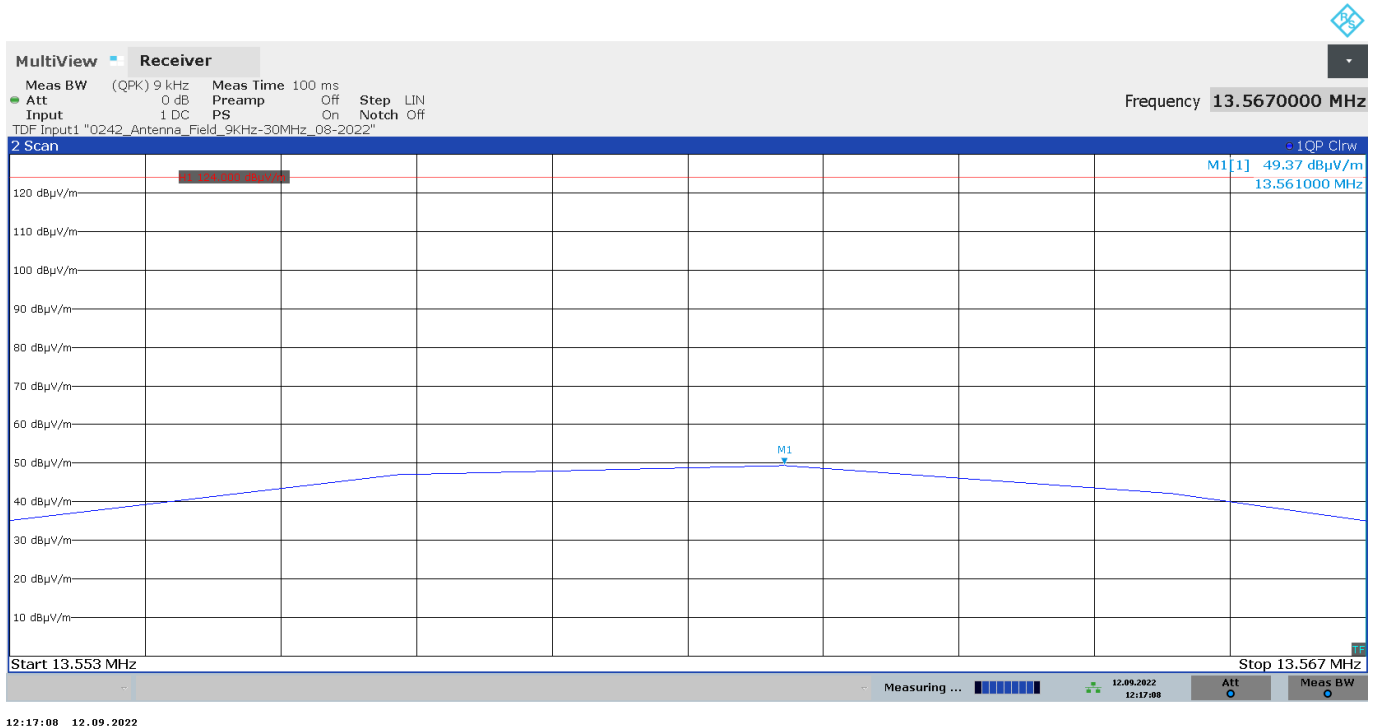

12:17:08 12.09.2022

The limit shown in the above plot is extrapolated to 3 meters.

Frequency (MHz)	Maximum field strength (dBµV/m) measured at 3 m (quasi-peak detector)	Maximum field strength (dBµV/m) extrapolated to 30 m (40 dB/decade)
13.561	49.37	9.37
Measurement uncertainty (dB)	<±3.04	

Verdict: PASS

## FCC 15.225 (b) / RSS-210 B.6 (a)(ii) Field Strength of Emissions within the band 13.410 MHz -13.553 MHz and 13.567 MHz - 13.710 MHz

### SPECIFICATION:

Within the bands 13.410-13.553 MHz and 13.567-13.710 MHz, the field strength of any emissions shall not exceed 334 microvolts/meter (50.47 dB $\mu$ V/m) at 30 meters.

### RESULTS:

Measurement distance: 3 meters.

- **NFC mode ISO 14443A:**

#### Band 13.410 - 13.553 MHz:

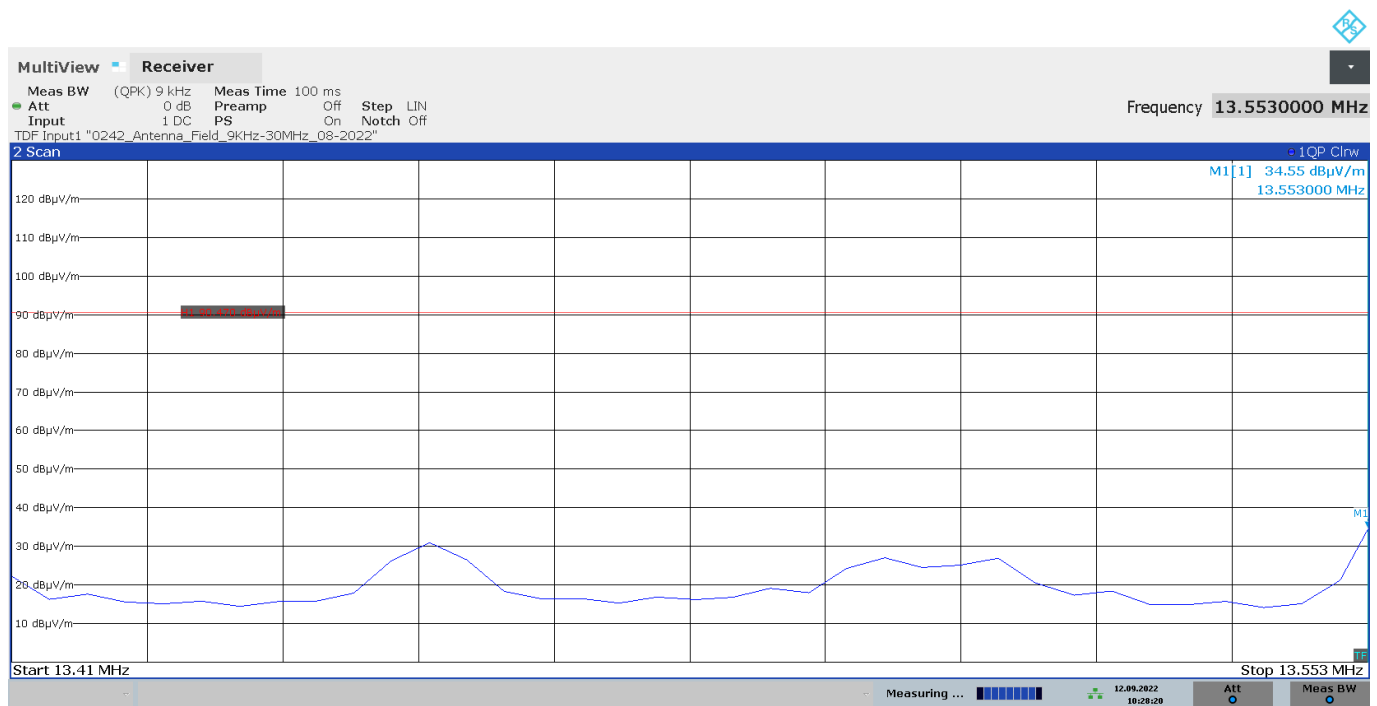

10:28:21 12.09.2022

The limit shown in the above plot is extrapolated to 3 meters.

Frequency (MHz)	Maximum field strength (dB $\mu$ V/m) measured at 3 m (quasi-peak detector)	Maximum field strength (dB $\mu$ V/m) extrapolated to 30 m (40 dB/decade)
13.553	34.55	-5.45
Measurement uncertainty (dB)	$\pm 3.04$	

Verdict: PASS

**Band 13.567 - 13.710 MHz:**

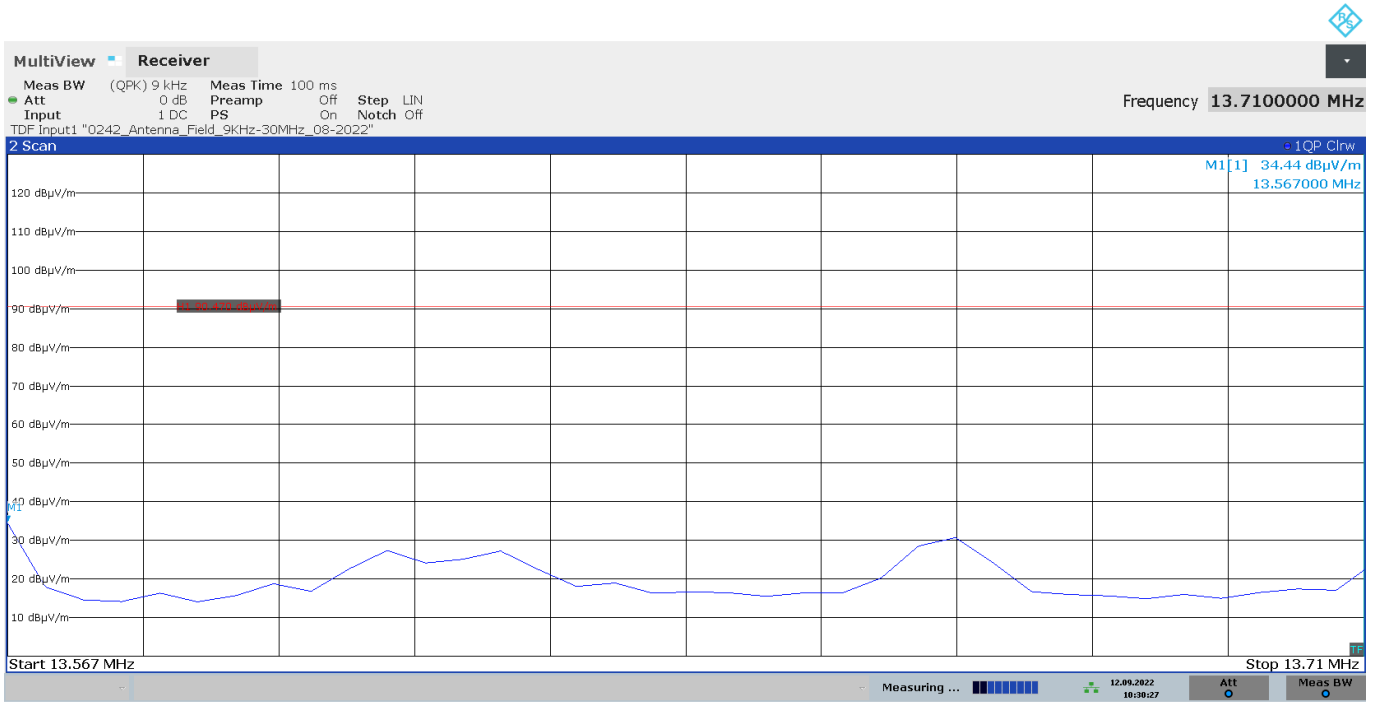

10:30:28 12.09.2022

The limit shown in the above plot is extrapolated to 3 meters.

Frequency (MHz)	Maximum field strength (dBµV/m) measured at 3 m (quasi-peak detector)	Maximum field strength (dBµV/m) extrapolated to 30 m (40 dB/decade)
13.567	34.44	-5.56
Measurement uncertainty (dB)	<±3.04	

Verdict: PASS

- **NFC mode ISO 15693:**

**Band 13.410 - 13.553 MHz:**

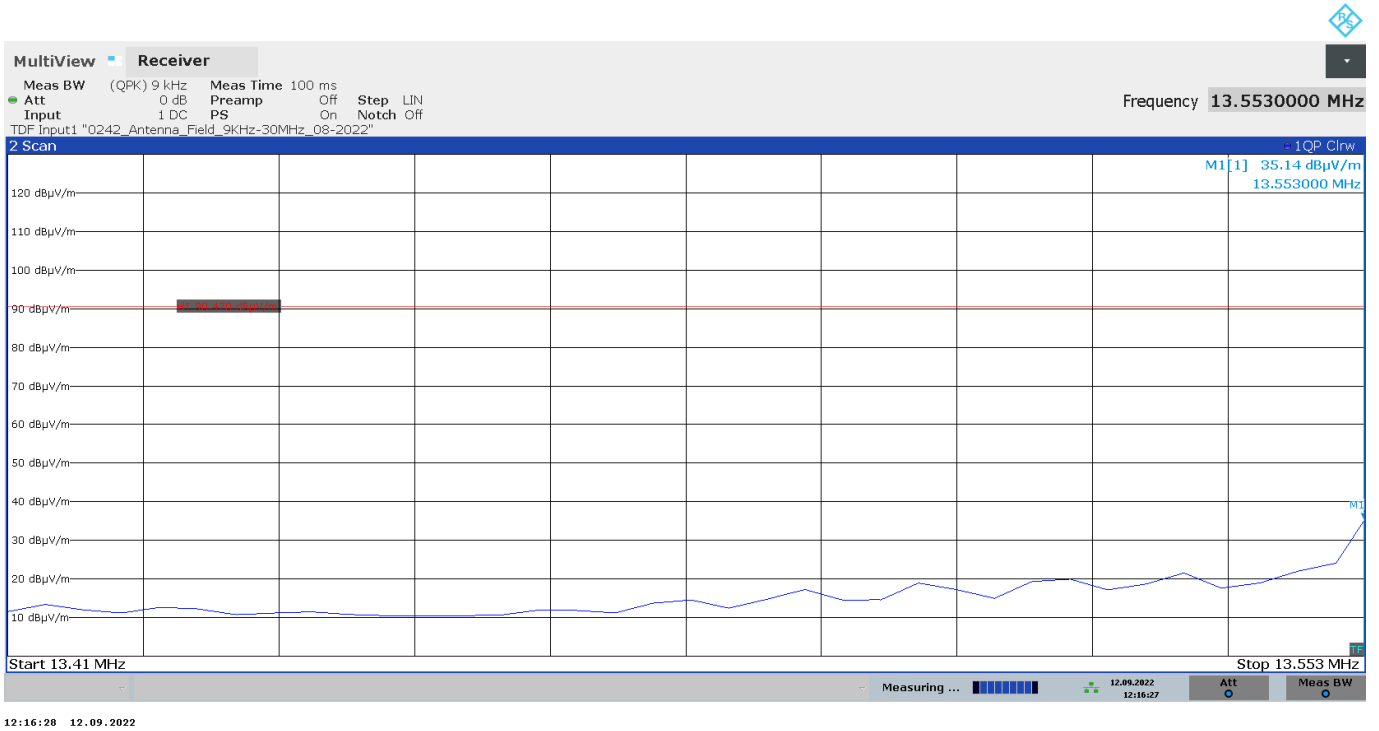

The limit shown in the above plot is extrapolated to 3 meters.

Frequency (MHz)	Maximum field strength (dBµV/m) measured at 3 m (quasi-peak detector)	Maximum field strength (dBµV/m) extrapolated to 30 m (40 dB/decade)
13.553	35.14	-4.86
Measurement uncertainty (dB)	<±3.04	

Verdict: PASS

**Band 13.567 - 13.710 MHz:**

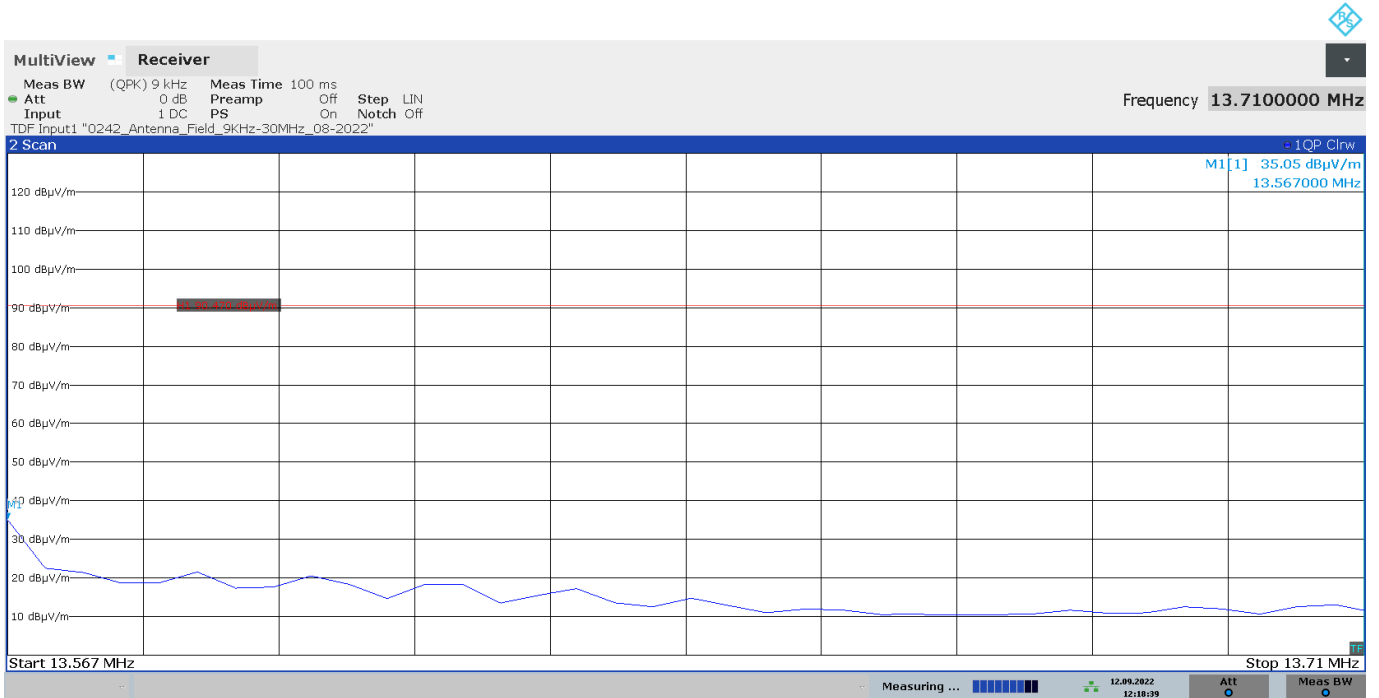

The limit shown in the above plot is extrapolated to 3 meters.

Frequency (MHz)	Maximum field strength (dBµV/m) measured at 3 m (quasi-peak detector)	Maximum field strength (dBµV/m) extrapolated to 30 m (40 dB/decade)
13.567	35.05	-4.95
Measurement uncertainty (dB)	<±3.04	

Verdict: PASS

## FCC 15.225 (c) / RSS-210 B.6 (a)(iii) Field Strength of Emissions within the band 13.110 MHz -13.410 MHz and 13.710 MHz - 14.010 MHz

**SPECIFICATION:**

Within the bands 13.110-13.410 MHz and 13.710-14.010 MHz, the field strength of any emissions shall not exceed 106 microvolts/meter (40.51 dBµV/m) at 30 meters.

**RESULTS:**

Measurement distance: 3 meters.

- **NFC mode ISO 14443A:**

**Band 13.110 - 13.410 MHz:**

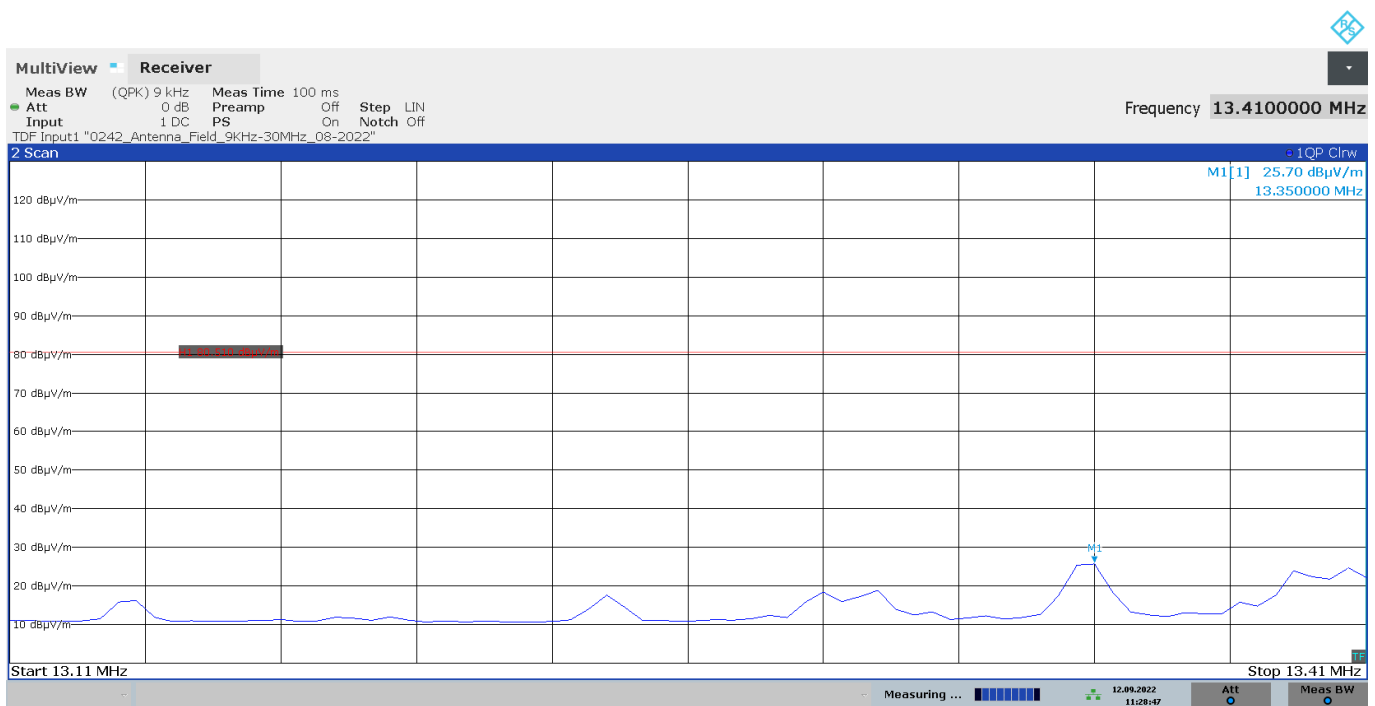

11:28:47 12.09.2022

The limit shown in the above plot is extrapolated to 3 meters.

Frequency (MHz)	Maximum field strength (dBµV/m) measured at 3 m (quasi-peak detector)	Maximum field strength (dBµV/m) extrapolated to 30 m (40 dB/decade)
13.350	25.7	-14.3
Measurement uncertainty (dB)	<±3.04	

Verdict: PASS

**Band 13.710 - 14.010 MHz:**

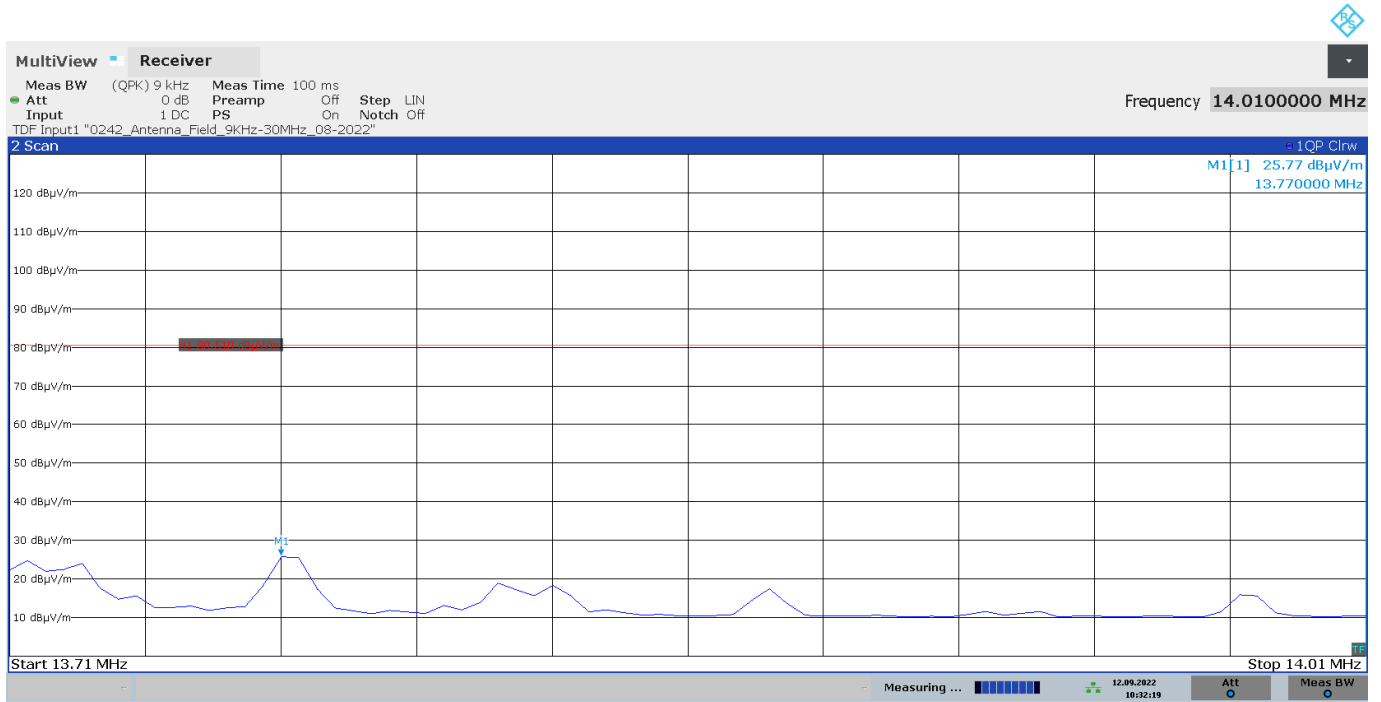

10:32:20 12.09.2022

The limit shown in the above plot is extrapolated to 3 meters.

Frequency (MHz)	Maximum field strength (dBµV/m) measured at 3 m (quasi-peak detector)	Maximum field strength (dBµV/m) extrapolated to 30 m (40 dB/decade)
13.770	25.77	-14.23
Measurement uncertainty (dB)	±3.04	

Verdict: PASS

- **NFC mode ISO 15693:**

**Band 13.110 - 13.410 MHz:**

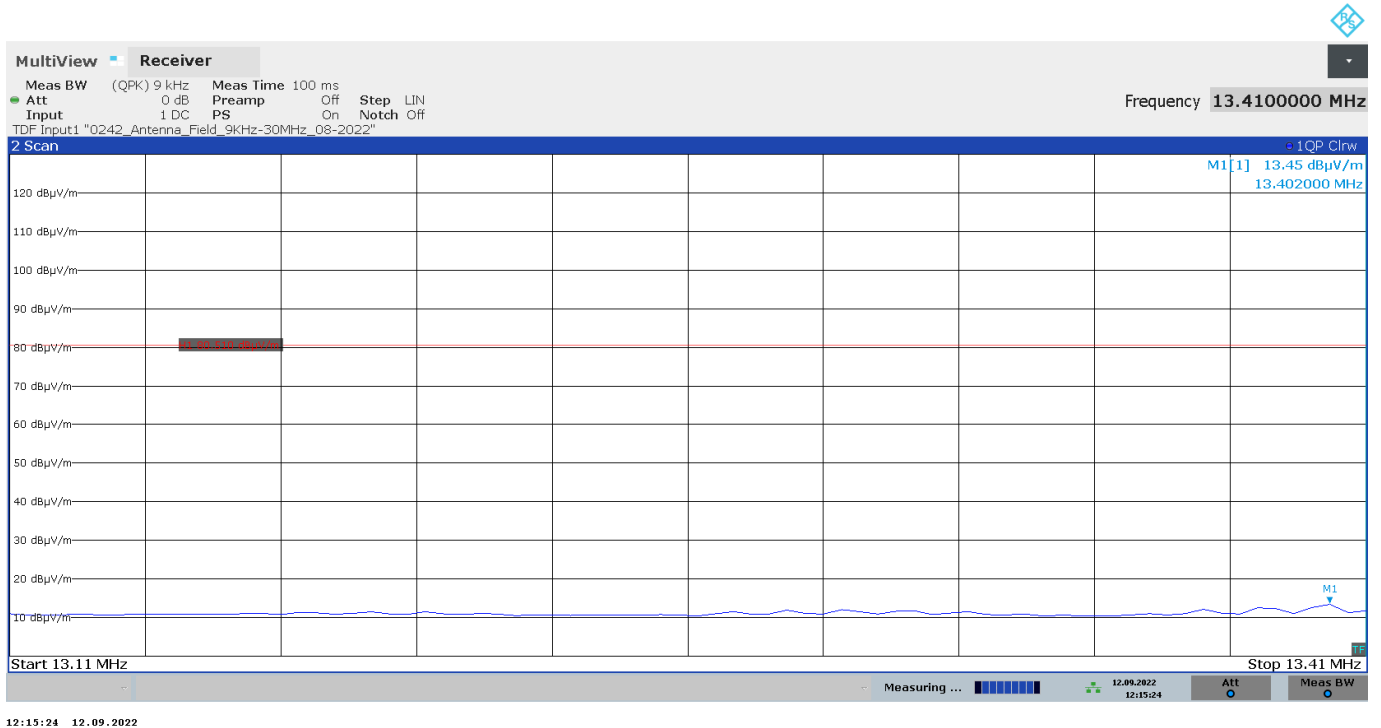

12:15:24 12.09.2022

The limit shown in the above plot is extrapolated to 3 meters.

Frequency (MHz)	Maximum field strength (dBµV/m) measured at 3 m (quasi-peak detector)	Maximum field strength (dBµV/m) extrapolated to 30 m (40 dB/decade)
13.402	13.45	-26.55
Measurement uncertainty (dB)	<±3.04	

Verdict: PASS



**Band 13.710 - 14.010 MHz:**

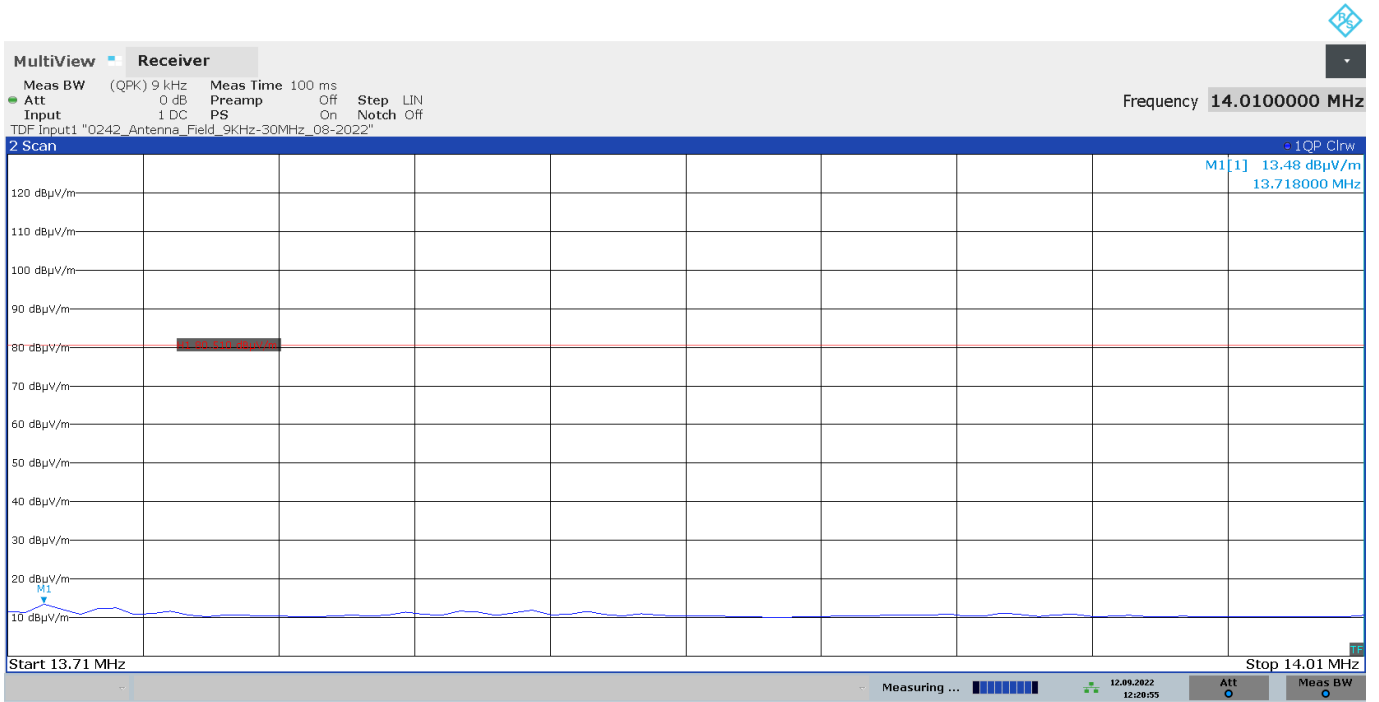

12:20:56 12.09.2022

The limit shown in the above plot is extrapolated to 3 meters.

Frequency (MHz)	Maximum field strength (dBµV/m) measured at 3 m (quasi-peak detector)	Maximum field strength (dBµV/m) extrapolated to 30 m (40 dB/decade)
13.718	13.48	-26.52
Measurement uncertainty (dB)	±3.04	

Verdict: PASS

## FCC 15.225 (d) / RSS-210 B.6 (a)(iv) Field Strength of Emissions outside of the band 13.110 MHz - 14.010 MHz

### SPECIFICATION:

Field strength of any emissions appearing outside of the band 13.110 MHz - 14.010 MHz band shall not exceed the general radiated emission limits in 15.209/RSS-Gen:

Frequency Range (MHz)	Field strength ( $\mu\text{V/m}$ )	Field strength ( $\text{dB}\mu\text{V/m}$ )	Measurement distance (m)
0.009-0.490	2400/F(kHz)	-	300
0.490-1.705	24000/F(kHz)	-	30
1.705 - 30.0	30	29.54	30
30 - 88	100	40	3
88 - 216	150	43.5	3
216 - 960	200	46	3
Above 960	500	54	3

### RESULTS:

All tests were performed in a semi-anechoic chamber at a distance of 3 m.

The spectrum was inspected from 9 kHz to 200 MHz searching for spurious signals.

The field strength is calculated by adding correction factor to the measured level from the spectrum analyzer. This correction factor includes antenna factor, cable loss and pre-amplifier gain.

- **NFC mode ISO 14443A:**

**Frequency range 9 kHz - 30 MHz:**

No spurious frequencies detected at less than 20 dB below the limit.

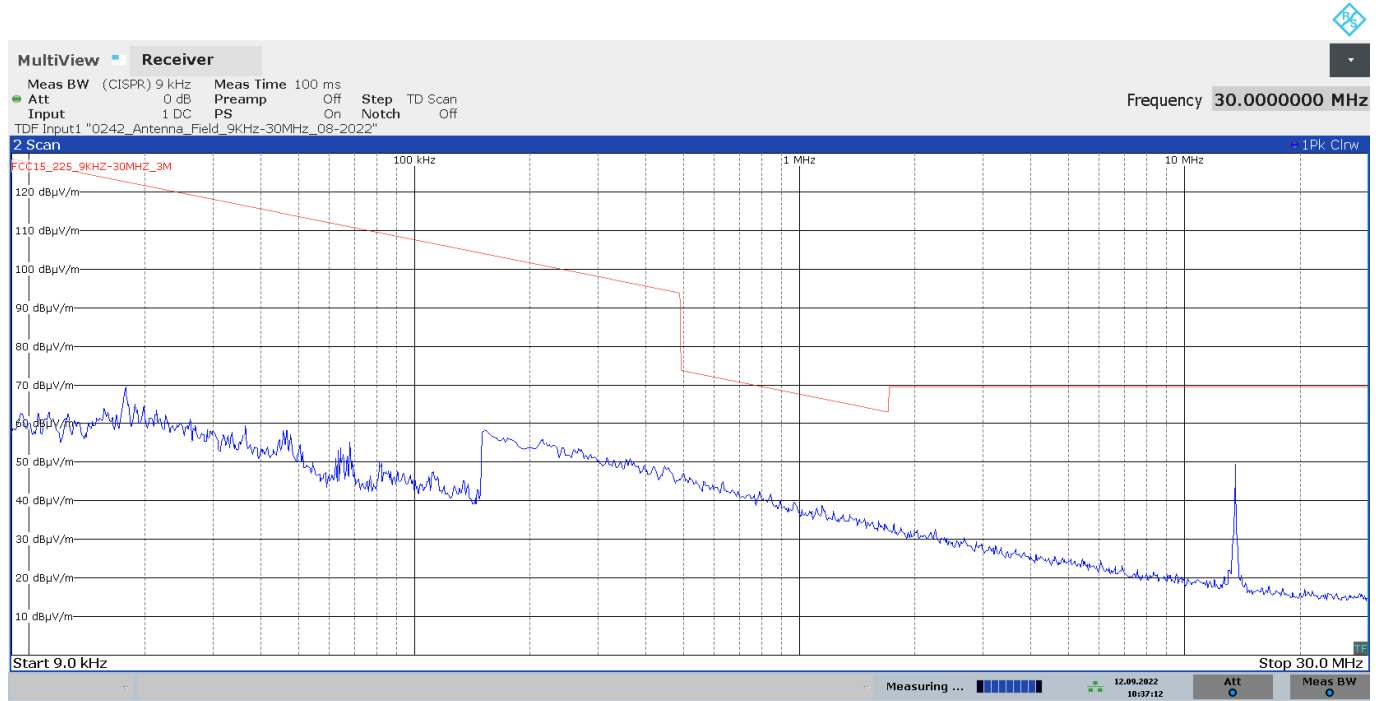

10:37:12 12.09.2022

The limits shown in this plot are extrapolated to 3 m. The highest peak is the carrier frequency.

Resolution bandwidth:  
 200 Hz for 9 kHz ≤ f ≤ 150 kHz  
 9 kHz for 150 kHz ≤ f ≤ 30 MHz

Measurement Uncertainty (dB) <± 3.04

### Frequency range 30 - 200 MHz:

No spurious frequencies detected at less than 20 dB below the limit.

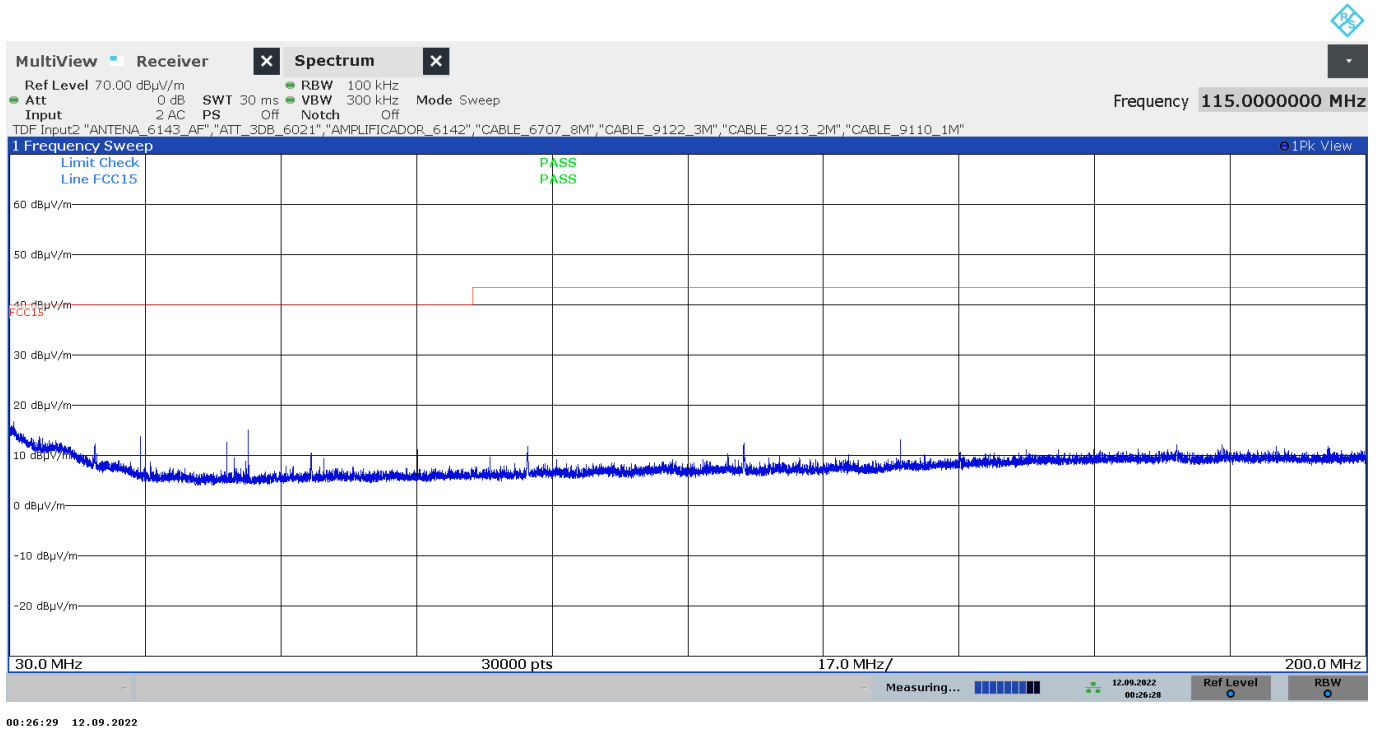

This plot shows the results of the scan using peak detector.

Measurement Uncertainty (dB)  $<\pm 4.68$

- **NFC mode ISO 15693:**

**Frequency range 9 kHz - 30 MHz:**

No spurious frequencies detected at less than 20 dB below the limit.

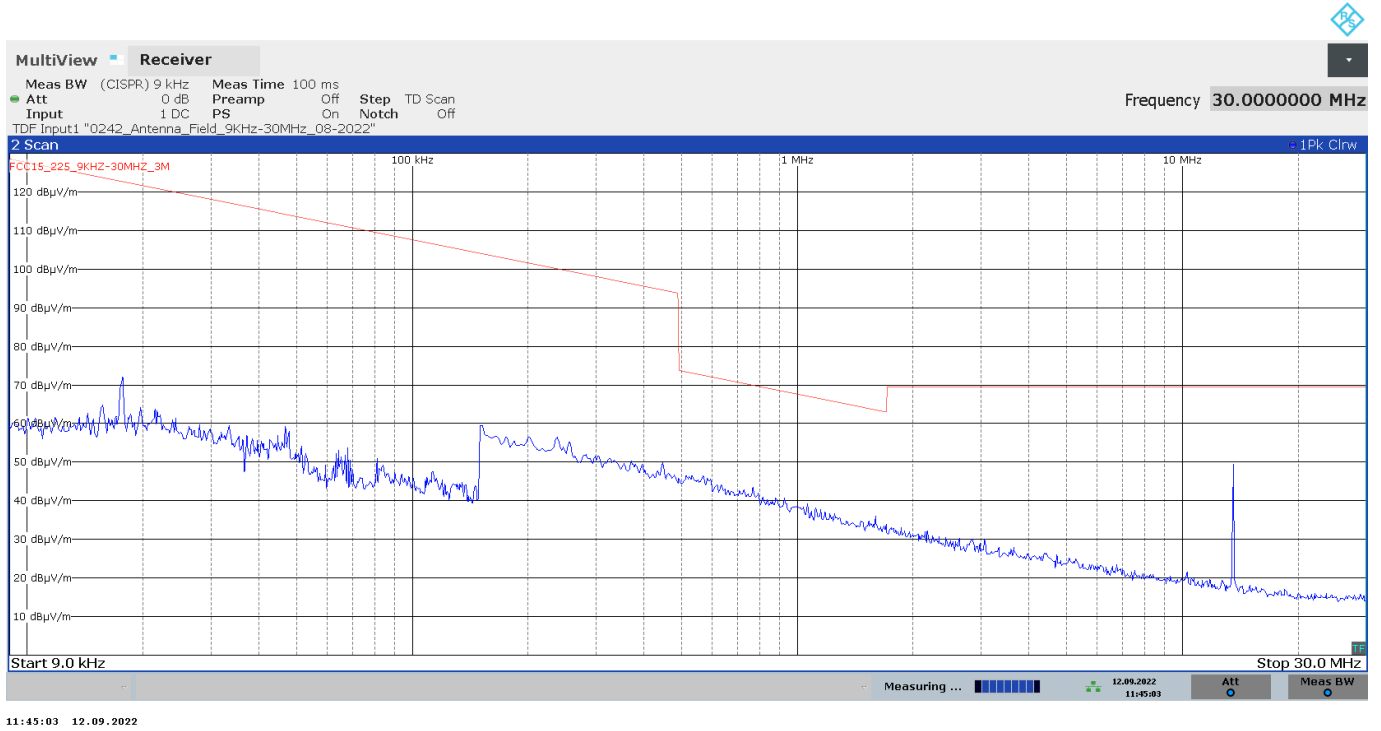

The limits shown in this plot are extrapolated to 3 m. The highest peak is the carrier frequency.

Resolution bandwidth:  
 200 Hz for 9 kHz ≤ f ≤ 150 kHz  
 9 kHz for 150 kHz ≤ f ≤ 30 MHz

Measurement Uncertainty (dB) <± 3.04

### Frequency range 30 - 200 MHz:

No spurious frequencies detected at less than 20 dB below the limit.

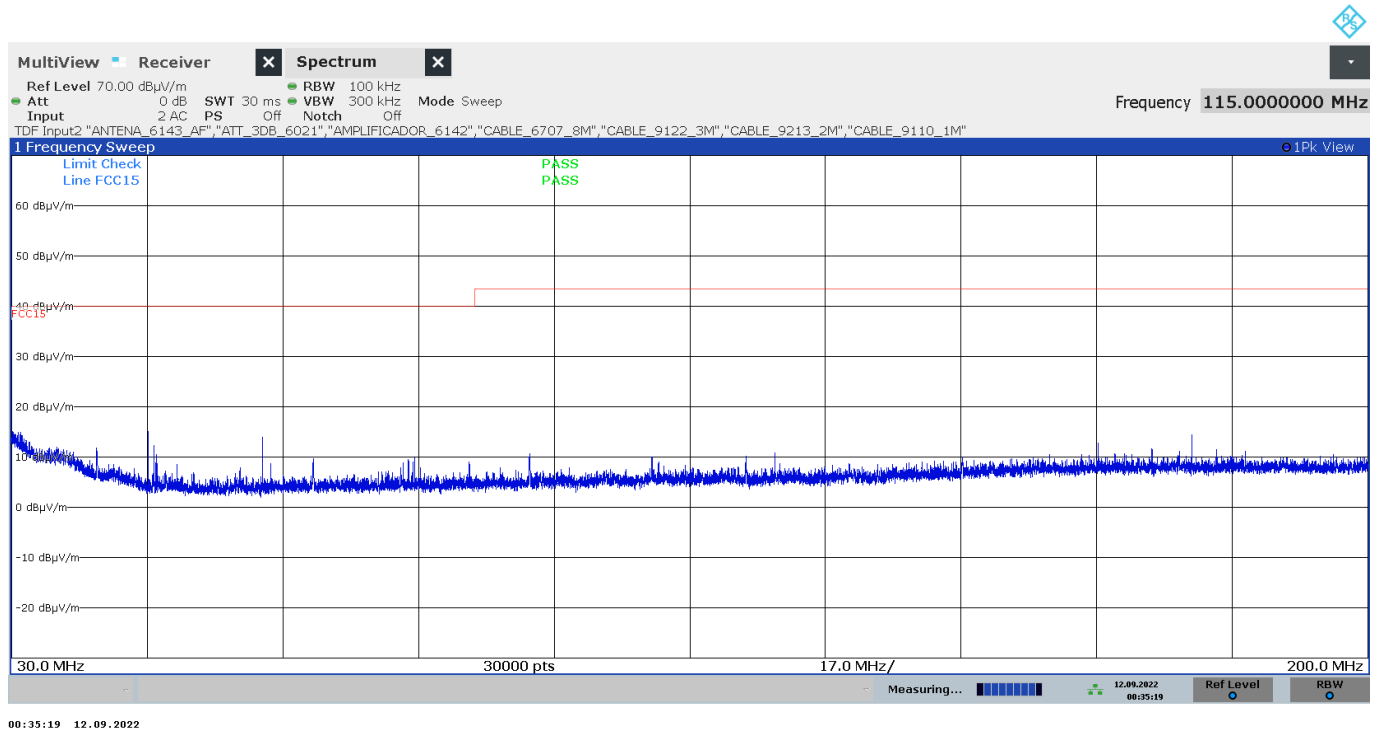

This plot shows the results of the scan using peak detector.

Measurement Uncertainty (dB)  $< \pm 4.68$

Verdict: PASS

## FCC 15.225 (e) / RSS-210 B.6 (b) Frequency Tolerance of the Carrier Signal

**SPECIFICATION:**

The frequency tolerance of the carrier signal shall be maintained within +/- 0.01% of the operating frequency over a temperature variation of -20 degrees to +50 degrees C at normal supply voltage, and for a variation in the primary supply voltage from 85% to 115% of the rated supply voltage at a temperature of 20 degrees C. For hand carried, battery powered equipment, reduce primary supply voltage to the battery operating end point which shall be specified by the manufacturer.

**RESULTS:**

Nominal Operating Frequency: 13.56 MHz.

- **NFC mode ISO 14443A:**
- **Frequency Stability over Temperature Variations:**

Temperature (°C)	Frequency Error (kHz)	Frequency Error (%)
+50	0.043850	0.000323
+40	0.052850	0.000390
+30	0.034850	0.000257
+20	0.025350	0.000187
+10	0.001150	0.000008
0	0.399765	0.002948
-10	0.061200	0.000451
-20	0.071700	0.000529

- **Frequency Stability over Voltage Variations:**

DC Voltage	Voltage (V)	Temperature (°C)	Frequency Error (kHz)	Frequency Error (%)
Vmax	4.95	20	0.043850	0.000323
Vmin	3.825	20	0.052850	0.000390

- **NFC mode ISO 15693:**

- **Frequency Stability over Temperature Variations:**

Temperature (°C)	Frequency Error (kHz)	Frequency Error (%)
+50	0.048350	0.000357
+40	0.051350	0.000379
+30	0.438650	0.003235
+20	0.016750	0.000124
+10	0.008700	0.000064
0	0.032700	0.000241
-10	0.062700	0.000462
-20	0.070200	0.000518

- **Frequency Stability over Voltage Variations:**

DC Voltage	Voltage (V)	Temperature (°C)	Frequency Error (kHz)	Frequency Error (%)
Vmax	3.825	20	0.048350	0.000357
Vmin	4.95	20	0.051350	0.000379

Verdict: PASS