

ISED CABid: ES1909

Test Report No:

Lab. Company Number: 4621A

72667RRF.005

Test Report

USA FCC Part 15.225, 15.209

CANADA RSS-210, RSS-Gen

| | |
|---|--|
| (*) Identification of item tested | SALTO DBolt Auto electronic lock series including all mechanical variants |
| (*) Trademark | SALTO |
| (*) Model and/or type reference | DZ0M / (Type reference: E2133) |
| Other identification of the product | FCC ID: UKCDZ0M IC: 10088A-DZ0M |
| (*) Features | Features: Bluetooth LE HW version: 1.0 SW version: 0190 (Control FW), 0209 (Motor FW) 0186 (FUS FW), 0187 (BLE FW) |
| Applicant | SALTO SYSTEMS, S.L. Arkotz 9, Polígono Lanbarren 20180, Oiartzun, Gipuzkoa, SPAIN |
| Test method requested, standard | USA FCC Part 15.225 (10-1-21 Edition): Operation within the band 13.110 -14.010. USA FCC Part 15.209 (10-1-21 Edition): Radiated emission limits, general requirements. CANADA RSS-210 Issue 10 (December 2019). CANADA RSS-Gen Issue 5 amendment 2 (February 2021). ANSI C63.10-2013: American National Standard for Testing Unlicensed Wireless Devices. |
| Summary | IN COMPLIANCE |
| Approved by (name / position & signature) | José Manuel Gómez Galván EMC Consumer & RF Lab. Manager |
| Date of issue | 2023-05-16 |
| Report template No | FDT08_24 (*) "Data provided by the client" |

Index

| | |
|------------------------------------|---|
| Competences and guarantees | 3 |
| General conditions | 3 |
| Uncertainty..... | 3 |
| Data provided by the client | 4 |
| Usage of samples | 4 |
| Test sample description | 5 |
| Identification of the client | 6 |
| Testing period and place | 6 |
| Document history..... | 6 |
| Environmental conditions | 6 |
| Remarks and comments..... | 7 |
| Testing verdicts..... | 8 |
| Summary | 8 |
| Appendix A: Test results..... | 9 |

Competences and guarantees

DEKRA Testing and Certification S.A.U. is a testing laboratory accredited by the National Accreditation Body (ENAC -Entidad Nacional de Acreditación), to perform the tests indicated in the Certificate No. 51/LE 147.

DEKRA Testing and Certification is a FCC-recognized accredited testing laboratory with appropriate scope of accreditation that covers the performed tests in this report.

DEKRA Testing and Certification is an ISED-recognized accredited testing laboratory, CABid: ES1909, Company Number: 4621A, with the appropriate scope of accreditation that covers the performed tests in this report.

In order to assure the traceability to other national and international laboratories, DEKRA Testing and Certification has a calibration and maintenance program for its measurement equipment.

DEKRA Testing and Certification guarantees the reliability of the data presented in this report, which is the result of the measurements and the tests performed to the item under test on the date and under the conditions stated on the report and, it is based on the knowledge and technical facilities available at DEKRA Testing and Certification at the time of performance of the test.

DEKRA Testing and Certification is liable to the client for the maintenance of the confidentiality of all information related to the item under test and the results of the test.

The results presented in this Test Report apply only to the particular item under test established in this document.

IMPORTANT: No parts of this report may be reproduced or quoted out of context, in any form or by any means, except in full, without the previous written permission of DEKRA Testing and Certification.

General conditions

1. This report is only referred to the item that has undergone the test.
2. This report does not constitute or imply on its own an approval of the product by the Certification Bodies or competent Authorities.
3. This document is only valid if complete; no partial reproduction can be made without previous written permission of DEKRA Testing and Certification.
4. This test report cannot be used partially or in full for publicity and/or promotional purposes without previous written permission of DEKRA Testing and Certification and the Accreditation Bodies.

Uncertainty

Uncertainty (factor $k=2$) was calculated according to the DEKRA Testing and Certification internal document PODT000.

The total uncertainty of the measurement system for the radiated emissions of EUT from 9 kHz to 30 MHz is:
Measurement uncertainty $\leq \pm 3.08$ dB (with factor $k = 2$).

The total uncertainty of the measurement system for the radiated emissions of EUT from 30 MHz to 200 MHz is:
Measurement uncertainty $\leq \pm 5.35$ dB (with factor $k = 2$).

The total uncertainty of the measurement system for the conducted testing of EUT is:
Frequency Tolerance of the Carrier Signal: Measurement uncertainty $\leq \pm 12.3$ kHz
Occupied Bandwidth $\leq \pm 1.70$ kHz
Field strength of emissions within the band $\leq \pm 3.44$ dB

Data provided by the client

The following data has been provided by the client:

1. Information relating to the description of the sample ("Identification of the item tested", "Trademark", "Model and/or type reference tested").
2. The sample consists of a SALTO DBolt Auto electronic lock series with RFID Mifare (ISO 14443A & ISO 15693 standard based) and Bluetooth LE technology.

DEKRA Testing and Certification S.A.U. declines any responsibility with respect to the information provided by the client and that may affect the validity of results.

Usage of samples

Samples undergoing test have been selected by: The client.

| Id | Control Number | Description | Model | Serial N° | Date of Reception | Application |
|------|----------------|----------------------------------|-------|-----------|-------------------|--------------------|
| S/01 | 72667_46.1 | SALTO DBolt Auto electronic lock | DZ0M | -- | 2023-03-13 | Element Under Test |
| S/02 | 72667_42.1 | SALTO DBolt Auto electronic lock | DZ0M | -- | 2023-03-13 | Element Under Test |

Notes referenced to samples during the project:

| Id | Type |
|------|-----------------------------------|
| S/01 | Sample used for radiated testing |
| S/02 | Sample used for conducted testing |

Test sample description

| | | | | | |
|--|---|--|----------------------|---------------|-----------------------------------|
| Ports..... : | Port name and description | Cable | | | |
| | | Specified max length [m] | Attached during test | Shielded | Coupled to patient ⁽³⁾ |
| | -- | | [] | [] | [] |
| Supplementary information to the ports..... : | | | | | |
| Rated power supply..... : | Voltage and Frequency | | Reference poles | | |
| | | | L1 | L2 | L3 |
| | [] | AC: | [] | [] | [] |
| | [X] | DC: 6 Vdc (4 x LR6 batteries), 6.5 Vmax, 4.25/4 Vmin | | | |
| Rated Power..... : | | | | | |
| Clock frequencies..... : | 32 MHz, 32.768 kHz, 27.12 MHz | | | | |
| Other parameters..... : | N/A | | | | |
| Software version..... : | 0190 (Control FW) + 0209 (Motor FW) + 0186 (FUS FW) + 0187 (BLE FW) | | | | |
| Hardware version..... : | 1.0 | | | | |
| Dimensions in cm (W x H x D)..... : | Reader: 6.8 x 16 x 3.15 cm; Control: 7.2 x 14.6 x 5.75 cm | | | | |
| Mounting position..... : | [] | Table top equipment | | | |
| | [] | Wall/Ceiling mounted equipment | | | |
| | [] | Floor standing equipment | | | |
| | [] | Hand-held equipment | | | |
| | [X] | Other: door mounting | | | |
| Modules/parts..... : | Module/parts of test item | | Type | Manufacturer | |
| | SoC + Antenna | | BLE | ST + JOHANSON | |
| | | | | | |
| Accessories (not part of the test item)..... : | Description | | Type | Manufacturer | |
| | -- | | | | |
| Documents as provided by the applicant..... : | Description | | File name | Issue date | |
| | -- | | | | |

⁽³⁾ Only for Medical Equipment

Identification of the client

SALTO SYSTEMS, S.L.
Arkotz 9, Polígono Lanbarren
20180, Oiartzun, Gipuzkoa, SPAIN

Testing period and place

| | |
|----------------------|--|
| Test Location | DEKRA Testing and Certification S.A.U. |
| Date (start) | 2023-03-28 |
| Date (finish) | 2023-04-04 |

Document history

| Report number | Date | Description |
|---------------|------------|----------------|
| 72667RRF.005 | 2023-05-16 | First release. |

Environmental conditions

In the control chamber, the following limits were not exceeded during the test:

| | |
|--------------------------|------------------------------|
| Temperature | Min. = 15 °C Max. = 35 °C |
| Relative humidity | Min. = 20 % Max. = 75 % |

In the semianechoic chamber, the following limits were not exceeded during the test.

| | |
|--------------------------|------------------------------|
| Temperature | Min. = 15 °C Max. = 35 °C |
| Relative humidity | Min. = 20 % Max. = 75 % |

In the chamber for conducted measurements, the following limits were not exceeded during the test:

| | |
|--------------------------|------------------------------|
| Temperature | Min. = 15 °C Max. = 35 °C |
| Relative humidity | Min. = 20 % Max. = 75 % |

Remarks and comments

The tests have been performed by the technical personnel: Jose Manuel Jimenez and Rafael Fernandez.

Used instrumentation:

| Control No. | Equipment | Model | Manufacturer | Next Calibration |
|-------------|--|----------------|-------------------|------------------|
| 4825 | SEMIANECHOIC ABSORBER LINED CHAMBER | FACT 3 200 STP | ETS LINDGREN | N/A |
| 4826 | SHIELDED ROOM | S101 | ETS LINDGREN | N/A |
| 0242 | ACTIVE LOOP ANTENNA 9 KHZ-30 MHz | 11966A | HEWLETT PACKARD | 2024-08-18 |
| 4578 | HYBRID BILOG ANTENNA 30MHz-6GHz | 3142E | ETS LINDGREN | 2023-04-30 |
| 6142 | PRE-AMPLIFIER G>38dB 30MHz-6GHz | BLNA 0360-01N | BONN ELEKTRONIK | 2023-06-16 |
| 6165 | EMI TEST RECEIVER 9kHz-7GHz | ESR7 | ROHDE AND SCHWARZ | 2023-11-08 |
| 4716 | SIGNAL AND SPECTRUM ANALYZER 2Hz-50GHz | FSW50 | ROHDE AND SCHWARZ | 2024-08-12 |
| 6208 | DC POWER SUPPLY | GPS-3030D | GW INSTEK | N/A |
| 5850 | DIGITAL MULTIMETER | 175 | FLUKE | 2023-11-02 |
| 8002 | TEMPERATURE CHAMBER | MK 56 | BINDER | 2024-03-21 |

Testing verdicts

| | |
|----------------|-----|
| Fail | F |
| Inconclusive | I |
| Not applicable | N/A |
| Not measured | N/M |
| Pass | P |

Summary

| FCC PART 15 PARAGRAPH / RSS-210 | | |
|---|---------|--------|
| Requirement – Test case | Verdict | Remark |
| FCC 15.225 (a) / RSS-210 B.6 (a)(i) Field strength of emissions within the band 13.553 MHz -13.567 MHz | P | -- |
| FCC 15.225 (b) / RSS-210 B.6 (a)(ii) Field strength of emissions within the band 13.410 - 13.553 MHz and 13.567 – 13.710 MHz | P | -- |
| FCC 15.225 (c) / RSS-210 B.6 (a)(iii) Field strength of emissions within the band 13.110 - 13.410 MHz and 13.710 – 14.010 MHz | P | -- |
| FCC 15.225 (d) / RSS-210 B.6 (a)(iv) Field strength of emissions outside of the band 13.110 MHz -14.010 MHz | P | -- |
| FCC 15.225 (e) / RSS-210 B.6 (b) Frequency tolerance of the carrier signal | P | -- |
| <u>Supplementary information and remarks:</u> None. | | |

Appendix A: Test results

INDEX

| | |
|---|----|
| TEST CONDITIONS | 11 |
| Occupied Bandwidth | 14 |
| FCC 15.225 (a) / RSS-210 B.6 (a). Field strength of emissions within the band 13.553 -13.567 MHz | 16 |
| FCC 15.225 (b) / RSS-210 B.6 (b). Field strength of emissions within the band 13.410 - 13.553 MHz and 13.567 - 13.710 MHz | 18 |
| FCC 15.225 (c) / RSS-210 B.6 (c). Field strength of emissions within the band 13.110 - 13.410 MHz and 13.710 - 14.010 MHz..... | 22 |
| FCC 15.225 (d) / RSS-210 B.6 (a)(iv) Field Strength of Emissions outside of the band 13.110 MHz - 14.010 MHz | 26 |
| FCC 15.225 (e) / RSS-210 B.6 (b) Frequency Tolerance of the Carrier Signal | 31 |

TEST CONDITIONS

(*) Data provided by the Applicant.

POWER SUPPLY (*):

| | |
|-----------------------|--------------------|
| Vnominal: | 6Vdc |
| Vminimum: | 5.1Vdc |
| Vmaximum: | 6.9Vdc |
| Type of Power Supply: | 4 x LR06 batteries |

ANTENNA (*):

| | |
|--------------------------------|----------------|
| Type of Antenna: | Integral (PCB) |
| Maximum Declared Antenna Gain: | N/A |

TEST FREQUENCY (*):

Nominal Operating Frequency: 13.56 MHz

CONDUCTED MEASUREMENTS:

The equipment under test was set up in a shielded room and it is directly connected to the spectrum analyzer.

For frequency stability test the EUT was placed inside a climatic chamber and connected to a frequency meter using a low loss cable. An external DC power supply was connected to the EUT for voltage variation test.

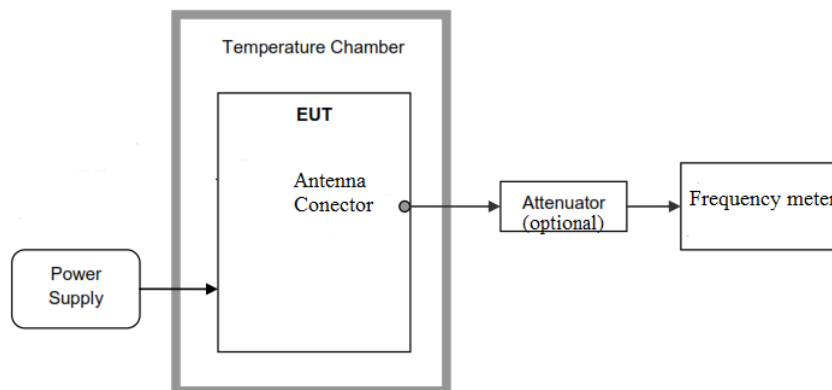

RADIATED MEASUREMENTS:

All radiated tests were performed in a semi-anechoic chamber. The measurement antenna (Loop antenna for the range between 9 kHz to 30 MHz and Bilog antenna for the range between 30 MHz to 200 MHz) is situated at a distance of 3 m.

For radiated emissions in the range 9 kHz to 30 MHz that is performed at a distance closer than the specified distance, an inverse proportionality factor of 40 dB per decade is used to normalize the measured data for determining compliance.

The equipment under test was set up on a non-conductive platform above the ground plane and the situation and orientation was varied to find the maximum radiated emission. It was also rotated 360° and in the range between 30 MHz and 200 MHz the antenna height was varied from 1 to 4 meters to find the maximum radiated emission. In the range between 9 kHz and 30 MHz the measurements were made in the three different orientation planes of the loop antenna to determine the maximum received field. In the range between 30 MHz and 200 MHz the measurements were made in both horizontal and vertical planes of polarization.

Radiated measurements setup 9 kHz to 30 MHz:

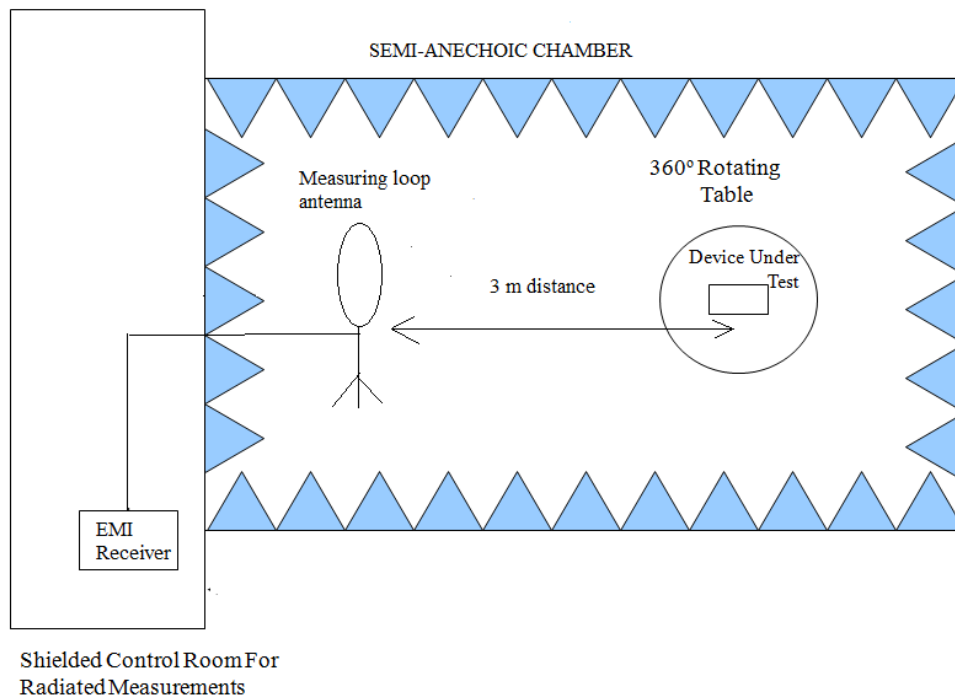

Radiated measurements setup 30 MHz to 200 MHz:

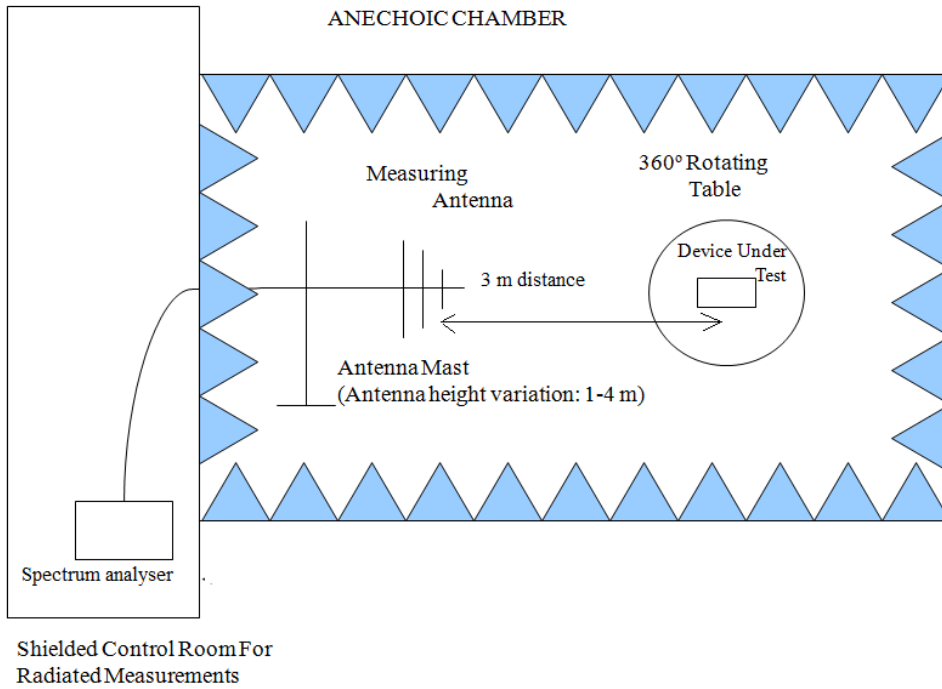

Occupied Bandwidth

RESULTS:

99 % Occupied Bandwidth and 20 dB Bandwidth.

- RFID mode ISO 1443A:

| Operation mode | 99% Occupied Bandwidth (kHz) | 20 dB Bandwidth (kHz) |
|-------------------------------|------------------------------|-----------------------|
| RFID 13.56 MHz mode ISO 1443A | 570.80 | 236.00 |

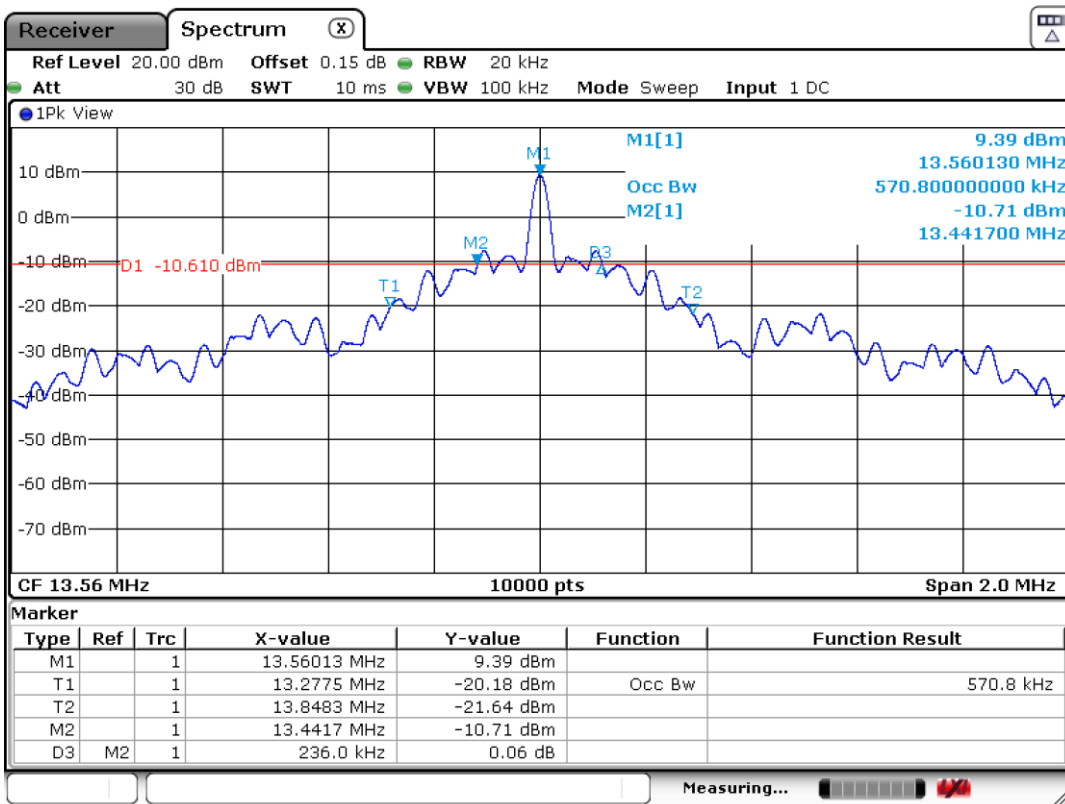

- RFID mode ISO 15693:

| Operation mode | 99% Occupied Bandwidth (kHz) | 20 dB Bandwidth (kHz) |
|-------------------------------|------------------------------|-----------------------|
| RFID 13.56 MHz mode ISO 15693 | 53.74 | 2.66 |

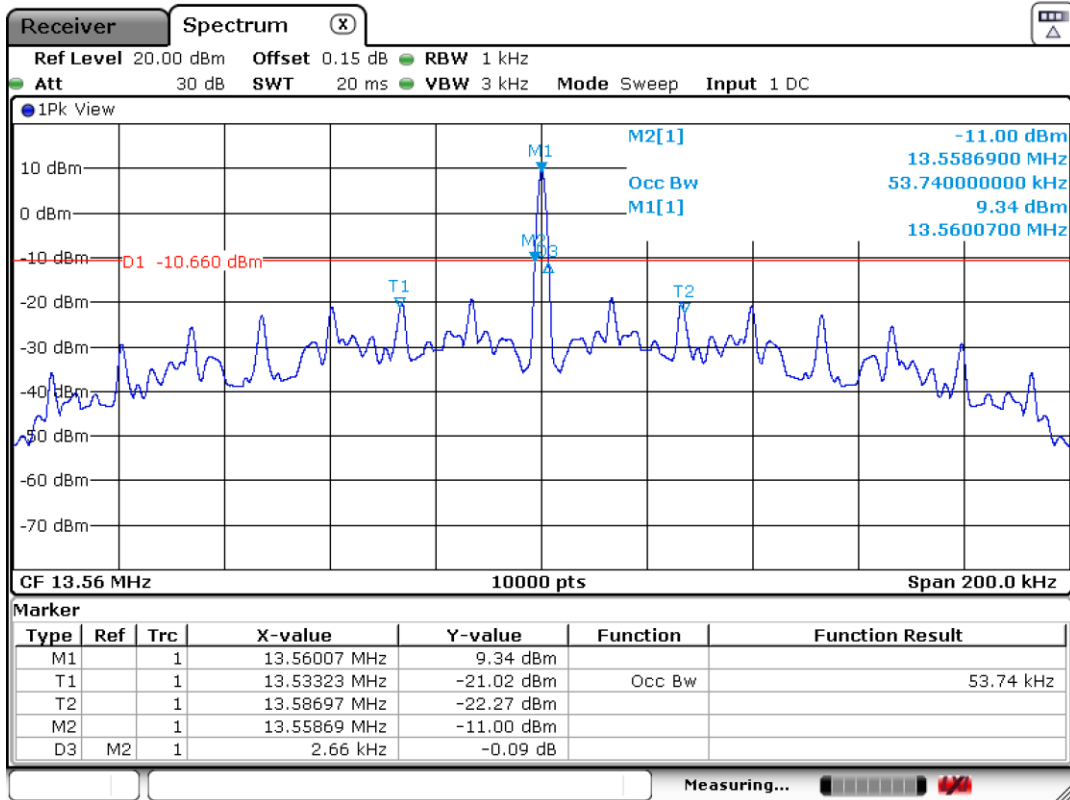

Verdict: PASS

FCC 15.225 (a) / RSS-210 B.6 (a). Field strength of emissions within the band 13.553 -13.567 MHz

SPECIFICATION:

The field strength of any emissions within the band 13.553 – 13.567 MHz shall not exceed 15,848 microvolts/meter (84 dBµV/m) at 30 meters.

RESULTS:

Measurement distance: 3 meters.

- **RFID mode ISO 14443A:**

The maximum field strength of fundamental emission:

| Frequency (MHz) | Maximum field strength (dBµV/m) measured at 3 m (quasi-peak detector) | Maximum field strength (dBµV/m) extrapolated to 30 m (40 dB/decade) |
|-----------------|---|---|
| 13.561 | 48.05 | 8.05 |

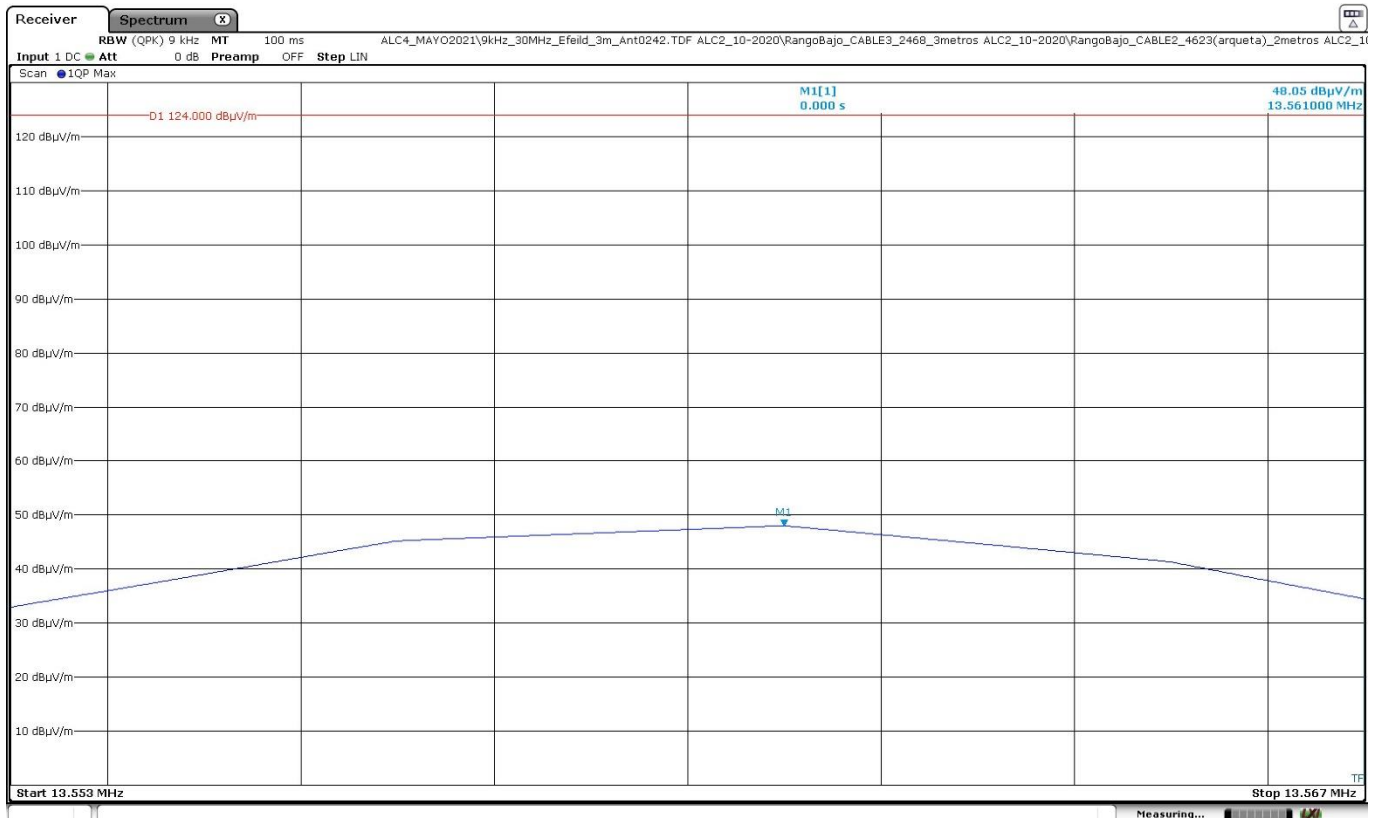

The limit shown in the above plot is extrapolated to 3 meters

Verdict: PASS

- **RFID mode ISO 15693:**

The maximum field strength of fundamental emission:

| Frequency (MHz) | Maximum field strength (dBµV/m) measured at 3 m (quasi-peak detector) | Maximum field strength (dBµV/m) extrapolated to 30 m (40 dB/decade) |
|-----------------|---|---|
| 13.561 | 48.06 | 8.06 |

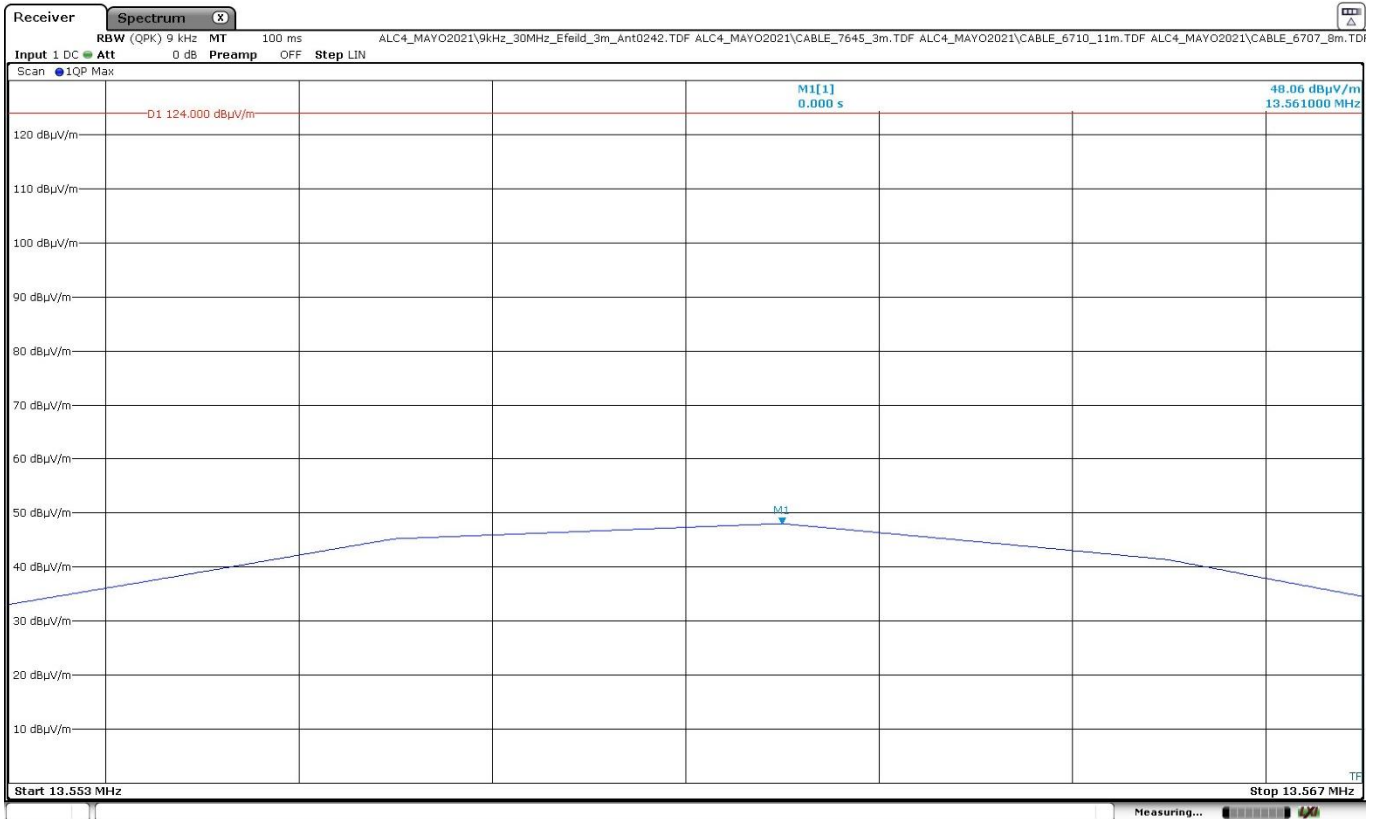

The limit shown in the above plot is extrapolated to 3 meters

Verdict: PASS

FCC 15.225 (b) / RSS-210 B.6 (b). Field strength of emissions within the band 13.410 - 13.553 MHz and 13.567 - 13.710 MHz

SPECIFICATION:

Within the bands 13.410-13.553 MHz and 13.567-13.710 MHz, the field strength of any emissions shall not exceed 334 microvolts/meter (50.47 dBµV/m) at 30 meters.

RESULTS:

Measurement distance: 3 meters.

- Band 13.410 - 13.553 MHz

- **RFID mode ISO 14443A:**

| Frequency (MHz) | Maximum field strength (dBµV/m) measured at 3 m (quasi-peak detector) | Maximum field strength (dBµV/m) extrapolated to 30 m (40 dB/decade) |
|-----------------|---|---|
| 13.553 | 32.06 | -7.94 |

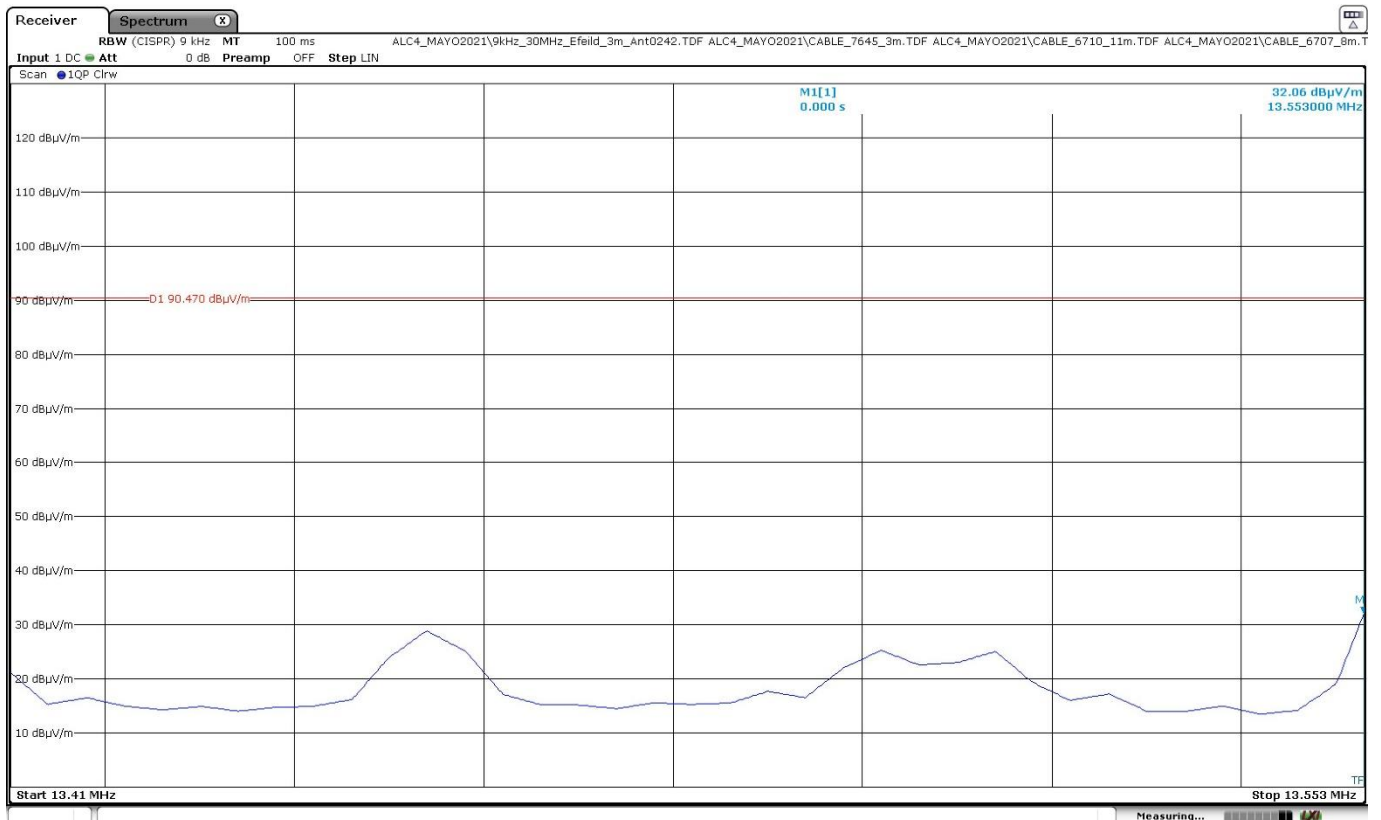

The limit shown in the above plot is extrapolated to 3 meters

Verdict: PASS

- RFID mode ISO 15693:

| Frequency (MHz) | Maximum field strength (dBµV/m) measured at 3 m (quasi-peak detector) | Maximum field strength (dBµV/m) extrapolated to 30 m (40 dB/decade) |
|-----------------|---|---|
| 13.553 | 32.91 | -7.09 |

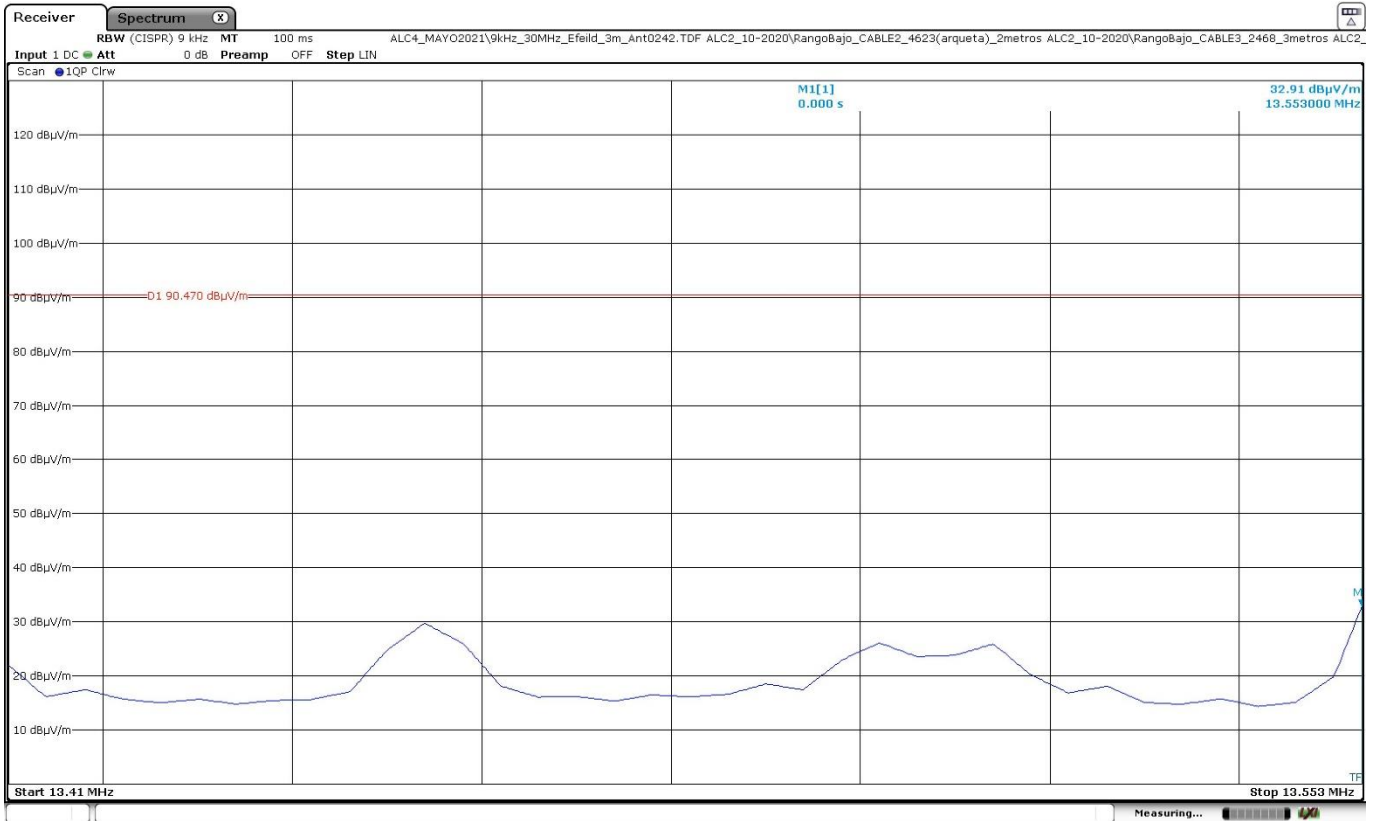

The limit shown in the above plot is extrapolated to 3 meters

Verdict: PASS

- Band 13.567-13.710 MHz

- **RFID mode ISO 14443A:**

| Frequency (MHz) | Maximum field strength (dBµV/m) measured at 3 m (quasi-peak detector) | Maximum field strength (dBµV/m) extrapolated to 30 m (40 dB/decade) |
|-----------------|---|---|
| 13.567 | 34.47 | -5.53 |

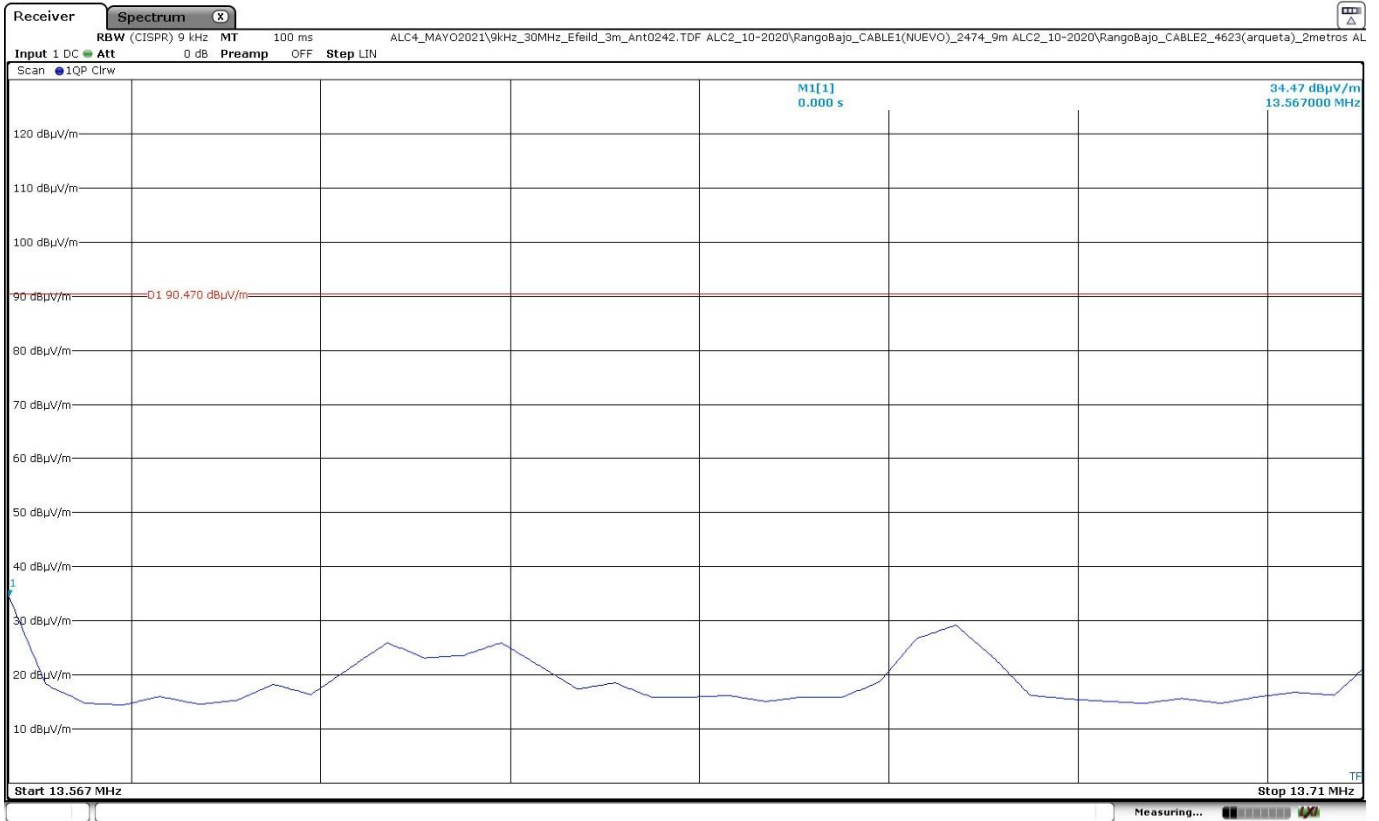

The limit shown in the above plot is extrapolated to 3 meters

Verdict: PASS

- RFID mode ISO 15693:

| Frequency (MHz) | Maximum field strength (dBµV/m) measured at 3 m (quasi-peak detector) | Maximum field strength (dBµV/m) extrapolated to 30 m (40 dB/decade) |
|-----------------|---|---|
| 13.567 | 34.54 | -5.46 |

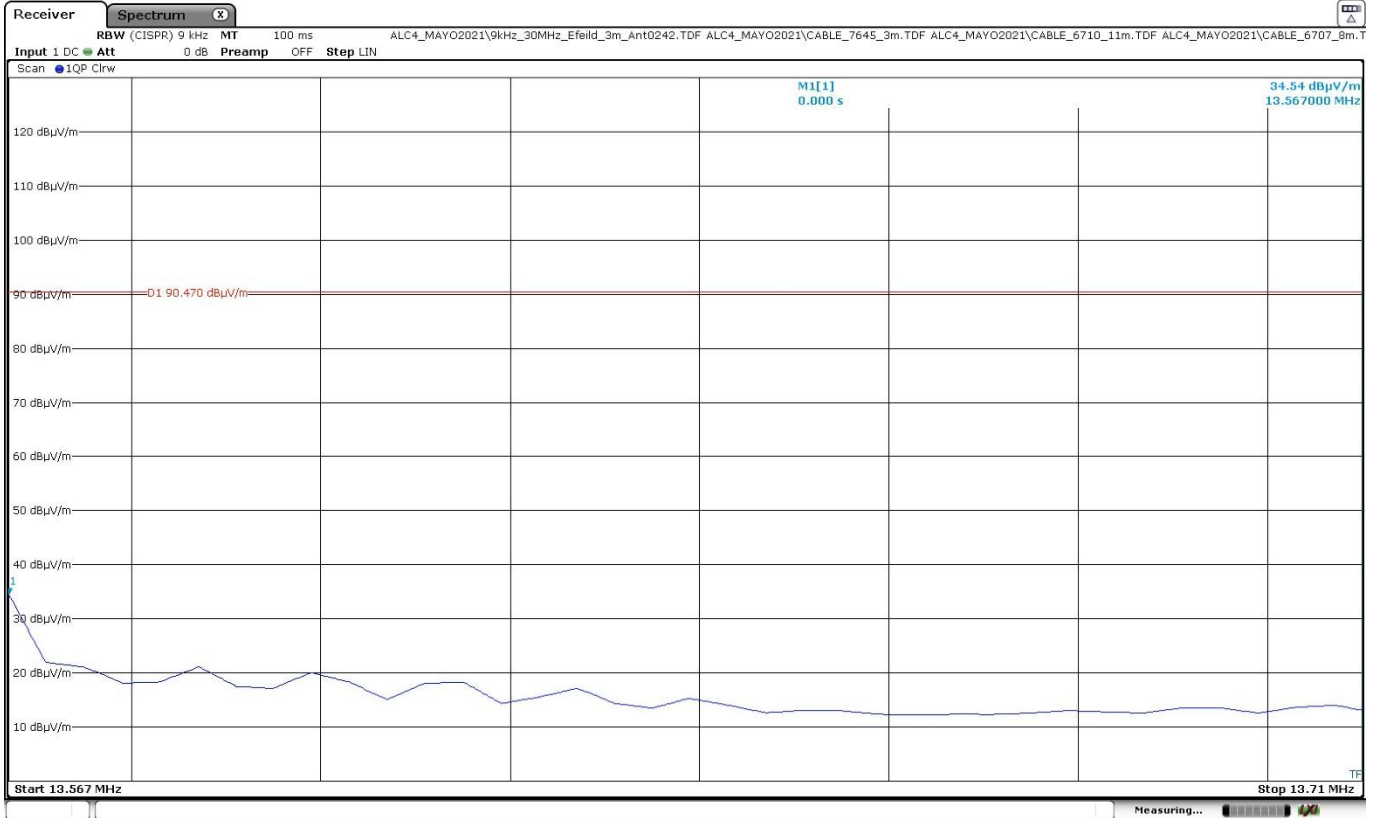

The limit shown in the above plot is extrapolated to 3 meters

Verdict: PASS

FCC 15.225 (c) / RSS-210 B.6 (c). Field strength of emissions within the band 13.110 - 13.410 MHz and 13.710 - 14.010 MHz

SPECIFICATION:

Within the bands 13.110-13.410 MHz and 13.710-14.010 MHz, the field strength of any emissions shall not exceed 106 microvolts/meter (40.51 dBµV/m) at 30 meters.

RESULTS:

Measurement distance: 3 meters.

- Band 13.110-13.410 MHz

- **RFID mode ISO 14443A:**

| Frequency (MHz) | Maximum field strength (dBµV/m) measured at 3 m (quasi-peak detector) | Maximum field strength (dBµV/m) extrapolated to 30 m (40 dB/decade) |
|-----------------|---|---|
| 13.350 | 25.03 | -14.97 |

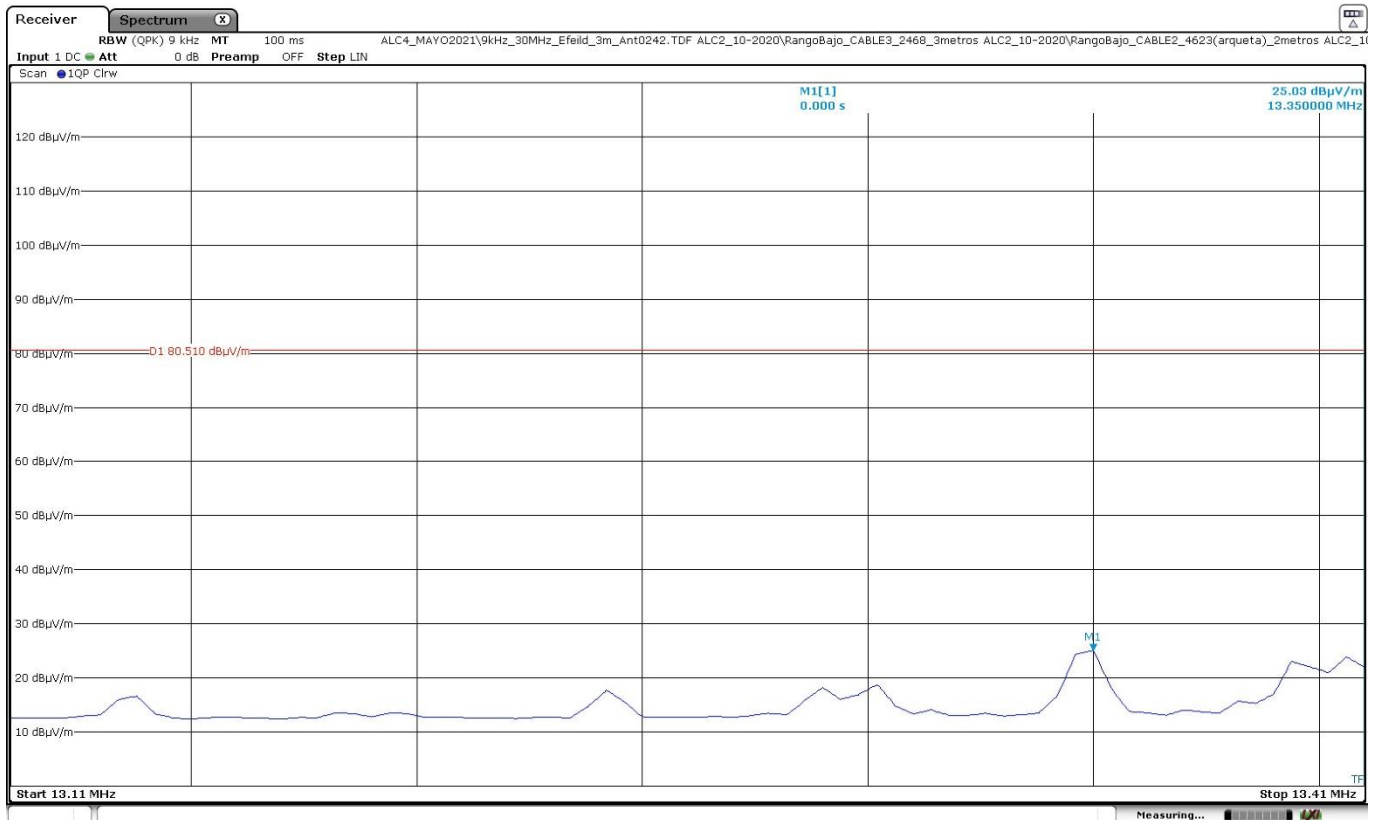

The limit shown in the above plot is extrapolated to 3 meters

Verdict: PASS

- RFID mode ISO 15693:

| Frequency (MHz) | Maximum field strength (dBµV/m) measured at 3 m (quasi-peak detector) | Maximum field strength (dBµV/m) extrapolated to 30 m (40 dB/decade) |
|-----------------|---|---|
| 13.350 | 14.38 | -25.62 |

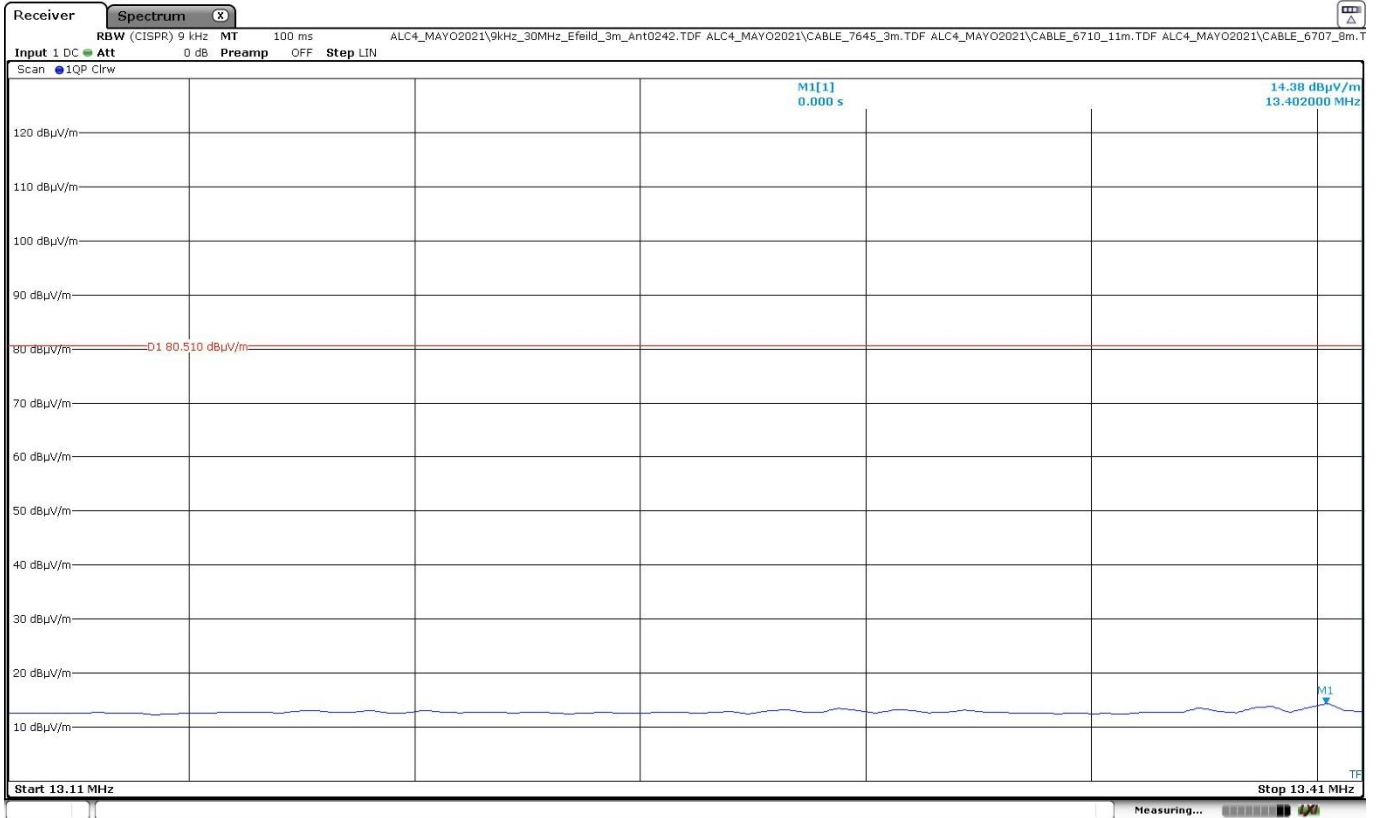

The limit shown in the above plot is extrapolated to 3 meters

Verdict: PASS

- Band 13.710-14.010 MHz

- **RFID mode ISO 14443A:**

| Frequency (MHz) | Maximum field strength (dBµV/m) measured at 3 m (quasi-peak detector) | Maximum field strength (dBµV/m) extrapolated to 30 m (40 dB/decade) |
|-----------------|---|---|
| 13.774 | 24.22 | -15.78 |

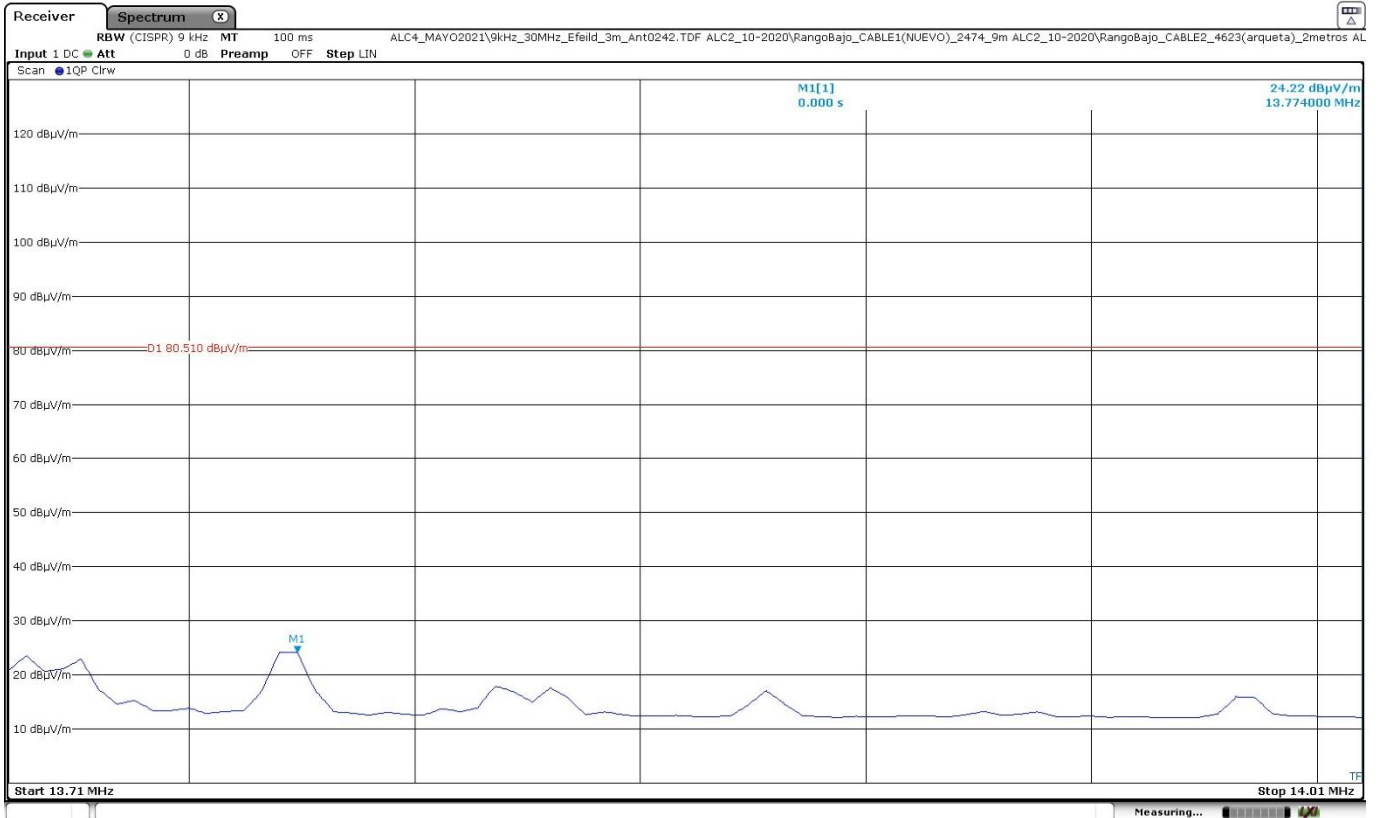

The limit shown in the above plot is extrapolated to 3 meters

Verdict: PASS

- RFID mode ISO 15693:

| Frequency (MHz) | Maximum field strength (dBµV/m) measured at 3 m (quasi-peak detector) | Maximum field strength (dBµV/m) extrapolated to 30 m (40 dB/decade) |
|-----------------|---|---|
| 13.718 | 14.14 | -25.86 |

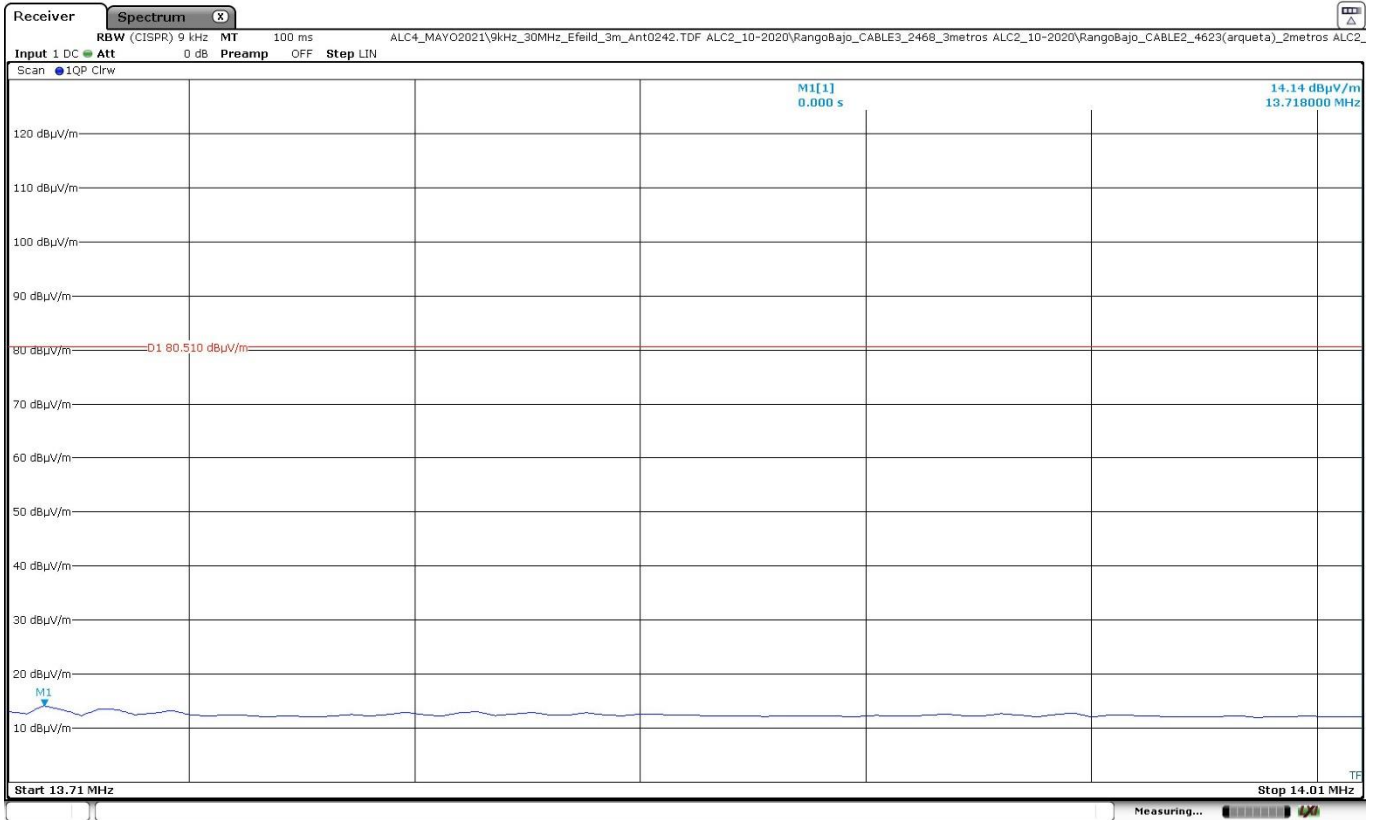

The limit shown in the above plot is extrapolated to 3 meters

Verdict: PASS

FCC 15.225 (d) / RSS-210 B.6 (a)(iv) Field Strength of Emissions outside of the band 13.110 MHz - 14.010 MHz

SPECIFICATION:

Field strength of any emissions appearing outside of the band 13.110 MHz - 14.010 MHz band shall not exceed the general radiated emission limits in 15.209/RSS-Gen:

| Frequency Range (MHz) | Field strength ($\mu\text{V/m}$) | Field strength ($\text{dB}\mu\text{V/m}$) | Measurement distance (m) |
|-----------------------|------------------------------------|---|--------------------------|
| 0.009-0.490 | 2400/F(kHz) | - | 300 |
| 0.490-1.705 | 24000/F(kHz) | - | 30 |
| 1.705 - 30.0 | 30 | 29.54 | 30 |
| 30 - 88 | 100 | 40 | 3 |
| 88 - 216 | 150 | 43.5 | 3 |
| 216 - 960 | 200 | 46 | 3 |
| Above 960 | 500 | 54 | 3 |

RESULTS:

All tests were performed in a semi-anechoic chamber at a distance of 3 m.

The spectrum was inspected from 9 kHz to 200 MHz searching for spurious signals.

The field strength is calculated by adding correction factor to the measured level from the spectrum analyzer. This correction factor includes antenna factor, cable loss and pre-amplifier gain.

- Frequency range 9 kHz - 30 MHz:

- RFID mode ISO 14443A:

No spurious frequencies were found at less than 20 dB of the limit.

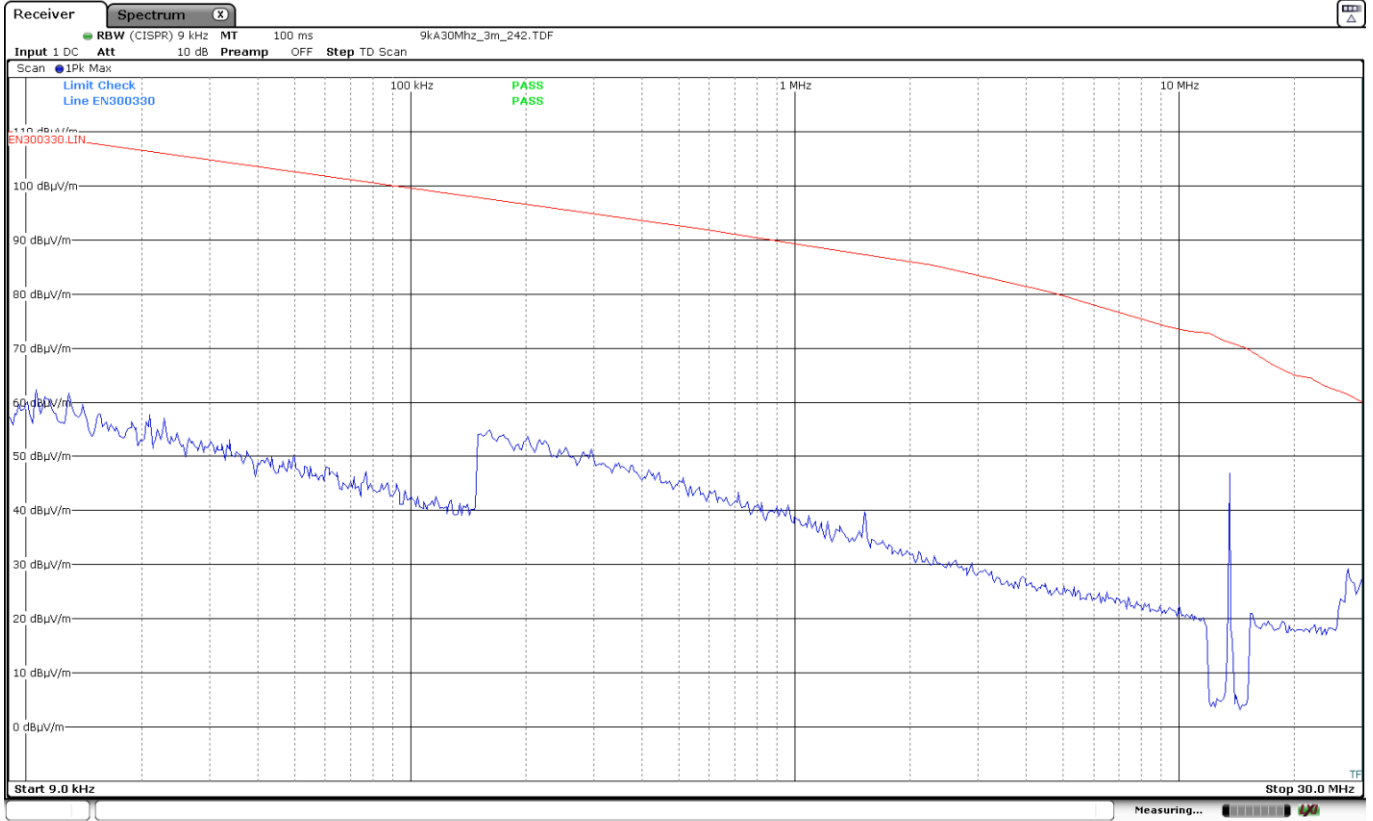

The limits shown in the above plot are extrapolated to 3 meters. The highest peak corresponds to the carrier level.

Resolution bandwidth:
200 Hz for $9 \text{ kHz} \leq f \leq 150 \text{ kHz}$
9 kHz for $150 \text{ kHz} \leq f \leq 30 \text{ MHz}$

- **RFID mode ISO 15693:**

No spurious frequencies were found at less than 20 dB of the limit.

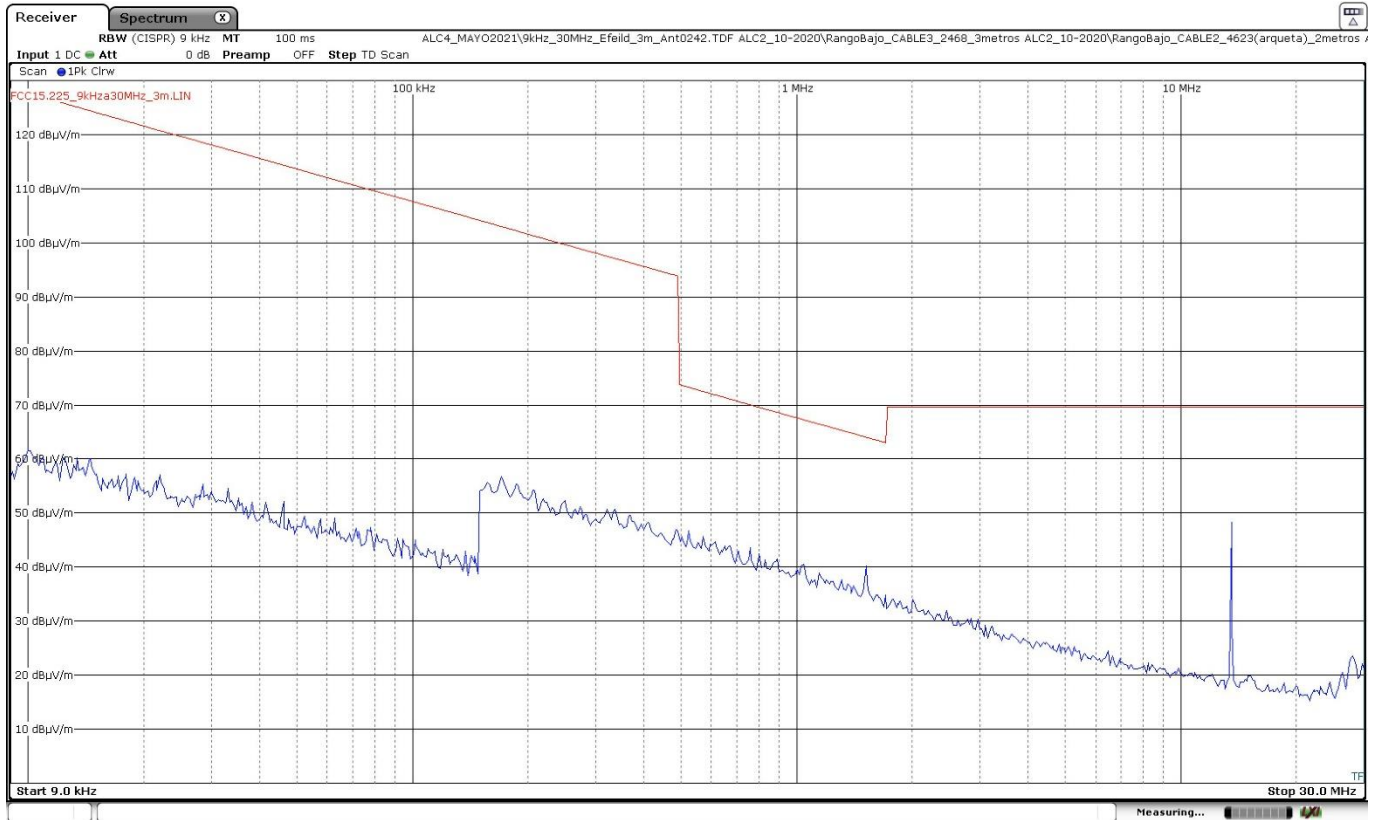

The limits shown in the above plot are extrapolated to 3 meters. The highest peak corresponds to the carrier level.

Resolution bandwidth:
 200 Hz for $9 \text{ kHz} \leq f \leq 150 \text{ kHz}$
 9 kHz for $150 \text{ kHz} \leq f \leq 30 \text{ MHz}$

- Frequency range 30 - 200 MHz:

- RFID mode ISO 14443A:

No spurious frequencies were found at less than 20 dB of the limit.

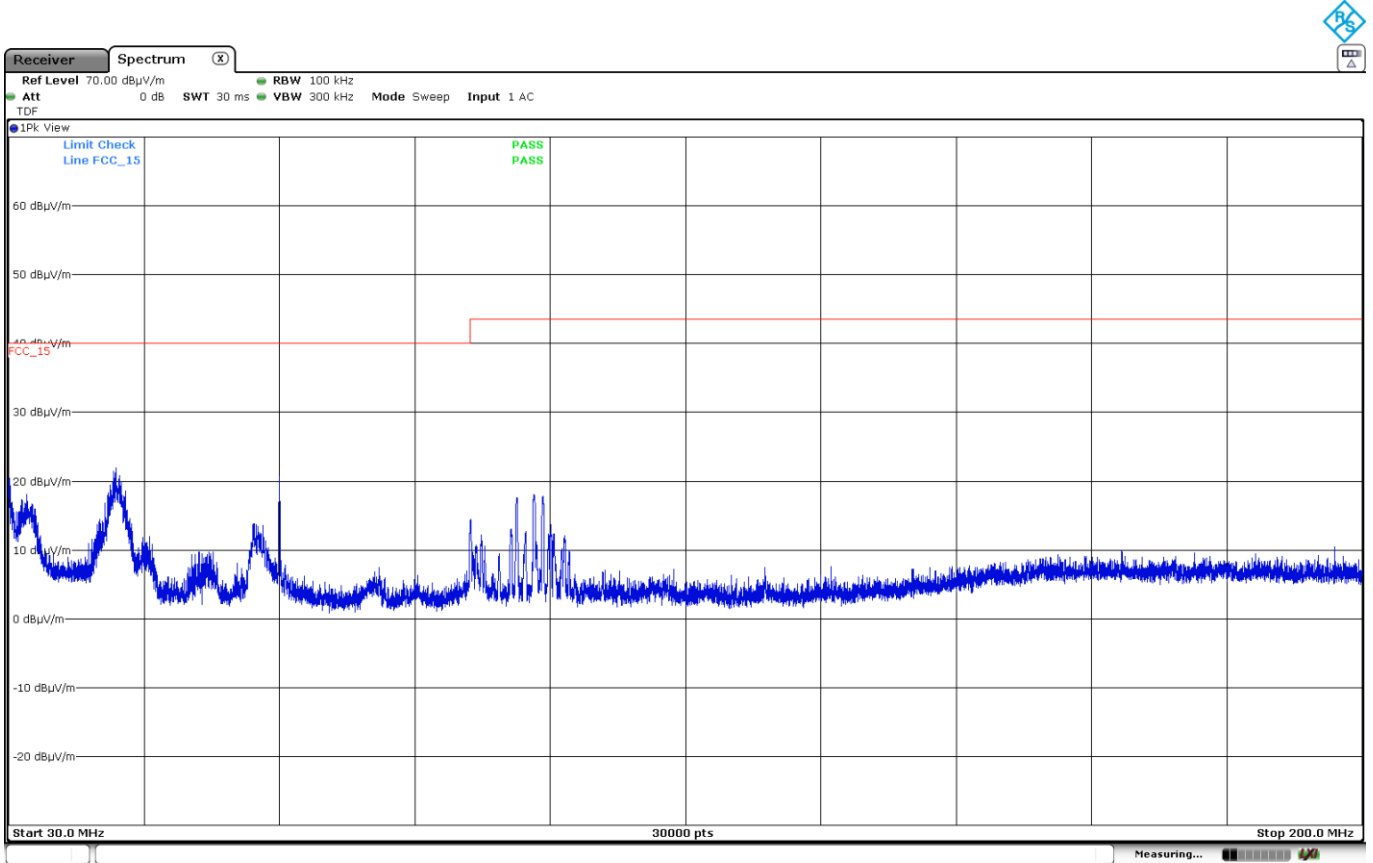

The above plot shows the results of the scan using peak detector.

Verdict: PASS

- **RFID mode ISO 15693:**

No spurious frequencies were found at less than 20 dB of the limit.

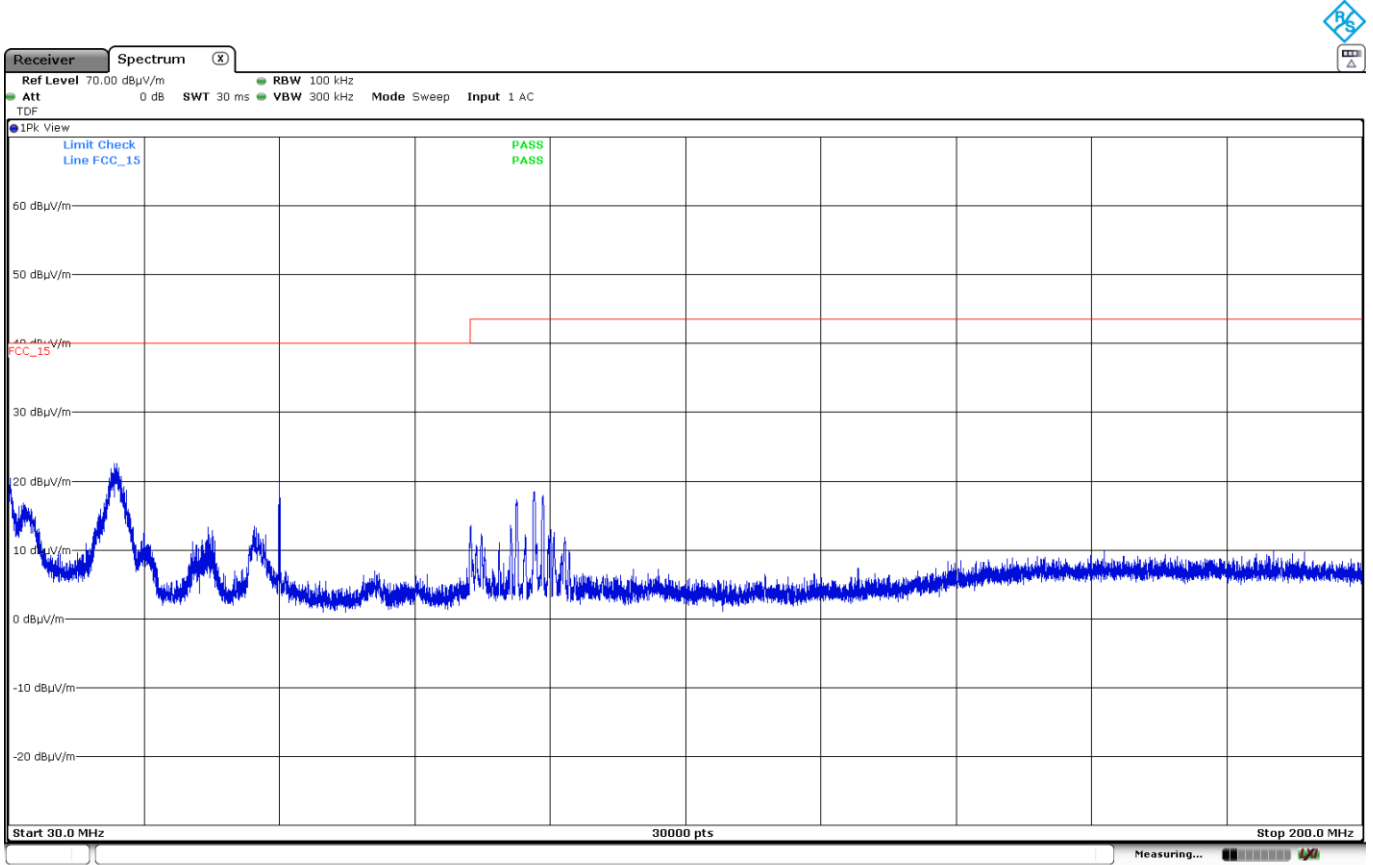

The above plot shows the results of the scan using peak detector.

Verdict: PASS

FCC 15.225 (e) / RSS-210 B.6 (b) Frequency Tolerance of the Carrier Signal

SPECIFICATION:

The frequency tolerance of the carrier signal shall be maintained within +/- 0.01% of the operating frequency over a temperature variation of -20 degrees to +50 degrees C at normal supply voltage, and for a variation in the primary supply voltage from 85% to 115% of the rated supply voltage at a temperature of 20 degrees C. For hand carried, battery powered equipment, reduce primary supply voltage to the battery operating end point which shall be specified by the manufacturer.

RESULTS:

Nominal Operating Frequency: 13.56 MHz.

- **RFID mode ISO 14443A:**

Frequency Stability over Temperature Variations:

| Temperature (°C) | Frequency Error (kHz) | Frequency Error (%) |
|------------------|-----------------------|---------------------|
| +50 | -0.088500 | -0.000653 |
| +40 | -0.096000 | -0.000708 |
| +30 | -0.115500 | -0.000852 |
| +20 | -0.127500 | -0.000940 |
| +10 | -0.094500 | -0.000697 |
| 0 | -0.130500 | -0.000962 |
| -10 | -0.178500 | -0.001316 |
| -20 | -0.187500 | -0.001383 |

Frequency Stability over Voltage Variations:

| DC Voltage | Voltage (V) | Temperature (°C) | Frequency Error (kHz) | Frequency Error (%) |
|------------|-------------|------------------|-----------------------|---------------------|
| Vmax | 6.9 | 20 | -0.142500 | -0.001051 |
| Vmin | 5.1 | 20 | -0.141000 | -0.001040 |

Verdict: PASS

- **RFID mode ISO 15693:**

Frequency Stability over Temperature Variations:

| Temperature (°C) | Frequency Error (kHz) | Frequency Error (%) |
|------------------|-----------------------|---------------------|
| +50 | -0.088500 | -0.000653 |
| +40 | -0.100500 | -0.000741 |
| +30 | -0.109500 | -0.000808 |
| +20 | -0.144000 | -0.001062 |
| +10 | -0.088500 | -0.000653 |
| 0 | -0.144000 | -0.001062 |
| -10 | -0.169500 | -0.001250 |
| -20 | -0.187500 | -0.001383 |

Frequency Stability over Voltage Variations:

| DC Voltage | Voltage (V) | Temperature (°C) | Frequency Error (kHz) | Frequency Error (%) |
|------------|-------------|------------------|-----------------------|---------------------|
| Vmax | 6.9 | 20 | -0.145500 | -0.001073 |
| Vmin | 5.1 | 20 | -0.144000 | -0.001062 |

Verdict: PASS