

## Variant FCC Test Report

**Report No.:** RF180621C33F

**FCC ID:** UK7-DW9

**Test Model:** DW9D1 (Refer section 3.1 for more details)

**Received Date:** Sep. 25, 2019

**Test Date:** Oct. 09 ~ Oct. 15, 2019

**Issued Date:** Oct. 18, 2019

**Applicant:** Fossil Group, Inc.

**Address:** 901 S. Central Expressway, Richardson, TX 75080, USA

**Issued By:** Bureau Veritas Consumer Products Services (H.K.) Ltd., Taoyuan Branch  
Lin Kou Laboratories

**Lab Address:** No. 47-2, 14th Ling, Chia Pau Vil., Lin Kou Dist., New Taipei City, Taiwan

**Test Location:** No.19, Hwa Ya 2nd Rd., Wen Hwa Vil., Kwei Shan Dist., Taoyuan City  
33383, Taiwan

**FCC Registration /  
Designation Number:** 788550 / TW0003



This report is for your exclusive use. Any copying or replication of this report to or for any other person or entity, or use of our name or trademark, is permitted only with our prior written permission. This report sets forth our findings solely with respect to the test samples identified herein. The results set forth in this report are not indicative or representative of the quality or characteristics of the lot from which a test sample was taken or any similar or identical product unless specifically and expressly noted. Our report includes all of the tests requested by you and the results thereof based upon the information that you provided to us. You have 60 days from date of issuance of this report to notify us of any material error or omission caused by our negligence, provided, however, that such notice shall be in writing and shall specifically address the issue you wish to raise. A failure to raise such issue within the prescribed time shall constitute your unqualified acceptance of the completeness of this report, the tests conducted and the correctness of the report contents. Unless specific mention, the uncertainty of measurement has been explicitly taken into account to declare the compliance or non-compliance to the specification. The report must not be used by the client to claim product certification, approval, or endorsement by TAF or any government agencies.

## Table of Contents

|  |           |
|--|-----------|
| <b>Release Control Record .....</b>                              | <b>3</b>  |
| <b>1 Certificate of Conformity .....</b>                         | <b>4</b>  |
| <b>2 Summary of Test Results.....</b>                            | <b>5</b>  |
| 2.1 Measurement Uncertainty.....                                 | 6         |
| 2.2 Modification Record .....                                    | 6         |
| <b>3 General Information .....</b>                               | <b>7</b>  |
| 3.1 General Description of EUT .....                             | 7         |
| 3.2 Description of Test Modes.....                               | 8         |
| 3.2.1 Test Mode Applicability and Tested Channel Detail.....     | 9         |
| 3.3 Description of Support Units .....                           | 11        |
| 3.3.1 Configuration of System under Test .....                   | 11        |
| 3.4 General Description of Applied Standards.....                | 11        |
| <b>4 Test Types and Results .....</b>                            | <b>12</b> |
| 4.1 Radiated Emission and Bandedge Measurement .....             | 12        |
| 4.1.1 Limits of Radiated Emission and Bandedge Measurement ..... | 12        |
| 4.1.2 Test Instruments .....                                     | 13        |
| 4.1.3 Test Procedures.....                                       | 14        |
| 4.1.4 Deviation from Test Standard .....                         | 15        |
| 4.1.5 Test Set Up .....  | 15        |
| 4.1.6 EUT Operating Conditions.....                              | 16        |
| 4.1.7 Test Results .....   | 17        |
| <b>5 Pictures of Test Arrangements.....</b>                      | <b>25</b> |
| <b>Annex A- Band-edge measurement .....</b>                      | <b>26</b> |
| <b>Appendix – Information of the Testing Laboratories .....</b>  | <b>28</b> |

### Release Control Record

| Issue No.    | Description      | Date Issued   |
|--------------|------------------|---------------|
| RF180621C33F | Original Release | Oct. 18, 2019 |

## 1 Certificate of Conformity

**Product:** Smart Watch

**Test Model:** DW9D1 (Refer to section 3.1 for more details)

**Sample Status:** Identical Prototype

**Applicant:** Fossil Group, Inc.

**Test Date:** Oct. 09 ~ Oct. 15, 2019

**Standards:** 47 CFR FCC Part 15, Subpart C (Section 15.247)  
ANSI C63.10:2013

This report is issued as a supplementary report to BV CPS report no.: RF180621C33E. This report shall be used by combining with its original report.

**Prepared by :** Gina Liu , **Date:** Oct. 18, 2019  
Gina Liu / Specialist

**Approved by :** Dylan Chiou , **Date:** Oct. 18, 2019  
Dylan Chiou / Project Engineer

## 2 Summary of Test Results

### <Bluetooth LE>

| 47 CFR FCC Part 15, Subpart C (Section 15.247) |                                |        |   |
|--|--------------------------------|--------|---|
| FCC Clause                                     | Test Item                      | Result | Remarks   |
| 15.207   | AC Power Conducted Emission    | N/A    | Refer to Note   |
| 15.205 & 209                                   | Radiated Emissions             | Pass   | Meet the requirement of limit.<br>Minimum passing margin is -6.34 dB at 945.68 MHz. |
| 15.247(d)                                      | Band Edge Measurement          | N/A    | Refer to Note   |
| 15.247(d)                                      | Antenna Port Emission          | N/A    | Refer to Note   |
| 15.247(a)(2)                                   | 6 dB Bandwidth                 | N/A    | Refer to Note   |
| ---  | Occupied Bandwidth Measurement | N/A    | Refer to Note   |
| 15.247(b)                                      | Conducted Power                | N/A    | Refer to Note   |
| 15.247(e)                                      | Power Spectral Density         | N/A    | Refer to Note   |
| 15.203   | Antenna Requirement            | N/A    | Refer to Note   |

### <WLAN>

| 47 CFR FCC Part 15, Subpart C (Section 15.247) |  |        |   |
|--|--|--------|---|
| FCC Clause                                     | Test Item                                    | Result | Remarks   |
| 15.207   | AC Power Conducted Emission                  | N/A    | Refer to Note   |
| 15.205 /<br>15.209 /<br>15.247(d)              | Radiated Emissions and Band Edge Measurement | Pass   | Meet the requirement of limit.<br>Minimum passing margin is -0.49 dB at 2483.5 MHz. |
| 15.247(d)                                      | Antenna Port Emission                        | N/A    | Refer to Note   |
| 15.247(a)(2)                                   | 6 dB Bandwidth                               | N/A    | Refer to Note   |
| ---  | Occupied Bandwidth Measurement               | N/A    | Refer to Note   |
| 15.247(b)                                      | Conducted power                              | N/A    | Refer to Note   |
| 15.247(e)                                      | Power Spectral Density                       | N/A    | Refer to Note   |
| 15.203   | Antenna Requirement                          | N/A    | Refer to Note   |

#### Note:

1. Only Radiated Emissions was performed for this report. Refer to original report for other test data.
2. Determining compliance based on the results of the compliance measurement, not taking into account measurement instrumentation uncertainty.

## 2.1 Measurement Uncertainty

Where relevant, the following measurement uncertainty levels have been estimated for tests performed on the EUT as specified in CISPR 16-4-2:

| Measurement                    | Frequency          | Expanded Uncertainty (k=2) ( $\pm$ ) |
|--------------------------------|--------------------|--------------------------------------|
| Radiated Emissions up to 1 GHz | 9 kHz ~ 30 MHz     | 3.04 dB                              |
|                                | 30 MHz ~ 200 MHz   | 2.93 dB                              |
|                                | 200 MHz ~ 1000 MHz | 2.95 dB                              |
| Radiated Emissions above 1 GHz | 1 GHz ~ 18 GHz     | 2.26 dB                              |
|                                | 18 GHz ~ 40 GHz    | 1.94 dB                              |

## 2.2 Modification Record

There were no modifications required for compliance.

### 3 General Information

#### 3.1 General Description of EUT

|                            |  |   |
|----------------------------|--|---|
| <b>Product</b>             | Smart Watch  |   |
| <b>Test Model</b>          | DW9D1  |   |
| <b>Status of EUT</b>       | Identical Prototype  |   |
| <b>Power Supply Rating</b> | 5.0 Vdc (adapter or host equipment)<br>3.85 Vdc (Li-ion battery) |   |
| <b>Modulation Type</b>     | Bluetooth LE   | GFSK  |
|                            | WLAN   | CCK, DQPSK, DBPSK for DSSS<br>64QAM, 16QAM, QPSK, BPSK for OFDM   |
| <b>Transfer Rate</b>       | Bluetooth LE   | 1 Mbps  |
|                            | WLAN   | 802.11b: 11.0 / 5.5 / 2.0 / 1.0 Mbps<br>802.11g: 54.0 / 48.0 / 36.0 / 24.0 / 18.0 / 12.0 / 9.0 / 6.0 Mbps<br>802.11n: up to 72.2 Mbps |
| <b>Operating Frequency</b> | Bluetooth LE   | 2402 ~ 2480 MHz   |
|                            | WLAN   | 2412 ~ 2472 MHz   |
| <b>Number of Channel</b>   | Bluetooth LE   | 40  |
|                            | WLAN   | 13 for 802.11b, 802.11g, 802.11n (HT20)   |
| <b>Antenna Type</b>        | Loop antenna   |   |
| <b>Antenna Connector</b>   | N/A  |   |
| <b>Accessory Device</b>    | Refer to Note as below   |   |
| <b>Data Cable Supplied</b> | Refer to Note as below   |   |

Note:

1. This report is issued as a supplementary report to BV CPS report no. RF180621C33E. The difference compared with original report is adding models (DW9D1), appearance design / antenna gain / brand. Therefore, only Radiated Emissions was verified worst channel and recorded in this report.
2. All models are listed as below. (New brand is marked in gray.)

| Sample | Model        | Antenna Gain (dBi) |              | Description   |
|--------|--------------|--------------------|--------------|---|
|        |              | 2.4G / BT          | GPS          |   |
| 1      | DW9F1        | -9.7               | -7.15        | The models have the same layout, circuit, and components, but different appearance, antenna gain and brand. |
| 2      | DW9F2        | -8.26              | -5.26        |   |
| 3      | DW9B1        | -5.88              | -4.02        |   |
| 4      | DW9M1        | -6.71              | -4.17        |   |
| 5      | DW9K1        | -8.62              | -4.20        |   |
| 6      | DW9P1        | -7.35              | -4.23        |   |
| 7      | <b>DW9D1</b> | <b>-7.82</b>       | <b>-5.47</b> |   |

3. The EUT provide one completed transmitter and one receiver.

| Modulation Mode | Tx Function |
|-----------------|-------------|
| 802.11b         | 1TX         |
| 802.11g         | 1TX         |
| 802.11n (HT20)  | 1TX         |
| BT LE           | 1TX         |

4. Confirmed output power has been verified as original filing before starting the C2PC testing.
5. The EUT accessories list refers to user manual.
6. The above EUT information is declared by manufacturer and for more detailed features description, please refers to the manufacturer's specifications or User's Manual.

### 3.2 Description of Test Modes

#### <Bluetooth LE>

40 channels are provided to this EUT:

| Channel | Freq. (MHz) | Channel | Freq. (MHz) | Channel | Freq. (MHz) | Channel | Freq. (MHz) |
|---------|-------------|---------|-------------|---------|-------------|---------|-------------|
| 0       | 2402        | 10      | 2422        | 20      | 2442        | 30      | 2462        |
| 1       | 2404        | 11      | 2424        | 21      | 2444        | 31      | 2464        |
| 2       | 2406        | 12      | 2426        | 22      | 2446        | 32      | 2466        |
| 3       | 2408        | 13      | 2428        | 23      | 2448        | 33      | 2468        |
| 4       | 2410        | 14      | 2430        | 24      | 2450        | 34      | 2470        |
| 5       | 2412        | 15      | 2432        | 25      | 2452        | 35      | 2472        |
| 6       | 2414        | 16      | 2434        | 26      | 2454        | 36      | 2474        |
| 7       | 2416        | 17      | 2436        | 27      | 2456        | 37      | 2476        |
| 8       | 2418        | 18      | 2438        | 28      | 2458        | 38      | 2478        |
| 9       | 2420        | 19      | 2440        | 29      | 2460        | 39      | 2480        |

#### <WLAN>

13 channels are provided for 802.11b, 802.11g and 802.11n (HT20):

| Channel | Frequency (MHz) | Channel | Frequency (MHz) |
|---------|-----------------|---------|-----------------|
| 1       | 2412            | 8       | 2447            |
| 2       | 2417            | 9       | 2452            |
| 3       | 2422            | 10      | 2457            |
| 4       | 2427            | 11      | 2462            |
| 5       | 2432            | 12      | 2467            |
| 6       | 2437            | 13      | 2472            |
| 7       | 2442            |         |                 |



### 3.2.1 Test Mode Applicability and Tested Channel Detail

#### <Bluetooth LE>

| EUT Configure Mode | Applicable To |       | Description |
|--------------------|---------------|-------|-------------|
|                    | RE $\geq$ 1G  | RE<1G |             |
| -                  | √             | √     | -           |

Where **RE $\geq$ 1G**: Radiated Emission above 1 GHz      **RE<1G**: Radiated Emission below 1 GHz

**NOTE:**

1. The EUT had been pre-tested on the positioned of each 3 axis. The worst case was found when positioned on **Z-plane**.
2. "-" means no effect.

#### **Radiated Emission Test (Above 1 GHz):**

- Pre-Scan has been conducted to determine the worst-case mode from all possible combinations between available modulations, data rates and antenna ports (if EUT with antenna diversity architecture).
- Following channel(s) was (were) selected for the final test as listed below.

| EUT Configure Mode | Available Channel | Tested Channel | Modulation Type | Data Rate (Mbps) |
|--------------------|-------------------|----------------|-----------------|------------------|
| -                  | 0 to 39           | 39             | GFSK            | 1                |

#### **Radiated Emission Test (Below 1 GHz):**

- Pre-Scan has been conducted to determine the worst-case mode from all possible combinations between available modulations, data rates and antenna ports (if EUT with antenna diversity architecture).
- Following channel(s) was (were) selected for the final test as listed below.

| EUT Configure Mode | Available Channel | Tested Channel | Modulation Type | Data Rate (Mbps) |
|--------------------|-------------------|----------------|-----------------|------------------|
| -                  | 0 to 39           | 39             | GFSK            | 1                |

<WLAN>

| EUT Configure Mode | Applicable To |       | Description |
|--------------------|---------------|-------|-------------|
|                    | RE $\geq$ 1G  | RE<1G |             |
| -                  | √             | √     | -           |

Where **RE $\geq$ 1G**: Radiated Emission above 1 GHz

**NOTE:**

1. The EUT had been pre-tested on the positioned of each 3 axis. The worst case was found when positioned on **Z-plane**.
2. "-" means no effect.

**Radiated Emission Test (Above 1 GHz):**

- Pre-Scan has been conducted to determine the worst-case mode from all possible combinations between available modulations, data rates and antenna ports (if EUT with antenna diversity architecture).
- Following channel(s) was (were) selected for the final test as listed below.

| EUT Configure Mode | Mode           | Available Channel | Tested Channel | Modulation Technology | Modulation Type | Data Rate (Mbps) |
|--------------------|----------------|-------------------|----------------|-----------------------|-----------------|------------------|
| -                  | 802.11n (HT20) | 1 to 13           | 13             | OFDM                  | BPSK            | 6.5              |

**Radiated Emission Test (Below 1 GHz):**

- Pre-Scan has been conducted to determine the worst-case mode from all possible combinations between available modulations, data rates and antenna ports (if EUT with antenna diversity architecture).
- Following channel(s) was (were) selected for the final test as listed below.

| EUT Configure Mode | Mode           | Available Channel | Tested Channel | Modulation Technology | Modulation Type | Data Rate (Mbps) |
|--------------------|----------------|-------------------|----------------|-----------------------|-----------------|------------------|
| -                  | 802.11n (HT20) | 1 to 13           | 13             | OFDM                  | BPSK            | 6.5              |

**Test Condition:**

| Applicable To | Environmental Conditions | Input Power    | Tested by            |
|---------------|--------------------------|----------------|----------------------|
| RE $\geq$ 1G  | 25 deg. C, 65 % RH       | 120 Vac, 60 Hz | Tim Chen, Getaz Yang |
| RE<1G         | 25 deg. C, 65 % RH       | 120 Vac, 60 Hz | Tim Chen             |

### 3.3 Description of Support Units

The EUT has been tested as an independent unit together with other necessary accessories or support units. The following support units or accessories were used to form a representative test configuration during the tests.

| No. | Product | Brand   | Model No. | Serial No. | FCC ID |
|-----|---------|---------|-----------|------------|--------|
| 1   | Adapter | SALCOMP | TC U250   | N/A        | N/A    |

| No. | Signal Cable Description Of The Above Support Units |
|-----|---|
| 1.  | 1m shielded cable                                   |

Note:

1. All power cords of the above support units are non-shielded (1.8m).

#### 3.3.1 Configuration of System under Test

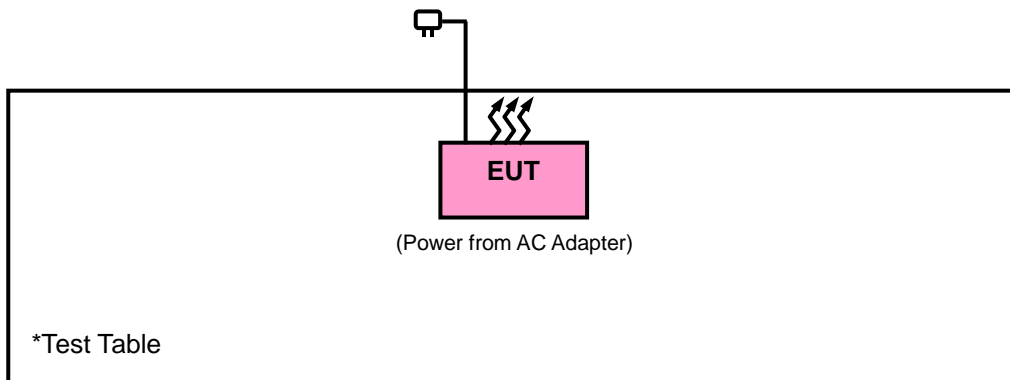

### 3.4 General Description of Applied Standards

The EUT is a RF Product. According to the specifications of the manufacturer, it must comply with the requirements of the following standards:

**FCC Part 15, Subpart C (15.247)**

**KDB 558074 D01 15.247 Meas Guidance v05r02**

ANSI C63.10-2013

All test items have been performed and recorded as per the above standards.

## 4 Test Types and Results

### 4.1 Radiated Emission and Bandedge Measurement

#### 4.1.1 Limits of Radiated Emission and Bandedge Measurement

Radiated emissions which fall in the restricted bands must comply with the radiated emission limits specified as below table. Other emissions shall be at least 20 dB below the highest level of the desired power:

| Frequencies (MHz) | Field Strength (microvolts/meter) | Measurement Distance (meters) |
|-------------------|-----------------------------------|-------------------------------|
| 0.009 ~ 0.490     | 2400/F (kHz)                      | 300                           |
| 0.490 ~ 1.705     | 24000/F (kHz)                     | 30                            |
| 1.705 ~ 30.0      | 30                                | 30                            |
| 30 ~ 88           | 100                               | 3                             |
| 88 ~ 216          | 150                               | 3                             |
| 216 ~ 960         | 200                               | 3                             |
| Above 960         | 500                               | 3                             |

**Note:**

1. The lower limit shall apply at the transition frequencies.
2. Emission level (dBuV/m) = 20 log Emission level (uV/m).
3. For frequencies above 1000 MHz, the field strength limits are based on average detector, however, the peak field strength of any emission shall not exceed the maximum permitted average limits, specified above by more than 20 dB under any condition of modulation.

## 4.1.2 Test Instruments

| Description & Manufacturer                     | Model No.                  | Serial No.                    | Date of Calibration | Due Date of Calibration |
|--|----------------------------|-------------------------------|---------------------|-------------------------|
| Test Receiver<br>Agilent                       | N9038A                     | MY51210203                    | Mar. 18, 2019       | Mar. 17, 2020           |
| Spectrum Analyzer<br>Agilent                   | N9010A                     | MY52220314                    | Dec. 13, 2018       | Dec. 12, 2019           |
| Spectrum Analyzer<br>ROHDE & SCHWARZ           | FSU43                      | 101261                        | Apr. 15, 2019       | Apr. 14, 2020           |
| Broadband Horn Antenna<br>SCHWARZBECK          | BBHA 9170                  | 148                           | Nov. 25, 2018       | Nov. 24, 2019           |
| HORN Antenna<br>SCHWARZBECK                    | BBHA 9120D                 | 9120D-969                     | Nov. 25, 2018       | Nov. 24, 2019           |
| BILOG Antenna<br>SCHWARZBECK                   | VULB 9168                  | 9168-472                      | Nov. 23, 2018       | Nov. 22, 2019           |
| Fixed Attenuator<br>Mini-Circuits              | MDCS18N-10                 | MDCS18N-10-01                 | Apr. 15, 2019       | Apr. 14, 2020           |
| Loop Antenna                                   | HLA 6121                   | 45745                         | Jul. 01, 2019       | Jun. 30, 2020           |
| Preamplifier<br>EMCI                           | EMC001340                  | 980201                        | Oct. 12, 2018       | Oct. 11, 2019           |
|  |                            |                               | Oct. 14, 2019       | Oct. 13, 2020           |
| Preamplifier<br>EMCI                           | EMC 012645                 | 980115                        | Oct. 08, 2019       | Oct. 07, 2020           |
| Preamplifier<br>EMCI                           | EMC 184045                 | 980116                        | Oct. 08, 2019       | Oct. 07, 2020           |
| Preamplifier<br>EMCI                           | EMC 330H                   | 980112                        | Oct. 08, 2019       | Oct. 07, 2020           |
| RF Coaxial Cable<br>HUBER+SUHNNER              | EMC104-SM-SM-8<br>000&3000 | 140811+170717                 | Oct. 08, 2019       | Oct. 07, 2020           |
| RF Coaxial Cable<br>HUBER+SUHNNER              | SUCOFLEX 104               | EMC104-SM-SM-1<br>000(140807) | Oct. 08, 2019       | Oct. 07, 2020           |
| RF Coaxial Cable<br>WOKEN                      | 8D-FB                      | Cable-Ch10-01                 | Oct. 08, 2019       | Oct. 07, 2020           |
| Boresight Antenna Fixture                      | FBA-01                     | FBA-SIP01                     | NA                  | NA                      |
| Software<br>BV ADT                             | E3<br>6.120103             | NA                            | NA                  | NA                      |
| Antenna Tower<br>MF                            | MFA-440H                   | NA                            | NA                  | NA                      |
| Turn Table<br>MF                               | MFT-201SS                  | NA                            | NA                  | NA                      |
| Antenna Tower & Turn<br>Table Controller<br>MF | MF-7802                    | NA                            | NA                  | NA                      |

Note: 1. The calibration interval of the above test instruments is 12 months and the calibrations are traceable to NML/ROC and NIST/USA.

2. The test was performed in HwaYa Chamber 10.

#### 4.1.3 Test Procedures

##### **For Radiated Emission below 30 MHz**

- a. The EUT was placed on the top of a rotating table 0.8 meters above the ground at a 3 meter chamber room. The table was rotated 360 degrees to determine the position of the highest radiation.
- b. The EUT was set 3 meters away from the interference-receiving antenna, which was mounted on the top of a variable-height antenna tower.
- c. Parallel, perpendicular, and ground-parallel orientations of the antenna are set to make the measurement.
- d. For each suspected emission, the EUT was arranged to its worst case and the rotatable table was turned from 0 degrees to 360 degrees to find the maximum reading.
- e. The test-receiver system was set to Quasi-Peak Detect Function and Specified Bandwidth with Maximum Hold Mode.

##### **Note:**

1. The resolution bandwidth and video bandwidth of test receiver/spectrum analyzer is 9 kHz at frequency below 30 MHz.
2. There is a comparison data of both open-field test site and semi-Anechoic chamber, and the result came out very similar.

##### **For Radiated Emission above 30 MHz**

- a. The EUT was placed on the top of a rotating table 0.8 meters (for 30 MHz ~ 1 GHz) / 1.5 meters (for above 1 GHz) above the ground at 3 meter chamber room for test. The table was rotated 360 degrees to determine the position of the highest radiation.
- b. The EUT was set 3 meters away from the interference-receiving antenna, which was mounted on the top of a variable-height antenna tower.
- c. The height of antenna is varied from one meter to four meters above the ground to determine the maximum value of the field strength. Both horizontal and vertical polarizations of the antenna are set to make the measurement.
- d. For each suspected emission, the EUT was arranged to its worst case and then the antenna was tuned to heights from 1 meter to 4 meters and the rotatable table was turned from 0 degrees to 360 degrees to find the maximum reading.
- e. The test-receiver system was set to quasi-peak detect function and specified bandwidth with maximum hold mode when the test frequency is below 1 GHz.
- f. The test-receiver system was set to peak and average detected function and specified bandwidth with maximum hold mode when the test frequency is above 1 GHz. If the peak reading value also meets average limit, measurement with the average detector is unnecessary.

##### **Note:**

1. The resolution bandwidth and video bandwidth of test receiver/spectrum analyzer is 120 kHz for Quasi-peak detection (QP) or Peak detection (PK) at frequency below 1 GHz.
2. The resolution bandwidth of test receiver/spectrum analyzer is 1 MHz and the video bandwidth is 3 MHz for Peak detection (PK) at frequency above 1 GHz.
3. The resolution bandwidth of test receiver/spectrum analyzer is 1 MHz and the video bandwidth is  $\geq 1/T$  (Duty cycle < 98 %) or 10 Hz (Duty cycle  $\geq 98$  %) for Average detection (AV) at frequency above 1 GHz. (RBW = 1 MHz, VBW = 3 kHz for BT LE; 11n (HT20); RBW = 1 MHz, VBW = 1 kHz for WLAN)
4. All modes of operation were investigated and the worst-case emissions are reported.

4.1.4 Deviation from Test Standard

No deviation.

4.1.5 Test Set Up

<Radiated Emission below 30 MHz>

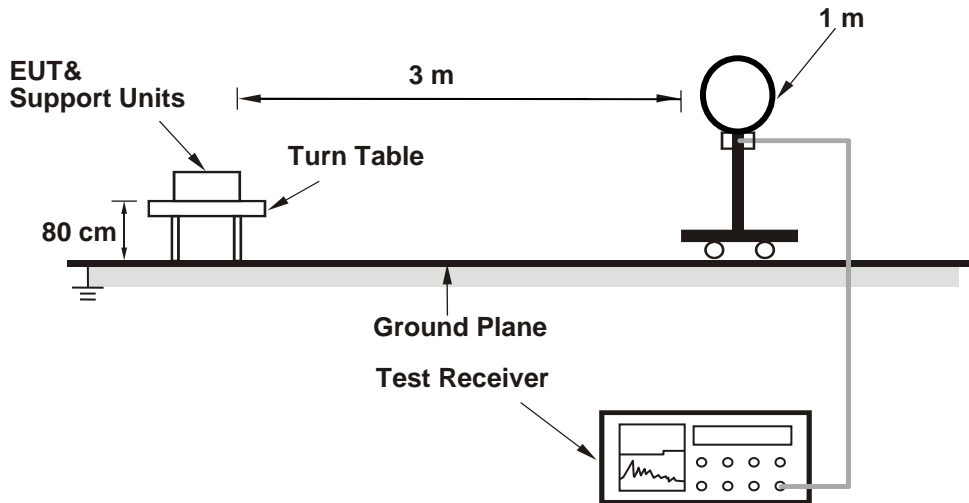

<Radiated Emission 30 MHz to 1 GHz>

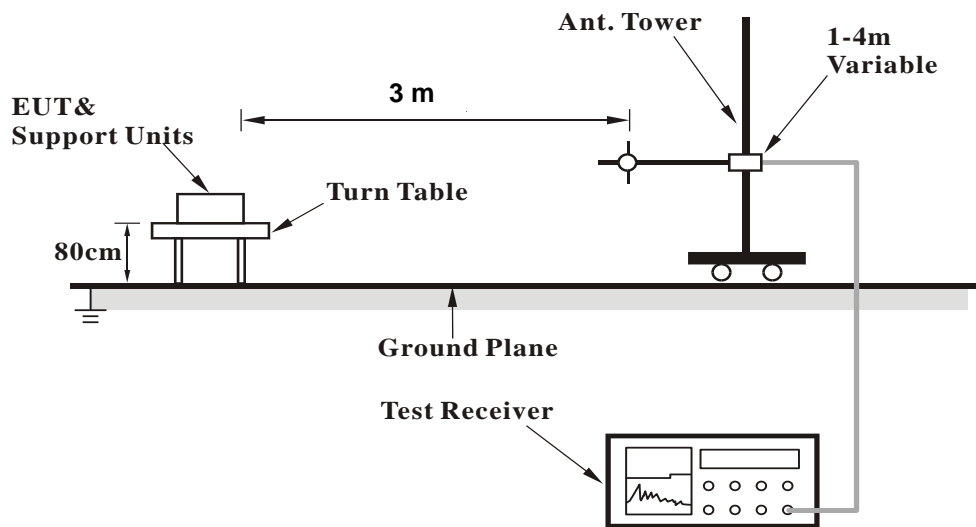

**<Radiated Emission above 1 GHz>**

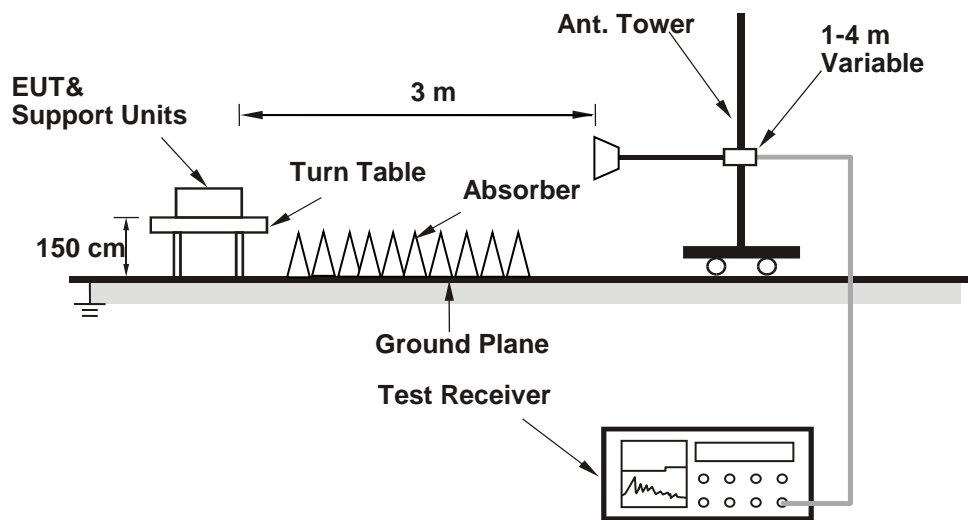

For the actual test configuration, please refer to the attached file (Test Setup Photo).

**4.1.6 EUT Operating Conditions**

- a. Placed the EUT on the testing table.
- b. Set the EUT under transmission condition continuously at specific channel frequency.



4.1.7 Test Results  
**ABOVE 1GHz DATA**  
**BT\_LE-GFSK**

| EUT Test Condition       |                    | Measurement Detail |                           |
|--------------------------|--------------------|--------------------|---------------------------|
| Channel                  | Channel 39         | Frequency Range    | 1 GHz ~ 25 GHz            |
| Input Power              | 120 Vac, 60 Hz     | Detector Function  | Peak (PK)<br>Average (AV) |
| Environmental Conditions | 25 deg. C, 65 % RH | Tested By          | Getaz Yang                |

**Horizontal**

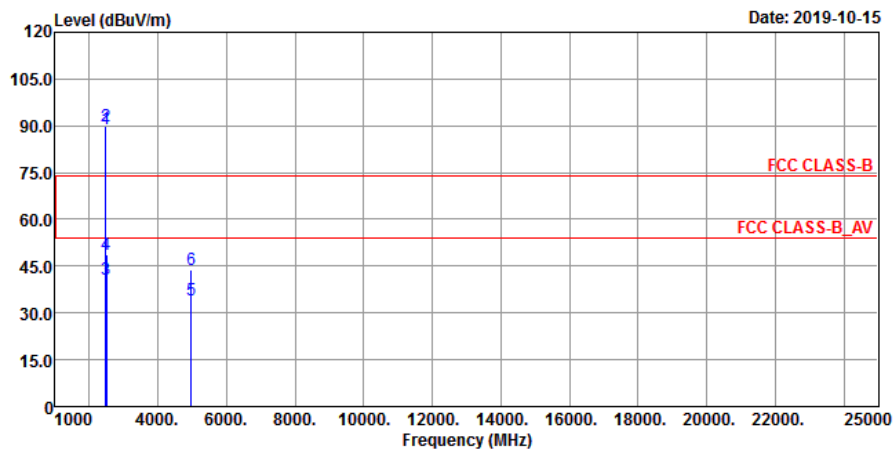

**Vertical**

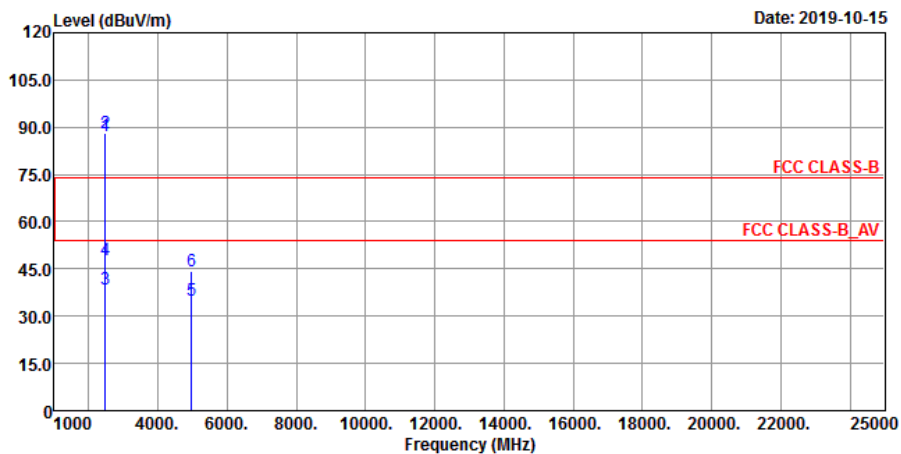

| Antenna Polarity & Test Distance: Horizontal at 3 m |                         |                   |               |                |             |                     |                      |         |
|---|-------------------------|-------------------|---------------|----------------|-------------|---------------------|----------------------|---------|
| Frequency (MHz)                                     | Emission Level (dBuV/m) | Read Level (dBuV) | Factor (dB/m) | Limit (dBuV/m) | Margin (dB) | Antenna Height (cm) | Table Angle (Degree) | Remark  |
| 2480  | 88.94                   | 56.47             | 32.47         |                |             | 142                 | 360                  | Average |
| 2480  | 89.78                   | 57.31             | 32.47         |                |             | 142                 | 360                  | Peak    |
| 2484.88   | 41.11                   | 45.96             | -4.85         | 54             | -12.89      | 142                 | 360                  | Average |
| 2484.88   | 48.91                   | 53.76             | -4.85         | 74             | -25.09      | 142                 | 360                  | Peak    |
| 4960  | 33.96                   | 47.85             | -13.89        | 54             | -20.04      | 198                 | 251                  | Average |
| 4960  | 43.83                   | 57.72             | -13.89        | 74             | -30.17      | 198                 | 251                  | Peak    |
| Antenna Polarity & Test Distance: Vertical at 3 m   |                         |                   |               |                |             |                     |                      |         |
| Frequency (MHz)                                     | Emission Level (dBuV/m) | Read Level (dBuV) | Factor (dB/m) | Limit (dBuV/m) | Margin (dB) | Antenna Height (cm) | Table Angle (Degree) | Remark  |
| 2480  | 87.36                   | 54.89             | 32.47         |                |             | 148                 | 220                  | Average |
| 2480  | 88.14                   | 55.67             | 32.47         |                |             | 148                 | 220                  | Peak    |
| 2483.64   | 38.5                    | 43.35             | -4.85         | 54             | -15.5       | 148                 | 220                  | Average |
| 2483.64   | 47.69                   | 52.54             | -4.85         | 74             | -26.31      | 148                 | 220                  | Peak    |
| 4960  | 34.93                   | 48.82             | -13.89        | 54             | -19.07      | 115                 | 21                   | Average |
| 4960  | 44.44                   | 58.33             | -13.89        | 74             | -29.56      | 115                 | 21                   | Peak    |

Remarks:

- Emission Level = Read Level + Factor  
Margin value = Emission level – Limit value
- 2480 MHz: Fundamental frequency.
- The emission levels of other frequencies were very low against the limit.

**9 kHz ~ 30 MHz Data:**

The amplitude of spurious emissions attenuated more than 20 dB below the permissible value is not required to be report.

**30 MHz ~ 1 GHz Worst-Case Data:**

| EUT Test Condition       |                    | Measurement Detail |                              |
|--------------------------|--------------------|--------------------|------------------------------|
| Channel                  | Channel 39         | Frequency Range    | 30 MHz ~ 1 GHz               |
| Input Power              | 120 Vac, 60 Hz     | Detector Function  | Peak (PK)<br>Quasi-peak (QP) |
| Environmental Conditions | 25 deg. C, 65 % RH | Tested By          | Tim Chen                     |

**Horizontal**

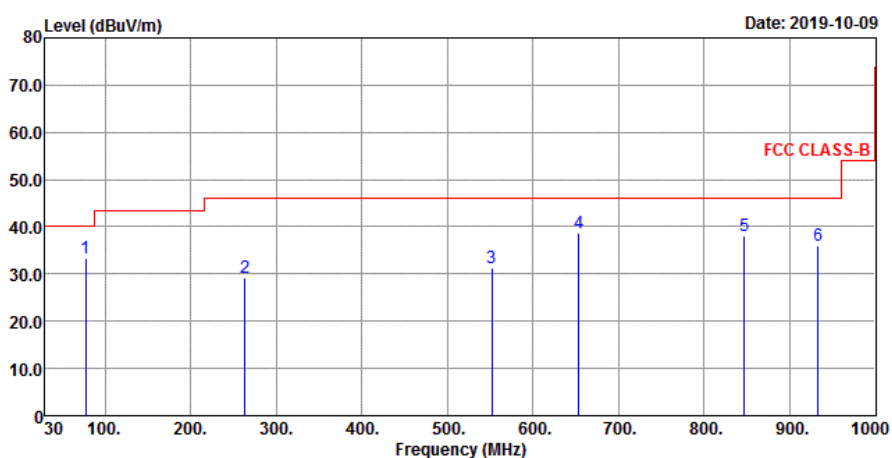

**Vertical**

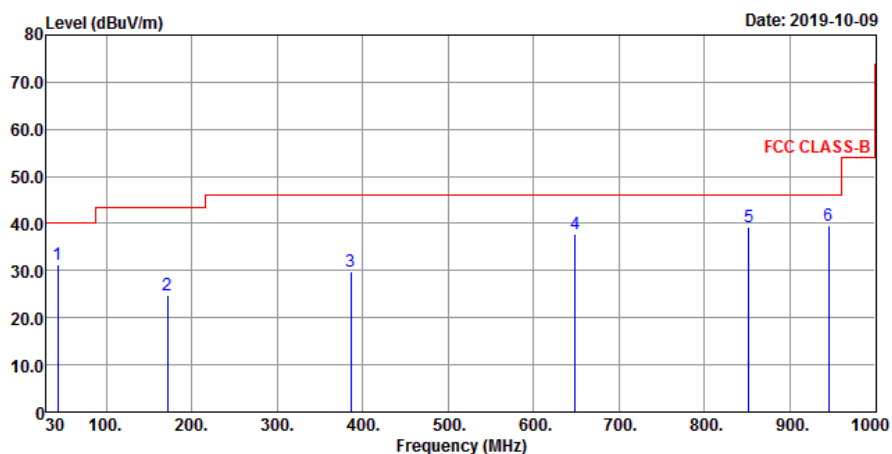

**Antenna Polarity & Test Distance: Horizontal at 3 m**

| Frequency (MHz) | Emission Level (dBuV/m) | Read Level (dBuV) | Factor (dB/m) | Limit (dBuV/m) | Margin (dB) | Antenna Height (cm) | Table Angle (Degree) | Remark |
|-----------------|-------------------------|-------------------|---------------|----------------|-------------|---------------------|----------------------|--------|
| 77.53           | 33.49                   | 54.73             | -21.24        | 40             | -6.51       | 116                 | 121                  | Peak   |
| 263.77          | 29.21                   | 46.35             | -17.14        | 46             | -16.79      | 133                 | 306                  | Peak   |
| 551.86          | 31.21                   | 41.85             | -10.64        | 46             | -14.79      | 125                 | 206                  | Peak   |
| 653.71          | 38.74                   | 46.69             | -7.95         | 46             | -7.26       | 117                 | 49                   | Peak   |
| 846.74          | 38.03                   | 42.21             | -4.18         | 46             | -7.97       | 103                 | 139                  | Peak   |
| 933.07          | 36.03                   | 38.85             | -2.82         | 46             | -9.97       | 118                 | 221                  | Peak   |

**Antenna Polarity & Test Distance: Vertical at 3 m**

| Frequency (MHz) | Emission Level (dBuV/m) | Read Level (dBuV) | Factor (dB/m) | Limit (dBuV/m) | Margin (dB) | Antenna Height (cm) | Table Angle (Degree) | Remark |
|-----------------|-------------------------|-------------------|---------------|----------------|-------------|---------------------|----------------------|--------|
| 43.58           | 31.38                   | 48.33             | -16.95        | 40             | -8.62       | 136                 | 251                  | Peak   |
| 171.62          | 24.66                   | 42.45             | -17.79        | 43.5           | -18.84      | 177                 | 151                  | Peak   |
| 385.99          | 29.68                   | 44.25             | -14.57        | 46             | -16.32      | 136                 | 299                  | Peak   |
| 648.86          | 37.74                   | 45.98             | -8.24         | 46             | -8.26       | 108                 | 132                  | Peak   |
| 851.59          | 39.13                   | 43.28             | -4.15         | 46             | -6.87       | 101                 | 56                   | Peak   |
| 945.68          | 39.66                   | 42.41             | -2.75         | 46             | -6.34       | 114                 | 307                  | Peak   |

Remarks:

- Emission Level = Read Level + Factor  
Margin value = Emission level – Limit value
- The emission levels of other frequencies were very low against the limit.

WLAN\_802.11n (HT20)

| EUT Test Condition       |                    | Measurement Detail |                           |
|--------------------------|--------------------|--------------------|---------------------------|
| Channel                  | Channel 13         | Frequency Range    | 1 GHz ~ 25 GHz            |
| Input Power              | 120 Vac, 60 Hz     | Detector Function  | Peak (PK)<br>Average (AV) |
| Environmental Conditions | 25 deg. C, 65 % RH | Tested By          | Tim Chen                  |

Horizontal

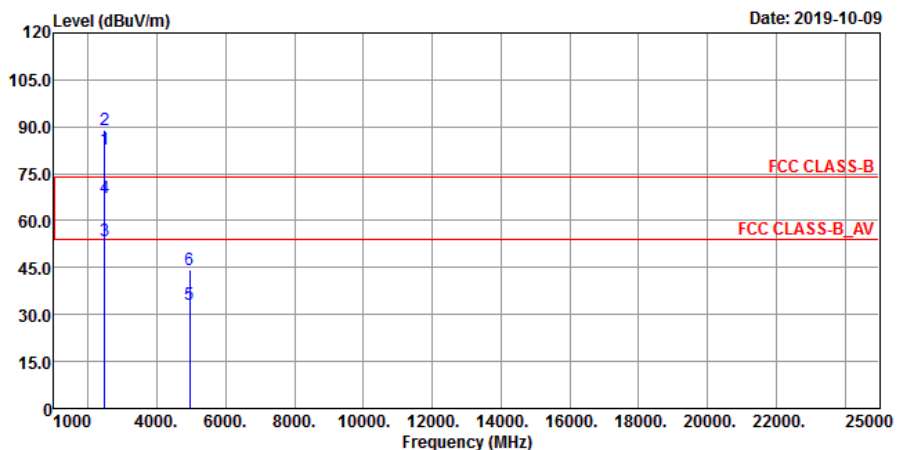

Vertical

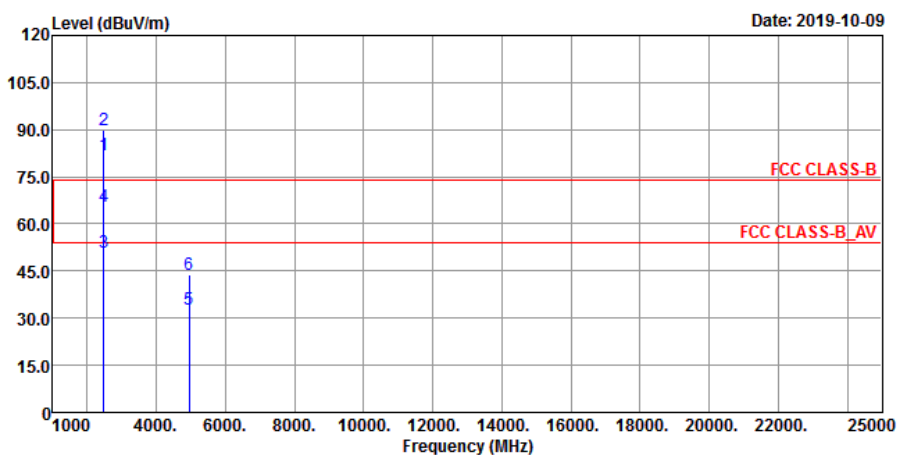

| Antenna Polarity & Test Distance: Horizontal at 3 m |                         |                   |               |                |             |                     |                      |         |
|---|-------------------------|-------------------|---------------|----------------|-------------|---------------------|----------------------|---------|
| Frequency (MHz)                                     | Emission Level (dBuV/m) | Read Level (dBuV) | Factor (dB/m) | Limit (dBuV/m) | Margin (dB) | Antenna Height (cm) | Table Angle (Degree) | Remark  |
| 2472  | 82.78                   | 87.63             | -4.85         |                |             | 201                 | 360                  | Average |
| 2472  | 89                      | 93.85             | -4.85         |                |             | 201                 | 360                  | Peak    |
| 2483.5  | 53.51                   | 58.36             | -4.85         | 54             | -0.49       | 201                 | 360                  | Average |
| 2483.5  | 67.52                   | 72.37             | -4.85         | 74             | -6.48       | 201                 | 360                  | Peak    |
| 4944  | 33.18                   | 47.13             | -13.95        | 54             | -20.82      | 175                 | 234                  | Average |
| 4944  | 44.43                   | 58.38             | -13.95        | 74             | -29.57      | 175                 | 234                  | Peak    |
| Antenna Polarity & Test Distance: Vertical at 3 m   |                         |                   |               |                |             |                     |                      |         |
| Frequency (MHz)                                     | Emission Level (dBuV/m) | Read Level (dBuV) | Factor (dB/m) | Limit (dBuV/m) | Margin (dB) | Antenna Height (cm) | Table Angle (Degree) | Remark  |
| 2472  | 82.08                   | 86.93             | -4.85         |                |             | 107                 | 197                  | Average |
| 2472  | 89.84                   | 94.69             | -4.85         |                |             | 107                 | 197                  | Peak    |
| 2483.5  | 51.09                   | 55.94             | -4.85         | 54             | -2.91       | 107                 | 197                  | Average |
| 2483.5  | 65.38                   | 70.23             | -4.85         | 74             | -8.62       | 107                 | 197                  | Peak    |
| 4944  | 32.58                   | 46.53             | -13.95        | 54             | -21.42      | 102                 | 67                   | Average |
| 4944  | 43.79                   | 57.74             | -13.95        | 74             | -30.21      | 102                 | 67                   | Peak    |

Remarks:

- Emission Level = Read Level + Factor  
Margin value = Emission level – Limit value
- 2472 MHz: Fundamental frequency.
- The emission levels of other frequencies were very low against the limit.

**9 kHz ~ 30 MHz Data:**

The amplitude of spurious emissions attenuated more than 20 dB below the permissible value is not required to be report.

**30 MHz ~ 1 GHz Worst-Case Data:**

| EUT Test Condition       |                    | Measurement Detail |                              |
|--------------------------|--------------------|--------------------|------------------------------|
| Channel                  | Channel 13         | Frequency Range    | 30 MHz ~ 1 GHz               |
| Input Power              | 120 Vac, 60 Hz     | Detector Function  | Peak (PK)<br>Quasi-peak (QP) |
| Environmental Conditions | 25 deg. C, 65 % RH | Tested By          | Tim Chen                     |

**Horizontal**

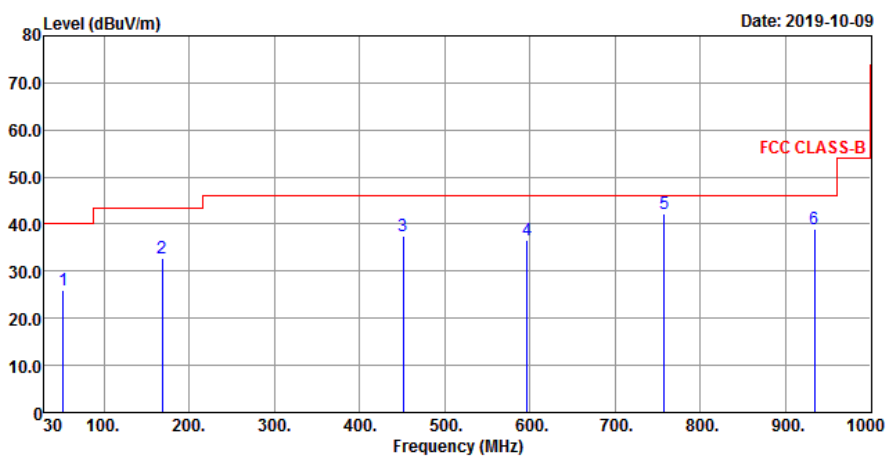

**Vertical**

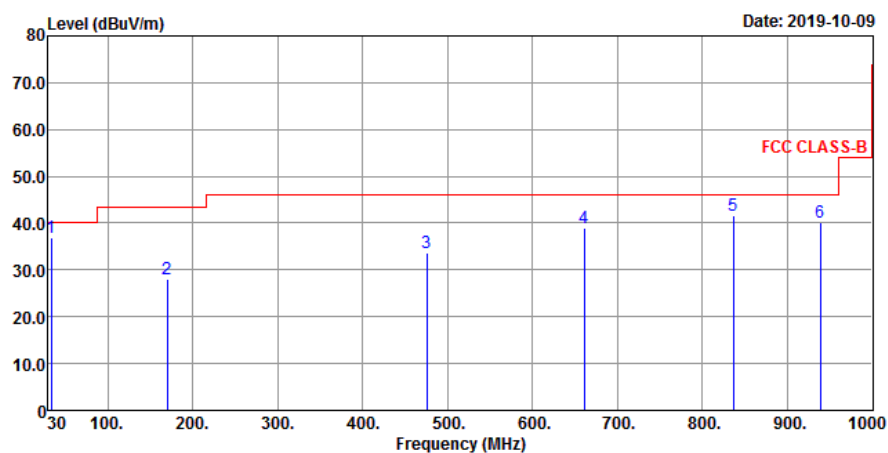

| Antenna Polarity & Test Distance: Horizontal at 3 m |                         |                   |               |                |             |                     |                      |        |
|---|-------------------------|-------------------|---------------|----------------|-------------|---------------------|----------------------|--------|
| Frequency (MHz)                                     | Emission Level (dBuV/m) | Read Level (dBuV) | Factor (dB/m) | Limit (dBuV/m) | Margin (dB) | Antenna Height (cm) | Table Angle (Degree) | Remark |
| 52.31   | 26.05                   | 43.72             | -17.67        | 40             | -13.95      | 134                 | 158                  | Peak   |
| 168.71  | 32.71                   | 50.19             | -17.48        | 43.5           | -10.79      | 105                 | 148                  | Peak   |
| 450.98  | 37.54                   | 49.84             | -12.3         | 46             | -8.46       | 211                 | 162                  | Peak   |
| 596.48  | 36.46                   | 44.84             | -8.38         | 46             | -9.54       | 194                 | 311                  | Peak   |
| 757.5   | 42.26                   | 47.12             | -4.86         | 46             | -3.74       | 182                 | 277                  | Peak   |
| 934.04  | 38.83                   | 41.63             | -2.8          | 46             | -7.17       | 202                 | 81                   | Peak   |
| Antenna Polarity & Test Distance: Vertical at 3 m   |                         |                   |               |                |             |                     |                      |        |
| Frequency (MHz)                                     | Emission Level (dBuV/m) | Read Level (dBuV) | Factor (dB/m) | Limit (dBuV/m) | Margin (dB) | Antenna Height (cm) | Table Angle (Degree) | Remark |
| 33.88   | 33.6                    | 50.55             | -16.95        | 40             | -6.4        | 103                 | 158                  | Peak   |
| 169.68  | 27.97                   | 45.59             | -17.62        | 43.5           | -15.53      | 114                 | 109                  | Peak   |
| 475.23  | 33.78                   | 45.82             | -12.04        | 46             | -12.22      | 102                 | 98                   | Peak   |
| 660.5   | 39.02                   | 46.67             | -7.65         | 46             | -6.98       | 113                 | 307                  | Peak   |
| 836.07  | 41.69                   | 46.01             | -4.32         | 46             | -4.31       | 114                 | 192                  | Peak   |
| 938.89  | 40.15                   | 42.93             | -2.78         | 46             | -5.85       | 108                 | 266                  | Peak   |

Remarks:

- Emission Level = Read Level + Factor  
Margin value = Emission level – Limit value
- The emission levels of other frequencies were very low against the limit.



## 5 Pictures of Test Arrangements

Please refer to the attached file (Test Setup Photo).

# Annex A- Band-edge measurement

<Bluetooth LE>

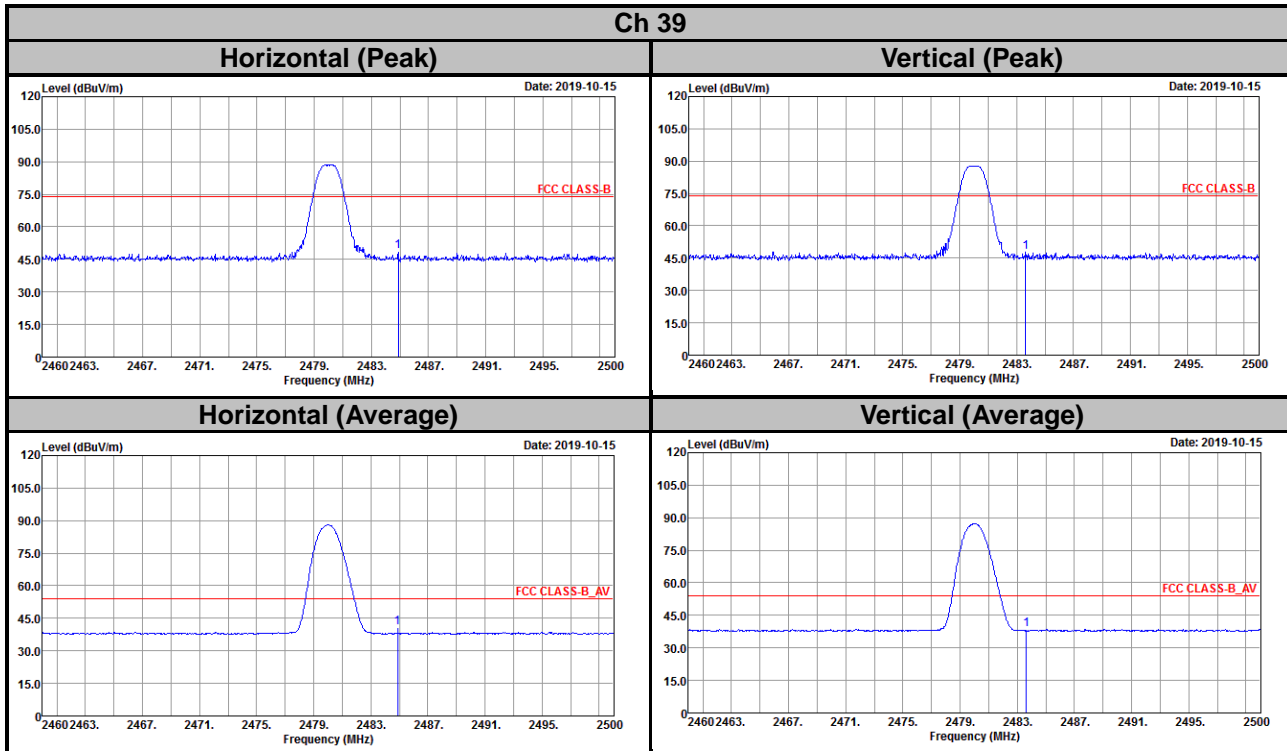

<WLAN>

802.11n (HT20)

Ch 13

Horizontal (Peak)

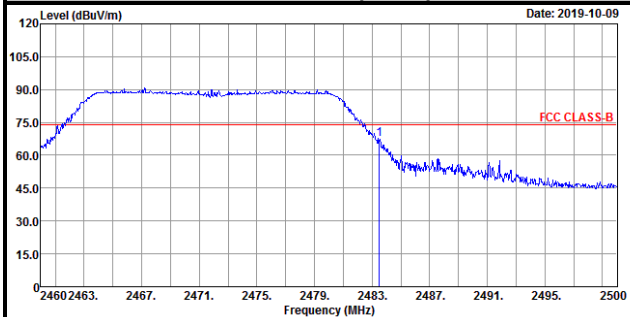

Vertical (Peak)

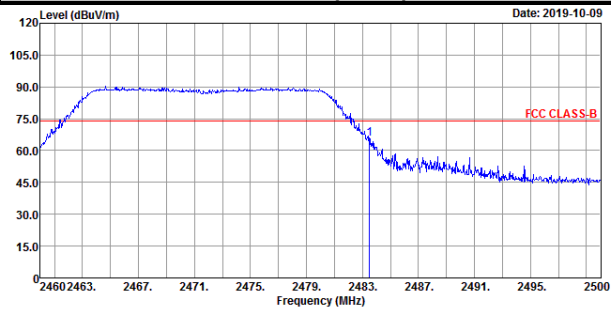

Horizontal (Average)

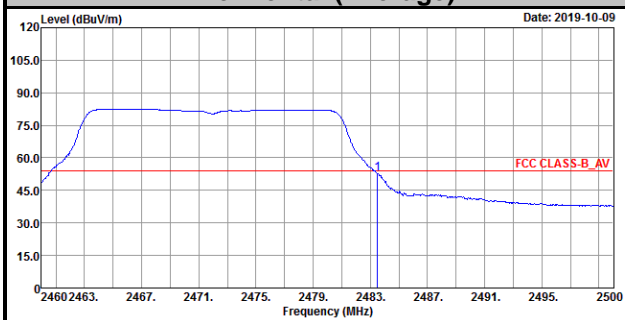

Vertical (Average)

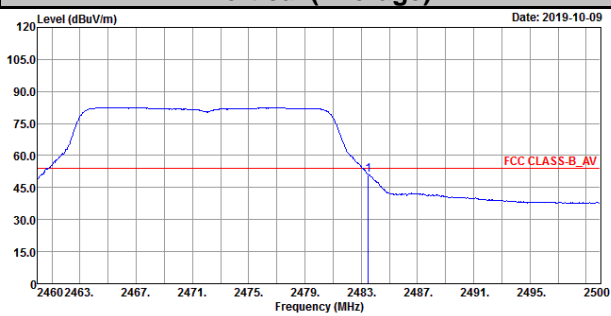

## Appendix – Information of the Testing Laboratories

We, Bureau Veritas Consumer Products Services (H.K.) Ltd., Taoyuan Branch, were founded in 1988 to provide our best service in EMC, Radio, Telecom and Safety consultation. Our laboratories are FCC recognized accredited test firms and accredited according to ISO/IEC 17025.

If you have any comments, please feel free to contact us at the following:

**Lin Kou EMC/RF Lab**

Tel: 886-2-26052180

Fax: 886-2-26051924

**Hsin Chu EMC/RF/Telecom Lab**

Tel: 886-3-6668565

Fax: 886-3-6668323

**Hwa Ya EMC/RF/Safety**

Tel: 886-3-3183232

Fax: 886-3-3270892

**Email:** [service.adt@tw.bureauveritas.com](mailto:service.adt@tw.bureauveritas.com)

**Web Site:** [www.bureauveritas-adt.com](http://www.bureauveritas-adt.com)

The address and road map of all our labs can be found in our web site also.

--- END ---