

Variant FCC Test Report

Report No.: RF170327C09A-2

FCC ID: UK7-DW5A

Received Date: Oct. 03, 2017

Test Date: Oct. 13, 2017 ~ Oct. 19, 2017

Issued Date: Oct. 26, 2017

Applicant: Fossil Group, Inc.

Address: 901 S. Central Expwy., Richardson, TX 75080 USA

Issued By: Bureau Veritas Consumer Products Services (H.K.) Ltd., Taoyuan Branch

Lab Address: No. 47-2, 14th Ling, Chia Pau Vil., Lin Kou Dist., New Taipei City, Taiwan (R.O.C)

Test Location (1): No.19, Hwa Ya 2nd Rd., Wen Hwa Vil., Kwei Shan Dist., Taoyuan City 33383, Taiwan, R.O.C.

Test Location (2): No.215, Sec. 3, Beixin Rd., Xindian Dist., New Taipei City 231, Taiwan, R.O.C



This report is for your exclusive use. Any copying or replication of this report to or for any other person or entity, or use of our name or trademark, is permitted only with our prior written permission. This report sets forth our findings solely with respect to the test samples identified herein. The results set forth in this report are not indicative or representative of the quality or characteristics of the lot from which a test sample was taken or any similar or identical product unless specifically and expressly noted. Our report includes all of the tests requested by you and the results thereof based upon the information that you provided to us. You have 60 days from date of issuance of this report to notify us of any material error or omission caused by our negligence, provided, however, that such notice shall be in writing and shall specifically address the issue you wish to raise. A failure to raise such issue within the prescribed time shall constitute your unqualified acceptance of the completeness of this report, the tests conducted and the correctness of the report contents. Unless specific mention, the uncertainty of measurement has been explicitly taken into account to declare the compliance or non-compliance to the specification.

Table of Contents

Release Control Record	3
1 Certificate of Conformity	4
2 Summary of Test Results.....	5
2.1 Measurement Uncertainty.....	5
2.2 Modification Record	5
3 General Information	6
3.1 General Description of EUT	6
3.2 Description of Test Modes.....	7
3.2.1 Test Mode Applicability and Tested Channel Detail.....	8
3.3 Description of Support Units	9
3.3.1 Configuration of System under Test	9
3.4 General Description of Applied Standards.....	9
4 Test Types and Results	10
4.1 Radiated Emission and Bandedge Measurement	10
4.1.1 Limits of Radiated Emission and Bandedge Measurement	10
4.1.2 Test Instruments	11
4.1.3 Test Procedures.....	12
4.1.4 Deviation from Test Standard	12
4.1.5 Test Set Up	13
4.1.6 EUT Operating Conditions.....	14
4.1.7 Test Results	15
4.2 Conducted Emission Measurement.....	79
4.2.1 Limits of Conducted Emission Measurement	79
4.2.2 Test Instruments	79
4.2.3 Test Procedures.....	80
4.2.4 Deviation from Test Standard	80
4.2.5 Test Setup.....	80
4.2.6 EUT Operating Conditions.....	80
4.2.7 Test Results	81
5 Pictures of Test Arrangements.....	85
Appendix – Information on the Testing Laboratories	86

Release Control Record

Issue No.	Description	Date Issued
RF170327C09A-2	Original Release	Oct. 26, 2017

1 Certificate of Conformity

Product: Smart Watch

Sample Status: Production Unit

Applicant: Fossil Group, Inc.

Test Date: Oct. 13, 2017 ~ Oct. 19, 2017

Standards: 47 CFR FCC Part 15, Subpart C (Section 15.247)
ANSI C63.10:2013

This report is issued as a supplementary report to BV CPS report no.: RF170327C09-2. This report shall be used by combining with its original report.

Prepared by :

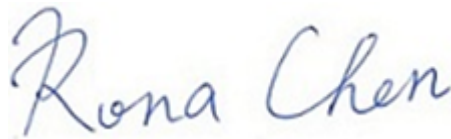

Date:

Oct. 26, 2017

Rona Chen / Specialist

Approved by :

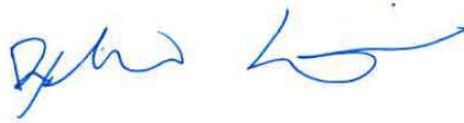

Date:

Oct. 26, 2017

Dylan Chiou / Project Engineer

2 Summary of Test Results

47 CFR FCC Part 15, Subpart C (Section 15.247)			
FCC Clause	Test Item	Result	Remarks
15.207	AC Power Conducted Emission	Pass	Meet the requirement of limit. Minimum passing margin is -2.38 dB at 4.28125 MHz.
15.205 / 15.209 / 15.247(d)	Radiated Emissions and Band Edge Measurement	Pass	Meet the requirement of limit. Minimum passing margin is -2.28 dB at 2483.56 MHz.
15.247(d)	Antenna Port Emission	N/A	Refer to Note
15.247(a)(2)	6 dB Bandwidth	N/A	Refer to Note
15.247(b)	Conducted power	N/A	Refer to Note
15.247(e)	Power Spectral Density	N/A	Refer to Note
15.203	Antenna Requirement	Pass	No antenna connector is used.

Note: Only Radiated Emissions and AC Power Conducted Emission tests had been performed for the addendum. Refer to original report for other test data.

2.1 Measurement Uncertainty

Where relevant, the following measurement uncertainty levels have been estimated for tests performed on the EUT:

The listed uncertainties are the worst case uncertainty for the entire range of measurement. Please note that the uncertainty values are provided for informational purposes only and are not used in determining the PASS/FAIL results.

Measurement	Frequency	Expanded Uncertainty (k=2) (\pm)
Conducted Emissions at mains ports	150 kHz ~ 30 MHz	2.44 dB
Radiated Emissions up to 1 GHz	30 MHz ~ 200 MHz	2.0153 dB
	200 MHz ~ 1000 MHz	2.0224 dB
Radiated Emissions above 1 GHz	1 GHz ~ 18 GHz	1.0121 dB
	18 GHz ~ 40 GHz	1.1508 dB

2.2 Modification Record

There were no modifications required for compliance.

3 General Information

3.1 General Description of EUT

Product	Smart Watch
Status of EUT	Production Unit
Power Supply Rating	5.0 Vdc (Wireless Charger) 3.8 Vdc (Li-ion battery)
Modulation Type	CCK, DQPSK, DBPSK for DSSS 64QAM, 16QAM, QPSK, BPSK for OFDM
Modulation Technology	DSSS, OFDM
Transfer Rate	802.11b: 11.0 / 5.5 / 2.0 / 1.0 Mbps 802.11g: 54.0 / 48.0 / 36.0 / 24.0 / 18.0 / 12.0 / 9.0 / 6.0 Mbps 802.11n: up to MCS7
Operating Frequency	2412 ~ 2472 MHz
Number of Channel	13 for 802.11b, 802.11g, 802.11n (HT20)
Antenna Type	Loop antenna
Antenna Connector	N/A
Accessory Device	Refer to Note as below
Data Cable Supplied	Refer to Note as below

Note:

1. This report is issued as a supplementary report to BV CPS report no.: RF170327C09-2. The difference compared with original report is changing antenna and appearance. Therefore, only Radiated Emissions and AC Power Conducted Emission tests had been performed in this report.
2. There are 2 configurations for the EUT which listed as below.

Sample	Antenna Gain (dBi)	Difference
A	-2.34	The models are different in the appearance and antenna only.
B	-4.91	

3. The above EUT information is declared by manufacturer and for more detailed features description, please refer to the manufacturer's specifications or user's manual.

3.2 Description of Test Modes

11 channels are provided for 802.11b, 802.11g and 802.11n (HT20):

Channel	Frequency (MHz)	Channel	Frequency (MHz)
1	2412	8	2447
2	2417	9	2452
3	2422	10	2457
4	2427	11	2462
5	2432	12	2467
6	2437	13	2472
7	2442		

3.2.1 Test Mode Applicability and Tested Channel Detail

EUT Configure Mode	Applicable To			Description
	RE \geq 1G	RE<1G	PLC	
A	√	√	√	Sample A
B	√	√	√	Sample B

Where **RE \geq 1G**: Radiated Emission above 1 GHz
RE<1G: Radiated Emission below 1 GHz
PLC: Power Line Conducted Emission
APCM: Antenna Port Conducted Measurement

NOTE: The EUT had been pre-tested on the positioned of each 3 axis. The worst case was found when positioned on **Z-plane**.

Radiated Emission Test (Above 1 GHz):

- Pre-Scan has been conducted to determine the worst-case mode from all possible combinations between available modulations, data rates and antenna ports (if EUT with antenna diversity architecture).
- Following channel(s) was (were) selected for the final test as listed below.

EUT Configure Mode	Mode	Available Channel	Tested Channel	Modulation Technology	Modulation Type	Data Rate (Mbps)
A, B	802.11b	1 to 13	1, 6, 11, 12, 13	DSSS	DBPSK	1.0
	802.11g	1 to 13	1, 6, 11, 12, 13	OFDM	BPSK	6.0
	802.11n (HT20)	1 to 13	1, 6, 11, 12, 13	OFDM	BPSK	MCS0

Radiated Emission Test (Below 1 GHz):

- Pre-Scan has been conducted to determine the worst-case mode from all possible combinations between available modulations, data rates and antenna ports (if EUT with antenna diversity architecture).
- Following channel(s) was (were) selected for the final test as listed below.

EUT Configure Mode	Mode	Available Channel	Tested Channel	Modulation Technology	Modulation Type	Data Rate (Mbps)
A, B	802.11n (HT20)	1 to 13	13	OFDM	BPSK	MCS0

Power Line Conducted Emission Test:

- Pre-Scan has been conducted to determine the worst-case mode from all possible combinations between available modulations, data rates and antenna ports (if EUT with antenna diversity architecture).
- Following channel(s) was (were) selected for the final test as listed below.

EUT Configure Mode	Mode	Available Channel	Tested Channel	Modulation Technology	Modulation Type	Data Rate (Mbps)
A, B	802.11n (HT20)	1 to 13	13	OFDM	BPSK	MCS0

Test Condition:

Applicable To	Environmental Conditions	Input Power	Tested by
RE \geq 1G	25 deg. C, 65 % RH	5 Vdc	Karl Lee
RE<1G	25 deg. C, 65 % RH	5 Vdc	Karl Lee
PLC	25 deg. C, 65 % RH	5 Vdc	Getaz Yang

3.3 Description of Support Units

The EUT has been tested as an independent unit together with other necessary accessories or support units. The following support units or accessories were used to form a representative test configuration during the tests.

No.	Product	Brand	Model No.	Serial No.	FCC ID
1.	Adapter	N/A	N/A	N/A	N/A

No.	Signal Cable Description Of The Above Support Units
1.	N/A

Note:

1. All power cords of the above support units are non-shielded (1.8m).

3.3.1 Configuration of System under Test

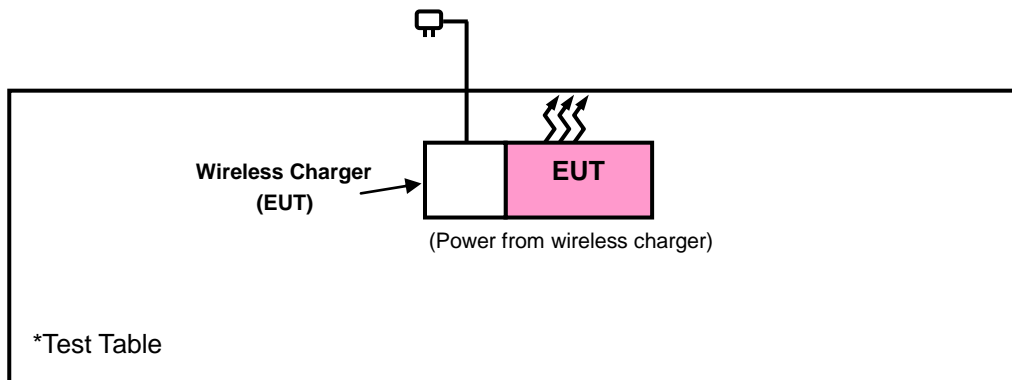

3.4 General Description of Applied Standards

The EUT is a RF Product. According to the specifications of the manufacturer, it must comply with the requirements of the following standards:

FCC Part 15, Subpart C (15.247)

558074 D01 DTS Meas Guidance v04

ANSI C63.10-2013

All test items have been performed and recorded as per the above standards.

NOTE: The EUT has been verified to comply with the requirements of FCC Part 15, Subpart B, Class B (DoC). The test report has been issued separately.

4 Test Types and Results

4.1 Radiated Emission and Bandedge Measurement

4.1.1 Limits of Radiated Emission and Bandedge Measurement

Radiated emissions which fall in the restricted bands must comply with the radiated emission limits specified as below table. Other emissions shall be at least 20 dB below the highest level of the desired power:

Frequencies (MHz)	Field Strength (microvolts/meter)	Measurement Distance (meters)
0.009 ~ 0.490	2400/F (kHz)	300
0.490 ~ 1.705	24000/F (kHz)	30
1.705 ~ 30.0	30	30
30 ~ 88	100	3
88 ~ 216	150	3
216 ~ 960	200	3
Above 960	500	3

NOTE:

1. The lower limit shall apply at the transition frequencies.
2. Emission level (dBuV/m) = 20 log Emission level (uV/m).
3. For frequencies above 1000 MHz, the field strength limits are based on average detector, however, the peak field strength of any emission shall not exceed the maximum permitted average limits, specified above by more than 20 dB under any condition of modulation.

4.1.2 Test Instruments

Description & Manufacturer	Model No.	Serial No.	Date of Calibration	Due Date of Calibration
Test Receiver Agilent Technologies	N9038A	MY52260177	Jul. 05, 2017	Jul. 04, 2018
Spectrum Analyzer ROHDE & SCHWARZ	FSU43	101261	Dec. 13, 2016	Dec. 12, 2017
BILOG Antenna SCHWARZBECK	VULB9168	9168-472	Dec. 16, 2016	Dec. 15, 2017
HORN Antenna ETS-Lindgren	3117	00143293	Dec. 29, 2016	Dec. 28, 2017
HORN Antenna SCHWARZBECK	BBHA 9170	9170-480	Dec. 14, 2016	Dec. 13, 2017
Fixed Attenuator Mini-Circuits	MDCS18N-10	MDCS18N-10-01	Apr. 17, 2017	Apr. 16, 2018
Bluetooth Tester	CBT	100980	Jun. 28, 2017	Jun. 27, 2019
Loop Antenna	HLA 6121	45745	May 19, 2017	May 18, 2018
Preamplifier Agilent	310N	187226	Jun. 23, 2017	Jun. 22, 2018
Preamplifier Agilent	83017A	MY39501357	Jun. 23, 2017	Jun. 22, 2018
RF signal cable ETS-LINDGREN	5D-FB	Cable-CH1-01(R FC-SMS-100-SM S-120+RFC-SMS -100-SMS-400)	Jun. 23, 2017	Jun. 22, 2018
RF signal cable ETS-LINDGREN	8D-FB	Cable-CH1-02(R FC-SMS-100-SM S-24)	Jun. 23, 2017	Jun. 22, 2018
Software BV ADT	E3 8.130425b	NA	NA	NA
Antenna Tower MF	NA	NA	NA	NA
Turn Table MF	NA	NA	NA	NA
Antenna Tower & Turn Table Controller MF	MF-7802	NA	NA	NA

- Note: 1. The calibration interval of the above test instruments is 12 months and the calibrations are traceable to NML/ROC and NIST/USA.
2. The test was performed in HsinTien Chamber 1.
3. The horn antenna and preamplifier (model: 83017A) are used only for the measurement of emission frequency above 1 GHz if tested.
4. The FCC Designation Number is TW0011. The number will be varied with the Lab location and scope as attached.
5. The IC Site Registration No. is IC7450I-1.

4.1.3 Test Procedures

- a. The EUT was placed on the top of a rotating table 0.8 meters (for below 1 GHz) / 1.5 meters (for above 1 GHz) above the ground at 3 meter chamber room for test. The table was rotated 360 degrees to determine the position of the highest radiation.
- b. The EUT was set 3 meters away from the interference-receiving antenna, which was mounted on the top of a variable-height antenna tower.
- c. The height of antenna is varied from one meter to four meters above the ground to determine the maximum value of the field strength. Both horizontal and vertical polarizations of the antenna are set to make the measurement.
- d. For each suspected emission, the EUT was arranged to its worst case and then the antenna was tuned to heights from 1 meter to 4 meters and the rotatable table was turned from 0 degrees to 360 degrees to find the maximum reading.
- e. The test-receiver system was set to quasi-peak detect function and specified bandwidth with maximum hold mode when the test frequency is below 1 GHz.
- f. The test-receiver system was set to peak and average detected function and specified bandwidth with maximum hold mode when the test frequency is above 1 GHz. If the peak reading value also meets average limit, measurement with the average detector is unnecessary.

Note:

1. The resolution bandwidth and video bandwidth of test receiver/spectrum analyzer is 120 kHz & 360 KHz for Quasi-peak detection (QP) at frequency below 1 GHz.
2. The resolution bandwidth of test receiver/spectrum analyzer is 1 MHz and the video bandwidth is 3 MHz for Peak detection (PK) at frequency above 1 GHz.
3. The resolution bandwidth of test receiver/spectrum analyzer is 1 MHz and the video bandwidth is 1/T for Average (Duty cycle < 98 %) detection at frequency above 1 GHz.
4. The resolution bandwidth of test receiver/spectrum analyzer is 1 MHz and the video bandwidth is 10 Hz (Duty cycle \geq 98 %) for Average detection (AV) at frequency above 1 GHz.
5. All modes of operation were investigated and the worst-case emissions are reported.

4.1.4 Deviation from Test Standard

No deviation.

4.1.5 Test Set Up

<Radiated emission below 30 MHz>

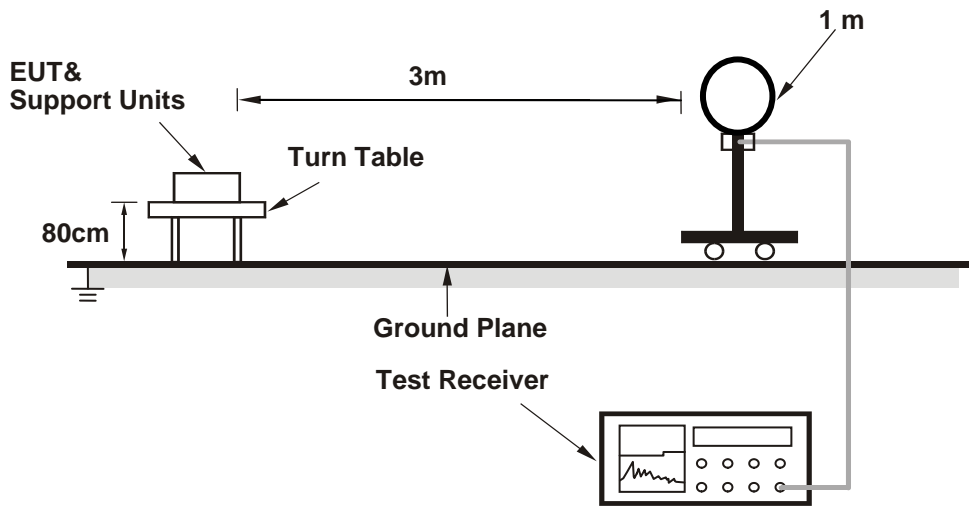

<Frequency Range below 1 GHz>

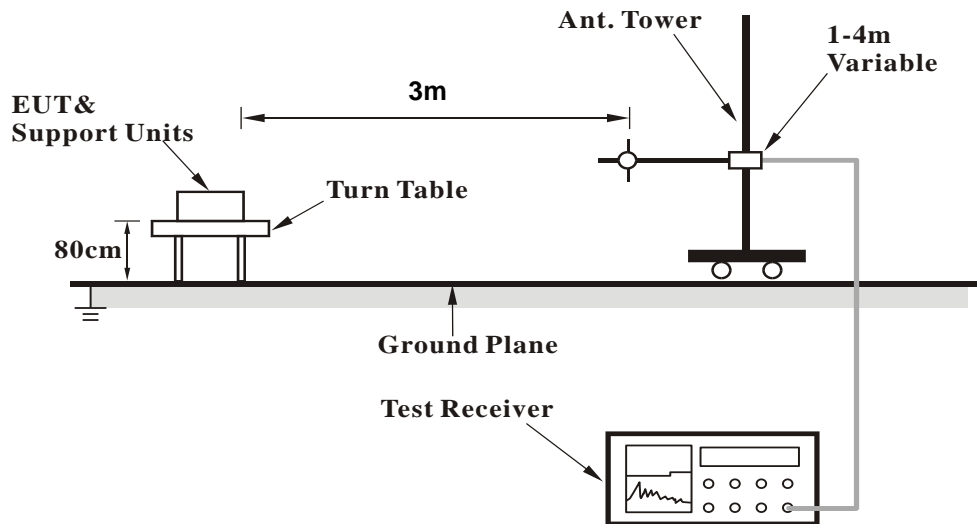

<Frequency Range above 1 GHz>

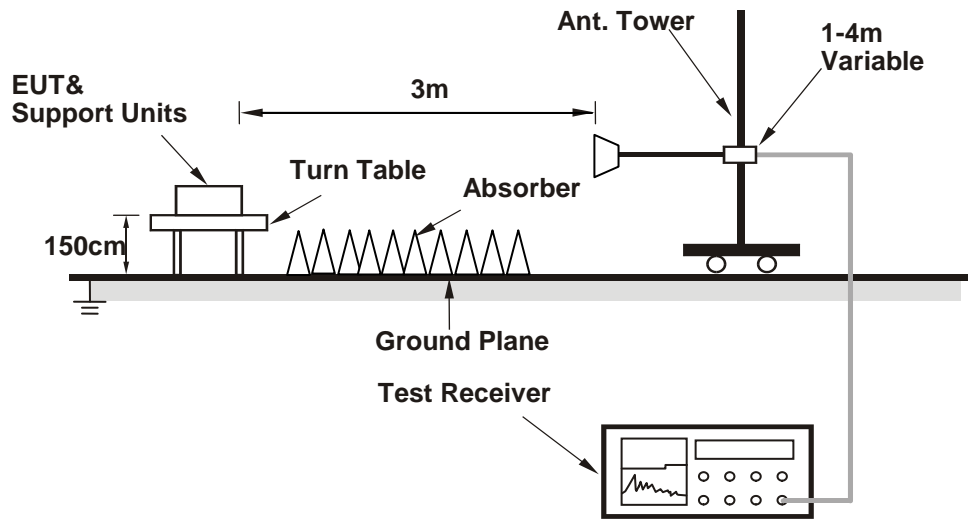

For the actual test configuration, please refer to the attached file (Test Setup Photo).

4.1.6 EUT Operating Conditions

- a. Placed the EUT on a testing table.
- b. Use the software to control the EUT under transmission condition continuously at specific channel frequency.

4.1.7 Test Results

Above 1 GHz Data :

Mode A

802.11b

EUT Test Condition		Measurement Detail	
Channel	Channel 1	Frequency Range	1 GHz ~ 25 GHz
Input Power	120 Vac, 60 Hz	Detector Function	Peak (PK) Average (AV)
Environmental Conditions	25 deg. C, 65 % RH	Tested By	Karl Lee

Horizontal

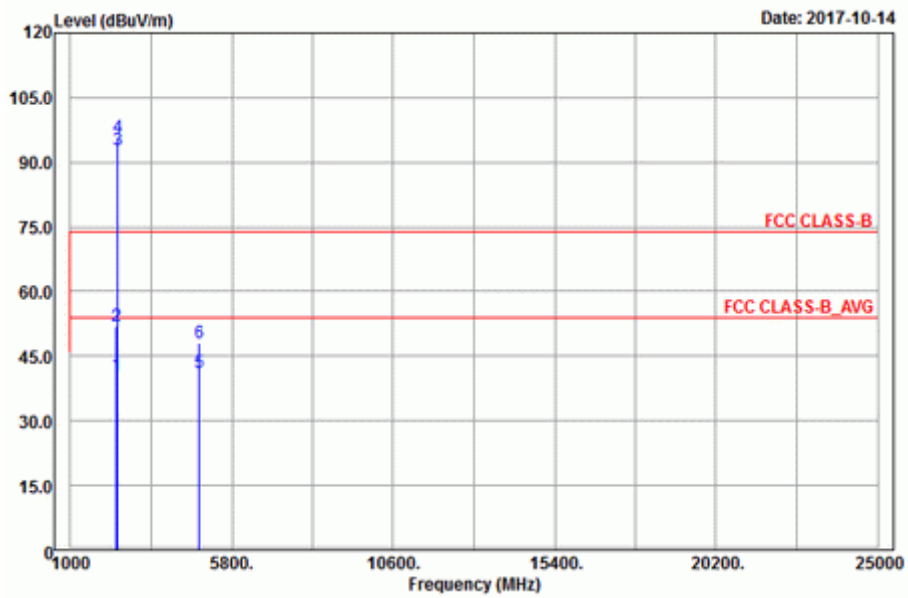

Vertical

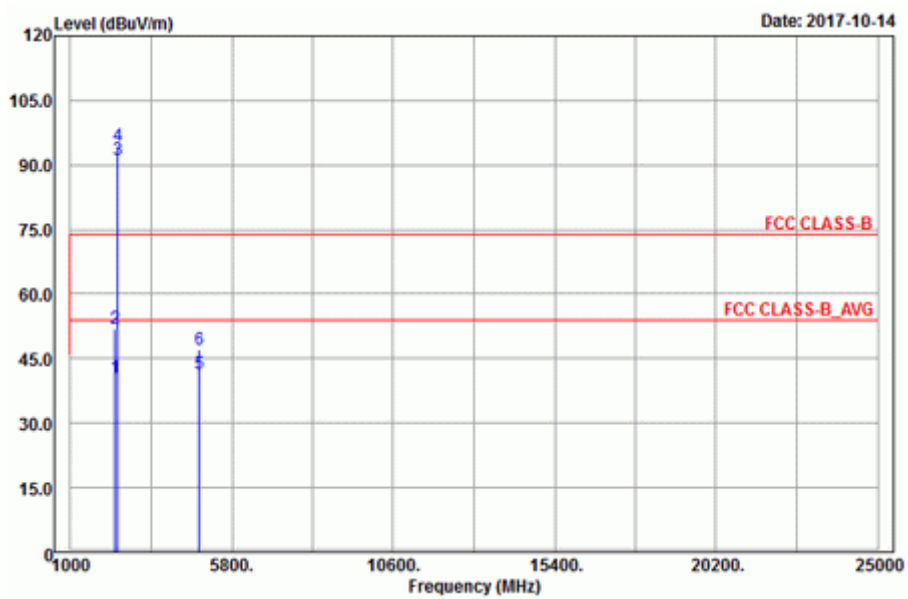

Antennal Polarity & Test Distance: Horizontal at 3 m

Frequency (MHz)	Emission Level (dBuV/m)	Read Level (dBuV)	Limit (dBuV/m)	Margin (dB)	Antenna Factor (dB/m)	Cable Loss (dB)	Preamp Factor (dB)	Antenna Height (cm)	Table Angle (Degree)	Remark
2368.23	40.53	38.89	54	-13.47	31.76	5.37	35.49	299	345	Average
2368.23	52.02	50.38	74	-21.98	31.76	5.37	35.49	299	345	Peak
2412	92.91	91.14			31.81	5.43	35.47	299	345	Average
2412	95.94	94.17			31.81	5.43	35.47	299	345	Peak
4824	41.13	33	54	-12.87	33.97	8.26	34.1	127	248	Average
4824	48.18	40.05	74	-25.82	33.97	8.26	34.1	127	248	Peak

Antennal Polarity & Test Distance: Vertical at 3 m

Frequency (MHz)	Emission Level (dBuV/m)	Read Level (dBuV)	Limit (dBuV/m)	Margin (dB)	Antenna Factor (dB/m)	Cable Loss (dB)	Preamp Factor (dB)	Antenna Height (cm)	Table Angle (Degree)	Remark
2324.85	40.51	39	54	-13.49	31.73	5.3	35.52	176	305	Average
2324.85	51.88	50.37	74	-22.12	31.73	5.3	35.52	176	305	Peak
2412	91.36	89.59			31.81	5.43	35.47	176	305	Average
2412	94.53	92.76			31.81	5.43	35.47	176	305	Peak
4824	41.37	33.24	54	-12.63	33.97	8.26	34.1	105	360	Average
4824	47.19	39.06	74	-26.81	33.97	8.26	34.1	105	360	Peak

Remarks:

- Emission Level = Read Level + Antenna Factor + Cable Loss - Preamp Factor
Margin value = Emission level – Limit value
- 2412 MHz: Fundamental frequency.

EUT Test Condition		Measurement Detail	
Channel	Channel 6	Frequency Range	1 GHz ~ 25 GHz
Input Power	120 Vac, 60 Hz	Detector Function	Peak (PK) Average (AV)
Environmental Conditions	25 deg. C, 65 % RH	Tested By	Karl Lee

Horizontal

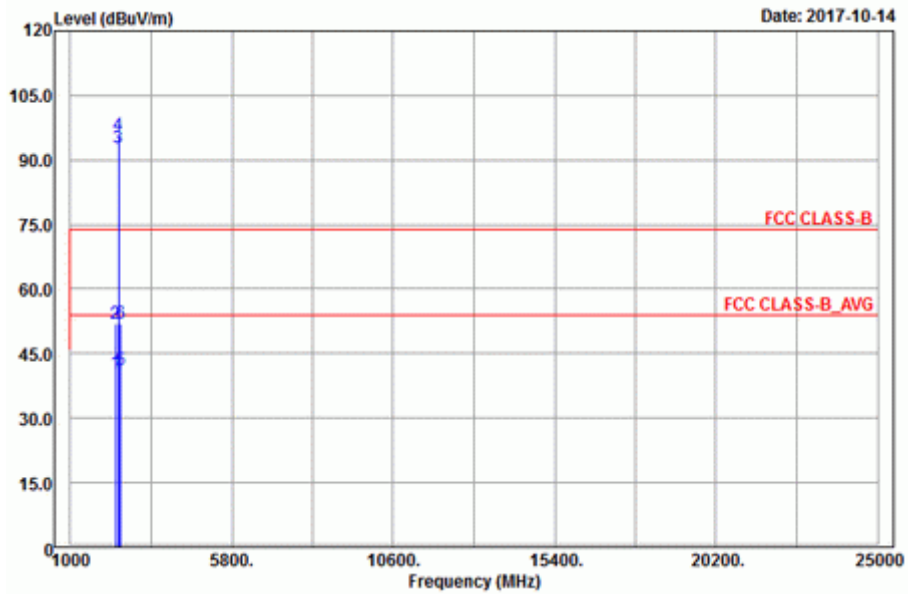

Vertical

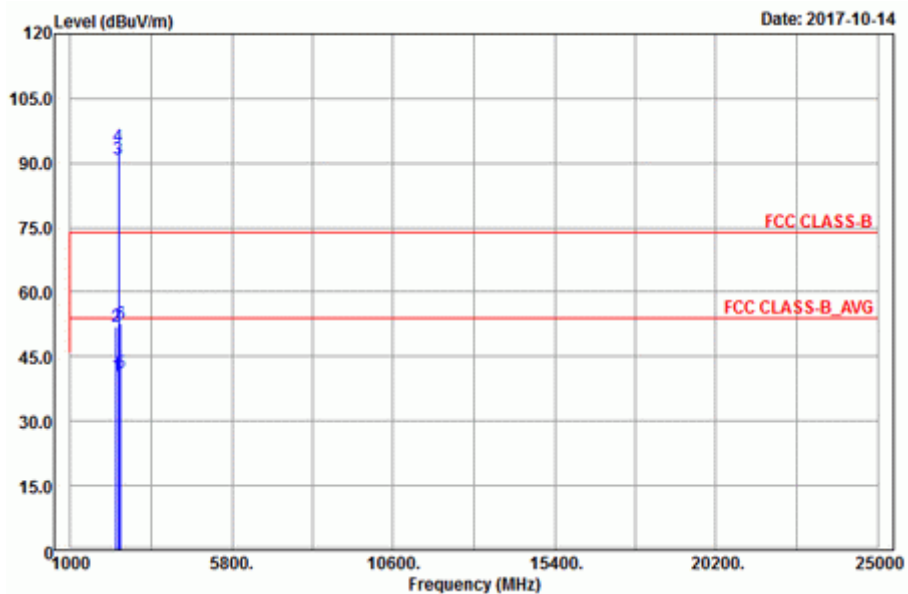

Antennal Polarity & Test Distance: Horizontal at 3 m

Frequency (MHz)	Emission Level (dBuV/m)	Read Level (dBuV)	Limit (dBuV/m)	Margin (dB)	Antenna Factor (dB/m)	Cable Loss (dB)	Preamp Factor (dB)	Antenna Height (cm)	Table Angle (Degree)	Remark
2348.88	40.52	38.95	54	-13.48	31.74	5.33	35.5	299	345	Average
2348.88	51.96	50.39	74	-22.04	31.74	5.33	35.5	299	345	Peak
2437	92.71	90.86			31.85	5.46	35.46	299	345	Average
2437	95.74	93.89			31.85	5.46	35.46	299	345	Peak
2499.88	41.1	39.08	54	-12.9	31.9	5.53	35.41	299	345	Average
2499.88	52.06	50.04	74	-21.94	31.9	5.53	35.41	299	345	Peak

Antennal Polarity & Test Distance: Vertical at 3 m

Frequency (MHz)	Emission Level (dBuV/m)	Read Level (dBuV)	Limit (dBuV/m)	Margin (dB)	Antenna Factor (dB/m)	Cable Loss (dB)	Preamp Factor (dB)	Antenna Height (cm)	Table Angle (Degree)	Remark
2374.35	40.57	38.91	54	-13.43	31.78	5.37	35.49	176	305	Average
2374.35	51.93	50.27	74	-22.07	31.78	5.37	35.49	176	305	Peak
2437	90.93	89.08			31.85	5.46	35.46	176	305	Average
2437	93.97	92.12			31.85	5.46	35.46	176	305	Peak
2487	41.07	39.08	54	-12.93	31.88	5.53	35.42	176	305	Average
2487	52.67	50.68	74	-21.33	31.88	5.53	35.42	176	305	Peak

Remarks:

- Emission Level = Read Level + Antenna Factor + Cable Loss - Preamp Factor
Margin value = Emission level – Limit value
- 2437 MHz: Fundamental frequency.

EUT Test Condition		Measurement Detail	
Channel	Channel 11	Frequency Range	1 GHz ~ 25 GHz
Input Power	120 Vac, 60 Hz	Detector Function	Peak (PK) Average (AV)
Environmental Conditions	25 deg. C, 65 % RH	Tested By	Karl Lee

Horizontal

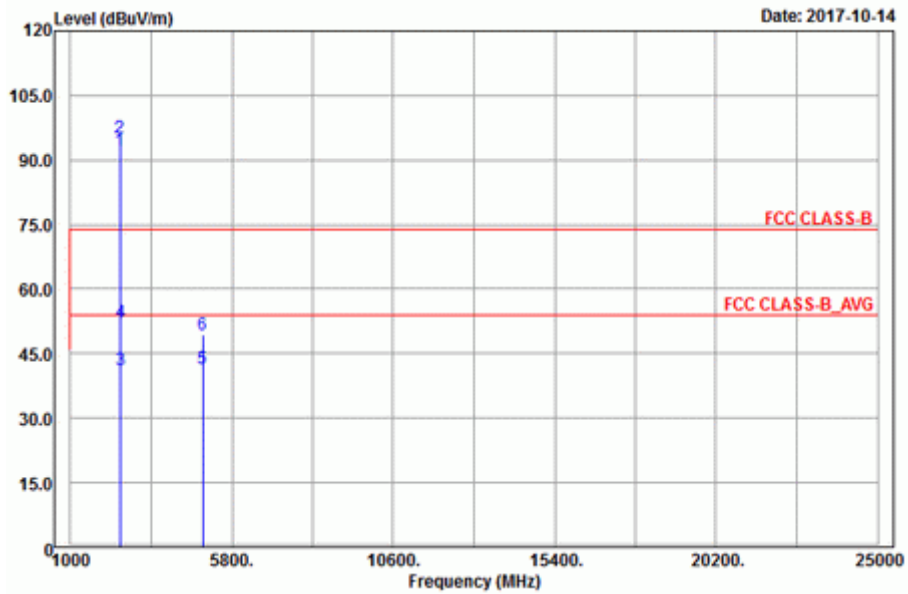

Vertical

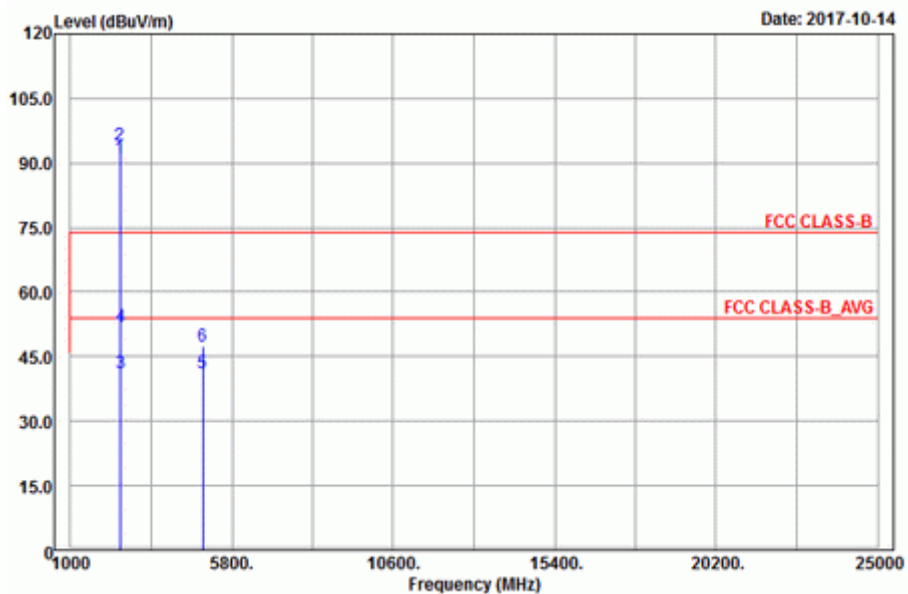

Antennal Polarity & Test Distance: Horizontal at 3 m

Frequency (MHz)	Emission Level (dBuV/m)	Read Level (dBuV)	Limit (dBuV/m)	Margin (dB)	Antenna Factor (dB/m)	Cable Loss (dB)	Preamp Factor (dB)	Antenna Height (cm)	Table Angle (Degree)	Remark
2462	92.07	90.14			31.87	5.5	35.44	299	313	Average
2462	95.17	93.24			31.87	5.5	35.44	299	313	Peak
2486.92	41.07	39.08	54	-12.93	31.88	5.53	35.42	299	313	Average
2486.92	52.28	50.29	74	-21.72	31.88	5.53	35.42	299	313	Peak
4924	41.6	33.35	54	-12.4	33.99	8.28	34.02	114	95	Average
4924	49.24	40.99	74	-24.76	33.99	8.28	34.02	114	95	Peak

Antennal Polarity & Test Distance: Vertical at 3 m

Frequency (MHz)	Emission Level (dBuV/m)	Read Level (dBuV)	Limit (dBuV/m)	Margin (dB)	Antenna Factor (dB/m)	Cable Loss (dB)	Preamp Factor (dB)	Antenna Height (cm)	Table Angle (Degree)	Remark
2462	91.22	89.29			31.87	5.5	35.44	185	91	Average
2462	94.15	92.22			31.87	5.5	35.44	185	91	Peak
2498.96	41.1	39.08	54	-12.9	31.9	5.53	35.41	185	91	Average
2498.96	51.94	49.92	74	-22.06	31.9	5.53	35.41	185	91	Peak
4924	41.26	33.01	54	-12.74	33.99	8.28	34.02	106	246	Average
4924	47.32	39.07	74	-26.68	33.99	8.28	34.02	106	246	Peak

Remarks:

- Emission Level = Read Level + Antenna Factor + Cable Loss - Preamp Factor
Margin value = Emission level – Limit value
- 2462 MHz: Fundamental frequency.

EUT Test Condition		Measurement Detail	
Channel	Channel 12	Frequency Range	1 GHz ~ 25 GHz
Input Power	120 Vac, 60 Hz	Detector Function	Peak (PK) Average (AV)
Environmental Conditions	25 deg. C, 65 % RH	Tested By	Karl Lee

Horizontal

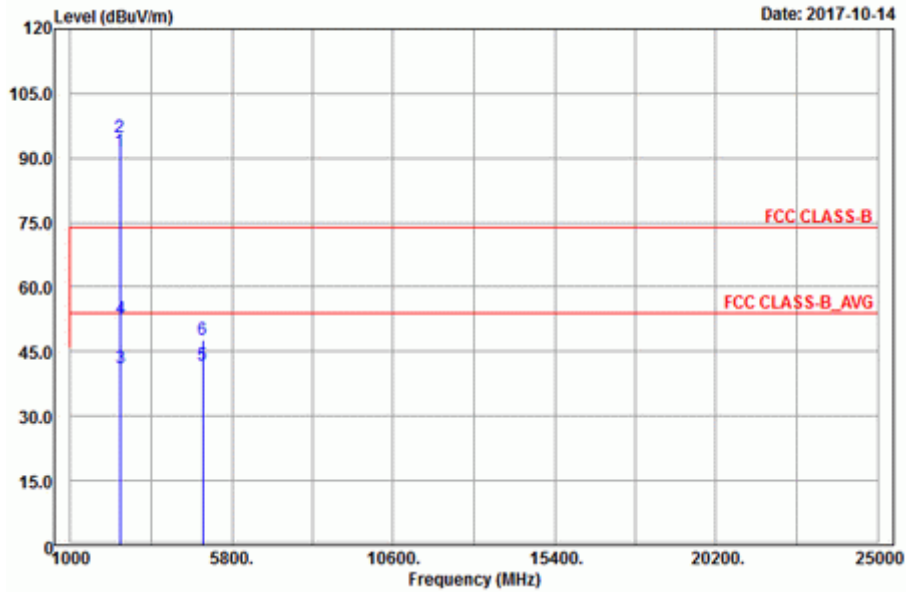

Vertical

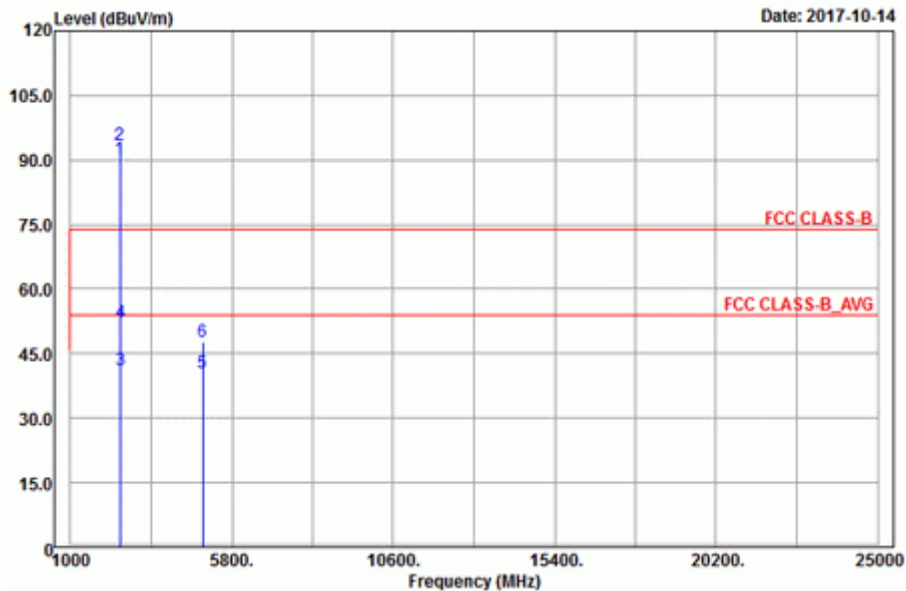

Antennal Polarity & Test Distance: Horizontal at 3 m

Frequency (MHz)	Emission Level (dBuV/m)	Read Level (dBuV)	Limit (dBuV/m)	Margin (dB)	Antenna Factor (dB/m)	Cable Loss (dB)	Preamp Factor (dB)	Antenna Height (cm)	Table Angle (Degree)	Remark
2467	91.64	89.69			31.87	5.5	35.42	299	323	Average
2467	94.68	92.73			31.87	5.5	35.42	299	323	Peak
2484.72	41.26	39.27	54	-12.74	31.88	5.53	35.42	299	323	Average
2484.72	52.75	50.76	74	-21.25	31.88	5.53	35.42	299	323	Peak
4934	41.74	33.48	54	-12.26	33.99	8.29	34.02	144	211	Average
4934	47.84	39.58	74	-26.16	33.99	8.29	34.02	144	211	Peak

Antennal Polarity & Test Distance: Vertical at 3 m

Frequency (MHz)	Emission Level (dBuV/m)	Read Level (dBuV)	Limit (dBuV/m)	Margin (dB)	Antenna Factor (dB/m)	Cable Loss (dB)	Preamp Factor (dB)	Antenna Height (cm)	Table Angle (Degree)	Remark
2467	90.28	88.33			31.87	5.5	35.42	235	96	Average
2467	93.36	91.41			31.87	5.5	35.42	235	96	Peak
2484.24	41.2	39.21	54	-12.8	31.88	5.53	35.42	235	96	Average
2484.24	52.34	50.35	74	-21.66	31.88	5.53	35.42	235	96	Peak
4934	40.44	32.18	54	-13.56	33.99	8.29	34.02	121	316	Average
4934	47.75	39.49	74	-26.25	33.99	8.29	34.02	121	316	Peak

Remarks:

- Emission Level = Read Level + Antenna Factor + Cable Loss - Preamp Factor
Margin value = Emission level – Limit value
- 2467 MHz: Fundamental frequency.

EUT Test Condition		Measurement Detail	
Channel	Channel 13	Frequency Range	1 GHz ~ 25 GHz
Input Power	120 Vac, 60 Hz	Detector Function	Peak (PK) Average (AV)
Environmental Conditions	25 deg. C, 65 % RH	Tested By	Karl Lee

Horizontal

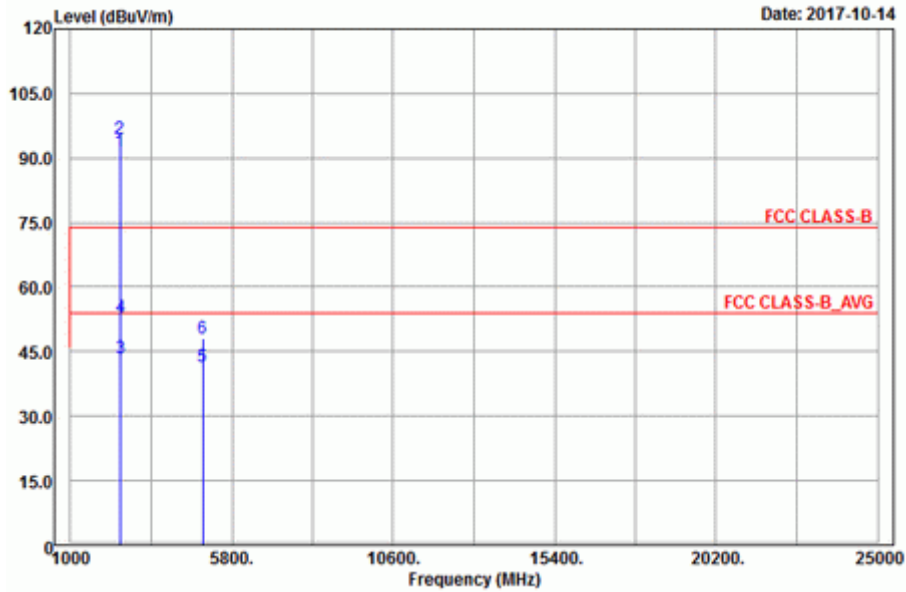

Vertical

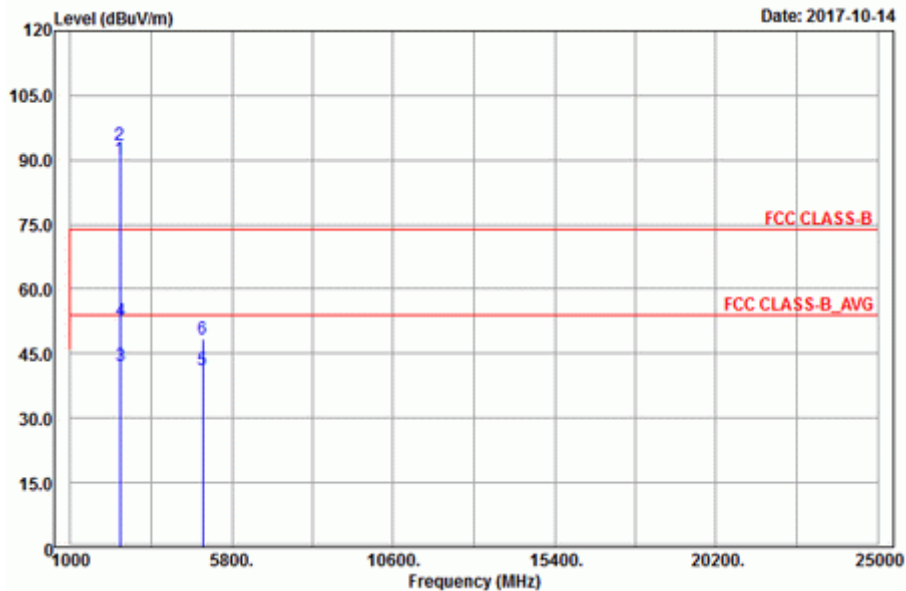

Antennal Polarity & Test Distance: Horizontal at 3 m

Frequency (MHz)	Emission Level (dBuV/m)	Read Level (dBuV)	Limit (dBuV/m)	Margin (dB)	Antenna Factor (dB/m)	Cable Loss (dB)	Preamp Factor (dB)	Antenna Height (cm)	Table Angle (Degree)	Remark
2472	91.49	89.53			31.88	5.5	35.42	299	323	Average
2472	94.41	92.45			31.88	5.5	35.42	299	323	Peak
2483.64	43.55	41.59	54	-10.45	31.88	5.5	35.42	299	323	Average
2483.64	53.13	51.17	74	-20.87	31.88	5.5	35.42	299	323	Peak
4944	41.59	33.32	54	-12.41	33.99	8.29	34.01	114	32	Average
4944	48.14	39.87	74	-25.86	33.99	8.29	34.01	114	32	Peak

Antennal Polarity & Test Distance: Vertical at 3 m

Frequency (MHz)	Emission Level (dBuV/m)	Read Level (dBuV)	Limit (dBuV/m)	Margin (dB)	Antenna Factor (dB/m)	Cable Loss (dB)	Preamp Factor (dB)	Antenna Height (cm)	Table Angle (Degree)	Remark
2472	90.36	88.4			31.88	5.5	35.42	235	96	Average
2472	93.46	91.5			31.88	5.5	35.42	235	96	Peak
2483.6	42.25	40.29	54	-11.75	31.88	5.5	35.42	235	96	Average
2483.6	52.73	50.77	74	-21.27	31.88	5.5	35.42	235	96	Peak
4944	41.16	32.89	54	-12.84	33.99	8.29	34.01	148	240	Average
4944	48.24	39.97	74	-25.76	33.99	8.29	34.01	148	240	Peak

Remarks:

- Emission Level = Read Level + Antenna Factor + Cable Loss - Preamp Factor
Margin value = Emission level – Limit value
- 2472 MHz: Fundamental frequency.

802.11g

EUT Test Condition		Measurement Detail	
Channel	Channel 1	Frequency Range	1 GHz ~ 25 GHz
Input Power	120 Vac, 60 Hz	Detector Function	Peak (PK) Average (AV)
Environmental Conditions	25 deg. C, 65 % RH	Tested By	Karl Lee

Horizontal

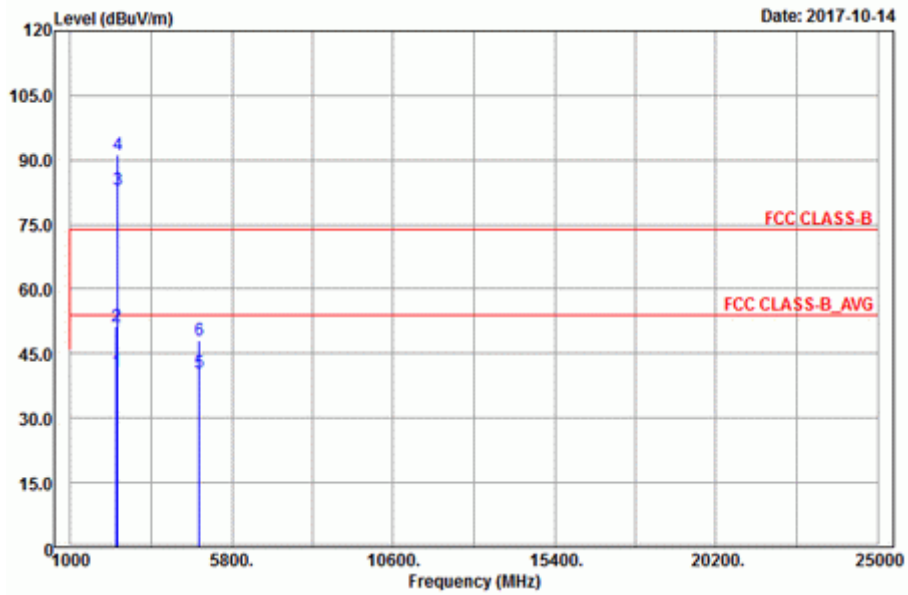

Vertical

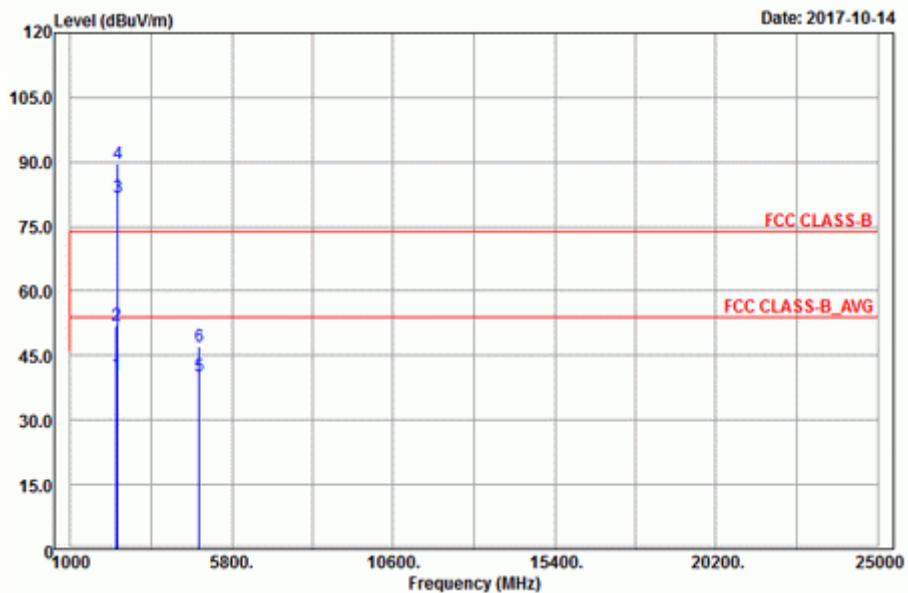

Antennal Polarity & Test Distance: Horizontal at 3 m

Frequency (MHz)	Emission Level (dBuV/m)	Read Level (dBuV)	Limit (dBuV/m)	Margin (dB)	Antenna Factor (dB/m)	Cable Loss (dB)	Preamp Factor (dB)	Antenna Height (cm)	Table Angle (Degree)	Remark
2362.02	40.79	39.16	54	-13.21	31.76	5.37	35.5	299	345	Average
2362.02	51.21	49.58	74	-22.79	31.76	5.37	35.5	299	345	Peak
2412	83.01	81.24			31.81	5.43	35.47	299	345	Average
2412	91.32	89.55			31.81	5.43	35.47	299	345	Peak
4824	40.61	32.48	54	-13.39	33.97	8.26	34.1	124	330	Average
4824	48.14	40.01	74	-25.86	33.97	8.26	34.1	124	330	Peak

Antennal Polarity & Test Distance: Vertical at 3 m

Frequency (MHz)	Emission Level (dBuV/m)	Read Level (dBuV)	Limit (dBuV/m)	Margin (dB)	Antenna Factor (dB/m)	Cable Loss (dB)	Preamp Factor (dB)	Antenna Height (cm)	Table Angle (Degree)	Remark
2370.84	40.49	38.83	54	-13.51	31.78	5.37	35.49	176	305	Average
2370.84	52.05	50.39	74	-21.95	31.78	5.37	35.49	176	305	Peak
2412	81.71	79.94			31.81	5.43	35.47	176	305	Average
2412	89.57	87.8			31.81	5.43	35.47	176	305	Peak
4824	40.35	32.22	54	-13.65	33.97	8.26	34.1	124	334	Average
4824	47.01	38.88	74	-26.99	33.97	8.26	34.1	124	334	Peak

Remarks:

- Emission Level = Read Level + Antenna Factor + Cable Loss - Preamp Factor
Margin value = Emission level – Limit value
- 2412 MHz: Fundamental frequency.

EUT Test Condition		Measurement Detail	
Channel	Channel 6	Frequency Range	1 GHz ~ 25 GHz
Input Power	120 Vac, 60 Hz	Detector Function	Peak (PK) Average (AV)
Environmental Conditions	25 deg. C, 65 % RH	Tested By	Karl Lee

Horizontal

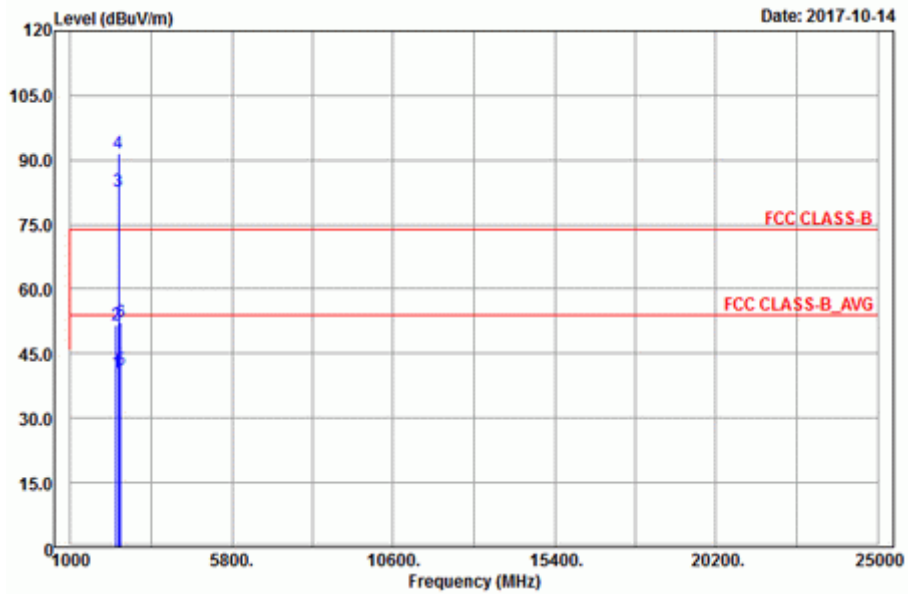

Vertical

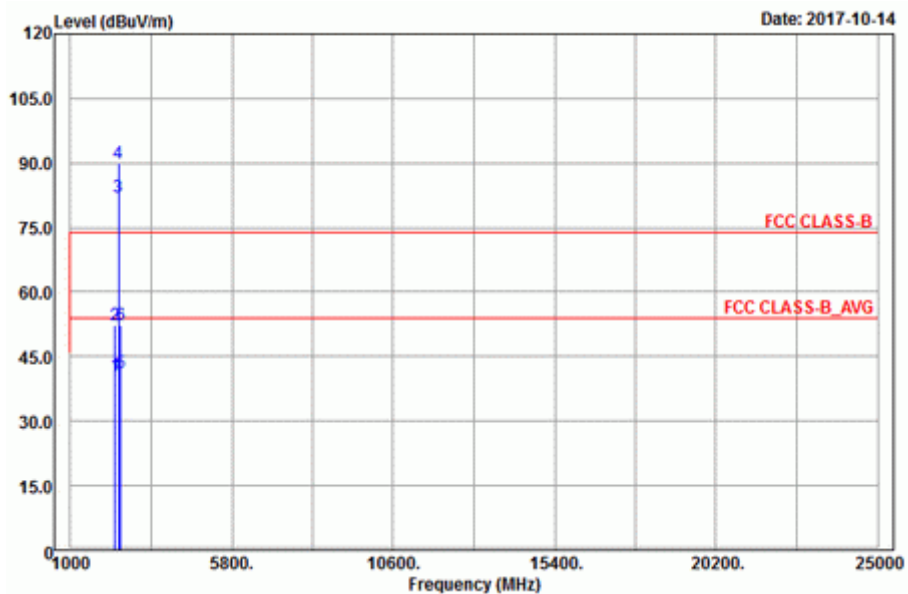

Antennal Polarity & Test Distance: Horizontal at 3 m

Frequency (MHz)	Emission Level (dBuV/m)	Read Level (dBuV)	Limit (dBuV/m)	Margin (dB)	Antenna Factor (dB/m)	Cable Loss (dB)	Preamp Factor (dB)	Antenna Height (cm)	Table Angle (Degree)	Remark
2374.89	40.59	38.93	54	-13.41	31.78	5.37	35.49	299	345	Average
2374.89	51.6	49.94	74	-22.4	31.78	5.37	35.49	299	345	Peak
2437	82.57	80.72			31.85	5.46	35.46	299	345	Average
2437	91.6	89.75			31.85	5.46	35.46	299	345	Peak
2492.2	41.25	39.23	54	-12.75	31.9	5.53	35.41	299	345	Average
2492.2	52.25	50.23	74	-21.75	31.9	5.53	35.41	299	345	Peak

Antennal Polarity & Test Distance: Vertical at 3 m

Frequency (MHz)	Emission Level (dBuV/m)	Read Level (dBuV)	Limit (dBuV/m)	Margin (dB)	Antenna Factor (dB/m)	Cable Loss (dB)	Preamp Factor (dB)	Antenna Height (cm)	Table Angle (Degree)	Remark
2331.15	40.57	39.03	54	-13.43	31.73	5.33	35.52	176	305	Average
2331.15	52.39	50.85	74	-21.61	31.73	5.33	35.52	176	305	Peak
2437	82.09	80.24			31.85	5.46	35.46	176	305	Average
2437	89.77	87.92			31.85	5.46	35.46	176	305	Peak
2485.24	41.21	39.22	54	-12.79	31.88	5.53	35.42	176	305	Average
2485.24	52.31	50.32	74	-21.69	31.88	5.53	35.42	176	305	Peak

Remarks:

- Emission Level = Read Level + Antenna Factor + Cable Loss - Preamp Factor
Margin value = Emission level – Limit value
- 2437 MHz: Fundamental frequency.

EUT Test Condition		Measurement Detail	
Channel	Channel 11	Frequency Range	1 GHz ~ 25 GHz
Input Power	120 Vac, 60 Hz	Detector Function	Peak (PK) Average (AV)
Environmental Conditions	25 deg. C, 65 % RH	Tested By	Karl Lee

Horizontal

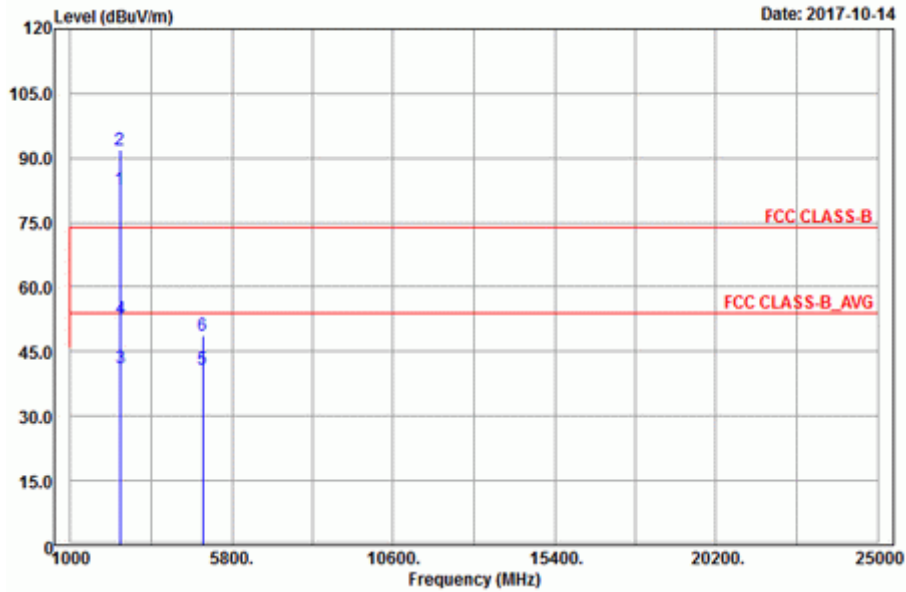

Vertical

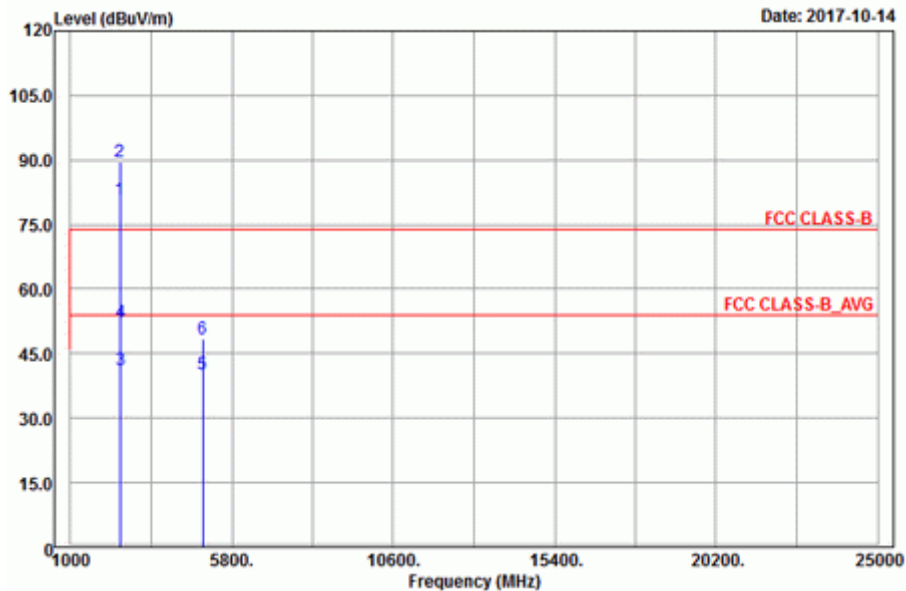

Antennal Polarity & Test Distance: Horizontal at 3 m

Frequency (MHz)	Emission Level (dBuV/m)	Read Level (dBuV)	Limit (dBuV/m)	Margin (dB)	Antenna Factor (dB/m)	Cable Loss (dB)	Preamp Factor (dB)	Antenna Height (cm)	Table Angle (Degree)	Remark
2462	82.58	80.65			31.87	5.5	35.44	299	313	Average
2462	91.76	89.83			31.87	5.5	35.44	299	313	Peak
2497.12	41.27	39.25	54	-12.73	31.9	5.53	35.41	299	313	Average
2497.12	52.59	50.57	74	-21.41	31.9	5.53	35.41	299	313	Peak
4924	40.76	32.51	54	-13.24	33.99	8.28	34.02	170	124	Average
4924	48.67	40.42	74	-25.33	33.99	8.28	34.02	170	124	Peak

Antennal Polarity & Test Distance: Vertical at 3 m

Frequency (MHz)	Emission Level (dBuV/m)	Read Level (dBuV)	Limit (dBuV/m)	Margin (dB)	Antenna Factor (dB/m)	Cable Loss (dB)	Preamp Factor (dB)	Antenna Height (cm)	Table Angle (Degree)	Remark
2462	80.61	78.68			31.87	5.5	35.44	185	91	Average
2462	89.6	87.67			31.87	5.5	35.44	185	91	Peak
2488.08	41.32	39.31	54	-12.68	31.9	5.53	35.42	185	91	Average
2488.08	52.38	50.37	74	-21.62	31.9	5.53	35.42	185	91	Peak
4924	40.3	32.05	54	-13.7	33.99	8.28	34.02	119	246	Average
4924	48.35	40.1	74	-25.65	33.99	8.28	34.02	119	246	Peak

Remarks:

- Emission Level = Read Level + Antenna Factor + Cable Loss - Preamp Factor
Margin value = Emission level – Limit value
- 2462 MHz: Fundamental frequency.

EUT Test Condition		Measurement Detail	
Channel	Channel 12	Frequency Range	1 GHz ~ 25 GHz
Input Power	120 Vac, 60 Hz	Detector Function	Peak (PK) Average (AV)
Environmental Conditions	25 deg. C, 65 % RH	Tested By	Karl Lee

Horizontal

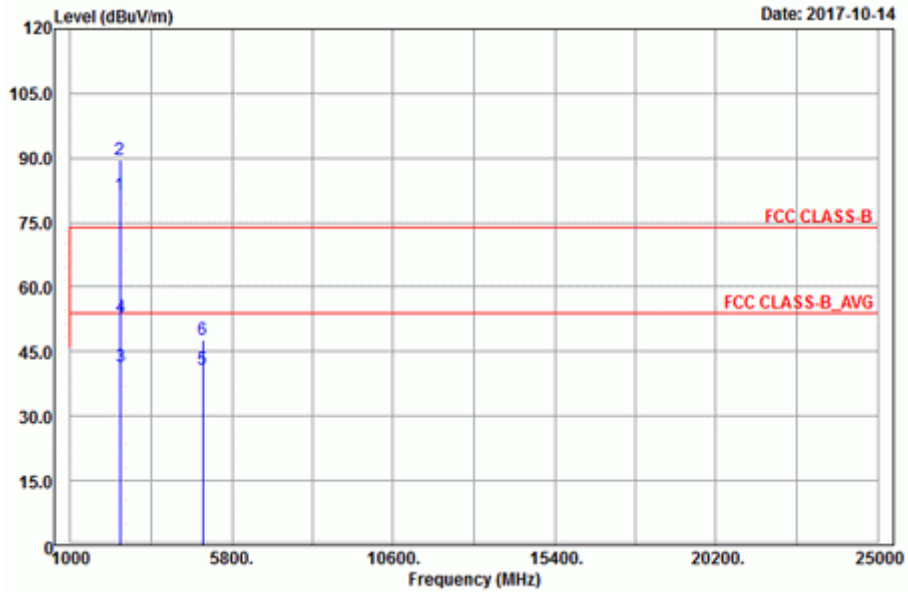

Vertical

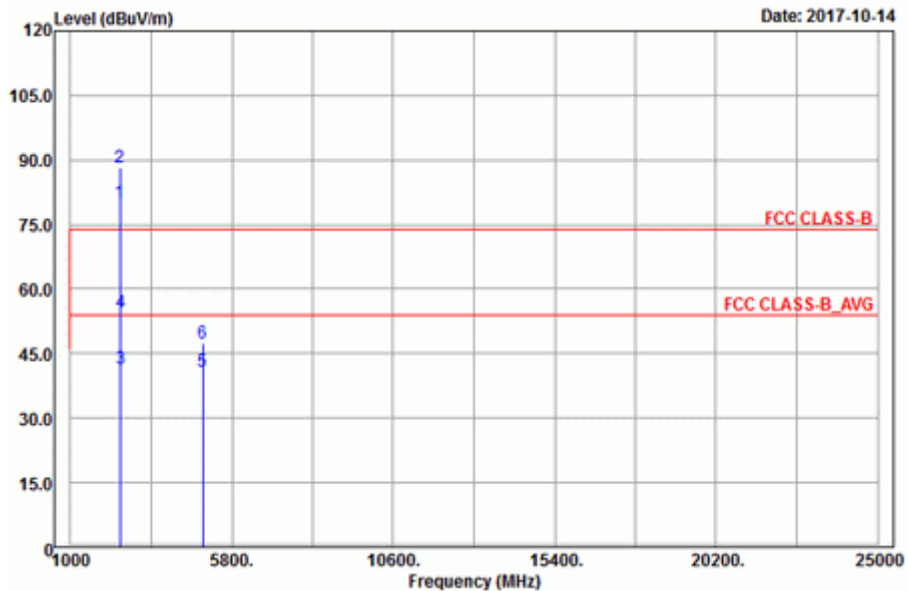

Antennal Polarity & Test Distance: Horizontal at 3 m

Frequency (MHz)	Emission Level (dBuV/m)	Read Level (dBuV)	Limit (dBuV/m)	Margin (dB)	Antenna Factor (dB/m)	Cable Loss (dB)	Preamp Factor (dB)	Antenna Height (cm)	Table Angle (Degree)	Remark
2467	81.26	79.31			31.87	5.5	35.42	299	323	Average
2467	89.74	87.79			31.87	5.5	35.42	299	323	Peak
2485.28	41.49	39.5	54	-12.51	31.88	5.53	35.42	299	323	Average
2485.28	52.87	50.88	74	-21.13	31.88	5.53	35.42	299	323	Peak
4934	40.72	32.46	54	-13.28	33.99	8.29	34.02	162	333	Average
4934	47.62	39.36	74	-26.38	33.99	8.29	34.02	162	333	Peak

Antennal Polarity & Test Distance: Vertical at 3 m

Frequency (MHz)	Emission Level (dBuV/m)	Read Level (dBuV)	Limit (dBuV/m)	Margin (dB)	Antenna Factor (dB/m)	Cable Loss (dB)	Preamp Factor (dB)	Antenna Height (cm)	Table Angle (Degree)	Remark
2467	80.06	78.11			31.87	5.5	35.42	235	96	Average
2467	88.25	86.3			31.87	5.5	35.42	235	96	Peak
2484.28	41.44	39.45	54	-12.56	31.88	5.53	35.42	235	96	Average
2484.28	54.5	52.51	74	-19.5	31.88	5.53	35.42	235	96	Peak
4934	40.72	32.46	54	-13.28	33.99	8.29	34.02	150	208	Average
4934	47.54	39.28	74	-26.46	33.99	8.29	34.02	150	208	Peak

Remarks:

- Emission Level = Read Level + Antenna Factor + Cable Loss - Preamp Factor
Margin value = Emission level – Limit value
- 2467 MHz: Fundamental frequency.

EUT Test Condition		Measurement Detail	
Channel	Channel 13	Frequency Range	1 GHz ~ 25 GHz
Input Power	120 Vac, 60 Hz	Detector Function	Peak (PK) Average (AV)
Environmental Conditions	25 deg. C, 65 % RH	Tested By	Karl Lee

Horizontal

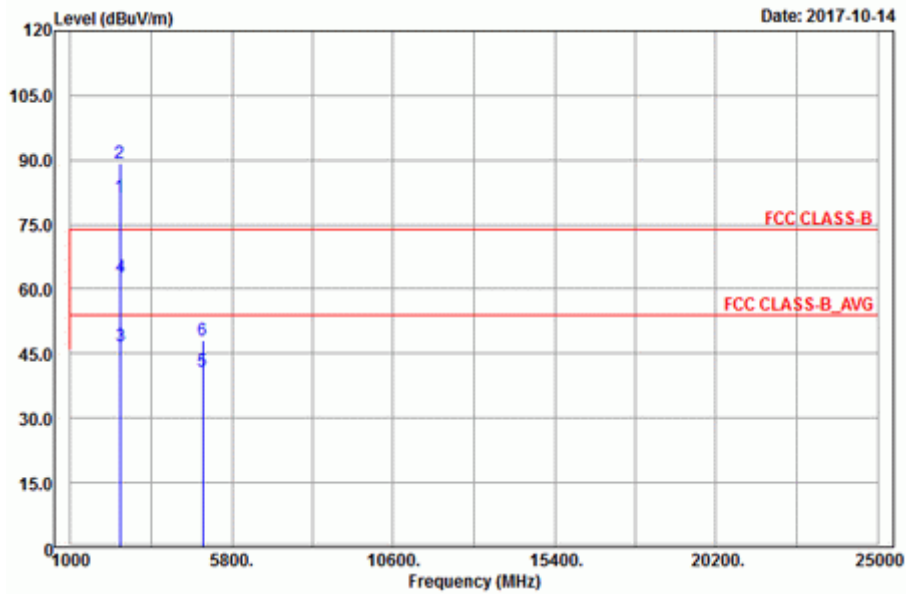

Vertical

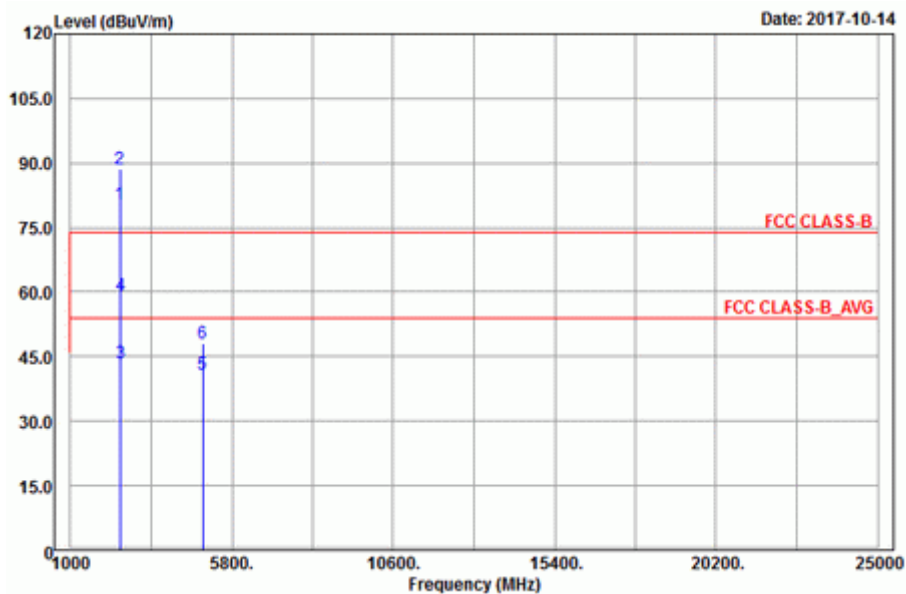

Antennal Polarity & Test Distance: Horizontal at 3 m

Frequency (MHz)	Emission Level (dBuV/m)	Read Level (dBuV)	Limit (dBuV/m)	Margin (dB)	Antenna Factor (dB/m)	Cable Loss (dB)	Preamp Factor (dB)	Antenna Height (cm)	Table Angle (Degree)	Remark
2472	81.36	79.4			31.88	5.5	35.42	299	323	Average
2472	89.13	87.17			31.88	5.5	35.42	299	323	Peak
2483.52	46.75	44.79	54	-7.25	31.88	5.5	35.42	299	323	Average
2483.52	62.67	60.71	74	-11.33	31.88	5.5	35.42	299	323	Peak
4944	40.87	32.6	54	-13.13	33.99	8.29	34.01	106	1	Average
4944	48.09	39.82	74	-25.91	33.99	8.29	34.01	106	1	Peak

Antennal Polarity & Test Distance: Vertical at 3 m

Frequency (MHz)	Emission Level (dBuV/m)	Read Level (dBuV)	Limit (dBuV/m)	Margin (dB)	Antenna Factor (dB/m)	Cable Loss (dB)	Preamp Factor (dB)	Antenna Height (cm)	Table Angle (Degree)	Remark
2472	80.47	78.51			31.88	5.5	35.42	235	96	Average
2472	88.53	86.57			31.88	5.5	35.42	235	96	Peak
2483.52	43.55	41.59	54	-10.45	31.88	5.5	35.42	235	96	Average
2483.52	59.04	57.08	74	-14.96	31.88	5.5	35.42	235	96	Peak
4944	40.75	32.48	54	-13.25	33.99	8.29	34.01	105	104	Average
4944	48.05	39.78	74	-25.95	33.99	8.29	34.01	105	104	Peak

Remarks:

- Emission Level = Read Level + Antenna Factor + Cable Loss - Preamp Factor
Margin value = Emission level – Limit value
- 2472 MHz: Fundamental frequency.

802.11n (HT20)

EUT Test Condition		Measurement Detail	
Channel	Channel 1	Frequency Range	1 GHz ~ 25 GHz
Input Power	120 Vac, 60 Hz	Detector Function	Peak (PK) Average (AV)
Environmental Conditions	25 deg. C, 65 % RH	Tested By	Karl Lee

Horizontal

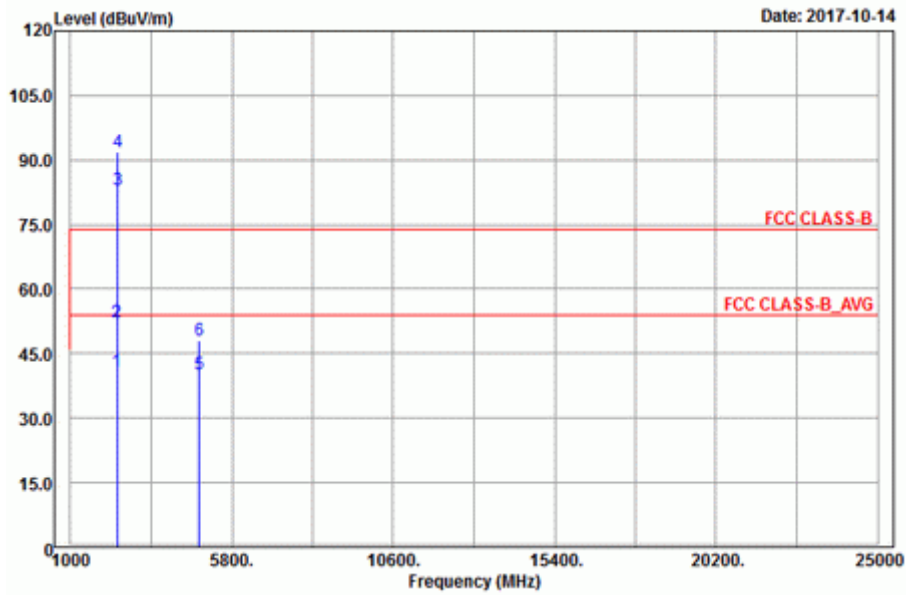

Vertical

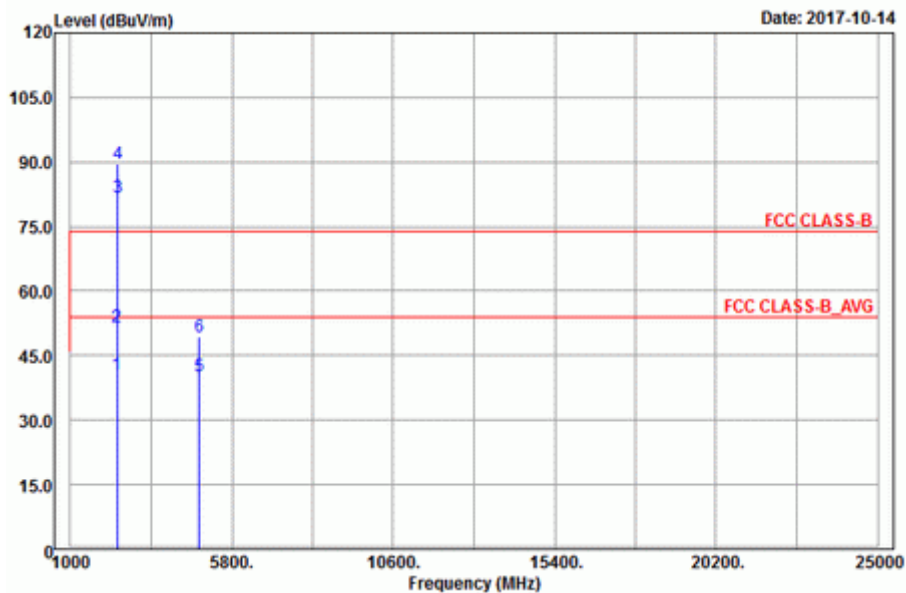

Antennal Polarity & Test Distance: Horizontal at 3 m

Frequency (MHz)	Emission Level (dBuV/m)	Read Level (dBuV)	Limit (dBuV/m)	Margin (dB)	Antenna Factor (dB/m)	Cable Loss (dB)	Preamp Factor (dB)	Antenna Height (cm)	Table Angle (Degree)	Remark
2389.92	40.85	39.12	54	-13.15	31.8	5.4	35.47	299	345	Average
2389.92	52.4	50.67	74	-21.6	31.8	5.4	35.47	299	345	Peak
2412	83.03	81.26			31.81	5.43	35.47	299	345	Average
2412	91.9	90.13			31.81	5.43	35.47	299	345	Peak
4824	40.13	32	54	-13.87	33.97	8.26	34.1	124	175	Average
4824	47.91	39.78	74	-26.09	33.97	8.26	34.1	124	175	Peak

Antennal Polarity & Test Distance: Vertical at 3 m

Frequency (MHz)	Emission Level (dBuV/m)	Read Level (dBuV)	Limit (dBuV/m)	Margin (dB)	Antenna Factor (dB/m)	Cable Loss (dB)	Preamp Factor (dB)	Antenna Height (cm)	Table Angle (Degree)	Remark
2380.47	40.54	38.85	54	-13.46	31.78	5.4	35.49	176	305	Average
2380.47	51.58	49.89	74	-22.42	31.78	5.4	35.49	176	305	Peak
2412	81.67	79.9			31.81	5.43	35.47	176	305	Average
2412	89.44	87.67			31.81	5.43	35.47	176	305	Peak
4824	40.27	32.14	54	-13.73	33.97	8.26	34.1	124	320	Average
4824	49.37	41.24	74	-24.63	33.97	8.26	34.1	124	320	Peak

Remarks:

1. Emission Level = Read Level + Antenna Factor + Cable Loss - Preamp Factor

Margin value = Emission level – Limit value

2. 2412 MHz: Fundamental frequency.

EUT Test Condition		Measurement Detail	
Channel	Channel 6	Frequency Range	1 GHz ~ 25 GHz
Input Power	120 Vac, 60 Hz	Detector Function	Peak (PK) Average (AV)
Environmental Conditions	25 deg. C, 65 % RH	Tested By	Karl Lee

Horizontal

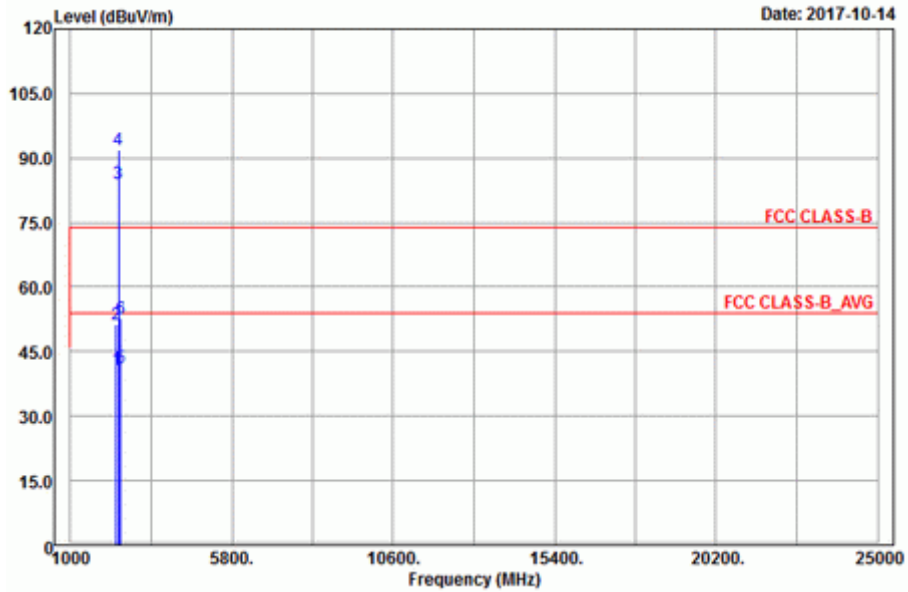

Vertical

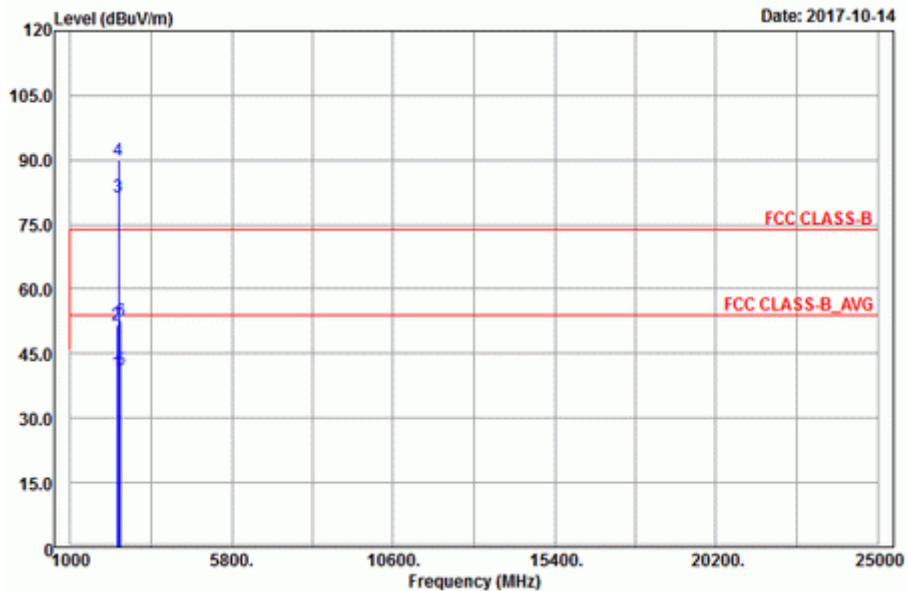

Antennal Polarity & Test Distance: Horizontal at 3 m

Frequency (MHz)	Emission Level (dBuV/m)	Read Level (dBuV)	Limit (dBuV/m)	Margin (dB)	Antenna Factor (dB/m)	Cable Loss (dB)	Preamp Factor (dB)	Antenna Height (cm)	Table Angle (Degree)	Remark
2376.42	40.76	39.1	54	-13.24	31.78	5.37	35.49	299	345	Average
2376.42	51.41	49.75	74	-22.59	31.78	5.37	35.49	299	345	Peak
2437	84.19	82.34			31.85	5.46	35.46	299	345	Average
2437	91.86	90.01			31.85	5.46	35.46	299	345	Peak
2491.04	41.12	39.11	54	-12.88	31.9	5.53	35.42	299	345	Average
2491.04	52.57	50.56	74	-21.43	31.9	5.53	35.42	299	345	Peak

Antennal Polarity & Test Distance: Vertical at 3 m

Frequency (MHz)	Emission Level (dBuV/m)	Read Level (dBuV)	Limit (dBuV/m)	Margin (dB)	Antenna Factor (dB/m)	Cable Loss (dB)	Preamp Factor (dB)	Antenna Height (cm)	Table Angle (Degree)	Remark
2384.79	40.52	38.83	54	-13.48	31.78	5.4	35.49	176	305	Average
2384.79	51.62	49.93	74	-22.38	31.78	5.4	35.49	176	305	Peak
2437	81.33	79.48			31.85	5.46	35.46	176	305	Average
2437	89.95	88.1			31.85	5.46	35.46	176	305	Peak
2490	41.05	39.04	54	-12.95	31.9	5.53	35.42	176	305	Average
2490	52.74	50.73	74	-21.26	31.9	5.53	35.42	176	305	Peak

Remarks:

- Emission Level = Read Level + Antenna Factor + Cable Loss - Preamp Factor
Margin value = Emission level – Limit value
- 2437 MHz: Fundamental frequency.

EUT Test Condition		Measurement Detail	
Channel	Channel 11	Frequency Range	1 GHz ~ 25 GHz
Input Power	120 Vac, 60 Hz	Detector Function	Peak (PK) Average (AV)
Environmental Conditions	25 deg. C, 65 % RH	Tested By	Karl Lee

Horizontal

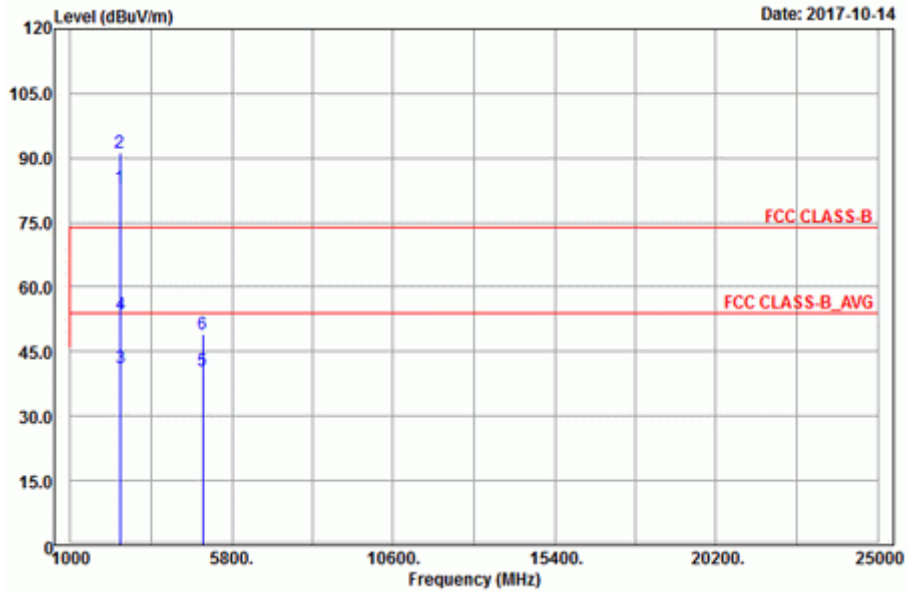

Vertical

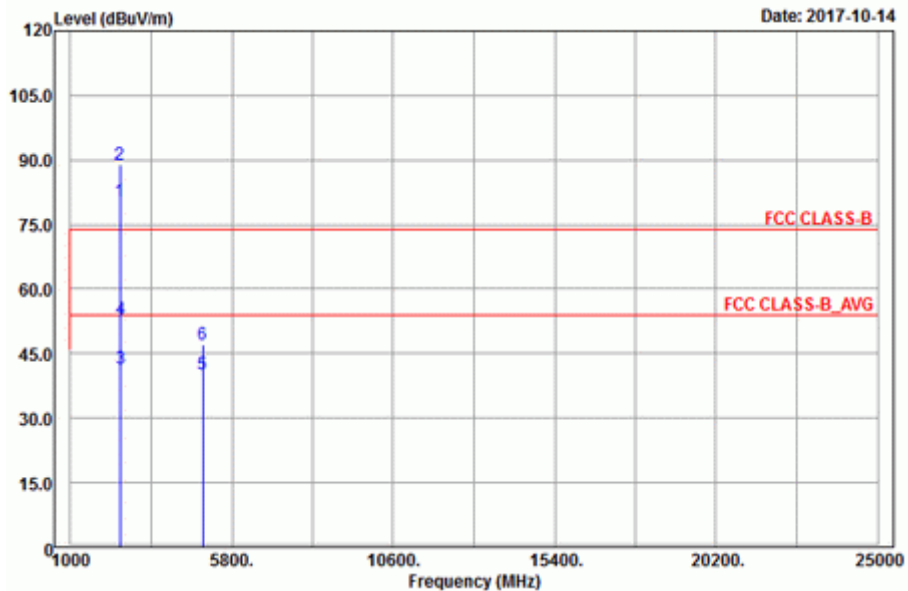

Antennal Polarity & Test Distance: Horizontal at 3 m

Frequency (MHz)	Emission Level (dBuV/m)	Read Level (dBuV)	Limit (dBuV/m)	Margin (dB)	Antenna Factor (dB/m)	Cable Loss (dB)	Preamp Factor (dB)	Antenna Height (cm)	Table Angle (Degree)	Remark
2462	82.9	80.97			31.87	5.5	35.44	299	319	Average
2462	91.36	89.43			31.87	5.5	35.44	299	319	Peak
2484.36	41.28	39.29	54	-12.72	31.88	5.53	35.42	299	319	Average
2484.36	53.62	51.63	74	-20.38	31.88	5.53	35.42	299	319	Peak
4924	40.43	32.18	54	-13.57	33.99	8.28	34.02	149	110	Average
4924	49.1	40.85	74	-24.9	33.99	8.28	34.02	149	110	Peak

Antennal Polarity & Test Distance: Vertical at 3 m

Frequency (MHz)	Emission Level (dBuV/m)	Read Level (dBuV)	Limit (dBuV/m)	Margin (dB)	Antenna Factor (dB/m)	Cable Loss (dB)	Preamp Factor (dB)	Antenna Height (cm)	Table Angle (Degree)	Remark
2462	80.52	78.59			31.87	5.5	35.44	185	91	Average
2462	89.06	87.13			31.87	5.5	35.44	185	91	Peak
2484.6	41.4	39.41	54	-12.6	31.88	5.53	35.42	185	91	Average
2484.6	52.86	50.87	74	-21.14	31.88	5.53	35.42	185	91	Peak
4924	40.2	31.95	54	-13.8	33.99	8.28	34.02	124	195	Average
4924	47.24	38.99	74	-26.76	33.99	8.28	34.02	124	195	Peak

Remarks:

- Emission Level = Read Level + Antenna Factor + Cable Loss - Preamp Factor
Margin value = Emission level – Limit value
- 2462 MHz: Fundamental frequency.

EUT Test Condition		Measurement Detail	
Channel	Channel 12	Frequency Range	1 GHz ~ 25 GHz
Input Power	120 Vac, 60 Hz	Detector Function	Peak (PK) Average (AV)
Environmental Conditions	25 deg. C, 65 % RH	Tested By	Karl Lee

Horizontal

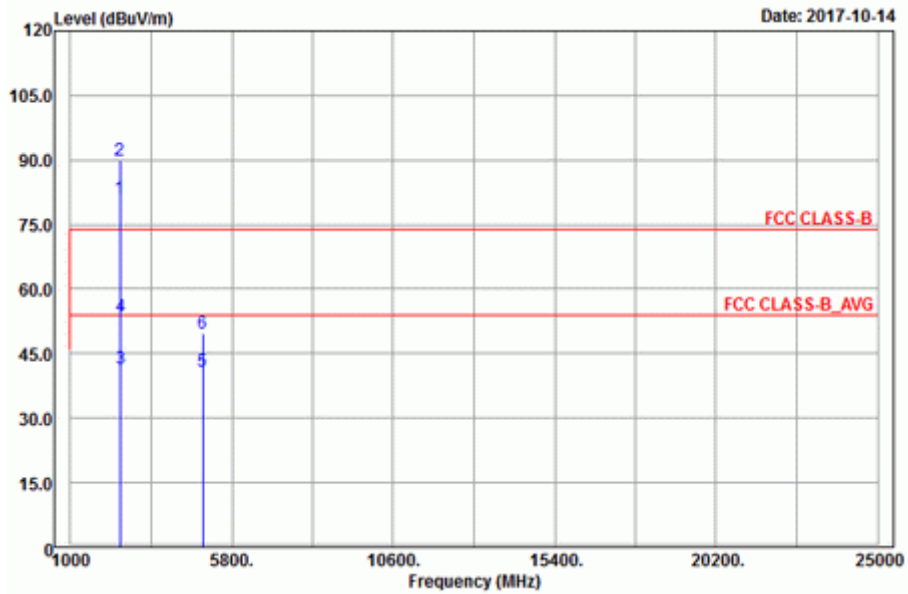

Vertical

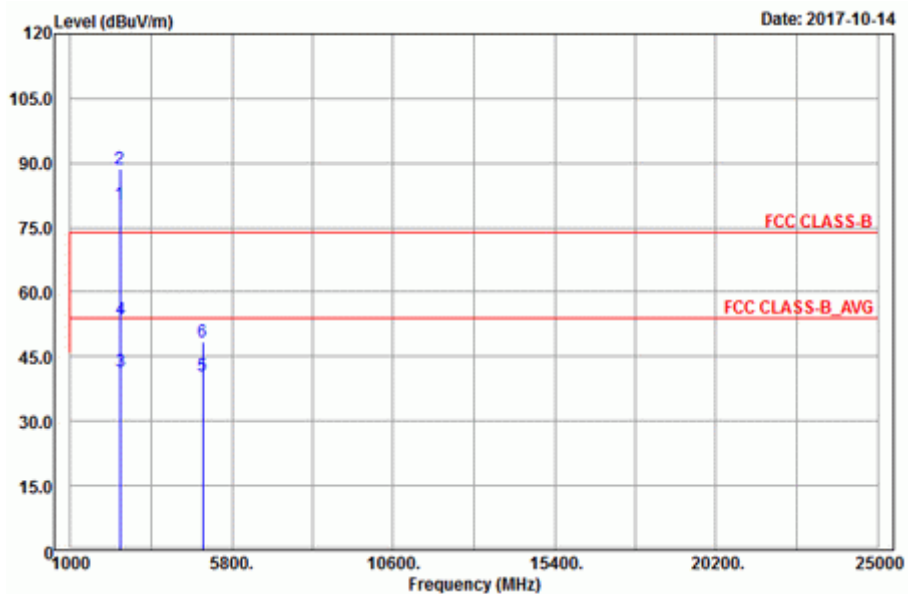

Antennal Polarity & Test Distance: Horizontal at 3 m

Frequency (MHz)	Emission Level (dBuV/m)	Read Level (dBuV)	Limit (dBuV/m)	Margin (dB)	Antenna Factor (dB/m)	Cable Loss (dB)	Preamp Factor (dB)	Antenna Height (cm)	Table Angle (Degree)	Remark
2467	81.03	79.08			31.87	5.5	35.42	299	323	Average
2467	89.78	87.83			31.87	5.5	35.42	299	323	Peak
2484.52	41.59	39.6	54	-12.41	31.88	5.53	35.42	299	323	Average
2484.52	53.66	51.67	74	-20.34	31.88	5.53	35.42	299	323	Peak
4934	40.84	32.58	54	-13.16	33.99	8.29	34.02	124	111	Average
4934	49.64	41.38	74	-24.36	33.99	8.29	34.02	124	111	Peak

Antennal Polarity & Test Distance: Vertical at 3 m

Frequency (MHz)	Emission Level (dBuV/m)	Read Level (dBuV)	Limit (dBuV/m)	Margin (dB)	Antenna Factor (dB/m)	Cable Loss (dB)	Preamp Factor (dB)	Antenna Height (cm)	Table Angle (Degree)	Remark
2467	80.48	78.53			31.87	5.5	35.42	235	96	Average
2467	88.58	86.63			31.87	5.5	35.42	235	96	Peak
2485.16	41.61	39.62	54	-12.39	31.88	5.53	35.42	235	96	Average
2485.16	53.46	51.47	74	-20.54	31.88	5.53	35.42	235	96	Peak
4934	40.59	32.33	54	-13.41	33.99	8.29	34.02	102	280	Average
4934	48.28	40.02	74	-25.72	33.99	8.29	34.02	102	280	Peak

Remarks:

- Emission Level = Read Level + Antenna Factor + Cable Loss - Preamp Factor
Margin value = Emission level – Limit value
- 2467 MHz: Fundamental frequency.

EUT Test Condition		Measurement Detail	
Channel	Channel 13	Frequency Range	1 GHz ~ 25 GHz
Input Power	120 Vac, 60 Hz	Detector Function	Peak (PK) Average (AV)
Environmental Conditions	25 deg. C, 65 % RH	Tested By	Karl Lee

Horizontal

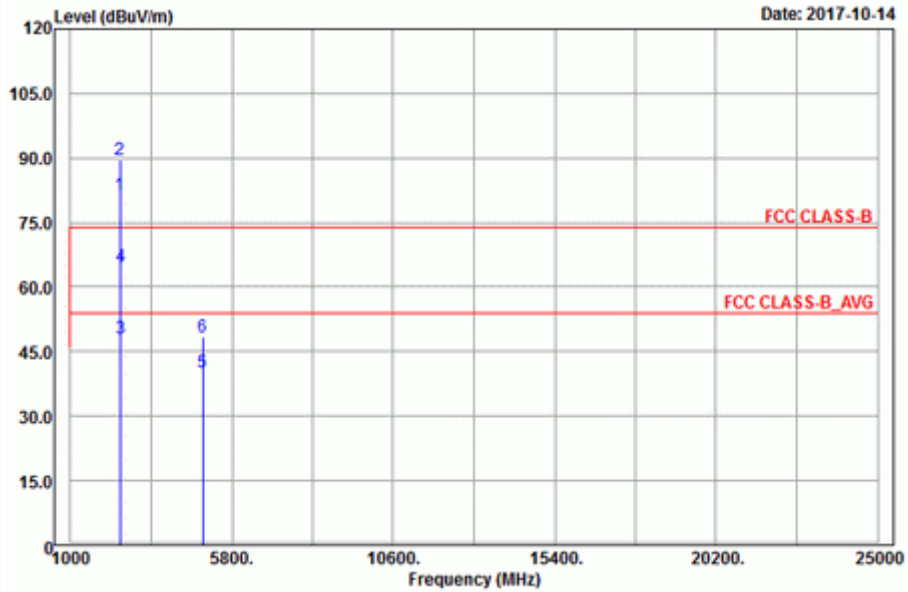

Vertical

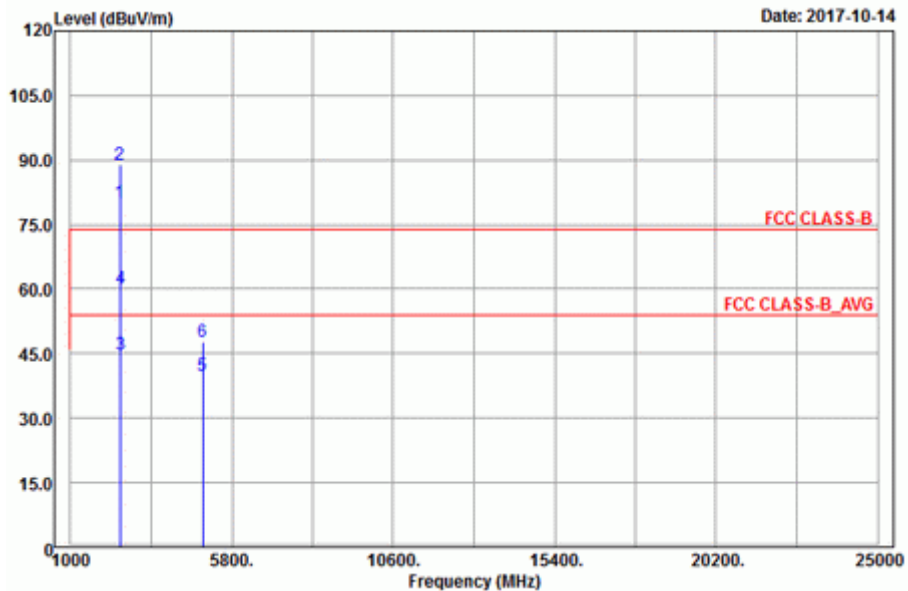

Antennal Polarity & Test Distance: Horizontal at 3 m										
Frequency (MHz)	Emission Level (dBuV/m)	Read Level (dBuV)	Limit (dBuV/m)	Margin (dB)	Antenna Factor (dB/m)	Cable Loss (dB)	Preamp Factor (dB)	Antenna Height (cm)	Table Angle (Degree)	Remark
2472	81.47	79.51			31.88	5.5	35.42	299	323	Average
2472	89.51	87.55			31.88	5.5	35.42	299	323	Peak
2483.52	48.11	46.15	54	-5.89	31.88	5.5	35.42	299	323	Average
2483.52	64.75	62.79	74	-9.25	31.88	5.5	35.42	299	323	Peak
4944	40.32	32.05	54	-13.68	33.99	8.29	34.01	124	205	Average
4944	48.53	40.26	74	-25.47	33.99	8.29	34.01	124	205	Peak
Antennal Polarity & Test Distance: Vertical at 3 m										
Frequency (MHz)	Emission Level (dBuV/m)	Read Level (dBuV)	Limit (dBuV/m)	Margin (dB)	Antenna Factor (dB/m)	Cable Loss (dB)	Preamp Factor (dB)	Antenna Height (cm)	Table Angle (Degree)	Remark
2472	80.25	78.29			31.88	5.5	35.42	235	96	Average
2472	88.88	86.92			31.88	5.5	35.42	235	96	Peak
2483.52	44.89	42.93	54	-9.11	31.88	5.5	35.42	235	96	Average
2483.52	60.06	58.1	74	-13.94	31.88	5.5	35.42	235	96	Peak
4944	40.05	31.78	54	-13.95	33.99	8.29	34.01	135	316	Average
4944	47.77	39.5	74	-26.23	33.99	8.29	34.01	135	316	Peak

Remarks:

- Emission Level = Read Level + Antenna Factor + Cable Loss - Preamp Factor
Margin value = Emission level – Limit value
- 2472 MHz: Fundamental frequency.

Mode B
802.11b

EUT Test Condition		Measurement Detail	
Channel	Channel 1	Frequency Range	1 GHz ~ 25 GHz
Input Power	120 Vac, 60 Hz	Detector Function	Peak (PK) Average (AV)
Environmental Conditions	25 deg. C, 65 % RH	Tested By	Karl Lee

Horizontal

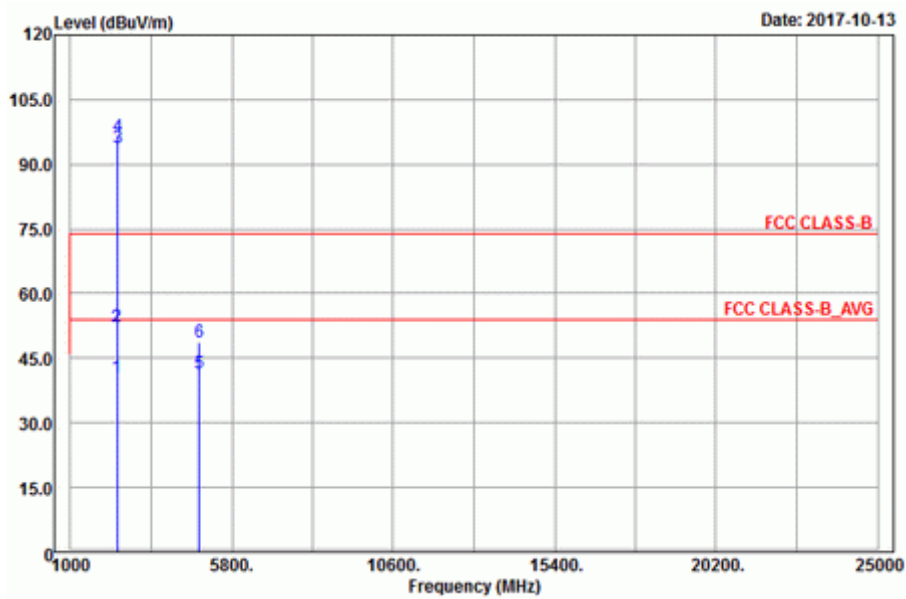

Vertical

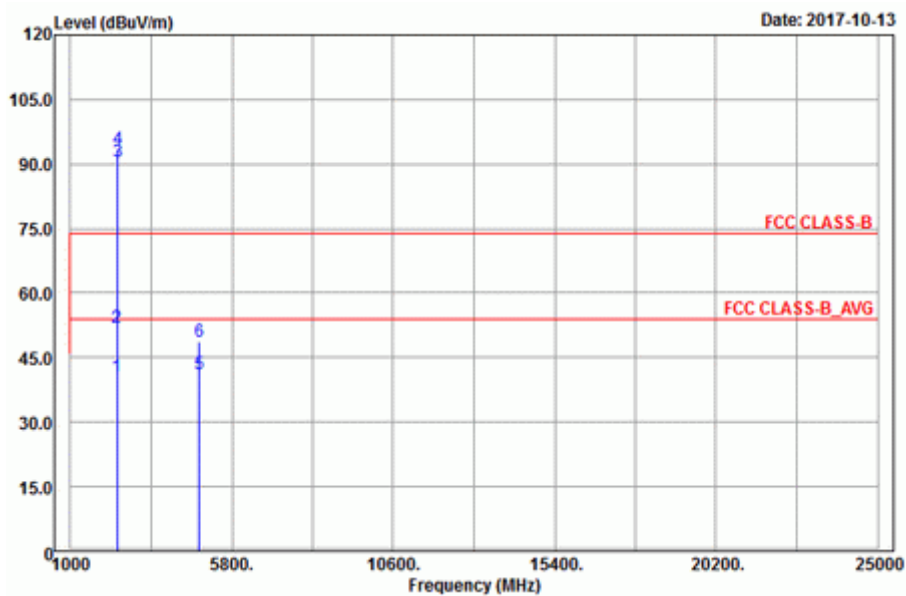

Antennal Polarity & Test Distance: Horizontal at 3 m

Frequency (MHz)	Emission Level (dBuV/m)	Read Level (dBuV)	Limit (dBuV/m)	Margin (dB)	Antenna Factor (dB/m)	Cable Loss (dB)	Preamp Factor (dB)	Antenna Height (cm)	Table Angle (Degree)	Remark
2389.47	40.66	38.95	54	-13.34	31.8	5.4	35.49	100	38	Average
2389.47	52.3	50.59	74	-21.7	31.8	5.4	35.49	100	38	Peak
2412	93.95	92.18			31.81	5.43	35.47	100	38	Average
2412	96.52	94.75			31.81	5.43	35.47	100	38	Peak
4824	41.38	33.25	54	-12.62	33.97	8.26	34.1	141	240	Average
4824	48.56	40.43	74	-25.44	33.97	8.26	34.1	141	240	Peak

Antennal Polarity & Test Distance: Vertical at 3 m

Frequency (MHz)	Emission Level (dBuV/m)	Read Level (dBuV)	Limit (dBuV/m)	Margin (dB)	Antenna Factor (dB/m)	Cable Loss (dB)	Preamp Factor (dB)	Antenna Height (cm)	Table Angle (Degree)	Remark
2381.73	40.39	38.7	54	-13.61	31.78	5.4	35.49	104	24	Average
2381.73	51.92	50.23	74	-22.08	31.78	5.4	35.49	104	24	Peak
2412	90.44	88.67			31.81	5.43	35.47	104	24	Average
2412	93.53	91.76			31.81	5.43	35.47	104	24	Peak
4824	41.12	32.99	54	-12.88	33.97	8.26	34.1	125	95	Average
4824	48.61	40.48	74	-25.39	33.97	8.26	34.1	125	95	Peak

Remarks:

1. Emission Level = Read Level + Antenna Factor + Cable Loss - Preamp Factor

Margin value = Emission level – Limit value

2. 2412 MHz: Fundamental frequency.

EUT Test Condition		Measurement Detail	
Channel	Channel 6	Frequency Range	1 GHz ~ 25 GHz
Input Power	120 Vac, 60 Hz	Detector Function	Peak (PK) Average (AV)
Environmental Conditions	25 deg. C, 65 % RH	Tested By	Karl Lee

Horizontal

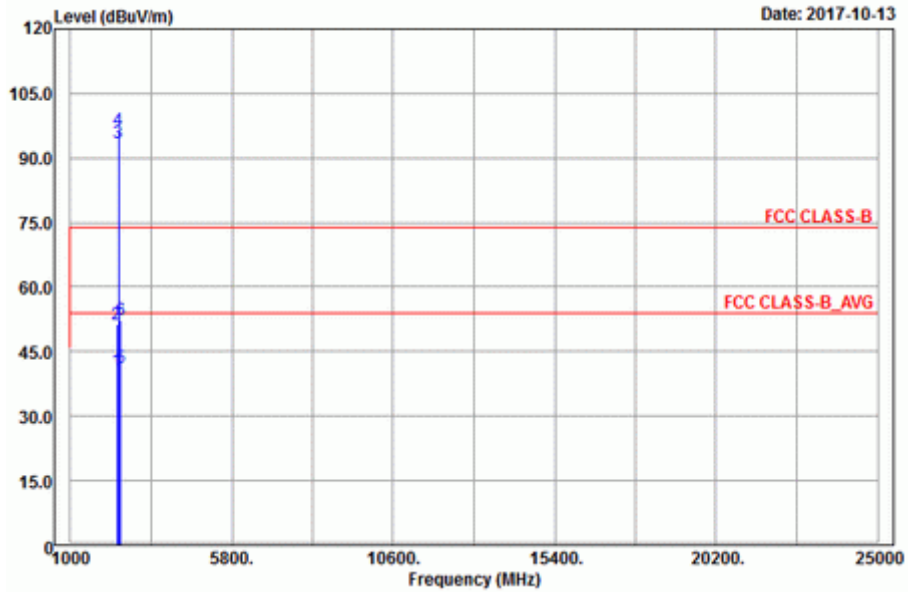

Vertical

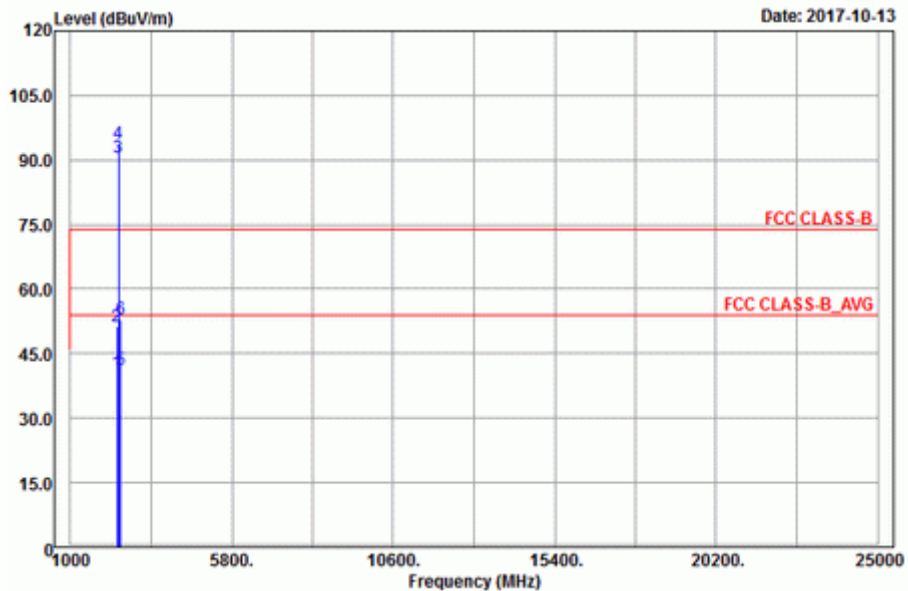

Antennal Polarity & Test Distance: Horizontal at 3 m

Frequency (MHz)	Emission Level (dBuV/m)	Read Level (dBuV)	Limit (dBuV/m)	Margin (dB)	Antenna Factor (dB/m)	Cable Loss (dB)	Preamp Factor (dB)	Antenna Height (cm)	Table Angle (Degree)	Remark
2380.65	40.58	38.89	54	-13.42	31.78	5.4	35.49	100	38	Average
2380.65	51.49	49.8	74	-22.51	31.78	5.4	35.49	100	38	Peak
2437	93.55	91.7			31.85	5.46	35.46	100	38	Average
2437	96.6	94.75			31.85	5.46	35.46	100	38	Peak
2499.8	41.15	39.13	54	-12.85	31.9	5.53	35.41	100	38	Average
2499.8	52.35	50.33	74	-21.65	31.9	5.53	35.41	100	38	Peak

Antennal Polarity & Test Distance: Vertical at 3 m

Frequency (MHz)	Emission Level (dBuV/m)	Read Level (dBuV)	Limit (dBuV/m)	Margin (dB)	Antenna Factor (dB/m)	Cable Loss (dB)	Preamp Factor (dB)	Antenna Height (cm)	Table Angle (Degree)	Remark
2389.2	40.58	38.87	54	-13.42	31.8	5.4	35.49	104	24	Average
2389.2	51.28	49.57	74	-22.72	31.8	5.4	35.49	104	24	Peak
2437	90.68	88.83			31.85	5.46	35.46	104	24	Average
2437	93.99	92.14			31.85	5.46	35.46	104	24	Peak
2493.12	41.1	39.08	54	-12.9	31.9	5.53	35.41	104	24	Average
2493.12	52.81	50.79	74	-21.19	31.9	5.53	35.41	104	24	Peak

Remarks:

1. Emission Level = Read Level + Antenna Factor + Cable Loss - Preamp Factor

Margin value = Emission level – Limit value

2. 2437 MHz: Fundamental frequency.

EUT Test Condition		Measurement Detail	
Channel	Channel 11	Frequency Range	1 GHz ~ 25 GHz
Input Power	120 Vac, 60 Hz	Detector Function	Peak (PK) Average (AV)
Environmental Conditions	25 deg. C, 65 % RH	Tested By	Karl Lee

Horizontal

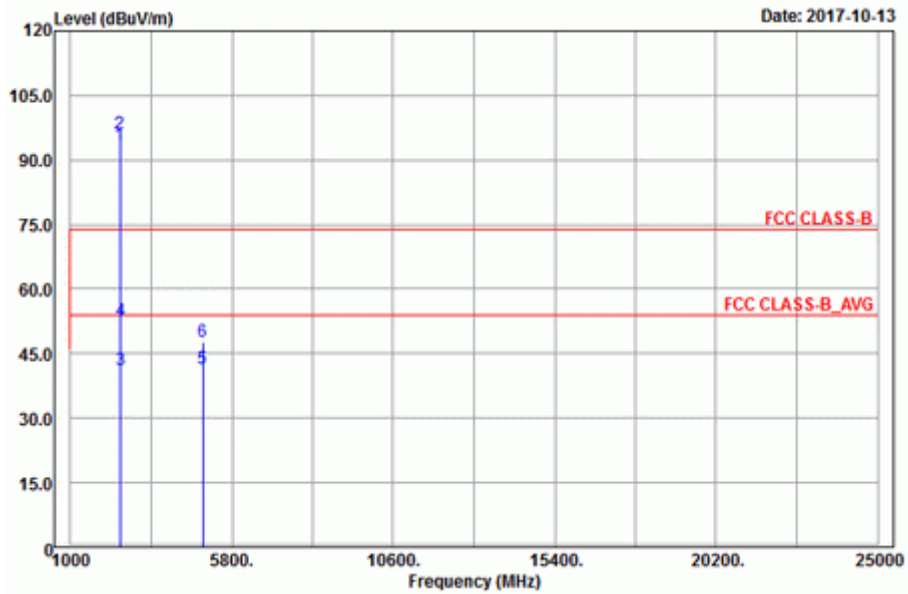

Vertical

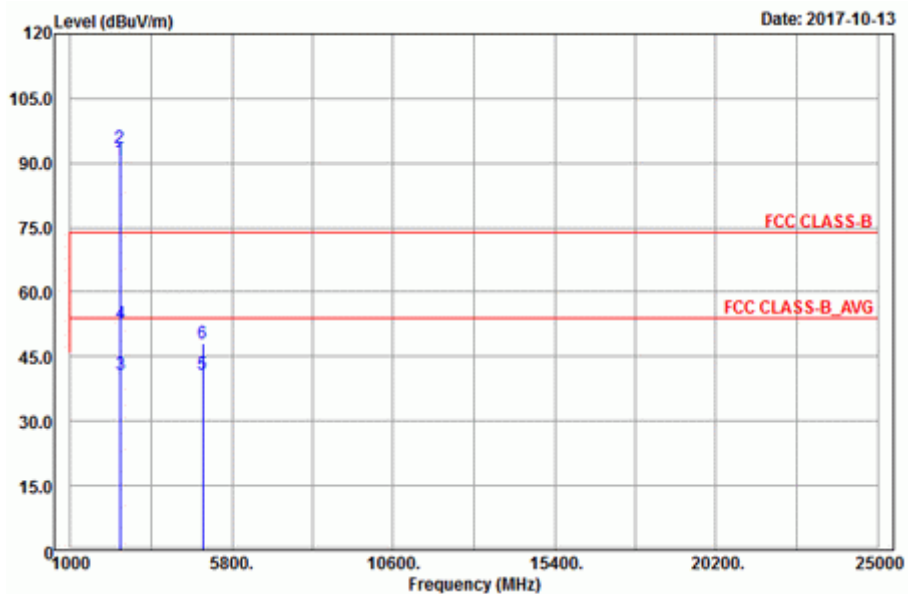

Antennal Polarity & Test Distance: Horizontal at 3 m

Frequency (MHz)	Emission Level (dBuV/m)	Read Level (dBuV)	Limit (dBuV/m)	Margin (dB)	Antenna Factor (dB/m)	Cable Loss (dB)	Preamp Factor (dB)	Antenna Height (cm)	Table Angle (Degree)	Remark
2462	93.36	91.43			31.87	5.5	35.44	100	38	Average
2462	96.1	94.17			31.87	5.5	35.44	100	38	Peak
2483.72	41.27	39.31	54	-12.73	31.88	5.5	35.42	100	38	Average
2483.72	52.66	50.7	74	-21.34	31.88	5.5	35.42	100	38	Peak
4924	41.59	33.34	54	-12.41	33.99	8.28	34.02	105	104	Average
4924	47.79	39.54	74	-26.21	33.99	8.28	34.02	105	104	Peak

Antennal Polarity & Test Distance: Vertical at 3 m

Frequency (MHz)	Emission Level (dBuV/m)	Read Level (dBuV)	Limit (dBuV/m)	Margin (dB)	Antenna Factor (dB/m)	Cable Loss (dB)	Preamp Factor (dB)	Antenna Height (cm)	Table Angle (Degree)	Remark
2462	90.43	88.5			31.87	5.5	35.44	104	24	Average
2462	93.58	91.65			31.87	5.5	35.44	104	24	Peak
2491.28	41.01	39	54	-12.99	31.9	5.53	35.42	104	24	Average
2491.28	52.49	50.48	74	-21.51	31.9	5.53	35.42	104	24	Peak
4924	41.01	32.76	54	-12.99	33.99	8.28	34.02	133	25	Average
4924	48.08	39.83	74	-25.92	33.99	8.28	34.02	133	25	Peak

Remarks:

- Emission Level = Read Level + Antenna Factor + Cable Loss - Preamp Factor
Margin value = Emission level – Limit value
- 2462 MHz: Fundamental frequency.

EUT Test Condition		Measurement Detail	
Channel	Channel 12	Frequency Range	1 GHz ~ 25 GHz
Input Power	120 Vac, 60 Hz	Detector Function	Peak (PK) Average (AV)
Environmental Conditions	25 deg. C, 65 % RH	Tested By	Karl Lee

Horizontal

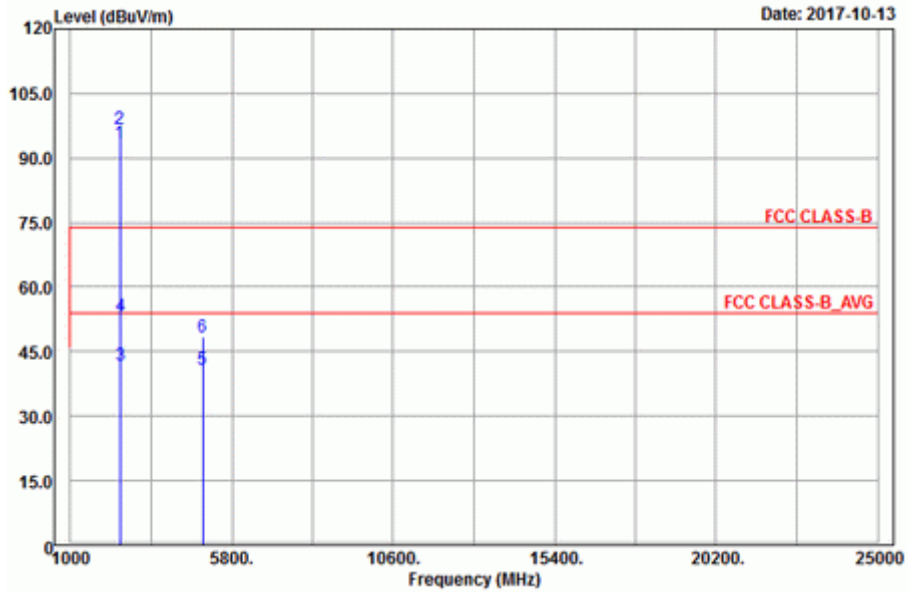

Vertical

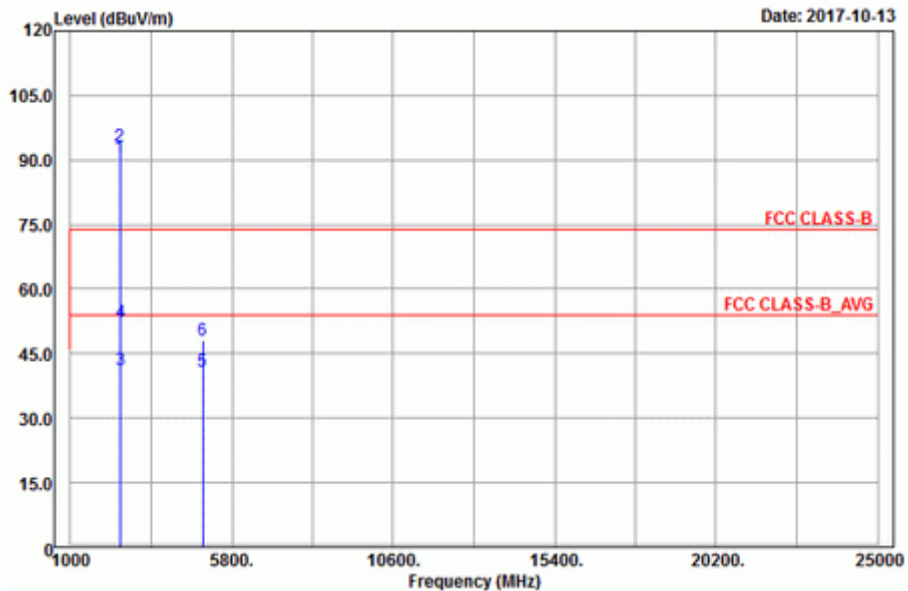

Antennal Polarity & Test Distance: Horizontal at 3 m

Frequency (MHz)	Emission Level (dBuV/m)	Read Level (dBuV)	Limit (dBuV/m)	Margin (dB)	Antenna Factor (dB/m)	Cable Loss (dB)	Preamp Factor (dB)	Antenna Height (cm)	Table Angle (Degree)	Remark
2467	93.36	91.41			31.87	5.5	35.42	100	38	Average
2467	96.82	94.87			31.87	5.5	35.42	100	38	Peak
2484.8	41.94	39.95	54	-12.06	31.88	5.53	35.42	100	38	Average
2484.8	53.16	51.17	74	-20.84	31.88	5.53	35.42	100	38	Peak
4934	40.9	32.64	54	-13.1	33.99	8.29	34.02	115	155	Average
4934	48.33	40.07	74	-25.67	33.99	8.29	34.02	115	155	Peak

Antennal Polarity & Test Distance: Vertical at 3 m

Frequency (MHz)	Emission Level (dBuV/m)	Read Level (dBuV)	Limit (dBuV/m)	Margin (dB)	Antenna Factor (dB/m)	Cable Loss (dB)	Preamp Factor (dB)	Antenna Height (cm)	Table Angle (Degree)	Remark
2467	90.43	88.48			31.87	5.5	35.42	104	24	Average
2467	93.18	91.23			31.87	5.5	35.42	104	24	Peak
2484.56	41.27	39.28	54	-12.73	31.88	5.53	35.42	104	24	Average
2484.56	52.27	50.28	74	-21.73	31.88	5.53	35.42	104	24	Peak
4934	41.02	32.76	54	-12.98	33.99	8.29	34.02	134	352	Average
4934	47.99	39.73	74	-26.01	33.99	8.29	34.02	134	352	Peak

Remarks:

- Emission Level = Read Level + Antenna Factor + Cable Loss - Preamp Factor
Margin value = Emission level – Limit value
- 2467 MHz: Fundamental frequency.

EUT Test Condition		Measurement Detail	
Channel	Channel 13	Frequency Range	1 GHz ~ 25 GHz
Input Power	120 Vac, 60 Hz	Detector Function	Peak (PK) Average (AV)
Environmental Conditions	25 deg. C, 65 % RH	Tested By	Karl Lee

Horizontal

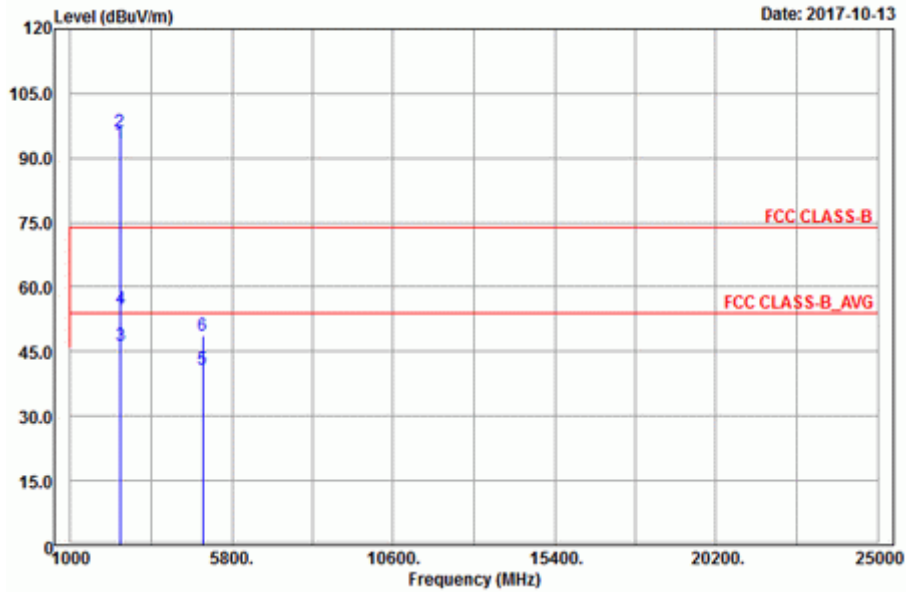

Vertical

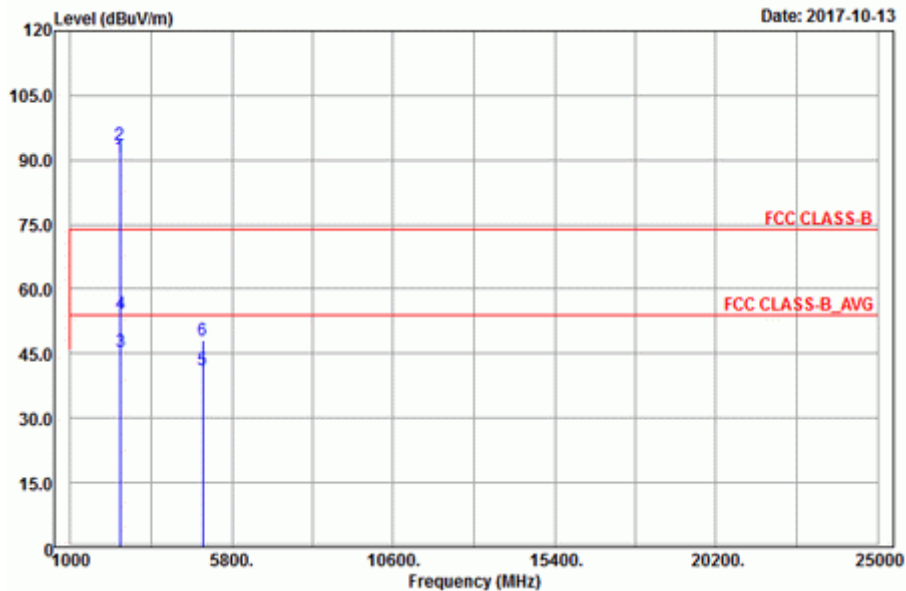

Antennal Polarity & Test Distance: Horizontal at 3 m

Frequency (MHz)	Emission Level (dBuV/m)	Read Level (dBuV)	Limit (dBuV/m)	Margin (dB)	Antenna Factor (dB/m)	Cable Loss (dB)	Preamp Factor (dB)	Antenna Height (cm)	Table Angle (Degree)	Remark
2472	93.63	91.67			31.88	5.5	35.42	100	38	Average
2472	96.25	94.29			31.88	5.5	35.42	100	38	Peak
2485.68	46.33	44.34	54	-7.67	31.88	5.53	35.42	100	38	Average
2485.68	55.05	53.06	74	-18.95	31.88	5.53	35.42	100	38	Peak
4944	40.76	32.49	54	-13.24	33.99	8.29	34.01	116	316	Average
4944	48.63	40.36	74	-25.37	33.99	8.29	34.01	116	316	Peak

Antennal Polarity & Test Distance: Vertical at 3 m

Frequency (MHz)	Emission Level (dBuV/m)	Read Level (dBuV)	Limit (dBuV/m)	Margin (dB)	Antenna Factor (dB/m)	Cable Loss (dB)	Preamp Factor (dB)	Antenna Height (cm)	Table Angle (Degree)	Remark
2472	90.73	88.77			31.88	5.5	35.42	104	24	Average
2472	93.61	91.65			31.88	5.5	35.42	104	24	Peak
2485.88	45.37	43.38	54	-8.63	31.88	5.53	35.42	104	24	Average
2485.88	54.15	52.16	74	-19.85	31.88	5.53	35.42	104	24	Peak
4944	41.15	32.88	54	-12.85	33.99	8.29	34.01	124	222	Average
4944	48.14	39.87	74	-25.86	33.99	8.29	34.01	124	222	Peak

Remarks:

- Emission Level = Read Level + Antenna Factor + Cable Loss - Preamp Factor
Margin value = Emission level – Limit value
- 2472 MHz: Fundamental frequency.

802.11g

EUT Test Condition		Measurement Detail	
Channel	Channel 1	Frequency Range	1 GHz ~ 25 GHz
Input Power	120 Vac, 60 Hz	Detector Function	Peak (PK) Average (AV)
Environmental Conditions	25 deg. C, 65 % RH	Tested By	Karl Lee

Horizontal

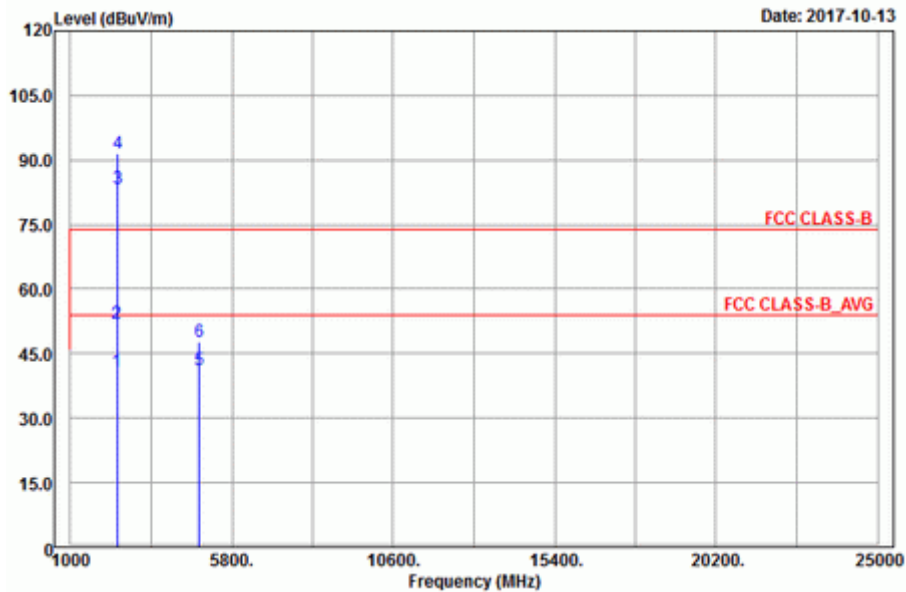

Vertical

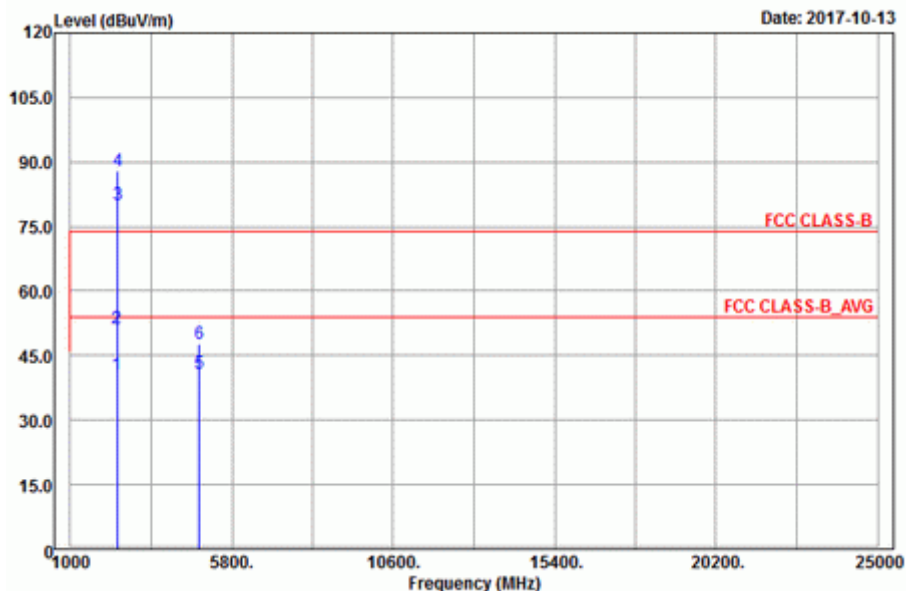

Antennal Polarity & Test Distance: Horizontal at 3 m

Frequency (MHz)	Emission Level (dBuV/m)	Read Level (dBuV)	Limit (dBuV/m)	Margin (dB)	Antenna Factor (dB/m)	Cable Loss (dB)	Preamp Factor (dB)	Antenna Height (cm)	Table Angle (Degree)	Remark
2389.65	40.85	39.14	54	-13.15	31.8	5.4	35.49	100	38	Average
2389.65	51.85	50.14	74	-22.15	31.8	5.4	35.49	100	38	Peak
2412	83.43	81.66			31.81	5.43	35.47	100	38	Average
2412	91.6	89.83			31.81	5.43	35.47	100	38	Peak
4824	41.27	33.14	54	-12.73	33.97	8.26	34.1	151	111	Average
4824	47.8	39.67	74	-26.2	33.97	8.26	34.1	151	111	Peak

Antennal Polarity & Test Distance: Vertical at 3 m

Frequency (MHz)	Emission Level (dBuV/m)	Read Level (dBuV)	Limit (dBuV/m)	Margin (dB)	Antenna Factor (dB/m)	Cable Loss (dB)	Preamp Factor (dB)	Antenna Height (cm)	Table Angle (Degree)	Remark
2388.84	40.52	38.81	54	-13.48	31.8	5.4	35.49	104	24	Average
2388.84	51.34	49.63	74	-22.66	31.8	5.4	35.49	104	24	Peak
2412	80.11	78.34			31.81	5.43	35.47	104	24	Average
2412	88.11	86.34			31.81	5.43	35.47	104	24	Peak
4824	40.98	32.85	54	-13.02	33.97	8.26	34.1	112	336	Average
4824	47.9	39.77	74	-26.1	33.97	8.26	34.1	112	336	Peak

Remarks:

- Emission Level = Read Level + Antenna Factor + Cable Loss - Preamp Factor
Margin value = Emission level – Limit value
- 2412 MHz: Fundamental frequency.

EUT Test Condition		Measurement Detail	
Channel	Channel 6	Frequency Range	1 GHz ~ 25 GHz
Input Power	120 Vac, 60 Hz	Detector Function	Peak (PK) Average (AV)
Environmental Conditions	25 deg. C, 65 % RH	Tested By	Karl Lee

Horizontal

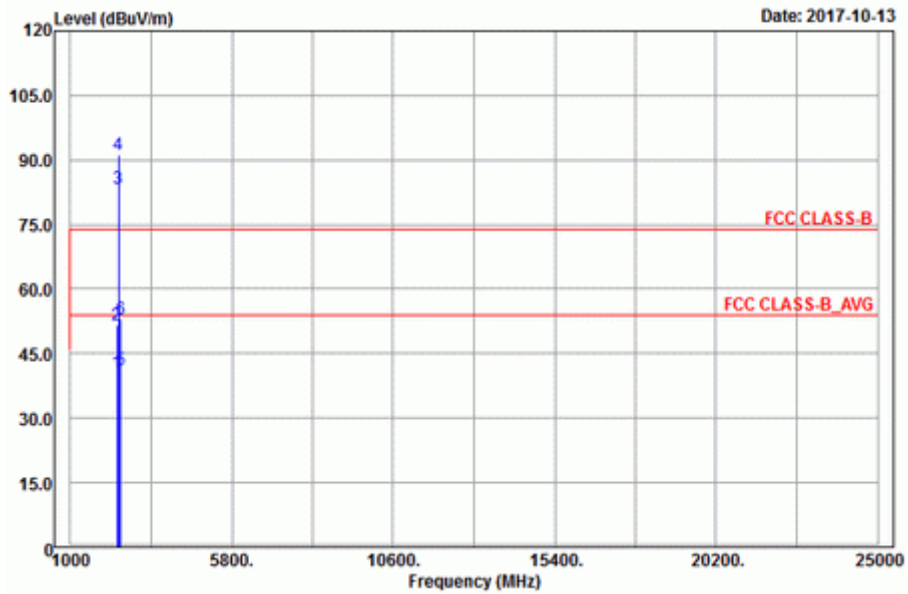

Vertical

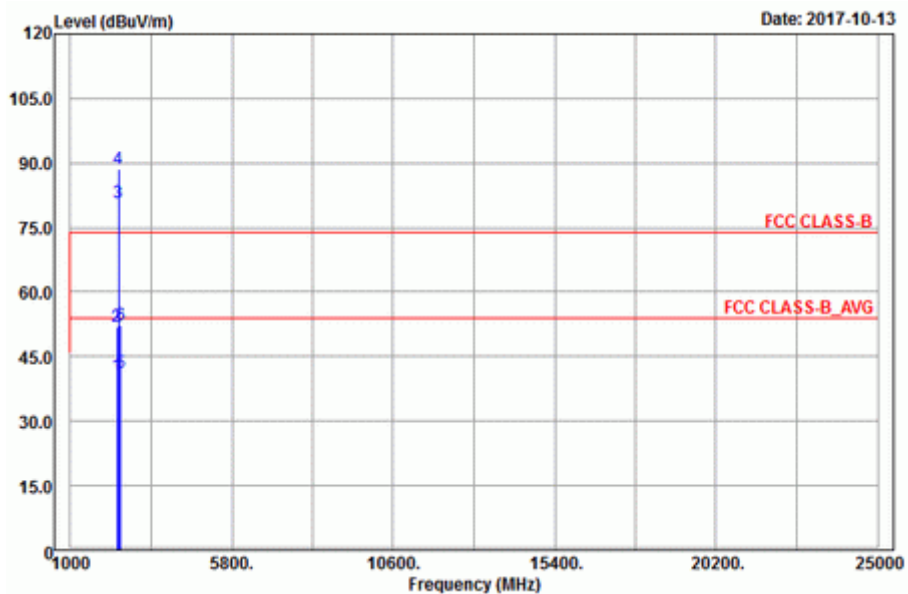

Antennal Polarity & Test Distance: Horizontal at 3 m

Frequency (MHz)	Emission Level (dBuV/m)	Read Level (dBuV)	Limit (dBuV/m)	Margin (dB)	Antenna Factor (dB/m)	Cable Loss (dB)	Preamp Factor (dB)	Antenna Height (cm)	Table Angle (Degree)	Remark
2384.7	40.5	38.81	54	-13.5	31.78	5.4	35.49	100	38	Average
2384.7	51.65	49.96	74	-22.35	31.78	5.4	35.49	100	38	Peak
2437	83.25	81.4			31.85	5.46	35.46	100	38	Average
2437	91.25	89.4			31.85	5.46	35.46	100	38	Peak
2488.84	41.15	39.14	54	-12.85	31.9	5.53	35.42	100	38	Average
2488.84	52.85	50.84	74	-21.15	31.9	5.53	35.42	100	38	Peak

Antennal Polarity & Test Distance: Vertical at 3 m

Frequency (MHz)	Emission Level (dBuV/m)	Read Level (dBuV)	Limit (dBuV/m)	Margin (dB)	Antenna Factor (dB/m)	Cable Loss (dB)	Preamp Factor (dB)	Antenna Height (cm)	Table Angle (Degree)	Remark
2383.53	40.53	38.84	54	-13.47	31.78	5.4	35.49	104	24	Average
2383.53	52.09	50.4	74	-21.91	31.78	5.4	35.49	104	24	Peak
2437	80.66	78.81			31.85	5.46	35.46	104	24	Average
2437	88.76	86.91			31.85	5.46	35.46	104	24	Peak
2489.36	41.19	39.18	54	-12.81	31.9	5.53	35.42	104	24	Average
2489.36	52.25	50.24	74	-21.75	31.9	5.53	35.42	104	24	Peak

Remarks:

- Emission Level = Read Level + Antenna Factor + Cable Loss - Preamp Factor
Margin value = Emission level – Limit value
- 2437 MHz: Fundamental frequency.

EUT Test Condition		Measurement Detail	
Channel	Channel 11	Frequency Range	1 GHz ~ 25 GHz
Input Power	120 Vac, 60 Hz	Detector Function	Peak (PK) Average (AV)
Environmental Conditions	25 deg. C, 65 % RH	Tested By	Karl Lee

Horizontal

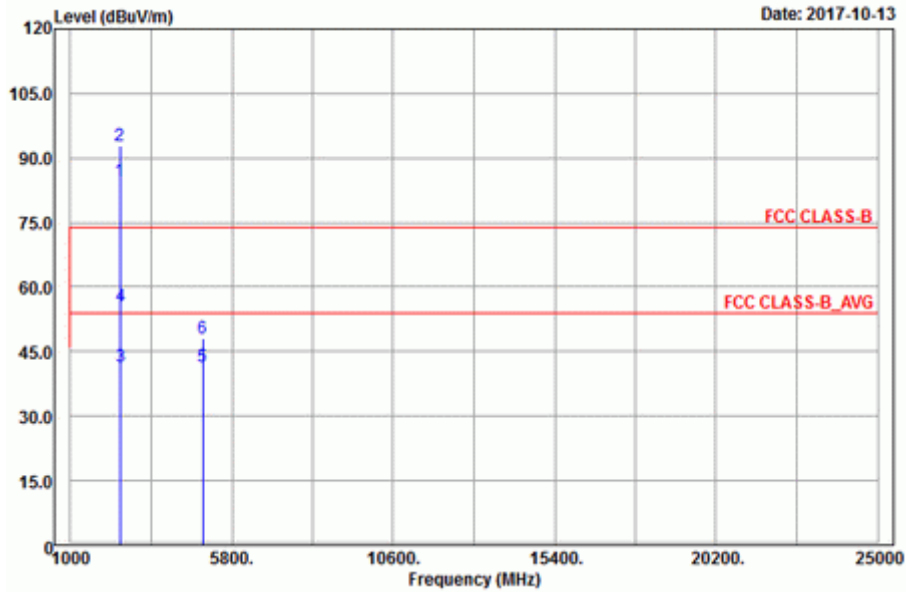

Vertical

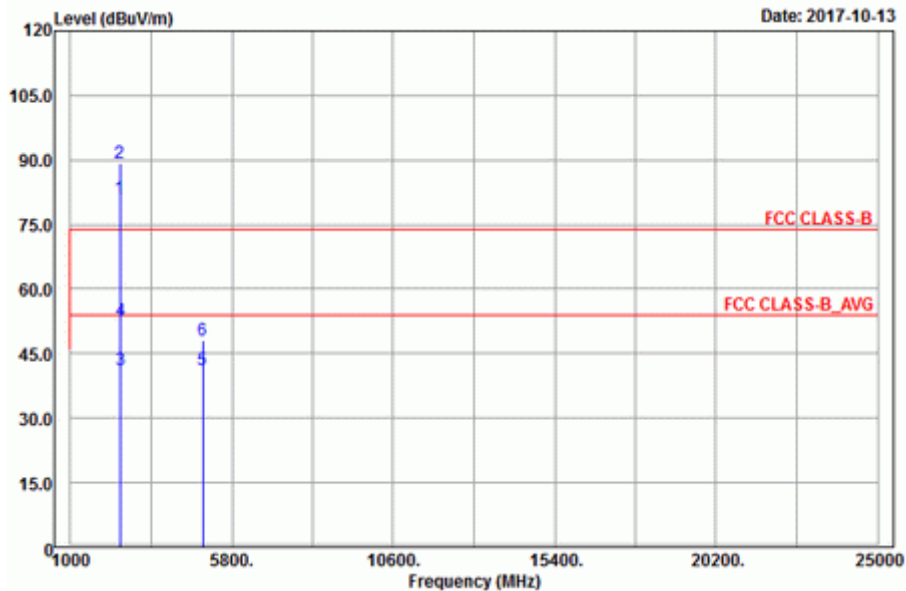

Antennal Polarity & Test Distance: Horizontal at 3 m

Frequency (MHz)	Emission Level (dBuV/m)	Read Level (dBuV)	Limit (dBuV/m)	Margin (dB)	Antenna Factor (dB/m)	Cable Loss (dB)	Preamp Factor (dB)	Antenna Height (cm)	Table Angle (Degree)	Remark
2462	84.53	82.6			31.87	5.5	35.44	100	38	Average
2462	92.93	91			31.87	5.5	35.44	100	38	Peak
2483.52	41.57	39.61	54	-12.43	31.88	5.5	35.42	100	38	Average
2483.52	55.73	53.77	74	-18.27	31.88	5.5	35.42	100	38	Peak
4924	41.47	33.22	54	-12.53	33.99	8.28	34.02	144	111	Average
4924	48.14	39.89	74	-25.86	33.99	8.28	34.02	144	111	Peak

Antennal Polarity & Test Distance: Vertical at 3 m

Frequency (MHz)	Emission Level (dBuV/m)	Read Level (dBuV)	Limit (dBuV/m)	Margin (dB)	Antenna Factor (dB/m)	Cable Loss (dB)	Preamp Factor (dB)	Antenna Height (cm)	Table Angle (Degree)	Remark
2462	81	79.07			31.87	5.5	35.44	101	67	Average
2462	89.27	87.34			31.87	5.5	35.44	101	67	Peak
2497.52	41.08	39.06	54	-12.92	31.9	5.53	35.41	101	67	Average
2497.52	52.65	50.63	74	-21.35	31.9	5.53	35.41	101	67	Peak
4924	41.19	32.94	54	-12.81	33.99	8.28	34.02	129	165	Average
4924	48.13	39.88	74	-25.87	33.99	8.28	34.02	129	165	Peak

Remarks:

- Emission Level = Read Level + Antenna Factor + Cable Loss - Preamp Factor
Margin value = Emission level – Limit value
- 2462 MHz: Fundamental frequency.

EUT Test Condition		Measurement Detail	
Channel	Channel 12	Frequency Range	1 GHz ~ 25 GHz
Input Power	120 Vac, 60 Hz	Detector Function	Peak (PK) Average (AV)
Environmental Conditions	25 deg. C, 65 % RH	Tested By	Karl Lee

Horizontal

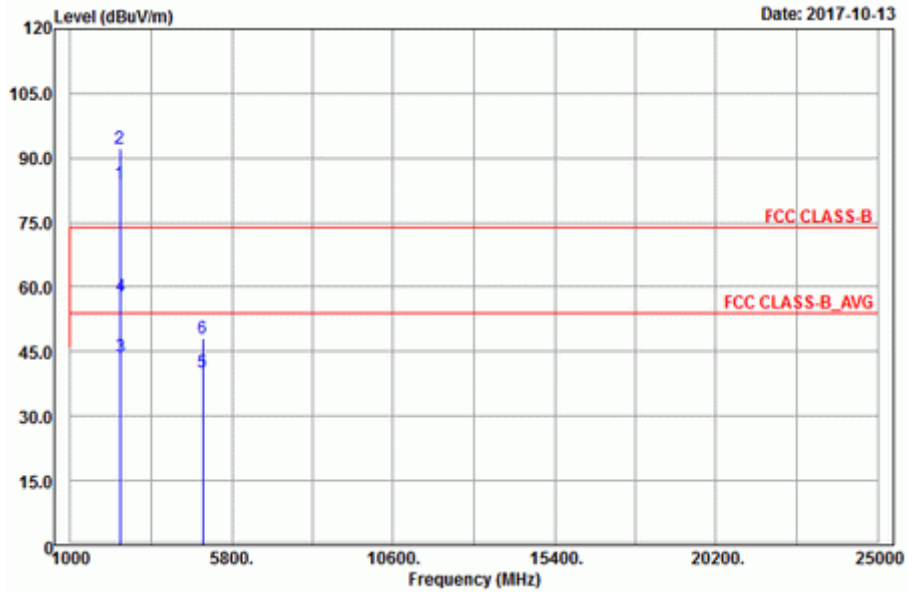

Vertical

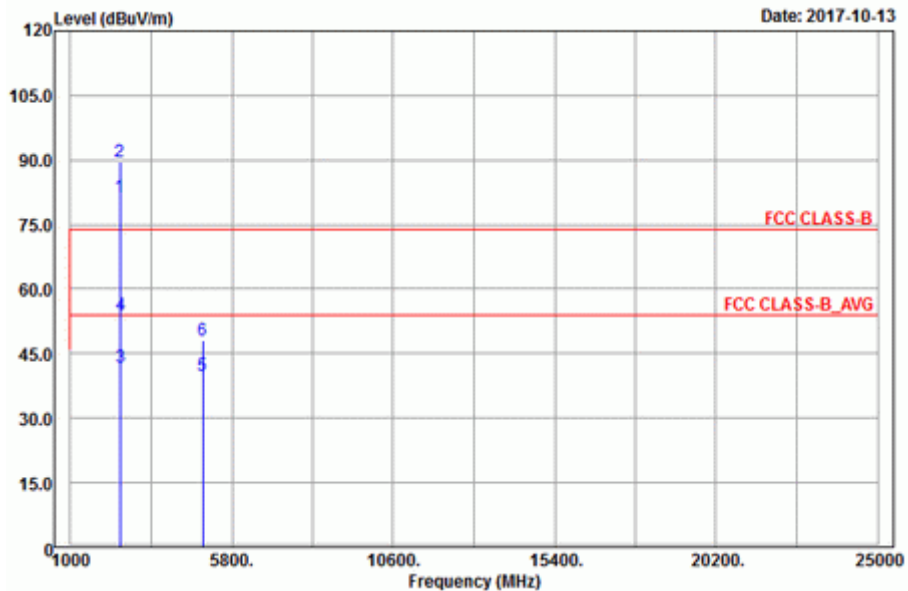

Antennal Polarity & Test Distance: Horizontal at 3 m

Frequency (MHz)	Emission Level (dBuV/m)	Read Level (dBuV)	Limit (dBuV/m)	Margin (dB)	Antenna Factor (dB/m)	Cable Loss (dB)	Preamp Factor (dB)	Antenna Height (cm)	Table Angle (Degree)	Remark
2467	84.08	82.13			31.87	5.5	35.42	100	38	Average
2467	92.19	90.24			31.87	5.5	35.42	100	38	Peak
2483.64	43.91	41.95	54	-10.09	31.88	5.5	35.42	100	38	Average
2483.64	57.8	55.84	74	-16.2	31.88	5.5	35.42	100	38	Peak
4934	40.28	32.02	54	-13.72	33.99	8.29	34.02	133	252	Average
4934	48	39.74	74	-26	33.99	8.29	34.02	133	252	Peak

Antennal Polarity & Test Distance: Vertical at 3 m

Frequency (MHz)	Emission Level (dBuV/m)	Read Level (dBuV)	Limit (dBuV/m)	Margin (dB)	Antenna Factor (dB/m)	Cable Loss (dB)	Preamp Factor (dB)	Antenna Height (cm)	Table Angle (Degree)	Remark
2467	81.43	79.48			31.87	5.5	35.42	104	24	Average
2467	89.58	87.63			31.87	5.5	35.42	104	24	Peak
2483.88	41.95	39.99	54	-12.05	31.88	5.5	35.42	104	24	Average
2483.88	53.85	51.89	74	-20.15	31.88	5.5	35.42	104	24	Peak
4934	39.99	31.73	54	-14.01	33.99	8.29	34.02	171	349	Average
4934	48.06	39.8	74	-25.94	33.99	8.29	34.02	171	349	Peak

Remarks:

- Emission Level = Read Level + Antenna Factor + Cable Loss - Preamp Factor
Margin value = Emission level – Limit value
- 2467 MHz: Fundamental frequency.

EUT Test Condition		Measurement Detail	
Channel	Channel 13	Frequency Range	1 GHz ~ 25 GHz
Input Power	120 Vac, 60 Hz	Detector Function	Peak (PK) Average (AV)
Environmental Conditions	25 deg. C, 65 % RH	Tested By	Karl Lee

Horizontal

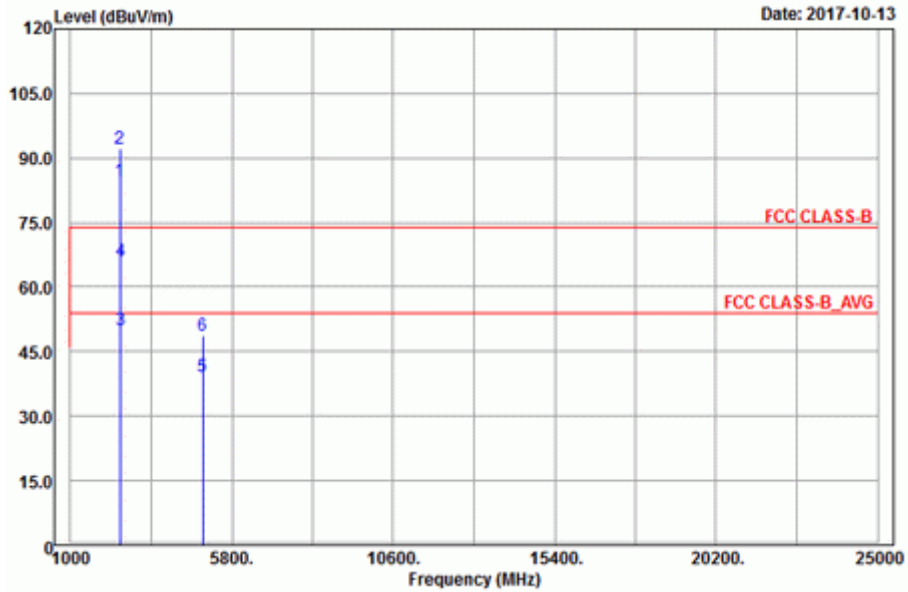

Vertical

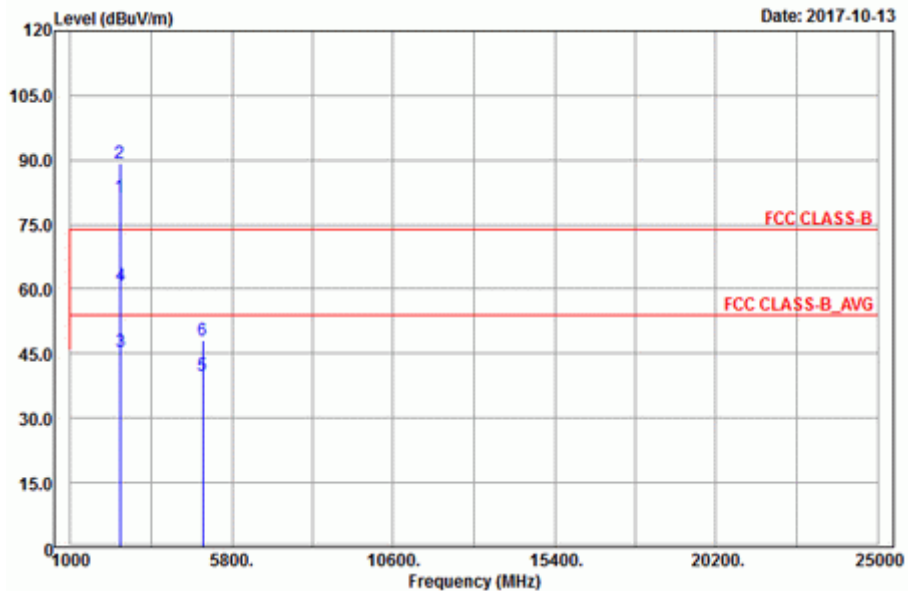

Antennal Polarity & Test Distance: Horizontal at 3 m

Frequency (MHz)	Emission Level (dBuV/m)	Read Level (dBuV)	Limit (dBuV/m)	Margin (dB)	Antenna Factor (dB/m)	Cable Loss (dB)	Preamp Factor (dB)	Antenna Height (cm)	Table Angle (Degree)	Remark
2472	84.54	82.58			31.88	5.5	35.42	100	38	Average
2472	92.24	90.28			31.88	5.5	35.42	100	38	Peak
2483.6	50.18	48.22	54	-3.82	31.88	5.5	35.42	100	38	Average
2483.6	66.08	64.12	74	-7.92	31.88	5.5	35.42	100	38	Peak
4944	39.35	31.08	54	-14.65	33.99	8.29	34.01	149	165	Average
4944	48.77	40.5	74	-25.23	33.99	8.29	34.01	149	165	Peak

Antennal Polarity & Test Distance: Vertical at 3 m

Frequency (MHz)	Emission Level (dBuV/m)	Read Level (dBuV)	Limit (dBuV/m)	Margin (dB)	Antenna Factor (dB/m)	Cable Loss (dB)	Preamp Factor (dB)	Antenna Height (cm)	Table Angle (Degree)	Remark
2472	81.47	79.51			31.88	5.5	35.42	104	24	Average
2472	89.13	87.17			31.88	5.5	35.42	104	24	Peak
2483.6	45.39	43.43	54	-8.61	31.88	5.5	35.42	104	24	Average
2483.6	60.84	58.88	74	-13.16	31.88	5.5	35.42	104	24	Peak
4944	40.04	31.77	54	-13.96	33.99	8.29	34.01	124	142	Average
4944	48.21	39.94	74	-25.79	33.99	8.29	34.01	124	142	Peak

Remarks:

- Emission Level = Read Level + Antenna Factor + Cable Loss - Preamp Factor
Margin value = Emission level – Limit value
- 2472 MHz: Fundamental frequency.

802.11n (HT20)

EUT Test Condition		Measurement Detail	
Channel	Channel 1	Frequency Range	1 GHz ~ 25 GHz
Input Power	120 Vac, 60 Hz	Detector Function	Peak (PK) Average (AV)
Environmental Conditions	25 deg. C, 65 % RH	Tested By	Karl Lee

Horizontal

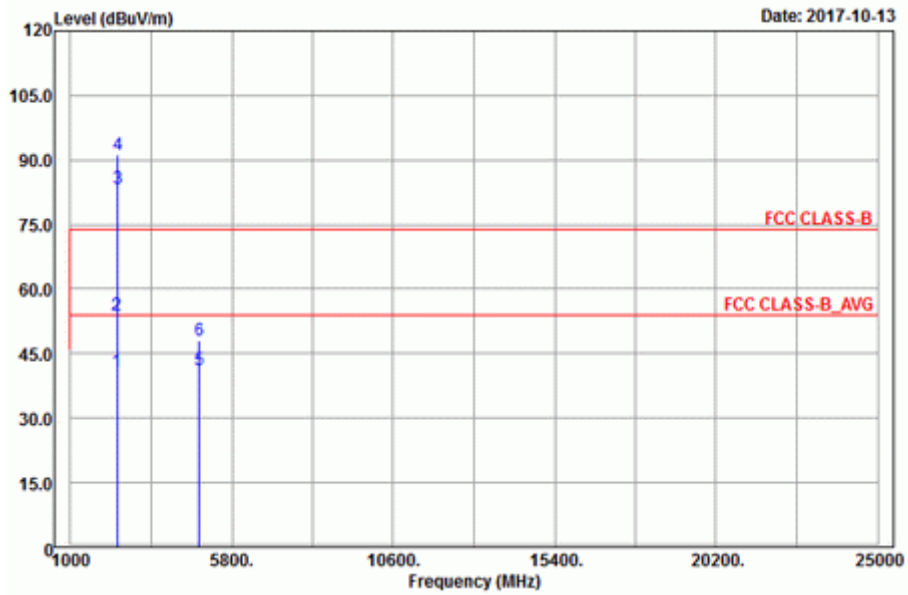

Vertical

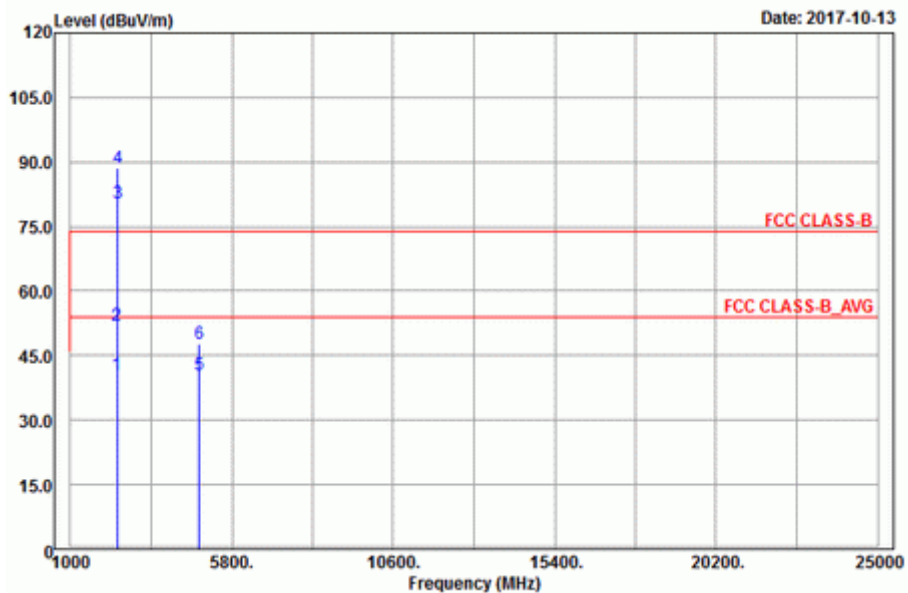

Antennal Polarity & Test Distance: Horizontal at 3 m

Frequency (MHz)	Emission Level (dBuV/m)	Read Level (dBuV)	Limit (dBuV/m)	Margin (dB)	Antenna Factor (dB/m)	Cable Loss (dB)	Preamp Factor (dB)	Antenna Height (cm)	Table Angle (Degree)	Remark
2389.74	40.99	39.28	54	-13.01	31.8	5.4	35.49	100	38	Average
2389.74	53.95	52.24	74	-20.05	31.8	5.4	35.49	100	38	Peak
2412	83.24	81.47			31.81	5.43	35.47	100	38	Average
2412	91.3	89.53			31.81	5.43	35.47	100	38	Peak
4824	41.13	33	54	-12.87	33.97	8.26	34.1	148	222	Average
4824	48.04	39.91	74	-25.96	33.97	8.26	34.1	148	222	Peak

Antennal Polarity & Test Distance: Vertical at 3 m

Frequency (MHz)	Emission Level (dBuV/m)	Read Level (dBuV)	Limit (dBuV/m)	Margin (dB)	Antenna Factor (dB/m)	Cable Loss (dB)	Preamp Factor (dB)	Antenna Height (cm)	Table Angle (Degree)	Remark
2388.21	40.49	38.78	54	-13.51	31.8	5.4	35.49	104	24	Average
2388.21	51.99	50.28	74	-22.01	31.8	5.4	35.49	104	24	Peak
2412	80.32	78.55			31.81	5.43	35.47	104	24	Average
2412	88.67	86.9			31.81	5.43	35.47	104	24	Peak
4824	40.61	32.48	54	-13.39	33.97	8.26	34.1	105	113	Average
4824	47.65	39.52	74	-26.35	33.97	8.26	34.1	105	113	Peak

Remarks:

- Emission Level = Read Level + Antenna Factor + Cable Loss - Preamp Factor
Margin value = Emission level – Limit value
- 2412 MHz: Fundamental frequency.

EUT Test Condition		Measurement Detail	
Channel	Channel 6	Frequency Range	1 GHz ~ 25 GHz
Input Power	120 Vac, 60 Hz	Detector Function	Peak (PK) Average (AV)
Environmental Conditions	25 deg. C, 65 % RH	Tested By	Karl Lee

Horizontal

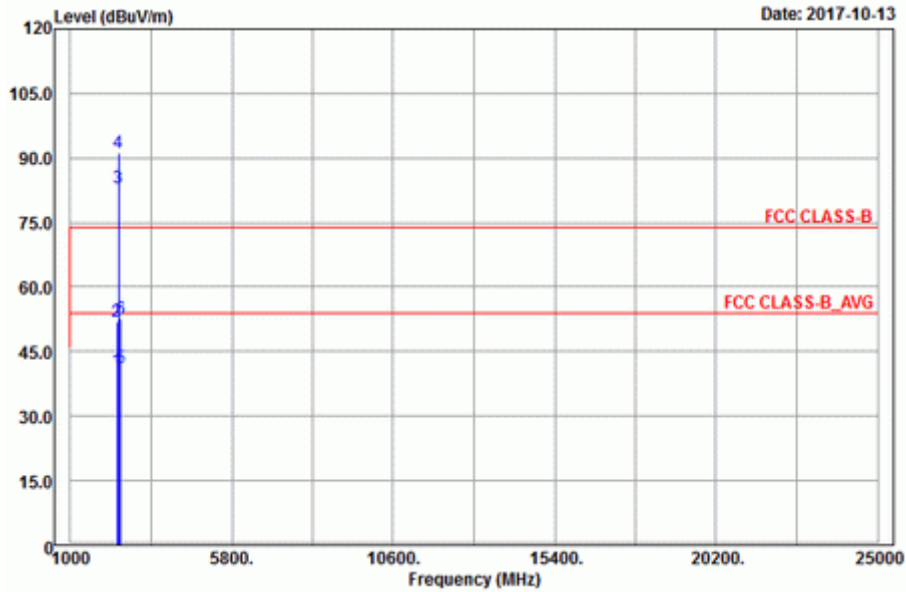

Vertical

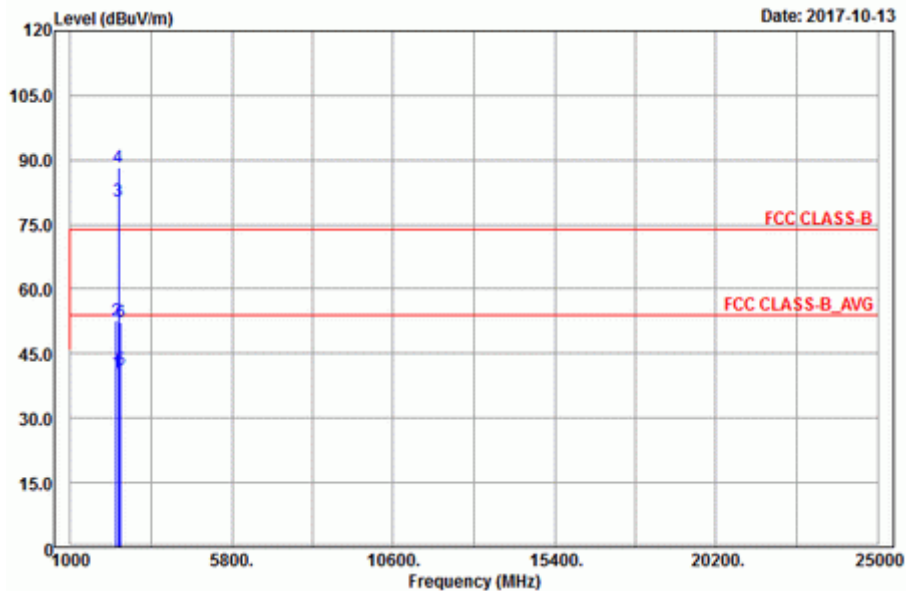

Antennal Polarity & Test Distance: Horizontal at 3 m

Frequency (MHz)	Emission Level (dBuV/m)	Read Level (dBuV)	Limit (dBuV/m)	Margin (dB)	Antenna Factor (dB/m)	Cable Loss (dB)	Preamp Factor (dB)	Antenna Height (cm)	Table Angle (Degree)	Remark
2385.96	40.61	38.9	54	-13.39	31.8	5.4	35.49	100	38	Average
2385.96	52.13	50.42	74	-21.87	31.8	5.4	35.49	100	38	Peak
2437	83.14	81.29			31.85	5.46	35.46	100	38	Average
2437	91.09	89.24			31.85	5.46	35.46	100	38	Peak
2488.28	41.19	39.18	54	-12.81	31.9	5.53	35.42	100	38	Average
2488.28	52.56	50.55	74	-21.44	31.9	5.53	35.42	100	38	Peak

Antennal Polarity & Test Distance: Vertical at 3 m

Frequency (MHz)	Emission Level (dBuV/m)	Read Level (dBuV)	Limit (dBuV/m)	Margin (dB)	Antenna Factor (dB/m)	Cable Loss (dB)	Preamp Factor (dB)	Antenna Height (cm)	Table Angle (Degree)	Remark
2360.13	40.54	38.91	54	-13.46	31.76	5.37	35.5	104	24	Average
2360.13	52.6	50.97	74	-21.4	31.76	5.37	35.5	104	24	Peak
2437	80.43	78.58			31.85	5.46	35.46	104	24	Average
2437	88.15	86.3			31.85	5.46	35.46	104	24	Peak
2493.88	41.1	39.08	54	-12.9	31.9	5.53	35.41	104	24	Average
2493.88	52.41	50.39	74	-21.59	31.9	5.53	35.41	104	24	Peak

Remarks:

1. Emission Level = Read Level + Antenna Factor + Cable Loss - Preamp Factor

Margin value = Emission level – Limit value

2. 2437 MHz: Fundamental frequency.

EUT Test Condition		Measurement Detail	
Channel	Channel 11	Frequency Range	1 GHz ~ 25 GHz
Input Power	120 Vac, 60 Hz	Detector Function	Peak (PK) Average (AV)
Environmental Conditions	25 deg. C, 65 % RH	Tested By	Karl Lee

Horizontal

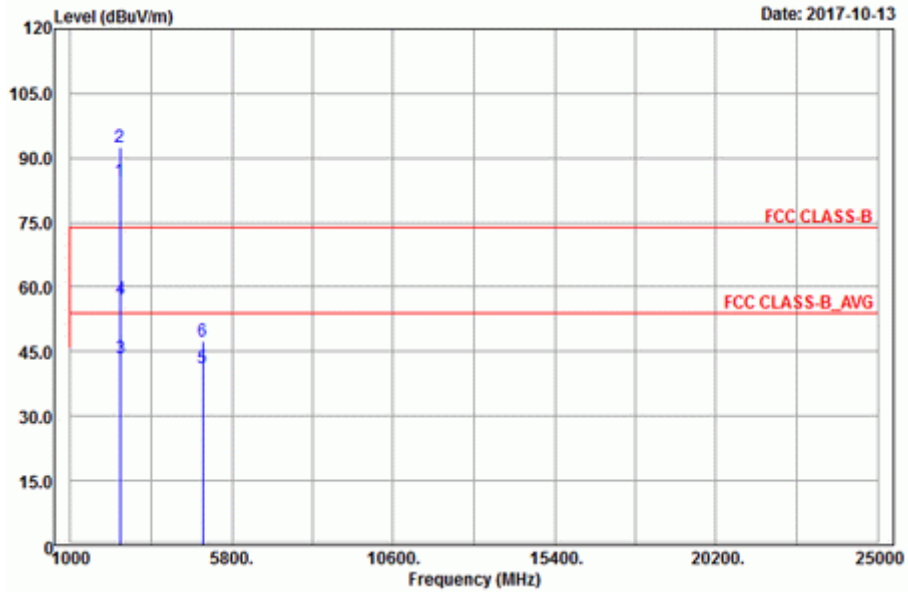

Vertical

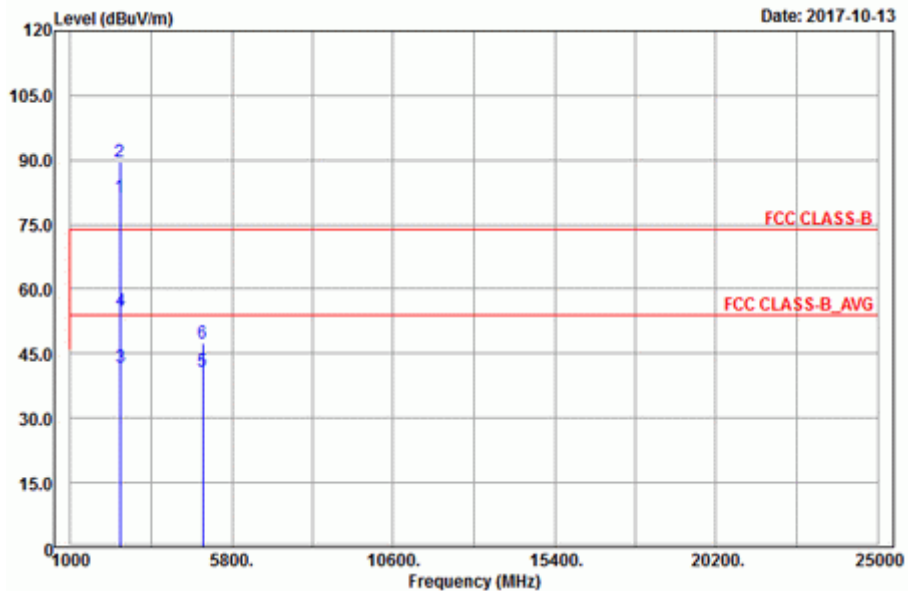

Antennal Polarity & Test Distance: Horizontal at 3 m										
Frequency (MHz)	Emission Level (dBuV/m)	Read Level (dBuV)	Limit (dBuV/m)	Margin (dB)	Antenna Factor (dB/m)	Cable Loss (dB)	Preamp Factor (dB)	Antenna Height (cm)	Table Angle (Degree)	Remark
2462	84.53	82.6			31.87	5.5	35.44	100	38	Average
2462	92.64	90.71			31.87	5.5	35.44	100	38	Peak
2483.56	43.38	41.42	54	-10.62	31.88	5.5	35.42	100	38	Average
2483.56	57.08	55.12	74	-16.92	31.88	5.5	35.42	100	38	Peak
4924	41.27	33.02	54	-12.73	33.99	8.28	34.02	112	212	Average
4924	47.55	39.3	74	-26.45	33.99	8.28	34.02	112	212	Peak
Antennal Polarity & Test Distance: Vertical at 3 m										
Frequency (MHz)	Emission Level (dBuV/m)	Read Level (dBuV)	Limit (dBuV/m)	Margin (dB)	Antenna Factor (dB/m)	Cable Loss (dB)	Preamp Factor (dB)	Antenna Height (cm)	Table Angle (Degree)	Remark
2462	81.43	79.5			31.87	5.5	35.44	104	24	Average
2462	89.47	87.54			31.87	5.5	35.44	104	24	Peak
2483.64	41.76	39.8	54	-12.24	31.88	5.5	35.42	104	24	Average
2483.64	54.96	53	74	-19.04	31.88	5.5	35.42	104	24	Peak
4924	40.73	32.48	54	-13.27	33.99	8.28	34.02	117	195	Average
4924	47.37	39.12	74	-26.63	33.99	8.28	34.02	117	195	Peak

Remarks:

- Emission Level = Read Level + Antenna Factor + Cable Loss - Preamp Factor
Margin value = Emission level – Limit value
- 2462 MHz: Fundamental frequency.

EUT Test Condition		Measurement Detail	
Channel	Channel 12	Frequency Range	1 GHz ~ 25 GHz
Input Power	120 Vac, 60 Hz	Detector Function	Peak (PK) Average (AV)
Environmental Conditions	25 deg. C, 65 % RH	Tested By	Karl Lee

Horizontal

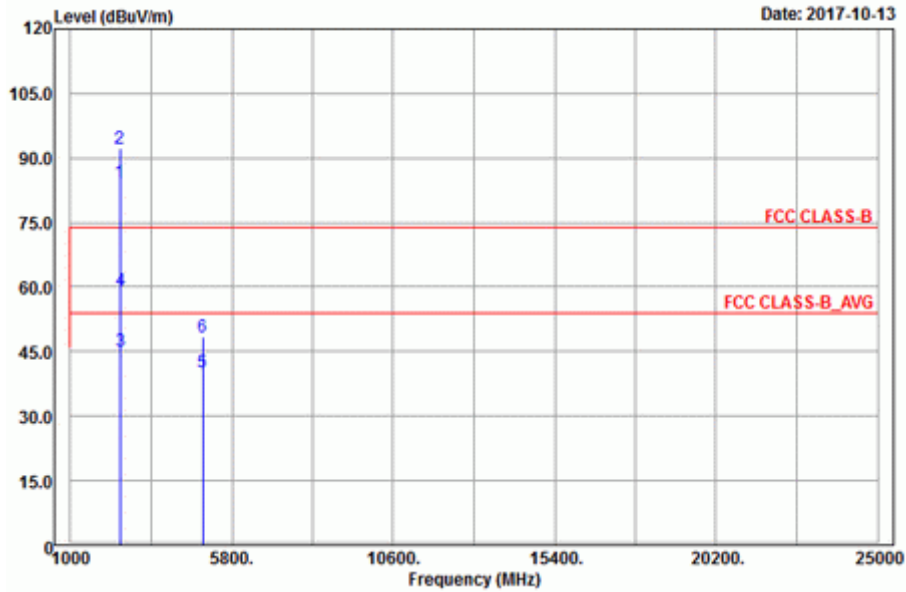

Vertical

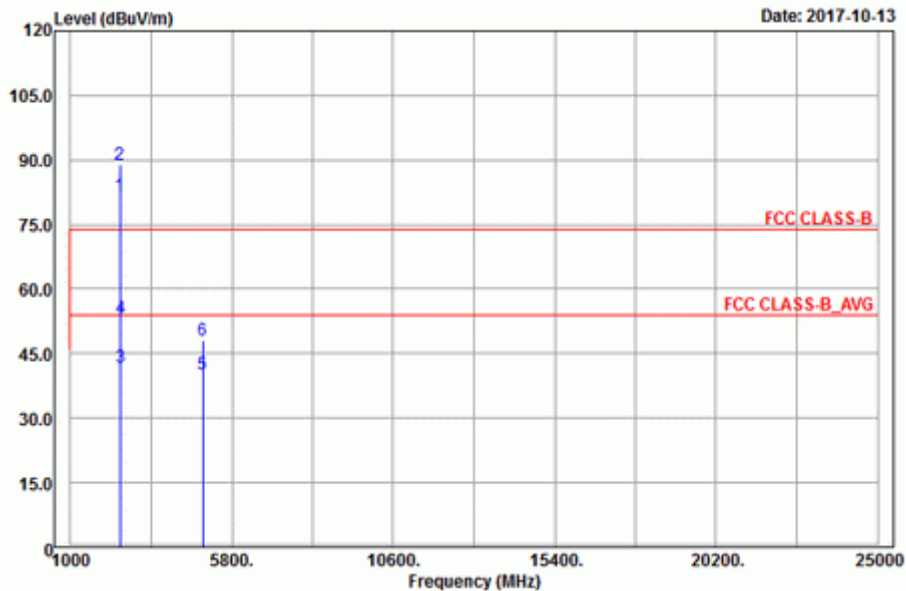

Antennal Polarity & Test Distance: Horizontal at 3 m

Frequency (MHz)	Emission Level (dBuV/m)	Read Level (dBuV)	Limit (dBuV/m)	Margin (dB)	Antenna Factor (dB/m)	Cable Loss (dB)	Preamp Factor (dB)	Antenna Height (cm)	Table Angle (Degree)	Remark
2467	84.38	82.43			31.87	5.5	35.42	100	38	Average
2467	92.22	90.27			31.87	5.5	35.42	100	38	Peak
2483.64	45.04	43.08	54	-8.96	31.88	5.5	35.42	100	38	Average
2483.64	59.27	57.31	74	-14.73	31.88	5.5	35.42	100	38	Peak
4934	40.1	31.84	54	-13.9	33.99	8.29	34.02	118	124	Average
4934	48.4	40.14	74	-25.6	33.99	8.29	34.02	118	124	Peak

Antennal Polarity & Test Distance: Vertical at 3 m

Frequency (MHz)	Emission Level (dBuV/m)	Read Level (dBuV)	Limit (dBuV/m)	Margin (dB)	Antenna Factor (dB/m)	Cable Loss (dB)	Preamp Factor (dB)	Antenna Height (cm)	Table Angle (Degree)	Remark
2467	81.79	79.84			31.87	5.5	35.42	104	24	Average
2467	89.09	87.14			31.87	5.5	35.42	104	24	Peak
2484.24	41.84	39.85	54	-12.16	31.88	5.53	35.42	104	24	Average
2484.24	53.36	51.37	74	-20.64	31.88	5.53	35.42	104	24	Peak
4934	40.24	31.98	54	-13.76	33.99	8.29	34.02	124	4	Average
4934	48.06	39.8	74	-25.94	33.99	8.29	34.02	124	4	Peak

Remarks:

- Emission Level = Read Level + Antenna Factor + Cable Loss - Preamp Factor
Margin value = Emission level – Limit value
- 2467 MHz: Fundamental frequency.

EUT Test Condition		Measurement Detail	
Channel	Channel 13	Frequency Range	1 GHz ~ 25 GHz
Input Power	120 Vac, 60 Hz	Detector Function	Peak (PK) Average (AV)
Environmental Conditions	25 deg. C, 65 % RH	Tested By	Karl Lee

Horizontal

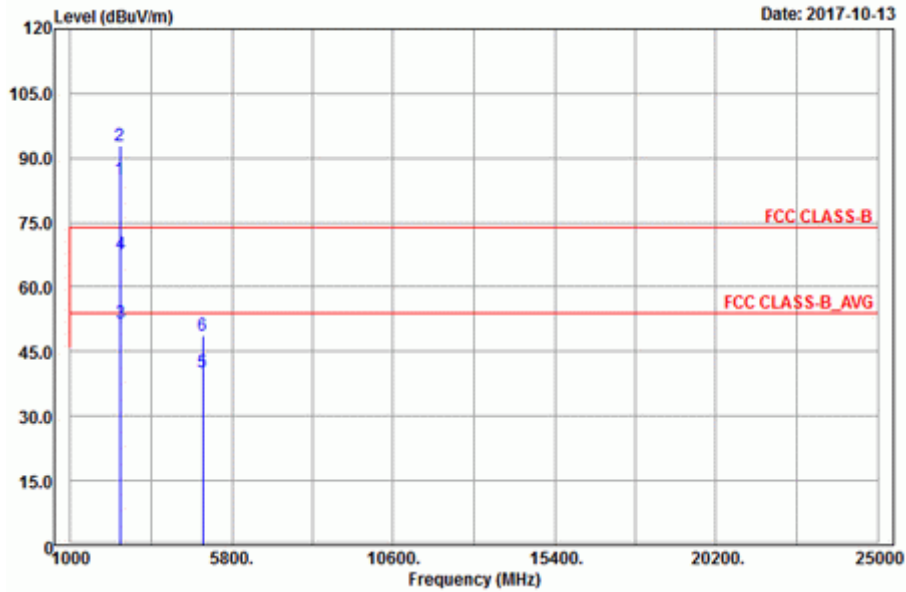

Vertical

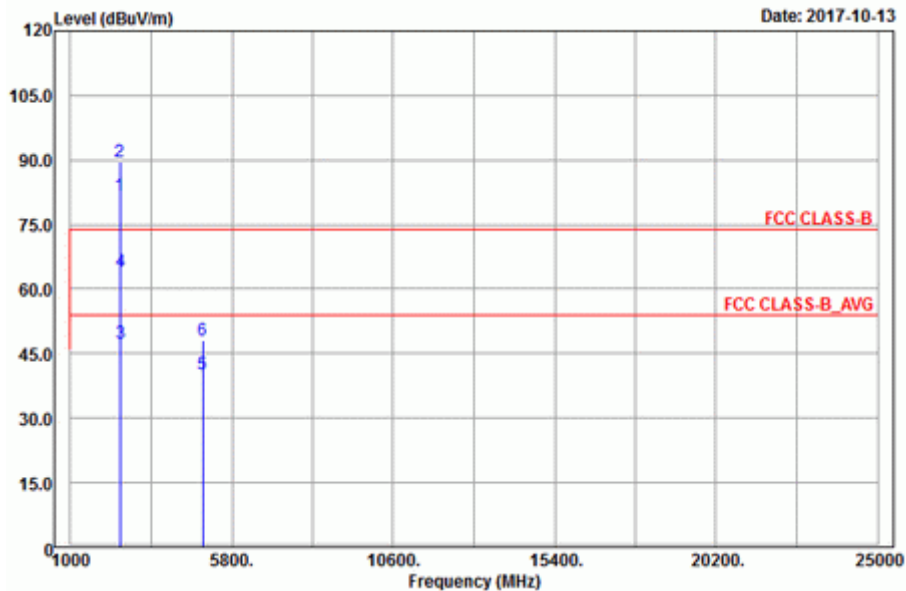

Antennal Polarity & Test Distance: Horizontal at 3 m										
Frequency (MHz)	Emission Level (dBuV/m)	Read Level (dBuV)	Limit (dBuV/m)	Margin (dB)	Antenna Factor (dB/m)	Cable Loss (dB)	Preamp Factor (dB)	Antenna Height (cm)	Table Angle (Degree)	Remark
2472	84.96	83			31.88	5.5	35.42	100	38	Average
2472	92.77	90.81			31.88	5.5	35.42	100	38	Peak
2483.56	51.72	49.76	54	-2.28	31.88	5.5	35.42	100	38	Average
2483.56	67.76	65.8	74	-6.24	31.88	5.5	35.42	100	38	Peak
4944	40.32	32.05	54	-13.68	33.99	8.29	34.01	113	356	Average
4944	48.81	40.54	74	-25.19	33.99	8.29	34.01	113	356	Peak
Antennal Polarity & Test Distance: Vertical at 3 m										
Frequency (MHz)	Emission Level (dBuV/m)	Read Level (dBuV)	Limit (dBuV/m)	Margin (dB)	Antenna Factor (dB/m)	Cable Loss (dB)	Preamp Factor (dB)	Antenna Height (cm)	Table Angle (Degree)	Remark
2472	81.86	79.9			31.88	5.5	35.42	104	24	Average
2472	89.52	87.56			31.88	5.5	35.42	104	24	Peak
2483.52	47.56	45.6	54	-6.44	31.88	5.5	35.42	104	24	Average
2483.52	64.1	62.14	74	-9.9	31.88	5.5	35.42	104	24	Peak
4944	40.13	31.86	54	-13.87	33.99	8.29	34.01	154	205	Average
4944	48.21	39.94	74	-25.79	33.99	8.29	34.01	154	205	Peak

Remarks:

1. Emission Level = Read Level + Antenna Factor + Cable Loss - Preamp Factor

Margin value = Emission level – Limit value

2. 2472 MHz: Fundamental frequency.

9 kHz ~ 30 MHz Data:

The amplitude of spurious emissions attenuated more than 20 dB below the permissible value is not required to be report.

30 MHz ~ 1 GHz Worst-Case Data:

Mode A

802.11n (HT20)

EUT Test Condition		Measurement Detail	
Channel	Channel 13	Frequency Range	30 MHz ~ 1 GHz
Input Power	120 Vac, 60 Hz	Detector Function	Peak (PK) Quasi-peak (QP)
Environmental Conditions	25 deg. C, 65 % RH	Tested By	Karl Lee

Horizontal

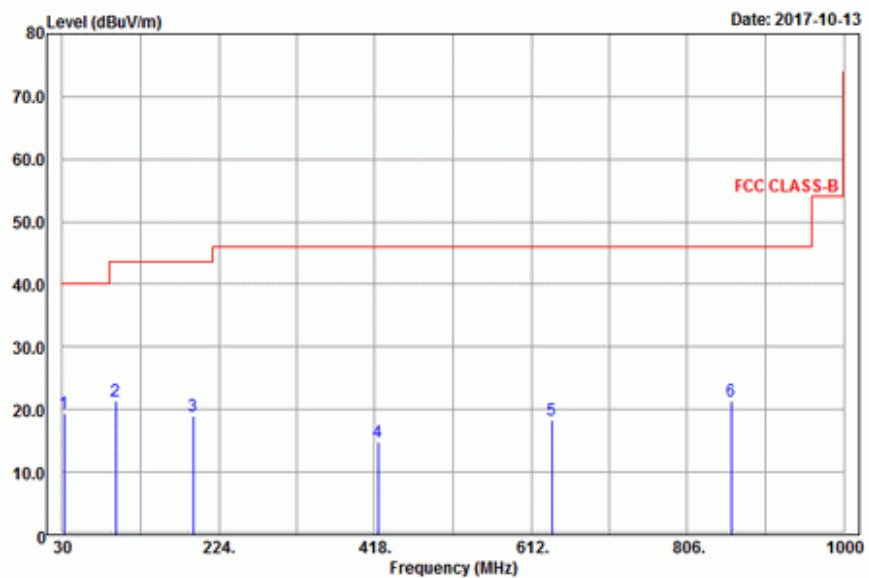

Vertical

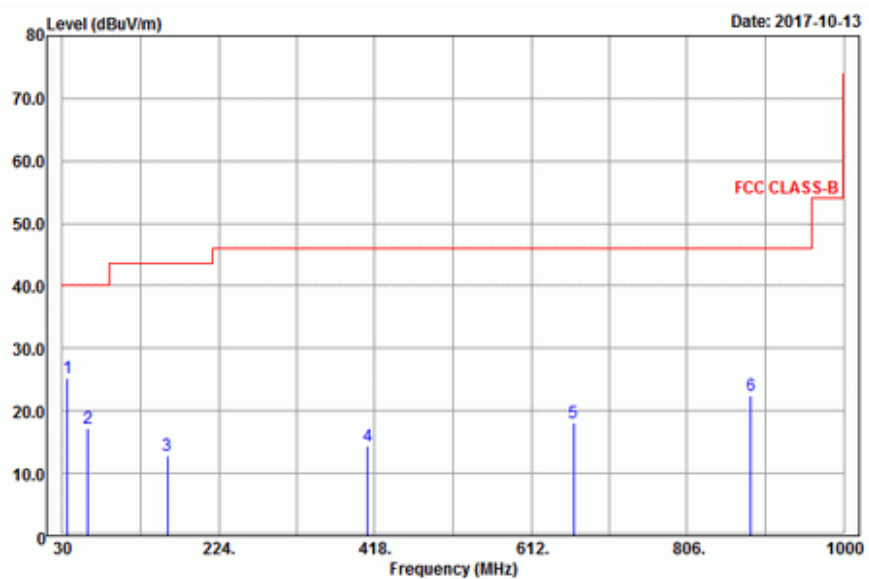

Antennal Polarity & Test Distance: Horizontal at 3 m

Frequency (MHz)	Emission Level (dBuV/m)	Read Level (dBuV)	Limit (dBuV/m)	Margin (dB)	Antenna Factor (dB/m)	Cable Loss (dB)	Preamp Factor (dB)	Antenna Height (cm)	Table Angle (Degree)	Remark
32.16	19.39	39.25	40	-20.61	11.66	0.74	32.26	168	151	Peak
96.15	21.38	40.39	43.5	-22.12	11.75	1.28	32.04	133	208	Peak
192	19	38.9	43.5	-24.5	10.75	1.61	32.26	167	125	Peak
421.8	14.83	29.36	46	-31.17	15.25	2.41	32.19	105	274	Peak
638.1	18.2	29.16	46	-27.8	18.27	2.93	32.16	193	216	Peak
860	21.29	28.42	46	-24.71	21.16	3.44	31.73	145	203	Peak

Antennal Polarity & Test Distance: Vertical at 3 m

Frequency (MHz)	Emission Level (dBuV/m)	Read Level (dBuV)	Limit (dBuV/m)	Margin (dB)	Antenna Factor (dB/m)	Cable Loss (dB)	Preamp Factor (dB)	Antenna Height (cm)	Table Angle (Degree)	Remark
35.94	25.27	44.41	40	-14.73	12.35	0.74	32.23	132	226	Peak
61.32	17.24	35.46	40	-22.76	13.11	0.9	32.23	148	227	Peak
160.41	12.77	34.77	43.5	-30.73	8.75	1.52	32.27	196	118	Peak
409.2	14.46	29.16	46	-31.54	15.1	2.41	32.21	185	163	Peak
664.7	18.18	28.64	46	-27.82	18.68	2.99	32.13	174	115	Peak
885.2	22.47	29.18	46	-23.53	21.37	3.49	31.57	150	328	Peak

Remarks:

- Emission Level = Read Level + Antenna Factor + Cable Loss - Preamp Factor
Margin value = Emission level – Limit value

Mode B

802.11n (HT20)

EUT Test Condition		Measurement Detail	
Channel	Channel 13	Frequency Range	30 MHz ~ 1 GHz
Input Power	120 Vac, 60 Hz	Detector Function	Peak (PK) Quasi-peak (QP)
Environmental Conditions	25 deg. C, 65 % RH	Tested By	Karl Lee

Horizontal

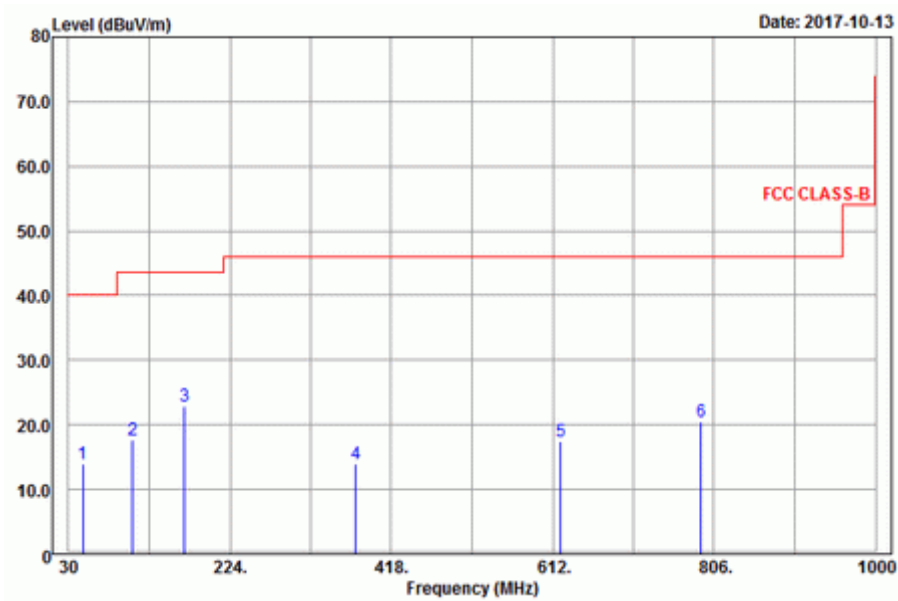

Vertical

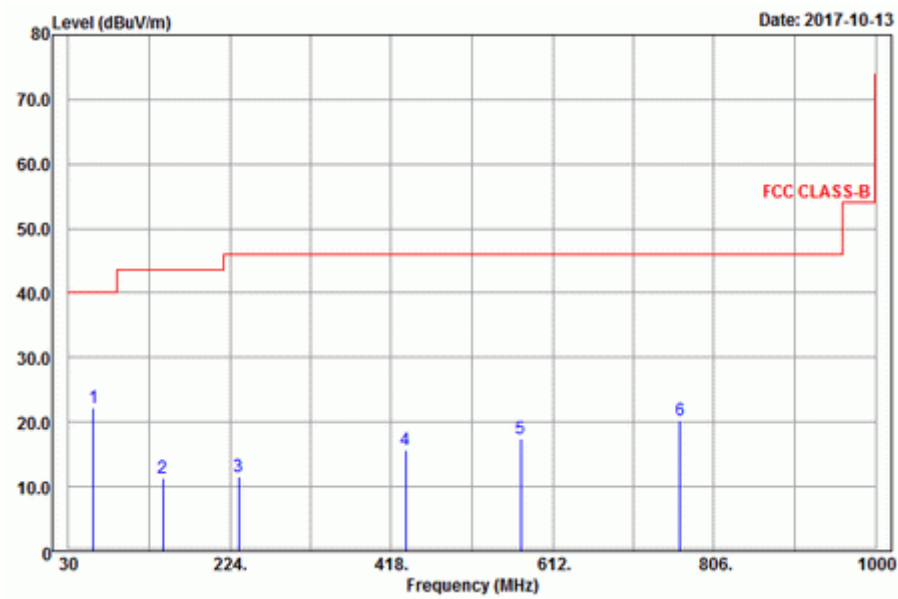

Antennal Polarity & Test Distance: Horizontal at 3 m

Frequency (MHz)	Emission Level (dBuV/m)	Read Level (dBuV)	Limit (dBuV/m)	Margin (dB)	Antenna Factor (dB/m)	Cable Loss (dB)	Preamp Factor (dB)	Antenna Height (cm)	Table Angle (Degree)	Remark
47.01	14.06	30.87	40	-25.94	14.51	0.9	32.22	199	72	Peak
107.49	17.76	36.54	43.5	-25.74	12.19	1.28	32.25	165	138	Peak
169.59	22.97	44.6	43.5	-20.53	9.09	1.52	32.24	127	153	Peak
375.6	14.03	29.39	46	-31.97	14.53	2.26	32.15	175	169	Peak
621.3	17.47	28.56	46	-28.53	18.15	2.93	32.17	105	142	Peak
790.7	20.47	29.04	46	-25.53	20.23	3.27	32.07	103	217	Peak

Antennal Polarity & Test Distance: Vertical at 3 m

Frequency (MHz)	Emission Level (dBuV/m)	Read Level (dBuV)	Limit (dBuV/m)	Margin (dB)	Antenna Factor (dB/m)	Cable Loss (dB)	Preamp Factor (dB)	Antenna Height (cm)	Table Angle (Degree)	Remark
59.7	22.22	40.18	40	-17.78	13.37	0.9	32.23	161	320	Peak
143.13	11.44	33.94	43.5	-32.06	8.39	1.38	32.27	134	221	Peak
234.93	11.53	29.92	46	-34.47	11.92	1.85	32.16	188	175	Peak
435.1	15.8	30.11	46	-30.2	15.37	2.49	32.17	150	167	Peak
573.7	17.43	29.27	46	-28.57	17.54	2.82	32.2	185	192	Peak
765.5	20.3	29.23	46	-25.7	19.97	3.22	32.12	121	64	Peak

Remarks:

- Emission Level = Read Level + Antenna Factor + Cable Loss - Preamp Factor
Margin value = Emission level – Limit value

4.2 Conducted Emission Measurement

4.2.1 Limits of Conducted Emission Measurement

Frequency (MHz)	Conducted Limit (dBUV)	
	Quasi-peak	Average
0.15 - 0.5	66 - 56	56 - 46
0.50 - 5.0	56	46
5.0 - 30.0	60	50

- Note: 1. The lower limit shall apply at the transition frequencies.
 2. The limit decreases in line with the logarithm of the frequency in the range of 0.15 to 0.50 MHz.

4.2.2 Test Instruments

Description & Manufacturer	Model No.	Serial No.	Date Of Calibration	Due Date Of Calibration
Test Receiver ROHDE & SCHWARZ	ESCS 30	100288	Aug. 17, 2017	Aug. 16, 2018
RF signal cable (with 10dB PAD) Woken	5D-FB	Cable-cond2-01	Sep. 08, 2017	Sep. 07, 2018
LISN/AMN ROHDE & SCHWARZ (EUT)	ESH2-Z5	100100	Jan. 17, 2017	Jan. 16, 2018
LISN/AMN ROHDE & SCHWARZ (Peripheral)	ESH3-Z5	100312	Aug. 02, 2017	Aug. 01, 2018
Software ADT	BV ADT_Cond_ V7.3.7.3	NA	NA	NA

- Note: 1. The calibration interval of the above test instruments is 12 months and the calibrations are traceable to NML/ROC and NIST/USA.
 2. The test was performed in HwaYa Shielded Room 2.
 3. The VCCI Site Registration No. is C-2047.

4.2.3 Test Procedures

- a. The EUT was placed 0.4 meters from the conducting wall of the shielded room with EUT being connected to the power mains through a line impedance stabilization network (LISN). Other support units were connected to the power mains through another LISN. The two LISNs provide 50 ohm/50 uH of coupling impedance for the measuring instrument.
- b. Both lines of the power mains connected to the EUT were checked for maximum conducted interference.
- c. The frequency range from 150 kHz to 30 MHz was searched. Emission levels under (Limit – 20 dB) was not recorded.

NOTE: All modes of operation were investigated and the worst-case emissions are reported.

4.2.4 Deviation from Test Standard

No deviation.

4.2.5 Test Setup

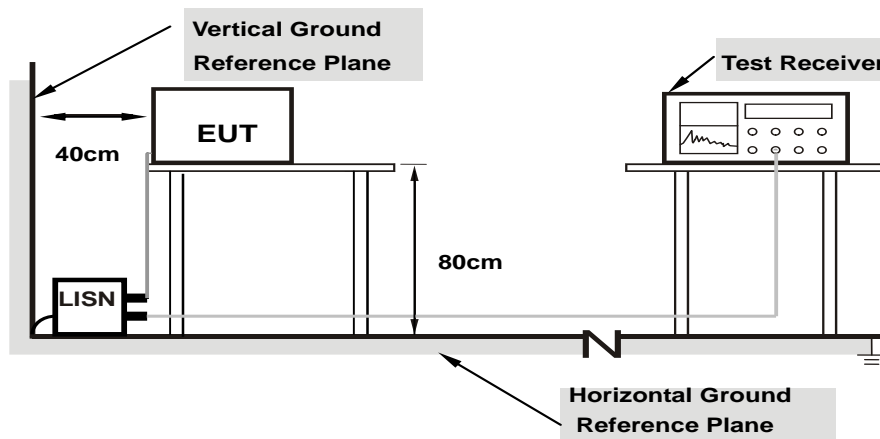

Note: 1.Support units were connected to second LISN.

For the actual test configuration, please refer to the attached file (Test Setup Photo).

4.2.6 EUT Operating Conditions

- a. Placed the EUT on a testing table.
- b. Use the software to control the EUT under transmission condition continuously at specific channel frequency.

4.2.7 Test Results

Mode A

Frequency Range	150kHz ~ 30MHz	Detector Function & Resolution Bandwidth	Quasi-Peak (QP) / Average (AV), 9kHz
Input Power	120Vac, 60Hz	Environmental Conditions	25°C, 65%RH
Tested by	Getaz Yang	Test Date	2017/10/19

Phase Of Power : Line (L)										
No	Frequency (MHz)	Correction Factor (dB)	Reading Value (dBuV)		Emission Level (dBuV)		Limit (dBuV)		Margin (dB)	
			Q.P.	AV.	Q.P.	AV.	Q.P.	AV.	Q.P.	AV.
1	0.49375	10.31	40.75	28.52	51.06	38.83	56.10	46.10	-5.04	-7.27
2	0.82578	10.38	26.52	32.99	36.90	43.37	56.00	46.00	-19.10	-2.63
3	1.47656	10.39	39.38	32.33	49.77	42.72	56.00	46.00	-6.23	-3.28
4	2.79297	10.41	17.84	21.11	28.25	31.52	56.00	46.00	-27.75	-14.48
5	3.60938	10.45	18.81	10.00	29.26	20.45	56.00	46.00	-26.74	-25.55
6	5.27344	10.49	38.09	33.41	48.58	43.90	60.00	50.00	-11.42	-6.10

Remarks:

1. Q.P. and AV. are abbreviations of quasi-peak and average individually.
2. The emission levels of other frequencies were very low against the limit.
3. Margin value = Emission level – Limit value
4. Correction factor = Insertion loss + Cable loss
5. Emission Level = Correction Factor + Reading Value

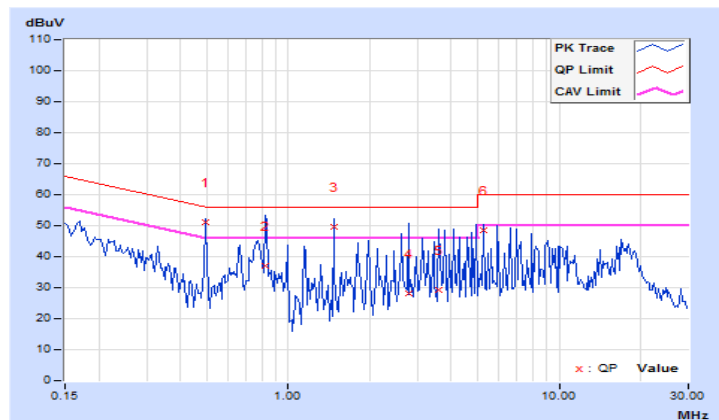

Frequency Range	150kHz ~ 30MHz	Detector Function & Resolution Bandwidth	Quasi-Peak (QP) / Average (AV), 9kHz
Input Power	120Vac, 60Hz	Environmental Conditions	25°C, 65%RH
Tested by	Getaz Yang	Test Date	2017/10/19

Phase Of Power : Neutral (N)										
No	Frequency (MHz)	Correction Factor (dB)	Reading Value (dBuV)		Emission Level (dBuV)		Limit (dBuV)		Margin (dB)	
			Q.P.	AV.	Q.P.	AV.	Q.P.	AV.	Q.P.	AV.
1	0.49766	10.33	34.35	31.09	44.68	41.42	56.04	46.04	-11.36	-4.62
2	0.82969	10.33	35.22	21.95	45.55	32.28	56.00	46.00	-10.45	-13.72
3	1.48828	10.36	37.20	32.59	47.56	42.95	56.00	46.00	-8.44	-3.05
4	2.81250	10.49	35.24	28.84	45.73	39.33	56.00	46.00	-10.27	-6.67
5	3.80078	10.58	34.13	29.23	44.71	39.81	56.00	46.00	-11.29	-6.19
6	6.63672	10.56	10.41	12.30	20.97	22.86	60.00	50.00	-39.03	-27.14

Remarks:

1. Q.P. and AV. are abbreviations of quasi-peak and average individually.
2. The emission levels of other frequencies were very low against the limit.
3. Margin value = Emission level – Limit value
4. Correction factor = Insertion loss + Cable loss
5. Emission Level = Correction Factor + Reading Value

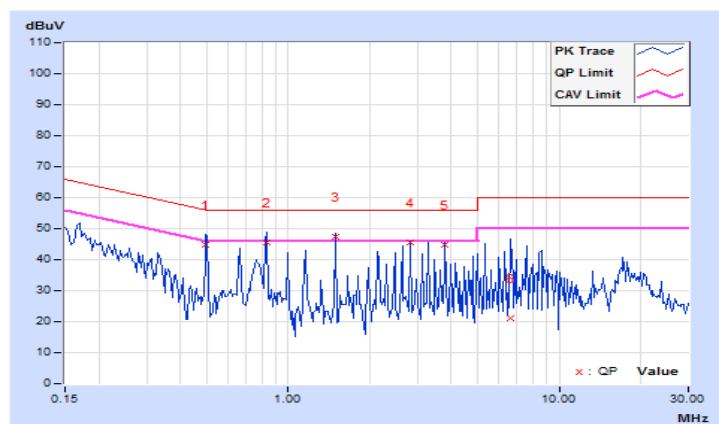

Mode B

Frequency Range	150kHz ~ 30MHz	Detector Function & Resolution Bandwidth	Quasi-Peak (QP) / Average (AV), 9kHz
Input Power	120Vac, 60Hz	Environmental Conditions	25°C, 65%RH
Tested by	Getaz Yang	Test Date	2017/10/19

Phase Of Power : Line (L)										
No	Frequency (MHz)	Correction Factor (dB)	Reading Value (dBuV)		Emission Level (dBuV)		Limit (dBuV)		Margin (dB)	
			Q.P.	AV.	Q.P.	AV.	Q.P.	AV.	Q.P.	AV.
1	0.49375	10.31	39.31	12.02	49.62	22.33	56.10	46.10	-6.48	-23.77
2	0.83359	10.38	39.69	32.52	50.07	42.90	56.00	46.00	-5.93	-3.10
3	1.49219	10.39	39.28	32.33	49.67	42.72	56.00	46.00	-6.33	-3.28
4	2.14063	10.38	9.19	3.99	19.57	14.37	56.00	46.00	-36.43	-31.63
5	3.45703	10.44	10.25	1.14	20.69	11.58	56.00	46.00	-35.31	-34.42
6	4.28125	10.48	10.28	33.14	20.76	43.62	56.00	46.00	-35.24	-2.38

Remarks:

1. Q.P. and AV. are abbreviations of quasi-peak and average individually.
2. The emission levels of other frequencies were very low against the limit.
3. Margin value = Emission level – Limit value
4. Correction factor = Insertion loss + Cable loss
5. Emission Level = Correction Factor + Reading Value

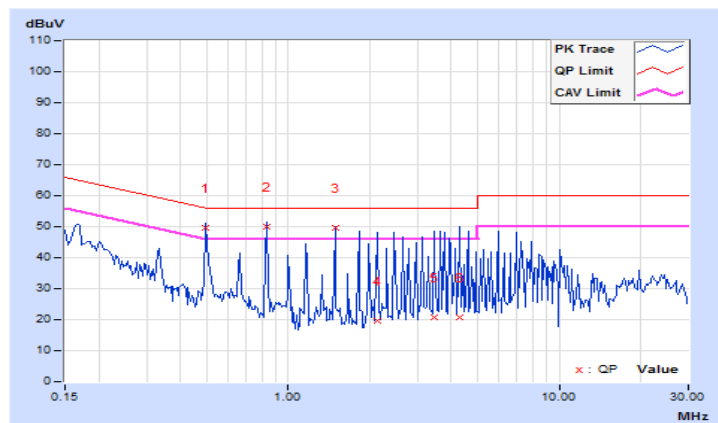

Frequency Range	150kHz ~ 30MHz	Detector Function & Resolution Bandwidth	Quasi-Peak (QP) / Average (AV), 9kHz
Input Power	120Vac, 60Hz	Environmental Conditions	25°C, 65%RH
Tested by	Getaz Yang	Test Date	2017/10/19

Phase Of Power : Neutral (N)										
No	Frequency (MHz)	Correction Factor (dB)	Reading Value (dBuV)		Emission Level (dBuV)		Limit (dBuV)		Margin (dB)	
			Q.P.	AV.	Q.P.	AV.	Q.P.	AV.	Q.P.	AV.
1	0.48984	10.33	14.25	9.56	24.58	19.89	56.17	46.17	-31.59	-26.28
2	0.82578	10.33	24.66	29.84	34.99	40.17	56.00	46.00	-21.01	-5.83
3	1.17188	10.34	20.42	1.30	30.76	11.64	56.00	46.00	-25.24	-34.36
4	1.50391	10.37	6.44	29.94	16.81	40.31	56.00	46.00	-39.19	-5.69
5	1.83984	10.40	34.85	31.80	45.25	42.20	56.00	46.00	-10.75	-3.80
6	4.33984	10.60	31.45	10.39	42.05	20.99	56.00	46.00	-13.95	-25.01

Remarks:

1. Q.P. and AV. are abbreviations of quasi-peak and average individually.
2. The emission levels of other frequencies were very low against the limit.
3. Margin value = Emission level – Limit value
4. Correction factor = Insertion loss + Cable loss
5. Emission Level = Correction Factor + Reading Value

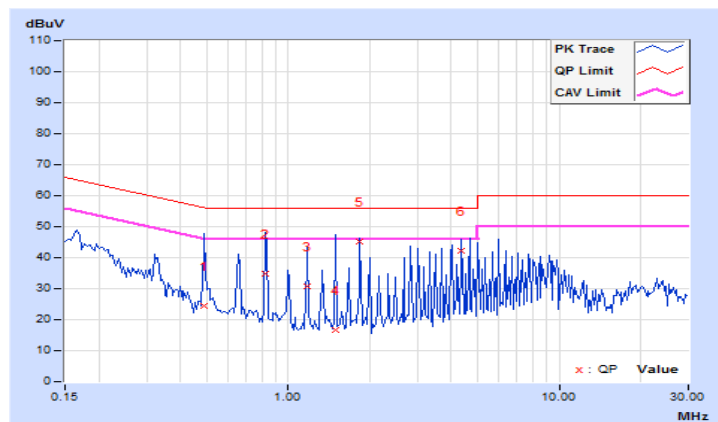

5 Pictures of Test Arrangements

Please refer to the attached file (Test Setup Photo).

Appendix – Information on the Testing Laboratories

We, Bureau Veritas Consumer Products Services (H.K.) Ltd., Taoyuan Branch, were founded in 1988 to provide our best service in EMC, Radio, Telecom and Safety consultation. Our laboratories are FCC recognized accredited test firms and accredited according to ISO/IEC 17025.

If you have any comments, please feel free to contact us at the following:

Linko EMC/RF Lab

Tel: 886-2-26052180

Fax: 886-2-26051924

Hsin Chu EMC/RF/Telecom Lab

Tel: 886-3-6668565

Fax: 886-3-6668323

Hwa Ya EMC/RF/Safety Lab

Tel: 886-3-3183232

Fax: 886-3-3270892

Email: service.adt@tw.bureauveritas.com

Web Site: www.bureauveritas-adt.com

The address and road map of all our labs can be found in our web site also.

--- END ---