

FCC Test Report

Report No.: RF170327C09-2

FCC ID: UK7-DW5A

Received Date: Mar. 27, 2017

Test Date: Apr. 05, 2017 ~ May 27, 2017

Issued Date: Jun. 14, 2017

Applicant: Fossil Group, Inc.

Address: 901 S. Central Expwy., Richardson, TX 75080 USA

Issued By: Bureau Veritas Consumer Products Services (H.K.) Ltd., Taoyuan Branch

Lab Address: No. 47-2, 14th Ling, Chia Pau Vil., Lin Kou Dist., New Taipei City, Taiwan
(R.O.C)

Test Location (1): No. 19, Hwa Ya 2nd Rd, Wen Hwa Tsuen, Kwei Shan Hsiang, Taoyuan
Hsien 333, Taiwan, R.O.C.



This report is for your exclusive use. Any copying or replication of this report to or for any other person or entity, or use of our name or trademark, is permitted only with our prior written permission. This report sets forth our findings solely with respect to the test samples identified herein. The results set forth in this report are not indicative or representative of the quality or characteristics of the lot from which a test sample was taken or any similar or identical product unless specifically and expressly noted. Our report includes all of the tests requested by you and the results thereof based upon the information that you provided to us. You have 60 days from date of issuance of this report to notify us of any material error or omission caused by our negligence, provided, however, that such notice shall be in writing and shall specifically address the issue you wish to raise. A failure to raise such issue within the prescribed time shall constitute your unqualified acceptance of the completeness of this report, the tests conducted and the correctness of the report contents. Unless specifically mentioned, the uncertainty of measurement has been explicitly taken into account to declare the compliance or non-compliance to the specification.

Table of Contents

Release Control Record	4
1 Certificate of Conformity	5
2 Summary of Test Results	6
2.1 Measurement Uncertainty	6
2.2 Modification Record	6
3 General Information	7
3.1 General Description of EUT	7
3.2 Description of Test Modes	8
3.2.1 Test Mode Applicability and Tested Channel Detail	9
3.3 Duty Cycle of Test Signal	11
3.4 Description of Support Units	12
3.4.1 Configuration of System under Test	12
3.5 General Description of Applied Standards	12
4 Test Types and Results	13
4.1 Radiated Emission and Bandedge Measurement	13
4.1.1 Limits of Radiated Emission and Bandedge Measurement	13
4.1.2 Test Instruments	14
4.1.3 Test Procedures	15
4.1.4 Deviation from Test Standard	15
4.1.5 Test Set Up	16
4.1.6 EUT Operating Conditions	16
4.1.7 Test Results	17
4.2 Conducted Emission Measurement	63
4.2.1 Limits of Conducted Emission Measurement	63
4.2.2 Test Instruments	63
4.2.3 Test Procedures	64
4.2.4 Deviation from Test Standard	64
4.2.5 Test Setup	64
4.2.6 EUT Operating Conditions	64
4.2.7 Test Results	65
4.3 6dB Bandwidth Measurement	71
4.3.1 Limits of 6dB Bandwidth Measurement	71
4.3.2 Test Setup	71
4.3.3 Test Instruments	71
4.3.4 Test Procedure	71
4.3.5 Deviation from Test Standard	71
4.3.6 EUT Operating Conditions	71
4.3.7 Test Result	72
4.4 Conducted Output Power Measurement	74
4.4.1 Limits of Conducted Output Power Measurement	74
4.4.2 Test Setup	74
4.4.3 Test Instruments	74
4.4.4 Test Procedures	74
4.4.5 Deviation from Test Standard	74
4.4.6 EUT Operating Conditions	74
4.4.7 Test Results	75
4.5 Power Spectral Density Measurement	76
4.5.1 Limits of Power Spectral Density Measurement	76
4.5.2 Test Setup	76
4.5.3 Test Instruments	76
4.5.4 Test Procedure	76
4.5.5 Deviation from Test Standard	76
4.5.6 EUT Operating Condition	76

4.5.7 Test Results	77
4.6 Conducted Out of Band Emission Measurement	79
4.6.1 Limits of Conducted Out of Band Emission Measurement.....	79
4.6.2 Test Setup.....	79
4.6.3 Test Instruments	79
4.6.4 Test Procedure	79
4.6.5 Deviation from Test Standard	79
4.6.6 EUT Operating Condition	79
4.6.7 Test Results	80
5 Pictures of Test Arrangements.....	89
Appendix – Information on the Testing Laboratories	90

Release Control Record

Issue No.	Description	Date Issued
RF170327C09-2	Original Release	Jun. 14, 2017

1 Certificate of Conformity

Product: Smart Watch

Sample Status: Production Unit

Applicant: Fossil Group, Inc.

Test Date: Apr. 05, 2017 ~ May 27, 2017

Standards: 47 CFR FCC Part 15, Subpart C (Section 15.247)
ANSI C63.10:2013

The above equipment has been tested by **Bureau Veritas Consumer Products Services (H.K.) Ltd., Taoyuan Branch**, and found compliance with the requirement of the above standards. The test record, data evaluation & Equipment Under Test (EUT) configurations represented herein are true and accurate accounts of the measurements of the sample's EMC characteristics under the conditions specified in this report.

Prepared by : , **Date:** Jun. 14, 2017
Ivonne Wu / Supervisor

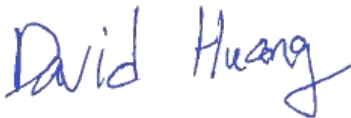
Approved by : , **Date:** Jun. 14, 2017
David Huang / Project Engineer

2 Summary of Test Results

47 CFR FCC Part 15, Subpart C (Section 15.247)			
FCC Clause	Test Item	Result	Remarks
15.207	AC Power Conducted Emission	Pass	Meet the requirement of limit. Minimum passing margin is -0.59 dB at 2.21000 MHz.
15.205 / 15.209 / 15.247(d)	Radiated Emissions and Band Edge Measurement	Pass	Meet the requirement of limit. Minimum passing margin is -2.27 dB at 32.91 MHz.
15.247(d)	Antenna Port Emission	Pass	Meet the requirement of limit.
15.247(a)(2)	6 dB Bandwidth	Pass	Meet the requirement of limit.
15.247(b)	Conducted power	Pass	Meet the requirement of limit.
15.247(e)	Power Spectral Density	Pass	Meet the requirement of limit.
15.203	Antenna Requirement	Pass	No antenna connector is used.

2.1 Measurement Uncertainty

Where relevant, the following measurement uncertainty levels have been estimated for tests performed on the EUT:

The listed uncertainties are the worst case uncertainty for the entire range of measurement. Please note that the uncertainty values are provided for informational purposes only and are not used in determining the PASS/FAIL results.

Measurement	Frequency	Expanded Uncertainty (k=2) (\pm)
Conducted Emissions at mains ports	150 kHz ~ 30 MHz	2.44 dB
Radiated Emissions up to 1 GHz	30 MHz ~ 200 MHz	2.93 dB
	200 MHz ~ 1000 MHz	2.95 dB
Radiated Emissions above 1 GHz	1 GHz ~ 18 GHz	2.26 dB
	18 GHz ~ 40 GHz	1.94 dB

2.2 Modification Record

There were no modifications required for compliance.

3 General Information

3.1 General Description of EUT

Product	Smart Watch
Status of EUT	Production Unit
Power Supply Rating	5.0 Vdc (from wireless charger) 3.8 Vdc (from battery)
Modulation Type	CCK, DQPSK, DBPSK for DSSS 64QAM, 16QAM, QPSK, BPSK for OFDM
Modulation Technology	DSSS, OFDM
Transfer Rate	802.11b: 11.0 / 5.5 / 2.0 / 1.0 Mbps 802.11g: 54.0 / 48.0 / 36.0 / 24.0 / 18.0 / 12.0 / 9.0 / 6.0 Mbps 802.11n: up to MCS7
Operating Frequency	2412 ~ 2472 MHz
Number of Channel	13 for 802.11b, 802.11g, 802.11n (HT20)
Output Power	74.473 mW
Antenna Type	Loop antenna
Antenna Connector	N/A
Accessory Device	Refer to Note as below
Data Cable Supplied	Refer to Note as below

Note:

- There're 3 configurations for the EUT listed as below.

Sample	Antenna Gain (dBi)	Difference
A	-4.85	The samples are different in the appearance and antenna only.
B	-3.75	
C	-2.55	

- The EUT's accessories list refers to Ext. Pho.

3.2 Description of Test Modes

11 channels are provided for 802.11b, 802.11g and 802.11n (HT20):

Channel	Frequency (MHz)	Channel	Frequency (MHz)
1	2412	8	2447
2	2417	9	2452
3	2422	10	2457
4	2427	11	2462
5	2432	12	2467
6	2437	13	2472
7	2442		

3.2.1 Test Mode Applicability and Tested Channel Detail

EUT Configure Mode	Applicable To				Description
	RE \geq 1G	RE<1G	PLC	APCM	
A	√	√	√	√	Sample C
B	√	√	√	-	Sample B
C	√	√	√	-	Sample A

Where **RE \geq 1G**: Radiated Emission above 1 GHz **RE<1G**: Radiated Emission below 1 GHz
PLC: Power Line Conducted Emission **APCM**: Antenna Port Conducted Measurement

NOTE: The EUT had been pre-tested on the positioned of each 3 axis. The worst case was found when positioned on **Z-plane**.
NOTE: “-” means no effect.

Radiated Emission Test (Above 1 GHz):

- Pre-Scan has been conducted to determine the worst-case mode from all possible combinations between available modulations, data rates and antenna ports (if EUT with antenna diversity architecture).
- Following channel(s) was (were) selected for the final test as listed below.

EUT Configure Mode	Mode	Available Channel	Tested Channel	Modulation Technology	Modulation Type	Data Rate (Mbps)
A	802.11b	1 to 13	1, 6, 11, 12, 13	DSSS	DBPSK	1.0
	802.11g	1 to 13	1, 6, 11, 12, 13	OFDM	BPSK	6.0
	802.11n (HT20)	1 to 13	1, 6, 11, 12, 13	OFDM	BPSK	MCS0
B, C	802.11n (HT20)	1 to 13	13	OFDM	BPSK	MCS0

Radiated Emission Test (Below 1 GHz):

- Pre-Scan has been conducted to determine the worst-case mode from all possible combinations between available modulations, data rates and antenna ports (if EUT with antenna diversity architecture).
- Following channel(s) was (were) selected for the final test as listed below.

EUT Configure Mode	Mode	Available Channel	Tested Channel	Modulation Technology	Modulation Type	Data Rate (Mbps)
A, B, C	802.11n (HT20)	1 to 13	13	OFDM	BPSK	MCS0

Power Line Conducted Emission Test:

- Pre-Scan has been conducted to determine the worst-case mode from all possible combinations between available modulations, data rates and antenna ports (if EUT with antenna diversity architecture).
- Following channel(s) was (were) selected for the final test as listed below.

EUT Configure Mode	Mode	Available Channel	Tested Channel	Modulation Technology	Modulation Type	Data Rate (Mbps)
A, B, C	802.11n (HT20)	1 to 13	13	OFDM	BPSK	MCS0

Bandedge Measurement:

- Pre-Scan has been conducted to determine the worst-case mode from all possible combinations between available modulations, data rates and antenna ports (if EUT with antenna diversity architecture).
- Following channel(s) was (were) selected for the final test as listed below.

EUT Configure Mode	Mode	Available Channel	Tested Channel	Modulation Technology	Modulation Type	Data Rate (Mbps)
A	802.11b	1 to 13	1, 6, 11, 12, 13	DSSS	DBPSK	1.0
	802.11g	1 to 13	1, 6, 11, 12, 13	OFDM	BPSK	6.0
	802.11n (HT20)	1 to 13	1, 6, 11, 12, 13	OFDM	BPSK	MCS0

Antenna Port Conducted Measurement:

- This item includes all test value of each mode, but only includes spectrum plot of worst value of each mode.
- Pre-Scan has been conducted to determine the worst-case mode from all possible combinations between available modulations, data rates and antenna ports (if EUT with antenna diversity architecture).
- Following channel(s) was (were) selected for the final test as listed below.

EUT Configure Mode	Mode	Available Channel	Tested Channel	Modulation Technology	Modulation Type	Data Rate (Mbps)
A	802.11b	1 to 13	1, 6, 11, 12, 13	DSSS	DBPSK	1.0
	802.11g	1 to 13	1, 6, 11, 12, 13	OFDM	BPSK	6.0
	802.11n (HT20)	1 to 13	1, 6, 11, 12, 13	OFDM	BPSK	MCS0

Test Condition:

Applicable To	Environmental Conditions	Input Power	Tested by
RE≥1G	25 deg. C, 65 % RH	5 Vdc	Getaz Yang
RE<1G	25 deg. C, 65 % RH	5 Vdc	Getaz Yang
PLC	25 deg. C, 65 % RH	5 Vdc	Getaz Yang
APCM	25 deg. C, 65 % RH	3.8 Vdc	Wayne Lin

3.3 Duty Cycle of Test Signal

802.11b: Duty cycle of test signal is 100 %

802.11g: Duty cycle = $1.367/1.558 = 0.877$, Duty factor = $10 * \log(1/0.877) = 0.57$

802.11n (HT20): Duty cycle = $1.258/1.475 = 0.853$, Duty factor = $10 * \log(1/0.853) = 0.69$

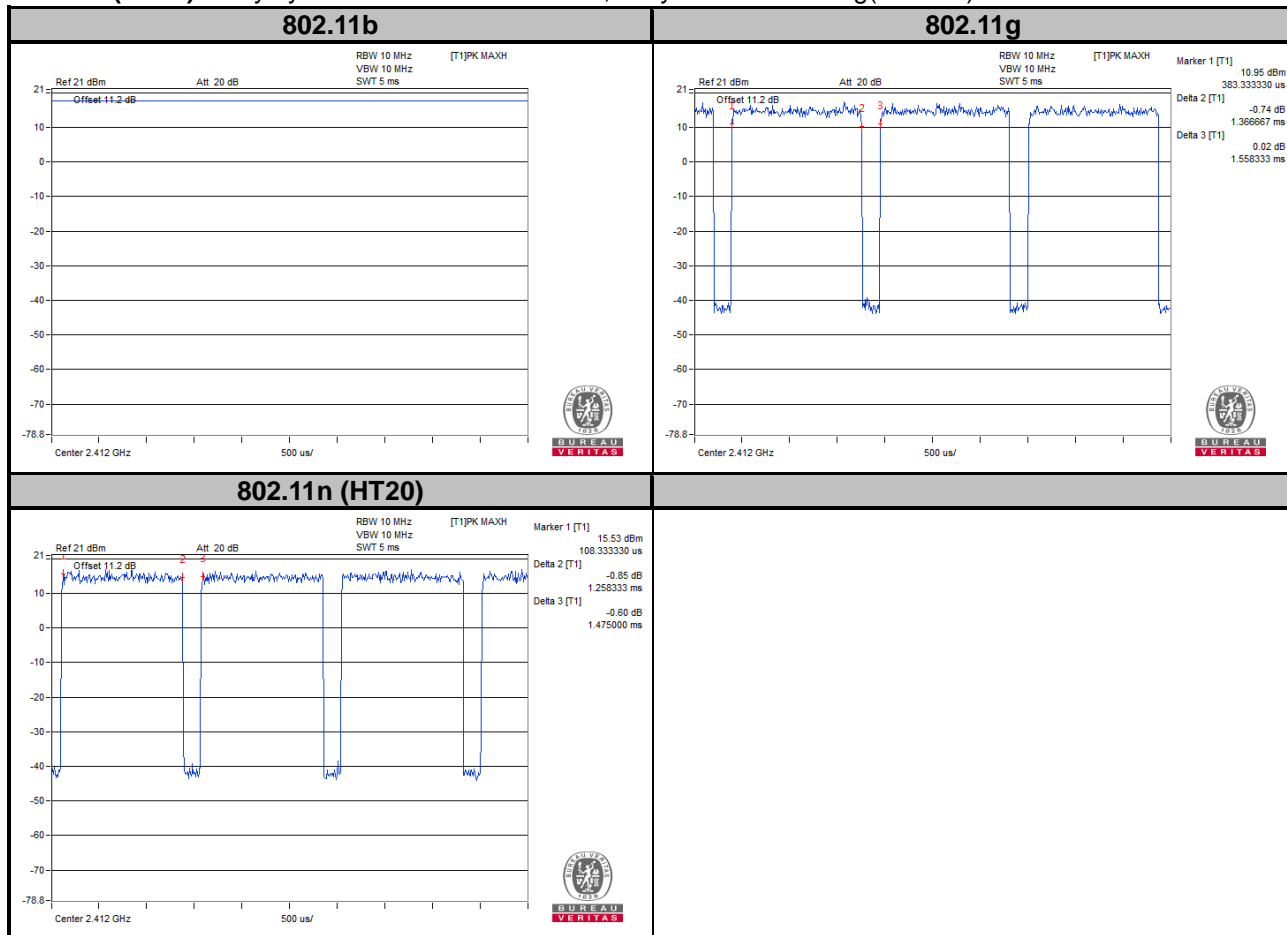

3.4 Description of Support Units

The EUT has been tested as an independent unit together with other necessary accessories or support units. The following support units or accessories were used to form a representative test configuration during the tests.

No.	Product	Brand	Model No.	Serial No.	FCC ID
1.	Adapter	XIAOMI	MDY-08-EF	N/A	N/A

No.	Signal Cable Description Of The Above Support Units
1.	N/A

Note:

1. All power cords of the above support units are non-shielded (1.8m).

3.4.1 Configuration of System under Test

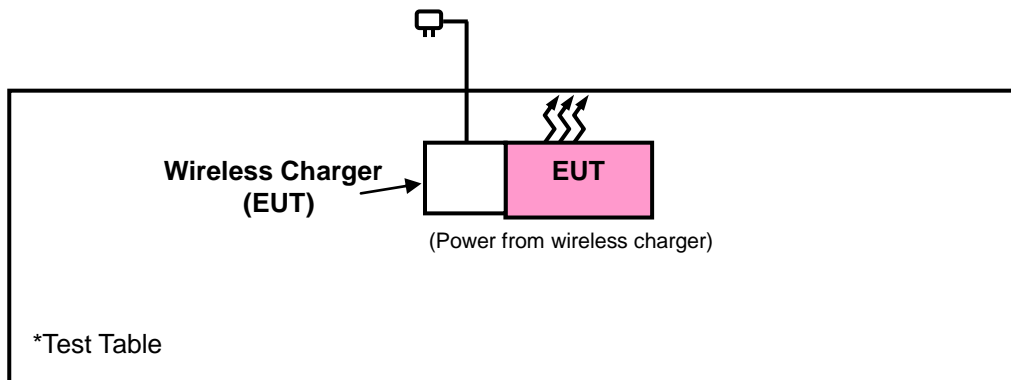

3.5 General Description of Applied Standards

The EUT is a RF Product. According to the specifications of the manufacturer, it must comply with the requirements of the following standards:

FCC Part 15, Subpart C (15.247)
558074 D01 DTS Meas Guidance v04
 ANSI C63.10-2013

All test items have been performed and recorded as per the above standards.

Note: The EUT has been verified to comply with the requirements of FCC Part 15, Subpart B, Class B (Verification). The test report has been issued separately.

4 Test Types and Results

4.1 Radiated Emission and Bandedge Measurement

4.1.1 Limits of Radiated Emission and Bandedge Measurement

Radiated emissions which fall in the restricted bands must comply with the radiated emission limits specified as below table. Other emissions shall be at least 20 dB below the highest level of the desired power:

Frequencies (MHz)	Field Strength (microvolts/meter)	Measurement Distance (meters)
0.009 ~ 0.490	2400/F (kHz)	300
0.490 ~ 1.705	24000/F (kHz)	30
1.705 ~ 30.0	30	30
30 ~ 88	100	3
88 ~ 216	150	3
216 ~ 960	200	3
Above 960	500	3

NOTE:

1. The lower limit shall apply at the transition frequencies.
2. Emission level (dBuV/m) = 20 log Emission level (uV/m).
3. For frequencies above 1000 MHz, the field strength limits are based on average detector, however, the peak field strength of any emission shall not exceed the maximum permitted average limits, specified above by more than 20 dB under any condition of modulation.

4.1.2 Test Instruments

Description & Manufacturer	Model No.	Serial No.	Date of Calibration	Due Date of Calibration
Test Receiver Agilent	N9038A	MY51210203	Feb. 17, 2017	Feb. 16, 2018
Spectrum Analyzer Agilent	N9010A	MY52220314	Dec. 16, 2016	Dec. 15, 2017
Spectrum Analyzer ROHDE & SCHWARZ	FSU43	101261	Dec. 13, 2016	Dec. 12, 2017
BILOG Antenna SCHWARZBECK	VULB9168	9168-472	Dec. 26, 2016	Dec. 27, 2017
HORN Antenna SCHWARZBECK	BBHA 9120 D	9120D-969	Dec. 12, 2016	Dec. 13, 2017
HORN Antenna SCHWARZBECK	BBHA 9170	9170-480	Dec. 14, 2016	Dec. 13, 2017
Fixed Attenuator Mini-Circuits	BW-N10W5+	NA	Jul. 08, 2016	Jul. 07, 2017
Loop Antenna	EM-6879	269	Aug. 11, 2016	Aug. 10, 2017
Bluetooth Tester	CBT	100946	Jul. 29, 2016	Jul. 28, 2018
Preamplifier EMCI	EMC 012645	980115	Oct. 21, 2016	Oct. 20, 2017
Preamplifier EMCI	EMC 184045	980116	Oct. 21, 2016	Oct. 20, 2017
Preamplifier EMCI	EMC 330H	980112	Oct. 21, 2016	Oct. 20, 2017
Power Meter Anritsu	ML2495A	1232002	Sep. 08, 2016	Sep. 07, 2017
Power Sensor Anritsu	MA2411B	1207325	Sep. 08, 2016	Sep. 07, 2017
RF signal cable HUBER+SUHNNER	SUCOFLEX 104	309219/4 2950114	Oct. 21, 2016	Oct. 20, 2017
RF signal cable HUBER+SUHNNER	SUCOFLEX 104	250130/4	Oct. 21, 2016	Oct. 20, 2017
RF Coaxial Cable Worken	8D-FB	Cable-Ch10-01	Oct. 21, 2016	Oct. 20, 2017
Software BV ADT	E3 6.120103	NA	NA	NA
Antenna Tower MF	MFA-440H	NA	NA	NA
Turn Table MF	MFT-201SS	NA	NA	NA
Antenna Tower & Turn Table Controller MF	MF-7802	NA	NA	NA

- Note: 1. The calibration interval of the above test instruments is 12 months and the calibrations are traceable to NML/ROC and NIST/USA.
2. The test was performed in HwaYa Chamber 10.
3. The horn antenna and preamplifier (model: EMC 184045) are used only for the measurement of emission frequency above 1 GHz if tested.
4. The FCC Site Registration No. is 690701.
5. The IC Site Registration No. is IC7450F-10.

4.1.3 Test Procedures

- a. The EUT was placed on the top of a rotating table 0.8 meters (for below 1 GHz) / 1.5 meters (for above 1 GHz) above the ground at 3 meter chamber room for test. The table was rotated 360 degrees to determine the position of the highest radiation.
- b. The EUT was set 3 meters away from the interference-receiving antenna, which was mounted on the top of a variable-height antenna tower.
- c. The height of antenna is varied from one meter to four meters above the ground to determine the maximum value of the field strength. Both horizontal and vertical polarizations of the antenna are set to make the measurement.
- d. For each suspected emission, the EUT was arranged to its worst case and then the antenna was tuned to heights from 1 meter to 4 meters and the rotatable table was turned from 0 degrees to 360 degrees to find the maximum reading.
- e. The test-receiver system was set to quasi-peak detect function and specified bandwidth with maximum hold mode when the test frequency is below 1 GHz.
- f. The test-receiver system was set to peak and average detected function and specified bandwidth with maximum hold mode when the test frequency is above 1 GHz. If the peak reading value also meets average limit, measurement with the average detector is unnecessary.

Note:

1. The resolution bandwidth and video bandwidth of test receiver/spectrum analyzer is 120 kHz & 360 KHz for Quasi-peak detection (QP) at frequency below 1 GHz.
2. The resolution bandwidth of test receiver/spectrum analyzer is 1 MHz and the video bandwidth is 3 MHz for Peak detection (PK) at frequency above 1 GHz.
3. The resolution bandwidth of test receiver/spectrum analyzer is 1 MHz and the video bandwidth is 1/T for Average (Duty cycle < 98 %) detection at frequency above 1 GHz.
4. The resolution bandwidth of test receiver/spectrum analyzer is 1 MHz and the video bandwidth is 10 Hz (Duty cycle \geq 98 %) for Average detection (AV) at frequency above 1 GHz.
5. All modes of operation were investigated and the worst-case emissions are reported.

4.1.4 Deviation from Test Standard

No deviation.

4.1.5 Test Set Up

<Frequency Range below 1 GHz>

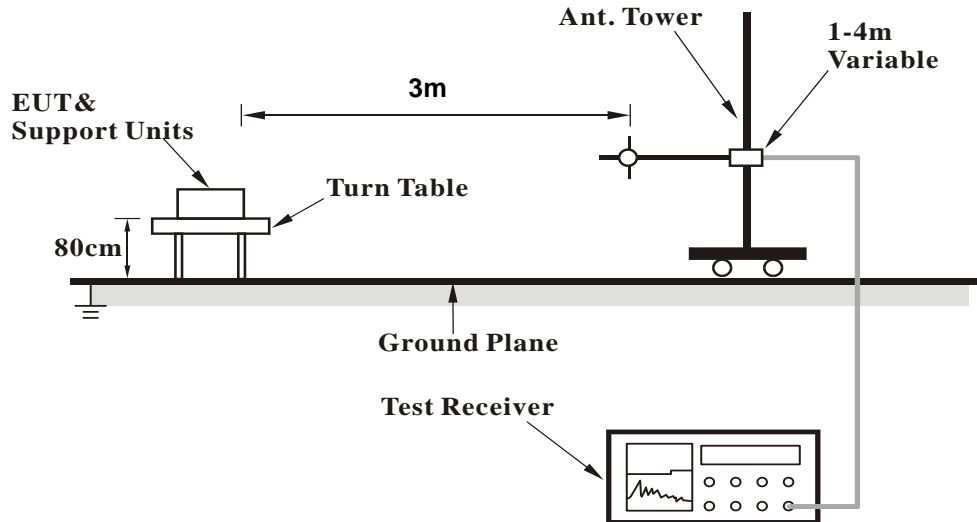

<Frequency Range above 1 GHz>

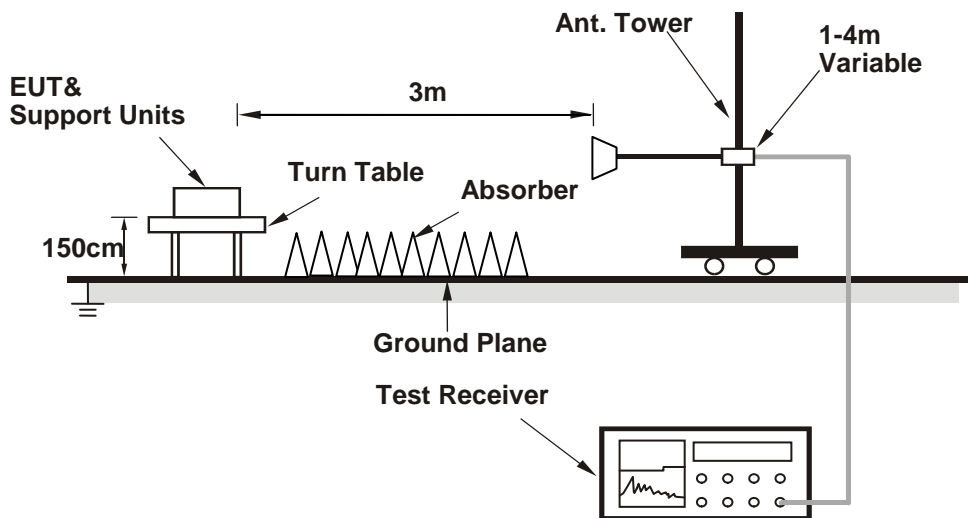

For the actual test configuration, please refer to the attached file (Test Setup Photo).

4.1.6 EUT Operating Conditions

- Placed the EUT on a testing table.
- Use the software to control the EUT under transmission condition continuously at specific channel frequency.

4.1.7 Test Results

Above 1 GHz Data :

Mode A

802.11b

EUT Test Condition		Measurement Detail	
Channel	Channel 1	Frequency Range	1 GHz ~ 25 GHz
Input Power	120 Vac, 60 Hz	Detector Function	Peak (PK) Average (AV)
Environmental Conditions	25 deg. C, 65 % RH	Tested By	Getaz Yang

Horizontal

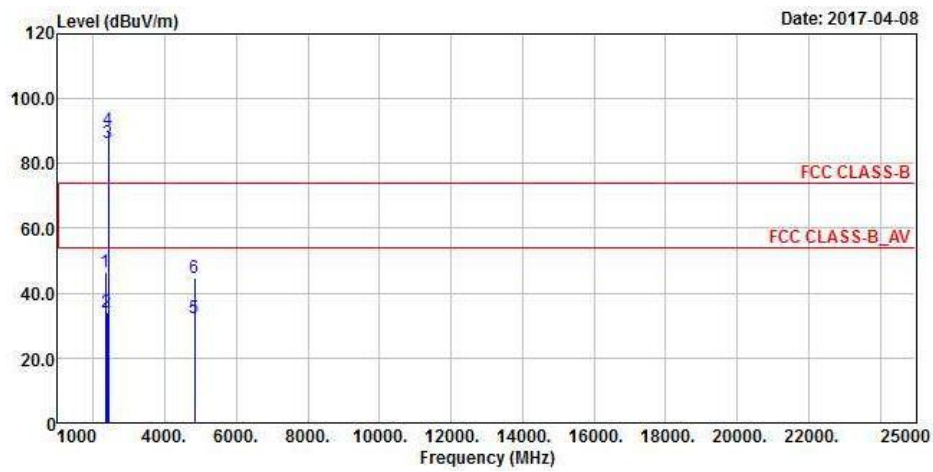

Vertical

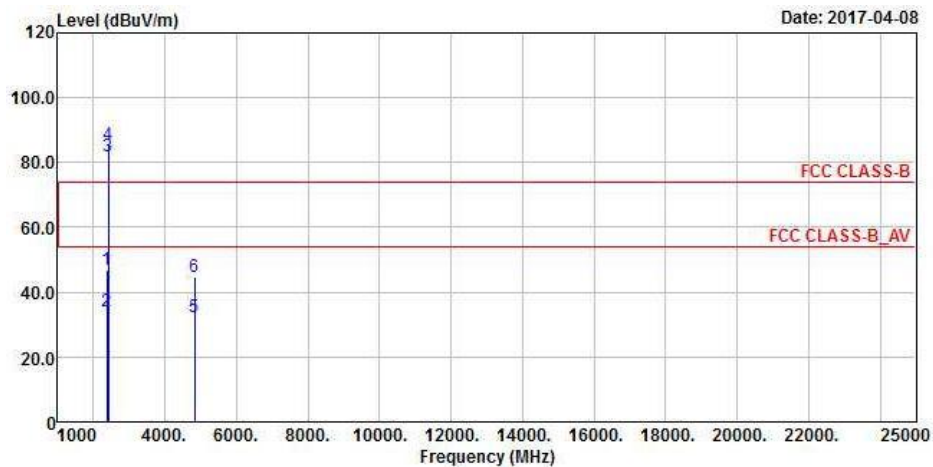

Antennal Polarity & Test Distance: Horizontal at 3 m

Frequency (MHz)	Emission Level (dBuV/m)	Read Level (dBuV)	Limit (dBuV/m)	Margin (dB)	Antenna Factor (dB/m)	Cable Loss (dB)	Preamp Factor (dB)	Antenna Height (cm)	Table Angle (Degree)	Remark
2336.55	46.7	53.36	74	-27.3	26.77	4.04	37.47	208	224	Peak
2365.35	34.2	40.82	54	-19.8	26.81	4.07	37.5	208	224	Average
2412	86.14	92.61			26.96	4.09	37.52	208	224	Average
2412	90.13	96.6			26.96	4.09	37.52	208	224	Peak
4824	32.49	47.79	54	-21.51	30.99	6.79	53.08	186	105	Average
4824	44.61	59.91	74	-29.39	30.99	6.79	53.08	186	105	Peak

Antennal Polarity & Test Distance: Vertical at 3 m

Frequency (MHz)	Emission Level (dBuV/m)	Read Level (dBuV)	Limit (dBuV/m)	Margin (dB)	Antenna Factor (dB/m)	Cable Loss (dB)	Preamp Factor (dB)	Antenna Height (cm)	Table Angle (Degree)	Remark
2374.98	46.88	53.45	74	-27.12	26.86	4.07	37.5	202	103	Peak
2379.93	34.24	40.8	54	-19.76	26.86	4.08	37.5	202	103	Average
2412	81.76	88.23			26.96	4.09	37.52	202	103	Average
2412	85.64	92.11			26.96	4.09	37.52	202	103	Peak
4824	32.29	47.59	54	-21.71	30.99	6.79	53.08	169	223	Average
4824	44.54	59.84	74	-29.46	30.99	6.79	53.08	169	223	Peak

Remarks:

- Emission Level = Read Level + Antenna Factor + Cable Loss - Preamp Factor
Margin value = Emission level – Limit value
- 2412 MHz: Fundamental frequency.

EUT Test Condition		Measurement Detail	
Channel	Channel 6	Frequency Range	1 GHz ~ 25 GHz
Input Power	120 Vac, 60 Hz	Detector Function	Peak (PK) Average (AV)
Environmental Conditions	25 deg. C, 65 % RH	Tested By	Getaz Yang

Horizontal

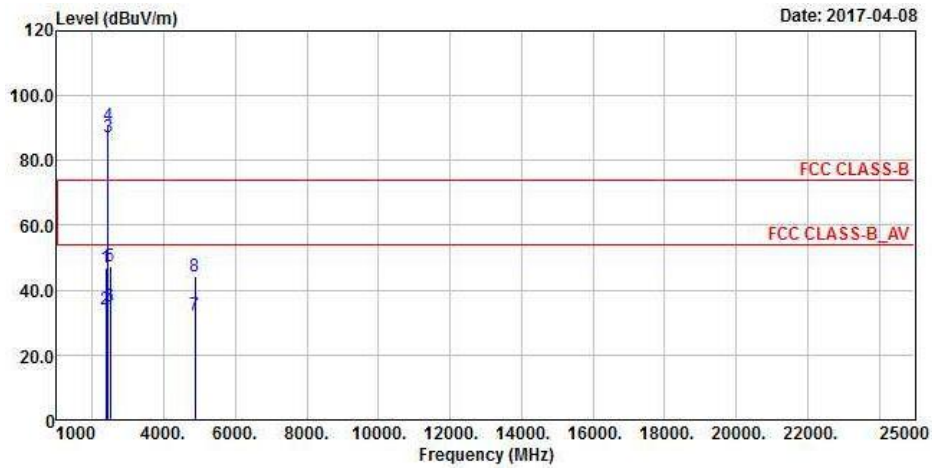

Vertical

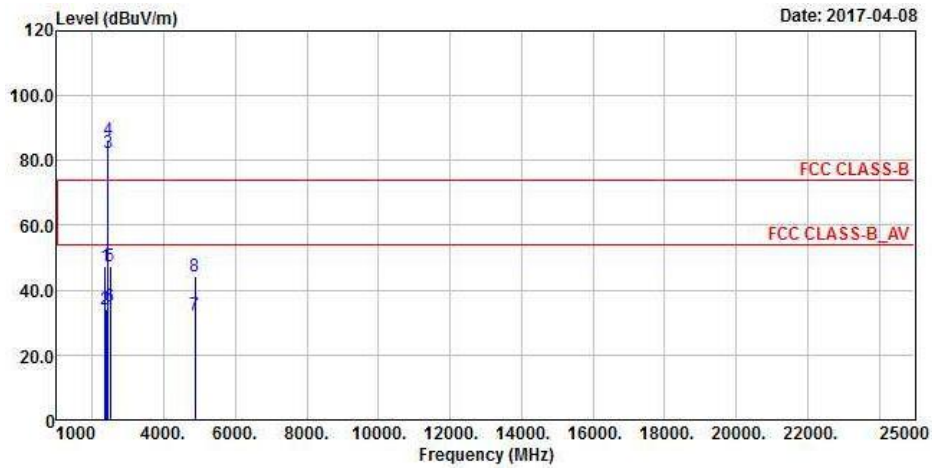

Antennal Polarity & Test Distance: Horizontal at 3 m

Frequency (MHz)	Emission Level (dBuV/m)	Read Level (dBuV)	Limit (dBuV/m)	Margin (dB)	Antenna Factor (dB/m)	Cable Loss (dB)	Preamp Factor (dB)	Antenna Height (cm)	Table Angle (Degree)	Remark
2371.74	46.91	53.48	74	-27.09	26.86	4.07	37.5	208	188	Peak
2381.82	34.17	40.73	54	-19.83	26.86	4.08	37.5	208	188	Average
2437	87.16	55.98			27.06	4.12	0	208	188	Average
2437	90.96	59.78			27.06	4.12	0	208	188	Peak
2493.8	47.33	53.22	74	-26.67	27.2	4.16	37.25	208	188	Peak
2499.8	34.81	40.7	54	-19.19	27.2	4.16	37.25	208	188	Average
4874	32.54	47.68	54	-21.46	31.06	6.85	53.05	183	112	Average
4874	44.45	59.59	74	-29.55	31.06	6.85	53.05	183	112	Peak

Antennal Polarity & Test Distance: Vertical at 3 m

Frequency (MHz)	Emission Level (dBuV/m)	Read Level (dBuV)	Limit (dBuV/m)	Margin (dB)	Antenna Factor (dB/m)	Cable Loss (dB)	Preamp Factor (dB)	Antenna Height (cm)	Table Angle (Degree)	Remark
2345.01	47.22	53.89	74	-26.78	26.77	4.05	37.49	202	107	Peak
2376.87	34.27	40.84	54	-19.73	26.86	4.07	37.5	202	107	Average
2437	82.31	88.59			27.06	4.12	37.46	202	107	Average
2437	86.17	92.45			27.06	4.12	37.46	202	107	Peak
2495.88	47.35	53.24	74	-26.65	27.2	4.16	37.25	202	107	Peak
2495.92	34.85	40.74	54	-19.15	27.2	4.16	37.25	202	107	Average
4874	32.24	47.38	54	-21.76	31.06	6.85	53.05	175	252	Average
4874	44.37	59.51	74	-29.63	31.06	6.85	53.05	175	252	Peak

Remarks:

- Emission Level = Read Level + Antenna Factor + Cable Loss - Preamp Factor
Margin value = Emission level – Limit value
- 2437 MHz: Fundamental frequency.

EUT Test Condition		Measurement Detail	
Channel	Channel 11	Frequency Range	1 GHz ~ 25 GHz
Input Power	120 Vac, 60 Hz	Detector Function	Peak (PK) Average (AV)
Environmental Conditions	25 deg. C, 65 % RH	Tested By	Getaz Yang

Horizontal

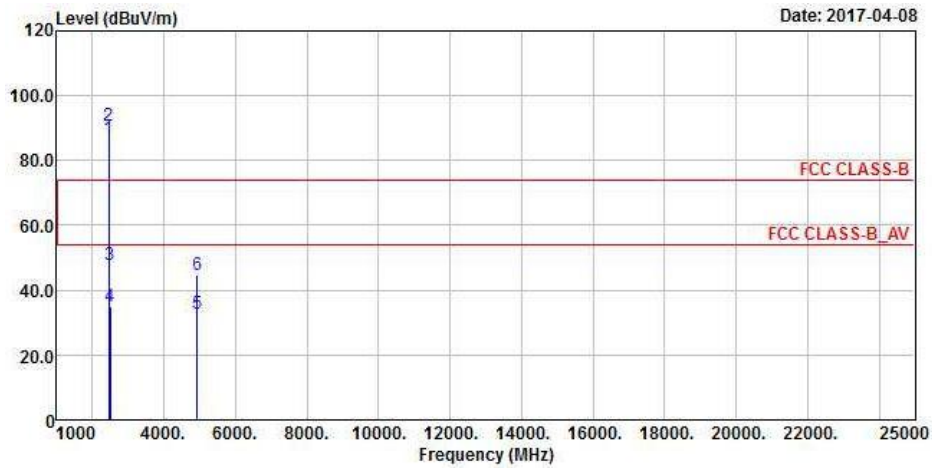

Vertical

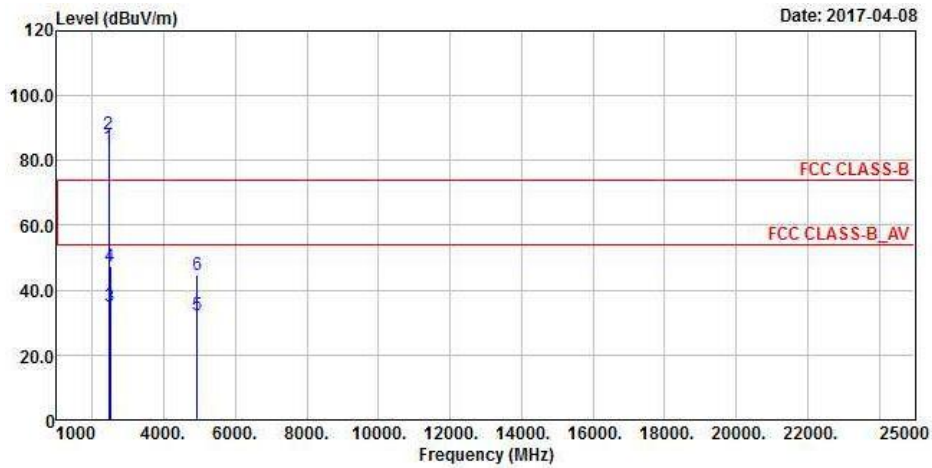

Antennal Polarity & Test Distance: Horizontal at 3 m

Frequency (MHz)	Emission Level (dBuV/m)	Read Level (dBuV)	Limit (dBuV/m)	Margin (dB)	Antenna Factor (dB/m)	Cable Loss (dB)	Preamp Factor (dB)	Antenna Height (cm)	Table Angle (Degree)	Remark
2462	86.77	92.93			27.1	4.13	37.39	208	206	Average
2462	90.6	96.76			27.1	4.13	37.39	208	206	Peak
2483.92	47.8	53.82	74	-26.2	27.15	4.15	37.32	208	206	Peak
2485.04	34.88	40.9	54	-19.12	27.15	4.15	37.32	208	206	Average
4924	32.56	47.59	54	-21.44	31.12	6.88	53.03	201	99	Average
4924	44.57	59.6	74	-29.43	31.12	6.88	53.03	201	99	Peak

Antennal Polarity & Test Distance: Vertical at 3 m

Frequency (MHz)	Emission Level (dBuV/m)	Read Level (dBuV)	Limit (dBuV/m)	Margin (dB)	Antenna Factor (dB/m)	Cable Loss (dB)	Preamp Factor (dB)	Antenna Height (cm)	Table Angle (Degree)	Remark
2462	84.13	90.29			27.1	4.13	37.39	202	106	Average
2462	87.95	94.11			27.1	4.13	37.39	202	106	Peak
2496.16	34.86	40.75	54	-19.14	27.2	4.16	37.25	202	106	Average
2498.52	47.53	53.42	74	-26.47	27.2	4.16	37.25	202	106	Peak
4924	32.33	47.36	54	-21.67	31.12	6.88	53.03	168	214	Average
4924	44.93	59.96	74	-29.07	31.12	6.88	53.03	168	214	Peak

Remarks:

- Emission Level = Read Level + Antenna Factor + Cable Loss - Preamp Factor
Margin value = Emission level – Limit value
- 2462 MHz: Fundamental frequency.

EUT Test Condition		Measurement Detail	
Channel	Channel 12	Frequency Range	1 GHz ~ 25 GHz
Input Power	120 Vac, 60 Hz	Detector Function	Peak (PK) Average (AV)
Environmental Conditions	25 deg. C, 65 % RH	Tested By	Getaz Yang

Horizontal

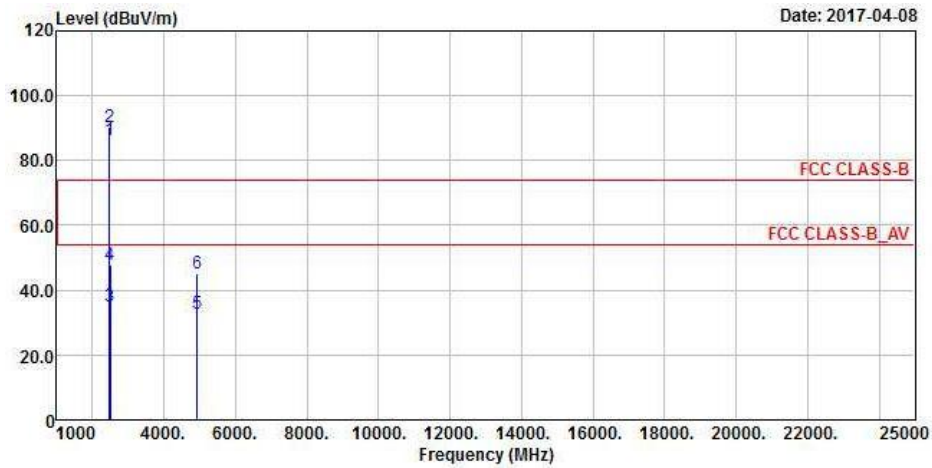

Vertical

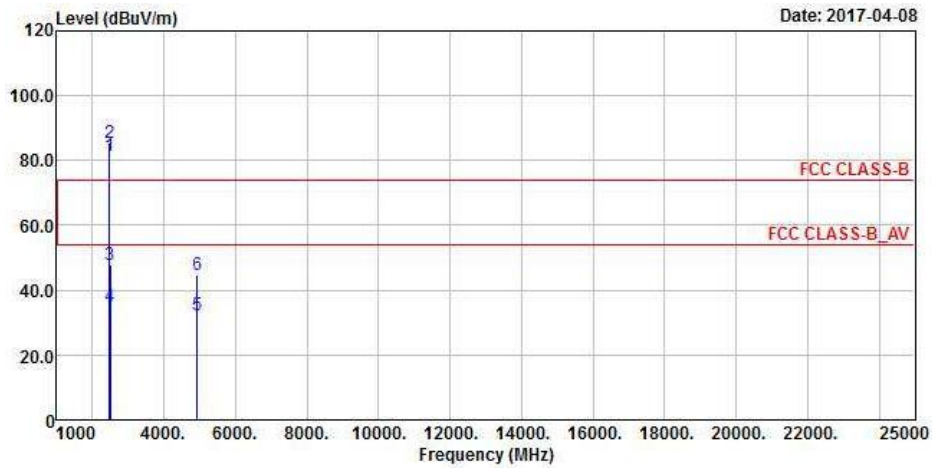

Antennal Polarity & Test Distance: Horizontal at 3 m

Frequency (MHz)	Emission Level (dBuV/m)	Read Level (dBuV)	Limit (dBuV/m)	Margin (dB)	Antenna Factor (dB/m)	Cable Loss (dB)	Preamp Factor (dB)	Antenna Height (cm)	Table Angle (Degree)	Remark
2467	86.43	55.2			27.1	4.13	0	208	177	Average
2467	90.29	59.06			27.1	4.13	0	208	177	Peak
2483.92	35.04	41.06	54	-18.96	27.15	4.15	37.32	208	177	Average
2494.56	47.62	53.51	74	-26.38	27.2	4.16	37.25	208	177	Peak
4934	32.62	47.65	54	-21.38	31.12	6.88	53.03	187	93	Average
4934	45.27	60.3	74	-28.73	31.12	6.88	53.03	187	93	Peak

Antennal Polarity & Test Distance: Vertical at 3 m

Frequency (MHz)	Emission Level (dBuV/m)	Read Level (dBuV)	Limit (dBuV/m)	Margin (dB)	Antenna Factor (dB/m)	Cable Loss (dB)	Preamp Factor (dB)	Antenna Height (cm)	Table Angle (Degree)	Remark
2467	81.46	87.55			27.1	4.13	37.32	202	104	Average
2467	85.32	91.41			27.1	4.13	37.32	202	104	Peak
2498.08	47.65	53.54	74	-26.35	27.2	4.16	37.25	202	104	Peak
2498.92	34.85	40.74	54	-19.15	27.2	4.16	37.25	202	104	Average
4934	32.3	47.33	54	-21.7	31.12	6.88	53.03	176	248	Average
4934	44.83	59.86	74	-29.17	31.12	6.88	53.03	176	248	Peak

Remarks:

- Emission Level = Read Level + Antenna Factor + Cable Loss - Preamp Factor
Margin value = Emission level – Limit value
- 2467 MHz: Fundamental frequency.

EUT Test Condition		Measurement Detail	
Channel	Channel 13	Frequency Range	1 GHz ~ 25 GHz
Input Power	120 Vac, 60 Hz	Detector Function	Peak (PK) Average (AV)
Environmental Conditions	25 deg. C, 65 % RH	Tested By	Getaz Yang

Horizontal

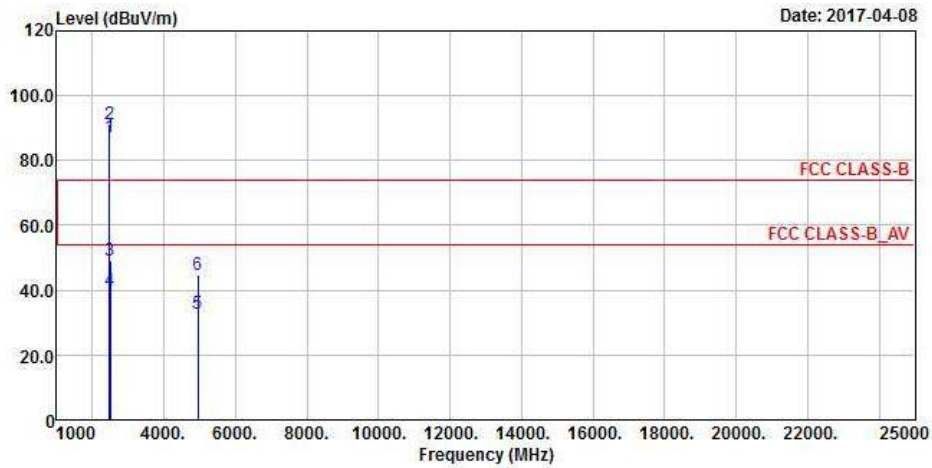

Vertical

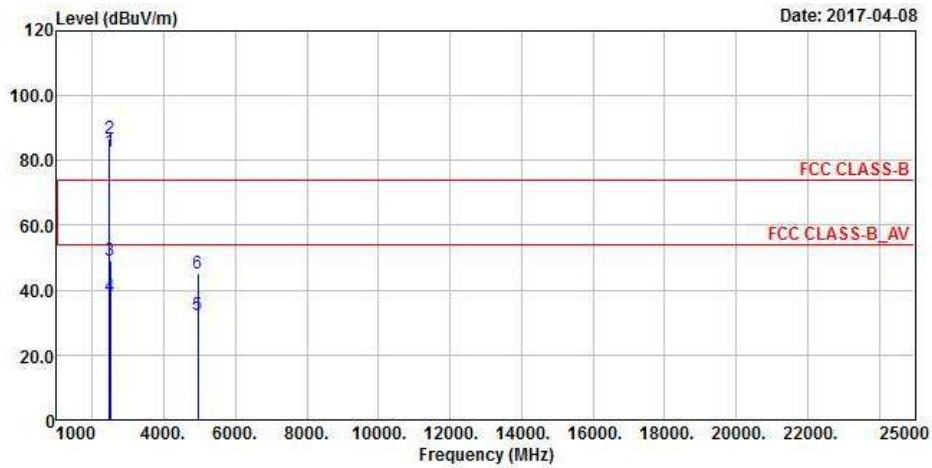

Antennal Polarity & Test Distance: Horizontal at 3 m

Frequency (MHz)	Emission Level (dBuV/m)	Read Level (dBuV)	Limit (dBuV/m)	Margin (dB)	Antenna Factor (dB/m)	Cable Loss (dB)	Preamp Factor (dB)	Antenna Height (cm)	Table Angle (Degree)	Remark
2472	87.12	93.14			27.15	4.15	37.32	208	196	Average
2472	91.04	97.06			27.15	4.15	37.32	208	196	Peak
2485.24	49.2	55.22	74	-24.8	27.15	4.15	37.32	208	196	Peak
2485.6	39.86	45.88	54	-14.14	27.15	4.15	37.32	208	196	Average
4944	32.68	47.67	54	-21.32	31.14	6.91	53.04	172	91	Average
4944	44.77	59.76	74	-29.23	31.14	6.91	53.04	172	91	Peak

Antennal Polarity & Test Distance: Vertical at 3 m

Frequency (MHz)	Emission Level (dBuV/m)	Read Level (dBuV)	Limit (dBuV/m)	Margin (dB)	Antenna Factor (dB/m)	Cable Loss (dB)	Preamp Factor (dB)	Antenna Height (cm)	Table Angle (Degree)	Remark
2472	82.95	88.97			27.15	4.15	37.32	202	105	Average
2472	86.72	92.74			27.15	4.15	37.32	202	105	Peak
2485.4	49.11	55.13	74	-24.89	27.15	4.15	37.32	202	105	Peak
2485.84	38.18	44.2	54	-15.82	27.15	4.15	37.32	202	105	Average
4944	32.46	47.45	54	-21.54	31.14	6.91	53.04	149	233	Average
4944	45.09	60.08	74	-28.91	31.14	6.91	53.04	149	233	Peak

Remarks:

- Emission Level = Read Level + Antenna Factor + Cable Loss - Preamp Factor
Margin value = Emission level – Limit value
- 2472 MHz: Fundamental frequency.

802.11g

EUT Test Condition		Measurement Detail	
Channel	Channel 1	Frequency Range	1 GHz ~ 25 GHz
Input Power	120 Vac, 60 Hz	Detector Function	Peak (PK) Average (AV)
Environmental Conditions	25 deg. C, 65 % RH	Tested By	Getaz Yang

Horizontal

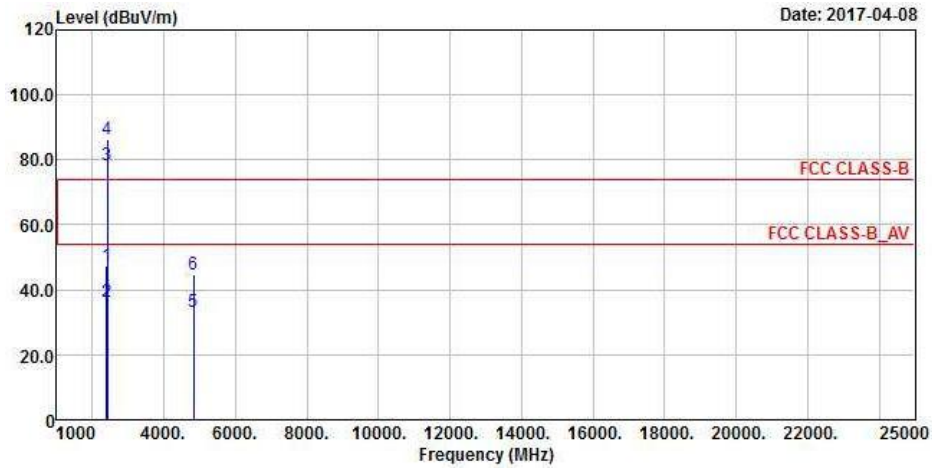

Vertical

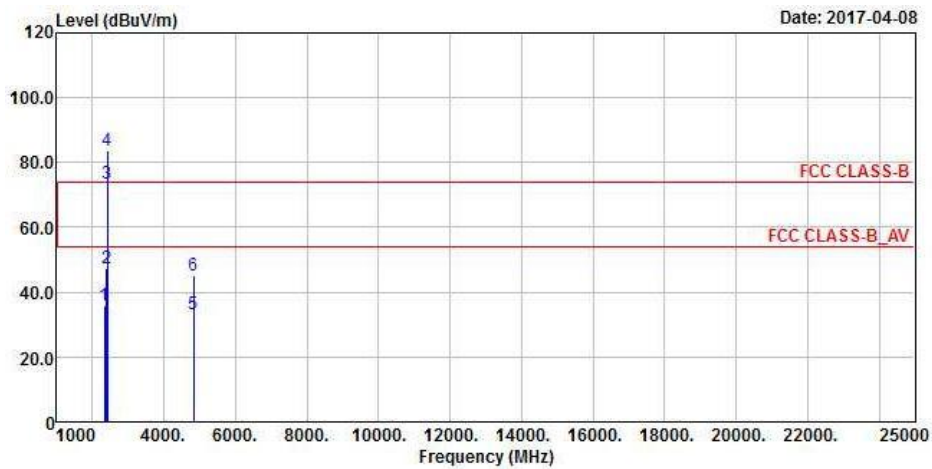

Antennal Polarity & Test Distance: Horizontal at 3 m

Frequency (MHz)	Emission Level (dBuV/m)	Read Level (dBuV)	Limit (dBuV/m)	Margin (dB)	Antenna Factor (dB/m)	Cable Loss (dB)	Preamp Factor (dB)	Antenna Height (cm)	Table Angle (Degree)	Remark
2384.97	47.48	54.04	74	-26.52	26.86	4.08	37.5	229	6	Peak
2386.68	36.11	42.62	54	-17.89	26.91	4.08	37.5	229	6	Average
2412	78.18	84.65			26.96	4.09	37.52	229	6	Average
2412	86.48	92.95			26.96	4.09	37.52	229	6	Peak
4824	33.43	48.73	54	-20.57	30.99	6.79	53.08	192	98	Average
4824	44.65	59.95	74	-29.35	30.99	6.79	53.08	192	98	Peak

Antennal Polarity & Test Distance: Vertical at 3 m

Frequency (MHz)	Emission Level (dBuV/m)	Read Level (dBuV)	Limit (dBuV/m)	Margin (dB)	Antenna Factor (dB/m)	Cable Loss (dB)	Preamp Factor (dB)	Antenna Height (cm)	Table Angle (Degree)	Remark
2339.07	35.74	42.42	54	-18.26	26.77	4.04	37.49	220	340	Average
2388.84	47.35	53.86	74	-26.65	26.91	4.08	37.5	220	340	Peak
2412	73.56	80.03			26.96	4.09	37.52	220	340	Average
2412	83.51	89.98			26.96	4.09	37.52	220	340	Peak
4824	33.22	48.52	54	-20.78	30.99	6.79	53.08	162	239	Average
4824	45.33	60.63	74	-28.67	30.99	6.79	53.08	162	239	Peak

Remarks:

- Emission Level = Read Level + Antenna Factor + Cable Loss - Preamp Factor
Margin value = Emission level – Limit value
- 2412 MHz: Fundamental frequency.

EUT Test Condition		Measurement Detail	
Channel	Channel 6	Frequency Range	1 GHz ~ 25 GHz
Input Power	120 Vac, 60 Hz	Detector Function	Peak (PK) Average (AV)
Environmental Conditions	25 deg. C, 65 % RH	Tested By	Getaz Yang

Horizontal

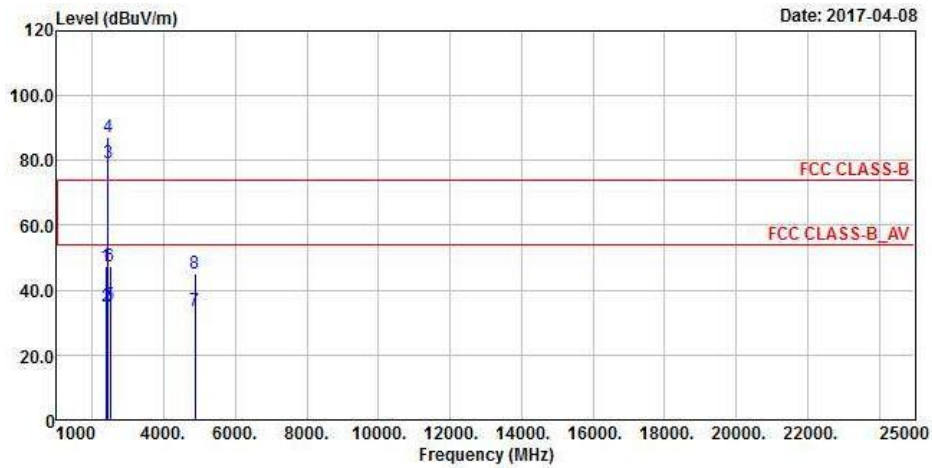

Vertical

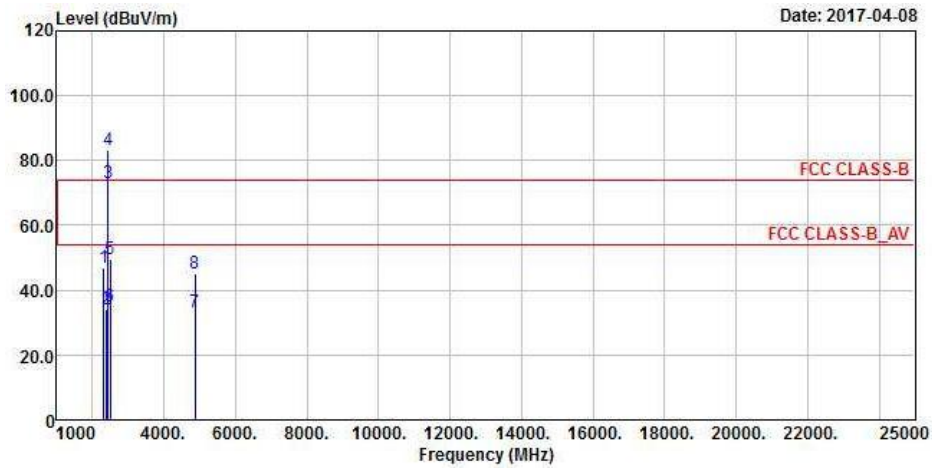

Antennal Polarity & Test Distance: Horizontal at 3 m

Frequency (MHz)	Emission Level (dBuV/m)	Read Level (dBuV)	Limit (dBuV/m)	Margin (dB)	Antenna Factor (dB/m)	Cable Loss (dB)	Preamp Factor (dB)	Antenna Height (cm)	Table Angle (Degree)	Remark
2376.69	47.2	53.77	74	-26.8	26.86	4.07	37.5	228	6	Peak
2385.06	34.84	41.4	54	-19.16	26.86	4.08	37.5	228	6	Average
2437	79.45	85.73			27.06	4.12	37.46	228	6	Average
2437	87.09	93.37			27.06	4.12	37.46	228	6	Peak
2489.4	35.48	41.44	54	-18.52	27.2	4.16	37.32	228	6	Average
2490.52	47.5	53.46	74	-26.5	27.2	4.16	37.32	228	6	Peak
4874	33.49	48.63	54	-20.51	31.06	6.85	53.05	185	96	Average
4874	45.15	60.29	74	-28.85	31.06	6.85	53.05	185	96	Peak

Antennal Polarity & Test Distance: Vertical at 3 m

Frequency (MHz)	Emission Level (dBuV/m)	Read Level (dBuV)	Limit (dBuV/m)	Margin (dB)	Antenna Factor (dB/m)	Cable Loss (dB)	Preamp Factor (dB)	Antenna Height (cm)	Table Angle (Degree)	Remark
2318.19	46.99	53.71	74	-27.01	26.72	4.03	37.47	218	341	Peak
2384.43	34.19	40.75	54	-19.81	26.86	4.08	37.5	218	341	Average
2437	73.23	79.51			27.06	4.12	37.46	218	341	Average
2437	83.05	89.33			27.06	4.12	37.46	218	341	Peak
2486.2	49.5	55.52	74	-24.5	27.15	4.15	37.32	218	341	Peak
2489.72	34.86	40.82	54	-19.14	27.2	4.16	37.32	218	341	Average
4874	33.24	48.38	54	-20.76	31.06	6.85	53.05	153	228	Average
4874	45.22	60.36	74	-28.78	31.06	6.85	53.05	153	228	Peak

Remarks:

- Emission Level = Read Level + Antenna Factor + Cable Loss - Preamp Factor
Margin value = Emission level – Limit value
- 2437 MHz: Fundamental frequency.

EUT Test Condition		Measurement Detail	
Channel	Channel 11	Frequency Range	1 GHz ~ 25 GHz
Input Power	120 Vac, 60 Hz	Detector Function	Peak (PK) Average (AV)
Environmental Conditions	25 deg. C, 65 % RH	Tested By	Getaz Yang

Horizontal

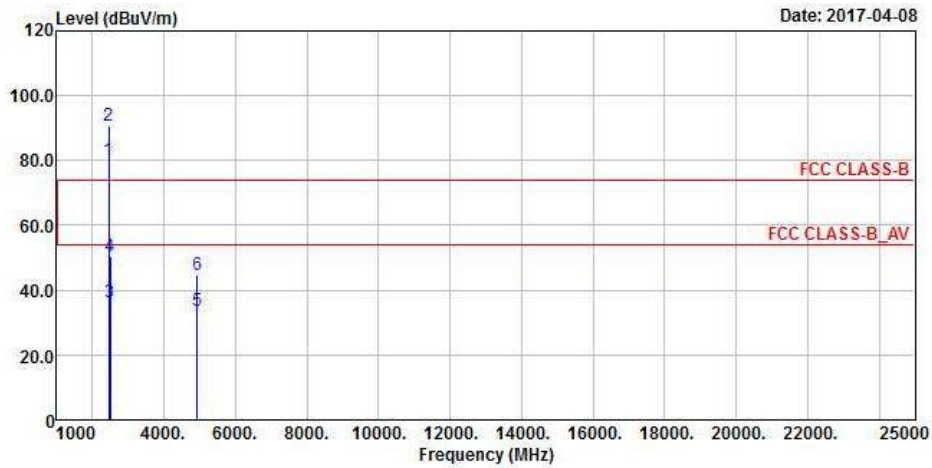

Vertical

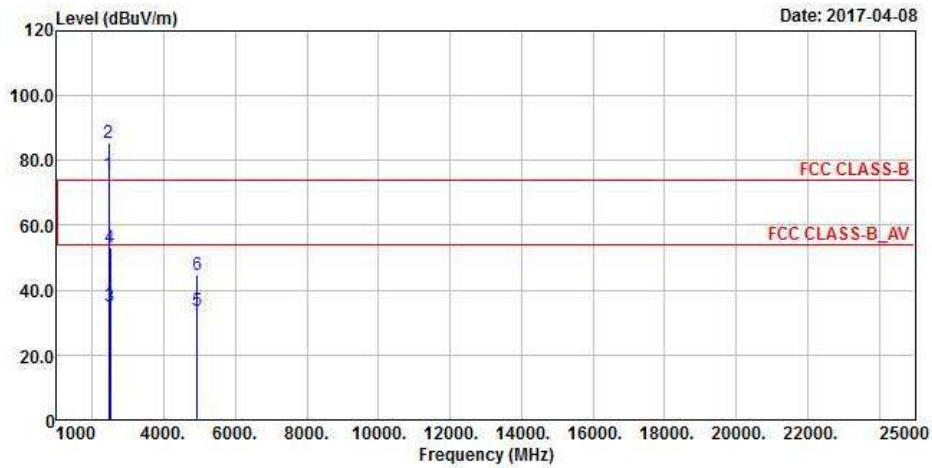

Antennal Polarity & Test Distance: Horizontal at 3 m

Frequency (MHz)	Emission Level (dBuV/m)	Read Level (dBuV)	Limit (dBuV/m)	Margin (dB)	Antenna Factor (dB/m)	Cable Loss (dB)	Preamp Factor (dB)	Antenna Height (cm)	Table Angle (Degree)	Remark
2462	80.26	86.42			27.1	4.13	37.39	223	4	Average
2462	90.99	97.15			27.1	4.13	37.39	223	4	Peak
2483.52	36.28	42.3	54	-17.72	27.15	4.15	37.32	223	4	Average
2484.32	50.51	56.53	74	-23.49	27.15	4.15	37.32	223	4	Peak
4924	33.78	48.81	54	-20.22	31.12	6.88	53.03	196	102	Average
4924	44.55	59.58	74	-29.45	31.12	6.88	53.03	196	102	Peak

Antennal Polarity & Test Distance: Vertical at 3 m

Frequency (MHz)	Emission Level (dBuV/m)	Read Level (dBuV)	Limit (dBuV/m)	Margin (dB)	Antenna Factor (dB/m)	Cable Loss (dB)	Preamp Factor (dB)	Antenna Height (cm)	Table Angle (Degree)	Remark
2462	75.78	81.94			27.1	4.13	37.39	216	340	Average
2462	85.6	91.76			27.1	4.13	37.39	216	340	Peak
2484	35.17	41.19	54	-18.83	27.15	4.15	37.32	216	340	Average
2485.32	53.09	59.11	74	-20.91	27.15	4.15	37.32	216	340	Peak
4924	33.45	48.48	54	-20.55	31.12	6.88	53.03	179	227	Average
4924	44.53	59.56	74	-29.47	31.12	6.88	53.03	179	227	Peak

Remarks:

- Emission Level = Read Level + Antenna Factor + Cable Loss - Preamp Factor
Margin value = Emission level – Limit value
- 2462 MHz: Fundamental frequency.

EUT Test Condition		Measurement Detail	
Channel	Channel 12	Frequency Range	1 GHz ~ 25 GHz
Input Power	120 Vac, 60 Hz	Detector Function	Peak (PK) Average (AV)
Environmental Conditions	25 deg. C, 65 % RH	Tested By	Getaz Yang

Horizontal

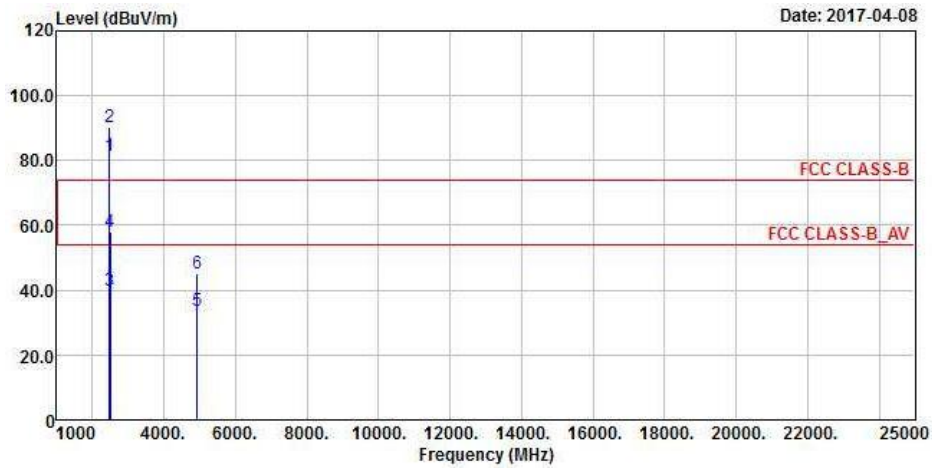

Vertical

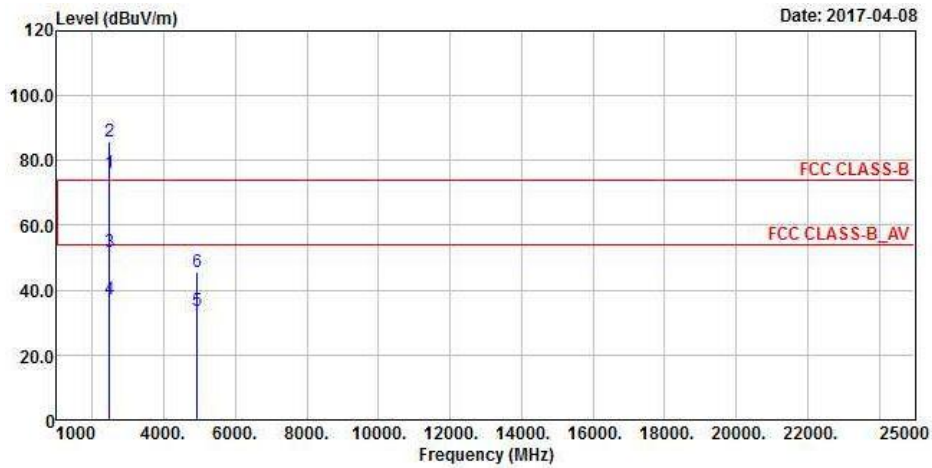

Antennal Polarity & Test Distance: Horizontal at 3 m

Frequency (MHz)	Emission Level (dBuV/m)	Read Level (dBuV)	Limit (dBuV/m)	Margin (dB)	Antenna Factor (dB/m)	Cable Loss (dB)	Preamp Factor (dB)	Antenna Height (cm)	Table Angle (Degree)	Remark
2467	81.58	87.67			27.1	4.13	37.32	224	4	Average
2467	90.54	96.63			27.1	4.13	37.32	224	4	Peak
2483.64	40.02	46.04	54	-13.98	27.15	4.15	37.32	224	4	Average
2484.76	57.97	63.99	74	-16.03	27.15	4.15	37.32	224	4	Peak
4934	33.76	48.79	54	-20.24	31.12	6.88	53.03	181	88	Average
4934	45.1	60.13	74	-28.9	31.12	6.88	53.03	181	88	Peak

Antennal Polarity & Test Distance: Vertical at 3 m

Frequency (MHz)	Emission Level (dBuV/m)	Read Level (dBuV)	Limit (dBuV/m)	Margin (dB)	Antenna Factor (dB/m)	Cable Loss (dB)	Preamp Factor (dB)	Antenna Height (cm)	Table Angle (Degree)	Remark
2467	76.22	82.31			27.1	4.13	37.32	217	339	Average
2467	86.07	92.16			27.1	4.13	37.32	217	339	Peak
2483.6	51.88	57.9	74	-22.12	27.15	4.15	37.32	217	339	Peak
2483.84	37.02	43.04	54	-16.98	27.15	4.15	37.32	217	339	Average
4934	33.55	48.58	54	-20.45	31.12	6.88	53.03	166	216	Average
4934	45.68	60.71	74	-28.32	31.12	6.88	53.03	166	216	Peak

Remarks:

- Emission Level = Read Level + Antenna Factor + Cable Loss - Preamp Factor
Margin value = Emission level – Limit value
- 2467 MHz: Fundamental frequency.

EUT Test Condition		Measurement Detail	
Channel	Channel 13	Frequency Range	1 GHz ~ 25 GHz
Input Power	120 Vac, 60 Hz	Detector Function	Peak (PK) Average (AV)
Environmental Conditions	25 deg. C, 65 % RH	Tested By	Getaz Yang

Horizontal

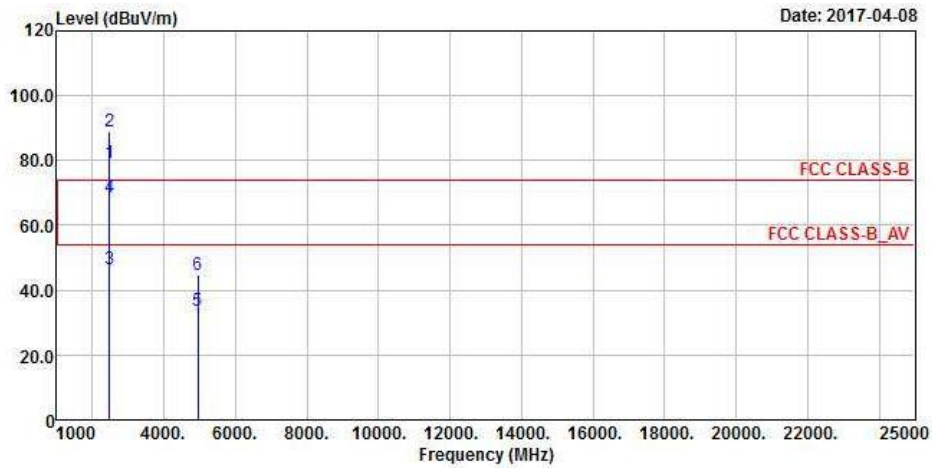

Vertical

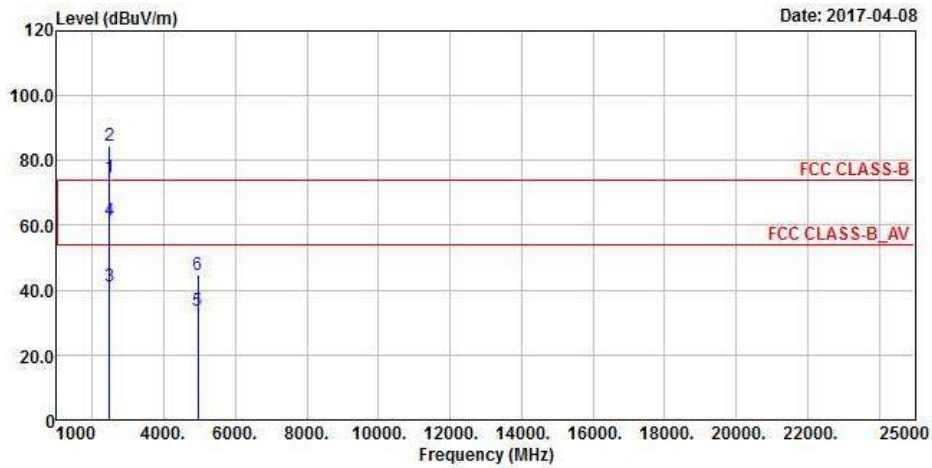

Antennal Polarity & Test Distance: Horizontal at 3 m

Frequency (MHz)	Emission Level (dBuV/m)	Read Level (dBuV)	Limit (dBuV/m)	Margin (dB)	Antenna Factor (dB/m)	Cable Loss (dB)	Preamp Factor (dB)	Antenna Height (cm)	Table Angle (Degree)	Remark
2472	79.13	85.15			27.15	4.15	37.32	224	4	Average
2472	89.11	95.13			27.15	4.15	37.32	224	4	Peak
2483.52	46.63	52.65	54	-7.37	27.15	4.15	37.32	224	4	Average
2483.52	68.73	74.75	74	-5.27	27.15	4.15	37.32	224	4	Peak
4944	33.77	48.76	54	-20.23	31.14	6.91	53.04	203	86	Average
4944	44.82	59.81	74	-29.18	31.14	6.91	53.04	203	86	Peak

Antennal Polarity & Test Distance: Vertical at 3 m

Frequency (MHz)	Emission Level (dBuV/m)	Read Level (dBuV)	Limit (dBuV/m)	Margin (dB)	Antenna Factor (dB/m)	Cable Loss (dB)	Preamp Factor (dB)	Antenna Height (cm)	Table Angle (Degree)	Remark
2472	75.02	81.04			27.15	4.15	37.32	216	338	Average
2472	84.58	90.6			27.15	4.15	37.32	216	338	Peak
2483.52	41.22	47.24	54	-12.78	27.15	4.15	37.32	216	338	Average
2483.6	61.64	67.66	74	-12.36	27.15	4.15	37.32	216	338	Peak
4944	33.49	48.48	54	-20.51	31.14	6.91	53.04	163	248	Average
4944	44.62	59.61	74	-29.38	31.14	6.91	53.04	163	248	Peak

Remarks:

- Emission Level = Read Level + Antenna Factor + Cable Loss - Preamp Factor
Margin value = Emission level – Limit value
- 2472 MHz: Fundamental frequency.

802.11n (HT20)

EUT Test Condition		Measurement Detail	
Channel	Channel 1	Frequency Range	1 GHz ~ 25 GHz
Input Power	120 Vac, 60 Hz	Detector Function	Peak (PK) Average (AV)
Environmental Conditions	25 deg. C, 65 % RH	Tested By	Getaz Yang

Horizontal

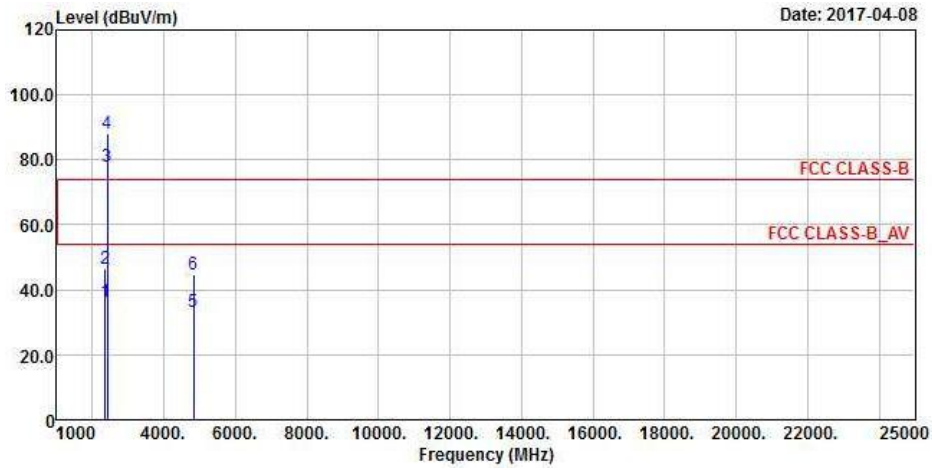

Vertical

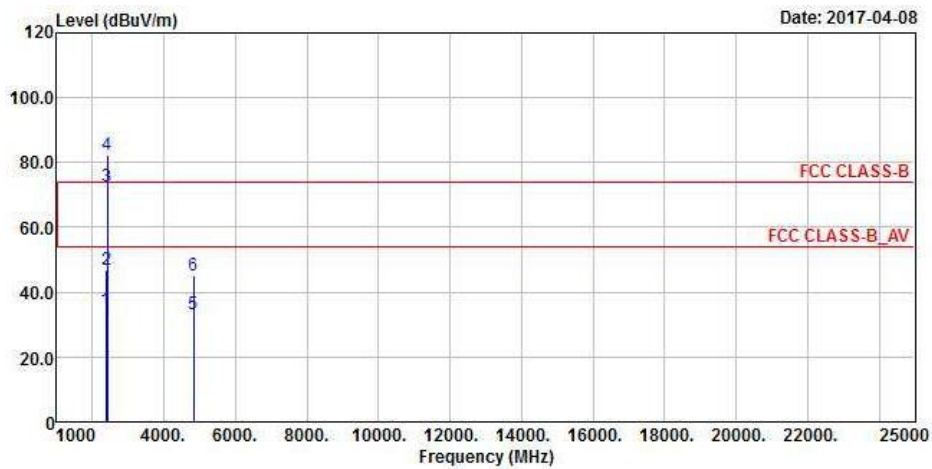

Antennal Polarity & Test Distance: Horizontal at 3 m

Frequency (MHz)	Emission Level (dBuV/m)	Read Level (dBuV)	Limit (dBuV/m)	Margin (dB)	Antenna Factor (dB/m)	Cable Loss (dB)	Preamp Factor (dB)	Antenna Height (cm)	Table Angle (Degree)	Remark
2360.22	36.33	42.96	54	-17.67	26.81	4.05	37.49	204	42	Average
2362.74	46.63	53.24	74	-27.37	26.81	4.07	37.49	204	42	Peak
2412	77.97	84.44			26.96	4.09	37.52	204	42	Average
2412	87.99	94.46			26.96	4.09	37.52	204	42	Peak
4824	33.13	48.43	54	-20.87	30.99	6.79	53.08	176	107	Average
4824	44.65	59.95	74	-29.35	30.99	6.79	53.08	176	107	Peak

Antennal Polarity & Test Distance: Vertical at 3 m

Frequency (MHz)	Emission Level (dBuV/m)	Read Level (dBuV)	Limit (dBuV/m)	Margin (dB)	Antenna Factor (dB/m)	Cable Loss (dB)	Preamp Factor (dB)	Antenna Height (cm)	Table Angle (Degree)	Remark
2379.84	34.47	41.03	54	-19.53	26.86	4.08	37.5	199	271	Average
2384.34	46.78	53.34	74	-27.22	26.86	4.08	37.5	199	271	Peak
2412	72.43	78.9			26.96	4.09	37.52	199	271	Average
2412	82.44	88.91			26.96	4.09	37.52	199	271	Peak
4824	33.05	48.35	54	-20.95	30.99	6.79	53.08	178	241	Average
4824	45.17	60.47	74	-28.83	30.99	6.79	53.08	178	241	Peak

Remarks:

- Emission Level = Read Level + Antenna Factor + Cable Loss - Preamp Factor
Margin value = Emission level – Limit value
- 2412 MHz: Fundamental frequency.

EUT Test Condition		Measurement Detail	
Channel	Channel 6	Frequency Range	1 GHz ~ 25 GHz
Input Power	120 Vac, 60 Hz	Detector Function	Peak (PK) Average (AV)
Environmental Conditions	25 deg. C, 65 % RH	Tested By	Getaz Yang

Horizontal

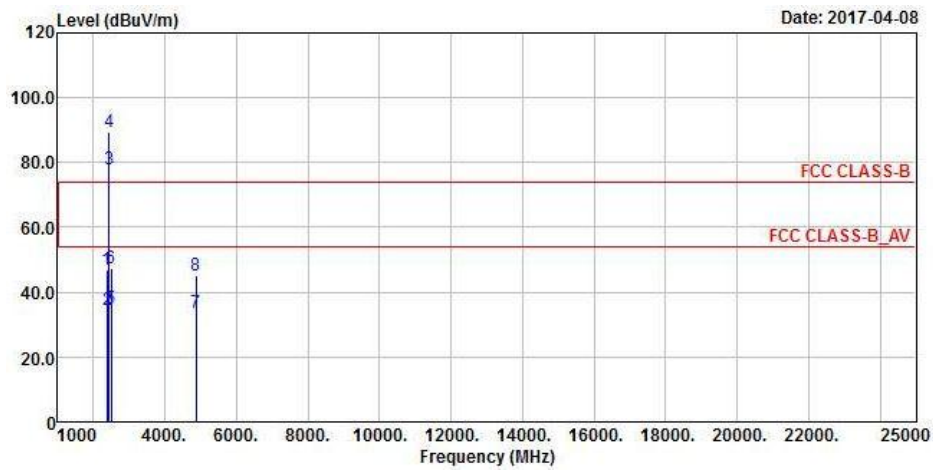

Vertical

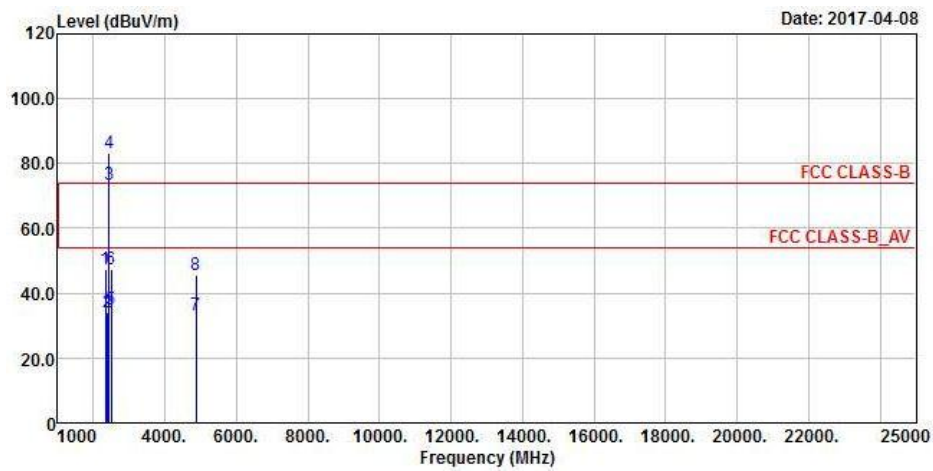

Antennal Polarity & Test Distance: Horizontal at 3 m

Frequency (MHz)	Emission Level (dBuV/m)	Read Level (dBuV)	Limit (dBuV/m)	Margin (dB)	Antenna Factor (dB/m)	Cable Loss (dB)	Preamp Factor (dB)	Antenna Height (cm)	Table Angle (Degree)	Remark
2374.89	46.87	53.44	74	-27.13	26.86	4.07	37.5	198	52	Peak
2383.53	34.33	40.89	54	-19.67	26.86	4.08	37.5	198	52	Average
2437	78.14	84.42			27.06	4.12	37.46	198	52	Average
2437	89.31	95.59			27.06	4.12	37.46	198	52	Peak
2489.72	34.99	40.95	54	-19.01	27.2	4.16	37.32	198	52	Average
2490.28	47.35	53.31	74	-26.65	27.2	4.16	37.32	198	52	Peak
4874	33.58	48.72	54	-20.42	31.06	6.85	53.05	197	89	Average
4874	44.99	60.13	74	-29.01	31.06	6.85	53.05	197	89	Peak

Antennal Polarity & Test Distance: Vertical at 3 m

Frequency (MHz)	Emission Level (dBuV/m)	Read Level (dBuV)	Limit (dBuV/m)	Margin (dB)	Antenna Factor (dB/m)	Cable Loss (dB)	Preamp Factor (dB)	Antenna Height (cm)	Table Angle (Degree)	Remark
2333.76	47.2	53.91	74	-26.8	26.72	4.04	37.47	199	275	Peak
2383.98	34.3	40.86	54	-19.7	26.86	4.08	37.5	199	275	Average
2437	73.3	79.58			27.06	4.12	37.46	199	275	Average
2437	83.37	89.65			27.06	4.12	37.46	199	275	Peak
2488.48	34.94	40.9	54	-19.06	27.2	4.16	37.32	199	275	Average
2496.4	47.37	53.26	74	-26.63	27.2	4.16	37.25	199	275	Peak
4874	33.2	48.34	54	-20.8	31.06	6.85	53.05	159	219	Average
4874	45.53	60.67	74	-28.47	31.06	6.85	53.05	159	219	Peak

Remarks:

- Emission Level = Read Level + Antenna Factor + Cable Loss - Preamp Factor
Margin value = Emission level – Limit value
- 2437 MHz: Fundamental frequency.

EUT Test Condition		Measurement Detail	
Channel	Channel 11	Frequency Range	1 GHz ~ 25 GHz
Input Power	120 Vac, 60 Hz	Detector Function	Peak (PK) Average (AV)
Environmental Conditions	25 deg. C, 65 % RH	Tested By	Getaz Yang

Horizontal

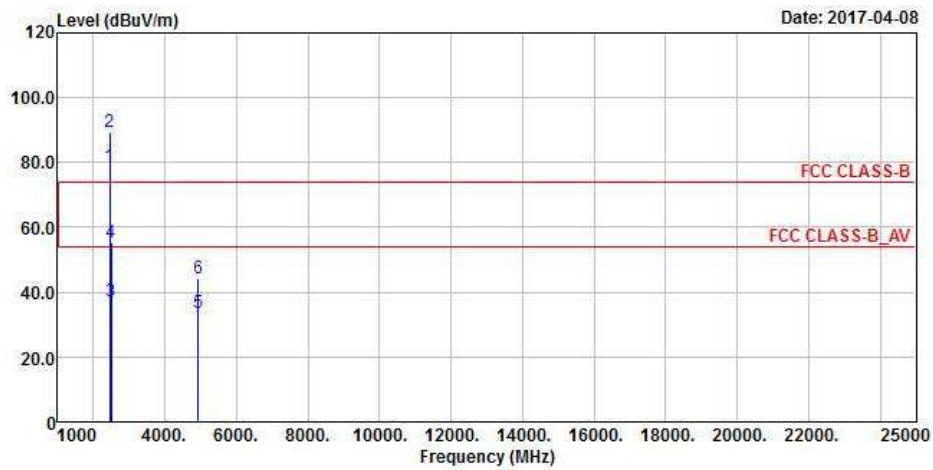

Vertical

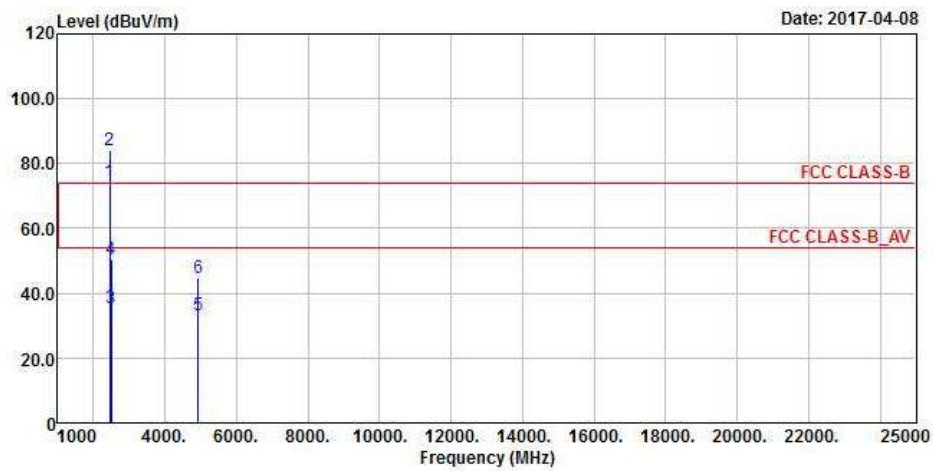

Antennal Polarity & Test Distance: Horizontal at 3 m										
Frequency (MHz)	Emission Level (dBuV/m)	Read Level (dBuV)	Limit (dBuV/m)	Margin (dB)	Antenna Factor (dB/m)	Cable Loss (dB)	Preamp Factor (dB)	Antenna Height (cm)	Table Angle (Degree)	Remark
2462	78.86	85.02			27.1	4.13	37.39	224	1	Average
2462	89.42	95.58			27.1	4.13	37.39	224	1	Peak
2483.56	37.27	43.29	54	-16.73	27.15	4.15	37.32	224	1	Average
2484.44	55.13	61.15	74	-18.87	27.15	4.15	37.32	224	1	Peak
4924	33.55	48.58	54	-20.45	31.12	6.88	53.03	194	104	Average
4924	44.39	59.42	74	-29.61	31.12	6.88	53.03	194	104	Peak
Antennal Polarity & Test Distance: Vertical at 3 m										
Frequency (MHz)	Emission Level (dBuV/m)	Read Level (dBuV)	Limit (dBuV/m)	Margin (dB)	Antenna Factor (dB/m)	Cable Loss (dB)	Preamp Factor (dB)	Antenna Height (cm)	Table Angle (Degree)	Remark
2462	74.26	80.42			27.1	4.13	37.39	215	340	Average
2462	84.09	90.25			27.1	4.13	37.39	215	340	Peak
2483.76	35.46	41.48	54	-18.54	27.15	4.15	37.32	215	340	Average
2484.4	50.69	56.71	74	-23.31	27.15	4.15	37.32	215	340	Peak
4924	33.18	48.21	54	-20.82	31.12	6.88	53.03	181	236	Average
4924	44.57	59.6	74	-29.43	31.12	6.88	53.03	181	236	Peak

Remarks:

- Emission Level = Read Level + Antenna Factor + Cable Loss - Preamp Factor
Margin value = Emission level – Limit value
- 2462 MHz: Fundamental frequency.

EUT Test Condition		Measurement Detail	
Channel	Channel 12	Frequency Range	1 GHz ~ 25 GHz
Input Power	120 Vac, 60 Hz	Detector Function	Peak (PK) Average (AV)
Environmental Conditions	25 deg. C, 65 % RH	Tested By	Getaz Yang

Horizontal

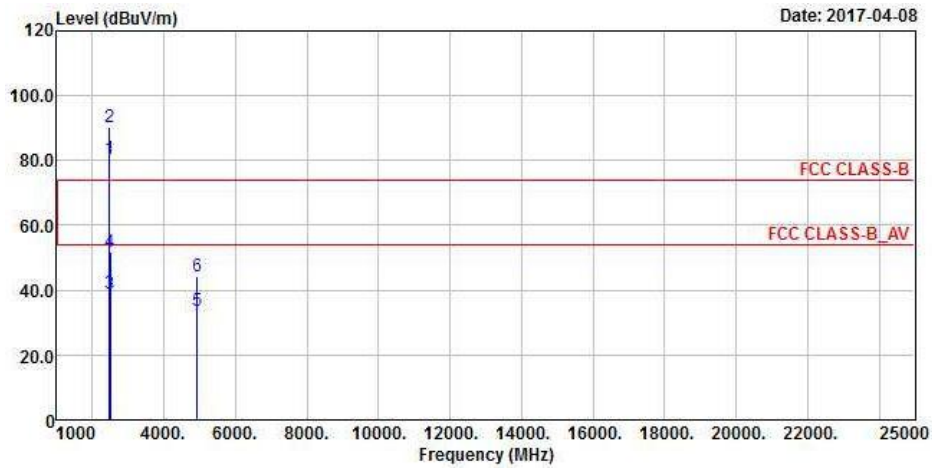

Vertical

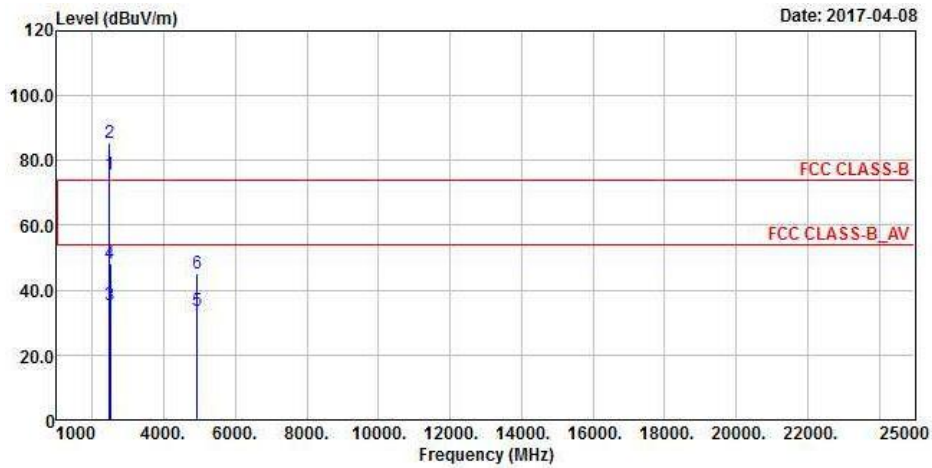

Antennal Polarity & Test Distance: Horizontal at 3 m

Frequency (MHz)	Emission Level (dBuV/m)	Read Level (dBuV)	Limit (dBuV/m)	Margin (dB)	Antenna Factor (dB/m)	Cable Loss (dB)	Preamp Factor (dB)	Antenna Height (cm)	Table Angle (Degree)	Remark
2467	80.5	86.59			27.1	4.13	37.32	198	55	Average
2467	90.27	96.36			27.1	4.13	37.32	198	55	Peak
2483.88	39.1	45.12	54	-14.9	27.15	4.15	37.32	198	55	Average
2484.44	51.74	57.76	74	-22.26	27.15	4.15	37.32	198	55	Peak
4934	33.72	48.75	54	-20.28	31.12	6.88	53.03	179	103	Average
4934	44.35	59.38	74	-29.65	31.12	6.88	53.03	179	103	Peak

Antennal Polarity & Test Distance: Vertical at 3 m

Frequency (MHz)	Emission Level (dBuV/m)	Read Level (dBuV)	Limit (dBuV/m)	Margin (dB)	Antenna Factor (dB/m)	Cable Loss (dB)	Preamp Factor (dB)	Antenna Height (cm)	Table Angle (Degree)	Remark
2467	75.77	81.86			27.1	4.13	37.32	201	355	Average
2467	85.5	91.59			27.1	4.13	37.32	201	355	Peak
2485.16	35.32	41.34	54	-18.68	27.15	4.15	37.32	201	355	Average
2485.44	48.3	54.32	74	-25.7	27.15	4.15	37.32	201	355	Peak
4934	33.45	48.48	54	-20.55	31.12	6.88	53.03	157	237	Average
4934	45.17	60.2	74	-28.83	31.12	6.88	53.03	157	237	Peak

Remarks:

- Emission Level = Read Level + Antenna Factor + Cable Loss - Preamp Factor
Margin value = Emission level – Limit value
- 2467 MHz: Fundamental frequency.

EUT Test Condition		Measurement Detail	
Channel	Channel 13	Frequency Range	1 GHz ~ 25 GHz
Input Power	120 Vac, 60 Hz	Detector Function	Peak (PK) Average (AV)
Environmental Conditions	25 deg. C, 65 % RH	Tested By	Getaz Yang

Horizontal

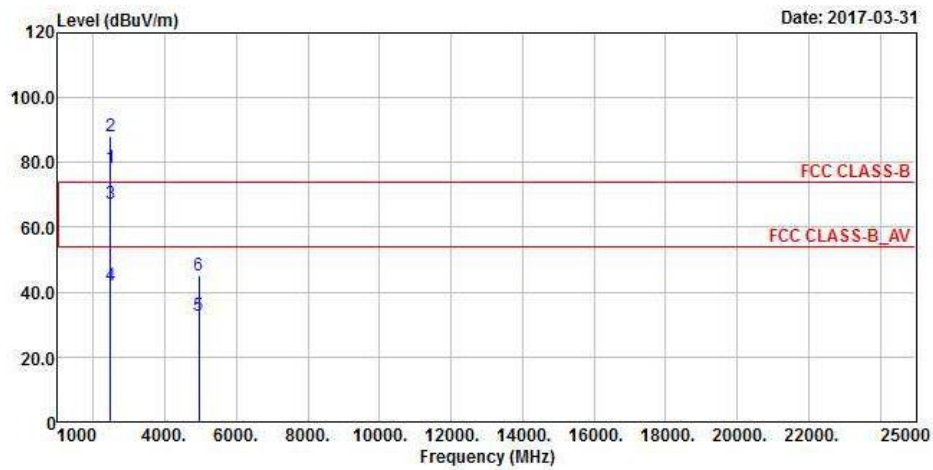

Vertical

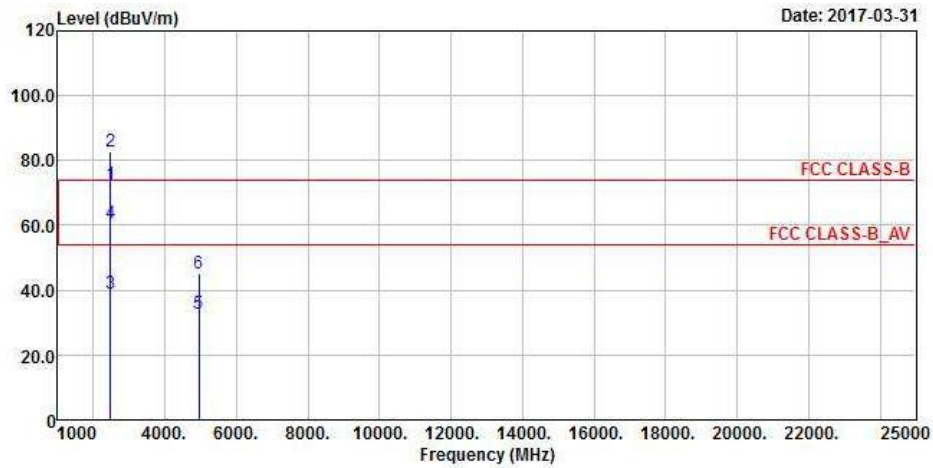

**Band Edge
Peak
Horizontal**

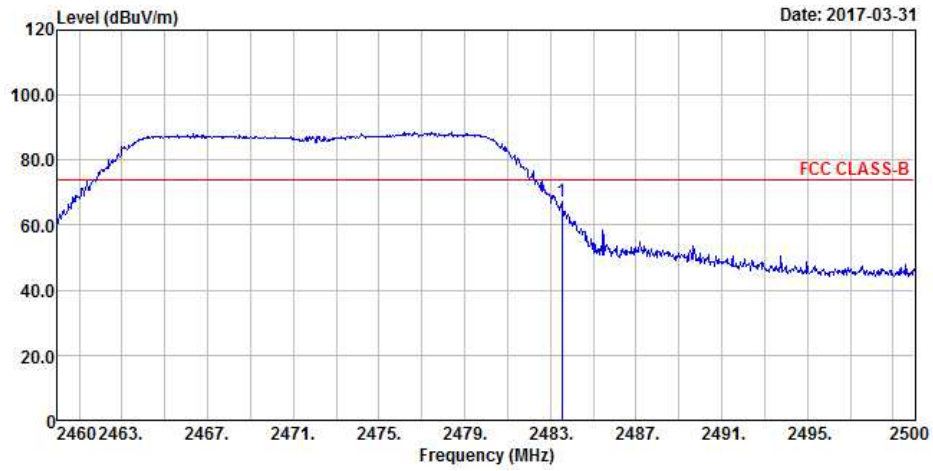

Vertical

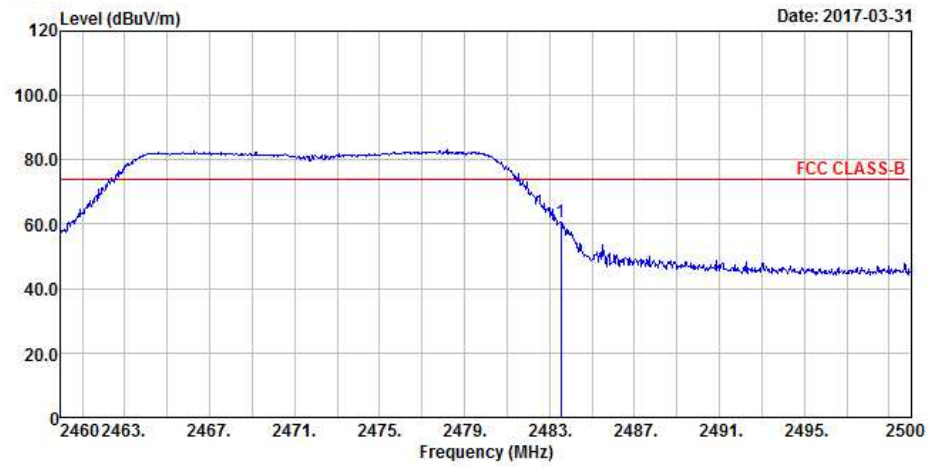

Average Horizontal

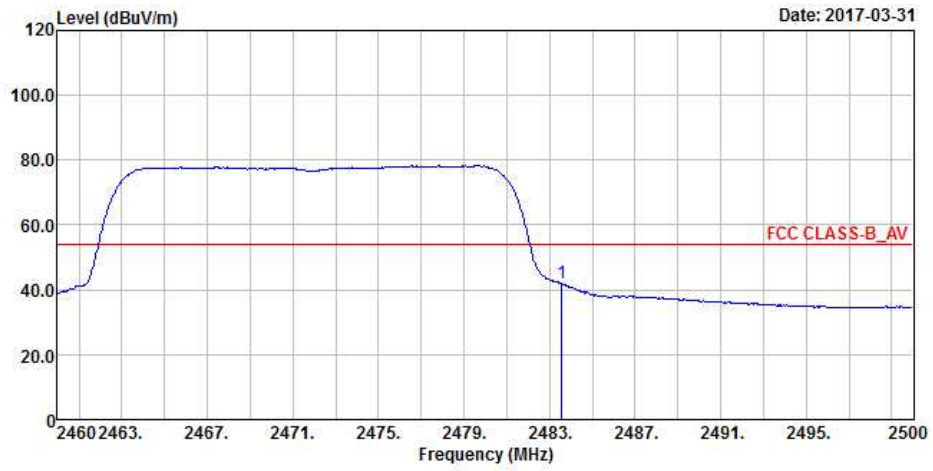

Vertical

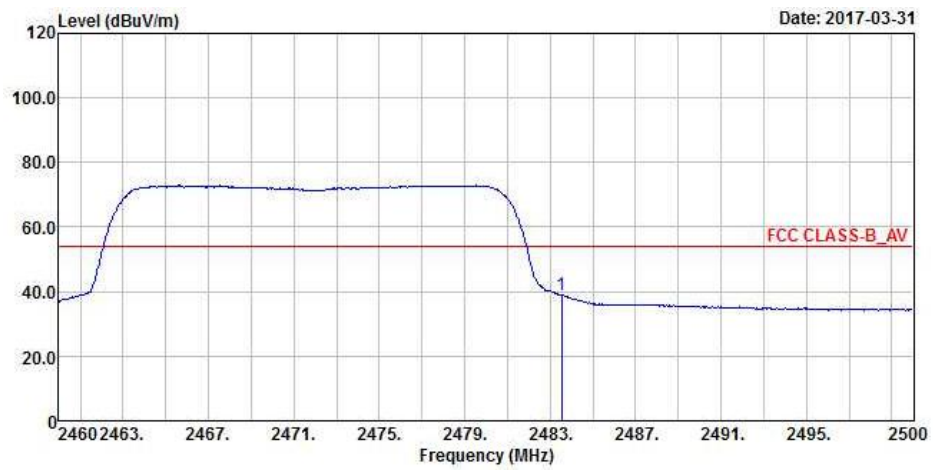

Antennal Polarity & Test Distance: Horizontal at 3 m

Frequency (MHz)	Emission Level (dBuV/m)	Read Level (dBuV)	Limit (dBuV/m)	Margin (dB)	Antenna Factor (dB/m)	Cable Loss (dB)	Preamp Factor (dB)	Antenna Height (cm)	Table Angle (Degree)	Remark
2472	78.27	84.29			27.15	4.15	37.32	203	209	Average
2472	88.28	94.3			27.15	4.15	37.32	203	209	Peak
2483.52	67.37	73.39	74	-6.63	27.15	4.15	37.32	203	209	Peak
2483.56	42.01	48.03	54	-11.99	27.15	4.15	37.32	203	209	Average
4944	32.66	47.65	54	-21.34	31.14	6.91	53.04	150	211	Average
4944	44.96	59.95	74	-29.04	31.14	6.91	53.04	150	211	Peak

Antennal Polarity & Test Distance: Vertical at 3 m

Frequency (MHz)	Emission Level (dBuV/m)	Read Level (dBuV)	Limit (dBuV/m)	Margin (dB)	Antenna Factor (dB/m)	Cable Loss (dB)	Preamp Factor (dB)	Antenna Height (cm)	Table Angle (Degree)	Remark
2472	72.7	78.72			27.15	4.15	37.32	215	244	Average
2472	82.79	88.81			27.15	4.15	37.32	215	244	Peak
2483.52	39.09	45.11	54	-14.91	27.15	4.15	37.32	215	244	Average
2483.52	60.69	66.71	74	-13.31	27.15	4.15	37.32	215	244	Peak
4944	32.91	47.9	54	-21.09	31.14	6.91	53.04	131	21	Average
4944	45.02	60.01	74	-28.98	31.14	6.91	53.04	131	21	Peak

Remarks:

- Emission Level = Read Level + Antenna Factor + Cable Loss - Preamp Factor
Margin value = Emission level – Limit value
- 2472 MHz: Fundamental frequency.

Mode B
802.11n (HT20)

EUT Test Condition		Measurement Detail	
Channel	Channel 13	Frequency Range	1 GHz ~ 25 GHz
Input Power	120 Vac, 60 Hz	Detector Function	Peak (PK) Average (AV)
Environmental Conditions	25 deg. C, 65 % RH	Tested By	Getaz Yang

Horizontal

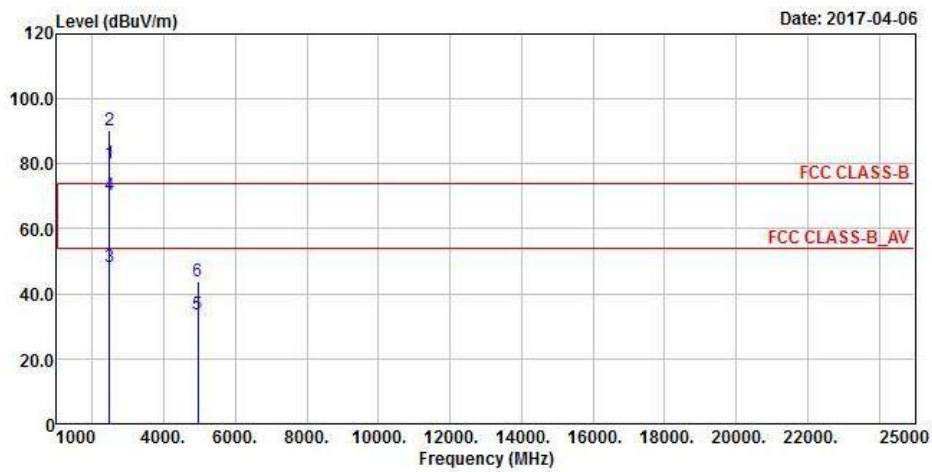

Vertical

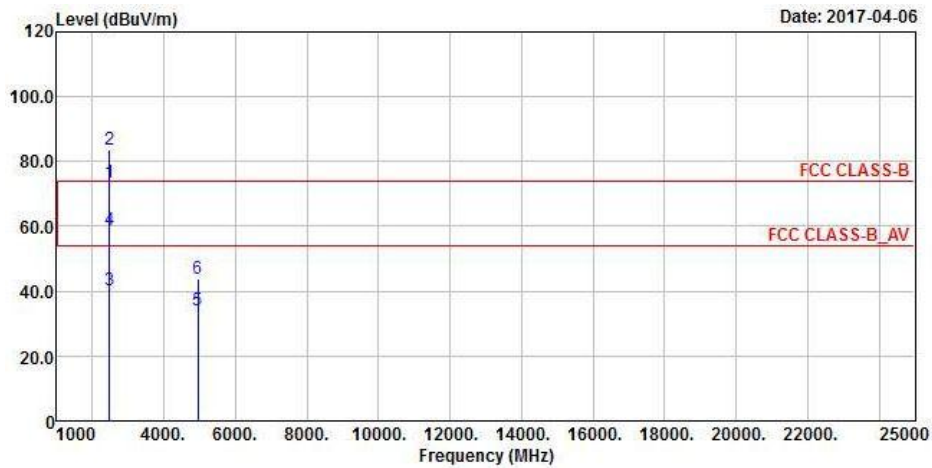

**Band Edge
Peak
Horizontal**

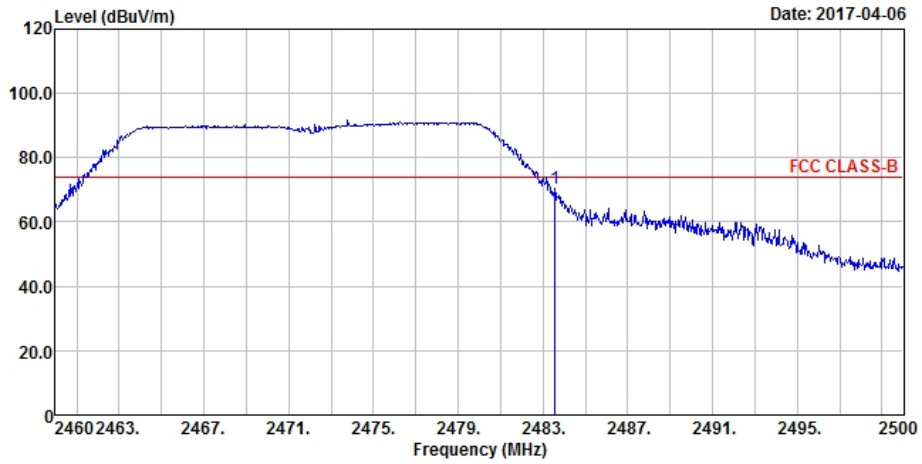

Vertical

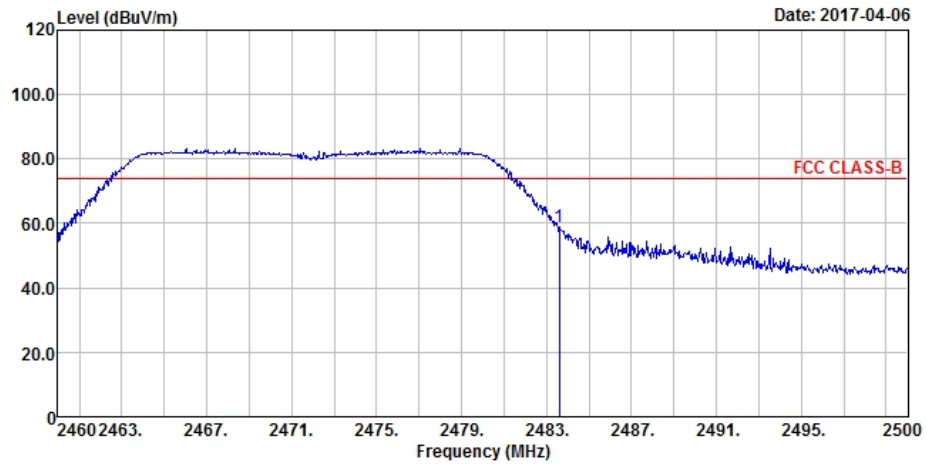

Average Horizontal

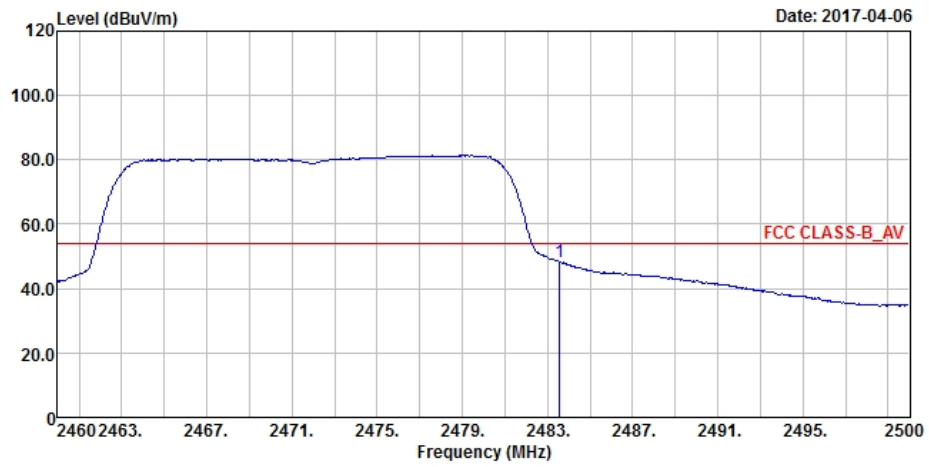

Vertical

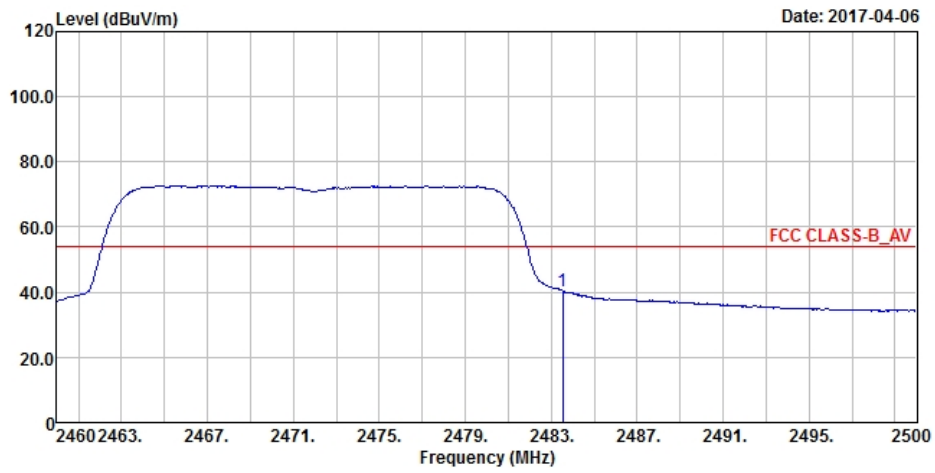

Antennal Polarity & Test Distance: Horizontal at 3 m

Frequency (MHz)	Emission Level (dBuV/m)	Read Level (dBuV)	Limit (dBuV/m)	Margin (dB)	Antenna Factor (dB/m)	Cable Loss (dB)	Preamp Factor (dB)	Antenna Height (cm)	Table Angle (Degree)	Remark
2472	80.32	86.34			27.15	4.15	37.32	222	7	Average
2472	90.31	96.33			27.15	4.15	37.32	222	7	Peak
2483.56	48.49	54.51	54	-5.51	27.15	4.15	37.32	222	7	Average
2483.56	70.38	76.4	74	-3.62	27.15	4.15	37.32	222	7	Peak
4944	33.72	48.71	54	-20.28	31.14	6.91	53.04	204	71	Average
4944	43.94	58.93	74	-30.06	31.14	6.91	53.04	204	71	Peak

Antennal Polarity & Test Distance: Vertical at 3 m

Frequency (MHz)	Emission Level (dBuV/m)	Read Level (dBuV)	Limit (dBuV/m)	Margin (dB)	Antenna Factor (dB/m)	Cable Loss (dB)	Preamp Factor (dB)	Antenna Height (cm)	Table Angle (Degree)	Remark
2472	73.64	79.66			27.15	4.15	37.32	221	108	Average
2472	83.51	89.53			27.15	4.15	37.32	221	108	Peak
2483.52	40.38	46.4	54	-13.62	27.15	4.15	37.32	221	108	Average
2483.6	59.11	65.13	74	-14.89	27.15	4.15	37.32	221	108	Peak
4944	33.96	48.95	54	-20.04	31.14	6.91	53.04	186	290	Average
4944	43.82	58.81	74	-30.18	31.14	6.91	53.04	186	290	Peak

Remarks:

- Emission Level = Read Level + Antenna Factor + Cable Loss - Preamp Factor
Margin value = Emission level – Limit value
- 2472 MHz: Fundamental frequency.

Mode C

EUT Test Condition		Measurement Detail	
Channel	Channel 13	Frequency Range	1 GHz ~ 25 GHz
Input Power	120 Vac, 60 Hz	Detector Function	Peak (PK) Average (AV)
Environmental Conditions	25 deg. C, 65 % RH	Tested By	Getaz Yang

Horizontal

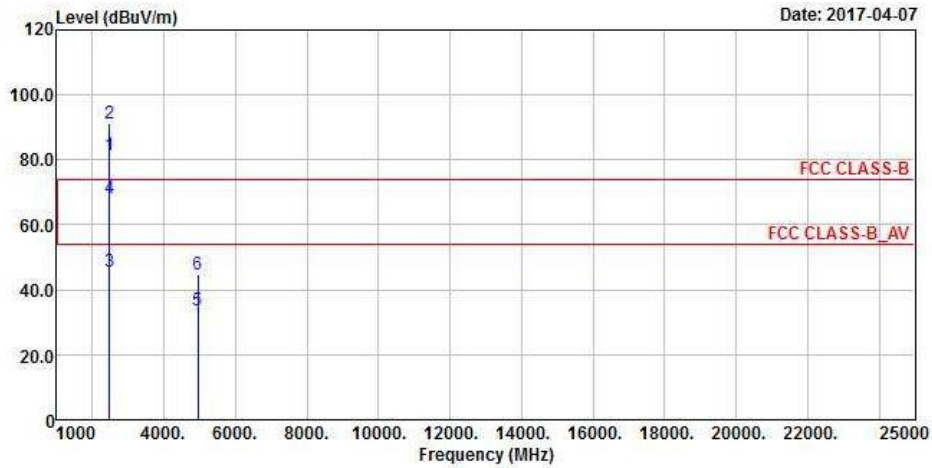

Vertical

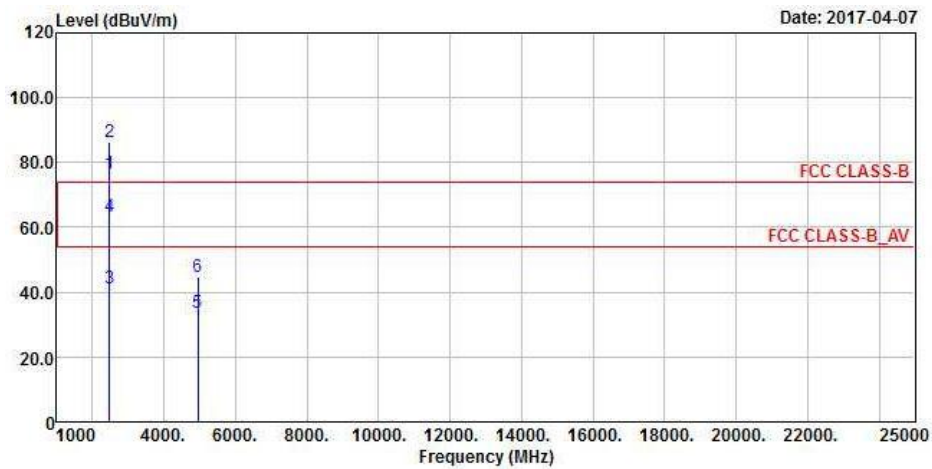

**Band Edge
Peak
Horizontal**

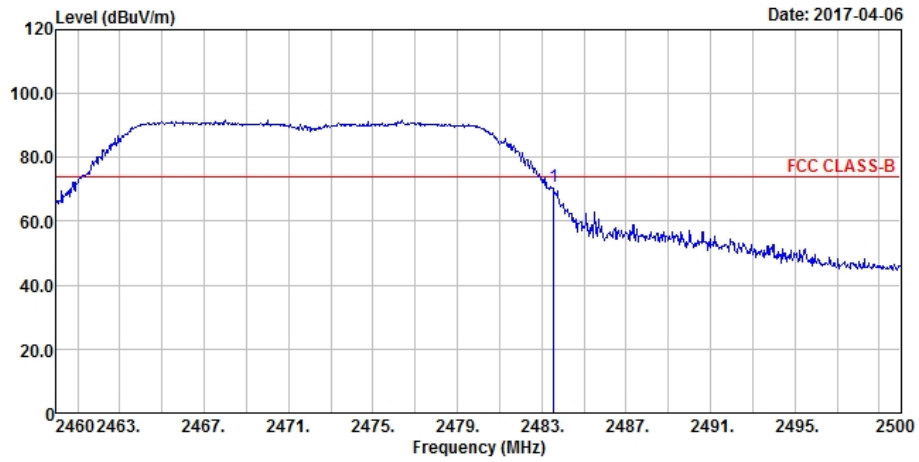

Vertical

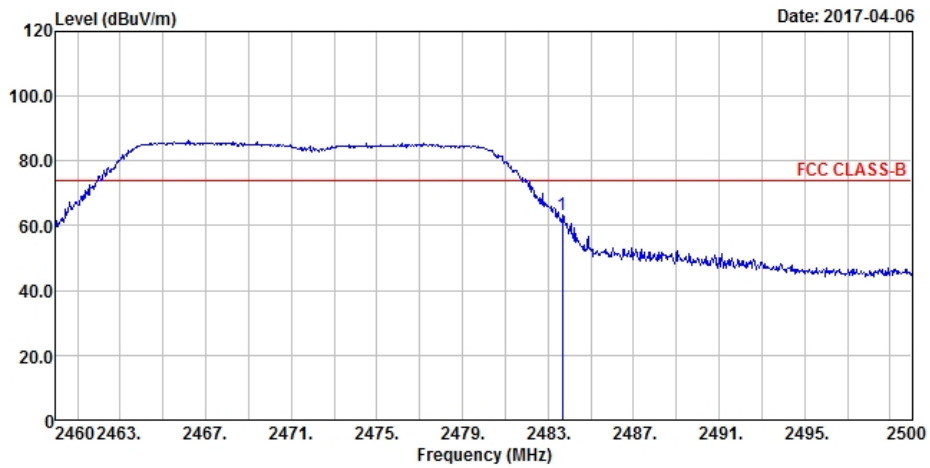

Average Horizontal

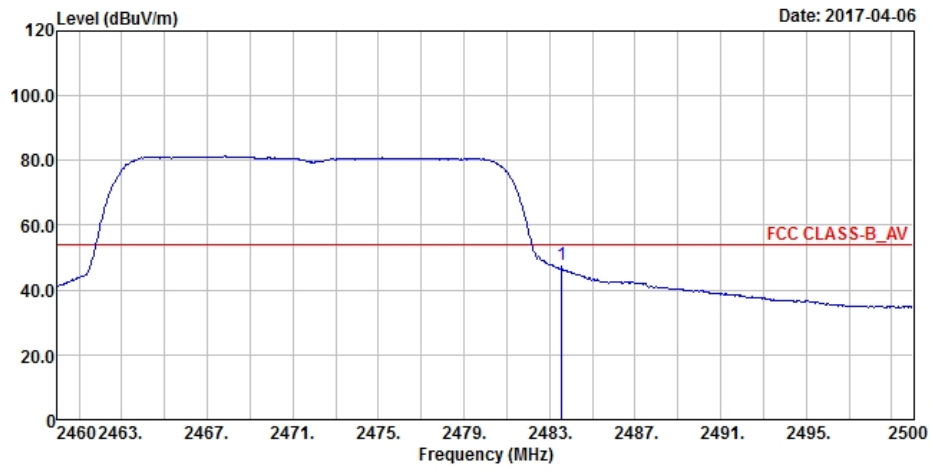

Vertical

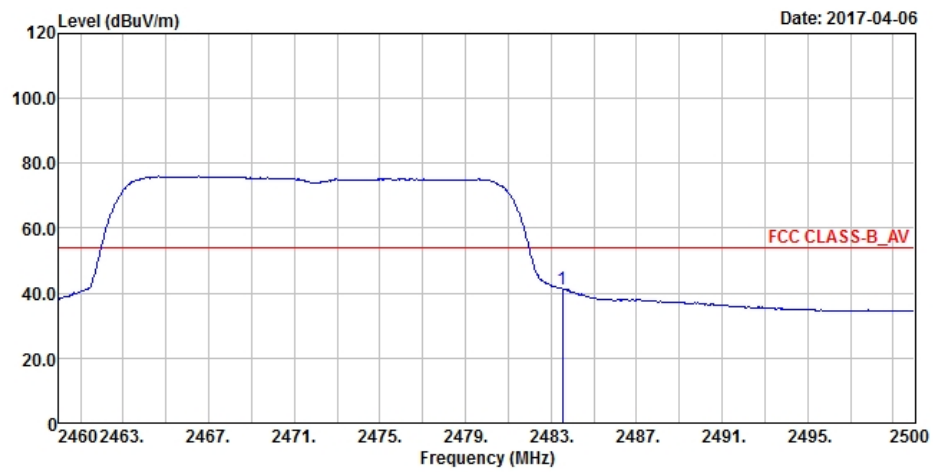

Antennal Polarity & Test Distance: Horizontal at 3 m

Frequency (MHz)	Emission Level (dBuV/m)	Read Level (dBuV)	Limit (dBuV/m)	Margin (dB)	Antenna Factor (dB/m)	Cable Loss (dB)	Preamp Factor (dB)	Antenna Height (cm)	Table Angle (Degree)	Remark
2472	81.31	87.33			27.15	4.15	37.32	200	2	Average
2472	91.03	97.05			27.15	4.15	37.32	200	2	Peak
2483.56	45.62	51.64	54	-8.38	27.15	4.15	37.32	200	2	Average
2483.56	68.04	74.06	74	-5.96	27.15	4.15	37.32	200	2	Peak
4944	33.76	48.75	54	-20.24	31.14	6.91	53.04	120	40	Average
4944	44.75	59.74	74	-29.25	31.14	6.91	53.04	120	40	Peak

Antennal Polarity & Test Distance: Vertical at 3 m

Frequency (MHz)	Emission Level (dBuV/m)	Read Level (dBuV)	Limit (dBuV/m)	Margin (dB)	Antenna Factor (dB/m)	Cable Loss (dB)	Preamp Factor (dB)	Antenna Height (cm)	Table Angle (Degree)	Remark
2472	76.67	82.69			27.15	4.15	37.32	190	11	Average
2472	86.41	92.43			27.15	4.15	37.32	190	11	Peak
2483.52	41.26	47.28	54	-12.74	27.15	4.15	37.32	190	11	Average
2483.68	63.26	69.28	74	-10.74	27.15	4.15	37.32	190	11	Peak
4944	33.74	48.73	54	-20.26	31.14	6.91	53.04	175	219	Average
4944	44.68	59.67	74	-29.32	31.14	6.91	53.04	175	219	Peak

Remarks:

- Emission Level = Read Level + Antenna Factor + Cable Loss - Preamp Factor
Margin value = Emission level – Limit value
- 2472 MHz: Fundamental frequency.

9 kHz ~ 30 MHz DATA:

The amplitude of spurious emissions attenuated more than 20 dB below the permissible value is not required to be report.

30 MHz ~ 1 GHz WORST-CASE DATA:

Mode A

802.11n (HT20)

EUT Test Condition		Measurement Detail	
Channel	Channel 13	Frequency Range	30 MHz ~ 1 GHz
Input Power	120 Vac, 60 Hz	Detector Function	Peak (PK) Quasi-peak (QP)
Environmental Conditions	25 deg. C, 65 % RH	Tested By	Getaz Yang

Horizontal

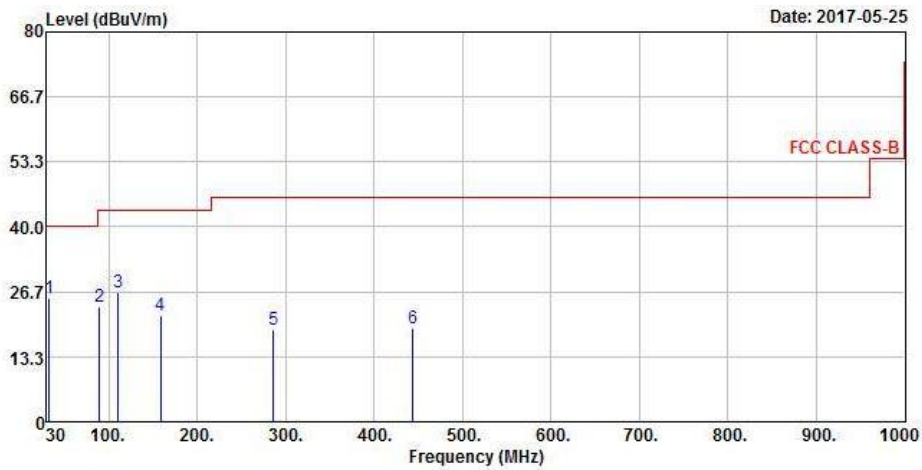

Vertical

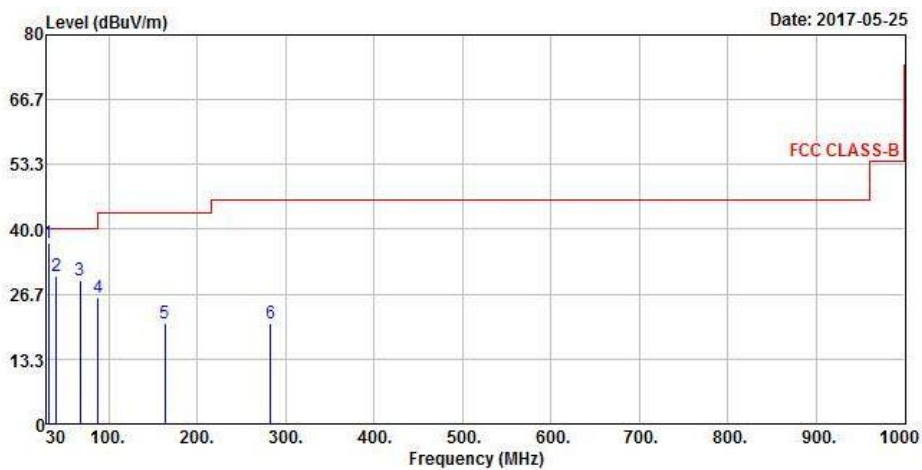

Antennal Polarity & Test Distance: Horizontal at 3 m

Frequency (MHz)	Emission Level (dBuV/m)	Read Level (dBuV)	Limit (dBuV/m)	Margin (dB)	Antenna Factor (dB/m)	Cable Loss (dB)	Preamp Factor (dB)	Antenna Height (cm)	Table Angle (Degree)	Remark
32.91	25.4	43.42	40	-14.6	12.47	0.6	31.09	138	308	Peak
89.17	23.57	46.24	43.5	-19.93	8.28	0.96	31.91	119	170	Peak
110.51	26.61	47.26	43.5	-16.89	10.09	1.11	31.85	121	145	Peak
159.01	21.88	39.86	43.5	-21.62	12.73	1.14	31.85	105	216	Peak
286.08	19	36.6	46	-27	12.54	1.59	31.73	130	12	Peak
444.19	19.19	32.99	46	-26.81	16.21	1.98	31.99	104	274	Peak

Antennal Polarity & Test Distance: Vertical at 3 m

Frequency (MHz)	Emission Level (dBuV/m)	Read Level (dBuV)	Limit (dBuV/m)	Margin (dB)	Antenna Factor (dB/m)	Cable Loss (dB)	Preamp Factor (dB)	Antenna Height (cm)	Table Angle (Degree)	Remark
31.94	37.11	55.33	40	-2.89	12.3	0.59	31.11	127	328	Peak
40.67	30.29	47.11	40	-9.71	13.55	0.65	31.02	119	160	Peak
67.83	29.63	49.51	40	-10.37	11	0.85	31.73	116	290	Peak
88.2	25.99	48.64	43.5	-17.51	8.27	0.95	31.87	110	323	Peak
163.86	20.77	39.12	43.5	-22.73	12.34	1.13	31.82	129	240	Peak
283.17	20.59	38.32	46	-25.41	12.45	1.59	31.77	132	288	Peak

Remarks:

- Emission Level = Read Level + Antenna Factor + Cable Loss - Preamp Factor
Margin value = Emission level – Limit value

Mode B
802.11n (HT20)

EUT Test Condition		Measurement Detail	
Channel	Channel 13	Frequency Range	30 MHz ~ 1 GHz
Input Power	120 Vac, 60 Hz	Detector Function	Peak (PK) Quasi-peak (QP)
Environmental Conditions	25 deg. C, 65 % RH	Tested By	Getaz Yang

Horizontal

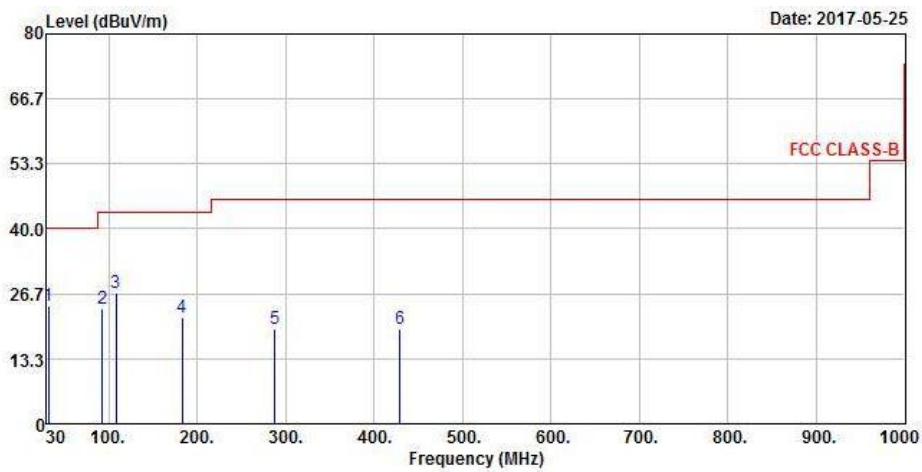

Vertical

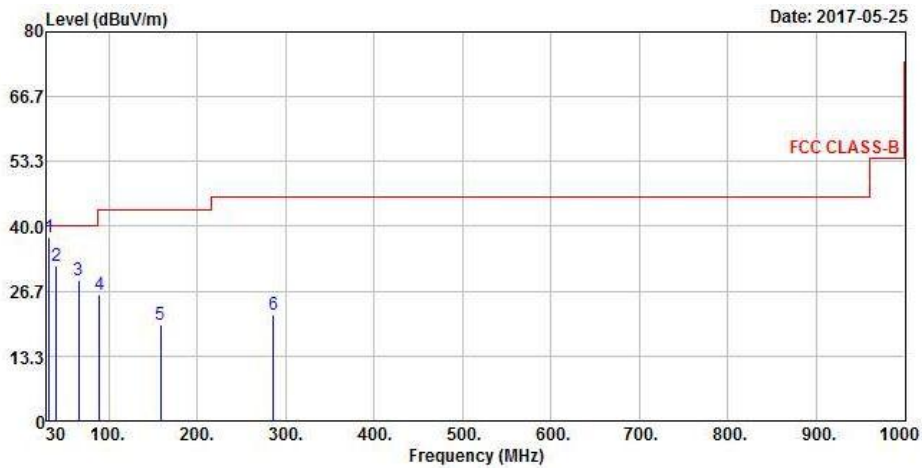

Antennal Polarity & Test Distance: Horizontal at 3 m

Frequency (MHz)	Emission Level (dBuV/m)	Read Level (dBuV)	Limit (dBuV/m)	Margin (dB)	Antenna Factor (dB/m)	Cable Loss (dB)	Preamp Factor (dB)	Antenna Height (cm)	Table Angle (Degree)	Remark
31.94	24.17	42.39	40	-15.83	12.3	0.59	31.11	129	95	Peak
93.05	23.56	46	43.5	-19.94	8.53	0.99	31.96	126	277	Peak
108.57	26.95	47.8	43.5	-16.55	9.9	1.1	31.85	103	194	Peak
183.26	21.97	42	43.5	-21.53	10.53	1.23	31.79	126	36	Peak
288.02	19.4	36.9	46	-26.6	12.6	1.6	31.7	128	92	Peak
429.64	19.49	33.62	46	-26.51	15.93	1.95	32.01	118	29	Peak

Antennal Polarity & Test Distance: Vertical at 3 m

Frequency (MHz)	Emission Level (dBuV/m)	Read Level (dBuV)	Limit (dBuV/m)	Margin (dB)	Antenna Factor (dB/m)	Cable Loss (dB)	Preamp Factor (dB)	Antenna Height (cm)	Table Angle (Degree)	Remark
32.91	37.73	55.75	40	-2.27	12.47	0.6	31.09	120	178	Peak
40.67	31.87	48.69	40	-8.13	13.55	0.65	31.02	101	229	Peak
65.89	29.02	48.57	40	-10.98	11.24	0.85	31.64	130	310	Peak
89.17	26.1	48.77	43.5	-17.4	8.28	0.96	31.91	126	131	Peak
159.01	19.72	37.7	43.5	-23.78	12.73	1.14	31.85	103	222	Peak
286.08	21.9	39.5	46	-24.1	12.54	1.59	31.73	109	129	Peak

Remarks:

- Emission Level = Read Level + Antenna Factor + Cable Loss - Preamp Factor
Margin value = Emission level – Limit value

Mode C
802.11n (HT20)

EUT Test Condition		Measurement Detail	
Channel	Channel 13	Frequency Range	30 MHz ~ 1 GHz
Input Power	120 Vac, 60 Hz	Detector Function	Peak (PK) Quasi-peak (QP)
Environmental Conditions	25 deg. C, 65 % RH	Tested By	Getaz Yang

Horizontal

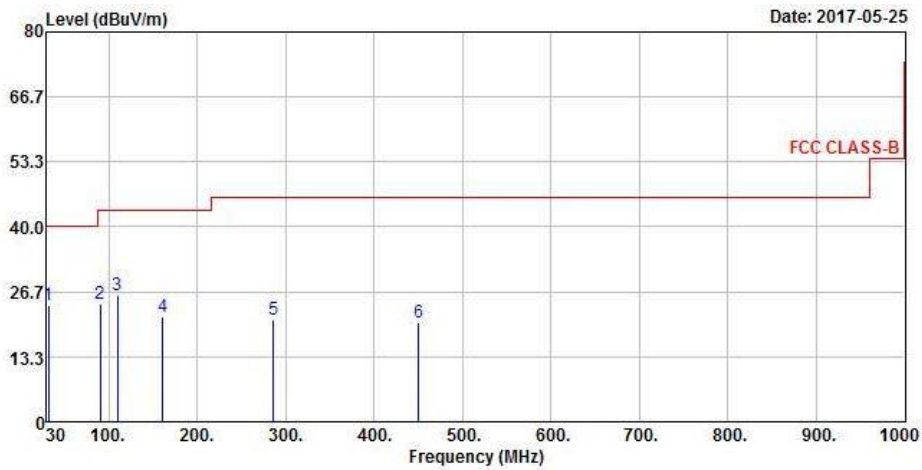

Vertical

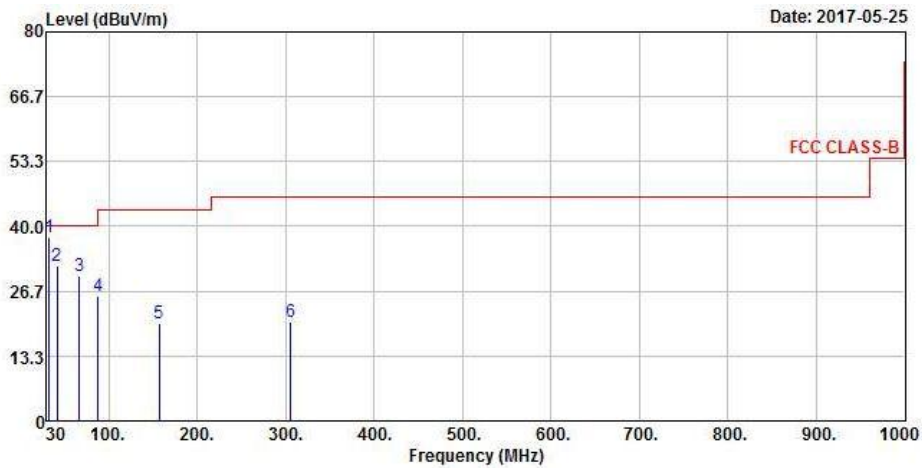

Antennal Polarity & Test Distance: Horizontal at 3 m

Frequency (MHz)	Emission Level (dBuV/m)	Read Level (dBuV)	Limit (dBuV/m)	Margin (dB)	Antenna Factor (dB/m)	Cable Loss (dB)	Preamp Factor (dB)	Antenna Height (cm)	Table Angle (Degree)	Remark
31.94	24.01	42.23	40	-15.99	12.3	0.59	31.11	112	109	Peak
90.14	24.13	46.82	43.5	-19.37	8.3	0.97	31.96	122	352	Peak
109.54	26.09	46.84	43.5	-17.41	9.99	1.1	31.84	127	194	Peak
160.95	21.51	39.59	43.5	-21.99	12.63	1.15	31.86	135	167	Peak
286.08	20.93	38.53	46	-25.07	12.54	1.59	31.73	127	293	Peak
450.01	20.34	34	46	-25.66	16.33	1.99	31.98	130	198	Peak

Antennal Polarity & Test Distance: Vertical at 3 m

Frequency (MHz)	Emission Level (dBuV/m)	Read Level (dBuV)	Limit (dBuV/m)	Margin (dB)	Antenna Factor (dB/m)	Cable Loss (dB)	Preamp Factor (dB)	Antenna Height (cm)	Table Angle (Degree)	Remark
32.91	37.68	55.7	40	-2.32	12.47	0.6	31.09	115	217	Peak
41.64	31.97	48.8	40	-8.03	13.56	0.66	31.05	121	241	Peak
66.86	29.9	49.61	40	-10.1	11.12	0.85	31.68	130	336	Peak
88.2	25.77	48.42	43.5	-17.73	8.27	0.95	31.87	128	261	Peak
157.07	19.97	37.92	43.5	-23.53	12.72	1.13	31.8	129	270	Peak
305.48	20.27	37.44	46	-25.73	13.08	1.65	31.9	124	153	Peak

Remarks:

- Emission Level = Read Level + Antenna Factor + Cable Loss - Preamp Factor
 Margin value = Emission level – Limit value

4.2 Conducted Emission Measurement

4.2.1 Limits of Conducted Emission Measurement

Frequency (MHz)	Conducted Limit (dBuV)	
	Quasi-peak	Average
0.15 - 0.5	66 - 56	56 - 46
0.50 - 5.0	56	46
5.0 - 30.0	60	50

Note: 1. The lower limit shall apply at the transition frequencies.

2. The limit decreases in line with the logarithm of the frequency in the range of 0.15 to 0.50 MHz.

4.2.2 Test Instruments

Description & Manufacturer	Model No.	Serial No.	Date of Calibration	Due Date of Calibration
Test Receiver ROHDE & SCHWARZ	ESCI	100613	Nov. 21, 2016	Nov. 20, 2017
RF signal cable (with 10dB PAD) Woken	5D-FB	Cable-cond1-01	Dec. 22, 2016	Dec. 21, 2017
LISN ROHDE & SCHWARZ (EUT)	ESH3-Z5	835239/001	Mar. 10, 2017	Mar. 09, 2018
LISN ROHDE & SCHWARZ (Peripheral)	ESH3-Z5	100311	Jul. 28, 2016	Jul. 27, 2017
Software ADT	BV ADT_Cond_ V7.3.7.3	NA	NA	NA

Note: 1. The calibration interval of the above test instruments is 12 months and the calibrations are traceable to NML/ROC and NIST/USA.

2. The test was performed in HwaYa Shielded Room 1.

3. The VCCI Site Registration No. is C-2040.

4.2.3 Test Procedures

- a. The EUT was placed 0.4 meters from the conducting wall of the shielded room with EUT being connected to the power mains through a line impedance stabilization network (LISN). Other support units were connected to the power mains through another LISN. The two LISNs provide 50 ohm/50 uH of coupling impedance for the measuring instrument.
- b. Both lines of the power mains connected to the EUT were checked for maximum conducted interference.
- c. The frequency range from 150 kHz to 30 MHz was searched. Emission levels under (Limit – 20 dB) was not recorded.

NOTE: All modes of operation were investigated and the worst-case emissions are reported.

4.2.4 Deviation from Test Standard

No deviation.

4.2.5 Test Setup

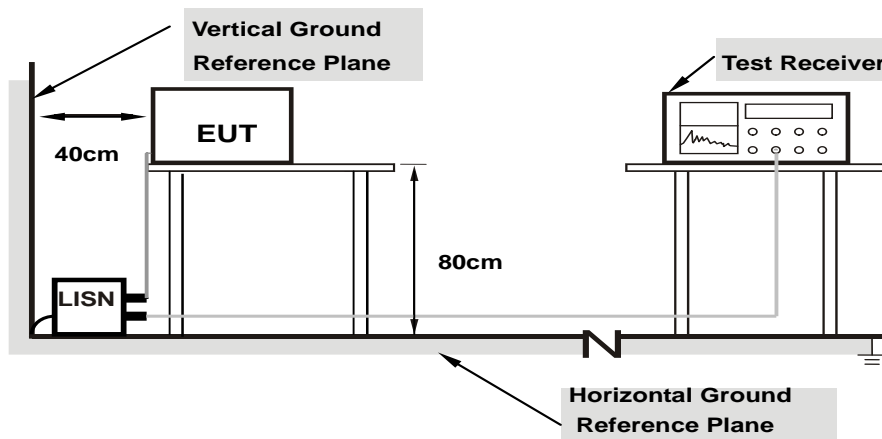

Note: 1. Support units were connected to second LISN.

For the actual test configuration, please refer to the attached file (Test Setup Photo).

4.2.6 EUT Operating Conditions

- a. Placed the EUT on a testing table.
- b. Use the software to control the EUT under transmission condition continuously at specific channel frequency.

4.2.7 Test Results

Mode A

Frequency Range	150kHz ~ 30MHz	Detector Function & Resolution Bandwidth	Quasi-Peak (QP) / Average (AV), 9kHz
Input Power	120Vac, 60Hz	Environmental Conditions	25°C, 65%RH
Tested by	Getaz Yang	Test Date	2017/5/27

Phase Of Power : Line (L)										
No	Frequency (MHz)	Correction Factor (dB)	Reading Value (dBuV)		Emission Level (dBuV)		Limit (dBuV)		Margin (dB)	
			Q.P.	AV.	Q.P.	AV.	Q.P.	AV.	Q.P.	AV.
1	0.15400	10.35	37.21	20.97	47.56	31.32	65.78	55.78	-18.22	-24.46
2	0.50600	10.40	27.73	23.26	38.13	33.66	56.00	46.00	-17.87	-12.34
3	0.83798	10.40	35.67	31.25	46.07	41.65	56.00	46.00	-9.93	-4.35
4	1.17000	10.41	13.54	5.96	23.95	16.37	56.00	46.00	-32.05	-29.63
5	1.83800	10.45	14.68	7.34	25.13	17.79	56.00	46.00	-30.87	-28.21
6	3.66600	10.55	14.23	6.09	24.78	16.64	56.00	46.00	-31.22	-29.36

Remarks:

1. Q.P. and AV. are abbreviations of quasi-peak and average individually.
2. The emission levels of other frequencies were very low against the limit.
3. Margin value = Emission level – Limit value
4. Correction factor = Insertion loss + Cable loss
5. Emission Level = Correction Factor + Reading Value

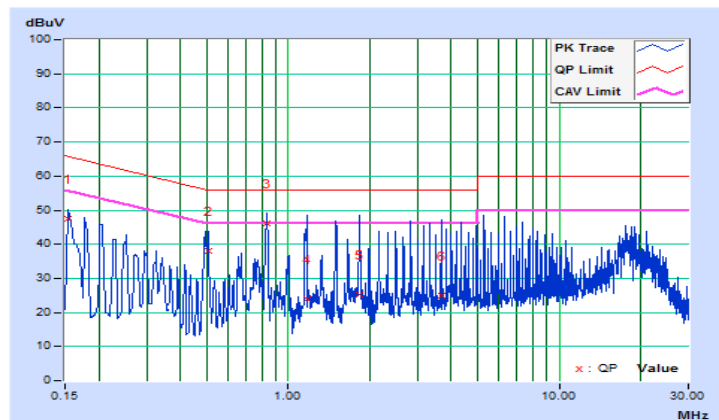

Frequency Range	150kHz ~ 30MHz	Detector Function & Resolution Bandwidth	Quasi-Peak (QP) / Average (AV), 9kHz
Input Power	120Vac, 60Hz	Environmental Conditions	25°C, 65%RH
Tested by	Getaz Yang	Test Date	2017/5/27

Phase Of Power : Neutral (N)										
No	Frequency (MHz)	Correction Factor (dB)	Reading Value (dBuV)		Emission Level (dBuV)		Limit (dBuV)		Margin (dB)	
			Q.P.	AV.	Q.P.	AV.	Q.P.	AV.	Q.P.	AV.
1	0.50200	10.16	40.17	34.01	50.33	44.17	56.00	46.00	-5.67	-1.83
2	0.83400	10.17	40.74	34.58	50.91	44.75	56.00	46.00	-5.09	-1.25
3	1.81812	10.22	35.13	31.00	45.35	41.22	56.00	46.00	-10.65	-4.78
4	2.15800	10.24	24.62	19.53	34.86	29.77	56.00	46.00	-21.14	-16.23
5	3.49800	10.31	17.50	5.81	27.81	16.12	56.00	46.00	-28.19	-29.88
6	5.66200	10.40	32.23	18.81	42.63	29.21	60.00	50.00	-17.37	-20.79

Remarks:

1. Q.P. and AV. are abbreviations of quasi-peak and average individually.
2. The emission levels of other frequencies were very low against the limit.
3. Margin value = Emission level – Limit value
4. Correction factor = Insertion loss + Cable loss
5. Emission Level = Correction Factor + Reading Value

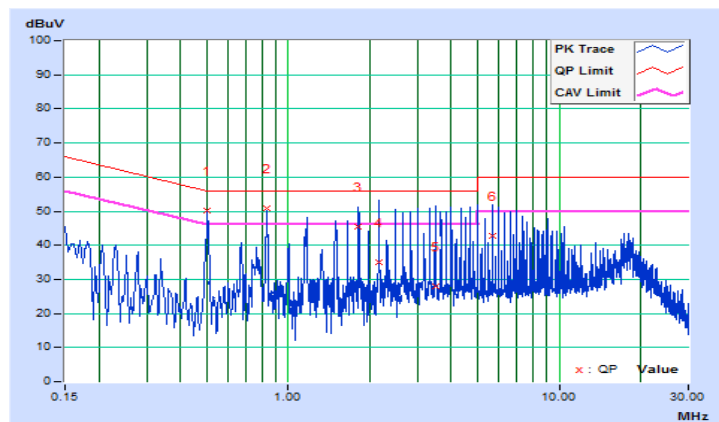

Mode B

Frequency Range	150kHz ~ 30MHz	Detector Function & Resolution Bandwidth	Quasi-Peak (QP) / Average (AV), 9kHz
Input Power	120Vac, 60Hz	Environmental Conditions	25°C, 65%RH
Tested by	Getaz Yang	Test Date	2017/5/27

Phase Of Power : Line (L)										
No	Frequency (MHz)	Correction Factor (dB)	Reading Value (dBuV)		Emission Level (dBuV)		Limit (dBuV)		Margin (dB)	
			Q.P.	AV.	Q.P.	AV.	Q.P.	AV.	Q.P.	AV.
1	0.50200	10.40	29.68	23.82	40.08	34.22	56.00	46.00	-15.92	-11.78
2	0.85000	10.40	35.21	30.91	45.61	41.31	56.00	46.00	-10.39	-4.69
3	1.17000	10.41	11.38	4.45	21.79	14.86	56.00	46.00	-34.21	-31.14
4	1.53000	10.43	37.14	32.99	47.57	43.42	56.00	46.00	-8.43	-2.58
5	2.88200	10.51	35.75	31.21	46.26	41.72	56.00	46.00	-9.74	-4.28
6	4.08200	10.57	36.23	32.23	46.80	42.80	56.00	46.00	-9.20	-3.20

Remarks:

1. Q.P. and AV. are abbreviations of quasi-peak and average individually.
2. The emission levels of other frequencies were very low against the limit.
3. Margin value = Emission level – Limit value
4. Correction factor = Insertion loss + Cable loss
5. Emission Level = Correction Factor + Reading Value

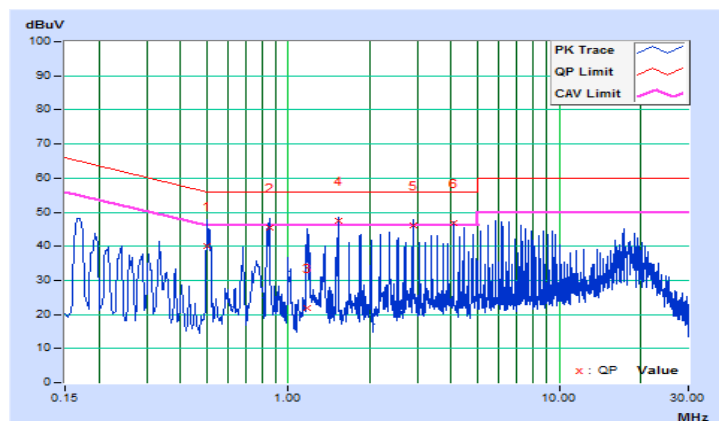

Frequency Range	150kHz ~ 30MHz	Detector Function & Resolution Bandwidth	Quasi-Peak (QP) / Average (AV), 9kHz
Input Power	120Vac, 60Hz	Environmental Conditions	25°C, 65%RH
Tested by	Getaz Yang	Test Date	2017/5/27

Phase Of Power : Neutral (N)										
No	Frequency (MHz)	Correction Factor (dB)	Reading Value (dBuV)		Emission Level (dBuV)		Limit (dBuV)		Margin (dB)	
			Q.P.	AV.	Q.P.	AV.	Q.P.	AV.	Q.P.	AV.
1	0.50600	10.16	36.25	32.00	46.41	42.16	56.00	46.00	-9.59	-3.84
2	0.84909	10.17	41.23	35.20	51.40	45.37	56.00	46.00	-4.60	-0.63
3	1.18600	10.18	34.69	25.28	44.87	35.46	56.00	46.00	-11.13	-10.54
4	1.87158	10.22	36.60	25.53	46.82	35.75	56.00	46.00	-9.18	-10.25
5	2.21000	10.24	41.18	35.17	51.42	45.41	56.00	46.00	-4.58	-0.59
6	2.89400	10.28	24.20	18.85	34.48	29.13	56.00	46.00	-21.52	-16.87

Remarks:

1. Q.P. and AV. are abbreviations of quasi-peak and average individually.
2. The emission levels of other frequencies were very low against the limit.
3. Margin value = Emission level – Limit value
4. Correction factor = Insertion loss + Cable loss
5. Emission Level = Correction Factor + Reading Value

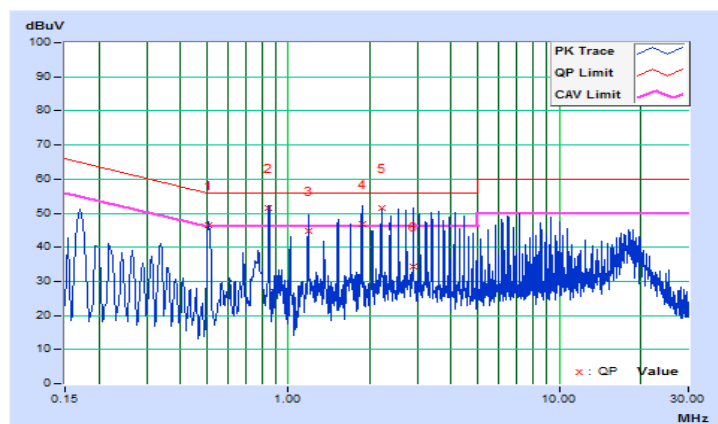

Mode C

Frequency Range	150kHz ~ 30MHz	Detector Function & Resolution Bandwidth	Quasi-Peak (QP) / Average (AV), 9kHz
Input Power	120Vac, 60Hz	Environmental Conditions	25°C, 65%RH
Tested by	Getaz Yang	Test Date	2017/5/27

Phase Of Power : Line (L)										
No	Frequency (MHz)	Correction Factor (dB)	Reading Value (dBuV)		Emission Level (dBuV)		Limit (dBuV)		Margin (dB)	
			Q.P.	AV.	Q.P.	AV.	Q.P.	AV.	Q.P.	AV.
1	0.50600	10.40	29.93	22.17	40.33	32.57	56.00	46.00	-15.67	-13.43
2	0.83798	10.40	35.63	31.93	46.03	42.33	56.00	46.00	-9.97	-3.67
3	1.16600	10.41	36.39	32.84	46.80	43.25	56.00	46.00	-9.20	-2.75
4	1.84600	10.45	34.90	30.90	45.35	41.35	56.00	46.00	-10.65	-4.65
5	2.52600	10.49	11.32	3.53	21.81	14.02	56.00	46.00	-34.19	-31.98
6	4.39000	10.59	10.84	4.69	21.43	15.28	56.00	46.00	-34.57	-30.72

Remarks:

1. Q.P. and AV. are abbreviations of quasi-peak and average individually.
2. The emission levels of other frequencies were very low against the limit.
3. Margin value = Emission level – Limit value
4. Correction factor = Insertion loss + Cable loss
5. Emission Level = Correction Factor + Reading Value

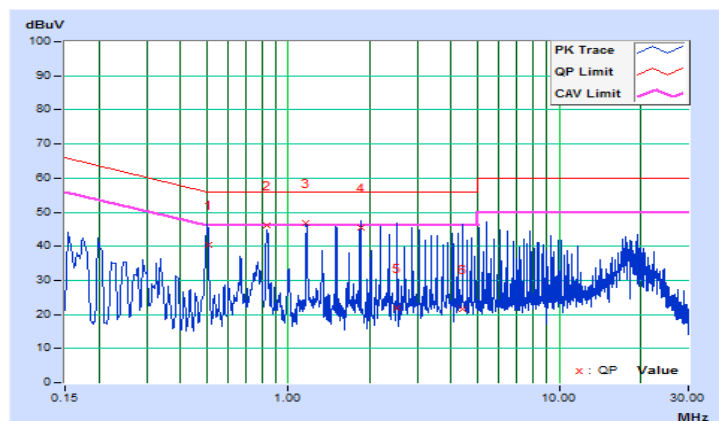

Frequency Range	150kHz ~ 30MHz	Detector Function & Resolution Bandwidth	Quasi-Peak (QP) / Average (AV), 9kHz
Input Power	120Vac, 60Hz	Environmental Conditions	25°C, 65%RH
Tested by	Getaz Yang	Test Date	2017/5/27

Phase Of Power : Neutral (N)										
No	Frequency (MHz)	Correction Factor (dB)	Reading Value (dBuV)		Emission Level (dBuV)		Limit (dBuV)		Margin (dB)	
			Q.P.	AV.	Q.P.	AV.	Q.P.	AV.	Q.P.	AV.
1	0.52200	10.16	28.97	31.34	39.13	41.50	56.00	46.00	-16.87	-4.50
2	0.86200	10.17	25.03	25.14	35.20	35.31	56.00	46.00	-20.80	-10.69
3	1.21000	10.18	16.54	8.35	26.72	18.53	56.00	46.00	-29.28	-27.47
4	1.82600	10.22	15.09	6.83	25.31	17.05	56.00	46.00	-30.69	-28.95
5	2.49000	10.26	17.83	9.39	28.09	19.65	56.00	46.00	-27.91	-26.35
6	3.66600	10.32	16.41	8.30	26.73	18.62	56.00	46.00	-29.27	-27.38

Remarks:

1. Q.P. and AV. are abbreviations of quasi-peak and average individually.
2. The emission levels of other frequencies were very low against the limit.
3. Margin value = Emission level – Limit value
4. Correction factor = Insertion loss + Cable loss
5. Emission Level = Correction Factor + Reading Value

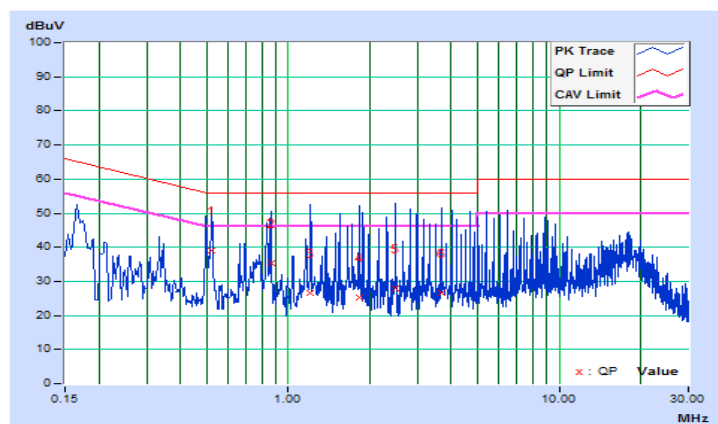

4.3 6 dB Bandwidth Measurement

4.3.1 Limits of 6 dB Bandwidth Measurement

The minimum of 6 dB Bandwidth Measurement is 0.5 MHz.

4.3.2 Test Setup

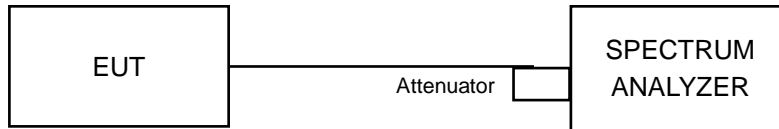

4.3.3 Test Instruments

Refer to section 4.1.2 to get information of above instrument.

4.3.4 Test Procedure

- Set resolution bandwidth (RBW) = 100 kHz
- Set the video bandwidth (VBW) $\geq 3 \times$ RBW, Detector = Peak.
- Trace mode = max hold.
- Sweep = auto couple.
- Measure the maximum width of the emission that is constrained by the frequencies associated with the two amplitude points (upper and lower) that are attenuated by 6 dB relative to the maximum level measured in the fundamental emission

4.3.5 Deviation from Test Standard

No deviation.

4.3.6 EUT Operating Conditions

The software provided by client to enable the EUT under transmission condition continuously at lowest, middle and highest channel frequencies individually.

4.3.7 Test Result

802.11b

Channel	Frequency (MHz)	6 dB Bandwidth (MHz)	Minimum Limit (MHz)	Pass / Fail
1	2412	8.03	0.5	Pass
6	2437	7.13	0.5	Pass
11	2462	7.14	0.5	Pass
12	2467	7.11	0.5	Pass
13	2472	8.03	0.5	Pass

802.11g

Channel	Frequency (MHz)	6 dB Bandwidth (MHz)	Minimum Limit (MHz)	Pass / Fail
1	2412	16.37	0.5	Pass
6	2437	16.41	0.5	Pass
11	2462	16.40	0.5	Pass
12	2467	16.42	0.5	Pass
13	2472	16.42	0.5	Pass

802.11n (HT20)

Channel	Frequency (MHz)	6 dB Bandwidth (MHz)	Minimum Limit (MHz)	Pass / Fail
1	2412	17.60	0.5	Pass
6	2437	17.63	0.5	Pass
11	2462	17.63	0.5	Pass
12	2467	17.62	0.5	Pass
13	2472	17.62	0.5	Pass

Spectrum Plot of Worst Value

802.11b

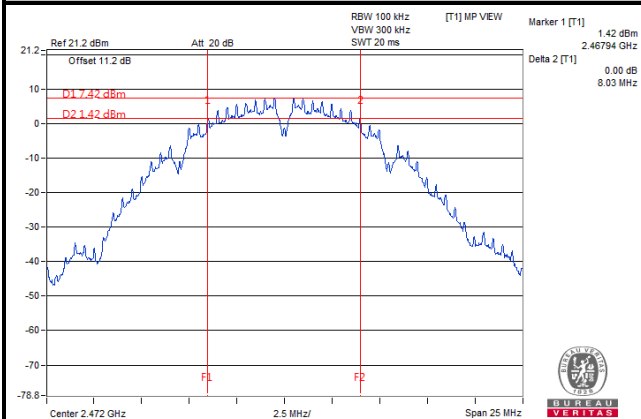

802.11g

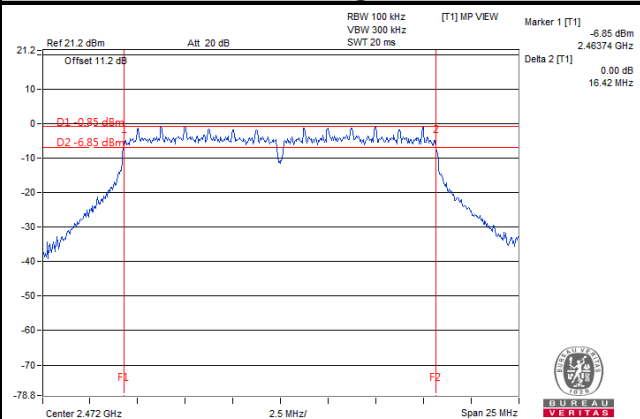

802.11n (HT20)

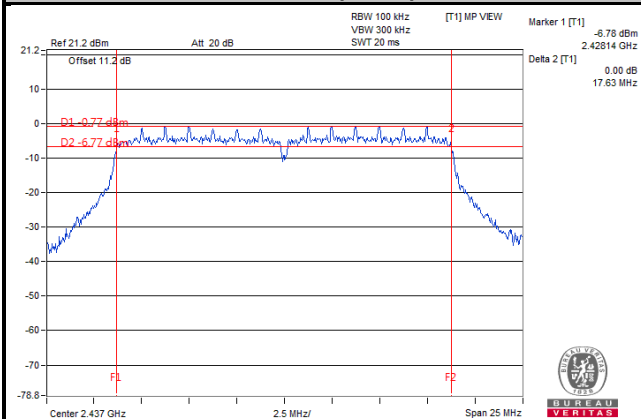

4.4 Conducted Output Power Measurement

4.4.1 Limits of Conducted Output Power Measurement

For systems using digital modulation in the 2400–2483.5 MHz bands: 1 Watt (30 dBm)

4.4.2 Test Setup

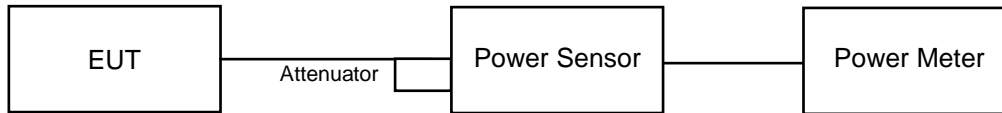

4.4.3 Test Instruments

Refer to section 4.1.2 to get information of above instrument.

4.4.4 Test Procedures

A peak power sensor was used on the output port of the EUT. A power meter was used to read the response of the peak power sensor. Record the power level.

4.4.5 Deviation from Test Standard

No deviation.

4.4.6 EUT Operating Conditions

The software provided by client to enable the EUT under transmission condition continuously at lowest, middle and highest channel frequencies individually.

4.4.7 Test Results

802.11b

Channel	Frequency (MHz)	Peak Power (mW)	Peak Power (dBm)	Limit (dBm)	Pass / Fail
1	2412	63.826	18.05	30	Pass
6	2437	67.298	18.28	30	Pass
11	2462	55.335	17.43	30	Pass
12	2467	55.976	17.48	30	Pass
13	2472	59.429	17.74	30	Pass

802.11g

Channel	Frequency (MHz)	Peak Power (mW)	Peak Power (dBm)	Limit (dBm)	Pass / Fail
1	2412	70.307	18.47	30	Pass
6	2437	73.79	18.68	30	Pass
11	2462	74.473	18.72	30	Pass
12	2467	68.391	18.35	30	Pass
13	2472	65.013	18.13	30	Pass

802.11n (HT20)

Channel	Frequency (MHz)	Peak Power (mW)	Peak Power (dBm)	Limit (dBm)	Pass / Fail
1	2412	66.988	18.26	30	Pass
6	2437	71.285	18.53	30	Pass
11	2462	73.961	18.69	30	Pass
12	2467	73.282	18.65	30	Pass
13	2472	69.984	18.45	30	Pass

4.5 Power Spectral Density Measurement

4.5.1 Limits of Power Spectral Density Measurement

The Maximum of Power Spectral Density Measurement is 8 dBm.

4.5.2 Test Setup

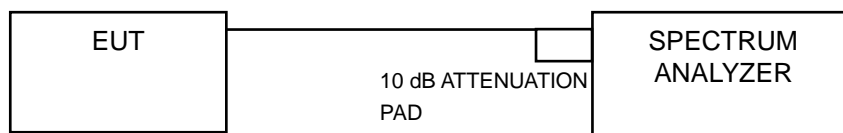

4.5.3 Test Instruments

Refer to section 4.1.2 to get information of above instrument.

4.5.4 Test Procedure

- a. Set analyzer center frequency to DTS channel center frequency.
- b. Set the span to 1.5 times the DTS bandwidth.
- c. Set the RBW to: $3 \text{ kHz} \leq \text{RBW} \leq 100 \text{ kHz}$.
- d. Set the VBW $\geq 3 \times \text{RBW}$.
- e. Detector = peak.
- f. Sweep time = auto couple.
- g. Trace mode = max hold.
- h. Allow trace to fully stabilize.
- i. Use the peak marker function to determine the maximum amplitude level within the RBW.

4.5.5 Deviation from Test Standard

No deviation.

4.5.6 EUT Operating Condition

The software provided by client to enable the EUT under transmission condition continuously at lowest, middle and highest channel frequencies individually.

4.5.7 Test Results

802.11b

Channel	Frequency (MHz)	PSD (dBm/3 kHz)	Limit (dBm/3 kHz)	Pass / Fail
1	2412	-6.76	8	Pass
6	2437	-6.87	8	Pass
11	2462	-7.21	8	Pass
12	2467	-7.13	8	Pass
13	2472	-6.99	8	Pass

802.11g

Channel	Frequency (MHz)	PSD (dBm/3 kHz)	Limit (dBm/3 kHz)	Pass / Fail
1	2412	-15.23	8	Pass
6	2437	-14.69	8	Pass
11	2462	-15.19	8	Pass
12	2467	-15.18	8	Pass
13	2472	-14.76	8	Pass

802.11n (HT20)

Channel	Frequency (MHz)	PSD (dBm/3 kHz)	Limit (dBm/3 kHz)	Pass / Fail
1	2412	-15.55	8	Pass
6	2437	-15.04	8	Pass
11	2462	-15.06	8	Pass
12	2467	-15.21	8	Pass
13	2472	-15.30	8	Pass

Spectrum Plot of Worst Value

802.11b

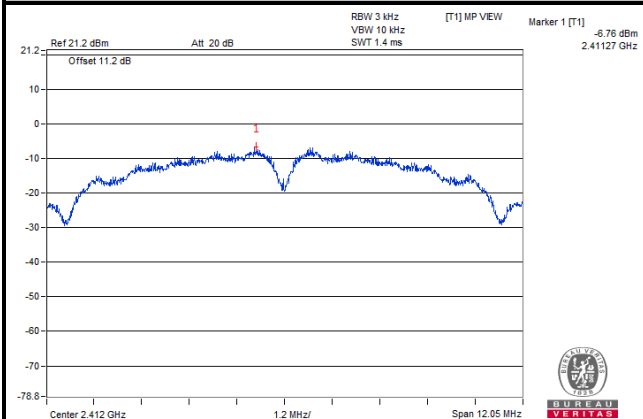

802.11g

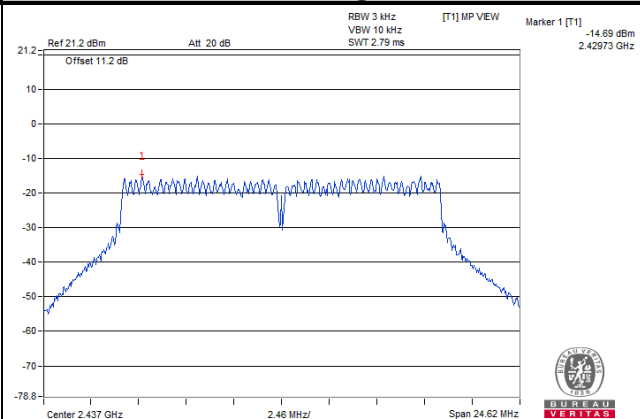

802.11n (HT20)

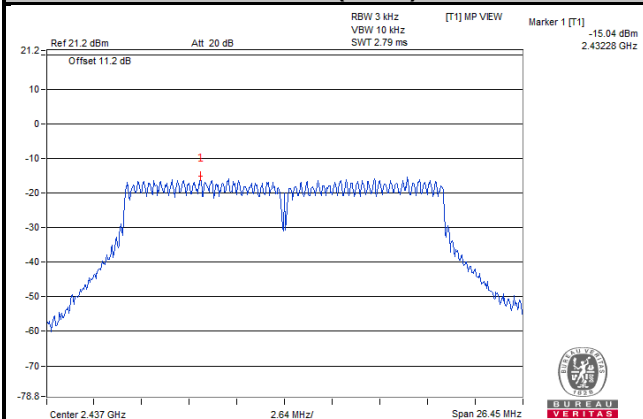

4.6 Conducted Out of Band Emission Measurement

4.6.1 Limits of Conducted Out of Band Emission Measurement

Below 20 dB of the highest emission level of operating band (in 100 kHz Resolution Bandwidth).

4.6.2 Test Setup

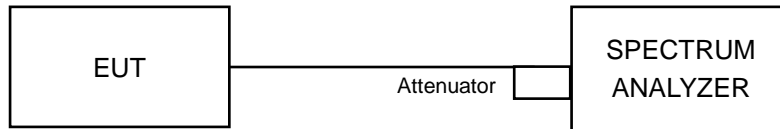

4.6.3 Test Instruments

Refer to section 4.1.2 to get information of above instrument.

4.6.4 Test Procedure

MEASUREMENT PROCEDURE REF

1. Set the RBW = 100 kHz.
2. Set the VBW \geq 300 kHz.
3. Detector = peak.
4. Sweep time = auto couple.
5. Trace mode = max hold.
6. Allow trace to fully stabilize.
7. Use the peak marker function to determine the maximum power level in any 100 kHz band segment within the fundamental EBW.

MEASUREMENT PROCEDURE OOBE

1. Set RBW = 100 kHz.
2. Set VBW \geq 300 kHz.
3. Detector = peak.
4. Sweep = auto couple.
5. Trace Mode = max hold.
6. Allow trace to fully stabilize.
7. Use the peak marker function to determine the maximum amplitude level.

4.6.5 Deviation from Test Standard

No deviation.

4.6.6 EUT Operating Condition

The software provided by client to enable the EUT under transmission condition continuously at lowest, middle and highest channel frequencies individually.

4.6.7 Test Results

The spectrum plots are attached on the following images. D1 line indicates the highest level, and D2 line indicates the 20 dB offset below D1. It shows compliance with the requirement.

802.11b

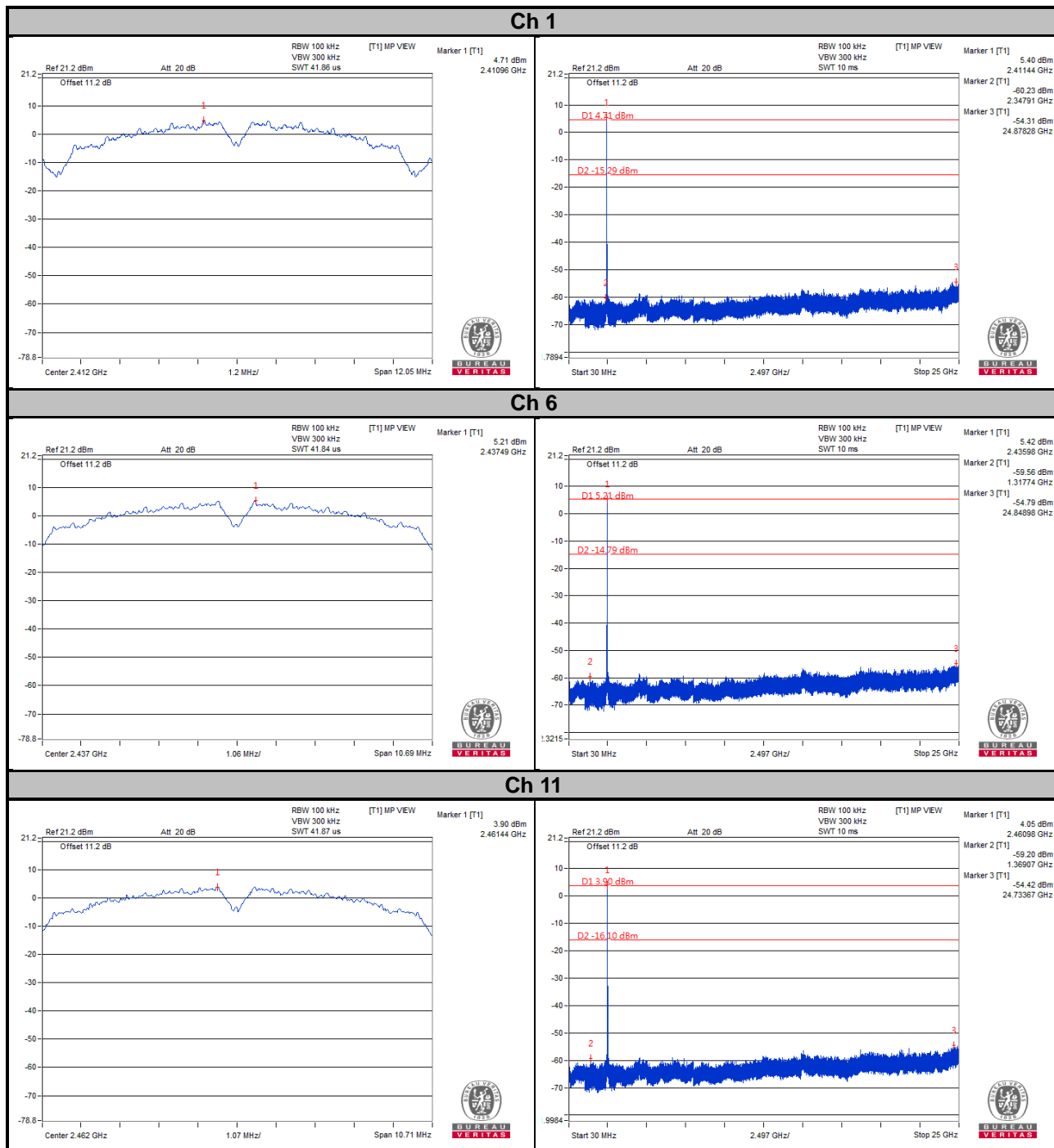

Ch 12

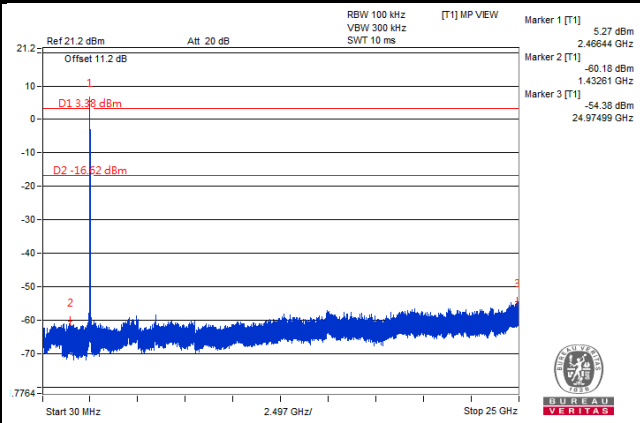
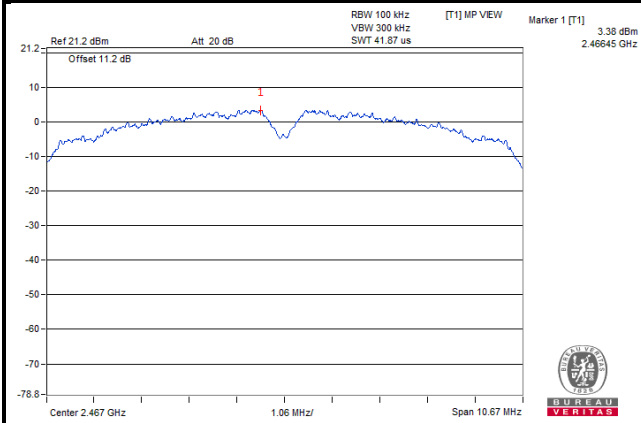

Ch 13

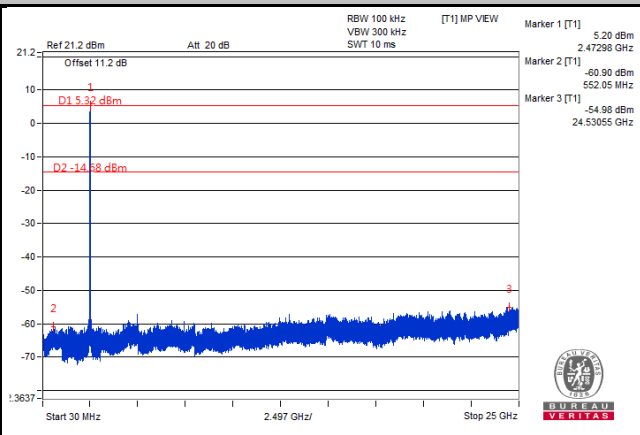
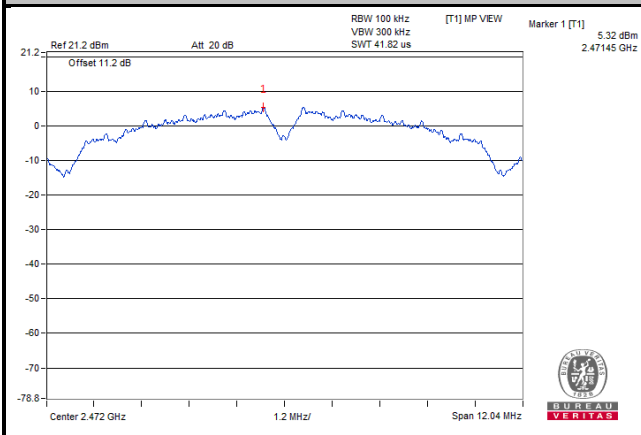

Ch 1 Band Edge

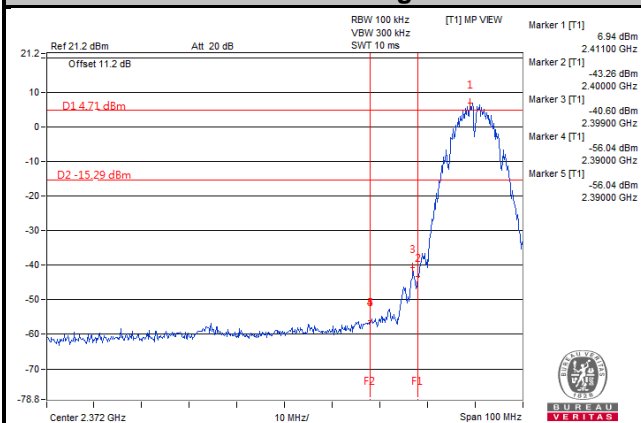

Ch 11 Band Edge

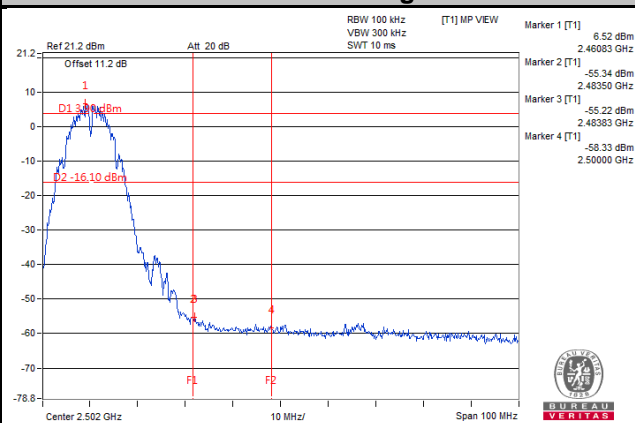

Ch 12 Band Edge

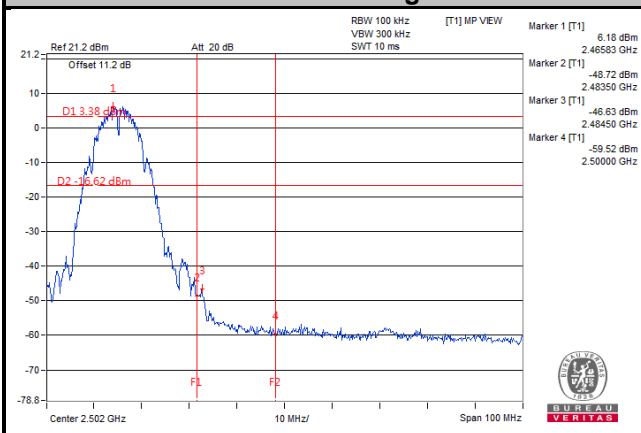

Ch 13 Band Edge

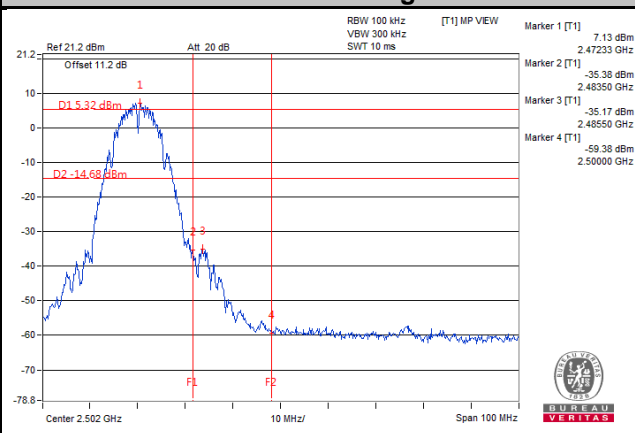

802.11g

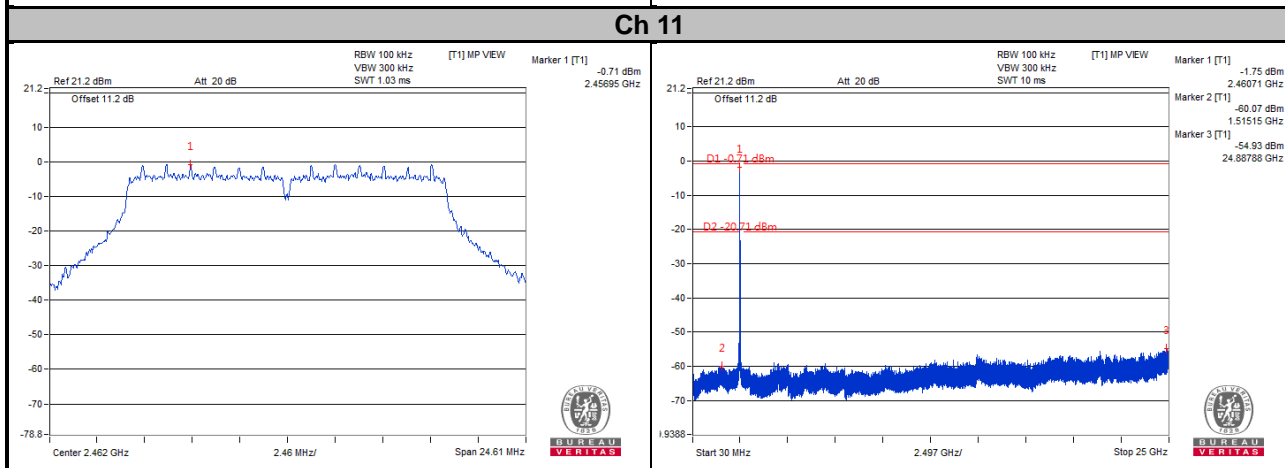
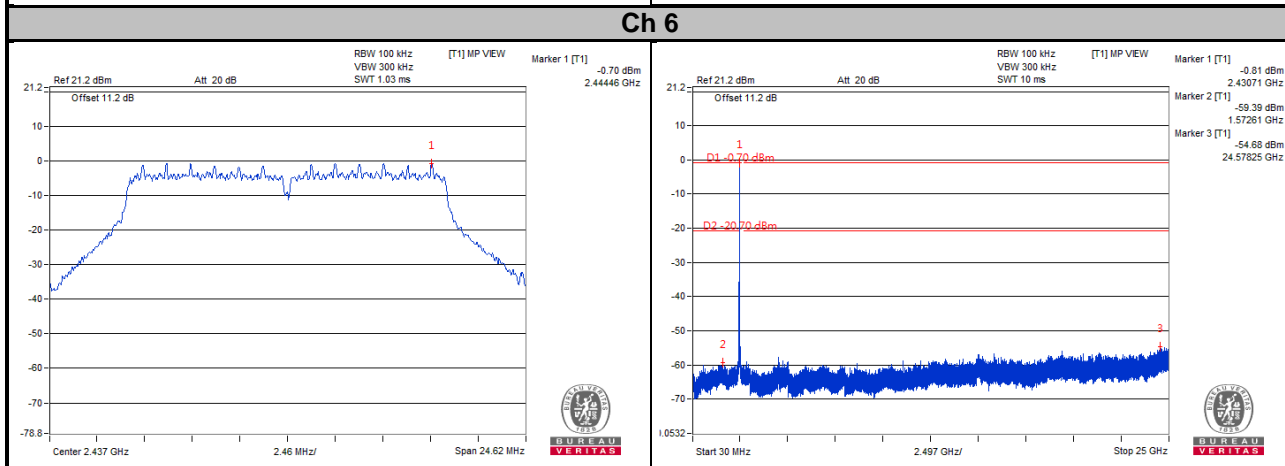
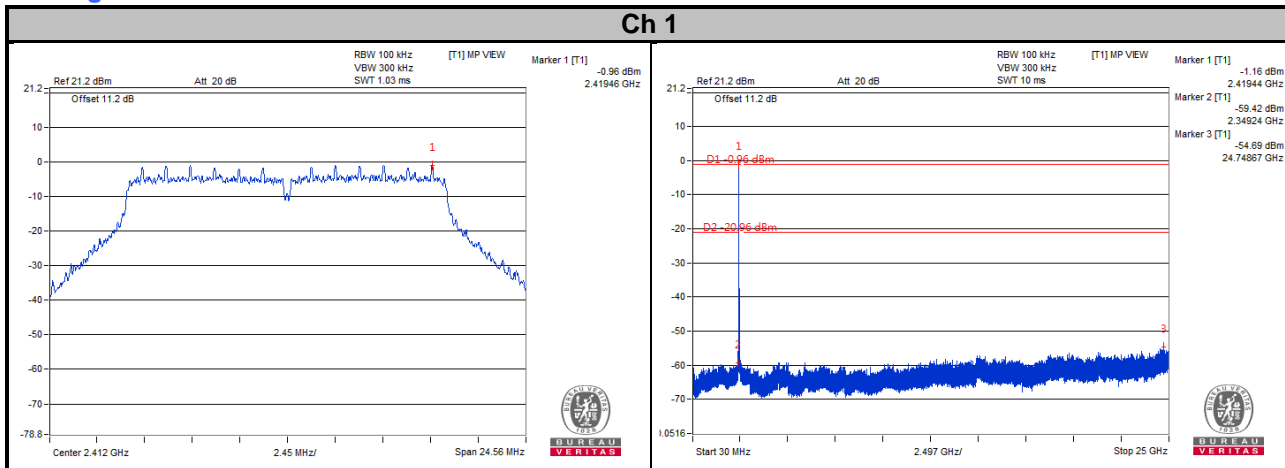

Ch 12

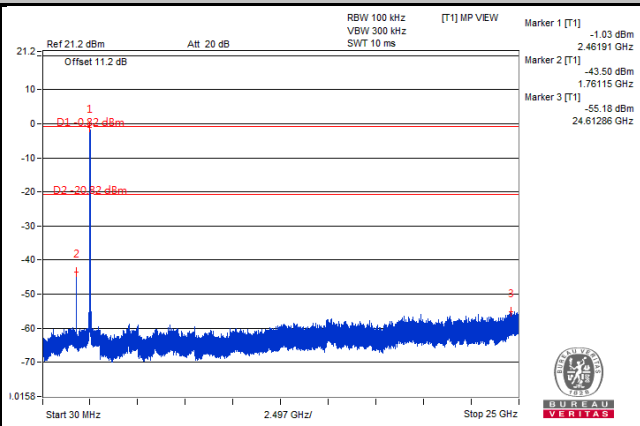
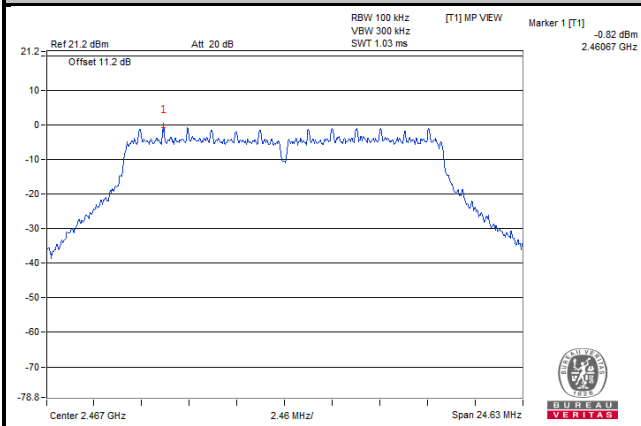

Ch 13

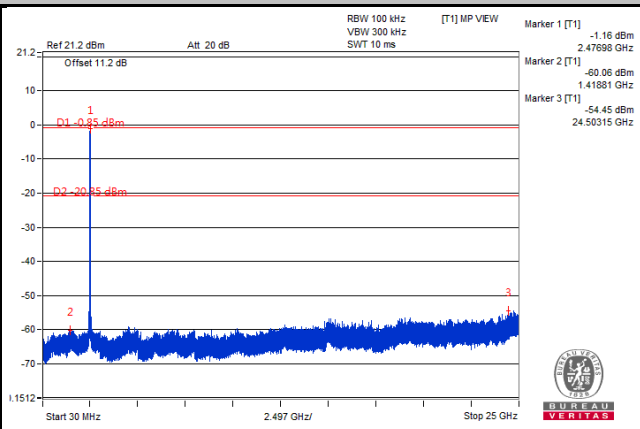
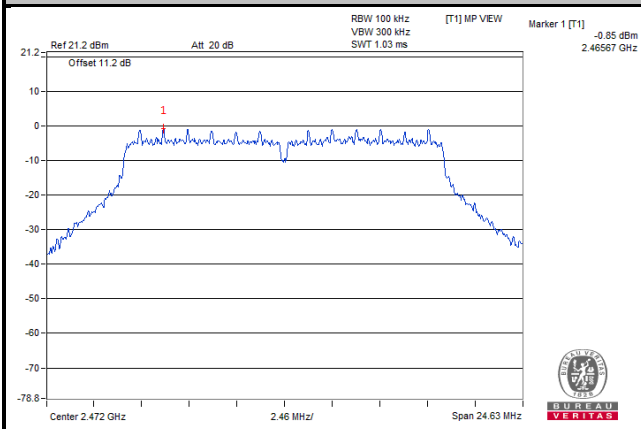

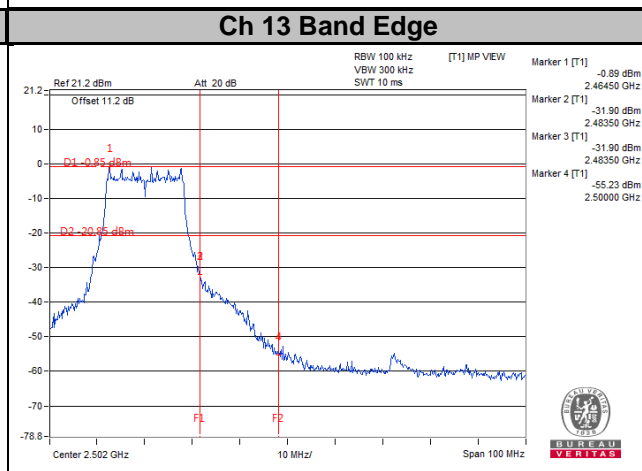
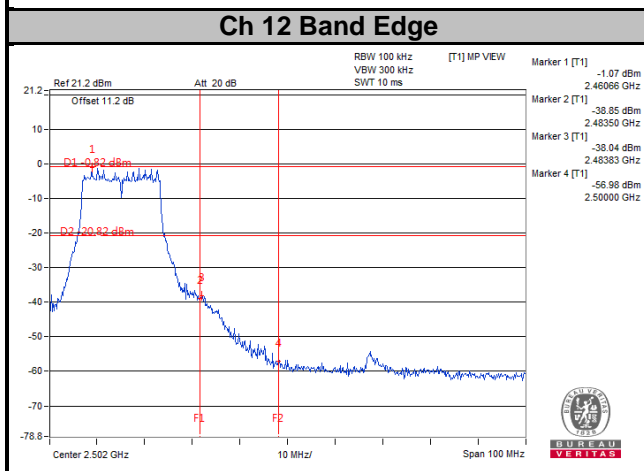
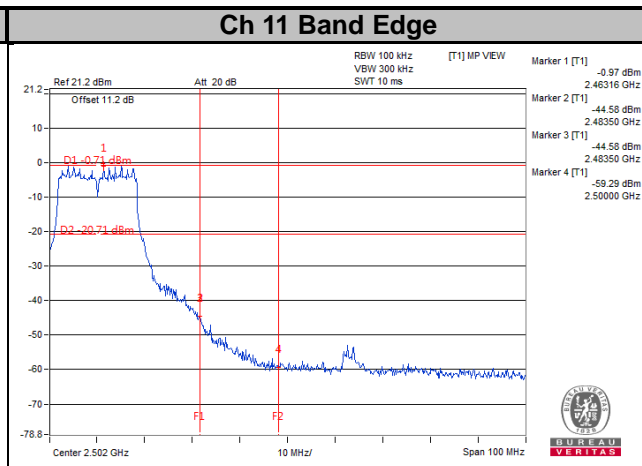
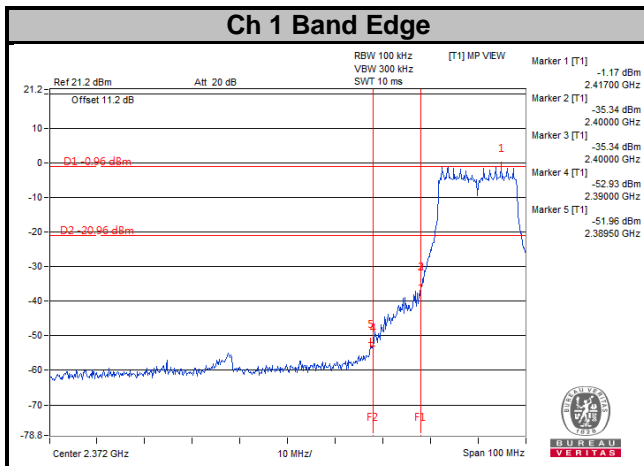

802.11n (HT20)

Ch 1

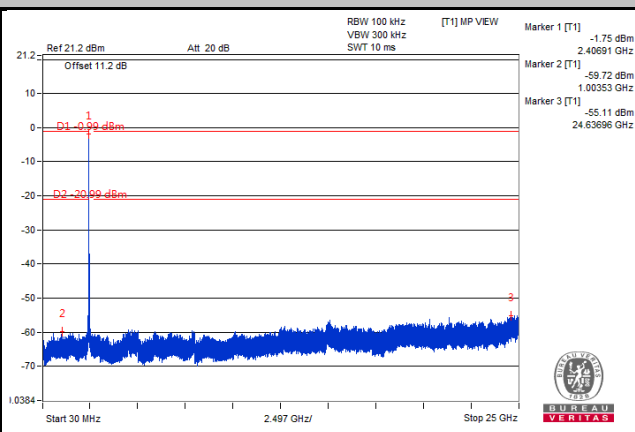
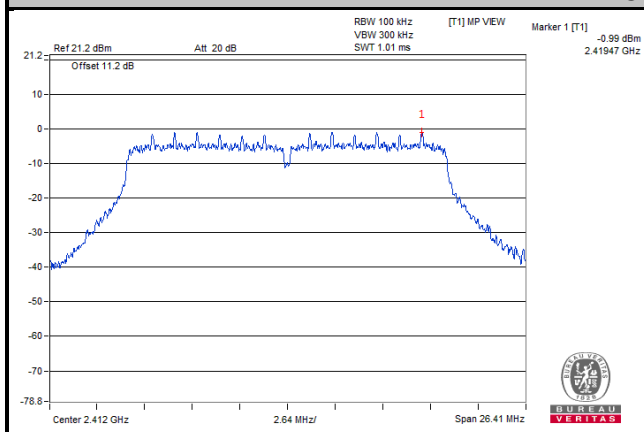

Ch 6

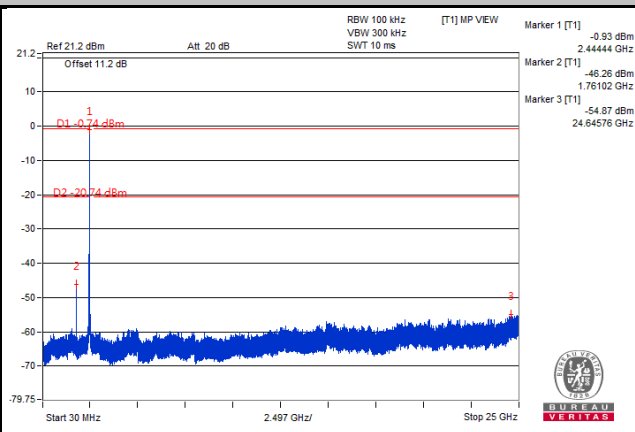
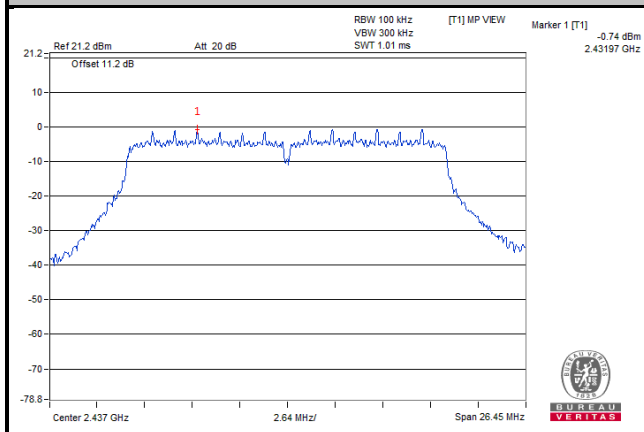

Ch 11

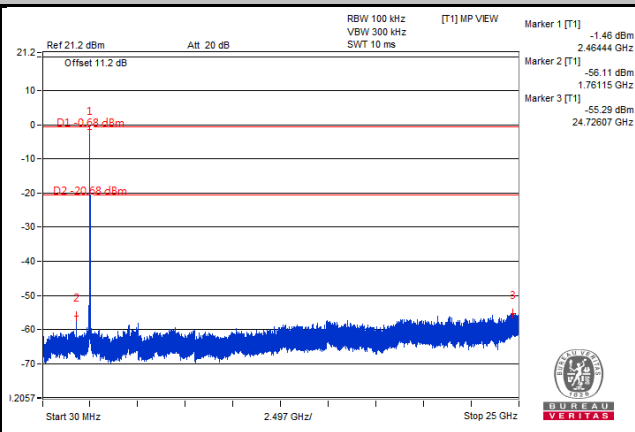
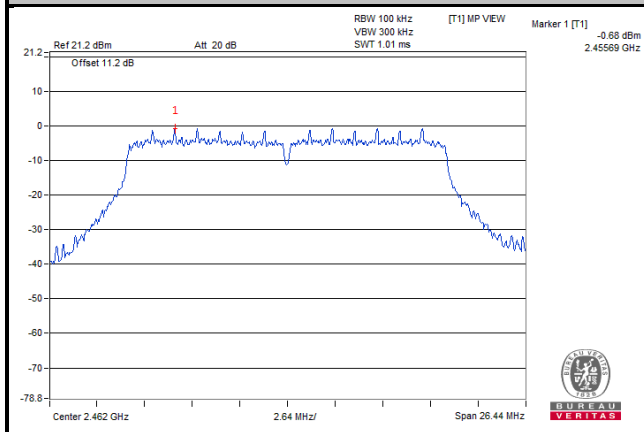

Ch 12

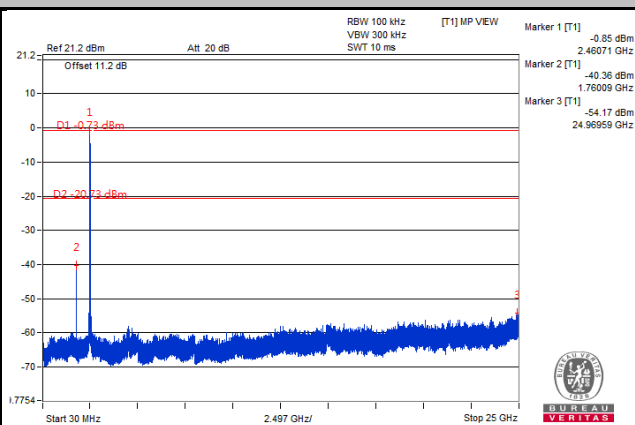
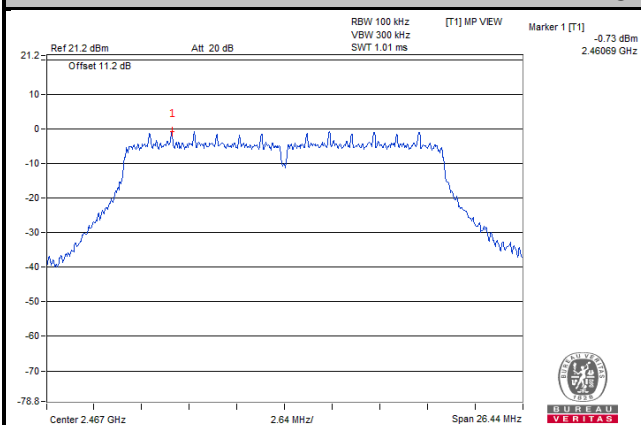

Ch 13

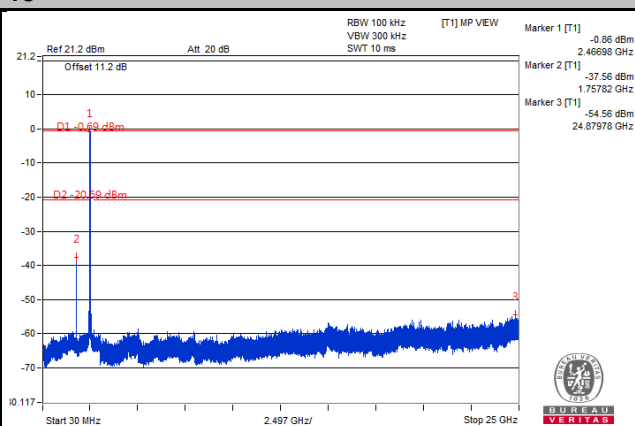
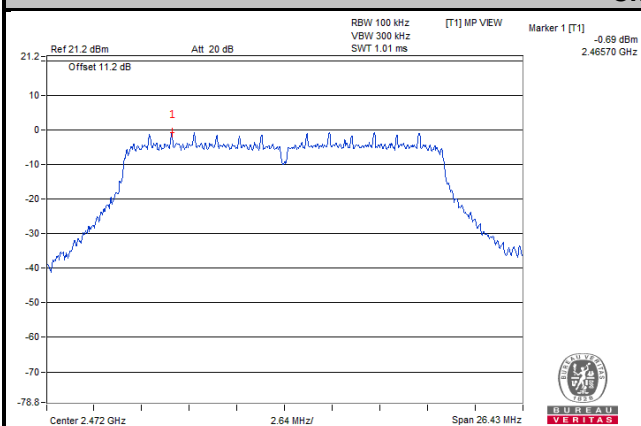

Ch 1 Band Edge

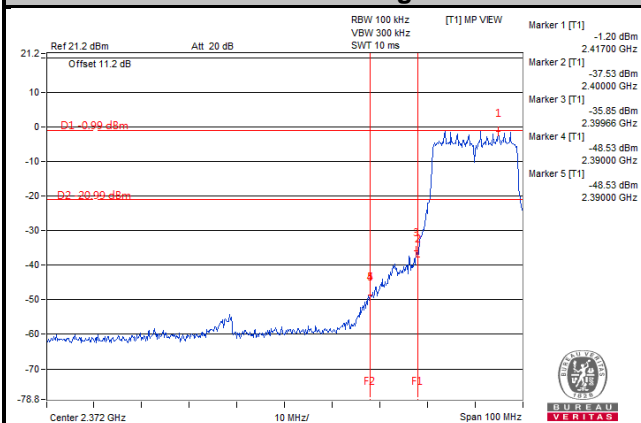

Ch 11 Band Edge

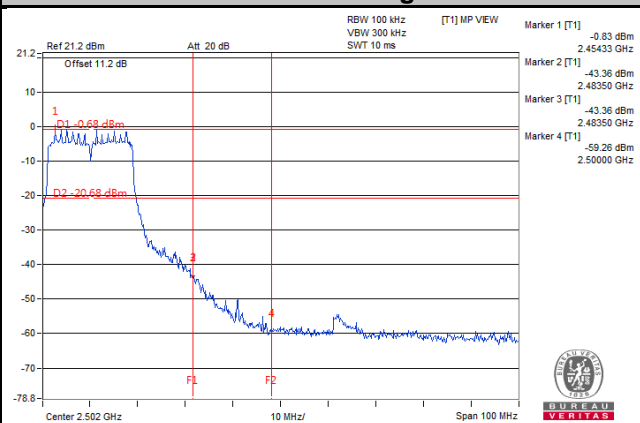

Ch 12 Band Edge

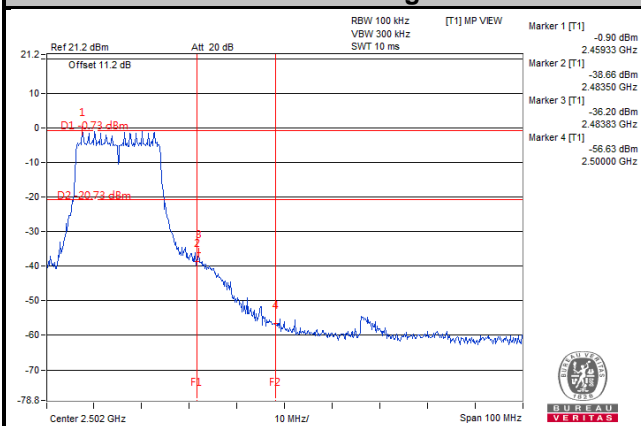

Ch 13 Band Edge

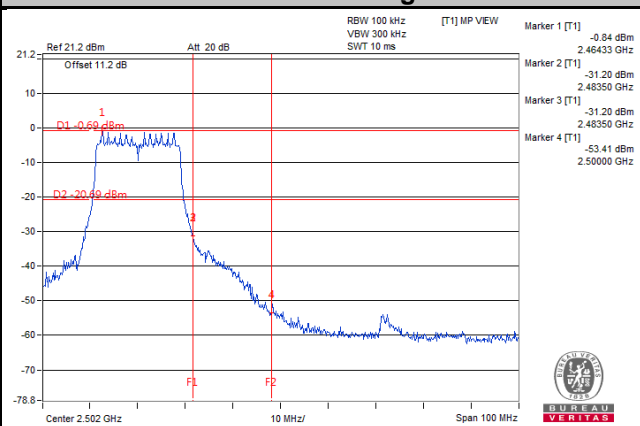

5 Pictures of Test Arrangements

Please refer to the attached file (Test Setup Photo).

Appendix – Information on the Testing Laboratories

We, Bureau Veritas Consumer Products Services (H.K.) Ltd., Taoyuan Branch, were founded in 1988 to provide our best service in EMC, Radio, Telecom and Safety consultation. Our laboratories are accredited and approved according to ISO/IEC 17025.

If you have any comments, please feel free to contact us at the following:

Linko EMC/RF Lab

Tel: 886-2-26052180

Fax: 886-2-26051924

Hsin Chu EMC/RF/Telecom Lab

Tel: 886-3-6668565

Fax: 886-3-6668323

Hwa Ya EMC/RF/Safety Lab

Tel: 886-3-3183232

Fax: 886-3-3270892

Email: service.adt@tw.bureauveritas.com

Web Site: www.bureauveritas-adt.com

The address and road map of all our labs can be found in our web site also.

--- END ---