

FCC Test Report

Report No.: RF170315C40-2

FCC ID: UK7-DW4A

Received Date: Mar. 15, 2017

Test Date: Mar. 28, 2017 ~ May 26, 2017

Issued Date: Jun. 14, 2017

Applicant: Fossil Group, Inc.

Address: 901 S. Central Expwy., Richardson, TX 75080 USA

Issued By: Bureau Veritas Consumer Products Services (H.K.) Ltd., Taoyuan Branch

Lab Address: No. 47-2, 14th Ling, Chia Pau Vil., Lin Kou Dist., New Taipei City, Taiwan
(R.O.C)

Test Location (1): No. 19, Hwa Ya 2nd Rd, Wen Hwa Tsuen, Kwei Shan Hsiang, Taoyuan
Hsien 333, Taiwan, R.O.C.



This report is for your exclusive use. Any copying or replication of this report to or for any other person or entity, or use of our name or trademark, is permitted only with our prior written permission. This report sets forth our findings solely with respect to the test samples identified herein. The results set forth in this report are not indicative or representative of the quality or characteristics of the lot from which a test sample was taken or any similar or identical product unless specifically and expressly noted. Our report includes all of the tests requested by you and the results thereof based upon the information that you provided to us. You have 60 days from date of issuance of this report to notify us of any material error or omission caused by our negligence, provided, however, that such notice shall be in writing and shall specifically address the issue you wish to raise. A failure to raise such issue within the prescribed time shall constitute your unqualified acceptance of the completeness of this report, the tests conducted and the correctness of the report contents. Unless specifically mentioned, the uncertainty of measurement has been explicitly taken into account to declare the compliance or non-compliance to the specification.

Table of Contents

Release Control Record	4
1 Certificate of Conformity	5
2 Summary of Test Results	6
2.1 Measurement Uncertainty	6
2.2 Modification Record	6
3 General Information	7
3.1 General Description of EUT	7
3.2 Description of Test Modes	8
3.2.1 Test Mode Applicability and Tested Channel Detail	9
3.3 Duty Cycle of Test Signal	11
3.4 Description of Support Units	12
3.4.1 Configuration of System under Test	12
3.5 General Description of Applied Standards	12
4 Test Types and Results	13
4.1 Radiated Emission and Bandedge Measurement	13
4.1.1 Limits of Radiated Emission and Bandedge Measurement	13
4.1.2 Test Instruments	14
4.1.3 Test Procedures	15
4.1.4 Deviation from Test Standard	15
4.1.5 Test Set Up	16
4.1.6 EUT Operating Conditions	16
4.1.7 Test Results	17
4.2 Conducted Emission Measurement	69
4.2.1 Limits of Conducted Emission Measurement	69
4.2.2 Test Instruments	69
4.2.3 Test Procedures	70
4.2.4 Deviation from Test Standard	70
4.2.5 Test Setup	70
4.2.6 EUT Operating Conditions	70
4.2.7 Test Results	71
4.3 6dB Bandwidth Measurement	79
4.3.1 Limits of 6dB Bandwidth Measurement	79
4.3.2 Test Setup	79
4.3.3 Test Instruments	79
4.3.4 Test Procedure	79
4.3.5 Deviation from Test Standard	79
4.3.6 EUT Operating Conditions	79
4.3.7 Test Result	80
4.4 Conducted Output Power Measurement	82
4.4.1 Limits of Conducted Output Power Measurement	82
4.4.2 Test Setup	82
4.4.3 Test Instruments	82
4.4.4 Test Procedures	82
4.4.5 Deviation from Test Standard	82
4.4.6 EUT Operating Conditions	82
4.4.7 Test Results	83
4.5 Power Spectral Density Measurement	84
4.5.1 Limits of Power Spectral Density Measurement	84
4.5.2 Test Setup	84
4.5.3 Test Instruments	84
4.5.4 Test Procedure	84
4.5.5 Deviation from Test Standard	84
4.5.6 EUT Operating Condition	84

4.5.7 Test Results	85
4.6 Conducted Out of Band Emission Measurement	87
4.6.1 Limits of Conducted Out of Band Emission Measurement.....	87
4.6.2 Test Setup.....	87
4.6.3 Test Instruments	87
4.6.4 Test Procedure	87
4.6.5 Deviation from Test Standard	87
4.6.6 EUT Operating Condition	87
4.6.7 Test Results	88
5 Pictures of Test Arrangements.....	97
Appendix – Information on the Testing Laboratories	98

Release Control Record

Issue No.	Description	Date Issued
RF170315C40-2	Original Release	Jun. 14, 2017

1 Certificate of Conformity

Product: Smart Watch

Sample Status: Production Unit

Applicant: Fossil Group, Inc.

Test Date: Mar. 28, 2017 ~ May 26, 2017

Standards: 47 CFR FCC Part 15, Subpart C (Section 15.247)
ANSI C63.10:2013

The above equipment has been tested by **Bureau Veritas Consumer Products Services (H.K.) Ltd., Taoyuan Branch**, and found compliance with the requirement of the above standards. The test record, data evaluation & Equipment Under Test (EUT) configurations represented herein are true and accurate accounts of the measurements of the sample's EMC characteristics under the conditions specified in this report.

Prepared by :  _____, **Date:** _____ Jun. 14, 2017
Ivonne Wu / Supervisor

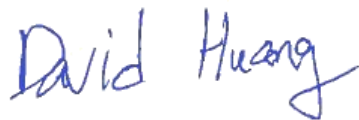
Approved by :  _____, **Date:** _____ Jun. 14, 2017
David Huang / Project Engineer

2 Summary of Test Results

47 CFR FCC Part 15, Subpart C (Section 15.247)			
FCC Clause	Test Item	Result	Remarks
15.207	AC Power Conducted Emission	Pass	Meet the requirement of limit. Minimum passing margin is -0.33 dB at 0.76600 MHz.
15.205 / 15.209 / 15.247(d)	Radiated Emissions and Band Edge Measurement	Pass	Meet the requirement of limit. Minimum passing margin is -2.37 dB at 32.91 MHz.
15.247(d)	Antenna Port Emission	Pass	Meet the requirement of limit.
15.247(a)(2)	6 dB Bandwidth	Pass	Meet the requirement of limit.
15.247(b)	Conducted power	Pass	Meet the requirement of limit.
15.247(e)	Power Spectral Density	Pass	Meet the requirement of limit.
15.203	Antenna Requirement	Pass	No antenna connector is used.

2.1 Measurement Uncertainty

Where relevant, the following measurement uncertainty levels have been estimated for tests performed on the EUT:

The listed uncertainties are the worst case uncertainty for the entire range of measurement. Please note that the uncertainty values are provided for informational purposes only and are not used in determining the PASS/FAIL results.

Measurement	Frequency	Expanded Uncertainty (k=2) (±)
Conducted Emissions at mains ports	150 kHz ~ 30 MHz	2.44 dB
Radiated Emissions up to 1 GHz	30 MHz ~ 200 MHz	2.93 dB
	200 MHz ~ 1000 MHz	2.95 dB
Radiated Emissions above 1 GHz	1 GHz ~ 18 GHz	2.26 dB
	18 GHz ~ 40 GHz	1.94 dB

2.2 Modification Record

There were no modifications required for compliance.

3 General Information

3.1 General Description of EUT

Product	Smart Watch
Status of EUT	Production Unit
Power Supply Rating	5.0 Vdc (from wireless charger) 3.8 Vdc (from battery)
Modulation Type	CCK, DQPSK, DBPSK for DSSS 64QAM, 16QAM, QPSK, BPSK for OFDM
Modulation Technology	DSSS, OFDM
Transfer Rate	802.11b: 11.0 / 5.5 / 2.0 / 1.0 Mbps 802.11g: 54.0 / 48.0 / 36.0 / 24.0 / 18.0 / 12.0 / 9.0 / 6.0 Mbps 802.11n: up to MCS7
Operating Frequency	2412 ~ 2472 MHz
Number of Channel	13 for 802.11b, 802.11g, 802.11n (HT20)
Output Power	81.283 mW
Antenna Type	Loop antenna
Antenna Connector	N/A
Accessory Device	Refer to Note as below
Data Cable Supplied	Refer to Note as below

Note:

- There're 4 configurations for the EUT listed as below.

Sample	Antenna Gain (dBi)	Difference
A	-6.74	The samples are different in the appearance and antenna only.
B	-5.77	
C	-7.1	
D	-6.52	

- The EUT's accessories list refers to Ext. Pho.

3.2 Description of Test Modes

11 channels are provided for 802.11b, 802.11g and 802.11n (HT20):

Channel	Frequency (MHz)	Channel	Frequency (MHz)
1	2412	8	2447
2	2417	9	2452
3	2422	10	2457
4	2427	11	2462
5	2432	12	2467
6	2437	13	2472
7	2442		

3.2.1 Test Mode Applicability and Tested Channel Detail

EUT Configure Mode	Applicable To				Description
	RE \geq 1G	RE<1G	PLC	APCM	
A	√	√	√	√	Sample B
B	√	√	√	-	Sample A
C	√	√	√	-	Sample C
D	√	√	√	-	Sample D

Where **RE \geq 1G**: Radiated Emission above 1 GHz **RE<1G**: Radiated Emission below 1 GHz
PLC: Power Line Conducted Emission **APCM**: Antenna Port Conducted Measurement

NOTE: The EUT had been pre-tested on the positioned of each 3 axis. The worst case was found when positioned on **Z-plane** for sample C and **Y-plane** for sample A&B& D.

NOTE: “-” means no effect.

Radiated Emission Test (Above 1 GHz):

- Pre-Scan has been conducted to determine the worst-case mode from all possible combinations between available modulations, data rates and antenna ports (if EUT with antenna diversity architecture).
- Following channel(s) was (were) selected for the final test as listed below.

EUT Configure Mode	Mode	Available Channel	Tested Channel	Modulation Technology	Modulation Type	Data Rate (Mbps)
A	802.11b	1 to 13	1, 6, 11, 12, 13	DSSS	DBPSK	1.0
	802.11g	1 to 13	1, 6, 11, 12, 13	OFDM	BPSK	6.0
	802.11n (HT20)	1 to 13	1, 6, 11, 12, 13	OFDM	BPSK	MCS0
B, C, D	802.11n (HT20)	1 to 13	13	OFDM	BPSK	MCS0

Radiated Emission Test (Below 1 GHz):

- Pre-Scan has been conducted to determine the worst-case mode from all possible combinations between available modulations, data rates and antenna ports (if EUT with antenna diversity architecture).
- Following channel(s) was (were) selected for the final test as listed below.

EUT Configure Mode	Mode	Available Channel	Tested Channel	Modulation Technology	Modulation Type	Data Rate (Mbps)
A, B, C, D	802.11n (HT20)	1 to 13	13	OFDM	BPSK	MCS0

Power Line Conducted Emission Test:

- Pre-Scan has been conducted to determine the worst-case mode from all possible combinations between available modulations, data rates and antenna ports (if EUT with antenna diversity architecture).
- Following channel(s) was (were) selected for the final test as listed below.

EUT Configure Mode	Mode	Available Channel	Tested Channel	Modulation Technology	Modulation Type	Data Rate (Mbps)
A, B, C, D	802.11n (HT20)	1 to 13	13	OFDM	BPSK	MCS0

Bandedge Measurement:

- Pre-Scan has been conducted to determine the worst-case mode from all possible combinations between available modulations, data rates and antenna ports (if EUT with antenna diversity architecture).
- Following channel(s) was (were) selected for the final test as listed below.

EUT Configure Mode	Mode	Available Channel	Tested Channel	Modulation Technology	Modulation Type	Data Rate (Mbps)
A	802.11b	1 to 13	1, 11, 12, 13	DSSS	DBPSK	1.0
	802.11g	1 to 13	1, 11, 12, 13	OFDM	BPSK	6.0
	802.11n (HT20)	1 to 13	1, 11, 12, 13	OFDM	BPSK	MCS0

Antenna Port Conducted Measurement:

- This item includes all test value of each mode, but only includes spectrum plot of worst value of each mode.
- Pre-Scan has been conducted to determine the worst-case mode from all possible combinations between available modulations, data rates and antenna ports (if EUT with antenna diversity architecture).
- Following channel(s) was (were) selected for the final test as listed below.

EUT Configure Mode	Mode	Available Channel	Tested Channel	Modulation Technology	Modulation Type	Data Rate (Mbps)
A	802.11b	1 to 13	1, 6, 11, 12, 13	DSSS	DBPSK	1.0
	802.11g	1 to 13	1, 6, 11, 12, 13	OFDM	BPSK	6.0
	802.11n (HT20)	1 to 13	1, 6, 11, 12, 13	OFDM	BPSK	MCS0

Test Condition:

Applicable To	Environmental Conditions	Input Power	Tested by
RE≥1G	25 deg. C, 65 % RH	5 Vdc	Getaz Yang
RE<1G	25 deg. C, 65 % RH	5 Vdc	Getaz Yang
PLC	25 deg. C, 65 % RH	5 Vdc	Getaz Yang
APCM	25 deg. C, 65 % RH	3.8 Vdc	Carlos Chen

3.3 Duty Cycle of Test Signal

802.11b: Duty cycle of test signal is 100 %

802.11g: Duty cycle = $1.362/1.563 = 0.871$, Duty factor = $10 * \log(1/0.871) = 0.60$

802.11n (HT20): Duty cycle = $1.282/1.483 = 0.864$, Duty factor = $10 * \log(1/0.864) = 0.63$



3.4 Description of Support Units

The EUT has been tested as an independent unit together with other necessary accessories or support units. The following support units or accessories were used to form a representative test configuration during the tests.

No.	Product	Brand	Model No.	Serial No.	FCC ID
1.	Adapter	XIAOMI	MDY-08-EF	N/A	N/A

No.	Signal Cable Description Of The Above Support Units
1.	N/A

Note:

1. All power cords of the above support units are non-shielded (1.8m).

3.4.1 Configuration of System under Test

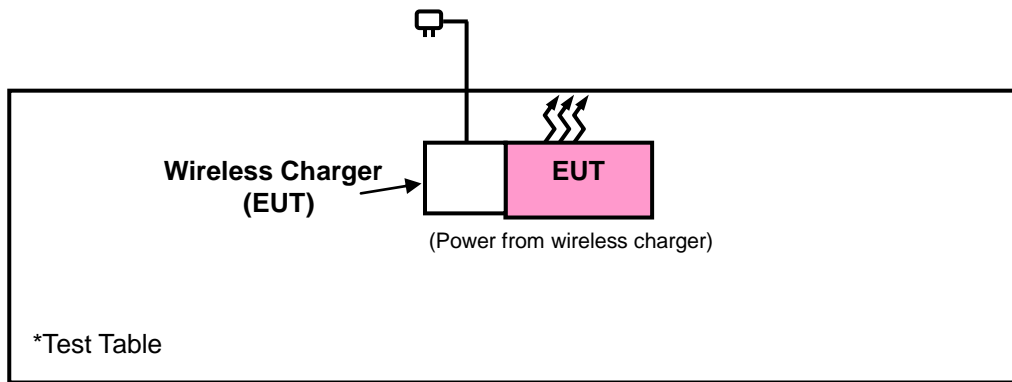

3.5 General Description of Applied Standards

The EUT is a RF Product. According to the specifications of the manufacturer, it must comply with the requirements of the following standards:

FCC Part 15, Subpart C (15.247)

558074 D01 DTS Meas Guidance v04

ANSI C63.10-2013

All test items have been performed and recorded as per the above standards.

NOTE: The EUT has been verified to comply with the requirements of FCC Part 15, Subpart B, Class B (Verification). The test report has been issued separately.

4 Test Types and Results

4.1 Radiated Emission and Bandedge Measurement

4.1.1 Limits of Radiated Emission and Bandedge Measurement

Radiated emissions which fall in the restricted bands must comply with the radiated emission limits specified as below table. Other emissions shall be at least 20 dB below the highest level of the desired power:

Frequencies (MHz)	Field Strength (microvolts/meter)	Measurement Distance (meters)
0.009 ~ 0.490	2400/F (kHz)	300
0.490 ~ 1.705	24000/F (kHz)	30
1.705 ~ 30.0	30	30
30 ~ 88	100	3
88 ~ 216	150	3
216 ~ 960	200	3
Above 960	500	3

NOTE:

1. The lower limit shall apply at the transition frequencies.
2. Emission level (dBuV/m) = 20 log Emission level (uV/m).
3. For frequencies above 1000 MHz, the field strength limits are based on average detector, however, the peak field strength of any emission shall not exceed the maximum permitted average limits, specified above by more than 20 dB under any condition of modulation.

4.1.2 Test Instruments

Description & Manufacturer	Model No.	Serial No.	Date of Calibration	Due Date of Calibration
Test Receiver Agilent	N9038A	MY51210203	Feb. 17, 2017	Feb. 16, 2018
Spectrum Analyzer Agilent	N9010A	MY52220314	Dec. 16, 2016	Dec. 15, 2017
Spectrum Analyzer ROHDE & SCHWARZ	FSU43	101261	Dec. 13, 2016	Dec. 12, 2017
BILOG Antenna SCHWARZBECK	VULB9168	9168-472	Dec. 26, 2016	Dec. 27, 2017
HORN Antenna SCHWARZBECK	BBHA 9120 D	9120D-969	Dec. 12, 2016	Dec. 13, 2017
HORN Antenna SCHWARZBECK	BBHA 9170	9170-480	Dec. 14, 2016	Dec. 13, 2017
Fixed Attenuator Mini-Circuits	BW-N10W5+	NA	Jul. 08, 2016	Jul. 07, 2017
Loop Antenna	EM-6879	269	Aug. 11, 2016	Aug. 10, 2017
Bluetooth Tester	CBT	100946	Jul. 29, 2016	Jul. 28, 2018
Preamplifier EMCI	EMC 012645	980115	Oct. 21, 2016	Oct. 20, 2017
Preamplifier EMCI	EMC 184045	980116	Oct. 21, 2016	Oct. 20, 2017
Preamplifier EMCI	EMC 330H	980112	Oct. 21, 2016	Oct. 20, 2017
Power Meter Anritsu	ML2495A	1232002	Sep. 08, 2016	Sep. 07, 2017
Power Sensor Anritsu	MA2411B	1207325	Sep. 08, 2016	Sep. 07, 2017
RF signal cable HUBER+SUHNNER	SUCOFLEX 104	309219/4 2950114	Oct. 21, 2016	Oct. 20, 2017
RF signal cable HUBER+SUHNNER	SUCOFLEX 104	250130/4	Oct. 21, 2016	Oct. 20, 2017
RF Coaxial Cable Worken	8D-FB	Cable-Ch10-01	Oct. 21, 2016	Oct. 20, 2017
Software BV ADT	E3 6.120103	NA	NA	NA
Antenna Tower MF	MFA-440H	NA	NA	NA
Turn Table MF	MFT-201SS	NA	NA	NA
Antenna Tower & Turn Table Controller MF	MF-7802	NA	NA	NA

- Note: 1. The calibration interval of the above test instruments is 12 months and the calibrations are traceable to NML/ROC and NIST/USA.
2. The test was performed in HwaYa Chamber 10.
3. The horn antenna and preamplifier (model: EMC 184045) are used only for the measurement of emission frequency above 1 GHz if tested.
4. The FCC Site Registration No. is 690701.
5. The IC Site Registration No. is IC7450F-10.

4.1.3 Test Procedures

- a. The EUT was placed on the top of a rotating table 0.8 meters (for below 1 GHz) / 1.5 meters (for above 1 GHz) above the ground at 3 meter chamber room for test. The table was rotated 360 degrees to determine the position of the highest radiation.
- b. The EUT was set 3 meters away from the interference-receiving antenna, which was mounted on the top of a variable-height antenna tower.
- c. The height of antenna is varied from one meter to four meters above the ground to determine the maximum value of the field strength. Both horizontal and vertical polarizations of the antenna are set to make the measurement.
- d. For each suspected emission, the EUT was arranged to its worst case and then the antenna was tuned to heights from 1 meter to 4 meters and the rotatable table was turned from 0 degrees to 360 degrees to find the maximum reading.
- e. The test-receiver system was set to quasi-peak detect function and specified bandwidth with maximum hold mode when the test frequency is below 1 GHz.
- f. The test-receiver system was set to peak and average detected function and specified bandwidth with maximum hold mode when the test frequency is above 1 GHz. If the peak reading value also meets average limit, measurement with the average detector is unnecessary.

Note:

1. The resolution bandwidth and video bandwidth of test receiver/spectrum analyzer is 120 kHz & 360 KHz for Quasi-peak detection (QP) at frequency below 1 GHz.
2. The resolution bandwidth of test receiver/spectrum analyzer is 1 MHz and the video bandwidth is 3 MHz for Peak detection (PK) at frequency above 1 GHz.
3. The resolution bandwidth of test receiver/spectrum analyzer is 1 MHz and the video bandwidth is 1/T for Average (Duty cycle < 98 %) detection at frequency above 1 GHz.
4. The resolution bandwidth of test receiver/spectrum analyzer is 1 MHz and the video bandwidth is 10 Hz (Duty cycle \geq 98 %) for Average detection (AV) at frequency above 1 GHz.
5. All modes of operation were investigated and the worst-case emissions are reported.

4.1.4 Deviation from Test Standard

No deviation.

4.1.5 Test Set Up

<Frequency Range below 1 GHz>

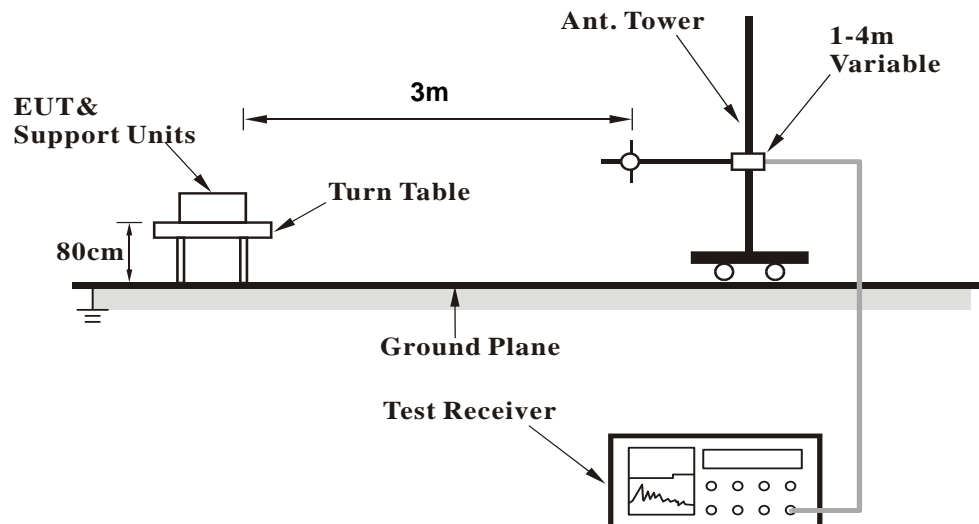

<Frequency Range above 1 GHz>

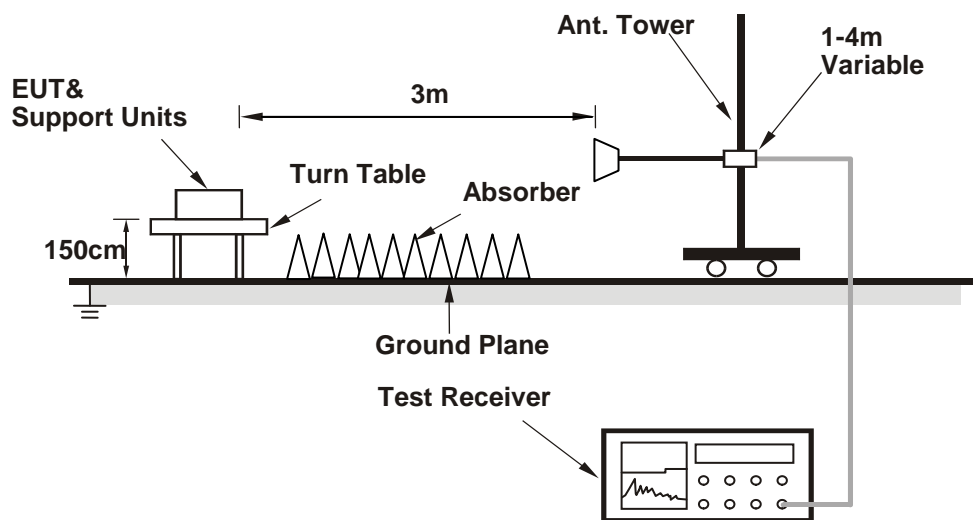

For the actual test configuration, please refer to the attached file (Test Setup Photo).

4.1.6 EUT Operating Conditions

- Placed the EUT on a testing table.
- Use the software to control the EUT under transmission condition continuously at specific channel frequency.

4.1.7 Test Results

Above 1 GHz Data :

Mode A

802.11b

EUT Test Condition		Measurement Detail	
Channel	Channel 1	Frequency Range	1 GHz ~ 25 GHz
Input Power	120 Vac, 60 Hz	Detector Function	Peak (PK) Average (AV)
Environmental Conditions	25 deg. C, 65 % RH	Tested By	Getaz Yang

Horizontal

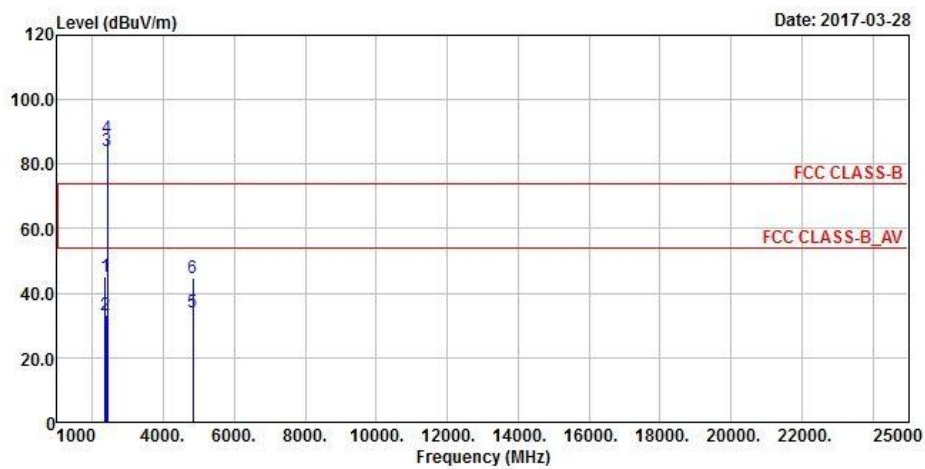

Vertical

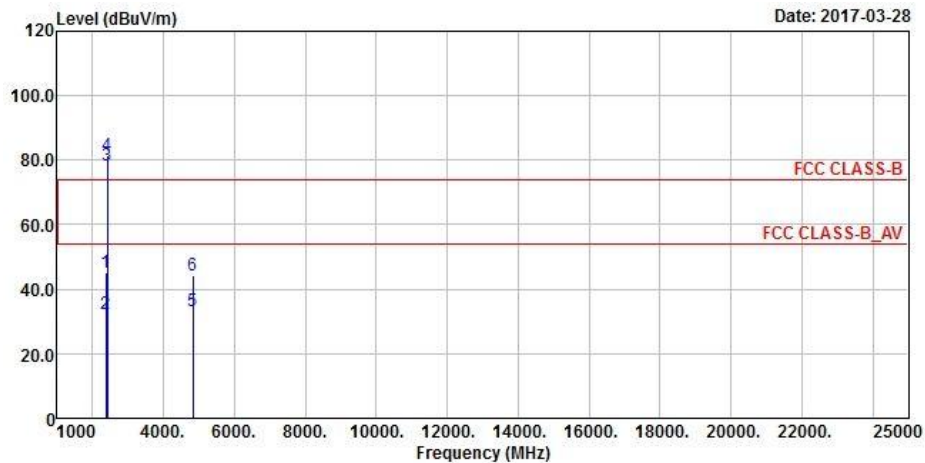

Antennal Polarity & Test Distance: Horizontal at 3 m

Frequency (MHz)	Emission Level (dBuV/m)	Read Level (dBuV)	Limit (dBuV/m)	Margin (dB)	Antenna Factor (dB/m)	Cable Loss (dB)	Preamp Factor (dB)	Antenna Height (cm)	Table Angle (Degree)	Remark
2349.25	45.16	51.83	74	-28.84	26.77	4.05	37.49	200	12	Peak
2371.88	33.24	39.81	54	-20.76	26.86	4.07	37.5	200	12	Average
2412	84.12	90.59			26.96	4.09	37.52	200	12	Average
2412	88.32	94.79			26.96	4.09	37.52	200	12	Peak
4824	34.22	49.52	54	-19.78	30.99	6.79	53.08	115	90	Average
4824	44.92	60.22	74	-29.08	30.99	6.79	53.08	115	90	Peak

Antennal Polarity & Test Distance: Vertical at 3 m

Frequency (MHz)	Emission Level (dBuV/m)	Read Level (dBuV)	Limit (dBuV/m)	Margin (dB)	Antenna Factor (dB/m)	Cable Loss (dB)	Preamp Factor (dB)	Antenna Height (cm)	Table Angle (Degree)	Remark
2370.99	45.36	51.99	74	-28.64	26.81	4.05	37.49	155	192	Peak
2381.19	32.15	38.71	54	-21.85	26.86	4.08	37.5	155	192	Average
2412	78.56	85.03			26.96	4.09	37.52	155	192	Average
2412	81.57	88.04			26.96	4.09	37.52	155	192	Peak
4824	33.25	48.55	54	-20.75	30.99	6.79	53.08	110	294	Average
4824	44.11	59.41	74	-29.89	30.99	6.79	53.08	110	294	Peak

Remarks:

- Emission Level = Read Level + Antenna Factor + Cable Loss - Preamp Factor
Margin value = Emission level – Limit value
- 2412 MHz: Fundamental frequency.

EUT Test Condition		Measurement Detail	
Channel	Channel 6	Frequency Range	1 GHz ~ 25 GHz
Input Power	120 Vac, 60 Hz	Detector Function	Peak (PK) Average (AV)
Environmental Conditions	25 deg. C, 65 % RH	Tested By	Getaz Yang

Horizontal

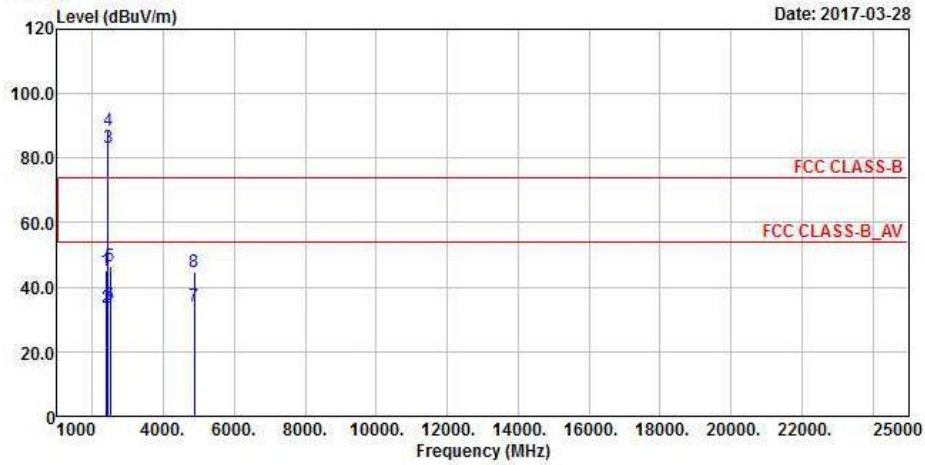

Vertical

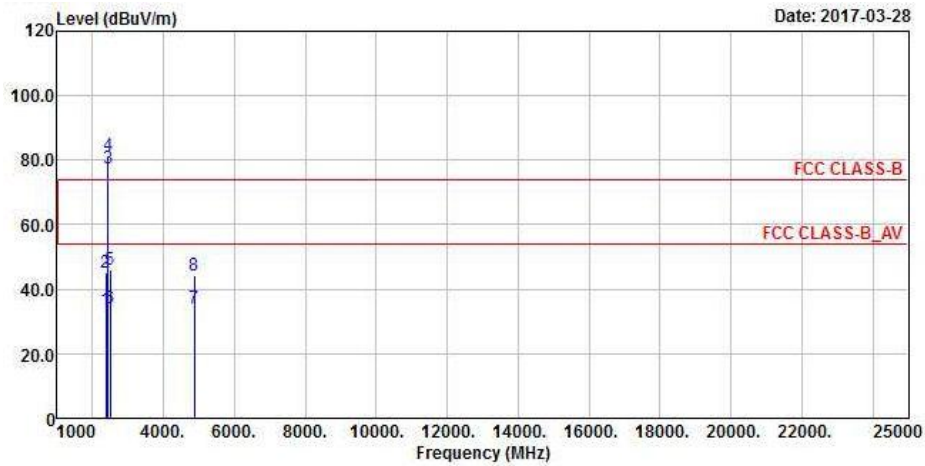

Antennal Polarity & Test Distance: Horizontal at 3 m

Frequency (MHz)	Emission Level (dBuV/m)	Read Level (dBuV)	Limit (dBuV/m)	Margin (dB)	Antenna Factor (dB/m)	Cable Loss (dB)	Preamp Factor (dB)	Antenna Height (cm)	Table Angle (Degree)	Remark
2377.15	45.22	51.79	74	-28.78	26.86	4.07	37.5	199	31	Peak
2388.09	33.54	40.05	54	-20.46	26.91	4.08	37.5	199	31	Average
2437	83.21	89.49			27.06	4.12	37.46	199	31	Average
2437	88.44	94.72			27.06	4.12	37.46	199	31	Peak
2488.19	46.44	52.4	74	-27.56	27.2	4.16	37.32	199	31	Peak
2492.36	34.71	40.6	54	-19.29	27.2	4.16	37.25	199	31	Average
4874	34.25	49.39	54	-19.75	31.06	6.85	53.05	120	99	Average
4874	44.79	59.93	74	-29.21	31.06	6.85	53.05	120	99	Peak

Antennal Polarity & Test Distance: Vertical at 3 m

Frequency (MHz)	Emission Level (dBuV/m)	Read Level (dBuV)	Limit (dBuV/m)	Margin (dB)	Antenna Factor (dB/m)	Cable Loss (dB)	Preamp Factor (dB)	Antenna Height (cm)	Table Angle (Degree)	Remark
2366.17	33.45	40.07	54	-20.55	26.81	4.07	37.5	114	166	Average
2377.1	45.22	51.79	74	-28.78	26.86	4.07	37.5	114	166	Peak
2437	77.33	83.61			27.06	4.12	37.46	114	166	Average
2437	81.49	87.77			27.06	4.12	37.46	114	166	Peak
2485	46.22	52.24	74	-27.78	27.15	4.15	37.32	114	166	Peak
2492.16	34.26	40.15	54	-19.74	27.2	4.16	37.25	114	166	Average
4874	34.15	49.29	54	-19.85	31.06	6.85	53.05	107	346	Average
4874	44.22	59.36	74	-29.78	31.06	6.85	53.05	107	346	Peak

Remarks:

- Emission Level = Read Level + Antenna Factor + Cable Loss - Preamp Factor
Margin value = Emission level – Limit value
- 2437 MHz: Fundamental frequency.

EUT Test Condition		Measurement Detail	
Channel	Channel 11	Frequency Range	1 GHz ~ 25 GHz
Input Power	120 Vac, 60 Hz	Detector Function	Peak (PK) Average (AV)
Environmental Conditions	25 deg. C, 65 % RH	Tested By	Getaz Yang

Horizontal

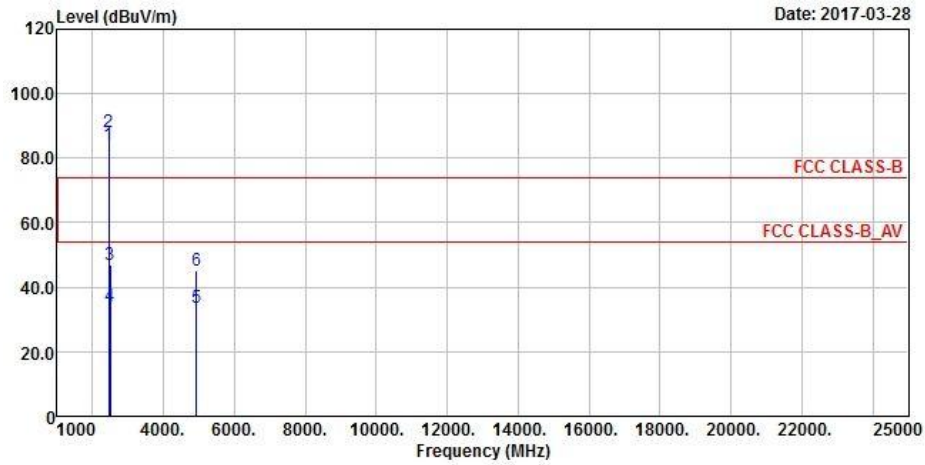

Vertical

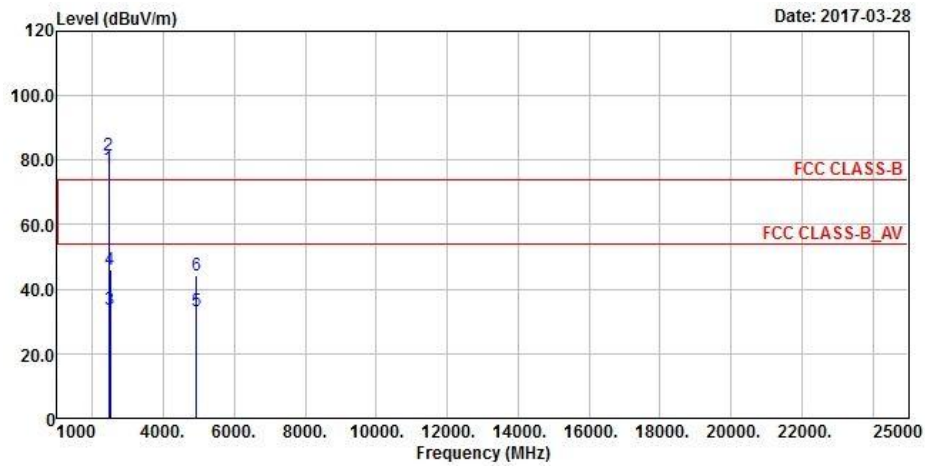

Antennal Polarity & Test Distance: Horizontal at 3 m

Frequency (MHz)	Emission Level (dBuV/m)	Read Level (dBuV)	Limit (dBuV/m)	Margin (dB)	Antenna Factor (dB/m)	Cable Loss (dB)	Preamp Factor (dB)	Antenna Height (cm)	Table Angle (Degree)	Remark
2462	84.26	90.42			27.1	4.13	37.39	114	88	Average
2462	88.09	94.25			27.1	4.13	37.39	114	88	Peak
2497.55	46.79	52.68	74	-27.21	27.2	4.16	37.25	114	88	Peak
2497.58	34.02	40.04	54	-19.98	27.15	4.15	37.32	114	88	Average
4924	33.44	48.47	54	-20.56	31.12	6.88	53.03	110	45	Average
4924	44.99	60.02	74	-29.01	31.12	6.88	53.03	110	45	Peak

Antennal Polarity & Test Distance: Vertical at 3 m

Frequency (MHz)	Emission Level (dBuV/m)	Read Level (dBuV)	Limit (dBuV/m)	Margin (dB)	Antenna Factor (dB/m)	Cable Loss (dB)	Preamp Factor (dB)	Antenna Height (cm)	Table Angle (Degree)	Remark
2462	77.39	83.55			27.1	4.13	37.39	125	191	Average
2462	81.39	87.55			27.1	4.13	37.39	125	191	Peak
2483.33	33.78	39.8	54	-20.22	27.15	4.15	37.32	125	191	Average
2494.66	45.88	51.77	74	-28.12	27.2	4.16	37.25	125	191	Peak
4924	33.32	48.35	54	-20.68	31.12	6.88	53.03	108	315	Average
4924	44.26	59.29	74	-29.74	31.12	6.88	53.03	108	315	Peak

Remarks:

- Emission Level = Read Level + Antenna Factor + Cable Loss - Preamp Factor
Margin value = Emission level – Limit value
- 2462 MHz: Fundamental frequency.

EUT Test Condition		Measurement Detail	
Channel	Channel 12	Frequency Range	1 GHz ~ 25 GHz
Input Power	120 Vac, 60 Hz	Detector Function	Peak (PK) Average (AV)
Environmental Conditions	25 deg. C, 65 % RH	Tested By	Getaz Yang

Horizontal

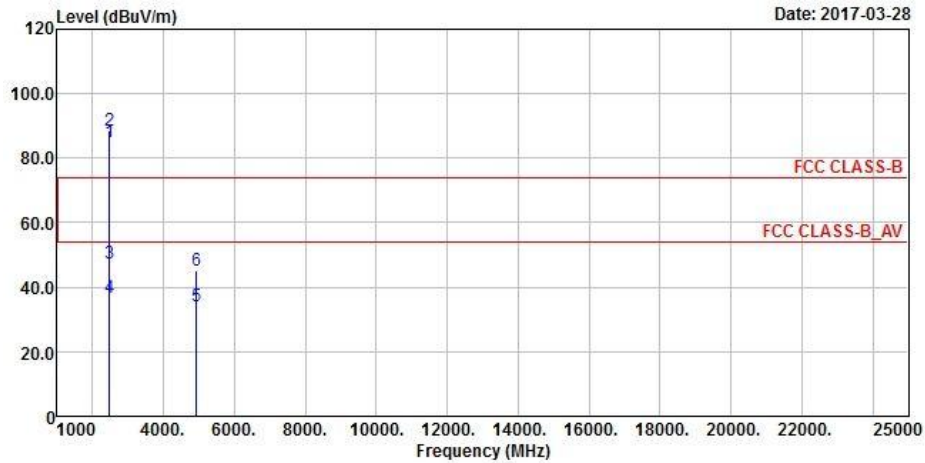

Vertical

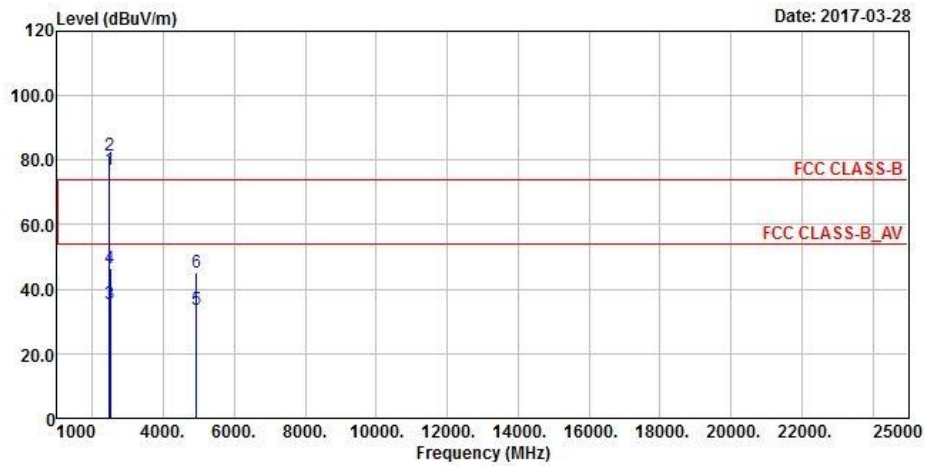

Antennal Polarity & Test Distance: Horizontal at 3 m

Frequency (MHz)	Emission Level (dBuV/m)	Read Level (dBuV)	Limit (dBuV/m)	Margin (dB)	Antenna Factor (dB/m)	Cable Loss (dB)	Preamp Factor (dB)	Antenna Height (cm)	Table Angle (Degree)	Remark
2467	85.02	91.11			27.1	4.13	37.32	139	72	Average
2467	88.65	94.74			27.1	4.13	37.32	139	72	Peak
2483.19	36.58	42.6	54	-17.42	27.15	4.15	37.32	139	72	Average
2483.48	47.26	53.28	74	-26.74	27.15	4.15	37.32	139	72	Peak
4934	33.94	48.97	54	-20.06	31.12	6.88	53.03	110	51	Average
4934	45.36	60.39	74	-28.64	31.12	6.88	53.03	110	51	Peak

Antennal Polarity & Test Distance: Vertical at 3 m

Frequency (MHz)	Emission Level (dBuV/m)	Read Level (dBuV)	Limit (dBuV/m)	Margin (dB)	Antenna Factor (dB/m)	Cable Loss (dB)	Preamp Factor (dB)	Antenna Height (cm)	Table Angle (Degree)	Remark
2467	77.21	83.3			27.1	4.13	37.32	155	199	Average
2467	81.29	87.38			27.1	4.13	37.32	155	199	Peak
2483.87	35.45	41.47	54	-18.55	27.15	4.15	37.32	155	199	Average
2484.1	46.47	52.49	74	-27.53	27.15	4.15	37.32	155	199	Peak
4934	33.68	48.71	54	-20.32	31.12	6.88	53.03	112	339	Average
4934	45.03	60.06	74	-28.97	31.12	6.88	53.03	112	339	Peak

Remarks:

- Emission Level = Read Level + Antenna Factor + Cable Loss - Preamp Factor
Margin value = Emission level – Limit value
- 2467 MHz: Fundamental frequency.

EUT Test Condition		Measurement Detail	
Channel	Channel 13	Frequency Range	1 GHz ~ 25 GHz
Input Power	120 Vac, 60 Hz	Detector Function	Peak (PK) Average (AV)
Environmental Conditions	25 deg. C, 65 % RH	Tested By	Getaz Yang

Horizontal

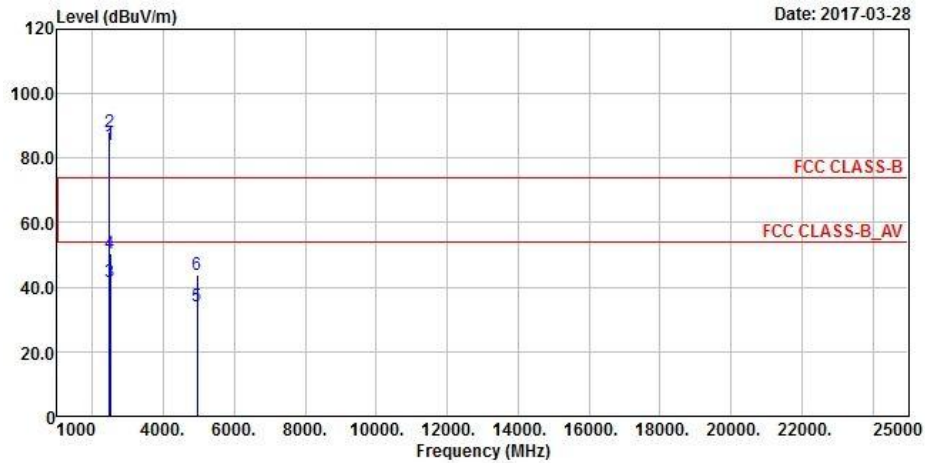

Vertical

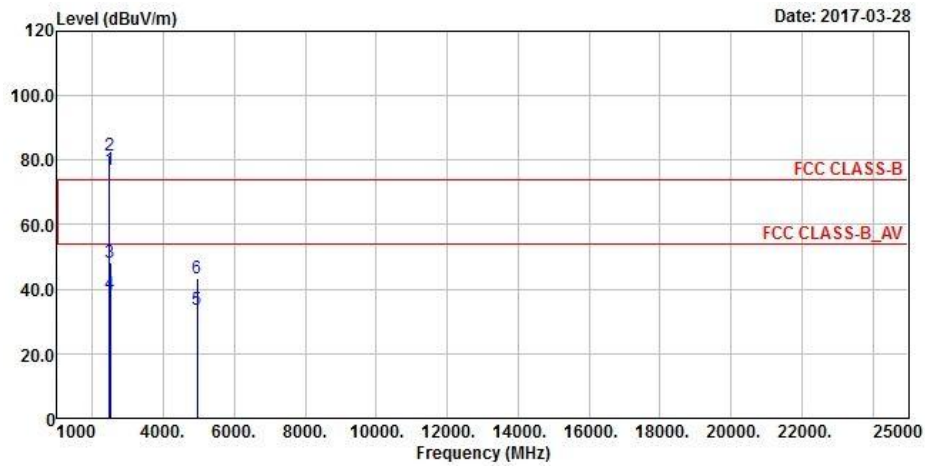

Antennal Polarity & Test Distance: Horizontal at 3 m

Frequency (MHz)	Emission Level (dBuV/m)	Read Level (dBuV)	Limit (dBuV/m)	Margin (dB)	Antenna Factor (dB/m)	Cable Loss (dB)	Preamp Factor (dB)	Antenna Height (cm)	Table Angle (Degree)	Remark
2472	84.22	90.24			27.15	4.15	37.32	120	66	Average
2472	88.32	94.34			27.15	4.15	37.32	120	66	Peak
2485.56	41.56	47.58	54	-12.44	27.15	4.15	37.32	120	66	Average
2485.77	50.68	56.7	74	-23.32	27.15	4.15	37.32	120	66	Peak
4944	33.92	48.91	54	-20.08	31.14	6.91	53.04	112	115	Average
4944	43.93	58.92	74	-30.07	31.14	6.91	53.04	112	115	Peak

Antennal Polarity & Test Distance: Vertical at 3 m

Frequency (MHz)	Emission Level (dBuV/m)	Read Level (dBuV)	Limit (dBuV/m)	Margin (dB)	Antenna Factor (dB/m)	Cable Loss (dB)	Preamp Factor (dB)	Antenna Height (cm)	Table Angle (Degree)	Remark
2472	77.25	83.27			27.15	4.15	37.32	177	155	Average
2472	81.62	87.64			27.15	4.15	37.32	177	155	Peak
2485.36	48.36	54.38	74	-25.64	27.15	4.15	37.32	177	155	Peak
2485.95	38.71	44.73	54	-15.29	27.15	4.15	37.32	177	155	Average
4944	33.74	48.73	54	-20.26	31.14	6.91	53.04	112	300	Average
4944	43.19	58.18	74	-30.81	31.14	6.91	53.04	112	300	Peak

Remarks:

- Emission Level = Read Level + Antenna Factor + Cable Loss - Preamp Factor
Margin value = Emission level – Limit value
- 2472 MHz: Fundamental frequency.

802.11g

EUT Test Condition		Measurement Detail	
Channel	Channel 1	Frequency Range	1 GHz ~ 25 GHz
Input Power	120 Vac, 60 Hz	Detector Function	Peak (PK) Average (AV)
Environmental Conditions	25 deg. C, 65 % RH	Tested By	Getaz Yang

Horizontal

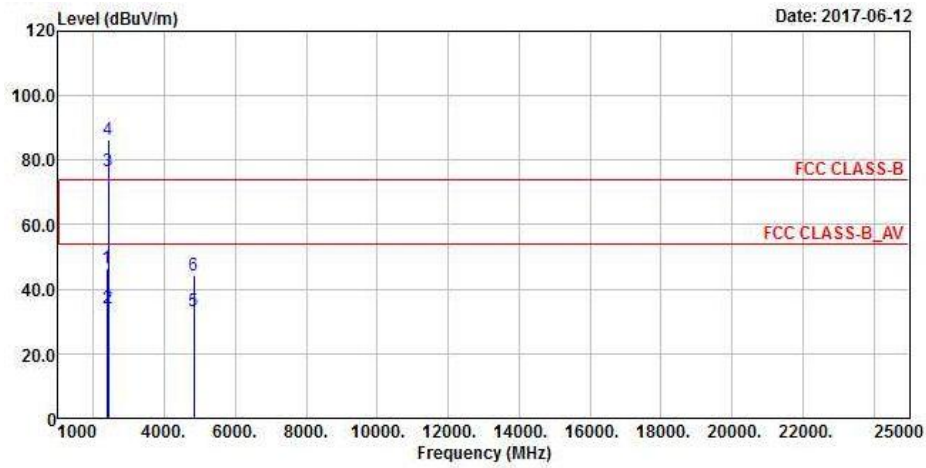

Vertical

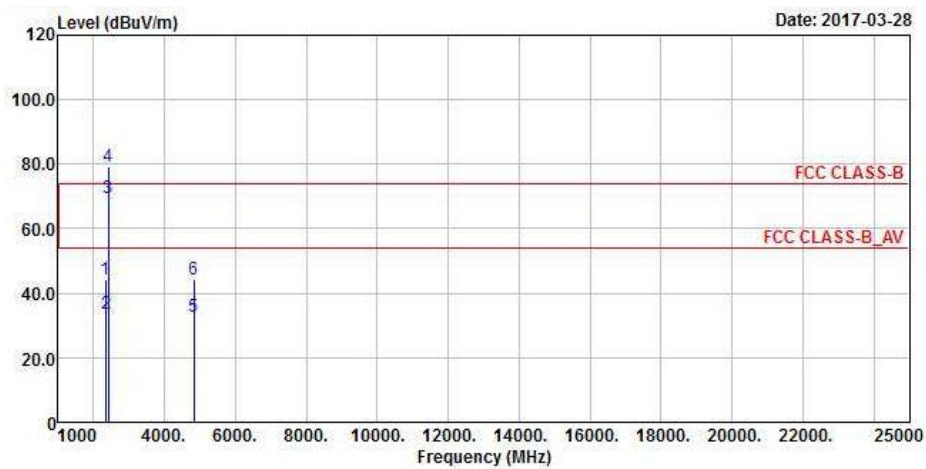

Antennal Polarity & Test Distance: Horizontal at 3 m

Frequency (MHz)	Emission Level (dBuV/m)	Read Level (dBuV)	Limit (dBuV/m)	Margin (dB)	Antenna Factor (dB/m)	Cable Loss (dB)	Preamp Factor (dB)	Antenna Height (cm)	Table Angle (Degree)	Remark
2367.15	46.55	53.17	74	-27.45	26.81	4.07	37.5	131	55	Peak
2386.18	34.31	40.87	54	-19.69	26.86	4.08	37.5	131	55	Average
2412	76.42	82.89			26.96	4.09	37.52	131	55	Average
2412	86.39	92.86			26.96	4.09	37.52	131	55	Peak
4824	33.12	48.42	54	-20.88	30.99	6.79	53.08	119	77	Average
4824	44.45	59.75	74	-29.55	30.99	6.79	53.08	119	77	Peak

Antennal Polarity & Test Distance: Vertical at 3 m

Frequency (MHz)	Emission Level (dBuV/m)	Read Level (dBuV)	Limit (dBuV/m)	Margin (dB)	Antenna Factor (dB/m)	Cable Loss (dB)	Preamp Factor (dB)	Antenna Height (cm)	Table Angle (Degree)	Remark
2334	44.36	51.07	74	-29.64	26.72	4.04	37.47	112	45	Peak
2349.22	33.47	40.14	54	-20.53	26.77	4.05	37.49	112	45	Average
2412	69.55	76.02			26.96	4.09	37.52	112	45	Average
2412	79.24	85.71			26.96	4.09	37.52	112	45	Peak
4824	32.89	48.19	54	-21.11	30.99	6.79	53.08	115	331	Average
4824	44.06	59.36	74	-29.94	30.99	6.79	53.08	115	331	Peak

Remarks:

- Emission Level = Read Level + Antenna Factor + Cable Loss - Preamp Factor
Margin value = Emission level – Limit value
- 2412 MHz: Fundamental frequency.

EUT Test Condition		Measurement Detail	
Channel	Channel 6	Frequency Range	1 GHz ~ 25 GHz
Input Power	120 Vac, 60 Hz	Detector Function	Peak (PK) Average (AV)
Environmental Conditions	25 deg. C, 65 % RH	Tested By	Getaz Yang

Horizontal

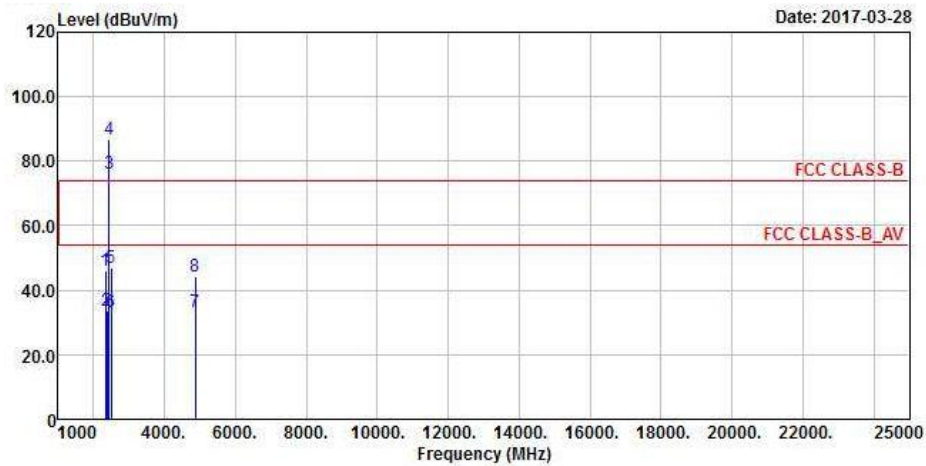

Vertical

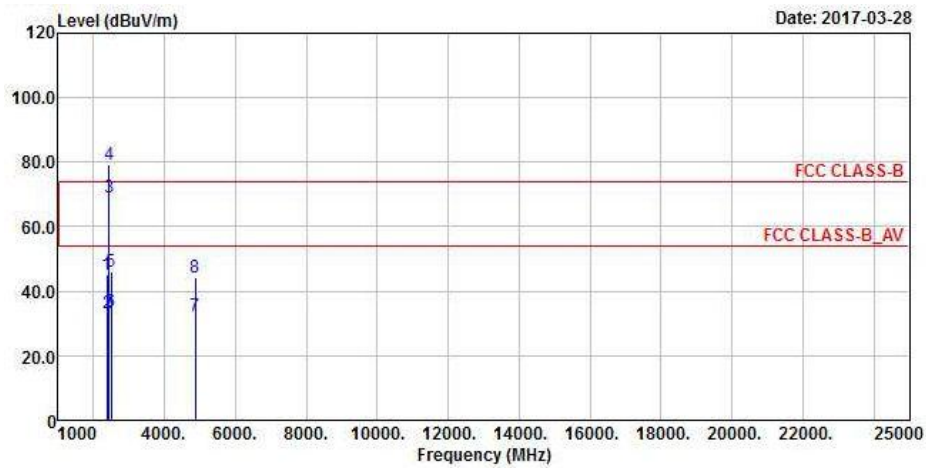

Antennal Polarity & Test Distance: Horizontal at 3 m

Frequency (MHz)	Emission Level (dBuV/m)	Read Level (dBuV)	Limit (dBuV/m)	Margin (dB)	Antenna Factor (dB/m)	Cable Loss (dB)	Preamp Factor (dB)	Antenna Height (cm)	Table Angle (Degree)	Remark
2330.02	46.21	52.92	74	-27.79	26.72	4.04	37.47	130	110	Peak
2373.51	33.53	40.1	54	-20.47	26.86	4.07	37.5	130	110	Average
2437	76.25	82.53			27.06	4.12	37.46	130	110	Average
2437	86.72	93			27.06	4.12	37.46	130	110	Peak
2488.65	46.87	52.83	74	-27.13	27.2	4.16	37.32	130	110	Peak
2491.1	33.32	39.28	54	-20.68	27.2	4.16	37.32	130	110	Average
4874	33.12	48.26	54	-20.88	31.06	6.85	53.05	109	21	Average
4874	44.27	59.41	74	-29.73	31.06	6.85	53.05	109	21	Peak

Antennal Polarity & Test Distance: Vertical at 3 m

Frequency (MHz)	Emission Level (dBuV/m)	Read Level (dBuV)	Limit (dBuV/m)	Margin (dB)	Antenna Factor (dB/m)	Cable Loss (dB)	Preamp Factor (dB)	Antenna Height (cm)	Table Angle (Degree)	Remark
2367.41	45.22	51.84	74	-28.78	26.81	4.07	37.5	127	33	Peak
2384.59	33.09	39.65	54	-20.91	26.86	4.08	37.5	127	33	Average
2437	69.15	75.43			27.06	4.12	37.46	127	33	Average
2437	79.36	85.64			27.06	4.12	37.46	127	33	Peak
2485.23	46.07	52.09	74	-27.93	27.15	4.15	37.32	127	33	Peak
2491	33.62	39.58	54	-20.38	27.2	4.16	37.32	127	33	Average
4874	32.51	47.65	54	-21.49	31.06	6.85	53.05	115	328	Average
4874	44.09	59.23	74	-29.91	31.06	6.85	53.05	115	328	Peak

Remarks:

- Emission Level = Read Level + Antenna Factor + Cable Loss - Preamp Factor
Margin value = Emission level – Limit value
- 2437 MHz: Fundamental frequency.

EUT Test Condition		Measurement Detail	
Channel	Channel 11	Frequency Range	1 GHz ~ 25 GHz
Input Power	120 Vac, 60 Hz	Detector Function	Peak (PK) Average (AV)
Environmental Conditions	25 deg. C, 65 % RH	Tested By	Getaz Yang

Horizontal

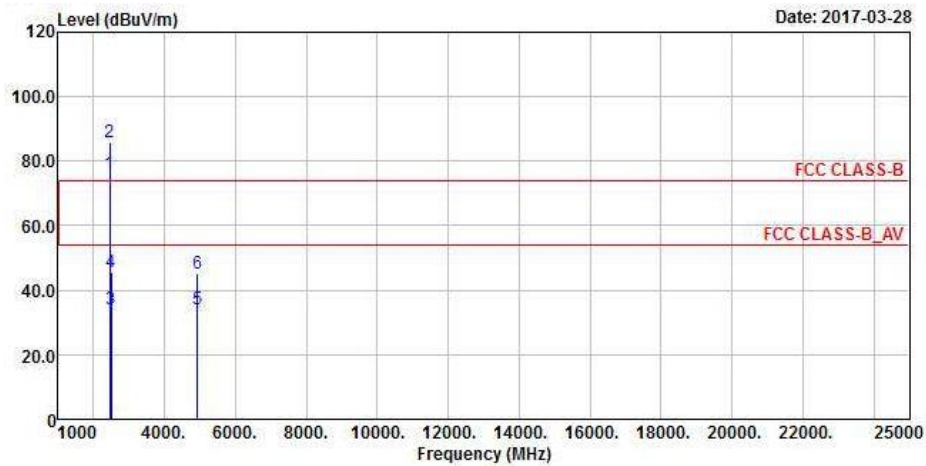

Vertical

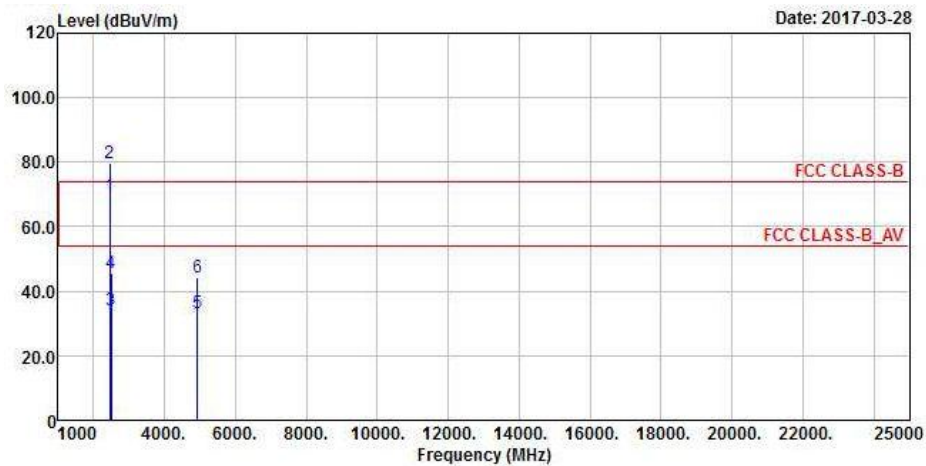

Antennal Polarity & Test Distance: Horizontal at 3 m

Frequency (MHz)	Emission Level (dBuV/m)	Read Level (dBuV)	Limit (dBuV/m)	Margin (dB)	Antenna Factor (dB/m)	Cable Loss (dB)	Preamp Factor (dB)	Antenna Height (cm)	Table Angle (Degree)	Remark
2462	76.25	82.41			27.1	4.13	37.39	132	71	Average
2462	86.06	92.22			27.1	4.13	37.39	132	71	Peak
2483.52	34.28	40.3	54	-19.72	27.15	4.15	37.32	132	71	Average
2498.88	45.74	51.63	74	-28.26	27.2	4.16	37.25	132	71	Peak
4924	34.15	49.18	54	-19.85	31.12	6.88	53.03	115	99	Average
4924	45.21	60.24	74	-28.79	31.12	6.88	53.03	115	99	Peak

Antennal Polarity & Test Distance: Vertical at 3 m

Frequency (MHz)	Emission Level (dBuV/m)	Read Level (dBuV)	Limit (dBuV/m)	Margin (dB)	Antenna Factor (dB/m)	Cable Loss (dB)	Preamp Factor (dB)	Antenna Height (cm)	Table Angle (Degree)	Remark
2462	69.34	75.5			27.1	4.13	37.39	162	39	Average
2462	79.49	85.65			27.1	4.13	37.39	162	39	Peak
2488.96	34.21	40.17	54	-19.79	27.2	4.16	37.32	162	39	Average
2491.64	45.39	51.35	74	-28.61	27.2	4.16	37.32	162	39	Peak
4924	33.38	48.41	54	-20.62	31.12	6.88	53.03	115	309	Average
4924	44.18	59.21	74	-29.82	31.12	6.88	53.03	115	309	Peak

Remarks:

- Emission Level = Read Level + Antenna Factor + Cable Loss - Preamp Factor
Margin value = Emission level – Limit value
- 2462 MHz: Fundamental frequency.

EUT Test Condition		Measurement Detail	
Channel	Channel 12	Frequency Range	1 GHz ~ 25 GHz
Input Power	120 Vac, 60 Hz	Detector Function	Peak (PK) Average (AV)
Environmental Conditions	25 deg. C, 65 % RH	Tested By	Getaz Yang

Horizontal

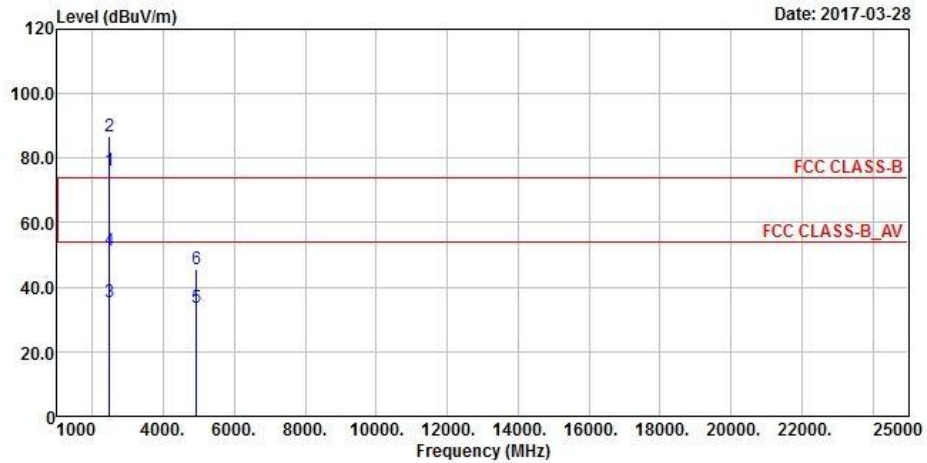

Vertical

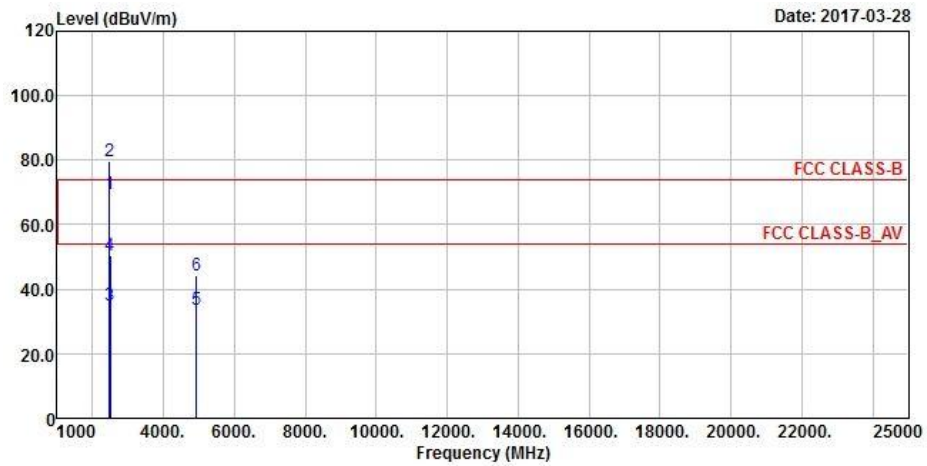

Antennal Polarity & Test Distance: Horizontal at 3 m

Frequency (MHz)	Emission Level (dBuV/m)	Read Level (dBuV)	Limit (dBuV/m)	Margin (dB)	Antenna Factor (dB/m)	Cable Loss (dB)	Preamp Factor (dB)	Antenna Height (cm)	Table Angle (Degree)	Remark
2467	76.26	82.35			27.1	4.13	37.32	144	60	Average
2467	86.65	92.74			27.1	4.13	37.32	144	60	Peak
2483.22	35.45	41.47	54	-18.55	27.15	4.15	37.32	144	60	Average
2483.98	51.29	57.31	74	-22.71	27.15	4.15	37.32	144	60	Peak
4934	33.87	48.9	54	-20.13	31.12	6.88	53.03	150	87	Average
4934	45.4	60.43	74	-28.6	31.12	6.88	53.03	150	87	Peak

Antennal Polarity & Test Distance: Vertical at 3 m

Frequency (MHz)	Emission Level (dBuV/m)	Read Level (dBuV)	Limit (dBuV/m)	Margin (dB)	Antenna Factor (dB/m)	Cable Loss (dB)	Preamp Factor (dB)	Antenna Height (cm)	Table Angle (Degree)	Remark
2467	69.31	75.59			27.06	4.12	37.46	152	22	Average
2467	79.58	85.86			27.06	4.12	37.46	152	22	Peak
2486.26	35.18	41.2	54	-18.82	27.15	4.15	37.32	152	22	Average
2486.32	50.26	56.28	74	-23.74	27.15	4.15	37.32	152	22	Peak
4934	33.54	48.57	54	-20.46	31.12	6.88	53.03	110	311	Average
4934	44.31	59.34	74	-29.69	31.12	6.88	53.03	110	311	Peak

Remarks:

1. Emission Level = Read Level + Antenna Factor + Cable Loss - Preamp Factor

Margin value = Emission level – Limit value

2. 2467 MHz: Fundamental frequency.

EUT Test Condition		Measurement Detail	
Channel	Channel 13	Frequency Range	1 GHz ~ 25 GHz
Input Power	120 Vac, 60 Hz	Detector Function	Peak (PK) Average (AV)
Environmental Conditions	25 deg. C, 65 % RH	Tested By	Getaz Yang

Horizontal

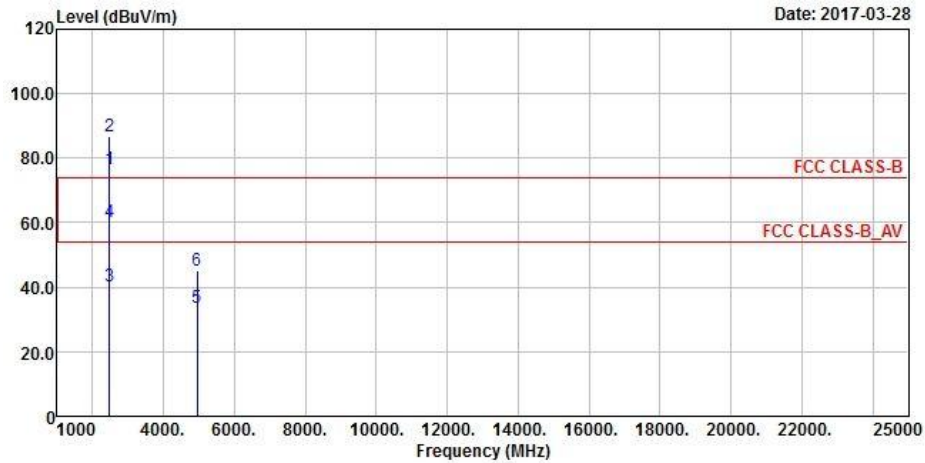

Vertical

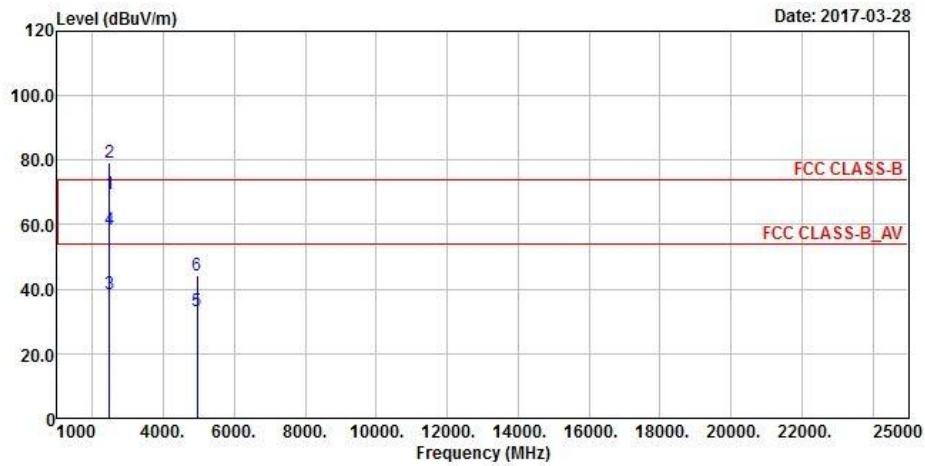

Antennal Polarity & Test Distance: Horizontal at 3 m

Frequency (MHz)	Emission Level (dBuV/m)	Read Level (dBuV)	Limit (dBuV/m)	Margin (dB)	Antenna Factor (dB/m)	Cable Loss (dB)	Preamp Factor (dB)	Antenna Height (cm)	Table Angle (Degree)	Remark
2472	76.39	82.41			27.15	4.15	37.32	144	92	Average
2472	86.74	92.76			27.15	4.15	37.32	144	92	Peak
2483.32	60.26	66.28	74	-13.74	27.15	4.15	37.32	144	92	Peak
2483.65	40.32	46.34	54	-13.68	27.15	4.15	37.32	144	92	Average
4944	33.47	48.46	54	-20.53	31.14	6.91	53.04	131	68	Average
4944	45.26	60.25	74	-28.74	31.14	6.91	53.04	131	68	Peak

Antennal Polarity & Test Distance: Vertical at 3 m

Frequency (MHz)	Emission Level (dBuV/m)	Read Level (dBuV)	Limit (dBuV/m)	Margin (dB)	Antenna Factor (dB/m)	Cable Loss (dB)	Preamp Factor (dB)	Antenna Height (cm)	Table Angle (Degree)	Remark
2472	69.38	75.4			27.15	4.15	37.32	120	118	Average
2472	79.26	85.28			27.15	4.15	37.32	120	118	Peak
2483.17	58.23	64.25	74	-15.77	27.15	4.15	37.32	120	118	Peak
2483.51	38.56	44.58	54	-15.44	27.15	4.15	37.32	120	118	Average
4944	33.17	48.16	54	-20.83	31.14	6.91	53.04	119	320	Average
4944	44.21	59.2	74	-29.79	31.14	6.91	53.04	119	320	Peak

Remarks:

- Emission Level = Read Level + Antenna Factor + Cable Loss - Preamp Factor
Margin value = Emission level – Limit value
- 2472 MHz: Fundamental frequency.

802.11n (HT20)

EUT Test Condition		Measurement Detail	
Channel	Channel 1	Frequency Range	1 GHz ~ 25 GHz
Input Power	120 Vac, 60 Hz	Detector Function	Peak (PK) Average (AV)
Environmental Conditions	25 deg. C, 65 % RH	Tested By	Getaz Yang

Horizontal

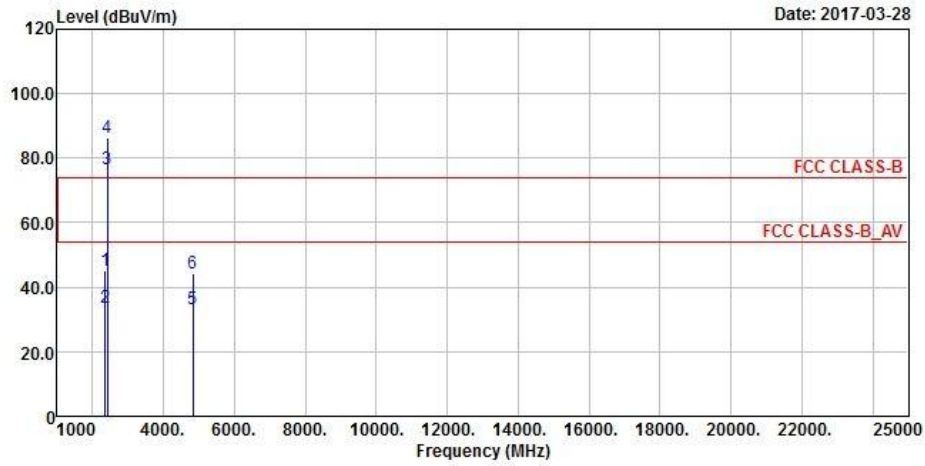

Vertical

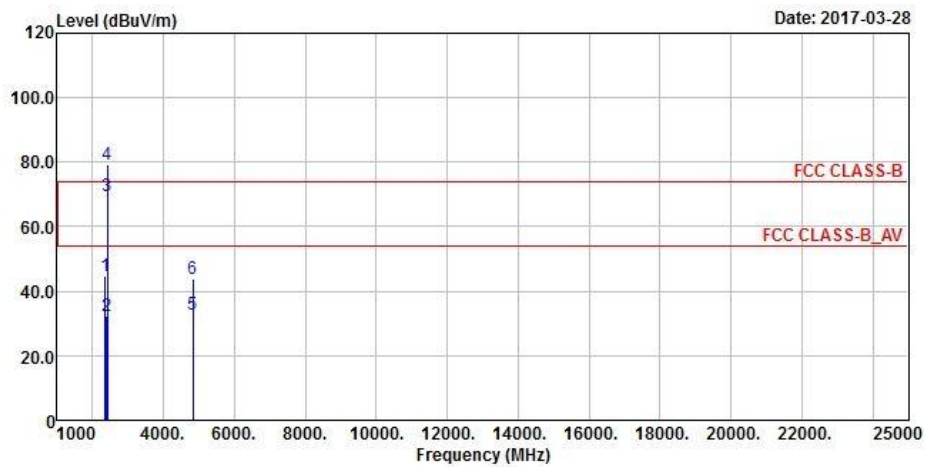

Antennal Polarity & Test Distance: Horizontal at 3 m

Frequency (MHz)	Emission Level (dBuV/m)	Read Level (dBuV)	Limit (dBuV/m)	Margin (dB)	Antenna Factor (dB/m)	Cable Loss (dB)	Preamp Factor (dB)	Antenna Height (cm)	Table Angle (Degree)	Remark
2344.28	45.36	52.03	74	-28.64	26.77	4.05	37.49	171	5	Peak
2351.86	33.85	40.48	54	-20.15	26.81	4.05	37.49	171	5	Average
2412	76.39	82.86			26.96	4.09	37.52	171	5	Average
2412	86.27	92.74			26.96	4.09	37.52	171	5	Peak
4824	33.26	48.56	54	-20.74	30.99	6.79	53.08	120	66	Average
4824	44.12	59.42	74	-29.88	30.99	6.79	53.08	120	66	Peak

Antennal Polarity & Test Distance: Vertical at 3 m

Frequency (MHz)	Emission Level (dBuV/m)	Read Level (dBuV)	Limit (dBuV/m)	Margin (dB)	Antenna Factor (dB/m)	Cable Loss (dB)	Preamp Factor (dB)	Antenna Height (cm)	Table Angle (Degree)	Remark
2361.1	44.86	51.49	74	-29.14	26.81	4.05	37.49	165	123	Peak
2386.25	32.17	38.68	54	-21.83	26.91	4.08	37.5	165	123	Average
2412	69.54	76.01			26.96	4.09	37.52	165	123	Average
2412	79.3	85.77			26.96	4.09	37.52	165	123	Peak
4824	32.95	48.25	54	-21.05	30.99	6.79	53.08	117	316	Average
4824	43.76	59.06	74	-30.24	30.99	6.79	53.08	117	316	Peak

Remarks:

- Emission Level = Read Level + Antenna Factor + Cable Loss - Preamp Factor
Margin value = Emission level – Limit value
- 2412 MHz: Fundamental frequency.

EUT Test Condition		Measurement Detail	
Channel	Channel 6	Frequency Range	1 GHz ~ 25 GHz
Input Power	120 Vac, 60 Hz	Detector Function	Peak (PK) Average (AV)
Environmental Conditions	25 deg. C, 65 % RH	Tested By	Getaz Yang

Horizontal

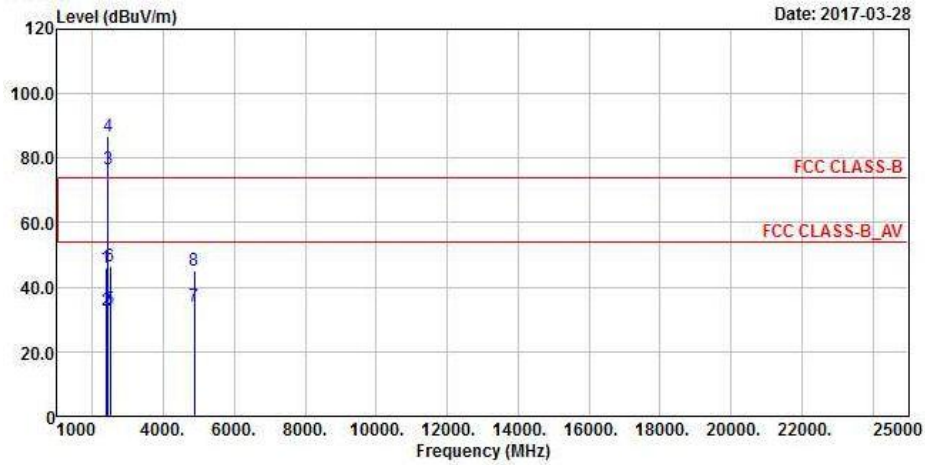

Vertical

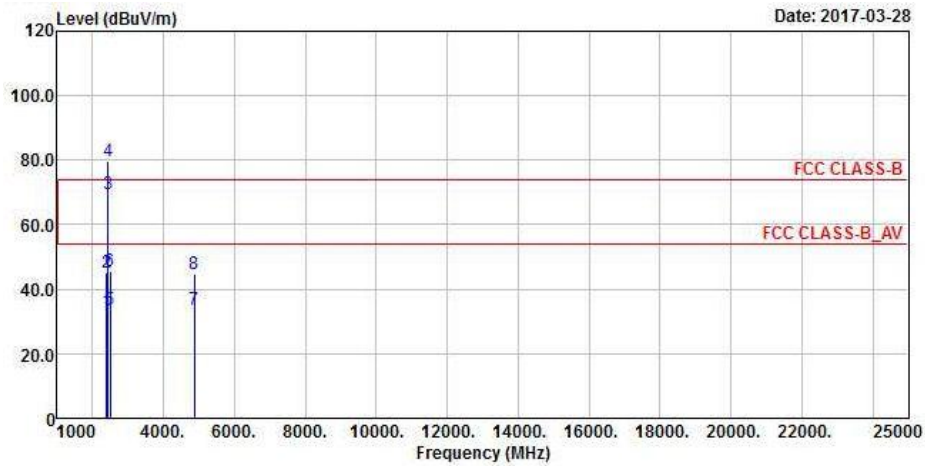

Antennal Polarity & Test Distance: Horizontal at 3 m

Frequency (MHz)	Emission Level (dBuV/m)	Read Level (dBuV)	Limit (dBuV/m)	Margin (dB)	Antenna Factor (dB/m)	Cable Loss (dB)	Preamp Factor (dB)	Antenna Height (cm)	Table Angle (Degree)	Remark
2381.51	46.12	52.68	74	-27.88	26.86	4.08	37.5	149	53	Peak
2387.29	32.84	39.35	54	-21.16	26.91	4.08	37.5	149	53	Average
2437	76.78	83.06			27.06	4.12	37.46	149	53	Average
2437	86.96	93.24			27.06	4.12	37.46	149	53	Peak
2488.62	33.29	39.25	54	-20.71	27.2	4.16	37.32	149	53	Average
2497	46.41	52.3	74	-27.59	27.2	4.16	37.25	149	53	Peak
4874	33.98	49.12	54	-20.02	31.06	6.85	53.05	142	66	Average
4874	45.2	60.34	74	-28.8	31.06	6.85	53.05	142	66	Peak

Antennal Polarity & Test Distance: Vertical at 3 m

Frequency (MHz)	Emission Level (dBuV/m)	Read Level (dBuV)	Limit (dBuV/m)	Margin (dB)	Antenna Factor (dB/m)	Cable Loss (dB)	Preamp Factor (dB)	Antenna Height (cm)	Table Angle (Degree)	Remark
2388.15	33.41	39.92	54	-20.59	26.91	4.08	37.5	127	69	Average
2389.45	45.36	51.87	74	-28.64	26.91	4.08	37.5	127	69	Peak
2437	69.41	75.69			27.06	4.12	37.46	127	69	Average
2437	79.82	86.1			27.06	4.12	37.46	127	69	Peak
2491	33.84	39.8	54	-20.16	27.2	4.16	37.32	127	69	Average
2496	45.69	51.58	74	-28.31	27.2	4.16	37.25	127	69	Peak
4874	33.44	48.58	54	-20.56	31.06	6.85	53.05	132	350	Average
4874	44.92	60.06	74	-29.08	31.06	6.85	53.05	132	350	Peak

Remarks:

- Emission Level = Read Level + Antenna Factor + Cable Loss - Preamp Factor
Margin value = Emission level – Limit value
- 2437 MHz: Fundamental frequency.

EUT Test Condition		Measurement Detail	
Channel	Channel 11	Frequency Range	1 GHz ~ 25 GHz
Input Power	120 Vac, 60 Hz	Detector Function	Peak (PK) Average (AV)
Environmental Conditions	25 deg. C, 65 % RH	Tested By	Getaz Yang

Horizontal

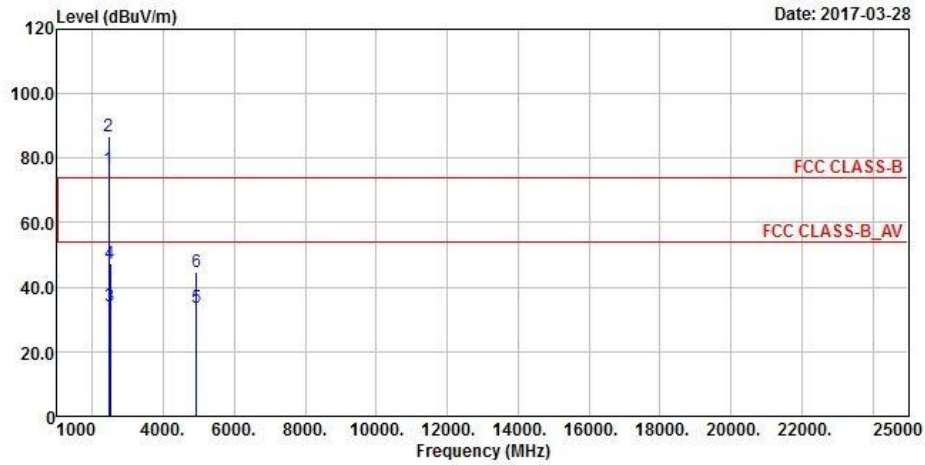

Vertical

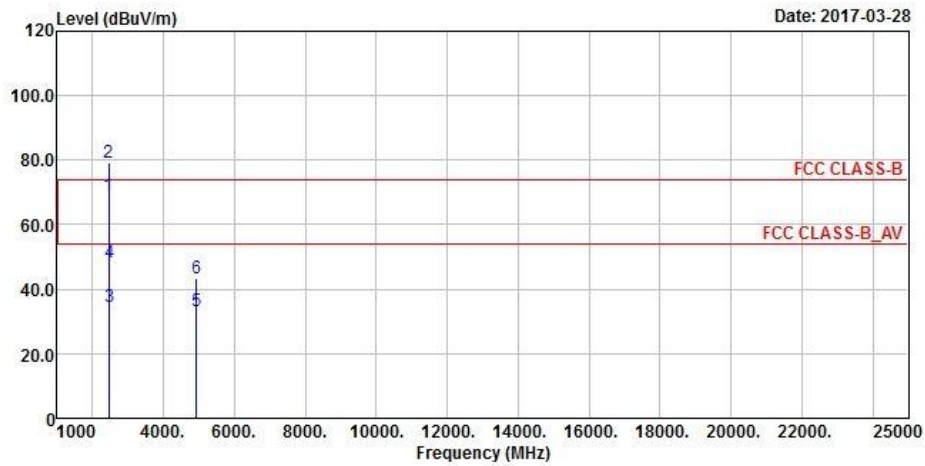

Antennal Polarity & Test Distance: Horizontal at 3 m

Frequency (MHz)	Emission Level (dBuV/m)	Read Level (dBuV)	Limit (dBuV/m)	Margin (dB)	Antenna Factor (dB/m)	Cable Loss (dB)	Preamp Factor (dB)	Antenna Height (cm)	Table Angle (Degree)	Remark
2462	76.49	82.65			27.1	4.13	37.39	133	75	Average
2462	86.62	92.78			27.1	4.13	37.39	133	75	Peak
2483.77	34.22	40.24	54	-19.78	27.15	4.15	37.32	133	75	Average
2484.36	47.25	53.27	74	-26.75	27.15	4.15	37.32	133	75	Peak
4924	33.65	48.68	54	-20.35	31.12	6.88	53.03	103	110	Average
4924	44.8	59.83	74	-29.2	31.12	6.88	53.03	103	110	Peak

Antennal Polarity & Test Distance: Vertical at 3 m

Frequency (MHz)	Emission Level (dBuV/m)	Read Level (dBuV)	Limit (dBuV/m)	Margin (dB)	Antenna Factor (dB/m)	Cable Loss (dB)	Preamp Factor (dB)	Antenna Height (cm)	Table Angle (Degree)	Remark
2462	69.06	75.22			27.1	4.13	37.39	149	12	Average
2462	79.28	85.44			27.1	4.13	37.39	149	12	Peak
2483.22	34.55	40.57	54	-19.45	27.15	4.15	37.32	149	12	Average
2483.78	48.23	54.25	74	-25.77	27.15	4.15	37.32	149	12	Peak
4924	33.05	48.08	54	-20.95	31.12	6.88	53.03	107	254	Average
4924	43.36	58.39	74	-30.64	31.12	6.88	53.03	107	254	Peak

Remarks:

- Emission Level = Read Level + Antenna Factor + Cable Loss - Preamp Factor
Margin value = Emission level – Limit value
- 2462 MHz: Fundamental frequency.

EUT Test Condition		Measurement Detail	
Channel	Channel 12	Frequency Range	1 GHz ~ 25 GHz
Input Power	120 Vac, 60 Hz	Detector Function	Peak (PK) Average (AV)
Environmental Conditions	25 deg. C, 65 % RH	Tested By	Getaz Yang

Horizontal

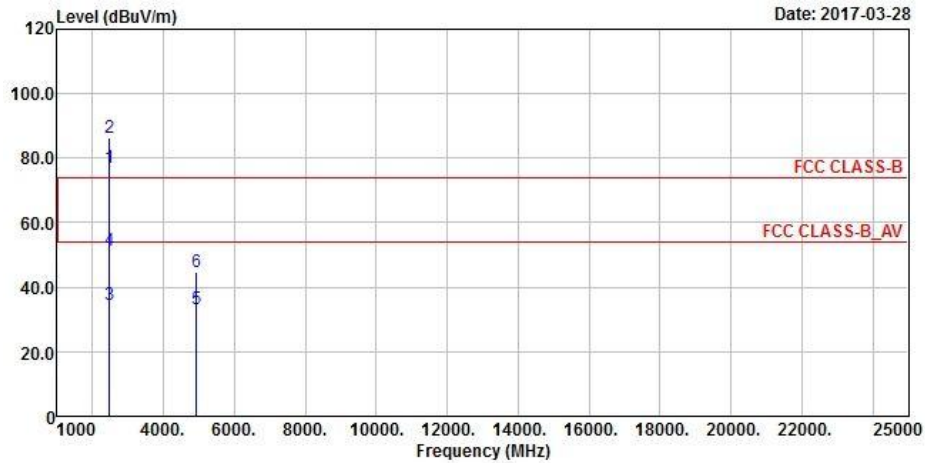

Vertical

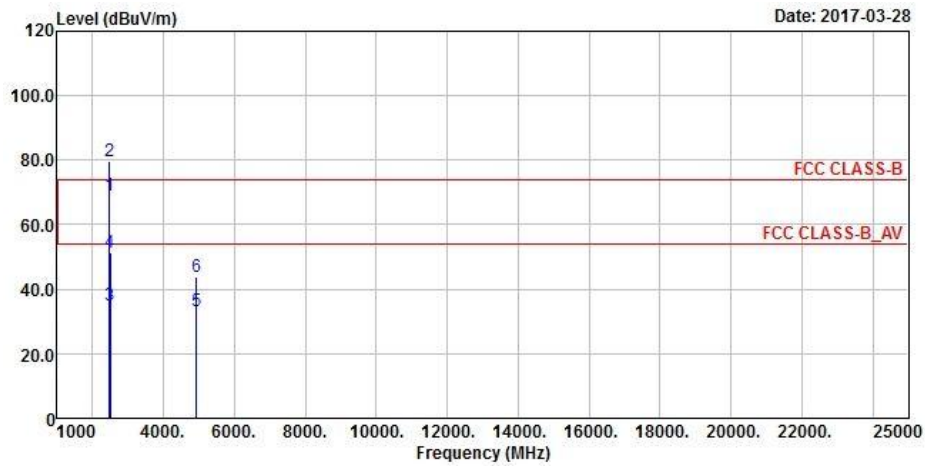

Antennal Polarity & Test Distance: Horizontal at 3 m

Frequency (MHz)	Emission Level (dBuV/m)	Read Level (dBuV)	Limit (dBuV/m)	Margin (dB)	Antenna Factor (dB/m)	Cable Loss (dB)	Preamp Factor (dB)	Antenna Height (cm)	Table Angle (Degree)	Remark
2467	76.88	82.97			27.1	4.13	37.32	170	23	Average
2467	86.55	92.64			27.1	4.13	37.32	170	23	Peak
2483.28	34.41	40.43	54	-19.59	27.15	4.15	37.32	170	23	Average
2484	51.36	57.38	74	-22.64	27.15	4.15	37.32	170	23	Peak
4934	33.39	48.42	54	-20.61	31.12	6.88	53.03	126	85	Average
4934	44.82	59.85	74	-29.18	31.12	6.88	53.03	126	85	Peak

Antennal Polarity & Test Distance: Vertical at 3 m

Frequency (MHz)	Emission Level (dBuV/m)	Read Level (dBuV)	Limit (dBuV/m)	Margin (dB)	Antenna Factor (dB/m)	Cable Loss (dB)	Preamp Factor (dB)	Antenna Height (cm)	Table Angle (Degree)	Remark
2467	69.2	75.29			27.1	4.13	37.32	110	199	Average
2467	79.68	85.77			27.1	4.13	37.32	110	199	Peak
2483.42	34.86	40.88	54	-19.14	27.15	4.15	37.32	110	199	Average
2484.83	51.29	57.31	74	-22.71	27.15	4.15	37.32	110	199	Peak
4934	33.11	48.14	54	-20.89	31.12	6.88	53.03	116	294	Average
4934	43.73	58.76	74	-30.27	31.12	6.88	53.03	116	294	Peak

Remarks:

- Emission Level = Read Level + Antenna Factor + Cable Loss - Preamp Factor
Margin value = Emission level – Limit value
- 2467 MHz: Fundamental frequency.

EUT Test Condition		Measurement Detail	
Channel	Channel 13	Frequency Range	1 GHz ~ 25 GHz
Input Power	120 Vac, 60 Hz	Detector Function	Peak (PK) Average (AV)
Environmental Conditions	25 deg. C, 65 % RH	Tested By	Getaz Yang

Horizontal

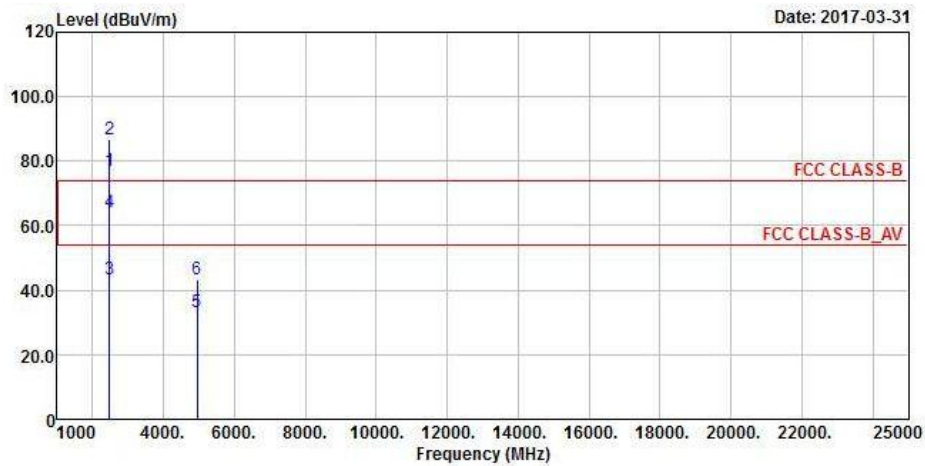

Vertical

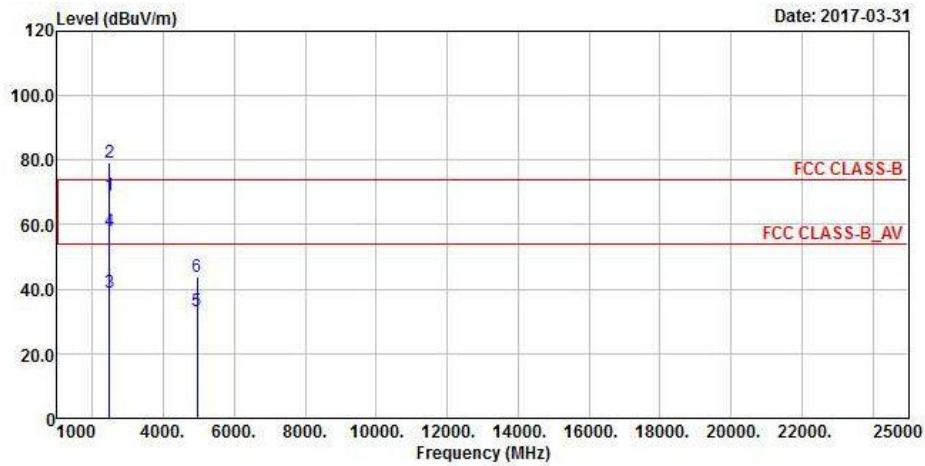

**Band Edge
Peak
Horizontal**

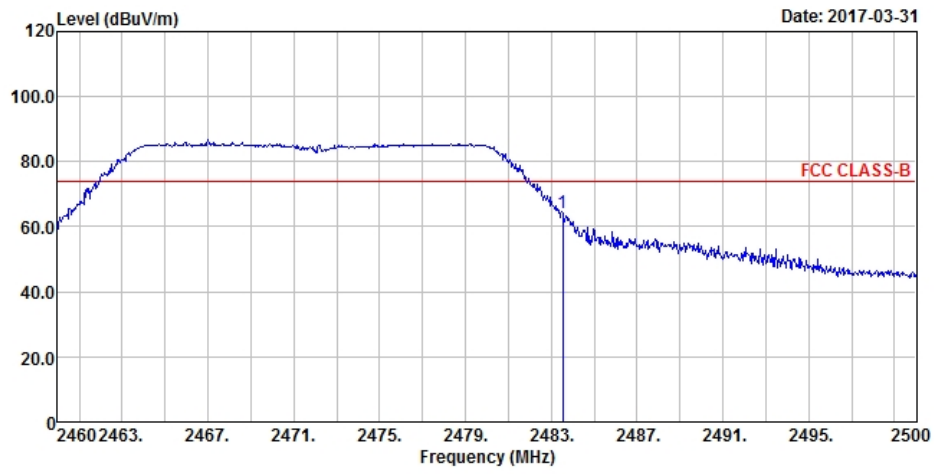

Vertical

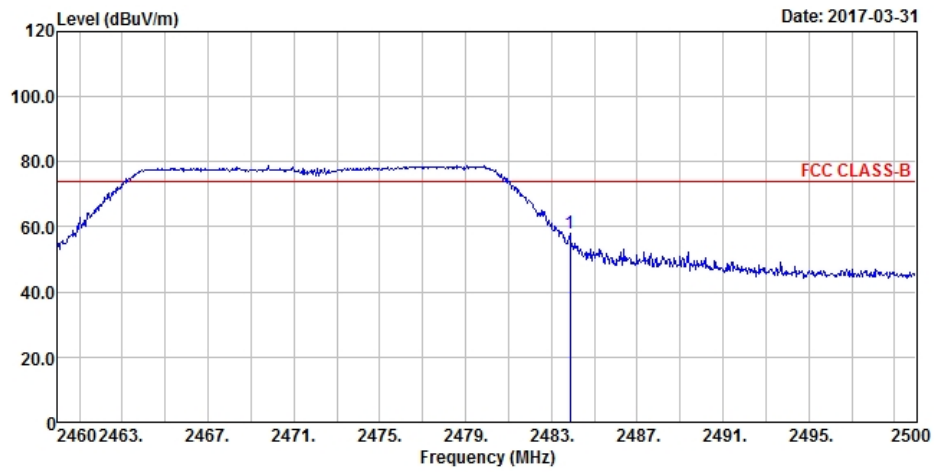

Average Horizontal

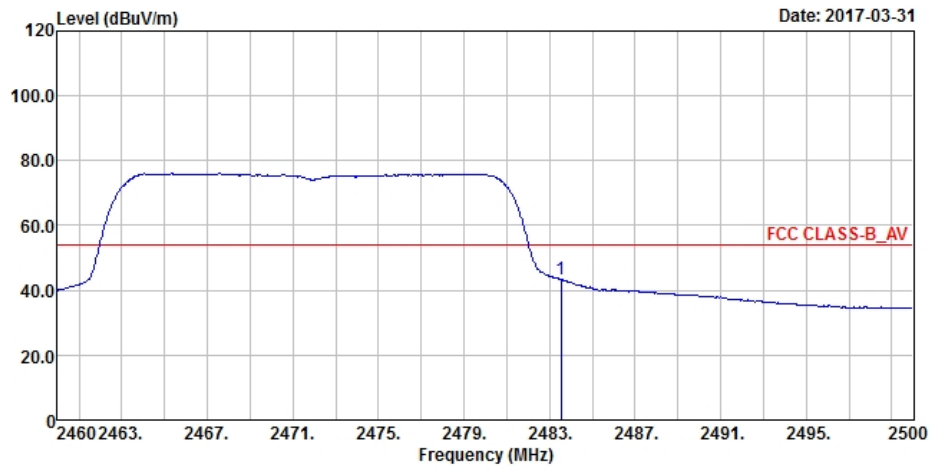

Vertical

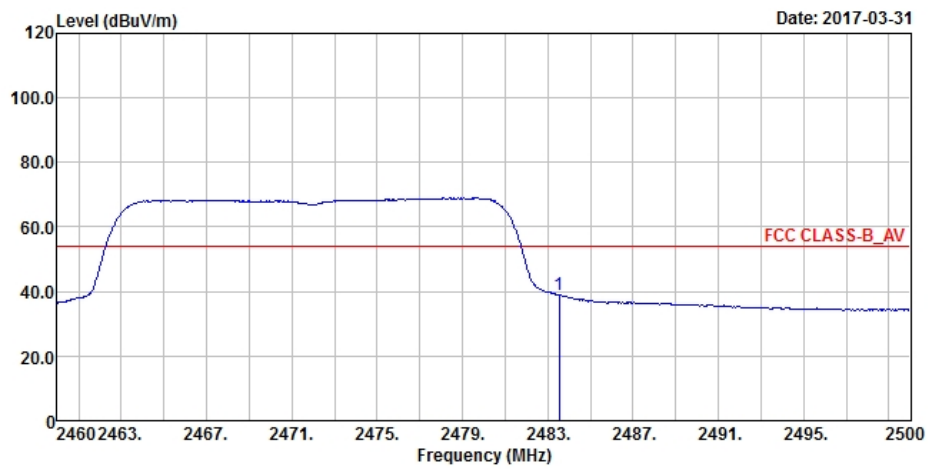

Antennal Polarity & Test Distance: Horizontal at 3 m										
Frequency (MHz)	Emission Level (dBuV/m)	Read Level (dBuV)	Limit (dBuV/m)	Margin (dB)	Antenna Factor (dB/m)	Cable Loss (dB)	Preamp Factor (dB)	Antenna Height (cm)	Table Angle (Degree)	Remark
2472	76.92	82.94			27.15	4.15	37.32	220	191	Average
2472	86.6	92.62			27.15	4.15	37.32	220	191	Peak
2483.52	43.49	49.51	54	-10.51	27.15	4.15	37.32	220	191	Average
2483.52	64.05	70.07	74	-9.95	27.15	4.15	37.32	220	191	Peak
4944	33.21	48.2	54	-20.79	31.14	6.91	53.04	194	186	Average
4944	43.49	58.48	74	-30.51	31.14	6.91	53.04	194	186	Peak
Antennal Polarity & Test Distance: Vertical at 3 m										
Frequency (MHz)	Emission Level (dBuV/m)	Read Level (dBuV)	Limit (dBuV/m)	Margin (dB)	Antenna Factor (dB/m)	Cable Loss (dB)	Preamp Factor (dB)	Antenna Height (cm)	Table Angle (Degree)	Remark
2472	69.28	75.3			27.15	4.15	37.32	211	95	Average
2472	79.14	85.16			27.15	4.15	37.32	211	95	Peak
2483.52	39	45.02	54	-15	27.15	4.15	37.32	211	95	Average
2483.88	58.03	64.05	74	-15.97	27.15	4.15	37.32	211	95	Peak
4944	33.14	48.13	54	-20.86	31.14	6.91	53.04	125	246	Average
4944	44.04	59.03	74	-29.96	31.14	6.91	53.04	125	246	Peak

Remarks:

1. Emission Level = Read Level + Antenna Factor + Cable Loss - Preamp Factor

Margin value = Emission level – Limit value

2. 2472 MHz: Fundamental frequency.

Mode B
802.11n (HT20)

EUT Test Condition		Measurement Detail	
Channel	Channel 13	Frequency Range	1 GHz ~ 25 GHz
Input Power	120 Vac, 60 Hz	Detector Function	Peak (PK) Average (AV)
Environmental Conditions	25 deg. C, 65 % RH	Tested By	Getaz Yang

Horizontal

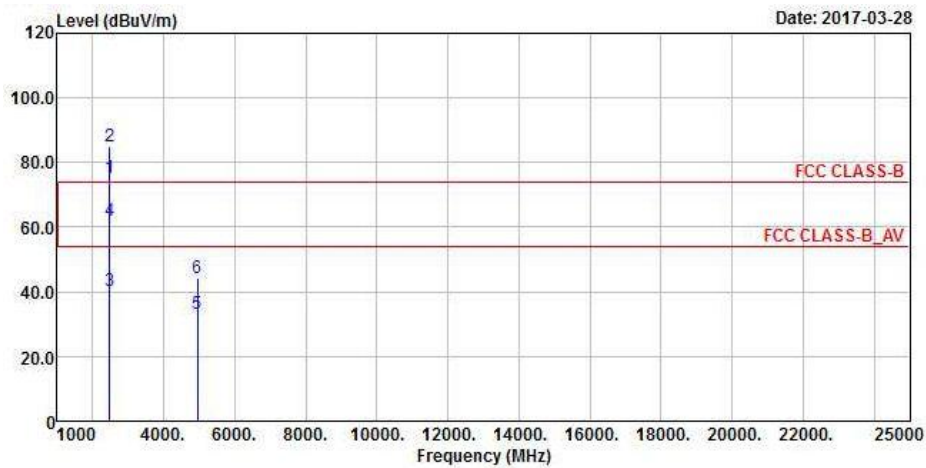

Vertical

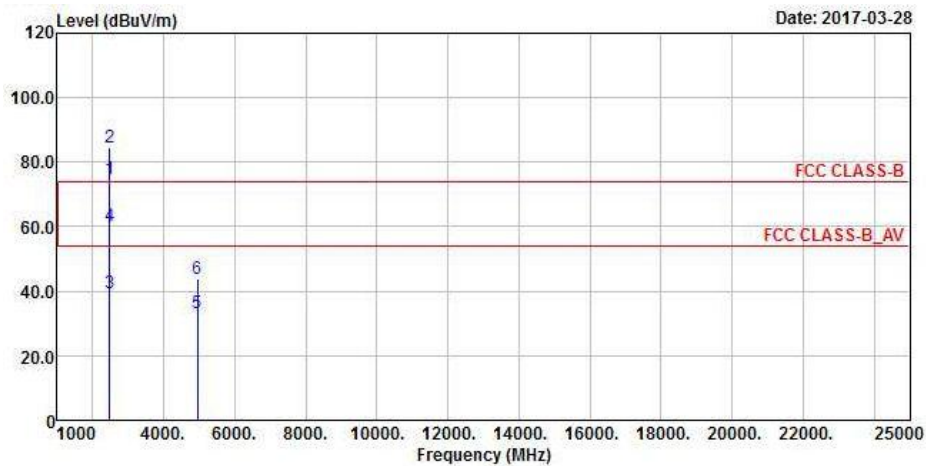

**Band Edge
Peak
Horizontal**

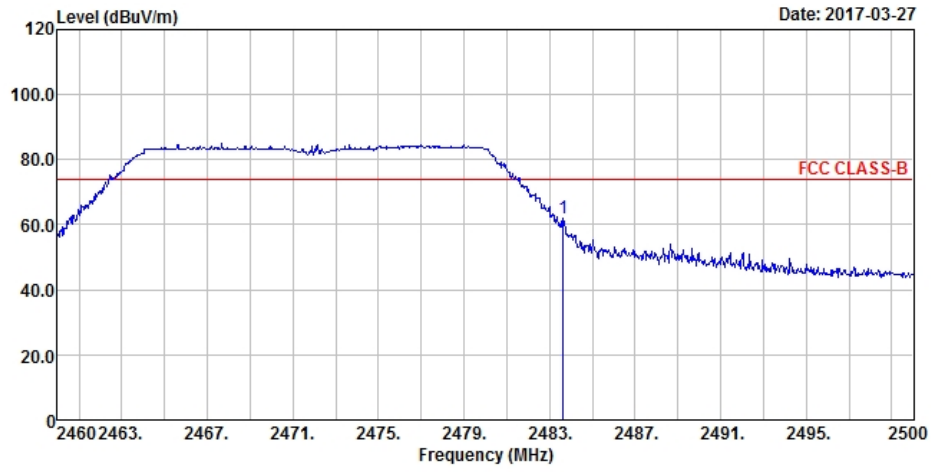

Vertical

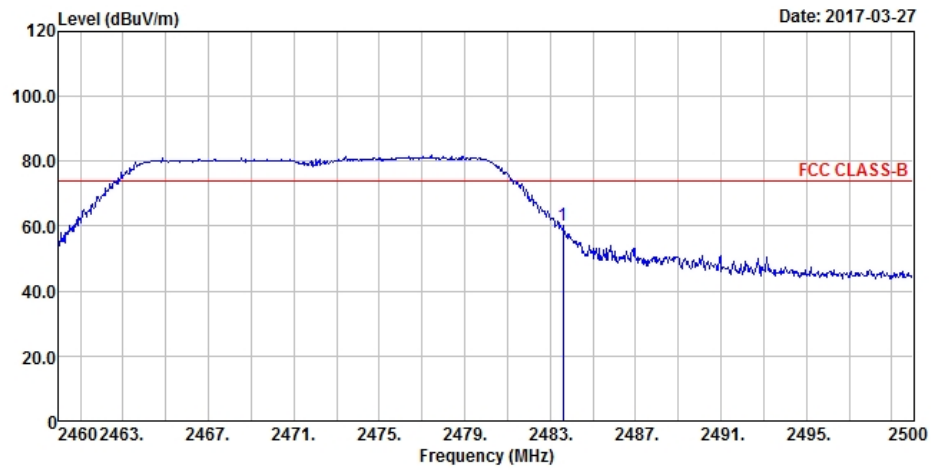

Average Horizontal

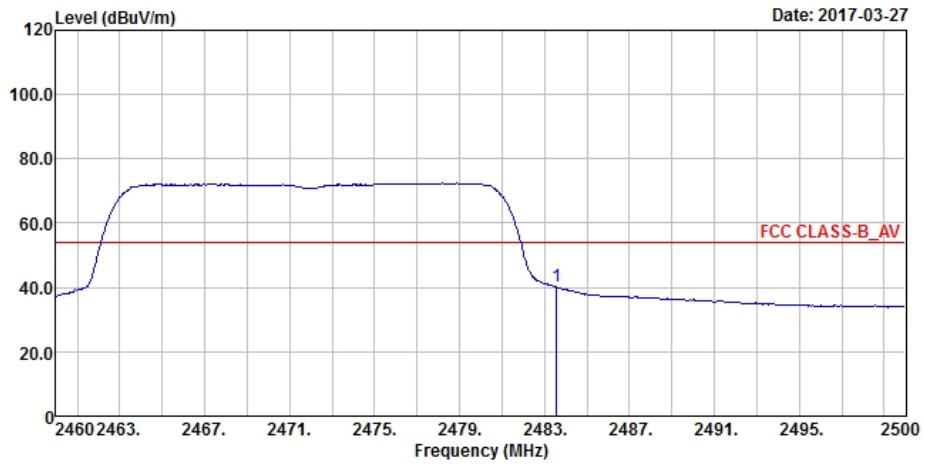

Vertical

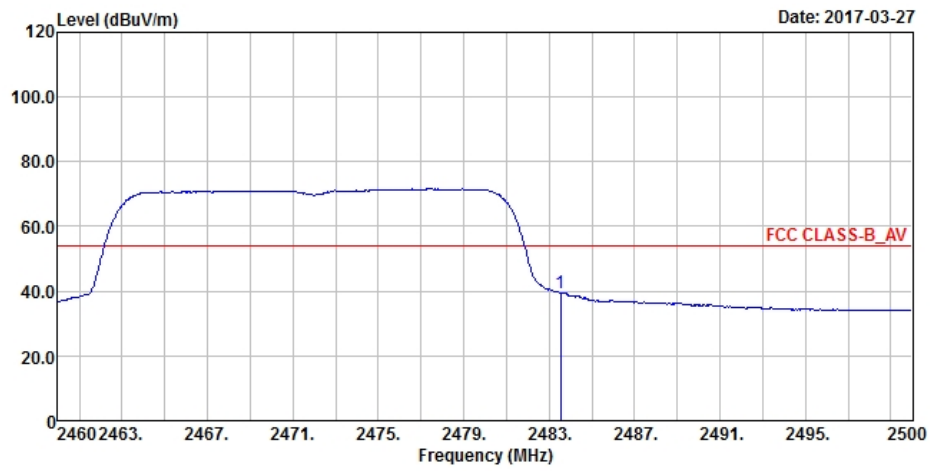

Antennal Polarity & Test Distance: Horizontal at 3 m

Frequency (MHz)	Emission Level (dBuV/m)	Read Level (dBuV)	Limit (dBuV/m)	Margin (dB)	Antenna Factor (dB/m)	Cable Loss (dB)	Preamp Factor (dB)	Antenna Height (cm)	Table Angle (Degree)	Remark
2472	75.35	81.37			27.15	4.15	37.32	188	22	Average
2472	85.17	91.19			27.15	4.15	37.32	188	22	Peak
2483.56	40.36	46.38	54	-13.64	27.15	4.15	37.32	188	22	Average
2483.64	61.8	67.82	74	-12.2	27.15	4.15	37.32	188	22	Peak
4944	33.34	48.33	54	-20.66	31.14	6.91	53.04	128	76	Average
4944	44.28	59.27	74	-29.72	31.14	6.91	53.04	128	76	Peak

Antennal Polarity & Test Distance: Vertical at 3 m

Frequency (MHz)	Emission Level (dBuV/m)	Read Level (dBuV)	Limit (dBuV/m)	Margin (dB)	Antenna Factor (dB/m)	Cable Loss (dB)	Preamp Factor (dB)	Antenna Height (cm)	Table Angle (Degree)	Remark
2472	74.97	80.99			27.15	4.15	37.32	119	172	Average
2472	84.73	90.75			27.15	4.15	37.32	119	172	Peak
2483.52	39.54	45.56	54	-14.46	27.15	4.15	37.32	119	172	Average
2483.6	60.14	66.16	74	-13.86	27.15	4.15	37.32	119	172	Peak
4944	33.12	48.11	54	-20.88	31.14	6.91	53.04	101	352	Average
4944	43.86	58.85	74	-30.14	31.14	6.91	53.04	101	352	Peak

Remarks:

- Emission Level = Read Level + Antenna Factor + Cable Loss - Preamp Factor
Margin value = Emission level – Limit value
- 2472 MHz: Fundamental frequency.

Mode C
802.11n (HT20)

EUT Test Condition		Measurement Detail	
Channel	Channel 13	Frequency Range	1 GHz ~ 25 GHz
Input Power	120 Vac, 60 Hz	Detector Function	Peak (PK) Average (AV)
Environmental Conditions	25 deg. C, 65 % RH	Tested By	Getaz Yang

Horizontal

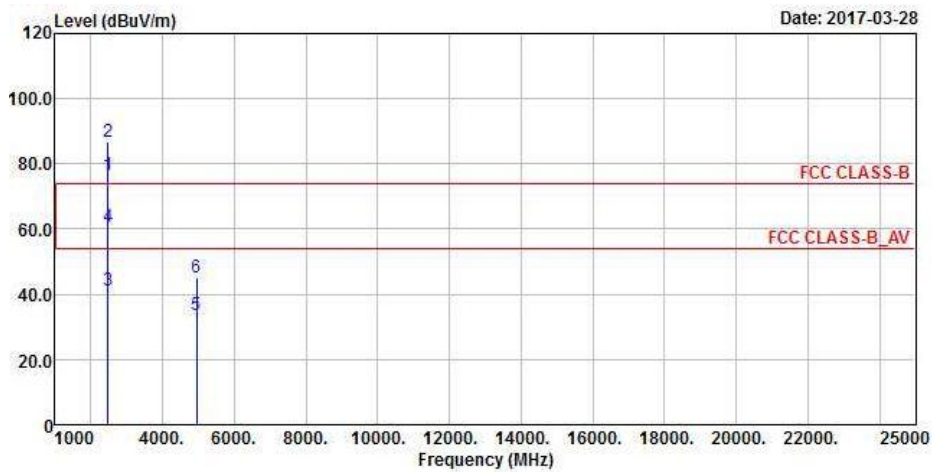

Vertical

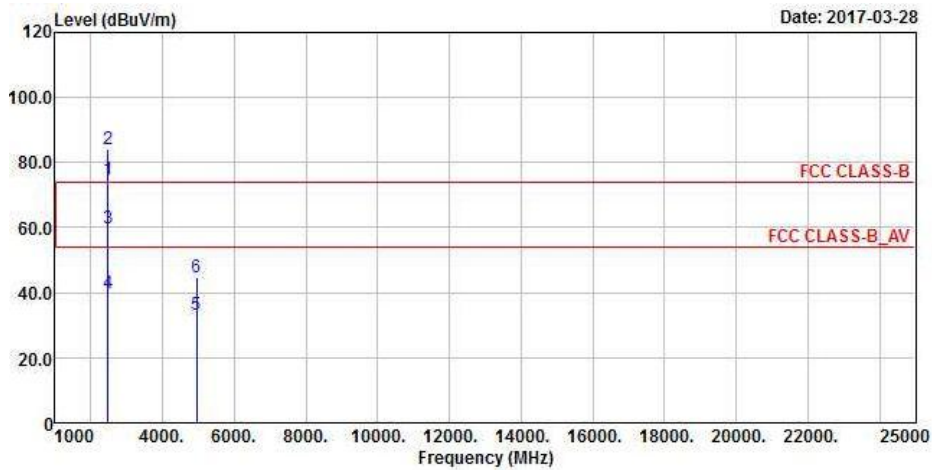

**Band Edge
Peak
Horizontal**

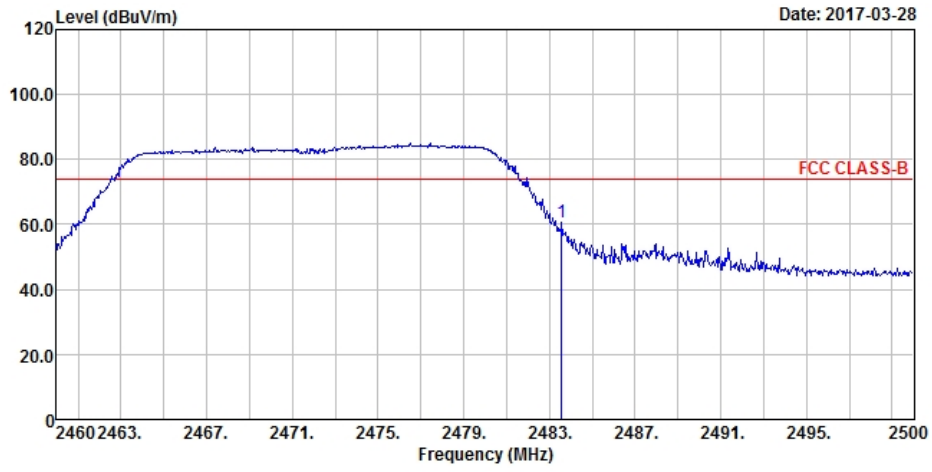

Vertical

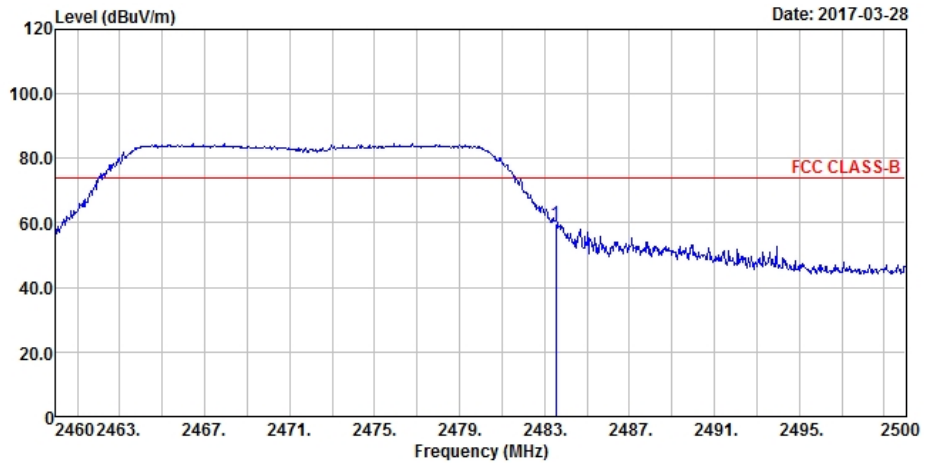

Average Horizontal

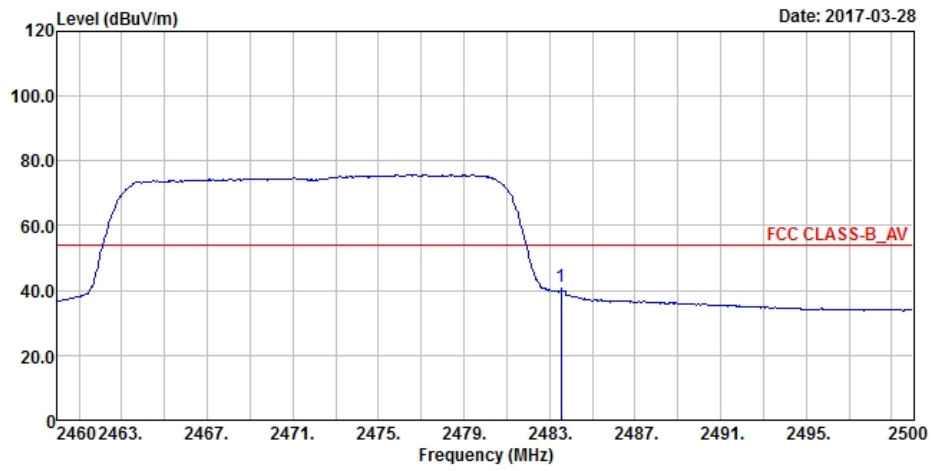

Vertical

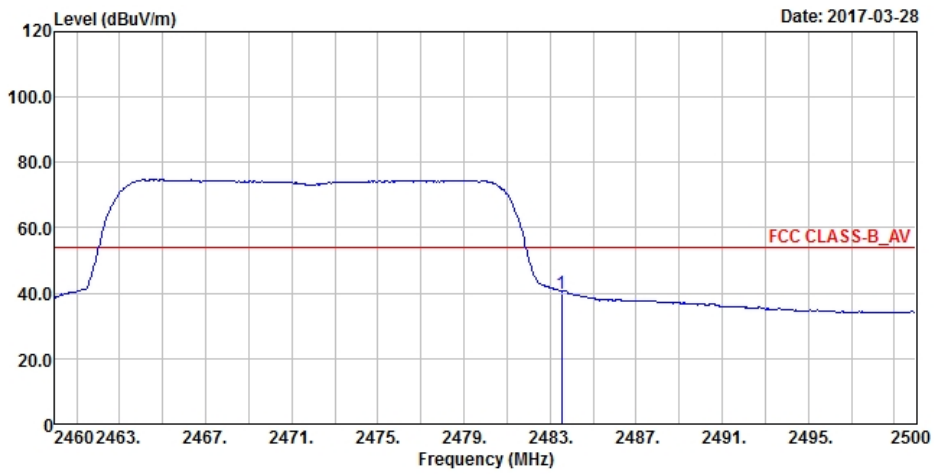

Antennal Polarity & Test Distance: Horizontal at 3 m

Frequency (MHz)	Emission Level (dBuV/m)	Read Level (dBuV)	Limit (dBuV/m)	Margin (dB)	Antenna Factor (dB/m)	Cable Loss (dB)	Preamp Factor (dB)	Antenna Height (cm)	Table Angle (Degree)	Remark
2472	76.82	82.84			27.15	4.15	37.32	202	237	Average
2472	86.72	92.74			27.15	4.15	37.32	202	237	Peak
2483.54	41.03	47.05	54	-12.97	27.15	4.15	37.32	202	237	Average
2483.56	60.59	66.61	74	-13.41	27.15	4.15	37.32	202	237	Peak
4944	33.73	48.72	54	-20.27	31.14	6.91	53.04	118	67	Average
4944	44.99	59.98	74	-29.01	31.14	6.91	53.04	118	67	Peak

Antennal Polarity & Test Distance: Vertical at 3 m

Frequency (MHz)	Emission Level (dBuV/m)	Read Level (dBuV)	Limit (dBuV/m)	Margin (dB)	Antenna Factor (dB/m)	Cable Loss (dB)	Preamp Factor (dB)	Antenna Height (cm)	Table Angle (Degree)	Remark
2472	74.93	80.95			27.15	4.15	37.32	200	276	Average
2472	84.03	90.05			27.15	4.15	37.32	200	276	Peak
2483.52	59.6	65.62	74	-14.4	27.15	4.15	37.32	200	276	Peak
2483.54	39.65	45.67	54	-14.35	27.15	4.15	37.32	200	276	Average
4944	33.25	48.24	54	-20.75	31.14	6.91	53.04	105	322	Average
4944	44.55	59.54	74	-29.45	31.14	6.91	53.04	105	322	Peak

Remarks:

- Emission Level = Read Level + Antenna Factor + Cable Loss - Preamp Factor
Margin value = Emission level – Limit value
- 2472 MHz: Fundamental frequency.

Mode D
802.11n (HT20)

EUT Test Condition		Measurement Detail	
Channel	Channel 13	Frequency Range	1 GHz ~ 25 GHz
Input Power	120 Vac, 60 Hz	Detector Function	Peak (PK) Average (AV)
Environmental Conditions	25 deg. C, 65 % RH	Tested By	Getaz Yang

Horizontal

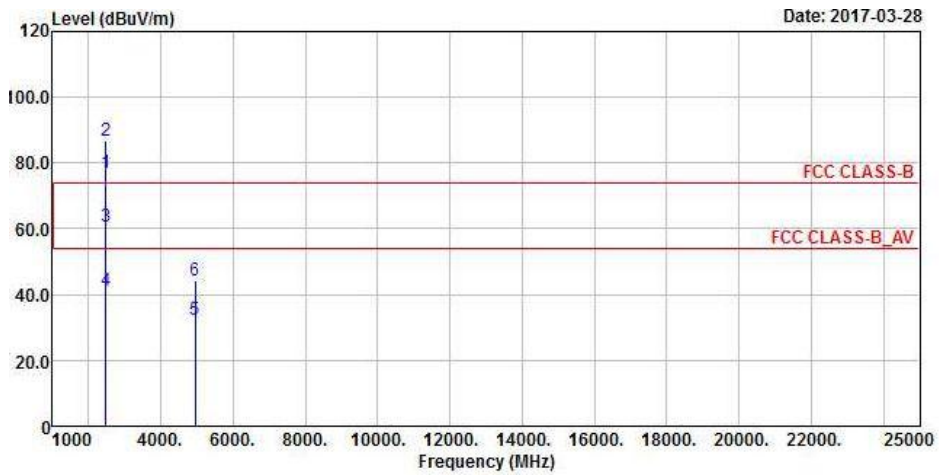

Vertical

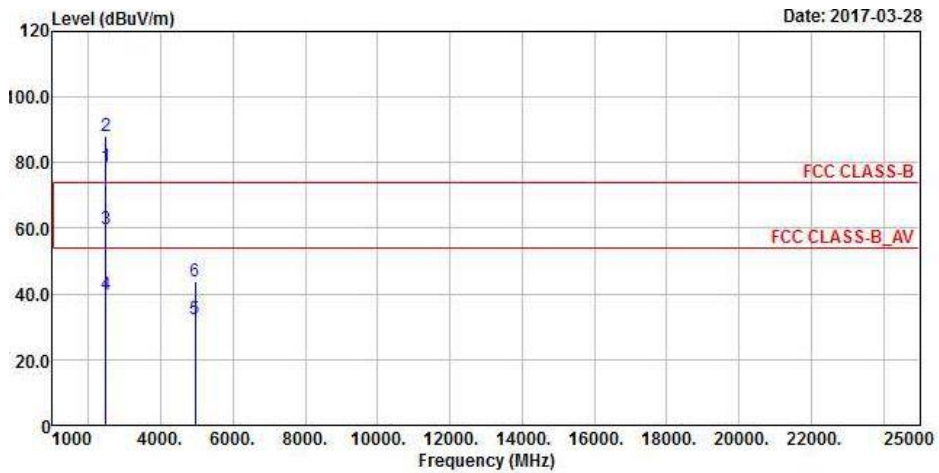

**Band Edge
Peak
Horizontal**

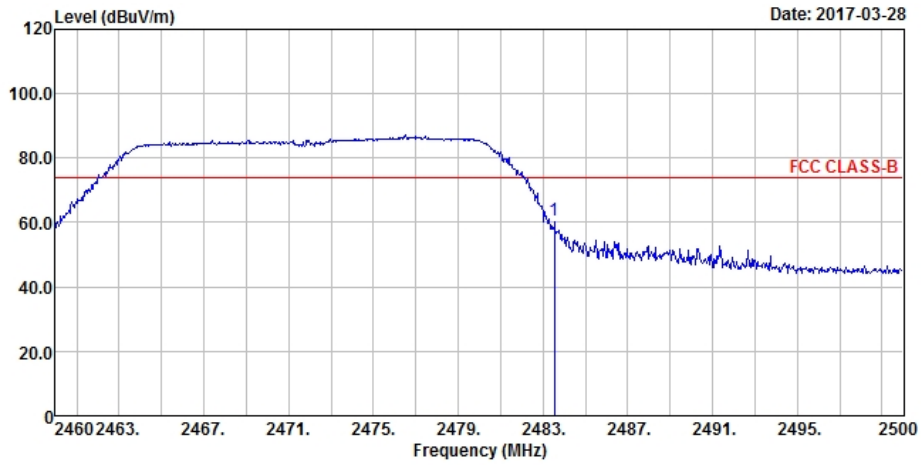

Vertical

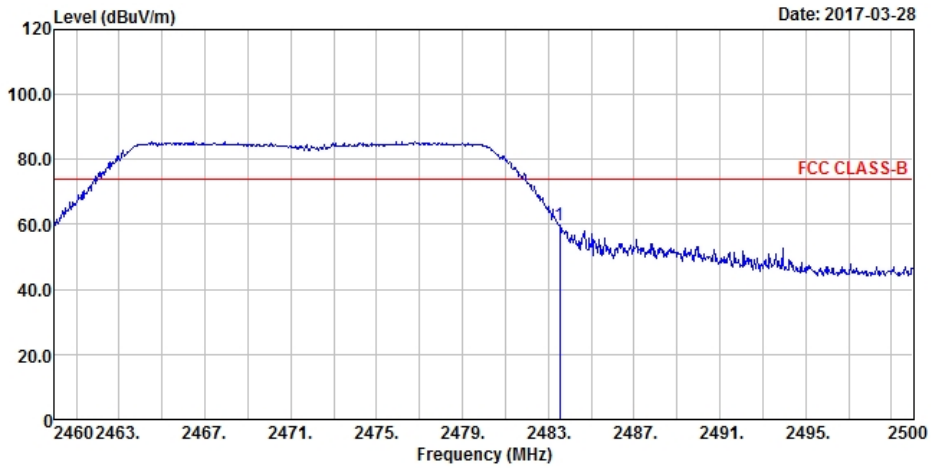

Average Horizontal

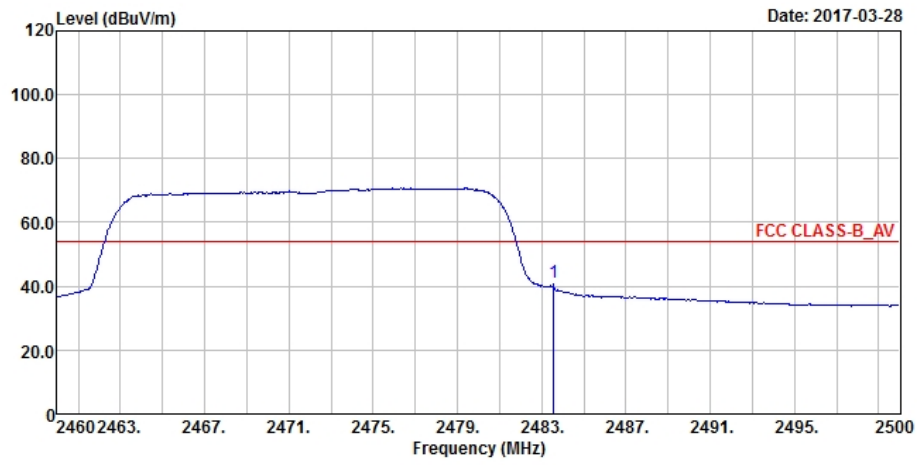

Vertical

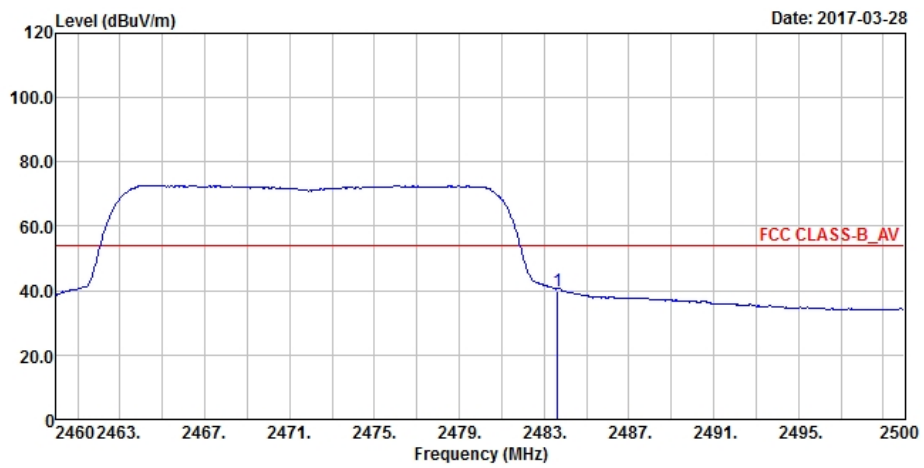

Antennal Polarity & Test Distance: Horizontal at 3 m

Frequency (MHz)	Emission Level (dBuV/m)	Read Level (dBuV)	Limit (dBuV/m)	Margin (dB)	Antenna Factor (dB/m)	Cable Loss (dB)	Preamp Factor (dB)	Antenna Height (cm)	Table Angle (Degree)	Remark
2472	76.92	82.94			27.15	4.15	37.32	110	146	Average
2472	86.7	92.72			27.15	4.15	37.32	110	146	Peak
2483.52	60.62	66.64	74	-13.38	27.15	4.15	37.32	110	146	Peak
2483.56	41.13	47.15	54	-12.87	27.15	4.15	37.32	110	146	Average
4944	32.39	47.38	54	-21.61	31.14	6.91	53.04	100	184	Average
4944	44.28	59.27	74	-29.72	31.14	6.91	53.04	100	184	Peak

Antennal Polarity & Test Distance: Vertical at 3 m

Frequency (MHz)	Emission Level (dBuV/m)	Read Level (dBuV)	Limit (dBuV/m)	Margin (dB)	Antenna Factor (dB/m)	Cable Loss (dB)	Preamp Factor (dB)	Antenna Height (cm)	Table Angle (Degree)	Remark
2472	78.74	84.76			27.15	4.15	37.32	100	187	Average
2472	88.18	94.2			27.15	4.15	37.32	100	187	Peak
2483.52	60	66.02	74	-14	27.15	4.15	37.32	100	187	Peak
2483.64	39.85	45.87	54	-14.15	27.15	4.15	37.32	100	187	Average
4944	32.28	47.27	54	-21.72	31.14	6.91	53.04	100	133	Average
4944	44	58.99	74	-30	31.14	6.91	53.04	100	133	Peak

Remarks:

- Emission Level = Read Level + Antenna Factor + Cable Loss - Preamp Factor
Margin value = Emission level – Limit value
- 2472 MHz: Fundamental frequency.

9 kHz ~ 30 MHz DATA:

The amplitude of spurious emissions attenuated more than 20 dB below the permissible value is not required to be report.

30 MHz ~ 1 GHz WORST-CASE DATA:

Mode A

802.11n (HT20)

EUT Test Condition		Measurement Detail	
Channel	Channel 13	Frequency Range	30 MHz ~ 1 GHz
Input Power	120 Vac, 60 Hz	Detector Function	Peak (PK) Quasi-peak (QP)
Environmental Conditions	25 deg. C, 65 % RH	Tested By	Getaz Yang

Horizontal

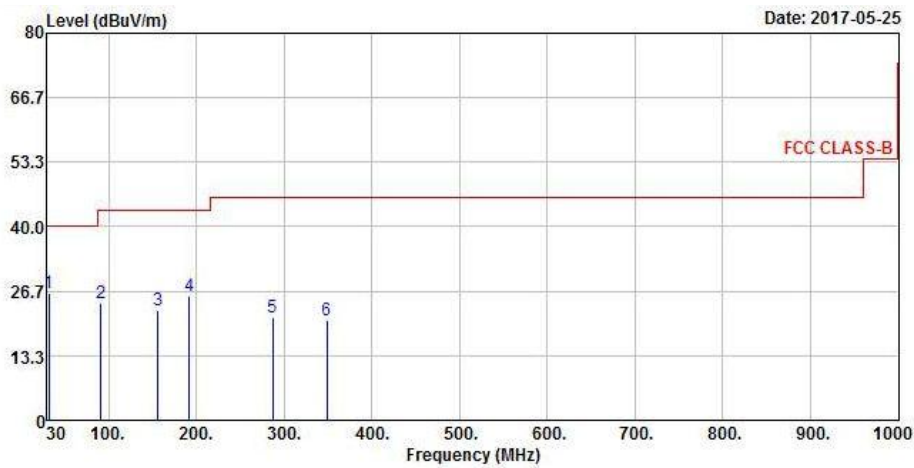

Vertical

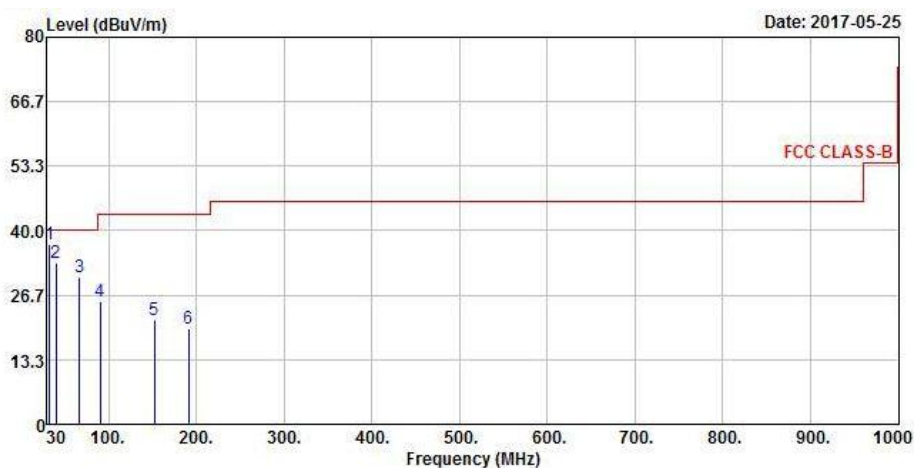

Antennal Polarity & Test Distance: Horizontal at 3 m										
Frequency (MHz)	Emission Level (dBuV/m)	Read Level (dBuV)	Limit (dBuV/m)	Margin (dB)	Antenna Factor (dB/m)	Cable Loss (dB)	Preamp Factor (dB)	Antenna Height (cm)	Table Angle (Degree)	Remark
31.94	26.41	44.63	40	-13.59	12.3	0.59	31.11	104	257	Peak
91.11	24.23	46.84	43.5	-19.27	8.38	0.97	31.96	120	182	Peak
156.1	22.84	40.77	43.5	-20.66	12.72	1.12	31.77	127	140	Peak
191.99	25.63	46.14	43.5	-17.87	9.91	1.27	31.69	129	205	Peak
287.05	21.4	38.95	46	-24.6	12.57	1.6	31.72	114	324	Peak
349.13	20.61	36.57	46	-25.39	14.12	1.76	31.84	131	13	Peak
Antennal Polarity & Test Distance: Vertical at 3 m										
Frequency (MHz)	Emission Level (dBuV/m)	Read Level (dBuV)	Limit (dBuV/m)	Margin (dB)	Antenna Factor (dB/m)	Cable Loss (dB)	Preamp Factor (dB)	Antenna Height (cm)	Table Angle (Degree)	Remark
32.91	37.26	55.28	40	-2.74	12.47	0.6	31.09	105	245	Peak
39.7	33.37	50.18	40	-6.63	13.54	0.64	30.99	139	205	Peak
66.86	30.46	50.17	40	-9.54	11.12	0.85	31.68	140	356	Peak
90.14	25.32	48.01	43.5	-18.18	8.3	0.97	31.96	111	223	Peak
152.22	21.66	39.49	43.5	-21.84	12.71	1.12	31.66	132	146	Peak
191.02	19.86	40.29	43.5	-23.64	9.98	1.27	31.68	110	102	Peak

Remarks:

- Emission Level = Read Level + Antenna Factor + Cable Loss - Preamp Factor
Margin value = Emission level – Limit value

Mode B
802.11n (HT20)

EUT Test Condition		Measurement Detail	
Channel	Channel 13	Frequency Range	30 MHz ~ 1 GHz
Input Power	120 Vac, 60 Hz	Detector Function	Peak (PK) Quasi-peak (QP)
Environmental Conditions	25 deg. C, 65 % RH	Tested By	Getaz Yang

Horizontal

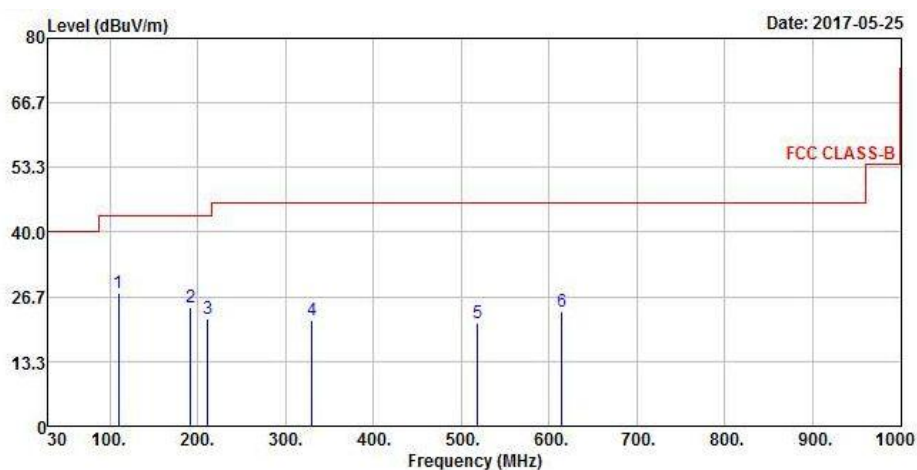

Vertical

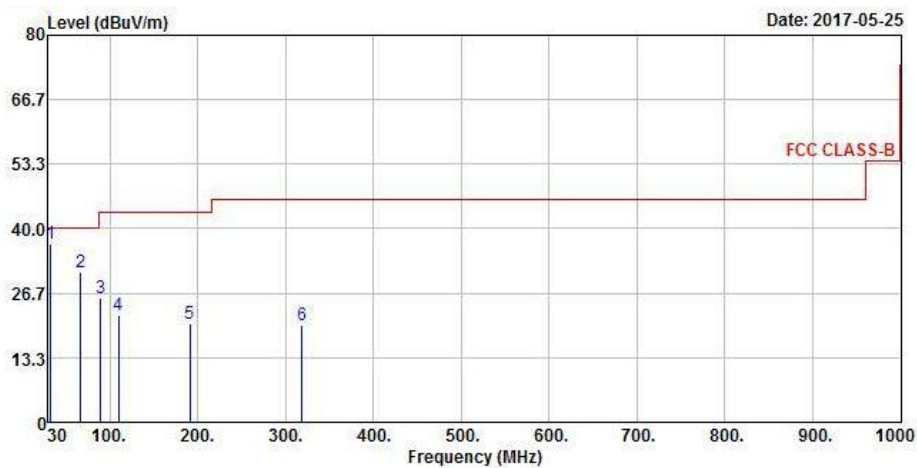

Antennal Polarity & Test Distance: Horizontal at 3 m										
Frequency (MHz)	Emission Level (dBuV/m)	Read Level (dBuV)	Limit (dBuV/m)	Margin (dB)	Antenna Factor (dB/m)	Cable Loss (dB)	Preamp Factor (dB)	Antenna Height (cm)	Table Angle (Degree)	Remark
109.54	27.36	48.11	43.5	-16.14	9.99	1.1	31.84	111	24	Peak
191.99	24.36	44.87	43.5	-19.14	9.91	1.27	31.69	132	31	Peak
211.39	21.99	42.4	43.5	-21.51	9.85	1.34	31.6	106	53	Peak
329.73	21.86	38.29	46	-24.14	13.66	1.72	31.81	135	133	Peak
518.88	21.18	32.88	46	-24.82	17.75	2.12	31.57	102	78	Peak
614.91	23.56	33.6	46	-22.44	19.79	2.29	32.12	100	145	Peak
Antennal Polarity & Test Distance: Vertical at 3 m										
Frequency (MHz)	Emission Level (dBuV/m)	Read Level (dBuV)	Limit (dBuV/m)	Margin (dB)	Antenna Factor (dB/m)	Cable Loss (dB)	Preamp Factor (dB)	Antenna Height (cm)	Table Angle (Degree)	Remark
32.91	36.77	54.79	40	-3.23	12.47	0.6	31.09	129	194	Peak
66.86	31	50.71	40	-9	11.12	0.85	31.68	101	311	Peak
89.17	25.68	48.35	43.5	-17.82	8.28	0.96	31.91	136	208	Peak
109.54	22.17	42.92	43.5	-21.33	9.99	1.1	31.84	101	305	Peak
191.02	20.26	40.69	43.5	-23.24	9.98	1.27	31.68	120	144	Peak
319.06	20.01	36.83	46	-25.99	13.4	1.68	31.9	103	157	Peak

Remarks:

- Emission Level = Read Level + Antenna Factor + Cable Loss - Preamp Factor
Margin value = Emission level – Limit value

Mode C
802.11n (HT20)

EUT Test Condition		Measurement Detail	
Channel	Channel 13	Frequency Range	30 MHz ~ 1 GHz
Input Power	120 Vac, 60 Hz	Detector Function	Peak (PK) Quasi-peak (QP)
Environmental Conditions	25 deg. C, 65 % RH	Tested By	Getaz Yang

Horizontal

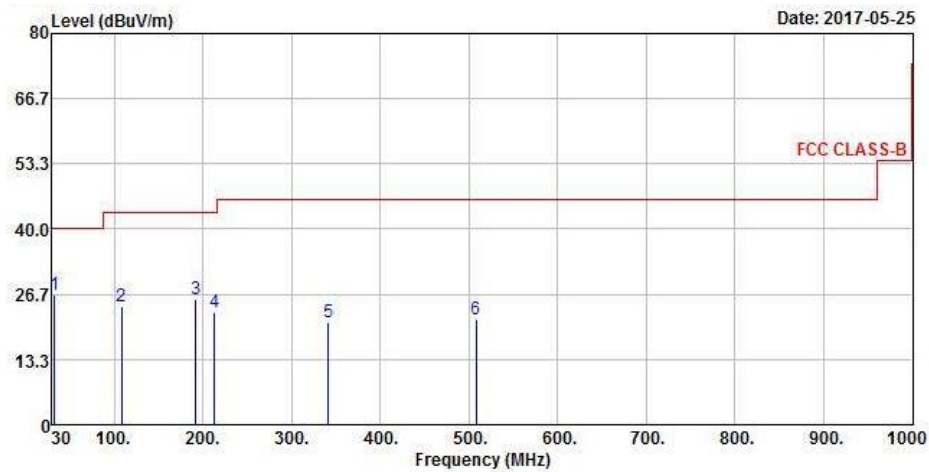

Vertical

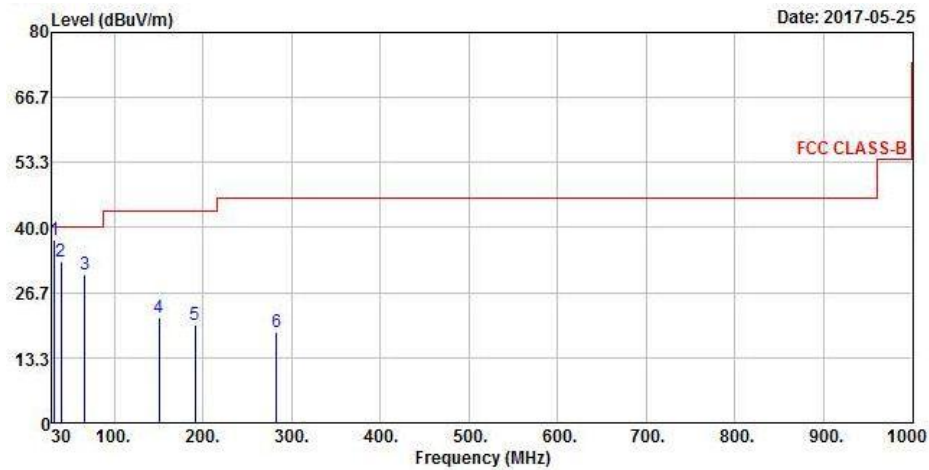

Antennal Polarity & Test Distance: Horizontal at 3 m

Frequency (MHz)	Emission Level (dBuV/m)	Read Level (dBuV)	Limit (dBuV/m)	Margin (dB)	Antenna Factor (dB/m)	Cable Loss (dB)	Preamp Factor (dB)	Antenna Height (cm)	Table Angle (Degree)	Remark
32.91	26.52	44.54	40	-13.48	12.47	0.6	31.09	200	0	Peak
108.57	24.35	45.2	43.5	-19.15	9.9	1.1	31.85	200	0	Peak
191.99	25.82	46.33	43.5	-17.68	9.91	1.27	31.69	200	0	Peak
213.33	23.04	43.39	43.5	-20.46	9.93	1.35	31.63	200	0	Peak
341.37	20.93	37.07	46	-25.07	13.94	1.74	31.82	200	0	Peak
508.21	21.58	33.56	46	-24.42	17.51	2.11	31.6	200	0	Peak

Antennal Polarity & Test Distance: Vertical at 3 m

Frequency (MHz)	Emission Level (dBuV/m)	Read Level (dBuV)	Limit (dBuV/m)	Margin (dB)	Antenna Factor (dB/m)	Cable Loss (dB)	Preamp Factor (dB)	Antenna Height (cm)	Table Angle (Degree)	Remark
32.91	37.63	55.65	40	-2.37	12.47	0.6	31.09	122	353	Peak
39.7	33.13	49.94	40	-6.87	13.54	0.64	30.99	128	179	Peak
66.86	30.54	50.25	40	-9.46	11.12	0.85	31.68	105	188	Peak
150.28	21.62	39.4	43.5	-21.88	12.71	1.12	31.61	115	289	Peak
191.02	20.21	40.64	43.5	-23.29	9.98	1.27	31.68	117	129	Peak
283.17	18.56	36.29	46	-27.44	12.45	1.59	31.77	137	170	Peak

Remarks:

- Emission Level = Read Level + Antenna Factor + Cable Loss - Preamp Factor
 Margin value = Emission level – Limit value

Mode D
802.11n (HT20)

EUT Test Condition		Measurement Detail	
Channel	Channel 13	Frequency Range	30 MHz ~ 1 GHz
Input Power	120 Vac, 60 Hz	Detector Function	Peak (PK) Quasi-peak (QP)
Environmental Conditions	25 deg. C, 65 % RH	Tested By	Getaz Yang

Horizontal

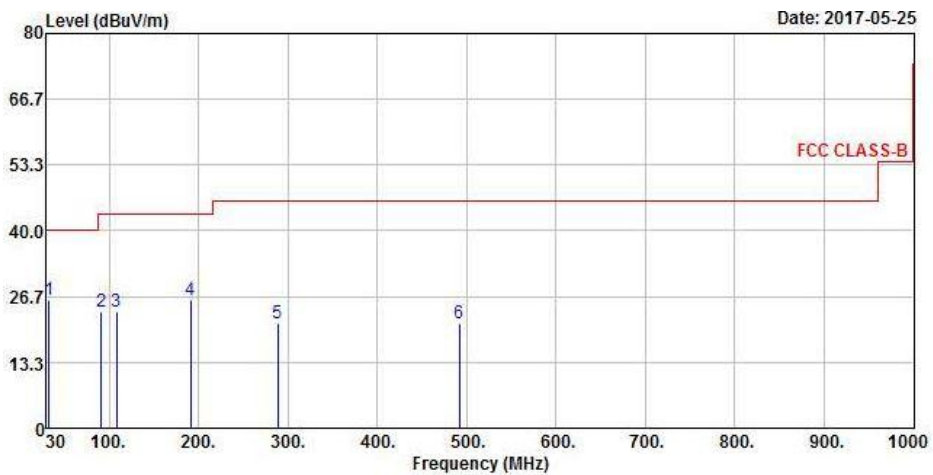

Vertical

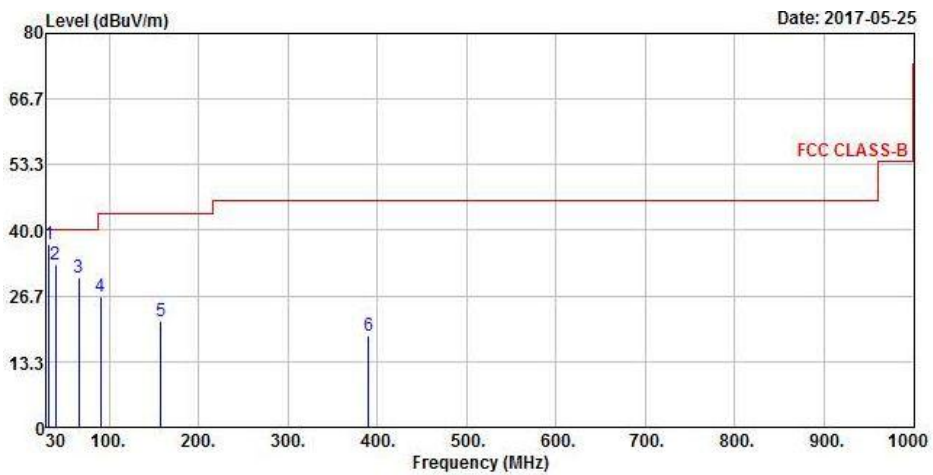

Antennal Polarity & Test Distance: Horizontal at 3 m										
Frequency (MHz)	Emission Level (dBuV/m)	Read Level (dBuV)	Limit (dBuV/m)	Margin (dB)	Antenna Factor (dB/m)	Cable Loss (dB)	Preamp Factor (dB)	Antenna Height (cm)	Table Angle (Degree)	Remark
32.91	25.86	43.88	40	-14.14	12.47	0.6	31.09	132	183	Peak
91.11	23.67	46.28	43.5	-19.83	8.38	0.97	31.96	136	170	Peak
108.57	23.58	44.43	43.5	-19.92	9.9	1.1	31.85	112	122	Peak
191.02	25.87	46.3	43.5	-17.63	9.98	1.27	31.68	122	232	Peak
288.99	21.2	38.64	46	-24.8	12.63	1.61	31.68	125	186	Peak
491.72	21.17	33.67	46	-24.83	17.16	2.08	31.74	126	75	Peak
Antennal Polarity & Test Distance: Vertical at 3 m										
Frequency (MHz)	Emission Level (dBuV/m)	Read Level (dBuV)	Limit (dBuV/m)	Margin (dB)	Antenna Factor (dB/m)	Cable Loss (dB)	Preamp Factor (dB)	Antenna Height (cm)	Table Angle (Degree)	Remark
32.91	37.27	55.29	40	-2.73	12.47	0.6	31.09	127	75	Peak
39.7	33.03	49.84	40	-6.97	13.54	0.64	30.99	134	340	Peak
65.89	30.46	50.01	40	-9.54	11.24	0.85	31.64	110	16	Peak
90.14	26.45	49.14	43.5	-17.05	8.3	0.97	31.96	101	257	Peak
158.04	21.6	39.57	43.5	-21.9	12.73	1.13	31.83	105	70	Peak
389.87	18.72	33.78	46	-27.28	15.1	1.88	32.04	114	336	Peak

Remarks:

- Emission Level = Read Level + Antenna Factor + Cable Loss - Preamp Factor
Margin value = Emission level – Limit value

4.2 Conducted Emission Measurement

4.2.1 Limits of Conducted Emission Measurement

Frequency (MHz)	Conducted Limit (dBuV)	
	Quasi-peak	Average
0.15 - 0.5	66 - 56	56 - 46
0.50 - 5.0	56	46
5.0 - 30.0	60	50

Note: 1. The lower limit shall apply at the transition frequencies.

2. The limit decreases in line with the logarithm of the frequency in the range of 0.15 to 0.50 MHz.

4.2.2 Test Instruments

Description & Manufacturer	Model No.	Serial No.	Date of Calibration	Due Date of Calibration
Test Receiver ROHDE & SCHWARZ	ESCI	100613	Nov. 21, 2016	Nov. 20, 2017
RF signal cable (with 10dB PAD) Woken	5D-FB	Cable-cond1-01	Dec. 22, 2016	Dec. 21, 2017
LISN ROHDE & SCHWARZ (EUT)	ESH3-Z5	835239/001	Mar. 10, 2017	Mar. 09, 2018
LISN ROHDE & SCHWARZ (Peripheral)	ESH3-Z5	100311	Jul. 28, 2016	Jul. 27, 2017
Software ADT	BV ADT_Cond_ V7.3.7.3	NA	NA	NA

Note: 1. The calibration interval of the above test instruments is 12 months and the calibrations are traceable to NML/ROC and NIST/USA.

2. The test was performed in HwaYa Shielded Room 1.

3. The VCCI Site Registration No. is C-2040.

4.2.3 Test Procedures

- a. The EUT was placed 0.4 meters from the conducting wall of the shielded room with EUT being connected to the power mains through a line impedance stabilization network (LISN). Other support units were connected to the power mains through another LISN. The two LISNs provide 50 ohm/50 uH of coupling impedance for the measuring instrument.
- b. Both lines of the power mains connected to the EUT were checked for maximum conducted interference.
- c. The frequency range from 150 kHz to 30 MHz was searched. Emission levels under (Limit – 20 dB) was not recorded.

NOTE: All modes of operation were investigated and the worst-case emissions are reported.

4.2.4 Deviation from Test Standard

No deviation.

4.2.5 Test Setup

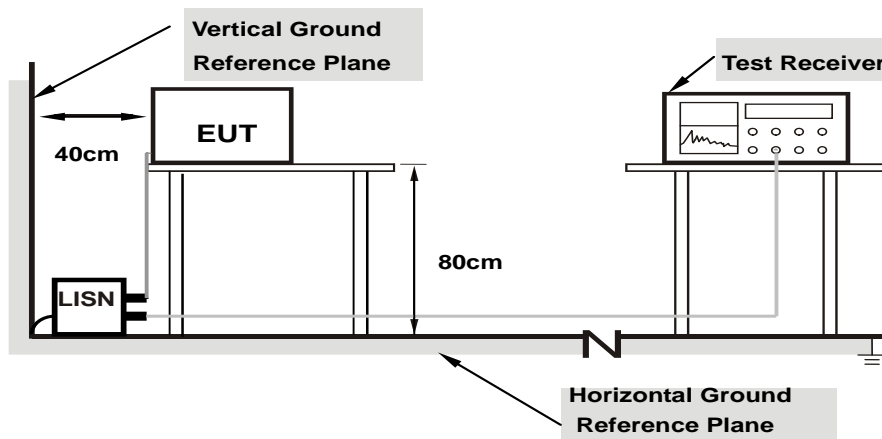

Note: 1. Support units were connected to second LISN.

For the actual test configuration, please refer to the attached file (Test Setup Photo).

4.2.6 EUT Operating Conditions

- a. Placed the EUT on a testing table.
- b. Use the software to control the EUT under transmission condition continuously at specific channel frequency.

4.2.7 Test Results

Mode A

Frequency Range	150kHz ~ 30MHz	Detector Function & Resolution Bandwidth	Quasi-Peak (QP) / Average (AV), 9kHz
Input Power	120Vac, 60Hz	Environmental Conditions	25°C, 65%RH
Tested by	Getaz Yang	Test Date	2017/5/26

Phase Of Power : Line (L)										
No	Frequency (MHz)	Correction Factor (dB)	Reading Value (dBuV)		Emission Level (dBuV)		Limit (dBuV)		Margin (dB)	
			Q.P.	AV.	Q.P.	AV.	Q.P.	AV.	Q.P.	AV.
1	0.15400	10.35	35.54	26.67	45.89	37.02	65.78	55.78	-19.89	-18.76
2	0.79000	10.40	33.03	26.23	43.43	36.63	56.00	46.00	-12.57	-9.37
3	1.72600	10.44	27.49	17.40	37.93	27.84	56.00	46.00	-18.07	-18.16
4	2.04200	10.46	37.06	32.72	47.52	43.18	56.00	46.00	-8.48	-2.82
5	2.67400	10.50	35.42	30.49	45.92	40.99	56.00	46.00	-10.08	-5.01
6	4.07400	10.57	30.88	24.41	41.45	34.98	56.00	46.00	-14.55	-11.02

Remarks:

1. Q.P. and AV. are abbreviations of quasi-peak and average individually.
2. The emission levels of other frequencies were very low against the limit.
3. Margin value = Emission level – Limit value
4. Correction factor = Insertion loss + Cable loss
5. Emission Level = Correction Factor + Reading Value

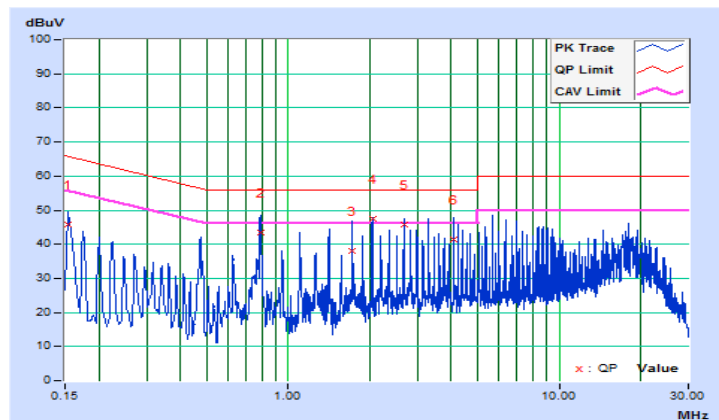

Frequency Range	150kHz ~ 30MHz	Detector Function & Resolution Bandwidth	Quasi-Peak (QP) / Average (AV), 9kHz
Input Power	120Vac, 60Hz	Environmental Conditions	25°C, 65%RH
Tested by	Getaz Yang	Test Date	2017/5/26

Phase Of Power : Neutral (N)										
No	Frequency (MHz)	Correction Factor (dB)	Reading Value (dBuV)		Emission Level (dBuV)		Limit (dBuV)		Margin (dB)	
			Q.P.	AV.	Q.P.	AV.	Q.P.	AV.	Q.P.	AV.
1	0.47000	10.16	37.36	33.31	47.52	43.47	56.51	46.51	-8.99	-3.04
2	1.09400	10.18	39.60	34.25	49.78	44.43	56.00	46.00	-6.22	-1.57
3	1.40600	10.19	13.79	6.20	23.98	16.39	56.00	46.00	-32.02	-29.61
4	1.71000	10.21	16.99	9.12	27.20	19.33	56.00	46.00	-28.80	-26.67
5	2.03000	10.23	25.23	20.04	35.46	30.27	56.00	46.00	-20.54	-15.73
6	2.66200	10.27	37.32	26.11	47.59	36.38	56.00	46.00	-8.41	-9.62

Remarks:

1. Q.P. and AV. are abbreviations of quasi-peak and average individually.
2. The emission levels of other frequencies were very low against the limit.
3. Margin value = Emission level – Limit value
4. Correction factor = Insertion loss + Cable loss
5. Emission Level = Correction Factor + Reading Value

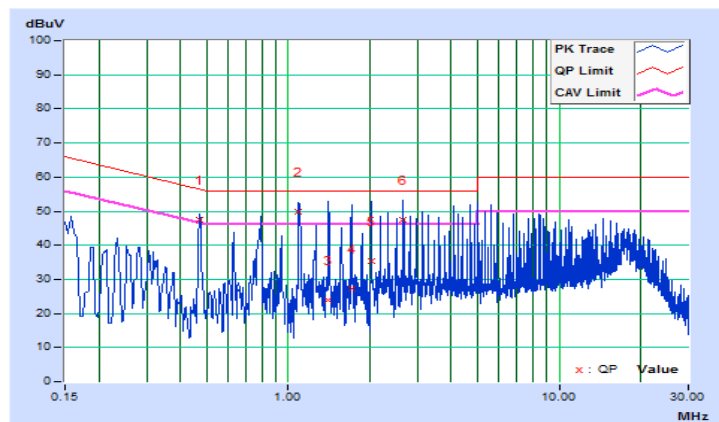

Mode B

Frequency Range	150kHz ~ 30MHz	Detector Function & Resolution Bandwidth	Quasi-Peak (QP) / Average (AV), 9kHz
Input Power	120Vac, 60Hz	Environmental Conditions	25°C, 65%RH
Tested by	Getaz Yang	Test Date	2017/5/26

Phase Of Power : Line (L)										
No	Frequency (MHz)	Correction Factor (dB)	Reading Value (dBuV)		Emission Level (dBuV)		Limit (dBuV)		Margin (dB)	
			Q.P.	AV.	Q.P.	AV.	Q.P.	AV.	Q.P.	AV.
1	0.46200	10.40	33.37	28.97	43.77	39.37	56.66	46.66	-12.89	-7.29
2	0.76618	10.40	36.37	32.05	46.77	42.45	56.00	46.00	-9.23	-3.55
3	1.37800	10.42	36.61	32.61	47.03	43.03	56.00	46.00	-8.97	-2.97
4	1.68600	10.44	35.98	31.93	46.42	42.37	56.00	46.00	-9.58	-3.63
5	2.29800	10.48	36.27	32.27	46.75	42.75	56.00	46.00	-9.25	-3.25
6	2.91000	10.51	36.21	32.28	46.72	42.79	56.00	46.00	-9.28	-3.21

Remarks:

1. Q.P. and AV. are abbreviations of quasi-peak and average individually.
2. The emission levels of other frequencies were very low against the limit.
3. Margin value = Emission level – Limit value
4. Correction factor = Insertion loss + Cable loss
5. Emission Level = Correction Factor + Reading Value

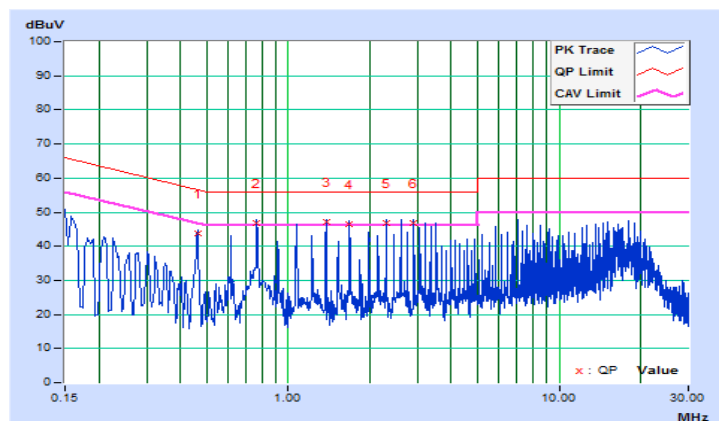

Frequency Range	150kHz ~ 30MHz	Detector Function & Resolution Bandwidth	Quasi-Peak (QP) / Average (AV), 9kHz
Input Power	120Vac, 60Hz	Environmental Conditions	25°C, 65%RH
Tested by	Getaz Yang	Test Date	2017/5/26

Phase Of Power : Neutral (N)										
No	Frequency (MHz)	Correction Factor (dB)	Reading Value (dBuV)		Emission Level (dBuV)		Limit (dBuV)		Margin (dB)	
			Q.P.	AV.	Q.P.	AV.	Q.P.	AV.	Q.P.	AV.
1	0.45837	10.16	39.88	35.64	50.04	45.80	56.72	46.72	-6.68	-0.92
2	0.76600	10.17	40.48	35.50	50.65	45.67	56.00	46.00	-5.35	-0.33
3	1.07063	10.17	40.19	34.38	50.36	44.55	56.00	46.00	-5.64	-1.45
4	1.37800	10.19	40.98	34.15	51.17	44.34	56.00	46.00	-4.83	-1.66
5	1.68200	10.21	39.33	33.38	49.54	43.59	56.00	46.00	-6.46	-2.41
6	2.60200	10.26	40.58	34.55	50.84	44.81	56.00	46.00	-5.16	-1.19

Remarks:

1. Q.P. and AV. are abbreviations of quasi-peak and average individually.
2. The emission levels of other frequencies were very low against the limit.
3. Margin value = Emission level – Limit value
4. Correction factor = Insertion loss + Cable loss
5. Emission Level = Correction Factor + Reading Value

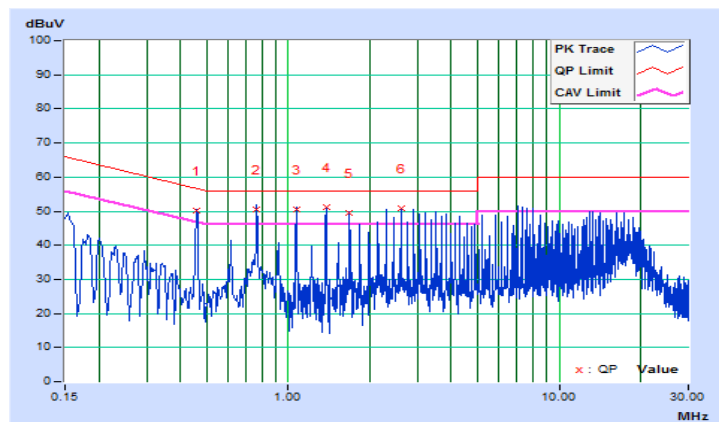

Mode C

Frequency Range	150kHz ~ 30MHz	Detector Function & Resolution Bandwidth	Quasi-Peak (QP) / Average (AV), 9kHz
Input Power	120Vac, 60Hz	Environmental Conditions	25°C, 65%RH
Tested by	Getaz Yang	Test Date	2017/5/26

Phase Of Power : Line (L)										
No	Frequency (MHz)	Correction Factor (dB)	Reading Value (dBuV)		Emission Level (dBuV)		Limit (dBuV)		Margin (dB)	
			Q.P.	AV.	Q.P.	AV.	Q.P.	AV.	Q.P.	AV.
1	0.46600	10.40	35.27	30.82	45.67	41.22	56.58	46.58	-10.91	-5.36
2	0.77800	10.40	35.72	31.42	46.12	41.82	56.00	46.00	-9.88	-4.18
3	1.09000	10.41	36.32	32.16	46.73	42.57	56.00	46.00	-9.27	-3.43
4	1.72200	10.44	18.45	10.07	28.89	20.51	56.00	46.00	-27.11	-25.49
5	2.03800	10.46	20.38	12.75	30.84	23.21	56.00	46.00	-25.16	-22.79
6	3.75000	10.56	33.58	29.73	44.14	40.29	56.00	46.00	-11.86	-5.71

Remarks:

1. Q.P. and AV. are abbreviations of quasi-peak and average individually.
2. The emission levels of other frequencies were very low against the limit.
3. Margin value = Emission level – Limit value
4. Correction factor = Insertion loss + Cable loss
5. Emission Level = Correction Factor + Reading Value

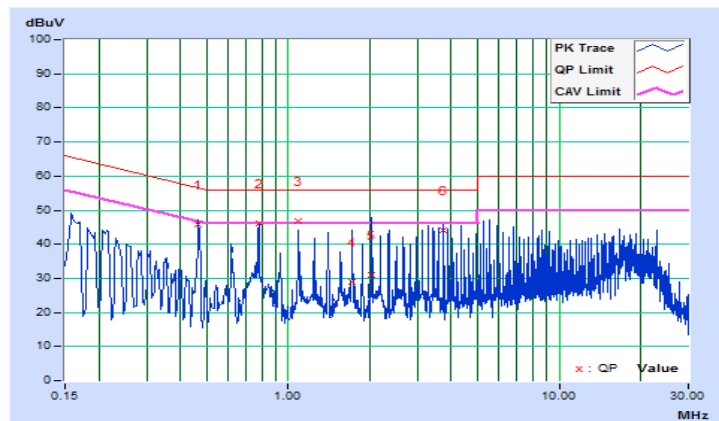

Frequency Range	150kHz ~ 30MHz	Detector Function & Resolution Bandwidth	Quasi-Peak (QP) / Average (AV), 9kHz
Input Power	120Vac, 60Hz	Environmental Conditions	25°C, 65%RH
Tested by	Getaz Yang	Test Date	2017/5/26

Phase Of Power : Neutral (N)										
No	Frequency (MHz)	Correction Factor (dB)	Reading Value (dBuV)		Emission Level (dBuV)		Limit (dBuV)		Margin (dB)	
			Q.P.	AV.	Q.P.	AV.	Q.P.	AV.	Q.P.	AV.
1	0.47810	10.16	16.23	11.06	26.39	21.22	56.37	46.37	-29.98	-25.15
2	1.09400	10.18	39.32	34.50	49.50	44.68	56.00	46.00	-6.50	-1.32
3	1.40600	10.19	40.07	34.97	50.26	45.16	56.00	46.00	-5.74	-0.84
4	1.74200	10.21	16.39	8.47	26.60	18.68	56.00	46.00	-29.40	-27.32
5	2.03000	10.23	27.57	23.28	37.80	33.51	56.00	46.00	-18.20	-12.49
6	4.06200	10.34	38.89	32.87	49.23	43.21	56.00	46.00	-6.77	-2.79

Remarks:

1. Q.P. and AV. are abbreviations of quasi-peak and average individually.
2. The emission levels of other frequencies were very low against the limit.
3. Margin value = Emission level – Limit value
4. Correction factor = Insertion loss + Cable loss
5. Emission Level = Correction Factor + Reading Value

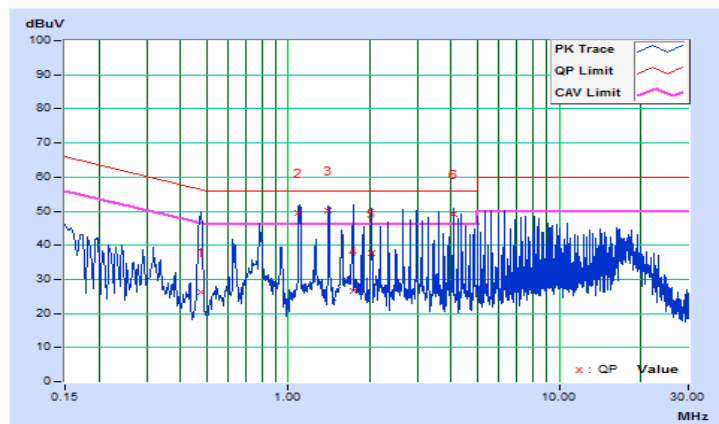

Mode D

Frequency Range	150kHz ~ 30MHz	Detector Function & Resolution Bandwidth	Quasi-Peak (QP) / Average (AV), 9kHz
Input Power	120Vac, 60Hz	Environmental Conditions	25°C, 65%RH
Tested by	Getaz Yang	Test Date	2017/5/26

Phase Of Power : Line (L)										
No	Frequency (MHz)	Correction Factor (dB)	Reading Value (dBuV)		Emission Level (dBuV)		Limit (dBuV)		Margin (dB)	
			Q.P.	AV.	Q.P.	AV.	Q.P.	AV.	Q.P.	AV.
1	0.50600	10.40	35.78	31.49	46.18	41.89	56.00	46.00	-9.82	-4.11
2	0.84600	10.40	35.75	31.42	46.15	41.82	56.00	46.00	-9.85	-4.18
3	1.15400	10.41	9.79	4.07	20.20	14.48	56.00	46.00	-35.80	-31.52
4	2.12600	10.47	13.16	7.11	23.63	17.58	56.00	46.00	-32.37	-28.42
5	3.62600	10.55	10.98	4.82	21.53	15.37	56.00	46.00	-34.47	-30.63
6	4.96200	10.61	10.02	3.51	20.63	14.12	56.00	46.00	-35.37	-31.88

Remarks:

1. Q.P. and AV. are abbreviations of quasi-peak and average individually.
2. The emission levels of other frequencies were very low against the limit.
3. Margin value = Emission level – Limit value
4. Correction factor = Insertion loss + Cable loss
5. Emission Level = Correction Factor + Reading Value

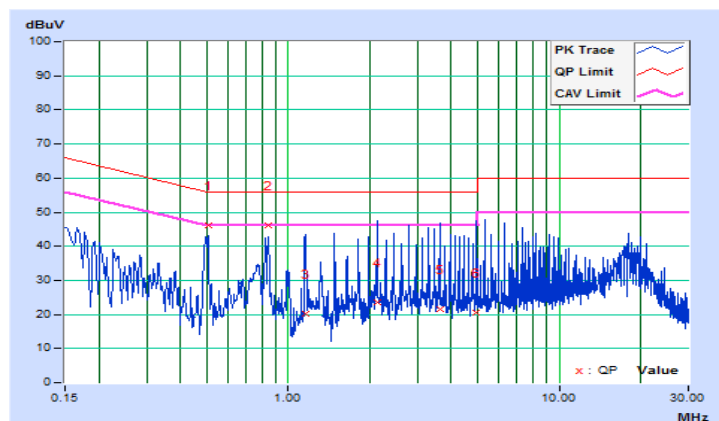

Frequency Range	150kHz ~ 30MHz	Detector Function & Resolution Bandwidth	Quasi-Peak (QP) / Average (AV), 9kHz
Input Power	120Vac, 60Hz	Environmental Conditions	25°C, 65%RH
Tested by	Getaz Yang	Test Date	2017/5/26

Phase Of Power : Neutral (N)										
No	Frequency (MHz)	Correction Factor (dB)	Reading Value (dBuV)		Emission Level (dBuV)		Limit (dBuV)		Margin (dB)	
			Q.P.	AV.	Q.P.	AV.	Q.P.	AV.	Q.P.	AV.
1	0.50663	10.16	36.94	33.02	47.10	43.18	56.00	46.00	-8.90	-2.82
2	0.84600	10.17	34.78	30.79	44.95	40.96	56.00	46.00	-11.05	-5.04
3	1.17800	10.18	36.66	30.21	46.84	40.39	56.00	46.00	-9.16	-5.61
4	1.52600	10.20	29.13	24.52	39.33	34.72	56.00	46.00	-16.67	-11.28
5	2.19800	10.24	17.72	8.63	27.96	18.87	56.00	46.00	-28.04	-27.13
6	4.02200	10.34	38.98	34.94	49.32	45.28	56.00	46.00	-6.68	-0.72

Remarks:

1. Q.P. and AV. are abbreviations of quasi-peak and average individually.
2. The emission levels of other frequencies were very low against the limit.
3. Margin value = Emission level – Limit value
4. Correction factor = Insertion loss + Cable loss
5. Emission Level = Correction Factor + Reading Value

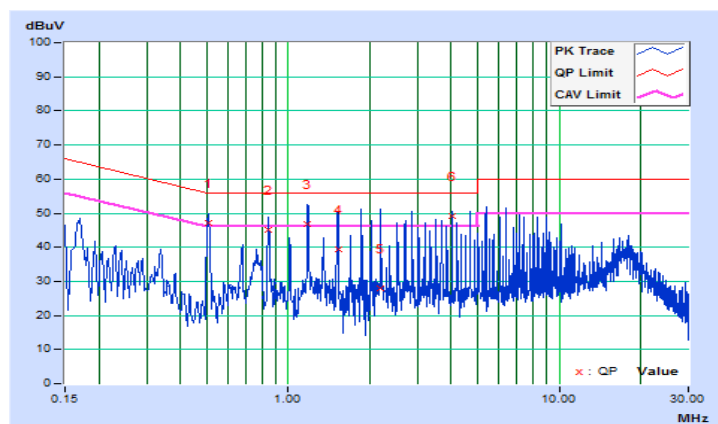

4.3 6 dB Bandwidth Measurement

4.3.1 Limits of 6 dB Bandwidth Measurement

The minimum of 6 dB Bandwidth Measurement is 0.5 MHz.

4.3.2 Test Setup

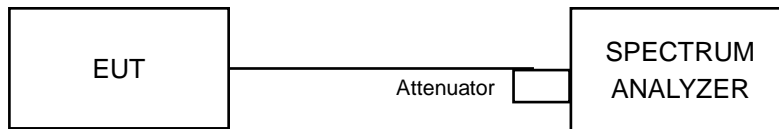

4.3.3 Test Instruments

Refer to section 4.1.2 to get information of above instrument.

4.3.4 Test Procedure

- Set resolution bandwidth (RBW) = 100 kHz
- Set the video bandwidth (VBW) $\geq 3 \times$ RBW, Detector = Peak.
- Trace mode = max hold.
- Sweep = auto couple.
- Measure the maximum width of the emission that is constrained by the frequencies associated with the two amplitude points (upper and lower) that are attenuated by 6 dB relative to the maximum level measured in the fundamental emission

4.3.5 Deviation from Test Standard

No deviation.

4.3.6 EUT Operating Conditions

The software provided by client to enable the EUT under transmission condition continuously at lowest, middle and highest channel frequencies individually.

4.3.7 Test Result

802.11b

Channel	Frequency (MHz)	6 dB Bandwidth (MHz)	Minimum Limit (MHz)	Pass / Fail
1	2412	8.59	0.5	Pass
6	2437	8.10	0.5	Pass
11	2462	8.08	0.5	Pass
12	2467	8.11	0.5	Pass
13	2472	8.57	0.5	Pass

802.11g

Channel	Frequency (MHz)	6 dB Bandwidth (MHz)	Minimum Limit (MHz)	Pass / Fail
1	2412	16.39	0.5	Pass
6	2437	16.42	0.5	Pass
11	2462	16.41	0.5	Pass
12	2467	16.42	0.5	Pass
13	2472	16.42	0.5	Pass

802.11n (HT20)

Channel	Frequency (MHz)	6 dB Bandwidth (MHz)	Minimum Limit (MHz)	Pass / Fail
1	2412	17.61	0.5	Pass
6	2437	17.64	0.5	Pass
11	2462	17.64	0.5	Pass
12	2467	17.65	0.5	Pass
13	2472	17.66	0.5	Pass

Spectrum Plot of Worst Value

802.11b

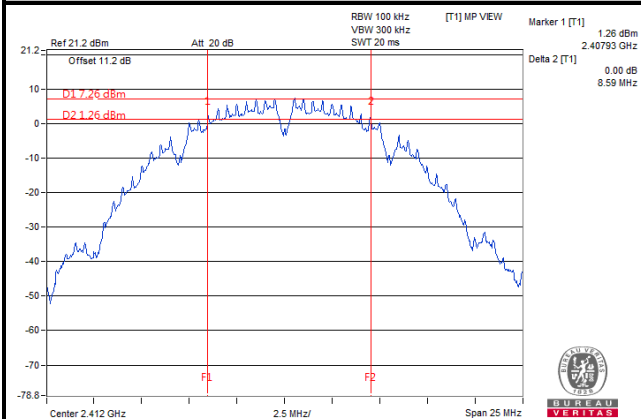

802.11g

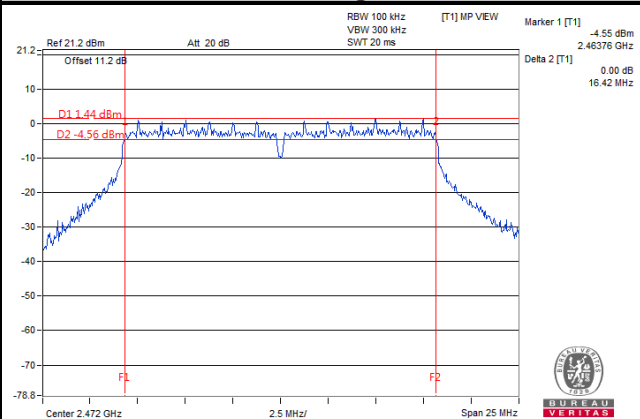

802.11n (HT20)

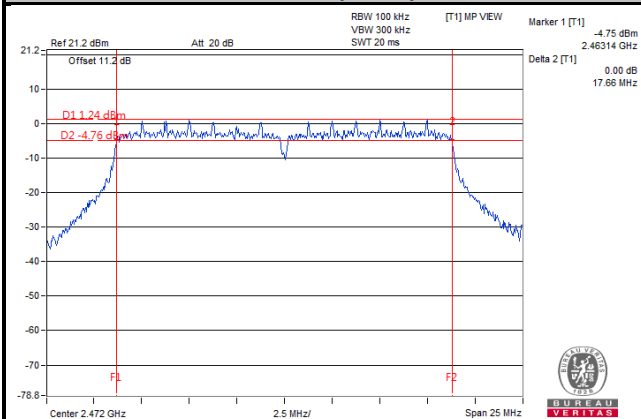

4.4 Conducted Output Power Measurement

4.4.1 Limits of Conducted Output Power Measurement

For systems using digital modulation in the 2400–2483.5 MHz bands: 1 Watt (30 dBm)

4.4.2 Test Setup

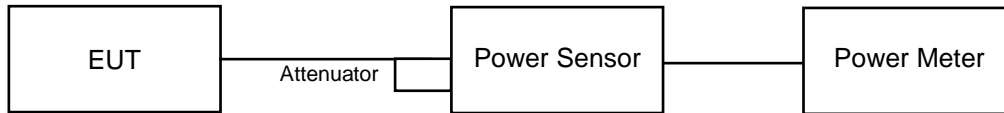

4.4.3 Test Instruments

Refer to section 4.1.2 to get information of above instrument.

4.4.4 Test Procedures

A peak power sensor was used on the output port of the EUT. A power meter was used to read the response of the peak power sensor. Record the power level.

4.4.5 Deviation from Test Standard

No deviation.

4.4.6 EUT Operating Conditions

The software provided by client to enable the EUT under transmission condition continuously at lowest, middle and highest channel frequencies individually.

4.4.7 Test Results

802.11b

Channel	Frequency (MHz)	Peak Power (mW)	Peak Power (dBm)	Limit (dBm)	Pass / Fail
1	2412	57.016	17.56	30	Pass
6	2437	53.211	17.26	30	Pass
11	2462	59.841	17.77	30	Pass
12	2467	52.602	17.21	30	Pass
13	2472	56.494	17.52	30	Pass

802.11g

Channel	Frequency (MHz)	Peak Power (mW)	Peak Power (dBm)	Limit (dBm)	Pass / Fail
1	2412	65.615	18.17	30	Pass
6	2437	76.033	18.81	30	Pass
11	2462	71.614	18.55	30	Pass
12	2467	74.989	18.75	30	Pass
13	2472	72.611	18.61	30	Pass

802.11n (HT20)

Channel	Frequency (MHz)	Peak Power (mW)	Peak Power (dBm)	Limit (dBm)	Pass / Fail
1	2412	79.25	18.99	30	Pass
6	2437	81.283	19.10	30	Pass
11	2462	79.433	19.00	30	Pass
12	2467	77.983	18.92	30	Pass
13	2472	76.736	18.85	30	Pass

4.5 Power Spectral Density Measurement

4.5.1 Limits of Power Spectral Density Measurement

The Maximum of Power Spectral Density Measurement is 8 dBm.

4.5.2 Test Setup

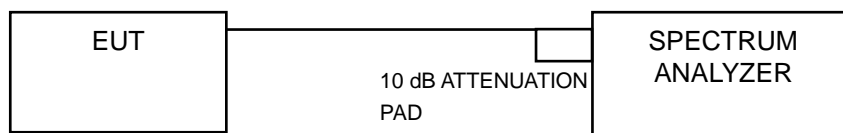

4.5.3 Test Instruments

Refer to section 4.1.2 to get information of above instrument.

4.5.4 Test Procedure

- a. Set analyzer center frequency to DTS channel center frequency.
- b. Set the span to 1.5 times the DTS bandwidth.
- c. Set the RBW to: $3 \text{ kHz} \leq \text{RBW} \leq 100 \text{ kHz}$.
- d. Set the VBW $\geq 3 \times \text{RBW}$.
- e. Detector = peak.
- f. Sweep time = auto couple.
- g. Trace mode = max hold.
- h. Allow trace to fully stabilize.
- i. Use the peak marker function to determine the maximum amplitude level within the RBW.

4.5.5 Deviation from Test Standard

No deviation.

4.5.6 EUT Operating Condition

The software provided by client to enable the EUT under transmission condition continuously at lowest, middle and highest channel frequencies individually.

4.5.7 Test Results

802.11b

Channel	Frequency (MHz)	PSD (dBm/3 kHz)	Limit (dBm/3 kHz)	Pass / Fail
1	2412	-7.28	8	Pass
6	2437	-6.91	8	Pass
11	2462	-6.59	8	Pass
12	2467	-6.97	8	Pass
13	2472	-7.19	8	Pass

802.11g

Channel	Frequency (MHz)	PSD (dBm/3 kHz)	Limit (dBm/3 kHz)	Pass / Fail
1	2412	-13.43	8	Pass
6	2437	-13.95	8	Pass
11	2462	-13.82	8	Pass
12	2467	-13.10	8	Pass
13	2472	-13.72	8	Pass

802.11n (HT20)

Channel	Frequency (MHz)	PSD (dBm/3 kHz)	Limit (dBm/3 kHz)	Pass / Fail
1	2412	-14.23	8	Pass
6	2437	-14.58	8	Pass
11	2462	-14.83	8	Pass
12	2467	-13.35	8	Pass
13	2472	-13.73	8	Pass

Spectrum Plot of Worst Value

802.11b

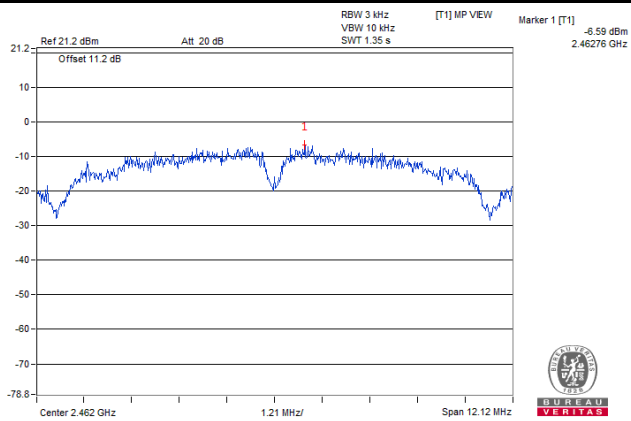

802.11g

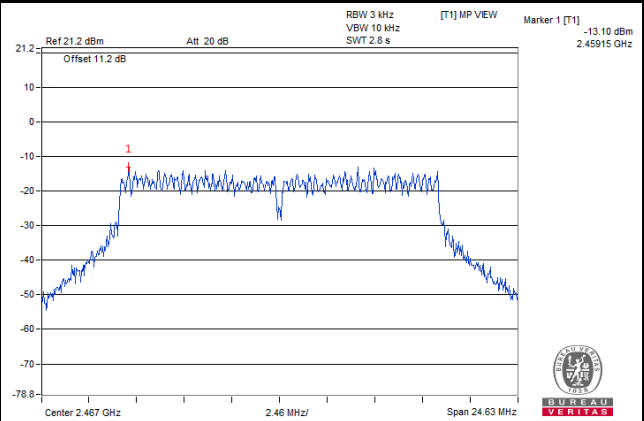

802.11n (HT20)

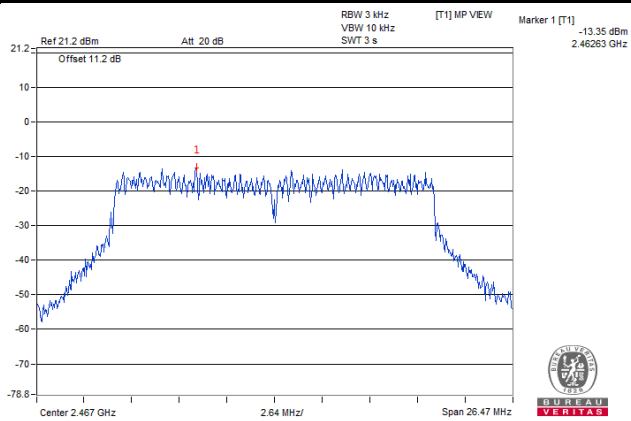

4.6 Conducted Out of Band Emission Measurement

4.6.1 Limits of Conducted Out of Band Emission Measurement

Below 20 dB of the highest emission level of operating band (in 100 kHz Resolution Bandwidth).

4.6.2 Test Setup

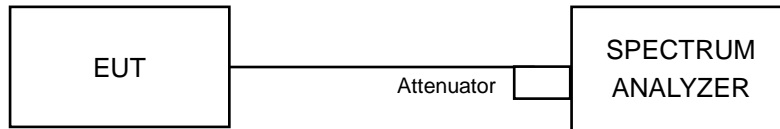

4.6.3 Test Instruments

Refer to section 4.1.2 to get information of above instrument.

4.6.4 Test Procedure

MEASUREMENT PROCEDURE REF

1. Set the RBW = 100 kHz.
2. Set the VBW \geq 300 kHz.
3. Detector = peak.
4. Sweep time = auto couple.
5. Trace mode = max hold.
6. Allow trace to fully stabilize.
7. Use the peak marker function to determine the maximum power level in any 100 kHz band segment within the fundamental EBW.

MEASUREMENT PROCEDURE OOB

1. Set RBW = 100 kHz.
2. Set VBW \geq 300 kHz.
3. Detector = peak.
4. Sweep = auto couple.
5. Trace Mode = max hold.
6. Allow trace to fully stabilize.
7. Use the peak marker function to determine the maximum amplitude level.

4.6.5 Deviation from Test Standard

No deviation.

4.6.6 EUT Operating Condition

The software provided by client to enable the EUT under transmission condition continuously at lowest, middle and highest channel frequencies individually.

4.6.7 Test Results

The spectrum plots are attached on the following images. D1 line indicates the highest level, and D2 line indicates the 20 dB offset below D1. It shows compliance with the requirement.

802.11b

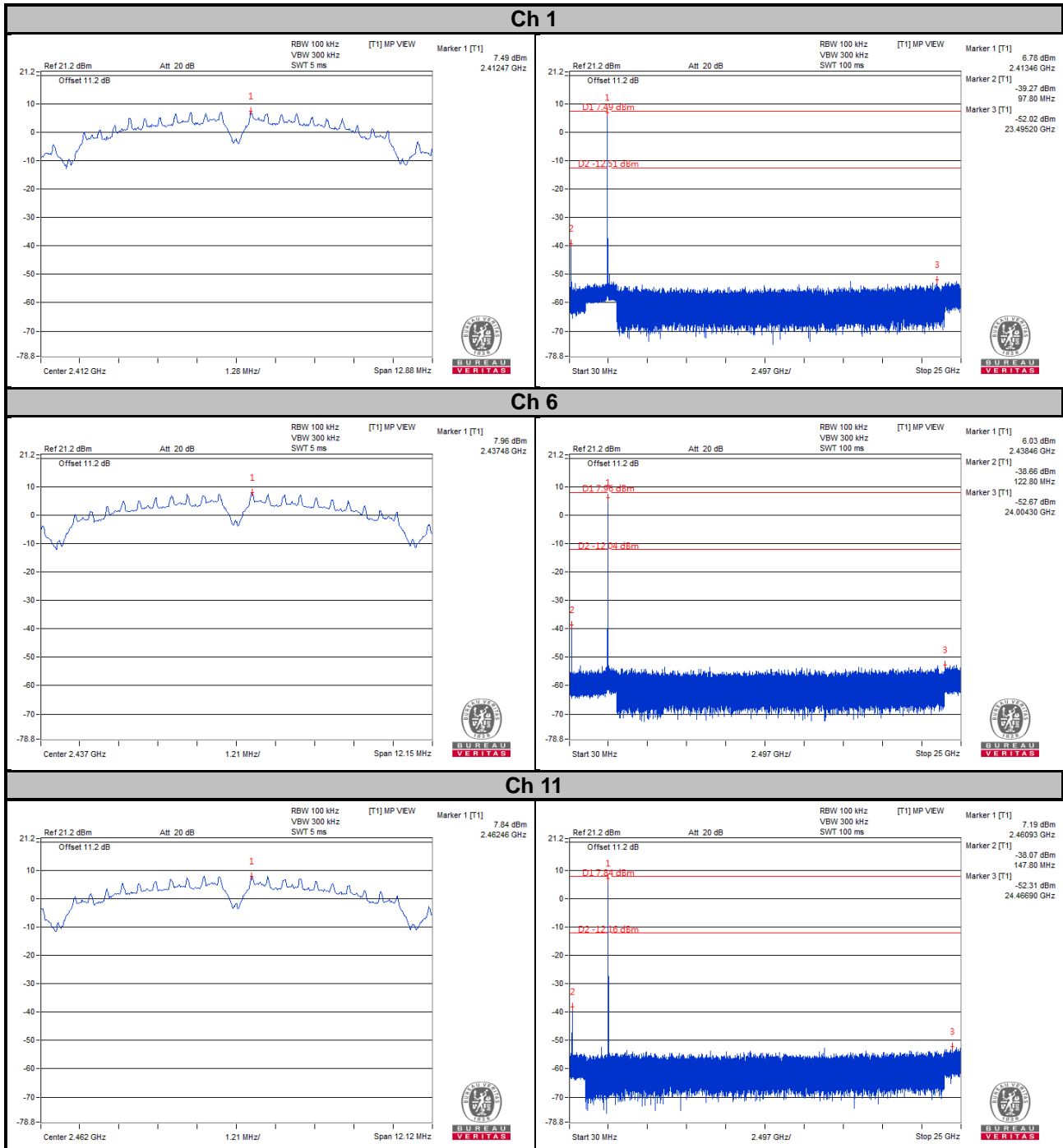

Ch 12

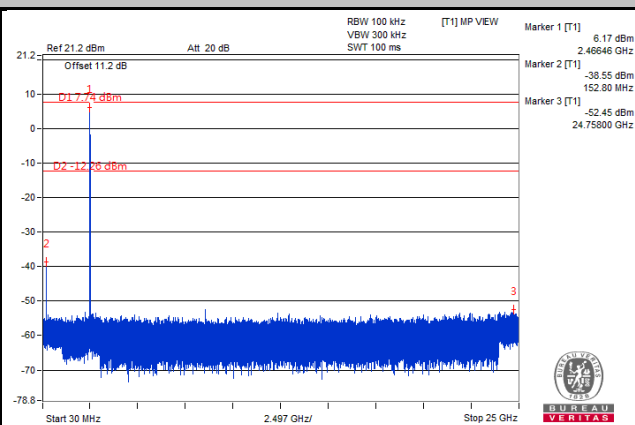
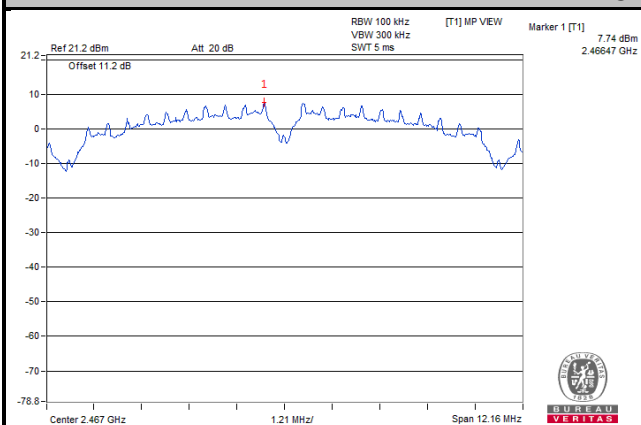

Ch 13

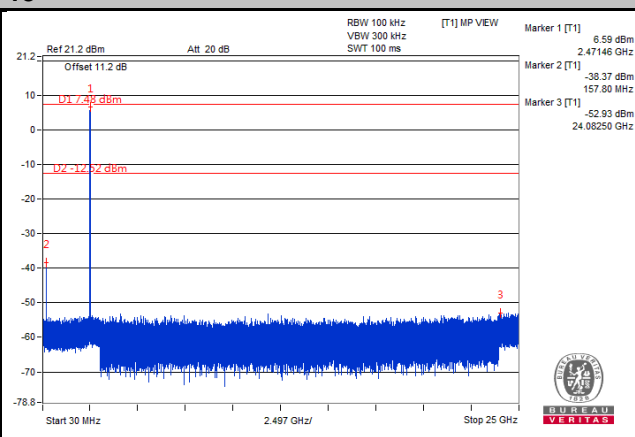
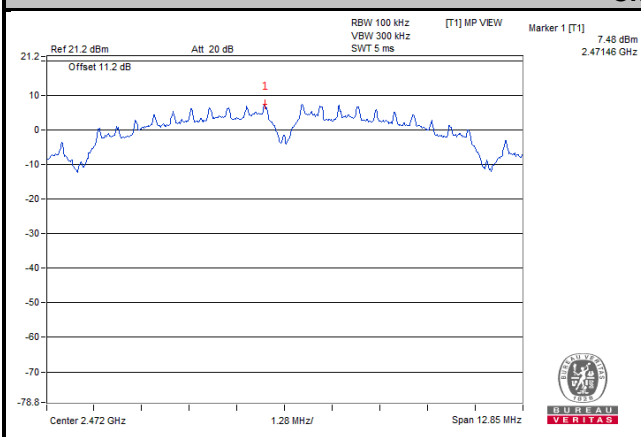

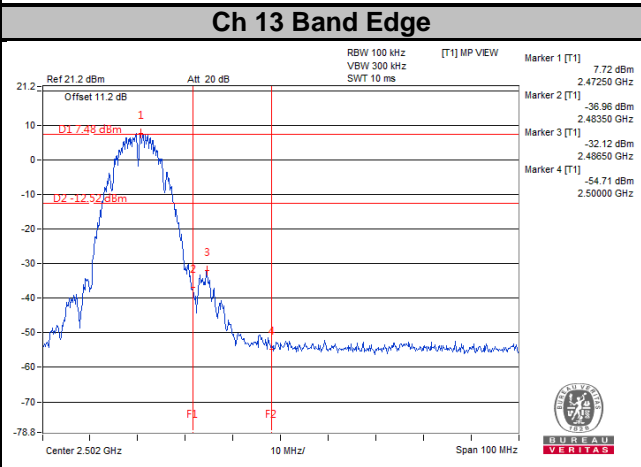
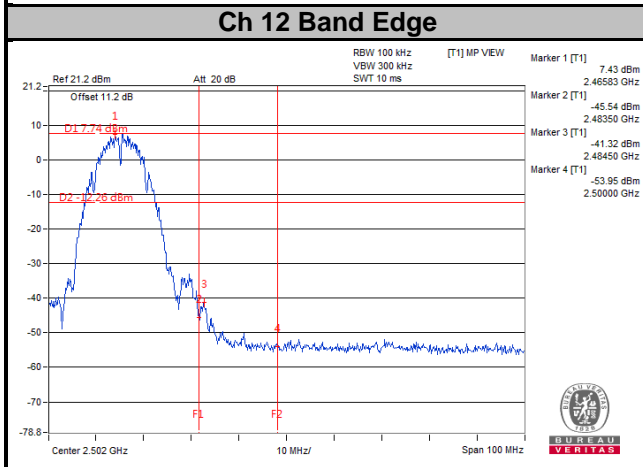
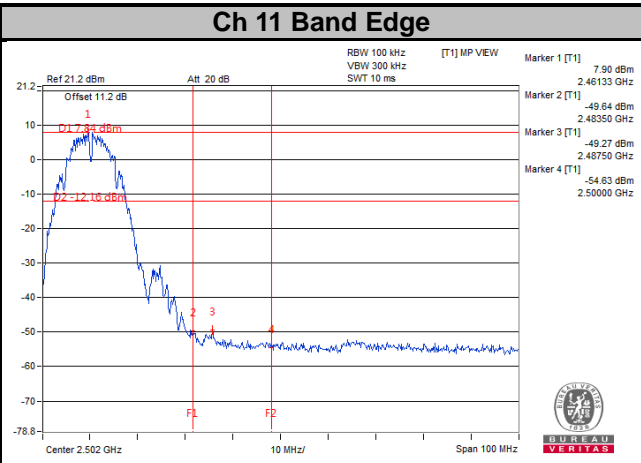
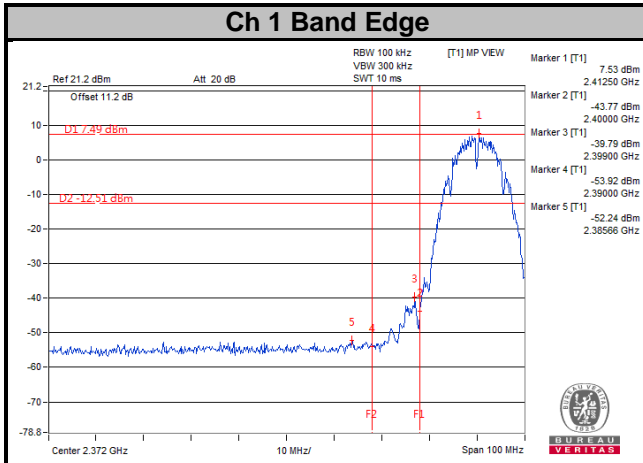

802.11g

Ch 1

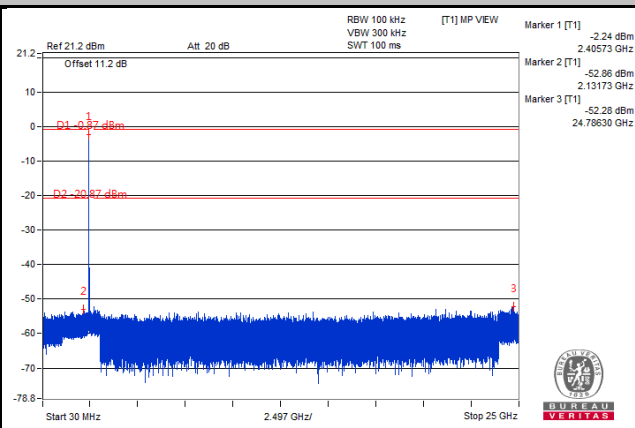
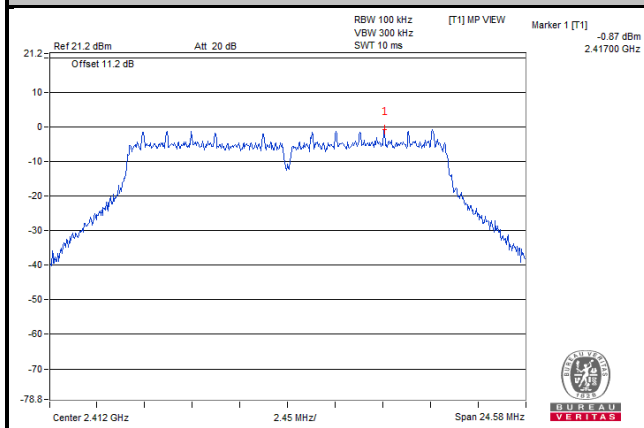

Ch 6

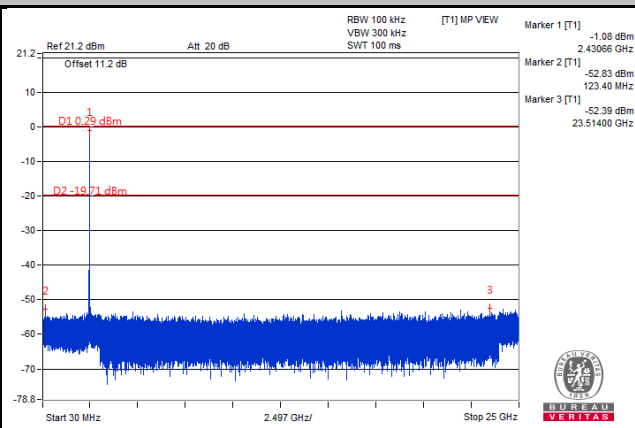
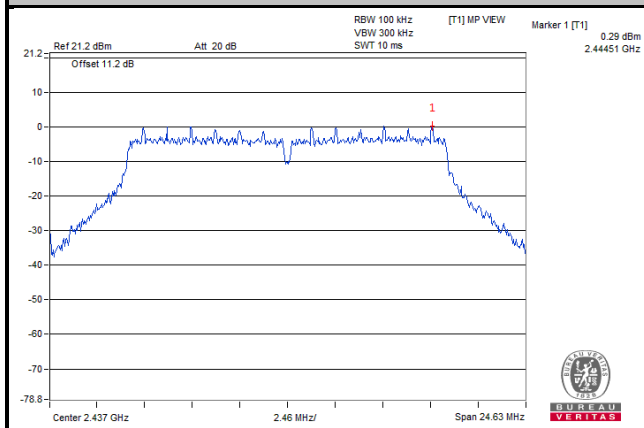

Ch 11

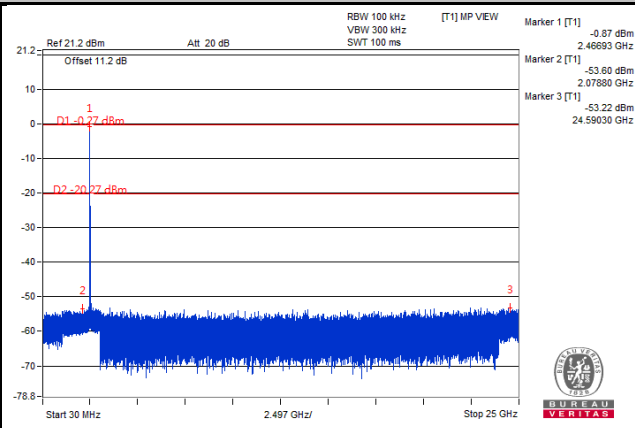
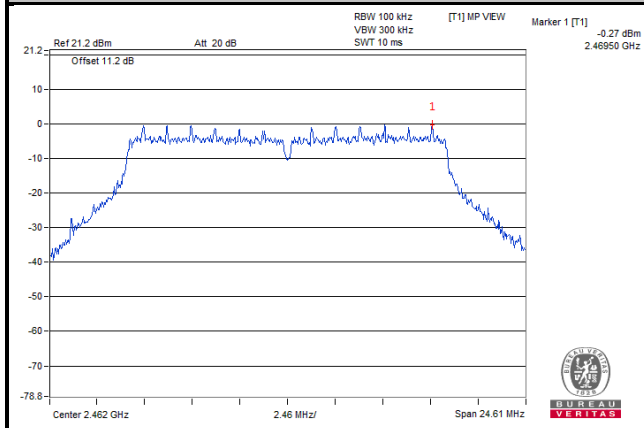

Ch 12

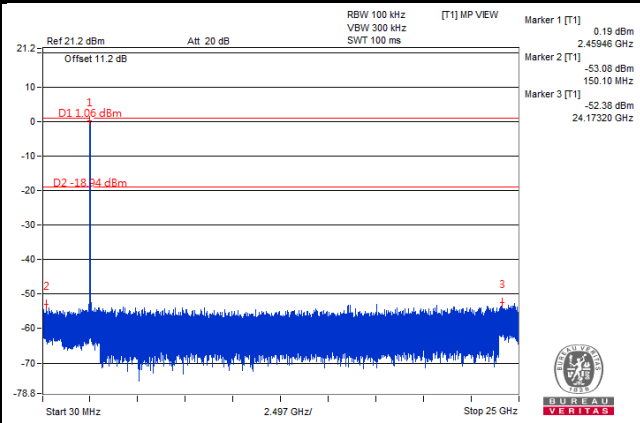
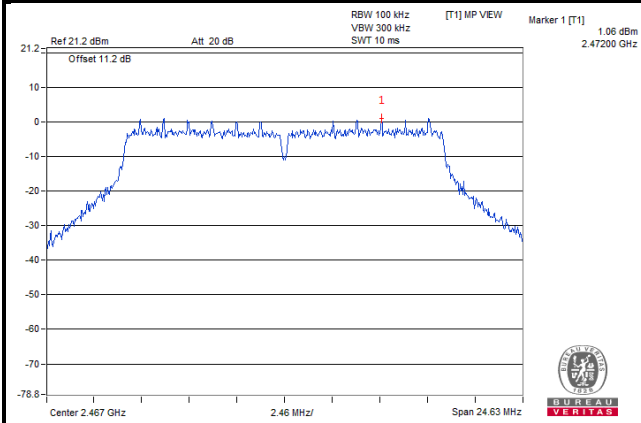

Ch 13

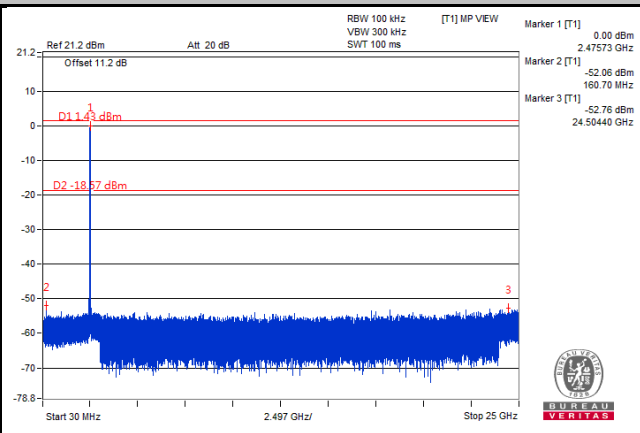
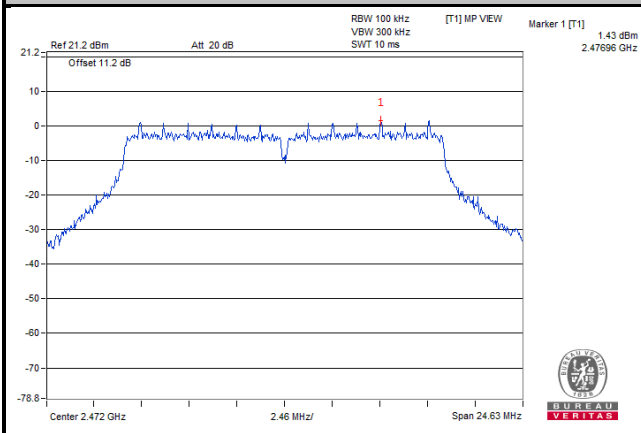

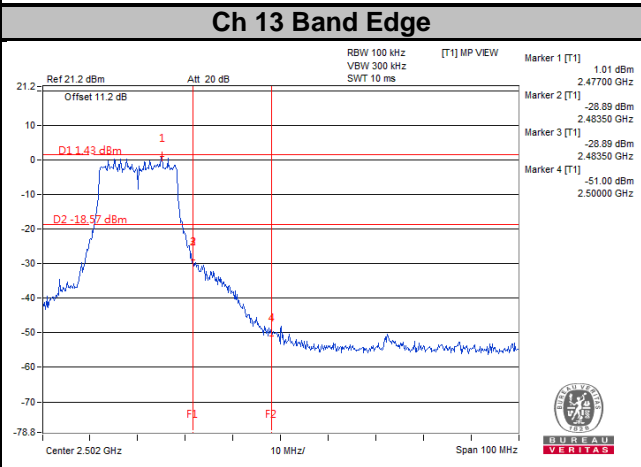
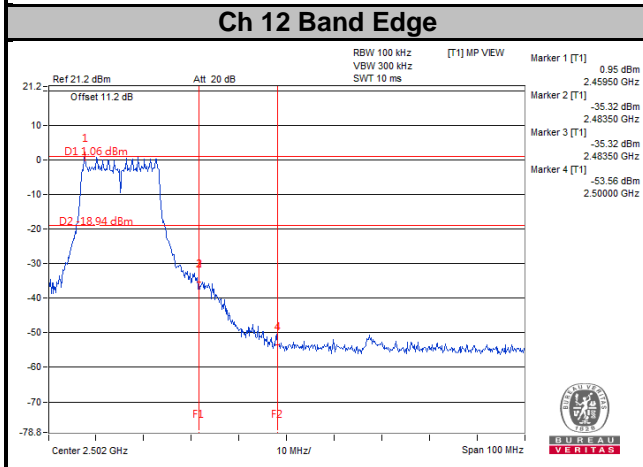
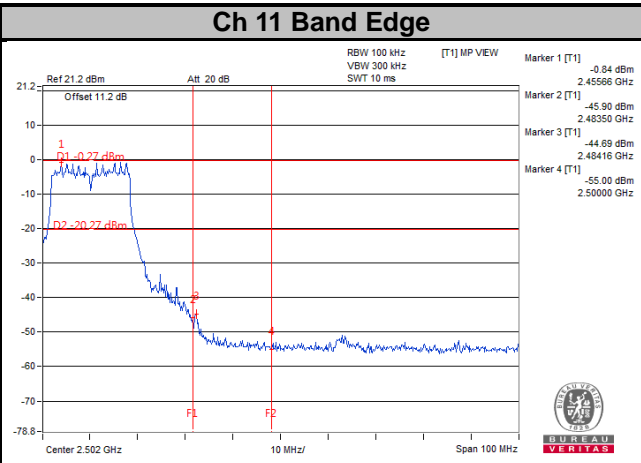
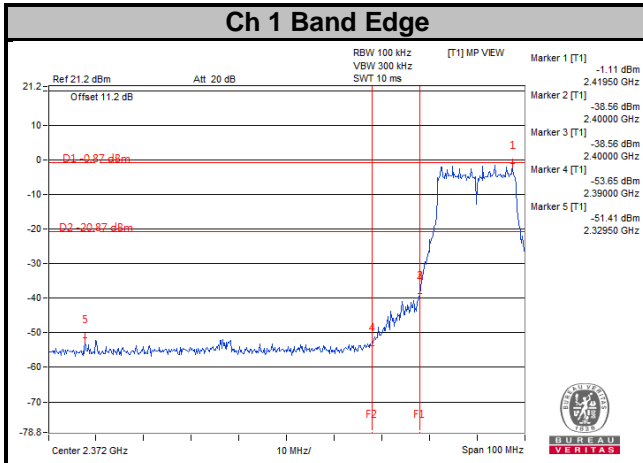

802.11n (HT20)

Ch 1

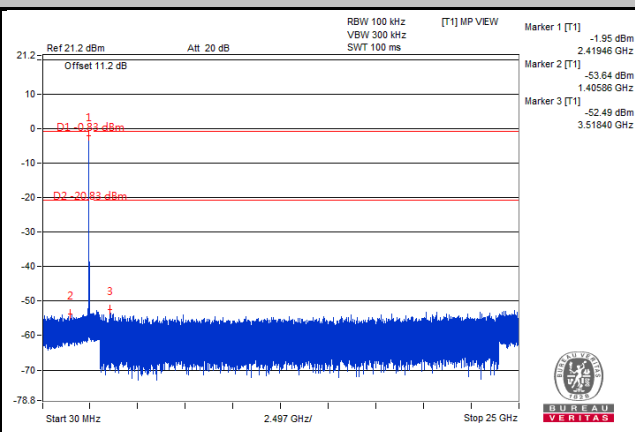
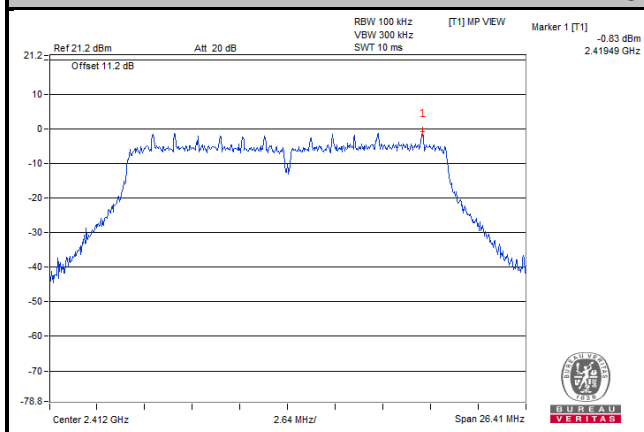

Ch 6

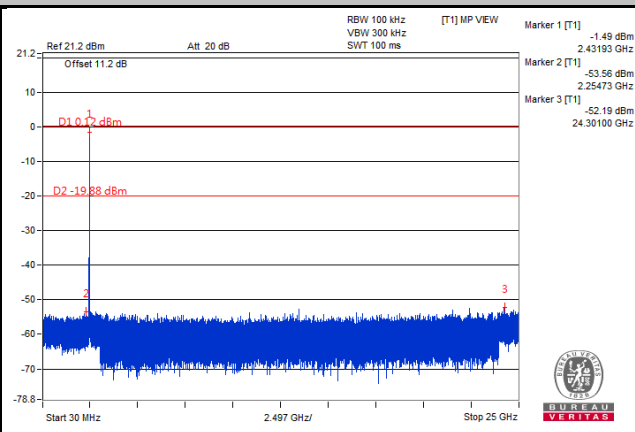
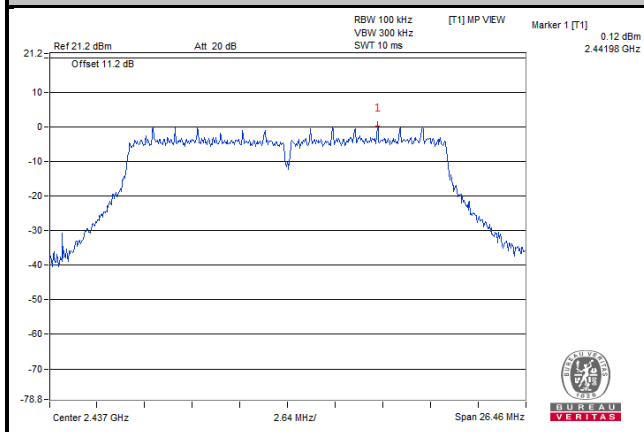

Ch 11

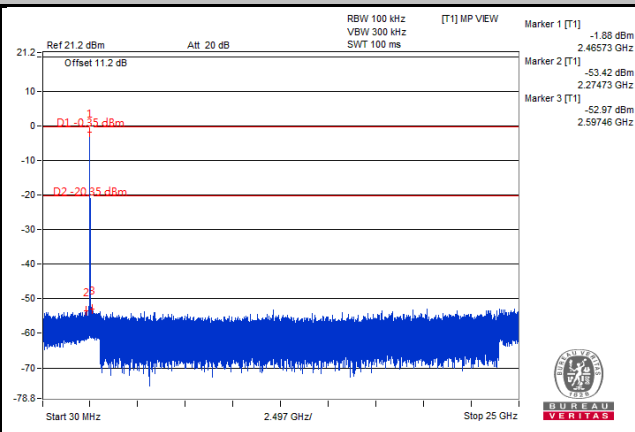
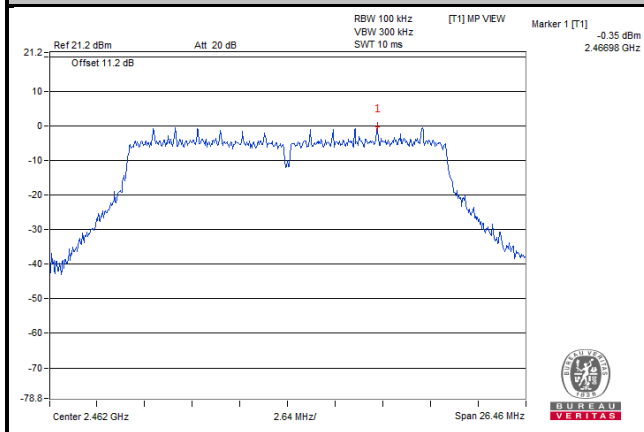

Ch 12

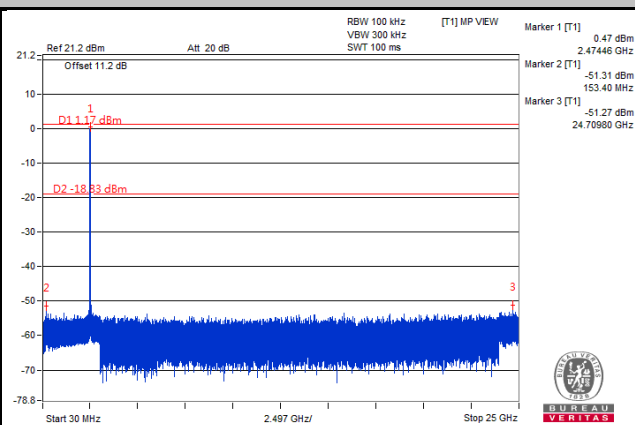
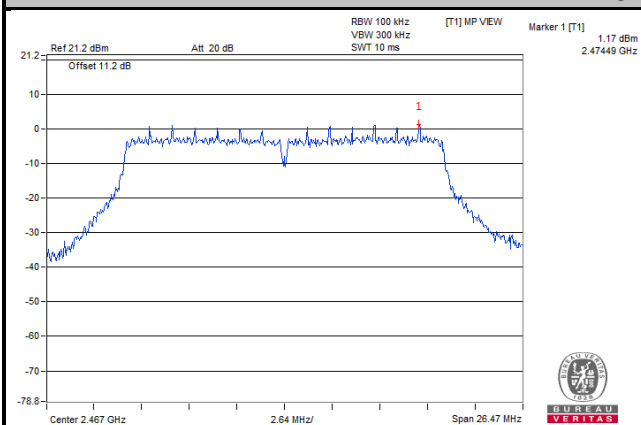

Ch 13

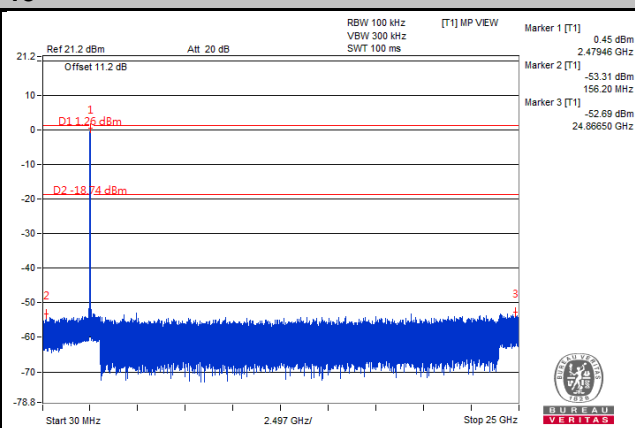
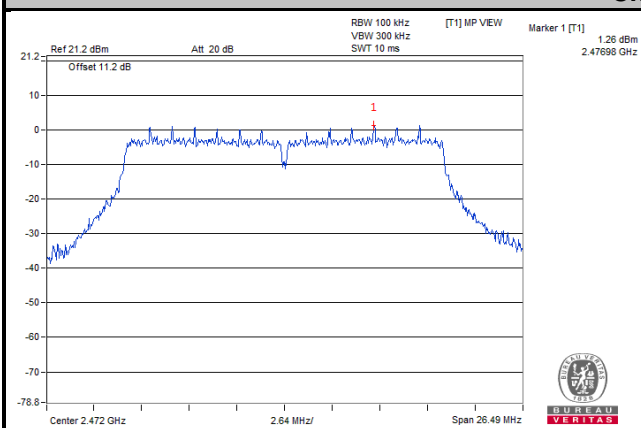

Ch 1 Band Edge

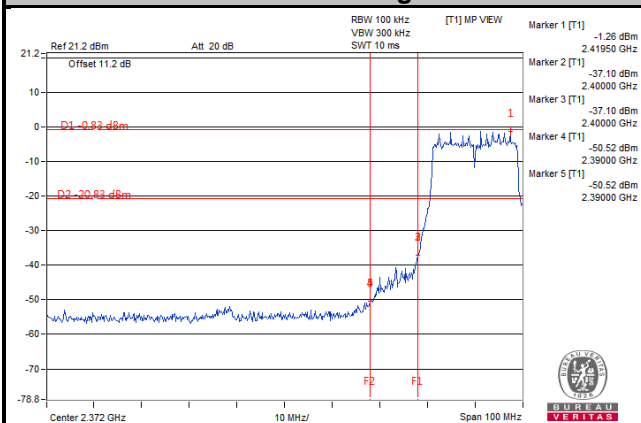

Ch 11 Band Edge

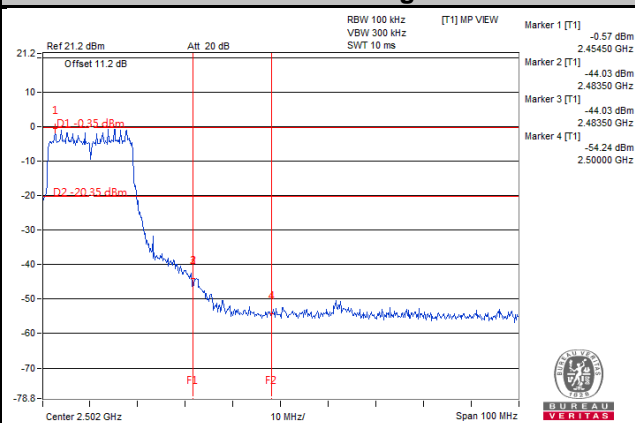

Ch 12 Band Edge

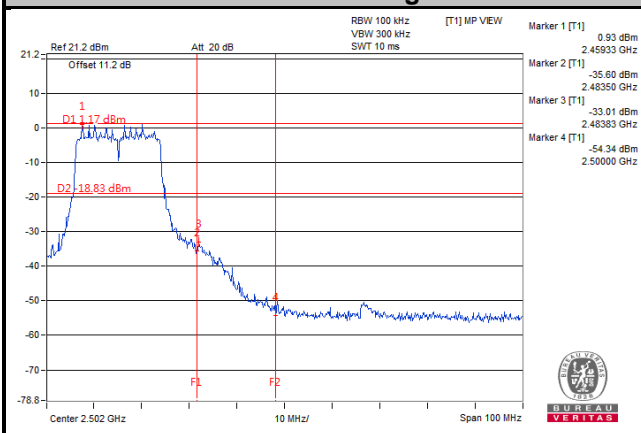

Ch 13 Band Edge

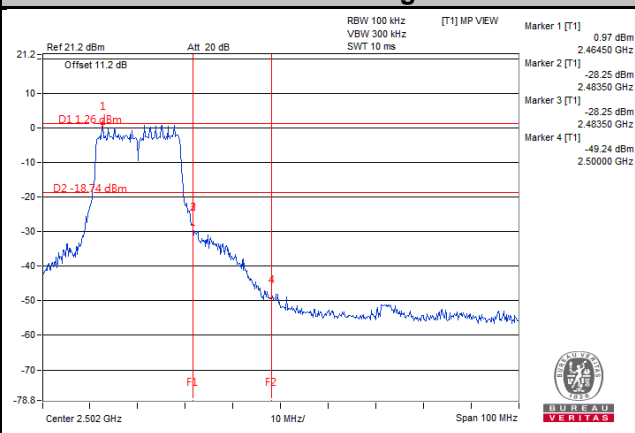

5 Pictures of Test Arrangements

Please refer to the attached file (Test Setup Photo).

Appendix – Information on the Testing Laboratories

We, Bureau Veritas Consumer Products Services (H.K.) Ltd., Taoyuan Branch, were founded in 1988 to provide our best service in EMC, Radio, Telecom and Safety consultation. Our laboratories are accredited and approved according to ISO/IEC 17025.

If you have any comments, please feel free to contact us at the following:

Linko EMC/RF Lab

Tel: 886-2-26052180

Fax: 886-2-26051924

Hsin Chu EMC/RF/Telecom Lab

Tel: 886-3-6668565

Fax: 886-3-6668323

Hwa Ya EMC/RF/Safety Lab

Tel: 886-3-3183232

Fax: 886-3-3270892

Email: service.adt@tw.bureauveritas.com

Web Site: www.bureauveritas-adt.com

The address and road map of all our labs can be found in our web site also.

--- END ---