

FCC Test Report

Report No.: RF170315C40-1

FCC ID: UK7-DW4A

Received Date: Mar. 15, 2017

Test Date: Mar. 28, 2017 ~ May 26, 2017

Issued Date: Jun. 14, 2017

Applicant: Fossil Group, Inc.

Address: 901 S. Central Expwy., Richardson, TX 75080 USA

Issued By: Bureau Veritas Consumer Products Services (H.K.) Ltd., Taoyuan Branch

Lab Address: No. 47-2, 14th Ling, Chia Pau Vil., Lin Kou Dist., New Taipei City, Taiwan
(R.O.C)

Test Location (1): No. 19, Hwa Ya 2nd Rd, Wen Hwa Tsuen, Kwei Shan Hsiang, Taoyuan
Hsien 333, Taiwan, R.O.C.



This report is for your exclusive use. Any copying or replication of this report to or for any other person or entity, or use of our name or trademark, is permitted only with our prior written permission. This report sets forth our findings solely with respect to the test samples identified herein. The results set forth in this report are not indicative or representative of the quality or characteristics of the lot from which a test sample was taken or any similar or identical product unless specifically and expressly noted. Our report includes all of the tests requested by you and the results thereof based upon the information that you provided to us. You have 60 days from date of issuance of this report to notify us of any material error or omission caused by our negligence, provided, however, that such notice shall be in writing and shall specifically address the issue you wish to raise. A failure to raise such issue within the prescribed time shall constitute your unqualified acceptance of the completeness of this report, the tests conducted and the correctness of the report contents. Unless specific mention, the uncertainty of measurement has been explicitly taken into account to declare the compliance or non-compliance to the specification.

Table of Contents

Release Control Record	4
1 Certificate of Conformity	5
2 Summary of Test Results	6
2.1 Measurement Uncertainty	6
2.2 Modification Record	6
3 General Information	7
3.1 General Description of EUT	7
3.2 Description of Test Modes	8
3.2.1 Test Mode Applicability and Tested Channel Detail	9
3.3 Duty Cycle of Test Signal	10
3.4 Description of Support Units	11
3.4.1 Configuration of System under Test	11
3.5 General Description of Applied Standards	11
4 Test Types and Results	12
4.1 Radiated Emission and Bandedge Measurement	12
4.1.1 Limits of Radiated Emission and Bandedge Measurement	12
4.1.2 Test Instruments	13
4.1.3 Test Procedures	14
4.1.4 Deviation from Test Standard	14
4.1.5 Test Set Up	15
4.1.6 EUT Operating Conditions	15
4.1.7 Test Results	16
4.2 Conducted Emission Measurement	44
4.2.1 Limits of Conducted Emission Measurement	44
4.2.2 Test Instruments	44
4.2.3 Test Procedures	44
4.2.4 Deviation from Test Standard	44
4.2.5 TEST SETUP	45
4.2.6 EUT Operating Conditions	45
4.2.7 Test Results	46
4.3 6 dB Bandwidth Measurement	54
4.3.1 Limits of 6 dB Bandwidth Measurement	54
4.3.2 Test Setup	54
4.3.3 Test Instruments	54
4.3.4 Test Procedure	54
4.3.5 Deviation from Test Standard	54
4.3.6 EUT Operating Conditions	54
4.3.7 Test Result	55
4.4 Conducted Output Power Measurement	56
4.4.1 Limits of Conducted Output Power Measurement	56
4.4.2 Test Setup	56
4.4.3 Test Instruments	56
4.4.4 Test Procedures	56
4.4.5 Deviation from Test Standard	56
4.4.6 EUT Operating Conditions	56
4.4.7 Test Results	56
4.5 Power Spectral Density Measurement	57
4.5.1 Limits of Power Spectral Density Measurement	57
4.5.2 Test Setup	57
4.5.3 Test Instruments	57
4.5.4 Test Procedure	57
4.5.5 Deviation from Test Standard	57
4.5.6 EUT Operating Condition	57

4.5.7 Test Results	58
4.6 Conducted Out of Band Emission Measurement	59
4.6.1 Limits of Conducted Out of Band Emission Measurement.....	59
4.6.2 Test Setup.....	59
4.6.3 Test Instruments	59
4.6.4 Test Procedure	59
4.6.5 Deviation from Test Standard	59
4.6.6 EUT Operating Condition	59
4.6.7 TEST RESULTS	60
5 Pictures of Test Arrangements.....	62
Appendix – Information on the Testing Laboratories	63

Release Control Record

Issue No.	Description	Date Issued
RF170315C40-1	Original Release	Jun. 14, 2017

1 Certificate of Conformity

Product: Smart Watch

Sample Status: Production Unit

Applicant: Fossil Group, Inc.

Test Date: Mar. 28, 2017 ~ May 26, 2017

Standards: 47 CFR FCC Part 15, Subpart C (Section 15.247)
ANSI C63.10:2013

The above equipment has been tested by **Bureau Veritas Consumer Products Services (H.K.) Ltd., Taoyuan Branch**, and found compliance with the requirement of the above standards. The test record, data evaluation & Equipment Under Test (EUT) configurations represented herein are true and accurate accounts of the measurements of the sample's EMC characteristics under the conditions specified in this report.

Prepared by :



Date:

Jun. 14, 2017

Ivonne Wu / Supervisor

Approved by :



Date:

Jun. 14, 2017

David Huang / Project Engineer

2 Summary of Test Results

47 CFR FCC Part 15, Subpart C (Section 15.247)			
FCC Clause	Test Item	Result	Remarks
15.207	AC Power Conducted Emission	Pass	Meet the requirement of limit. Minimum passing margin is -0.25 dB at 1.68600 MHz.
15.205 & 209	Radiated Emissions	Pass	Meet the requirement of limit. Minimum passing margin is -2.21 dB at 32.91 MHz.
15.247(d)	Band Edge Measurement	Pass	Meet the requirement of limit.
15.247(d)	Antenna Port Emission	Pass	Meet the requirement of limit.
15.247(a)(2)	6 dB Bandwidth	Pass	Meet the requirement of limit.
15.247(b)	Conducted power	Pass	Meet the requirement of limit.
15.247(e)	Power Spectral Density	Pass	Meet the requirement of limit.
15.203	Antenna Requirement	Pass	No antenna connector is used.

2.1 Measurement Uncertainty

Where relevant, the following measurement uncertainty levels have been estimated for tests performed on the EUT:

The listed uncertainties are the worst case uncertainty for the entire range of measurement. Please note that the uncertainty values are provided for informational purposes only and are not used in determining the PASS/FAIL results.

Measurement	Frequency	Expanded Uncertainty (k=2) (\pm)
Conducted Emissions at mains ports	150 kHz ~ 30 MHz	2.44 dB
Radiated Emissions up to 1 GHz	30 MHz ~ 200 MHz	2.93 dB
	200 MHz ~ 1000 MHz	2.95 dB
Radiated Emissions above 1 GHz	1 GHz ~ 18 GHz	2.26 dB
	18 GHz ~ 40 GHz	1.94 dB

2.2 Modification Record

There were no modifications required for compliance.

3 General Information

3.1 General Description of EUT

Product	Smart Watch
Status of EUT	Production Unit
Power Supply Rating	5.0 Vdc (from wireless charger) 3.8 Vdc (from battery)
Modulation Type	GFSK
Transfer Rate	1 Mbps
Operating Frequency	2402 ~ 2480 MHz
Number of Channel	40
Output Power	2.377 mW
Antenna Type	Loop antenna
Antenna Connector	N/A
Accessory Device	Refer to Note as below
Data Cable Supplied	Refer to Note as below

Note:

- There're 4 configurations for the EUT listed as below.

Sample	Antenna Gain (dBi)	Difference
A	-6.74	The samples are different in the appearance and antenna only.
B	-5.77	
C	-7.1	
D	-6.52	

- The EUT's accessories list refers to Ext. Pho.

3.2 Description of Test Modes

40 channels are provided to this EUT:

Channel	Freq. (MHz)	Channel	Freq. (MHz)	Channel	Freq. (MHz)	Channel	Freq. (MHz)
0	2402	10	2422	20	2442	30	2462
1	2404	11	2424	21	2444	31	2464
2	2406	12	2426	22	2446	32	2466
3	2408	13	2428	23	2448	33	2468
4	2410	14	2430	24	2450	34	2470
5	2412	15	2432	25	2452	35	2472
6	2414	16	2434	26	2454	36	2474
7	2416	17	2436	27	2456	37	2476
8	2418	18	2438	28	2458	38	2478
9	2420	19	2440	29	2460	39	2480

3.2.1 Test Mode Applicability and Tested Channel Detail

EUT Configure Mode	Applicable To				Description
	RE \geq 1G	RE<1G	PLC	APCM	
A	√	√	√	√	Sample B
B	√	√	√	-	Sample A
C	√	√	√	-	Sample C
D	√	√	√	-	Sample D

Where **RE \geq 1G**: Radiated Emission above 1 GHz **RE<1G**: Radiated Emission below 1 GHz
PLC: Power Line Conducted Emission **APCM**: Antenna Port Conducted Measurement

Note: The EUT had been pre-tested on the positioned of each 3 axis. The worst case was found when positioned on **Z-plane**.
Note: "-" means no effect.

Radiated Emission Test (Above 1 GHz):

- Pre-Scan has been conducted to determine the worst-case mode from all possible combinations between available modulations, data rates and antenna ports (if EUT with antenna diversity architecture).
- Following channel(s) was (were) selected for the final test as listed below.

EUT Configure Mode	Available Channel	Tested Channel	Modulation Type	Data Rate (Mbps)
A	0 to 39	0, 19, 39	GFSK	1
B, C, D	0 to 39	39	GFSK	1

Radiated Emission Test (Below 1 GHz):

- Pre-Scan has been conducted to determine the worst-case mode from all possible combinations between available modulations, data rates and antenna ports (if EUT with antenna diversity architecture).
- Following channel(s) was (were) selected for the final test as listed below.

EUT Configure Mode	Available Channel	Tested Channel	Modulation Type	Data Rate (Mbps)
A, B, C, D	0 to 39	39	GFSK	1

Power Line Conducted Emission Test:

- Pre-Scan has been conducted to determine the worst-case mode from all possible combinations between available modulations, data rates and antenna ports (if EUT with antenna diversity architecture).
- Following channel(s) was (were) selected for the final test as listed below.

EUT Configure Mode	Available Channel	Tested Channel	Modulation Type	Data Rate (Mbps)
A, B, C, D	0 to 39	39	GFSK	1

Antenna Port Conducted Measurement:

- This item includes all test value of each mode, but only includes spectrum plot of worst value of each mode.
- Pre-Scan has been conducted to determine the worst-case mode from all possible combinations between available modulations, data rates and antenna ports (if EUT with antenna diversity architecture).
- Following channel(s) was (were) selected for the final test as listed below.

EUT Configure Mode	Available Channel	Tested Channel	Modulation Type	Data Rate (Mbps)
A	0 to 39	0, 19, 39	GFSK	1

Test Condition:

Applicable To	Environmental Conditions	Input Power	Tested by
RE \geq 1G	25 deg. C, 65 % RH	5 Vdc	Getaz Yang
RE $<$ 1G	25 deg. C, 65 % RH	5 Vdc	Getaz Yang
PLC	25 deg. C, 65 % RH	5 Vdc	Getaz Yang
APCM	25 deg. C, 65 % RH	3.8 Vdc	Carlos Chen

3.3 Duty Cycle of Test Signal

Duty cycle = 391.03/628.21 = 0.622, Duty factor = 10 * log(1/0.622) = 2.06

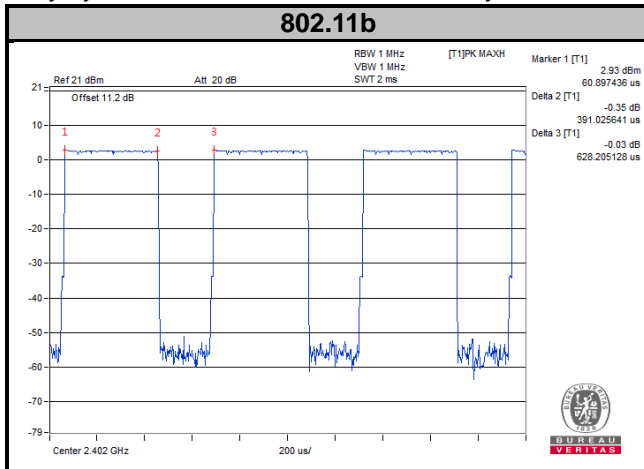

3.4 Description of Support Units

The EUT has been tested as an independent unit together with other necessary accessories or support units. The following support units or accessories were used to form a representative test configuration during the tests.

No.	Product	Brand	Model No.	Serial No.	FCC ID
1.	Adapter	XIAOMI	MDY-08-EF	N/A	N/A

No.	Signal Cable Description Of The Above Support Units
1.	N/A

Note:

1. All power cords of the above support units are non-shielded (1.8m).

3.4.1 Configuration of System under Test

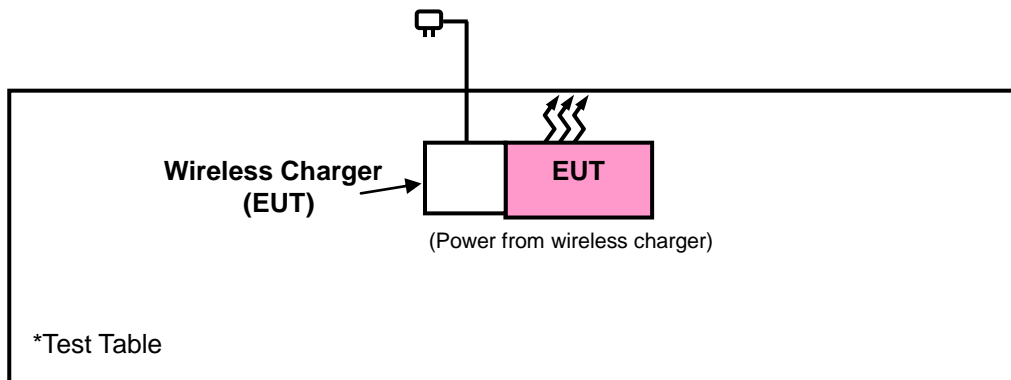

3.5 General Description of Applied Standards

The EUT is a RF Product. According to the specifications of the manufacturer, it must comply with the requirements of the following standards:

FCC Part 15, Subpart C (15.247)

558074 D01 DTS Meas Guidance v04

ANSI C63.10-2013

All test items have been performed and recorded as per the above standards.

Note: The EUT has been verified to comply with the requirements of FCC Part 15, Subpart B, Class B (Verification). The test report has been issued separately.

4 Test Types and Results

4.1 Radiated Emission and Bandedge Measurement

4.1.1 Limits of Radiated Emission and Bandedge Measurement

Radiated emissions which fall in the restricted bands must comply with the radiated emission limits specified as below table. Other emissions shall be at least 20 dB below the highest level of the desired power:

Frequencies (MHz)	Field Strength (microvolts/meter)	Measurement Distance (meters)
0.009 ~ 0.490	2400/F (kHz)	300
0.490 ~ 1.705	24000/F (kHz)	30
1.705 ~ 30.0	30	30
30 ~ 88	100	3
88 ~ 216	150	3
216 ~ 960	200	3
Above 960	500	3

Note:

1. The lower limit shall apply at the transition frequencies.
2. Emission level (dBuV/m) = 20 log Emission level (uV/m).
3. For frequencies above 1000 MHz, the field strength limits are based on average detector, however, the peak field strength of any emission shall not exceed the maximum permitted average limits, specified above by more than 20 dB under any condition of modulation.

4.1.2 Test Instruments

Description & Manufacturer	Model No.	Serial No.	Date of Calibration	Due Date of Calibration
Test Receiver Agilent	N9038A	MY51210203	Feb. 17, 2017	Feb. 16, 2018
Spectrum Analyzer Agilent	N9010A	MY52220314	Dec. 16, 2016	Dec. 15, 2017
Spectrum Analyzer ROHDE & SCHWARZ	FSU43	101261	Dec. 13, 2016	Dec. 12, 2017
BILOG Antenna SCHWARZBECK	VULB9168	9168-472	Dec. 26, 2016	Dec. 27, 2017
HORN Antenna SCHWARZBECK	BBHA 9120 D	9120D-969	Dec. 12, 2016	Dec. 13, 2017
HORN Antenna SCHWARZBECK	BBHA 9170	9170-480	Dec. 14, 2016	Dec. 13, 2017
Fixed Attenuator Mini-Circuits	BW-N10W5+	NA	Jul. 08, 2016	Jul. 07, 2017
Loop Antenna	EM-6879	269	Aug. 11, 2016	Aug. 10, 2017
Bluetooth Tester	CBT	100946	Jul. 29, 2016	Jul. 28, 2018
Preamplifier EMCI	EMC 012645	980115	Oct. 21, 2016	Oct. 20, 2017
Preamplifier EMCI	EMC 184045	980116	Oct. 21, 2016	Oct. 20, 2017
Preamplifier EMCI	EMC 330H	980112	Oct. 21, 2016	Oct. 20, 2017
Power Meter Anritsu	ML2495A	1232002	Sep. 08, 2016	Sep. 07, 2017
Power Sensor Anritsu	MA2411B	1207325	Sep. 08, 2016	Sep. 07, 2017
RF signal cable HUBER+SUHNNER	SUCOFLEX 104	309219/4 2950114	Oct. 21, 2016	Oct. 20, 2017
RF signal cable HUBER+SUHNNER	SUCOFLEX 104	250130/4	Oct. 21, 2016	Oct. 20, 2017
RF Coaxial Cable Worken	8D-FB	Cable-Ch10-01	Oct. 21, 2016	Oct. 20, 2017
Software BV ADT	E3 6.120103	NA	NA	NA
Antenna Tower MF	MFA-440H	NA	NA	NA
Turn Table MF	MFT-201SS	NA	NA	NA
Antenna Tower & Turn Table Controller MF	MF-7802	NA	NA	NA

- Note: 1. The calibration interval of the above test instruments is 12 months and the calibrations are traceable to NML/ROC and NIST/USA.
2. The test was performed in HwaYa Chamber 10.
3. The horn antenna and preamplifier (model: EMC 184045) are used only for the measurement of emission frequency above 1GHz if tested.
4. The FCC Site Registration No. is 690701.
5. The IC Site Registration No. is IC7450F-10.

4.1.3 Test Procedures

- a. The EUT was placed on the top of a rotating table 0.8 meters (for below 1 GHz) / 1.5 meters (for above 1 GHz) above the ground at 3 meter chamber room for test. The table was rotated 360 degrees to determine the position of the highest radiation.
- b. The EUT was set 3 meters away from the interference-receiving antenna, which was mounted on the top of a variable-height antenna tower.
- c. The height of antenna is varied from one meter to four meters above the ground to determine the maximum value of the field strength. Both horizontal and vertical polarizations of the antenna are set to make the measurement.
- d. For each suspected emission, the EUT was arranged to its worst case and then the antenna was tuned to heights from 1 meter to 4 meters and the rotatable table was turned from 0 degrees to 360 degrees to find the maximum reading.
- e. The test-receiver system was set to quasi-peak detect function and specified bandwidth with maximum hold mode when the test frequency is below 1 GHz.
- f. The test-receiver system was set to peak and average detected function and specified bandwidth with maximum hold mode when the test frequency is above 1 GHz. If the peak reading value also meets average limit, measurement with the average detector is unnecessary.

Note:

1. The resolution bandwidth and video bandwidth of test receiver/spectrum analyzer is 120 kHz & 360 kHz for Quasi-peak detection (QP) at frequency below 1 GHz.
2. The resolution bandwidth of test receiver/spectrum analyzer is 1 MHz and the video bandwidth is 3 MHz for Peak detection (PK) at frequency above 1 GHz.
3. The resolution bandwidth of test receiver/spectrum analyzer is 1 MHz and the video bandwidth is 1/T for Average (Duty cycle < 98 %) detection at frequency above 1 GHz.
4. The resolution bandwidth of test receiver/spectrum analyzer is 1 MHz and the video bandwidth is 10 Hz (Duty cycle \geq 98 %) for Average detection (AV) at frequency above 1 GHz.
5. All modes of operation were investigated and the worst-case emissions are reported.

4.1.4 Deviation from Test Standard

No deviation.

4.1.5 Test Set Up

<Frequency Range below 1 GHz>

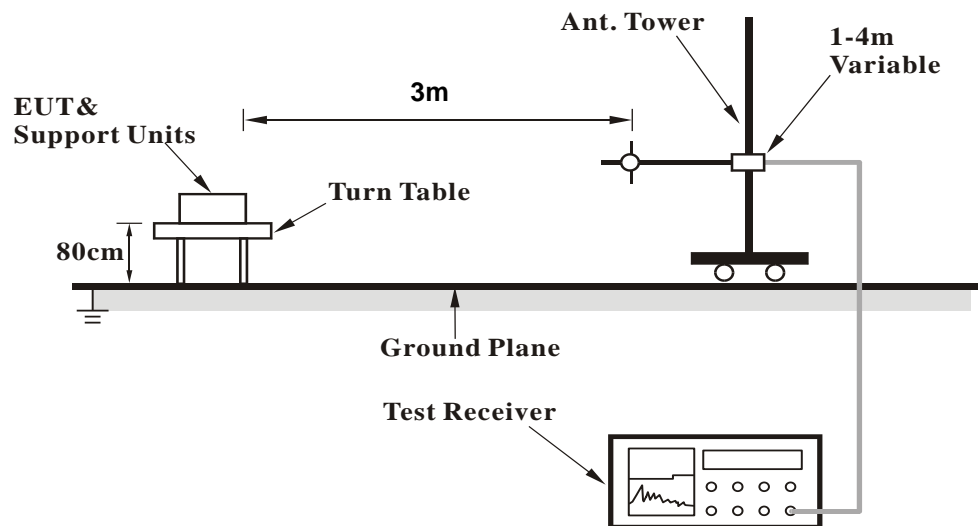

<Frequency Range above 1 GHz>

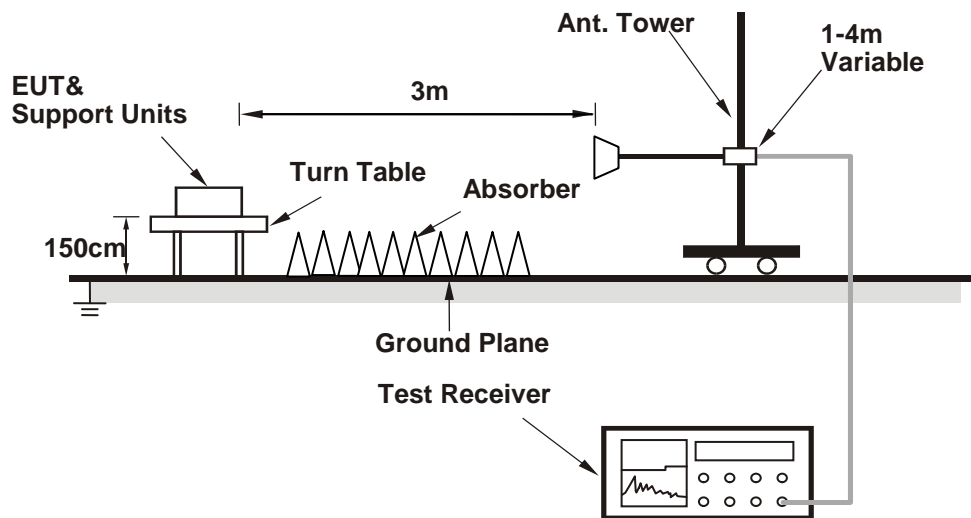

For the actual test configuration, please refer to the attached file (Test Setup Photo).

4.1.6 EUT Operating Conditions

- a. Placed the EUT on the testing table.
- b. Set the EUT under transmission condition continuously at specific channel frequency.

4.1.7 Test Results

ABOVE 1 GHz DATA :

Mode A

EUT Test Condition		Measurement Detail	
Channel	Channel 0	Frequency Range	1 GHz ~ 25 GHz
Input Power	120 Vac, 60 Hz	Detector Function	Peak (PK) Average (AV)
Environmental Conditions	25 deg. C, 65 % RH	Tested By	Getaz Yang

Horizontal

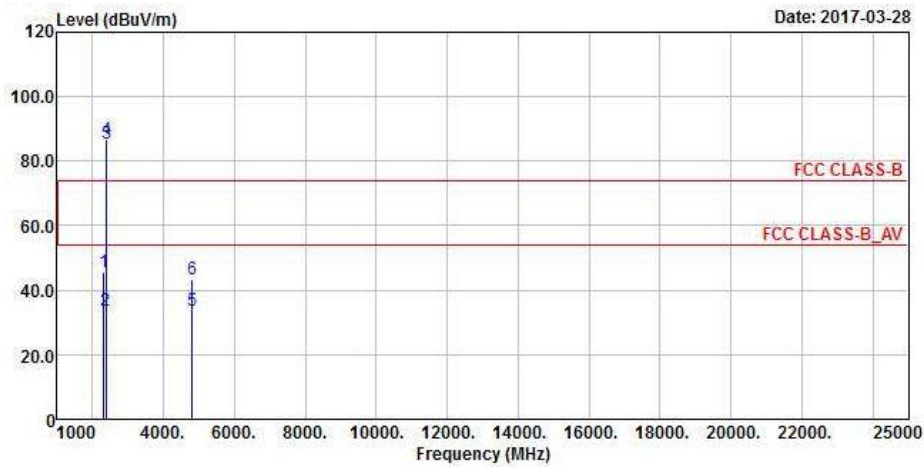

Vertical

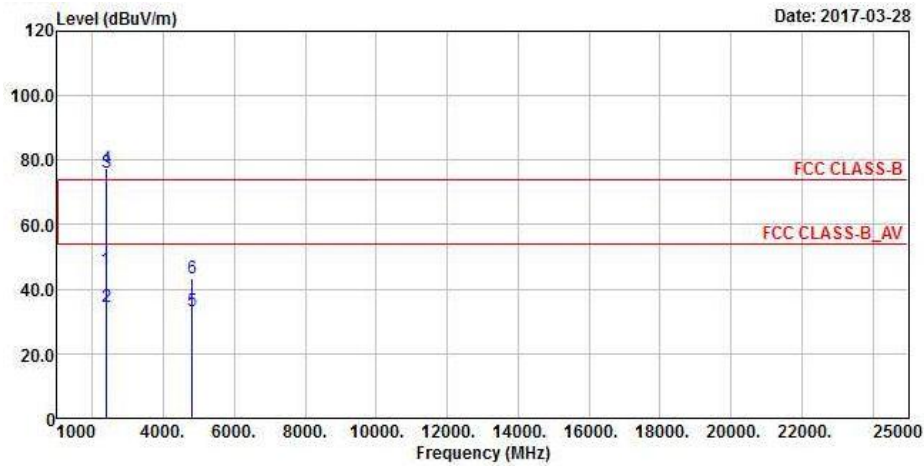

Antennal Polarity & Test Distance: Horizontal at 3 m

Frequency (MHz)	Emission Level (dBuV/m)	Read Level (dBuV)	Limit (dBuV/m)	Margin (dB)	Antenna Factor (dB/m)	Cable Loss (dB)	Preamp Factor (dB)	Antenna Height (cm)	Table Angle (Degree)	Remark
2322.42	45.81	52.53	74	-28.19	26.72	4.03	37.47	205	136	Peak
2370.1	33.56	40.13	54	-20.44	26.86	4.07	37.5	205	136	Average
2402	85.31	91.83			26.91	4.09	37.52	205	136	Average
2402	86.7	93.22			26.91	4.09	37.52	205	136	Peak
4804	33.51	48.85	54	-20.49	30.97	6.79	53.1	112	240	Average
4804	43.2	58.54	74	-30.8	30.97	6.79	53.1	112	240	Peak

Antennal Polarity & Test Distance: Vertical at 3 m

Frequency (MHz)	Emission Level (dBuV/m)	Read Level (dBuV)	Limit (dBuV/m)	Margin (dB)	Antenna Factor (dB/m)	Cable Loss (dB)	Preamp Factor (dB)	Antenna Height (cm)	Table Angle (Degree)	Remark
2374.66	45.89	52.46	74	-28.11	26.86	4.07	37.5	179	28	Peak
2387.54	34.32	40.83	54	-19.68	26.91	4.08	37.5	179	28	Average
2402	76.29	82.81			26.91	4.09	37.52	179	28	Average
2402	77.53	84.05			26.91	4.09	37.52	179	28	Peak
4804	33.41	48.75	54	-20.59	30.97	6.79	53.1	105	84	Average
4804	43.45	58.79	74	-30.55	30.97	6.79	53.1	105	84	Peak

Remarks:

1. Emission Level = Read Level + Antenna Factor + Cable Loss - Preamp Factor

Margin value = Emission level – Limit value

2. 2402 MHz: Fundamental frequency.

EUT Test Condition		Measurement Detail	
Channel	Channel 19	Frequency Range	1 GHz ~ 25 GHz
Input Power	120 Vac, 60 Hz	Detector Function	Peak (PK) Average (AV)
Environmental Conditions	25 deg. C, 65 % RH	Tested By	Getaz Yang

Horizontal

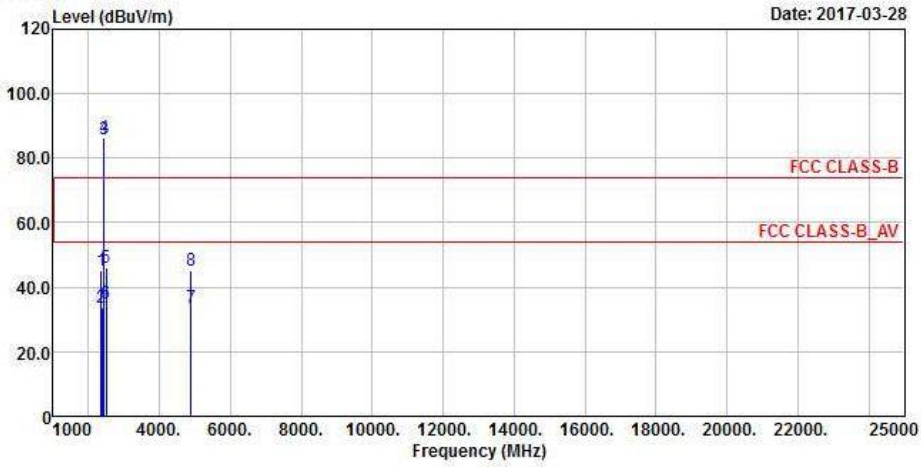

Vertical

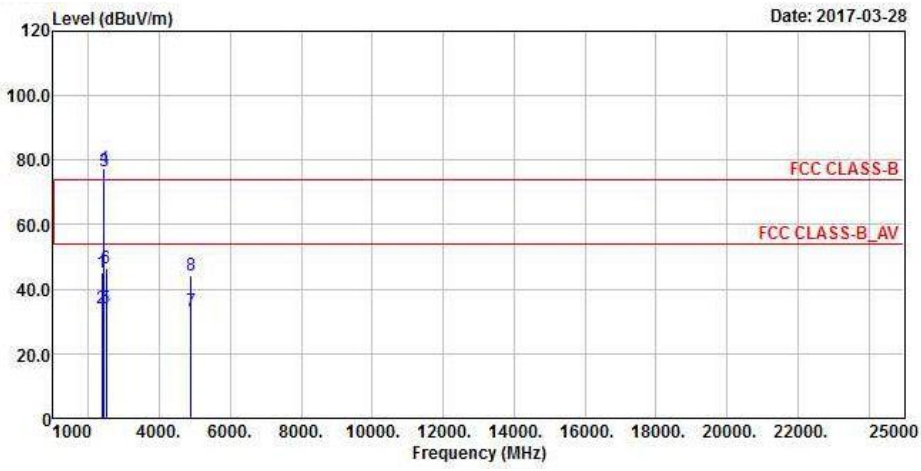

Antennal Polarity & Test Distance: Horizontal at 3 m

Frequency (MHz)	Emission Level (dBuV/m)	Read Level (dBuV)	Limit (dBuV/m)	Margin (dB)	Antenna Factor (dB/m)	Cable Loss (dB)	Preamp Factor (dB)	Antenna Height (cm)	Table Angle (Degree)	Remark
2360.22	45.36	51.99	74	-28.64	26.81	4.05	37.49	188	200	Peak
2367.66	33.84	40.46	54	-20.16	26.81	4.07	37.5	188	200	Average
2440	85.81	92.09			27.06	4.12	37.46	188	200	Average
2440	86.56	92.84			27.06	4.12	37.46	188	200	Peak
2488.19	46.26	52.22	74	-27.74	27.2	4.16	37.32	188	200	Peak
2489.62	34.78	40.67	54	-19.22	27.2	4.16	37.25	188	200	Average
4880	33.45	48.59	54	-20.55	31.06	6.85	53.05	111	290	Average
4880	45.32	60.46	74	-28.68	31.06	6.85	53.05	111	290	Peak

Antennal Polarity & Test Distance: Vertical at 3 m

Frequency (MHz)	Emission Level (dBuV/m)	Read Level (dBuV)	Limit (dBuV/m)	Margin (dB)	Antenna Factor (dB/m)	Cable Loss (dB)	Preamp Factor (dB)	Antenna Height (cm)	Table Angle (Degree)	Remark
2365.32	45.35	51.97	74	-28.65	26.81	4.07	37.5	195	42	Peak
2371.48	33.92	40.49	54	-20.08	26.86	4.07	37.5	192	42	Average
2440	76.59	82.87			27.06	4.12	37.46	192	42	Average
2440	77.48	83.76			27.06	4.12	37.46	192	42	Peak
2485.36	34.29	40.31	54	-19.71	27.15	4.15	37.32	192	42	Average
2495.09	46.52	52.41	74	-27.48	27.2	4.16	37.25	195	42	Peak
4880	33.18	48.32	54	-20.82	31.06	6.85	53.05	100	184	Average
4880	44.45	59.59	74	-29.55	31.06	6.85	53.05	100	184	Peak

Remarks:

- Emission Level = Read Level + Antenna Factor + Cable Loss - Preamp Factor
Margin value = Emission level – Limit value
- 2440 MHz: Fundamental frequency.

EUT Test Condition		Measurement Detail	
Channel	Channel 39	Frequency Range	1 GHz ~ 25 GHz
Input Power	120 Vac, 60 Hz	Detector Function	Peak (PK) Average (AV)
Environmental Conditions	25 deg. C, 65 % RH	Tested By	Getaz Yang

Horizontal

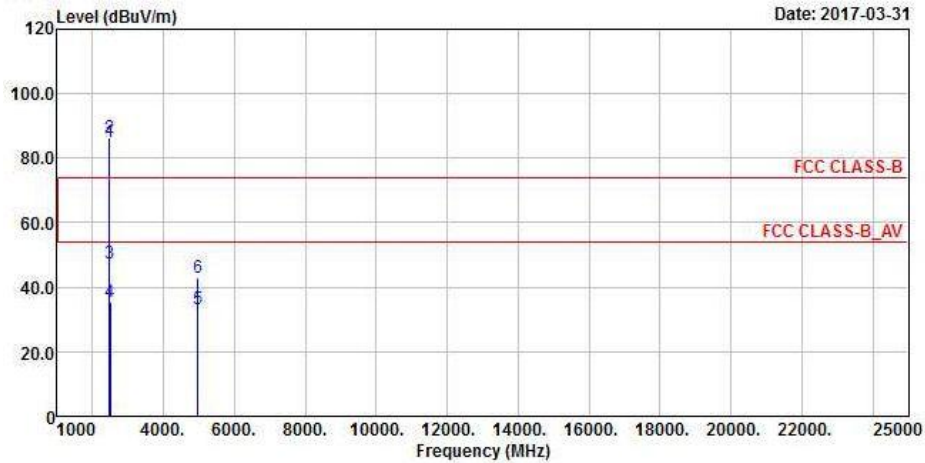

Vertical

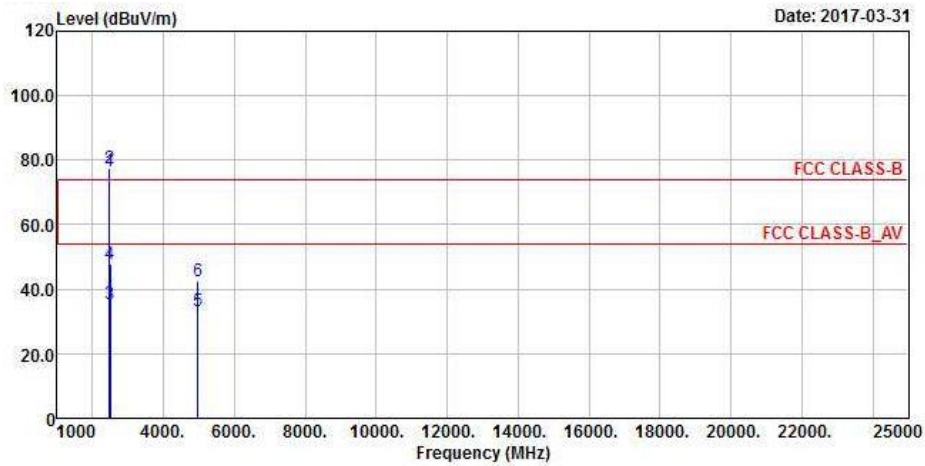

**Band Edge
Peak
Horizontal**

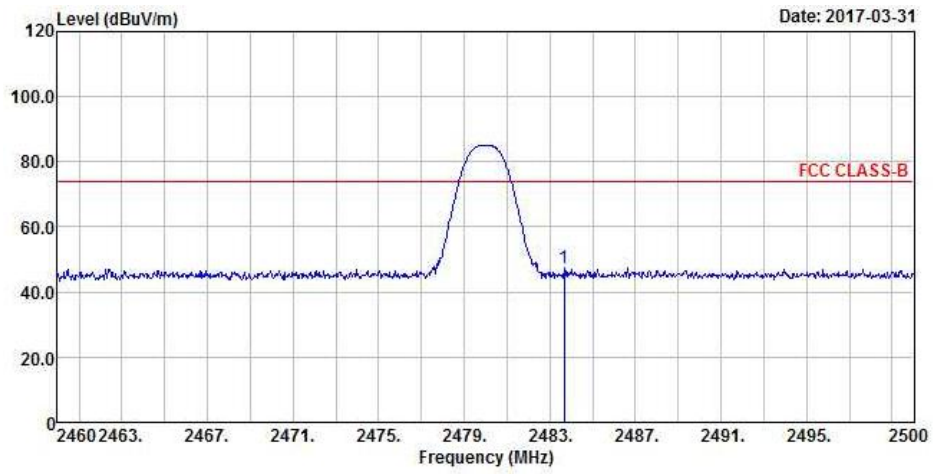

Vertical

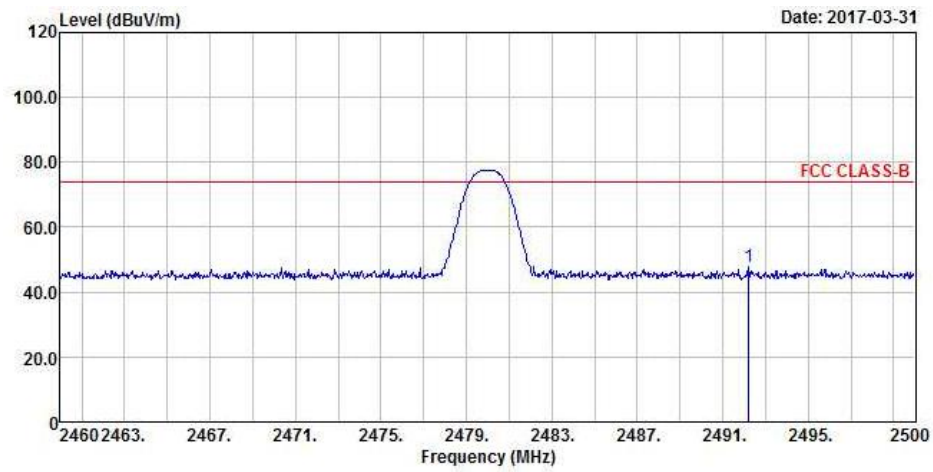

Average Horizontal

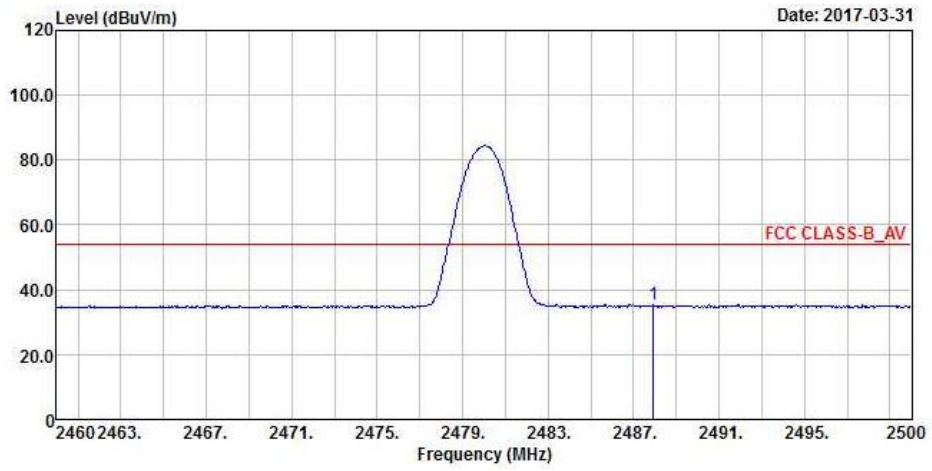

Vertical

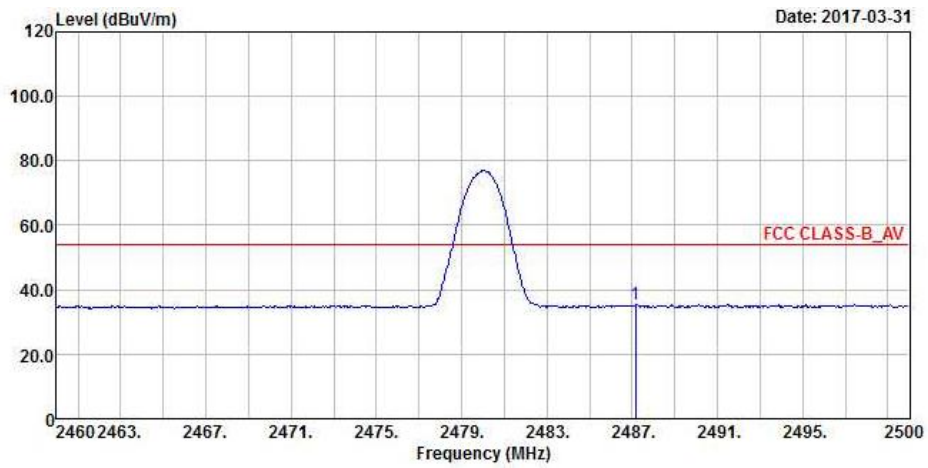

Antennal Polarity & Test Distance: Horizontal at 3 m

Frequency (MHz)	Emission Level (dBuV/m)	Read Level (dBuV)	Limit (dBuV/m)	Margin (dB)	Antenna Factor (dB/m)	Cable Loss (dB)	Preamp Factor (dB)	Antenna Height (cm)	Table Angle (Degree)	Remark
2480	85.12	91.14			27.15	4.15	37.32	198	179	Average
2480	86.19	92.21			27.15	4.15	37.32	198	179	Peak
2483.68	47.48	53.5	74	-26.52	27.15	4.15	37.32	198	179	Peak
2487.92	35.29	41.25	54	-18.71	27.2	4.16	37.32	198	179	Average
4960	33.37	48.34	54	-20.63	31.16	6.91	53.04	196	186	Average
4960	43.16	58.13	74	-30.84	31.16	6.91	53.04	196	186	Peak

Antennal Polarity & Test Distance: Horizontal at 3 m

Frequency (MHz)	Emission Level (dBuV/m)	Read Level (dBuV)	Limit (dBuV/m)	Margin (dB)	Antenna Factor (dB/m)	Cable Loss (dB)	Preamp Factor (dB)	Antenna Height (cm)	Table Angle (Degree)	Remark
2480	76.65	45.35			27.15	4.15	0	227	350	Average
2480	77.71	46.41			27.15	4.15	0	227	350	Peak
2487.16	35.52	41.54	54	-18.48	27.15	4.15	37.32	227	350	Average
2492.2	47.78	53.67	74	-26.22	27.2	4.16	37.25	227	350	Peak
4960	33.4	48.37	54	-20.6	31.16	6.91	53.04	128	88	Average
4960	42.42	57.39	74	-31.58	31.16	6.91	53.04	128	88	Peak

Remarks:

1. Emission Level = Read Level + Antenna Factor + Cable Loss - Preamp Factor

Margin value = Emission level – Limit value

2. 2480 MHz: Fundamental frequency.

Mode B

EUT Test Condition		Measurement Detail	
Channel	Channel 39	Frequency Range	1 GHz ~ 25 GHz
Input Power	120 Vac, 60 Hz	Detector Function	Peak (PK) Average (AV)
Environmental Conditions	25 deg. C, 65 % RH	Tested By	Getaz Yang

Horizontal

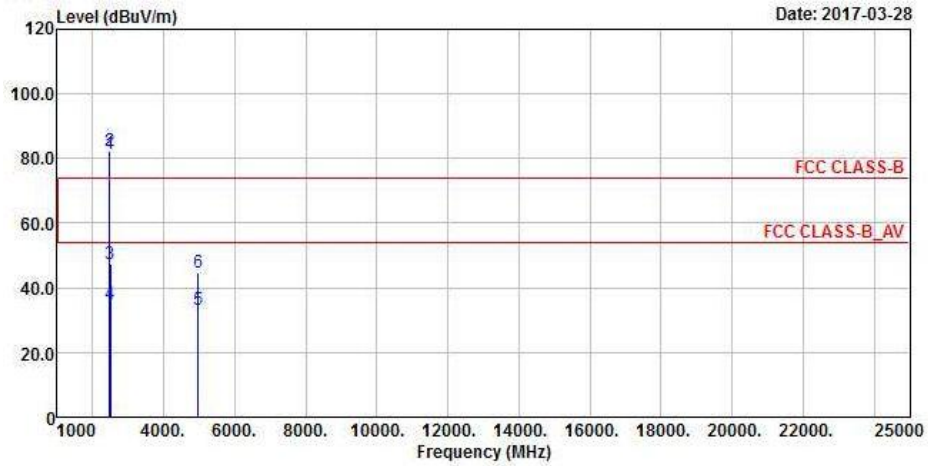

Vertical

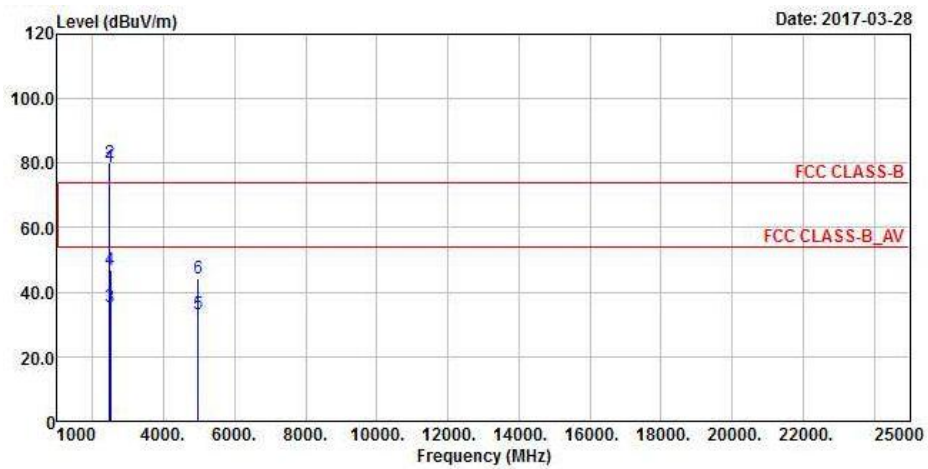

**Band Edge
Peak
Horizontal**

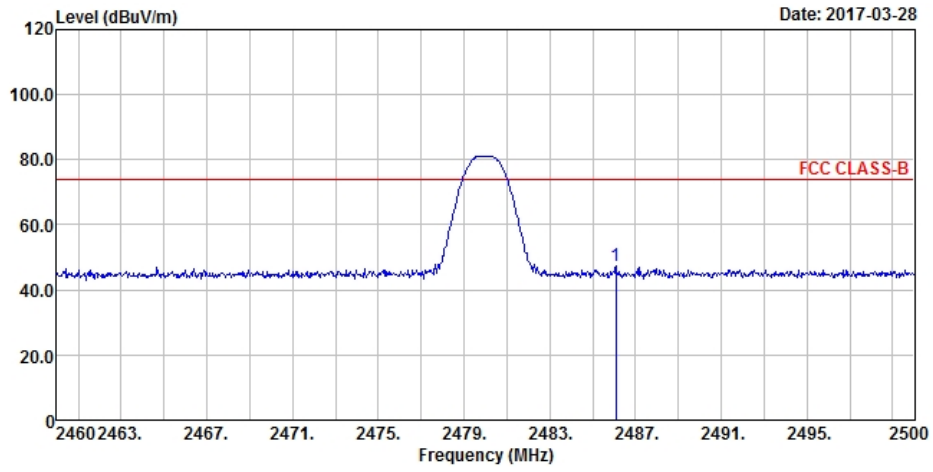

Vertical

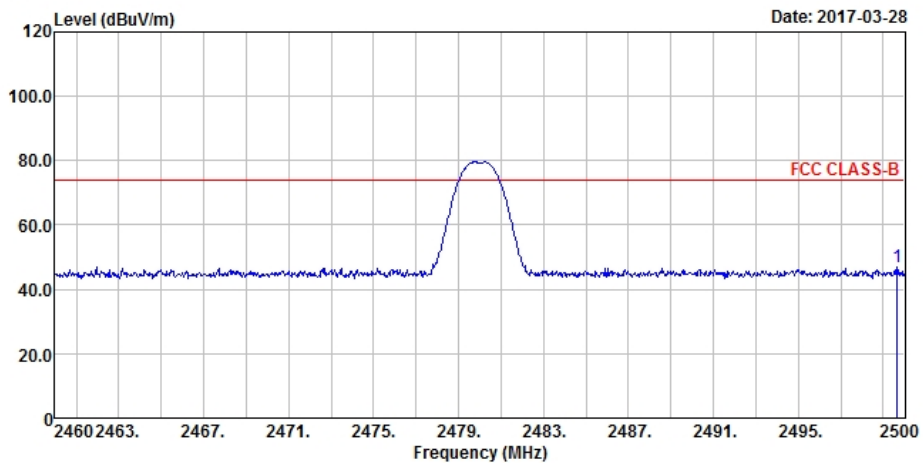

Average Horizontal

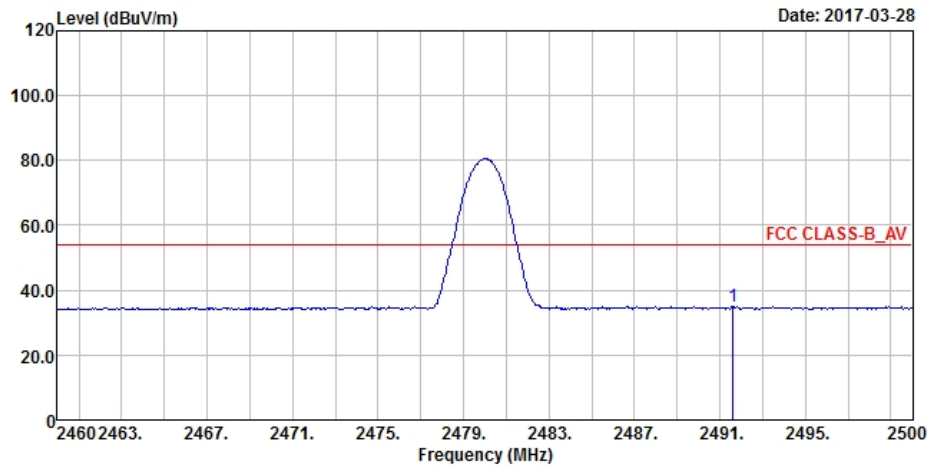

Vertical

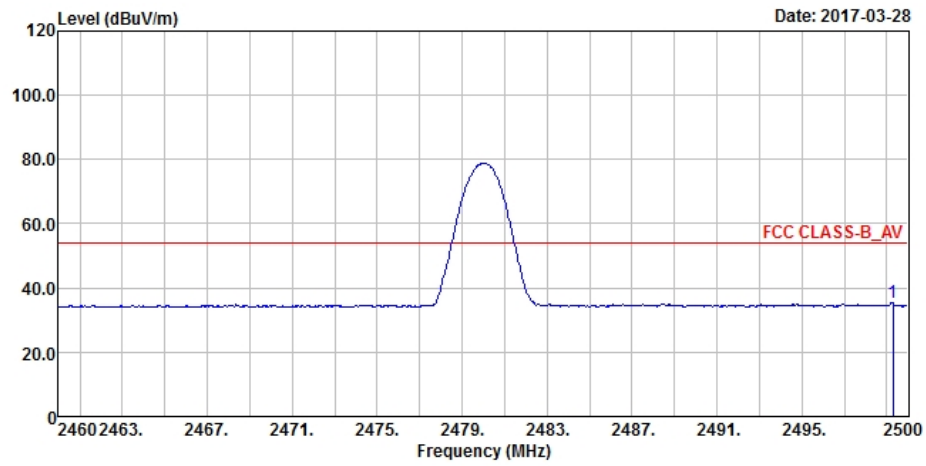

Antennal Polarity & Test Distance: Horizontal at 3 m

Frequency (MHz)	Emission Level (dBuV/m)	Read Level (dBuV)	Limit (dBuV/m)	Margin (dB)	Antenna Factor (dB/m)	Cable Loss (dB)	Preamp Factor (dB)	Antenna Height (cm)	Table Angle (Degree)	Remark
2480	81.43	87.45			27.15	4.15	37.32	200	180	Average
2480	82.18	88.2			27.15	4.15	37.32	200	180	Peak
2486.08	47.31	53.33	74	-26.69	27.15	4.15	37.32	200	180	Peak
2491.6	35.19	41.15	54	-18.81	27.2	4.16	37.32	200	180	Average
4960	33.26	48.23	54	-20.74	31.16	6.91	53.04	110	250	Average
4960	44.57	59.54	74	-29.43	31.16	6.91	53.04	110	250	Peak

Antennal Polarity & Test Distance: Vertical at 3 m

Frequency (MHz)	Emission Level (dBuV/m)	Read Level (dBuV)	Limit (dBuV/m)	Margin (dB)	Antenna Factor (dB/m)	Cable Loss (dB)	Preamp Factor (dB)	Antenna Height (cm)	Table Angle (Degree)	Remark
2480	78.78	84.8			27.15	4.15	37.32	203	18	Average
2480	79.96	85.98			27.15	4.15	37.32	203	18	Peak
2499.28	35.32	41.21	54	-18.68	27.2	4.16	37.25	203	18	Average
2499.64	46.84	52.73	74	-27.16	27.2	4.16	37.25	203	18	Peak
4960	33.15	48.12	54	-20.85	31.16	6.91	53.04	105	99	Average
4960	44.06	59.03	74	-29.94	31.16	6.91	53.04	105	99	Peak

Remarks:

- Emission Level = Read Level + Antenna Factor + Cable Loss - Preamp Factor
Margin value = Emission level – Limit value
- 2480 MHz: Fundamental frequency.

Mode C

EUT Test Condition		Measurement Detail	
Channel	Channel 39	Frequency Range	1 GHz ~ 25 GHz
Input Power	120 Vac, 60 Hz	Detector Function	Peak (PK) Average (AV)
Environmental Conditions	25 deg. C, 65 % RH	Tested By	Getaz Yang

Horizontal

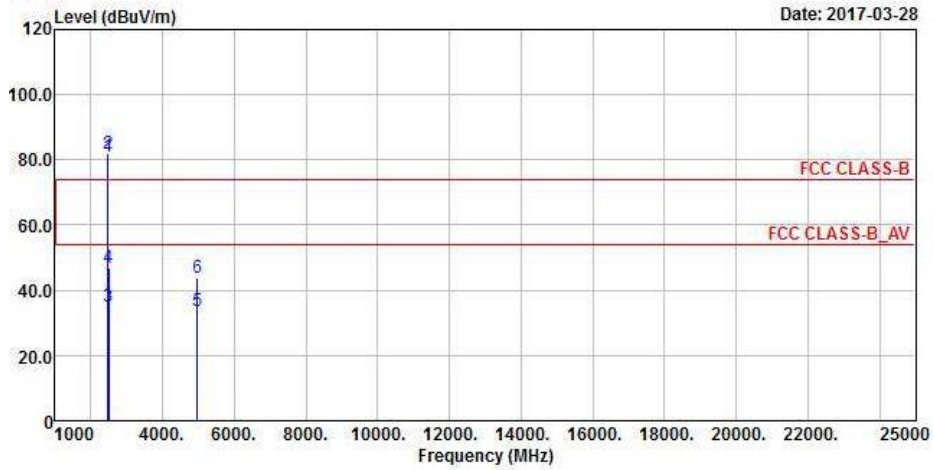

Vertical

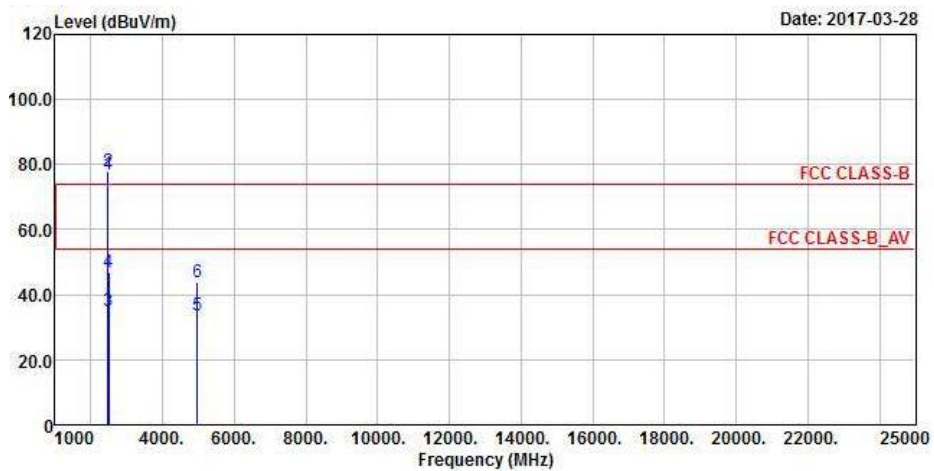

**Band Edge
Peak
Horizontal**

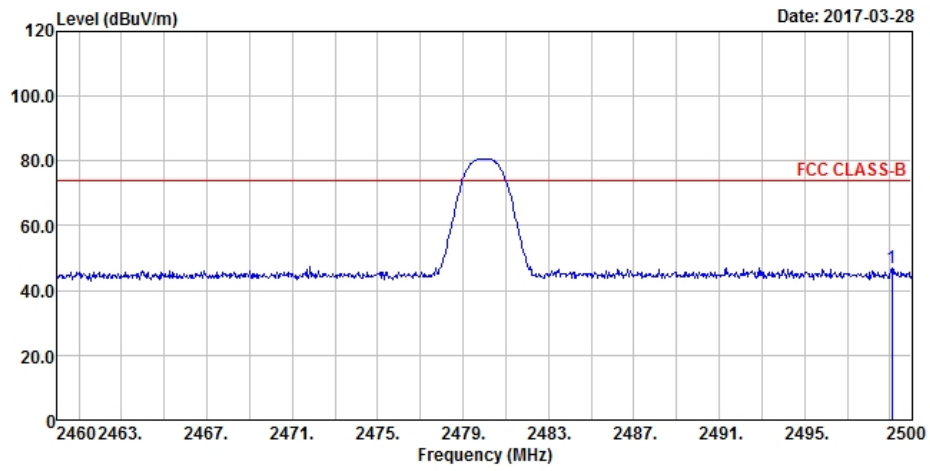

Vertical

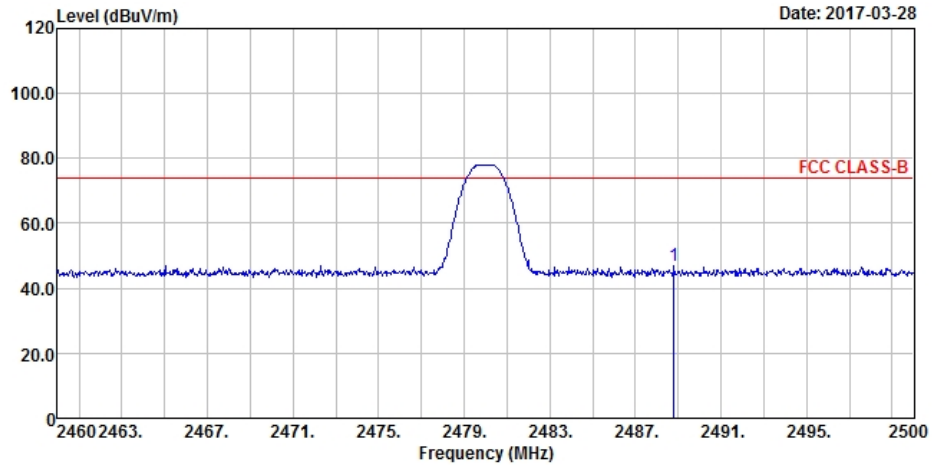

**Average
Horizontal**

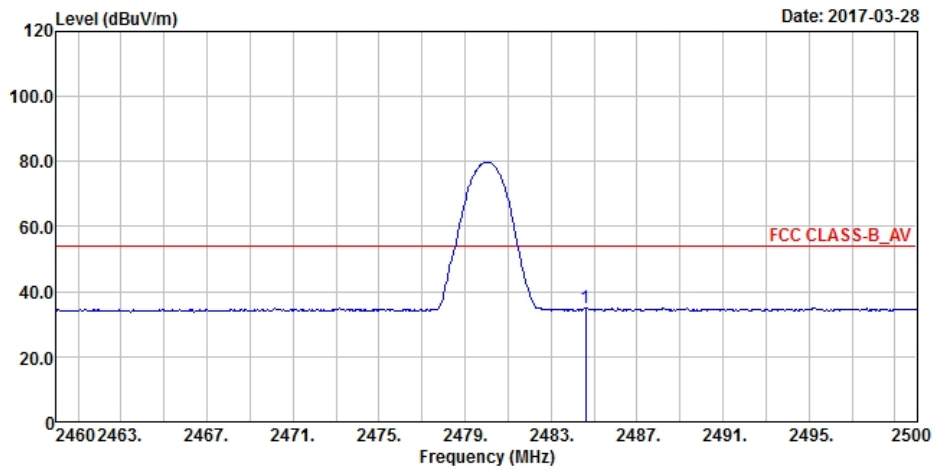

Vertical

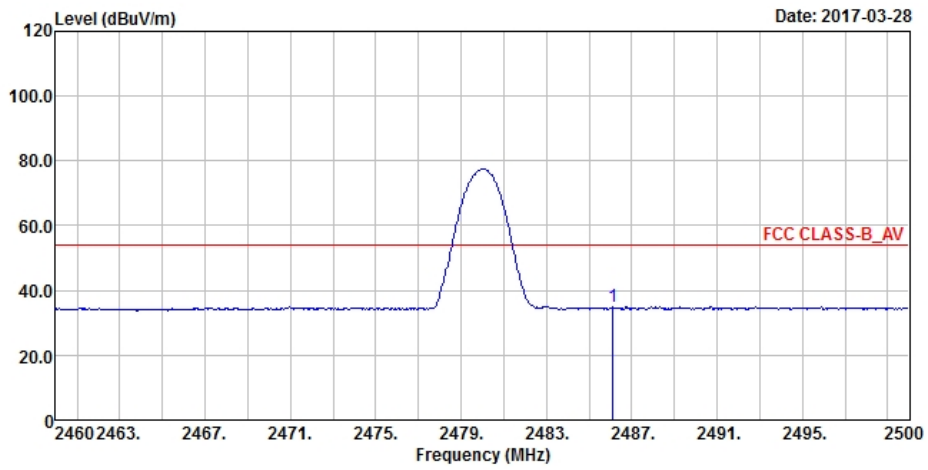

Antennal Polarity & Test Distance: Horizontal at 3 m

Frequency (MHz)	Emission Level (dBuV/m)	Read Level (dBuV)	Limit (dBuV/m)	Margin (dB)	Antenna Factor (dB/m)	Cable Loss (dB)	Preamp Factor (dB)	Antenna Height (cm)	Table Angle (Degree)	Remark
2480	81.12	87.14			27.15	4.15	37.32	246	246	Average
2480	81.85	87.87			27.15	4.15	37.32	246	246	Peak
2484.6	34.99	41.01	54	-19.01	27.15	4.15	37.32	246	246	Average
2499.08	46.9	52.79	74	-27.1	27.2	4.16	37.25	246	246	Peak
4960	33.78	48.75	54	-20.22	31.16	6.91	53.04	103	16	Average
4960	43.94	58.91	74	-30.06	31.16	6.91	53.04	103	16	Peak

Antennal Polarity & Test Distance: Vertical at 3 m

Frequency (MHz)	Emission Level (dBuV/m)	Read Level (dBuV)	Limit (dBuV/m)	Margin (dB)	Antenna Factor (dB/m)	Cable Loss (dB)	Preamp Factor (dB)	Antenna Height (cm)	Table Angle (Degree)	Remark
2480	77.22	83.24			27.15	4.15	37.32	201	280	Average
2480	78.14	84.16			27.15	4.15	37.32	201	280	Peak
2486.12	35	41.02	54	-19	27.15	4.15	37.32	201	280	Average
2488.8	46.78	52.74	74	-27.22	27.2	4.16	37.32	201	280	Peak
4960	33.67	48.64	54	-20.33	31.16	6.91	53.04	116	211	Average
4960	43.68	58.65	74	-30.32	31.16	6.91	53.04	116	211	Peak

Remarks:

- Emission Level = Read Level + Antenna Factor + Cable Loss - Preamp Factor
Margin value = Emission level – Limit value
- 2480 MHz: Fundamental frequency.

Mode D

EUT Test Condition		Measurement Detail	
Channel	Channel 39	Frequency Range	1 GHz ~ 25 GHz
Input Power	120 Vac, 60 Hz	Detector Function	Peak (PK) Average (AV)
Environmental Conditions	25 deg. C, 65 % RH	Tested By	Getaz Yang

Horizontal

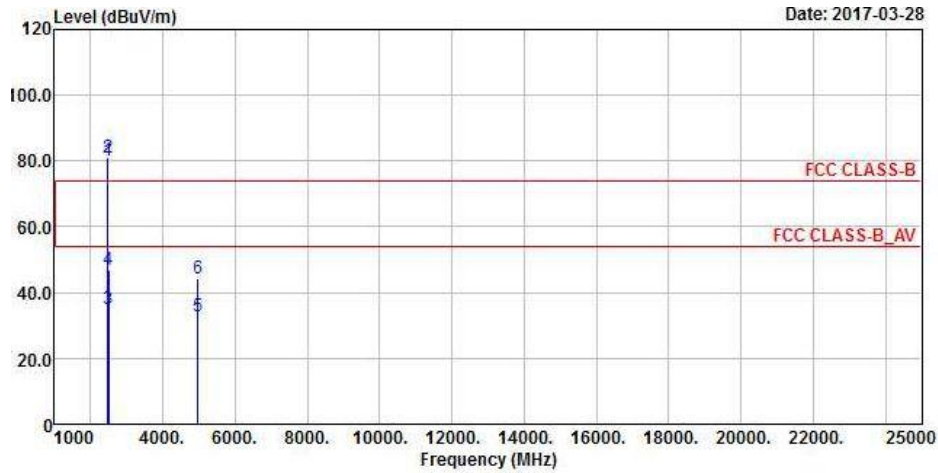

Vertical

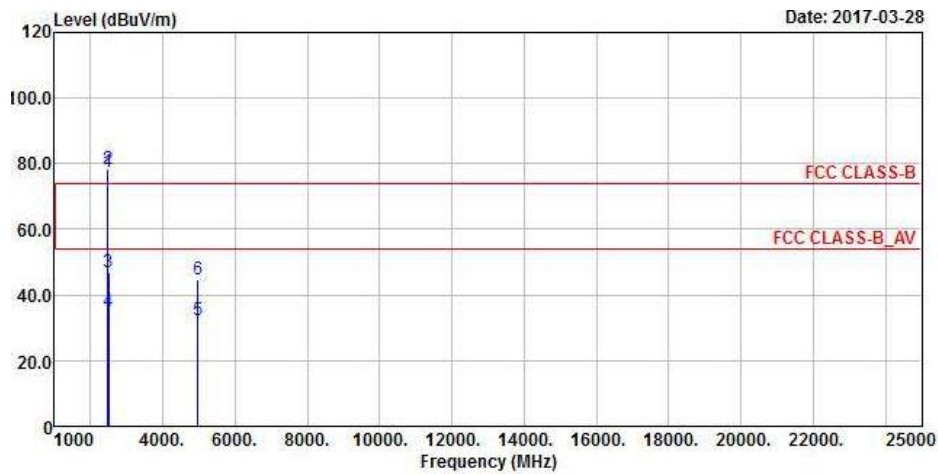

**Band Edge
Peak
Horizontal**

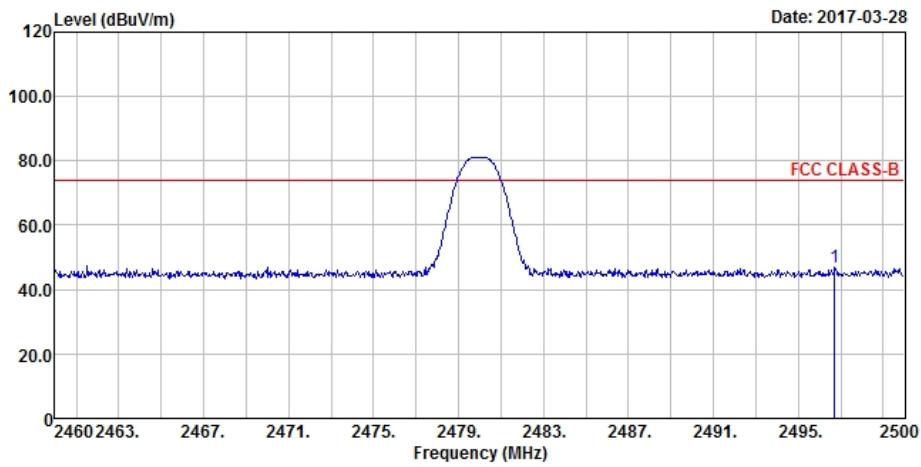

Vertical

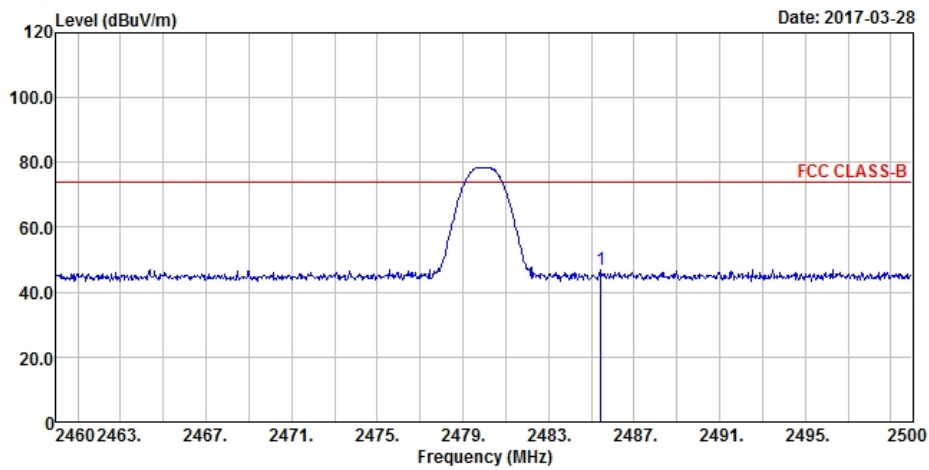

Average Horizontal

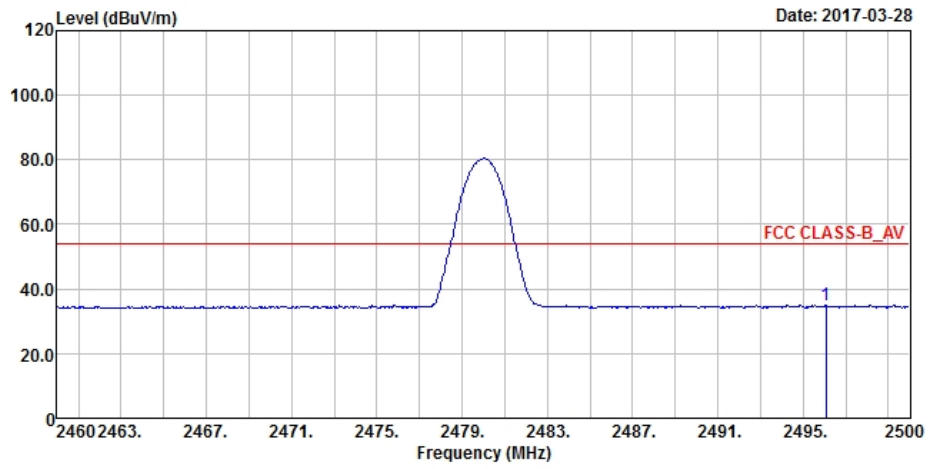

Vertical

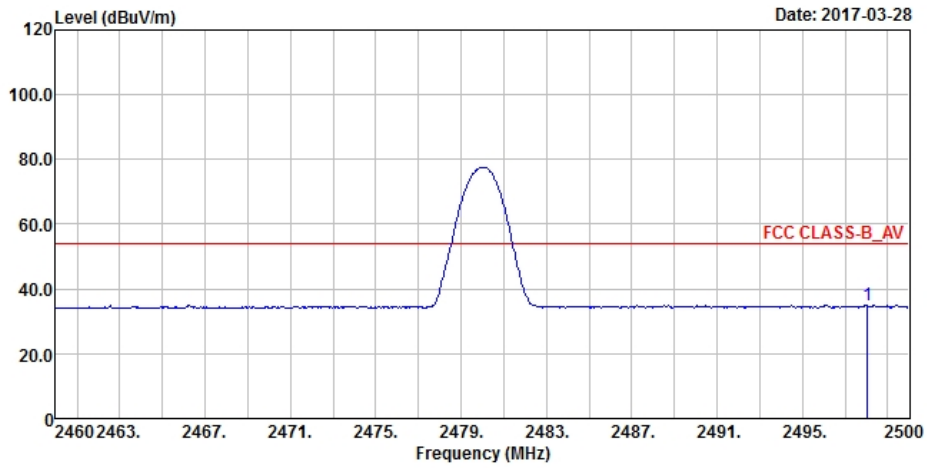

Antennal Polarity & Test Distance: Horizontal at 3 m

Frequency (MHz)	Emission Level (dBuV/m)	Read Level (dBuV)	Limit (dBuV/m)	Margin (dB)	Antenna Factor (dB/m)	Cable Loss (dB)	Preamp Factor (dB)	Antenna Height (cm)	Table Angle (Degree)	Remark
2480	80.19	86.21			27.15	4.15	37.32	102	46	Average
2480	81.08	87.1			27.15	4.15	37.32	102	46	Peak
2496.08	34.97	40.86	54	-19.03	27.2	4.16	37.25	102	46	Average
2496.72	46.82	52.71	74	-27.18	27.2	4.16	37.25	102	46	Peak
4960	32.91	47.88	54	-21.09	31.16	6.91	53.04	100	156	Average
4960	44.18	59.15	74	-29.82	31.16	6.91	53.04	100	156	Peak

Antennal Polarity & Test Distance: Vertical at 3 m

Frequency (MHz)	Emission Level (dBuV/m)	Read Level (dBuV)	Limit (dBuV/m)	Margin (dB)	Antenna Factor (dB/m)	Cable Loss (dB)	Preamp Factor (dB)	Antenna Height (cm)	Table Angle (Degree)	Remark
2480	77.64	83.66			27.15	4.15	37.32	208	181	Average
2480	78.57	84.59			27.15	4.15	37.32	208	181	Peak
2485.44	46.92	52.94	74	-27.08	27.15	4.15	37.32	208	181	Peak
2498.04	34.97	40.86	54	-19.03	27.2	4.16	37.25	208	181	Average
4960	32.39	47.36	54	-21.61	31.16	6.91	53.04	100	162	Average
4960	44.79	59.76	74	-29.21	31.16	6.91	53.04	100	162	Peak

Remarks:

- Emission Level = Read Level + Antenna Factor + Cable Loss - Preamp Factor
Margin value = Emission level – Limit value
- 2480 MHz: Fundamental frequency.

9 kHz ~ 30 MHz DATA:

The amplitude of spurious emissions attenuated more than 20 dB below the permissible value is not required to be report.

30 MHz ~ 1 GHz WORST-CASE DATA:

Mode A

EUT Test Condition		Measurement Detail	
Channel	Channel 39	Frequency Range	30 MHz ~ 1 GHz
Input Power	120 Vac, 60 Hz	Detector Function	Peak (PK) Quasi-peak (QP)
Environmental Conditions	25 deg. C, 65 % RH	Tested By	Getaz Yang

Horizontal

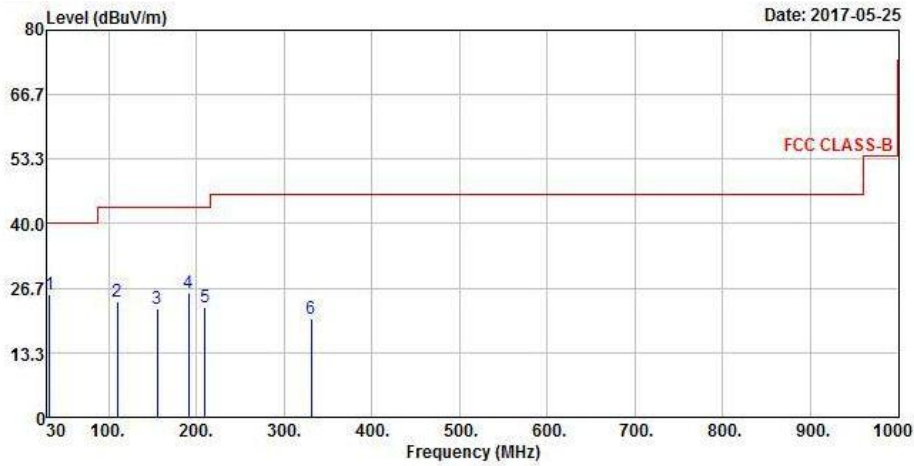

Vertical

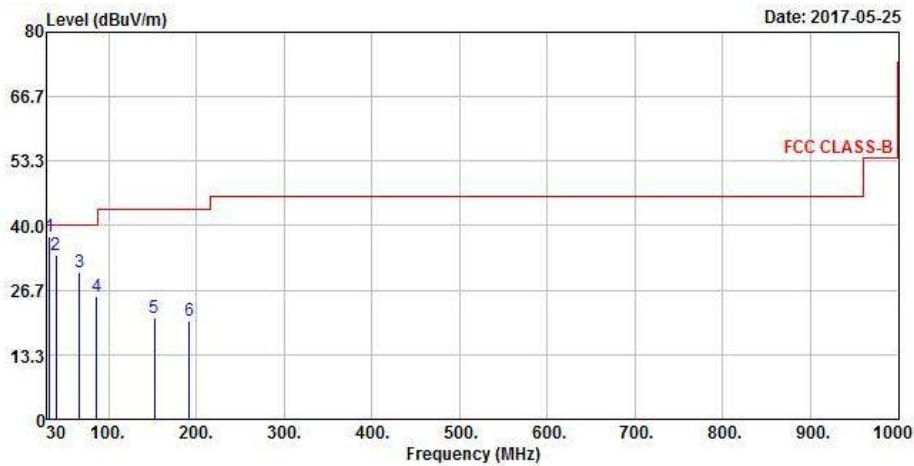

Antennal Polarity & Test Distance: Horizontal at 3 m

Frequency (MHz)	Emission Level (dBuV/m)	Read Level (dBuV)	Limit (dBuV/m)	Margin (dB)	Antenna Factor (dB/m)	Cable Loss (dB)	Preamp Factor (dB)	Antenna Height (cm)	Table Angle (Degree)	Remark
32.91	25.29	43.31	40	-14.71	12.47	0.6	31.09	131	322	Peak
109.54	23.85	44.6	43.5	-19.65	9.99	1.1	31.84	100	344	Peak
155.13	22.35	40.26	43.5	-21.15	12.72	1.11	31.74	111	178	Peak
191.02	25.78	46.21	43.5	-17.72	9.98	1.27	31.68	119	218	Peak
209.45	22.8	43.31	43.5	-20.7	9.77	1.33	31.61	122	338	Peak
330.7	20.49	36.9	46	-25.51	13.68	1.72	31.81	137	252	Peak

Antennal Polarity & Test Distance: Vertical at 3 m

Frequency (MHz)	Emission Level (dBuV/m)	Read Level (dBuV)	Limit (dBuV/m)	Margin (dB)	Antenna Factor (dB/m)	Cable Loss (dB)	Preamp Factor (dB)	Antenna Height (cm)	Table Angle (Degree)	Remark
32.91	37.79	55.81	40	-2.21	12.47	0.6	31.09	140	145	Peak
39.7	33.88	50.69	40	-6.12	13.54	0.64	30.99	107	180	Peak
66.86	30.52	50.23	40	-9.48	11.12	0.85	31.68	125	201	Peak
86.26	25.44	48.05	40	-14.56	8.23	0.94	31.78	106	334	Peak
152.22	20.89	38.72	43.5	-22.61	12.71	1.12	31.66	125	319	Peak
191.99	20.29	40.8	43.5	-23.21	9.91	1.27	31.69	128	289	Peak

Remarks:

- Emission Level = Read Level + Antenna Factor + Cable Loss - Preamp Factor
 Margin value = Emission level – Limit value

Mode B

EUT Test Condition		Measurement Detail	
Channel	Channel 39	Frequency Range	30 MHz ~ 1 GHz
Input Power	120 Vac, 60 Hz	Detector Function	Peak (PK) Quasi-peak (QP)
Environmental Conditions	25 deg. C, 65 % RH	Tested By	Getaz Yang

Horizontal

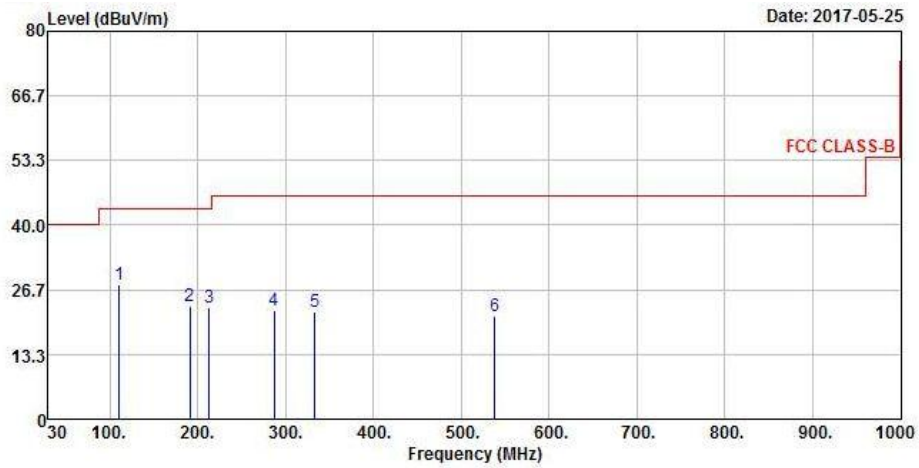

Vertical

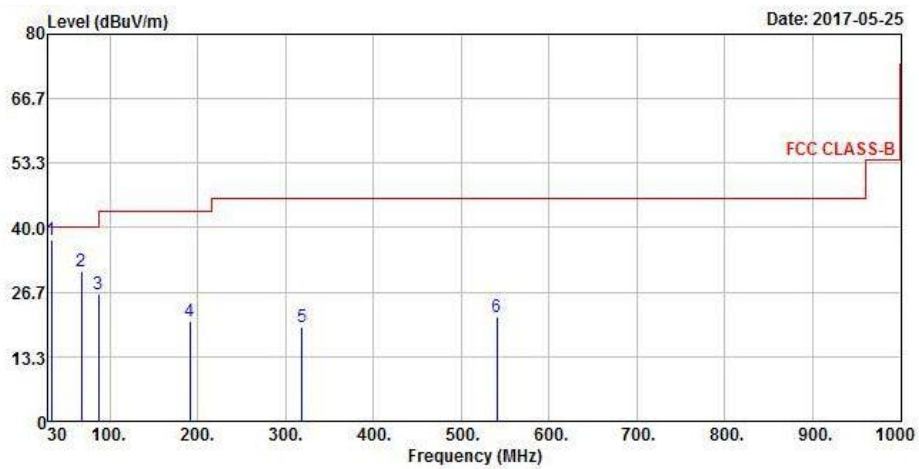

Antennal Polarity & Test Distance: Horizontal at 3 m										
Frequency (MHz)	Emission Level (dBuV/m)	Read Level (dBuV)	Limit (dBuV/m)	Margin (dB)	Antenna Factor (dB/m)	Cable Loss (dB)	Preamp Factor (dB)	Antenna Height (cm)	Table Angle (Degree)	Remark
110.51	27.82	48.47	43.5	-15.68	10.09	1.11	31.85	132	337	Peak
191.02	23.32	43.75	43.5	-20.18	9.98	1.27	31.68	136	213	Peak
213.33	22.98	43.33	43.5	-20.52	9.93	1.35	31.63	122	30	Peak
287.05	22.41	39.96	46	-23.59	12.57	1.6	31.72	115	269	Peak
333.61	22.16	38.5	46	-23.84	13.75	1.72	31.81	114	63	Peak
538.28	21.34	32.71	46	-24.66	18.19	2.16	31.72	110	119	Peak
Antennal Polarity & Test Distance: Vertical at 3 m										
Frequency (MHz)	Emission Level (dBuV/m)	Read Level (dBuV)	Limit (dBuV/m)	Margin (dB)	Antenna Factor (dB/m)	Cable Loss (dB)	Preamp Factor (dB)	Antenna Height (cm)	Table Angle (Degree)	Remark
33.88	37.56	55.41	40	-2.44	12.63	0.6	31.08	108	209	Peak
67.83	30.93	50.81	40	-9.07	11	0.85	31.73	107	68	Peak
87.23	26.37	48.99	40	-13.63	8.25	0.95	31.82	138	333	Peak
191.02	20.56	40.99	43.5	-22.94	9.98	1.27	31.68	119	205	Peak
319.06	19.46	36.28	46	-26.54	13.4	1.68	31.9	136	350	Peak
540.22	21.4	32.73	46	-24.6	18.24	2.16	31.73	115	219	Peak

Remarks:

- Emission Level = Read Level + Antenna Factor + Cable Loss - Preamp Factor
Margin value = Emission level – Limit value

Mode C

EUT Test Condition		Measurement Detail	
Channel	Channel 39	Frequency Range	30 MHz ~ 1 GHz
Input Power	120 Vac, 60 Hz	Detector Function	Peak (PK) Quasi-peak (QP)
Environmental Conditions	25 deg. C, 65 % RH	Tested By	Getaz Yang

Horizontal

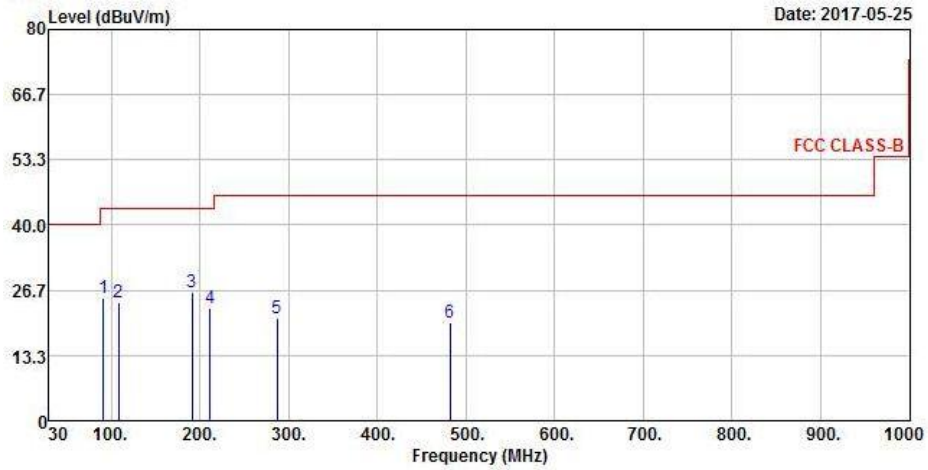

Vertical

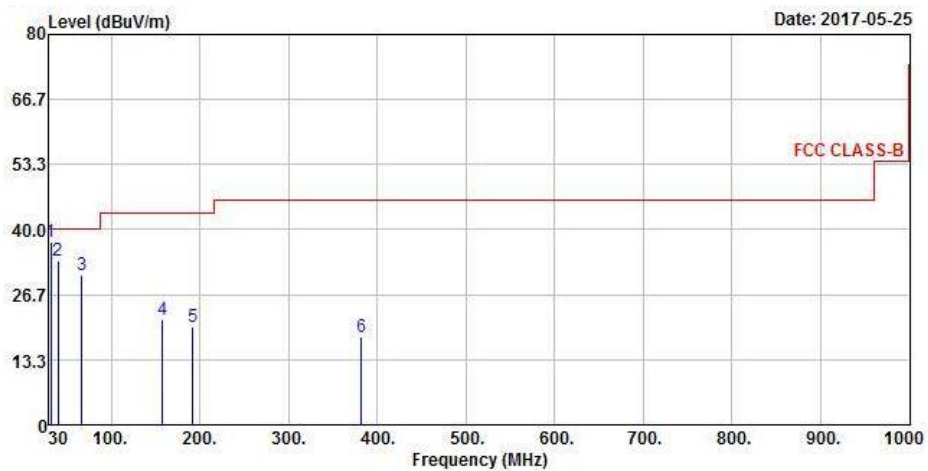

Antennal Polarity & Test Distance: Horizontal at 3 m										
Frequency (MHz)	Emission Level (dBuV/m)	Read Level (dBuV)	Limit (dBuV/m)	Margin (dB)	Antenna Factor (dB/m)	Cable Loss (dB)	Preamp Factor (dB)	Antenna Height (cm)	Table Angle (Degree)	Remark
91.11	25.09	47.7	43.5	-18.41	8.38	0.97	31.96	121	332	Peak
108.57	24.21	45.06	43.5	-19.29	9.9	1.1	31.85	132	24	Peak
191.02	26.26	46.69	43.5	-17.24	9.98	1.27	31.68	138	218	Peak
211.39	23.05	43.46	43.5	-20.45	9.85	1.34	31.6	122	176	Peak
287.05	20.95	38.5	46	-25.05	12.57	1.6	31.72	135	265	Peak
482.02	20.12	32.94	46	-25.88	16.96	2.05	31.83	107	43	Peak
Antennal Polarity & Test Distance: Vertical at 3 m										
Frequency (MHz)	Emission Level (dBuV/m)	Read Level (dBuV)	Limit (dBuV/m)	Margin (dB)	Antenna Factor (dB/m)	Cable Loss (dB)	Preamp Factor (dB)	Antenna Height (cm)	Table Angle (Degree)	Remark
31.94	37.62	55.84	40	-2.38	12.3	0.59	31.11	124	60	Peak
39.7	33.72	50.53	40	-6.28	13.54	0.64	30.99	112	69	Peak
66.86	30.69	50.4	40	-9.31	11.12	0.85	31.68	125	211	Peak
158.04	21.61	39.58	43.5	-21.89	12.73	1.13	31.83	110	16	Peak
191.99	20.22	40.73	43.5	-23.28	9.91	1.27	31.69	103	326	Peak
382.11	18.13	33.33	46	-27.87	14.91	1.86	31.97	128	155	Peak

Remarks:

- Emission Level = Read Level + Antenna Factor + Cable Loss - Preamp Factor
Margin value = Emission level – Limit value

Mode D

EUT Test Condition		Measurement Detail	
Channel	Channel 39	Frequency Range	30 MHz ~ 1 GHz
Input Power	120 Vac, 60 Hz	Detector Function	Peak (PK) Quasi-peak (QP)
Environmental Conditions	25 deg. C, 65 % RH	Tested By	Getaz Yang

Horizontal

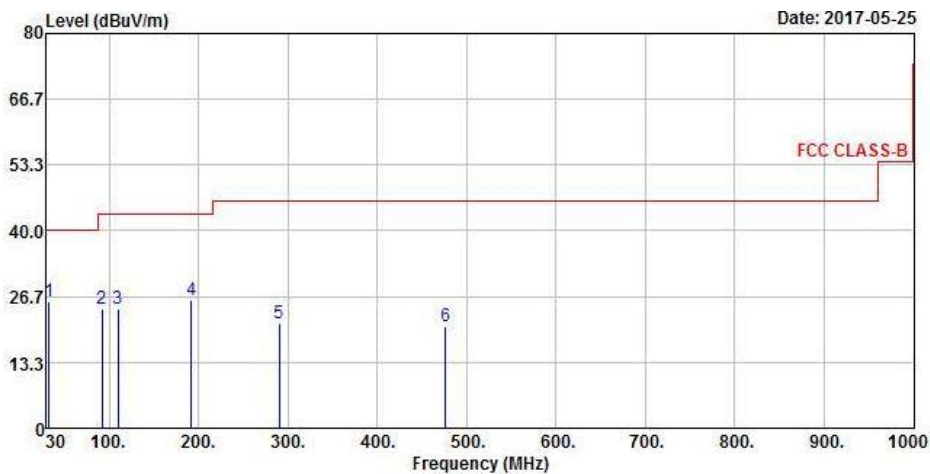

Vertical

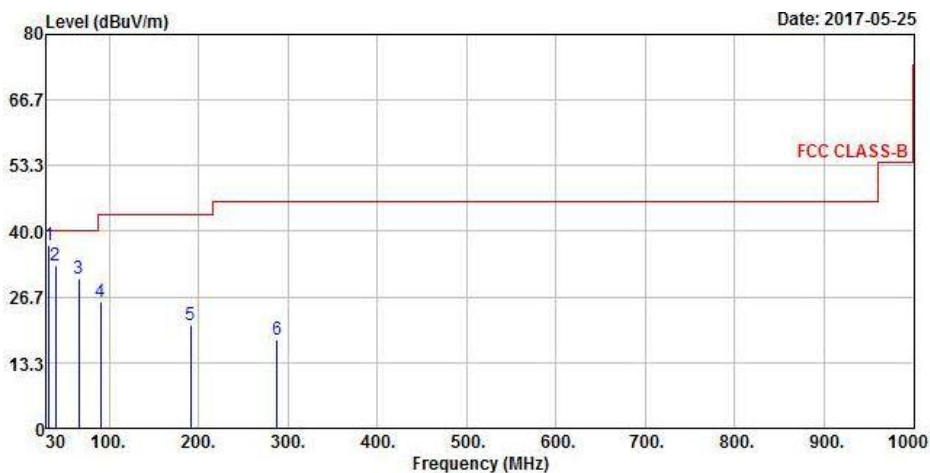

Antennal Polarity & Test Distance: Horizontal at 3 m

Frequency (MHz)	Emission Level (dBuV/m)	Read Level (dBuV)	Limit (dBuV/m)	Margin (dB)	Antenna Factor (dB/m)	Cable Loss (dB)	Preamp Factor (dB)	Antenna Height (cm)	Table Angle (Degree)	Remark
32.91	25.58	43.6	40	-14.42	12.47	0.6	31.09	104	123	Peak
92.08	24.23	46.75	43.5	-19.27	8.45	0.99	31.96	108	243	Peak
109.54	24.33	45.08	43.5	-19.17	9.99	1.1	31.84	129	109	Peak
191.99	25.99	46.5	43.5	-17.51	9.91	1.27	31.69	135	338	Peak
289.96	21.33	38.74	46	-24.67	12.65	1.61	31.67	131	206	Peak
476.2	20.76	33.74	46	-25.24	16.85	2.04	31.87	115	183	Peak

Antennal Polarity & Test Distance: Vertical at 3 m

Frequency (MHz)	Emission Level (dBuV/m)	Read Level (dBuV)	Limit (dBuV/m)	Margin (dB)	Antenna Factor (dB/m)	Cable Loss (dB)	Preamp Factor (dB)	Antenna Height (cm)	Table Angle (Degree)	Remark
32.91	37.3	55.32	40	-2.7	12.47	0.6	31.09	121	297	Peak
39.7	33.19	50	40	-6.81	13.54	0.64	30.99	136	64	Peak
65.89	30.48	50.03	40	-9.52	11.24	0.85	31.64	129	334	Peak
90.14	25.56	48.25	43.5	-17.94	8.3	0.97	31.96	108	202	Peak
191.02	20.91	41.34	43.5	-22.59	9.98	1.27	31.68	140	75	Peak
288.02	18.13	35.63	46	-27.87	12.6	1.6	31.7	136	284	Peak

Remarks:

- Emission Level = Read Level + Antenna Factor + Cable Loss - Preamp Factor
 Margin value = Emission level – Limit value

4.2 Conducted Emission Measurement

4.2.1 Limits of Conducted Emission Measurement

Frequency (MHz)	Conducted Limit (dBuV)	
	Quasi-peak	Average
0.15 - 0.5	66 - 56	56 - 46
0.50 - 5.0	56	46
5.0 - 30.0	60	50

4.2.2 Test Instruments

Description & Manufacturer	Model No.	Serial No.	Date Of Calibration	Due Date Of Calibration
Test Receiver ROHDE & SCHWARZ	ESCI	100613	Nov. 21, 2016	Nov. 20, 2017
RF signal cable (with 10dB PAD) Woken	5D-FB	Cable-cond1-01	Dec. 22, 2016	Dec. 21, 2017
LISN ROHDE & SCHWARZ (EUT)	ESH3-Z5	835239/001	Mar. 10, 2017	Mar. 09, 2018
LISN ROHDE & SCHWARZ (Peripheral)	ESH3-Z5	100311	Jul. 28, 2016	Jul. 27, 2017
Software ADT	BV ADT_Cond_ V7.3.7.3	NA	NA	NA

- Note: 1. The calibration interval of the above test instruments is 12 months and the calibrations are traceable to NML/ROC and NIST/USA.
 2. The test was performed in HwaYa Shielded Room 1.
 3. The VCCI Site Registration No. is C-2040.

4.2.3 Test Procedures

- The EUT was placed 0.4 meters from the conducting wall of the shielded room with EUT being connected to the power mains through a line impedance stabilization network (LISN). Other support units were connected to the power mains through another LISN. The two LISNs provide 50 ohm/50 uH of coupling impedance for the measuring instrument.
- Both lines of the power mains connected to the EUT were checked for maximum conducted interference.
- The frequency range from 150 kHz to 30 MHz was searched. Emission levels under (Limit – 20 dB) was not recorded.

Note: All modes of operation were investigated and the worst-case emissions are reported.

4.2.4 Deviation from Test Standard

No deviation.

4.2.5 TEST SETUP

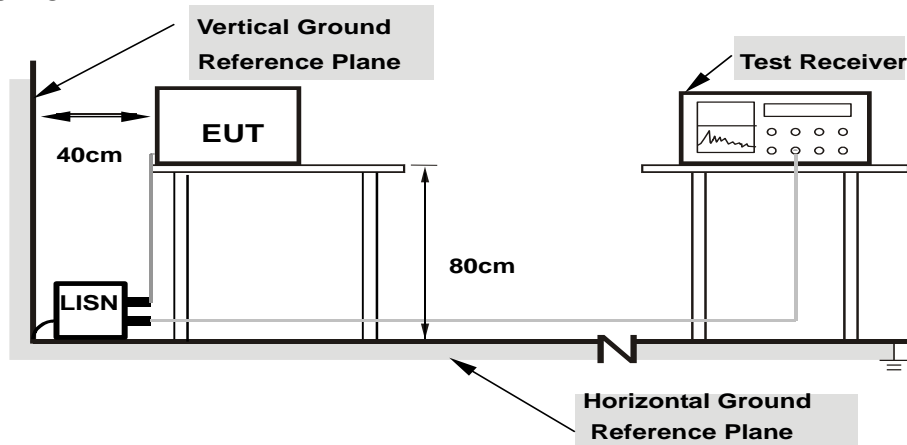

Note: 1.Support units were connected to second LISN.

2.Both of LISNs (AMN) are 80 cm from EUT and at least 80 from other units and other metal planes

4.2.6 EUT Operating Conditions

- a. Placed the EUT on the testing table.
- b. Set the EUT under transmission condition continuously at specific channel frequency.

4.2.7 Test Results

CONDUCTED WORST-CASE DATA

Mode A

Frequency Range	150kHz ~ 30MHz	Detector Function & Resolution Bandwidth	Quasi-Peak (QP) / Average (AV), 9kHz
Input Power	120Vac, 60Hz	Environmental Conditions	25°C, 65%RH
Tested by	Getaz Yang	Test Date	2017/5/26

Phase Of Power : Line (L)										
No	Frequency (MHz)	Correction Factor (dB)	Reading Value (dBuV)		Emission Level (dBuV)		Limit (dBuV)		Margin (dB)	
			Q.P.	AV.	Q.P.	AV.	Q.P.	AV.	Q.P.	AV.
1	0.17000	10.35	33.79	18.78	44.14	29.13	64.96	54.96	-20.82	-25.83
2	0.47309	10.40	36.54	31.95	46.94	42.35	56.46	46.46	-9.52	-4.11
3	1.10200	10.41	25.70	20.03	36.11	30.44	56.00	46.00	-19.89	-15.56
4	1.41400	10.42	36.42	29.06	46.84	39.48	56.00	46.00	-9.16	-6.52
5	2.42200	10.48	10.13	4.20	20.61	14.68	56.00	46.00	-35.39	-31.32
6	4.49000	10.59	11.80	5.66	22.39	16.25	56.00	46.00	-33.61	-29.75

Remarks:

1. Q.P. and AV. are abbreviations of quasi-peak and average individually.
2. The emission levels of other frequencies were very low against the limit.
3. Margin value = Emission level – Limit value
4. Correction factor = Insertion loss + Cable loss
5. Emission Level = Correction Factor + Reading Value

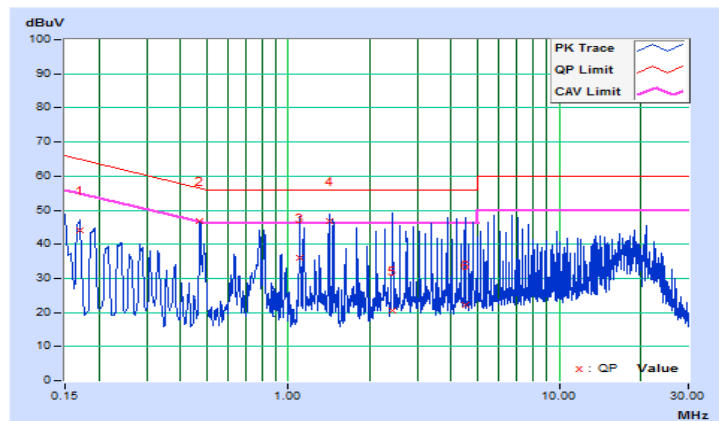

Frequency Range	150kHz ~ 30MHz	Detector Function & Resolution Bandwidth	Quasi-Peak (QP) / Average (AV), 9kHz
Input Power	120Vac, 60Hz	Environmental Conditions	25°C, 65%RH
Tested by	Getaz Yang	Test Date	2017/5/26

Phase Of Power : Neutral (N)										
No	Frequency (MHz)	Correction Factor (dB)	Reading Value (dBuV)		Emission Level (dBuV)		Limit (dBuV)		Margin (dB)	
			Q.P.	AV.	Q.P.	AV.	Q.P.	AV.	Q.P.	AV.
1	0.46600	10.16	39.15	34.36	49.31	44.52	56.58	46.58	-7.27	-2.06
2	0.77429	10.17	26.57	18.05	36.74	28.22	56.00	46.00	-19.26	-17.78
3	1.07800	10.17	12.58	2.83	22.75	13.00	56.00	46.00	-33.25	-33.00
4	1.38602	10.19	12.14	3.23	22.33	13.42	56.00	46.00	-33.67	-32.58
5	1.71400	10.21	15.63	6.04	25.84	16.25	56.00	46.00	-30.16	-29.75
6	4.74600	10.37	13.91	5.53	24.28	15.90	56.00	46.00	-31.72	-30.10

Remarks:

1. Q.P. and AV. are abbreviations of quasi-peak and average individually.
2. The emission levels of other frequencies were very low against the limit.
3. Margin value = Emission level – Limit value
4. Correction factor = Insertion loss + Cable loss
5. Emission Level = Correction Factor + Reading Value

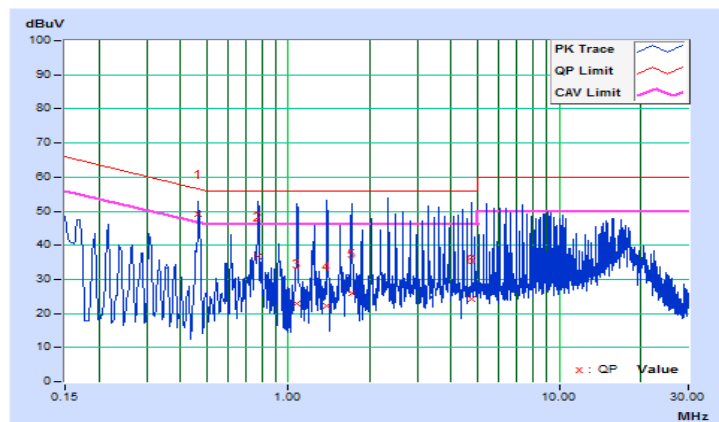

Mode B

Frequency Range	150kHz ~ 30MHz	Detector Function & Resolution Bandwidth	Quasi-Peak (QP) / Average (AV), 9kHz
Input Power	120Vac, 60Hz	Environmental Conditions	25°C, 65%RH
Tested by	Getaz Yang	Test Date	2017/5/26

Phase Of Power : Line (L)										
No	Frequency (MHz)	Correction Factor (dB)	Reading Value (dBuV)		Emission Level (dBuV)		Limit (dBuV)		Margin (dB)	
			Q.P.	AV.	Q.P.	AV.	Q.P.	AV.	Q.P.	AV.
1	0.46200	10.40	33.23	28.87	43.63	39.27	56.66	46.66	-13.03	-7.39
2	0.77000	10.40	30.95	26.52	41.35	36.92	56.00	46.00	-14.65	-9.08
3	1.07400	10.40	35.31	31.26	45.71	41.66	56.00	46.00	-10.29	-4.34
4	1.68600	10.44	35.93	31.92	46.37	42.36	56.00	46.00	-9.63	-3.64
5	2.29800	10.48	36.40	32.49	46.88	42.97	56.00	46.00	-9.12	-3.03
6	3.52200	10.54	35.42	31.52	45.96	42.06	56.00	46.00	-10.04	-3.94

Remarks:

1. Q.P. and AV. are abbreviations of quasi-peak and average individually.
2. The emission levels of other frequencies were very low against the limit.
3. Margin value = Emission level – Limit value
4. Correction factor = Insertion loss + Cable loss
5. Emission Level = Correction Factor + Reading Value

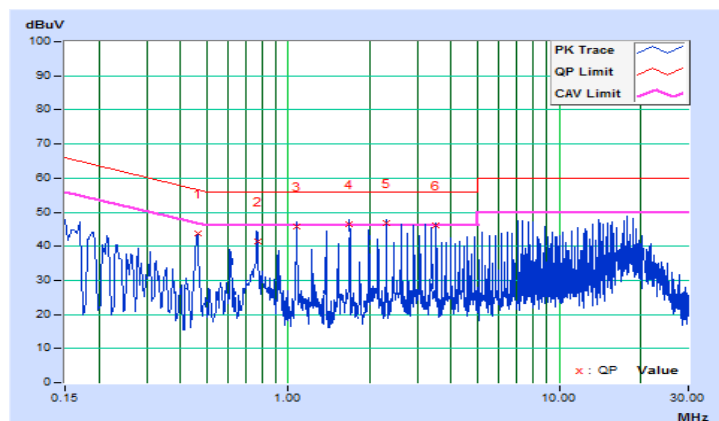

Frequency Range	150kHz ~ 30MHz	Detector Function & Resolution Bandwidth	Quasi-Peak (QP) / Average (AV), 9kHz
Input Power	120Vac, 60Hz	Environmental Conditions	25°C, 65%RH
Tested by	Getaz Yang	Test Date	2017/5/26

Phase Of Power : Neutral (N)										
No	Frequency (MHz)	Correction Factor (dB)	Reading Value (dBuV)		Emission Level (dBuV)		Limit (dBuV)		Margin (dB)	
			Q.P.	AV.	Q.P.	AV.	Q.P.	AV.	Q.P.	AV.
1	0.45800	10.16	39.51	35.35	49.67	45.51	56.73	46.73	-7.06	-1.22
2	0.76618	10.17	40.44	34.46	50.61	44.63	56.00	46.00	-5.39	-1.37
3	1.38200	10.19	36.39	32.53	46.58	42.72	56.00	46.00	-9.42	-3.28
4	1.68600	10.21	40.46	35.54	50.67	45.75	56.00	46.00	-5.33	-0.25
5	2.29800	10.25	40.85	33.95	51.10	44.20	56.00	46.00	-4.90	-1.80
6	2.91000	10.28	40.54	34.54	50.82	44.82	56.00	46.00	-5.18	-1.18

Remarks:

1. Q.P. and AV. are abbreviations of quasi-peak and average individually.
2. The emission levels of other frequencies were very low against the limit.
3. Margin value = Emission level – Limit value
4. Correction factor = Insertion loss + Cable loss
5. Emission Level = Correction Factor + Reading Value

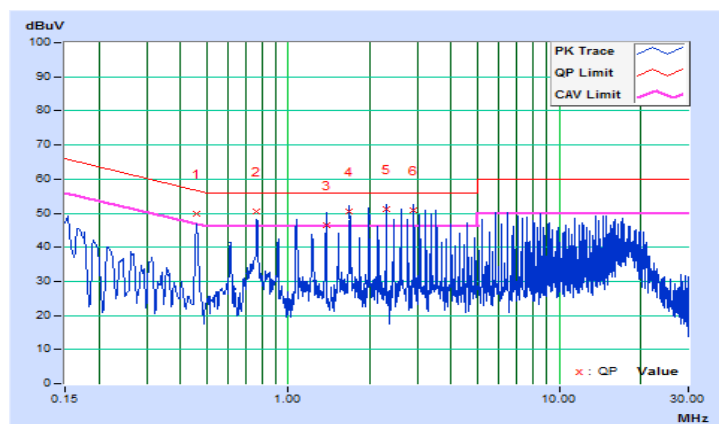

Mode C

Frequency Range	150kHz ~ 30MHz	Detector Function & Resolution Bandwidth	Quasi-Peak (QP) / Average (AV), 9kHz
Input Power	120Vac, 60Hz	Environmental Conditions	25°C, 65%RH
Tested by	Getaz Yang	Test Date	2017/5/26

Phase Of Power : Line (L)										
No	Frequency (MHz)	Correction Factor (dB)	Reading Value (dBuV)		Emission Level (dBuV)		Limit (dBuV)		Margin (dB)	
			Q.P.	AV.	Q.P.	AV.	Q.P.	AV.	Q.P.	AV.
1	0.47000	10.40	29.67	25.08	40.07	35.48	56.51	46.51	-16.44	-11.03
2	0.77800	10.40	34.91	30.57	45.31	40.97	56.00	46.00	-10.69	-5.03
3	1.09000	10.41	32.22	28.05	42.63	38.46	56.00	46.00	-13.37	-7.54
4	1.70200	10.44	32.84	27.59	43.28	38.03	56.00	46.00	-12.72	-7.97
5	2.33000	10.48	34.59	30.52	45.07	41.00	56.00	46.00	-10.93	-5.00
6	2.63800	10.50	36.09	31.98	46.59	42.48	56.00	46.00	-9.41	-3.52

Remarks:

1. Q.P. and AV. are abbreviations of quasi-peak and average individually.
2. The emission levels of other frequencies were very low against the limit.
3. Margin value = Emission level – Limit value
4. Correction factor = Insertion loss + Cable loss
5. Emission Level = Correction Factor + Reading Value

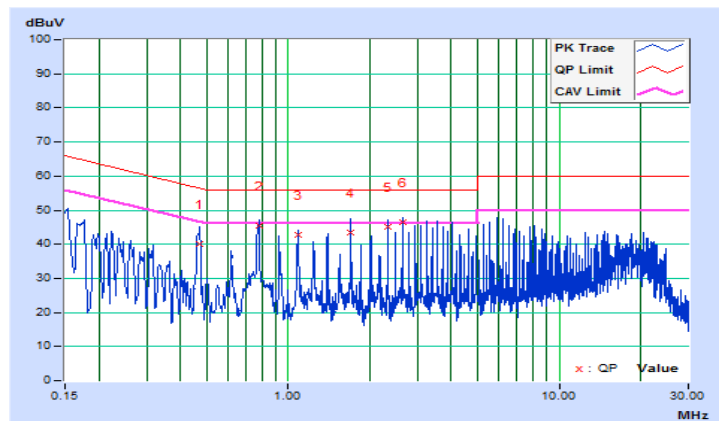

Frequency Range	150kHz ~ 30MHz	Detector Function & Resolution Bandwidth	Quasi-Peak (QP) / Average (AV), 9kHz
Input Power	120Vac, 60Hz	Environmental Conditions	25°C, 65%RH
Tested by	Getaz Yang	Test Date	2017/5/26

Phase Of Power : Neutral (N)										
No	Frequency (MHz)	Correction Factor (dB)	Reading Value (dBuV)		Emission Level (dBuV)		Limit (dBuV)		Margin (dB)	
			Q.P.	AV.	Q.P.	AV.	Q.P.	AV.	Q.P.	AV.
1	0.47000	10.16	39.46	35.44	49.62	45.60	56.51	46.51	-6.89	-0.91
2	0.79000	10.17	27.47	20.52	37.64	30.69	56.00	46.00	-18.36	-15.31
3	1.08198	10.17	14.19	6.17	24.36	16.34	56.00	46.00	-31.64	-29.66
4	1.39000	10.19	12.90	4.05	23.09	14.24	56.00	46.00	-32.91	-31.76
5	1.70200	10.21	17.00	8.86	27.21	19.07	56.00	46.00	-28.79	-26.93
6	2.95800	10.28	15.58	6.47	25.86	16.75	56.00	46.00	-30.14	-29.25

Remarks:

1. Q.P. and AV. are abbreviations of quasi-peak and average individually.
2. The emission levels of other frequencies were very low against the limit.
3. Margin value = Emission level – Limit value
4. Correction factor = Insertion loss + Cable loss
5. Emission Level = Correction Factor + Reading Value

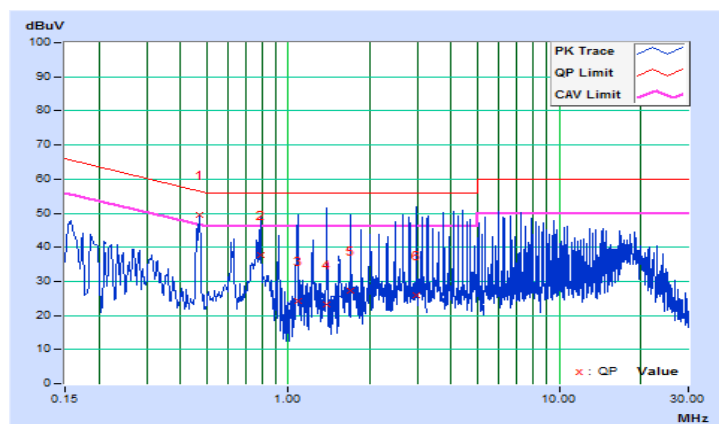

Mode D

Frequency Range	150kHz ~ 30MHz	Detector Function & Resolution Bandwidth	Quasi-Peak (QP) / Average (AV), 9kHz
Input Power	120Vac, 60Hz	Environmental Conditions	25°C, 65%RH
Tested by	Getaz Yang	Test Date	2017/5/26

Phase Of Power : Line (L)										
No	Frequency (MHz)	Correction Factor (dB)	Reading Value (dBuV)		Emission Level (dBuV)		Limit (dBuV)		Margin (dB)	
			Q.P.	AV.	Q.P.	AV.	Q.P.	AV.	Q.P.	AV.
1	0.50600	10.40	14.66	6.37	25.06	16.77	56.00	46.00	-30.94	-29.23
2	0.83000	10.40	16.92	12.45	27.32	22.85	56.00	46.00	-28.68	-23.15
3	1.16600	10.41	32.69	27.40	43.10	37.81	56.00	46.00	-12.90	-8.19
4	2.51400	10.49	36.17	32.19	46.66	42.68	56.00	46.00	-9.34	-3.32
5	3.65000	10.55	10.75	4.59	21.30	15.14	56.00	46.00	-34.70	-30.86
6	4.89400	10.61	27.33	23.43	37.94	34.04	56.00	46.00	-18.06	-11.96

Remarks:

1. Q.P. and AV. are abbreviations of quasi-peak and average individually.
2. The emission levels of other frequencies were very low against the limit.
3. Margin value = Emission level – Limit value
4. Correction factor = Insertion loss + Cable loss
5. Emission Level = Correction Factor + Reading Value

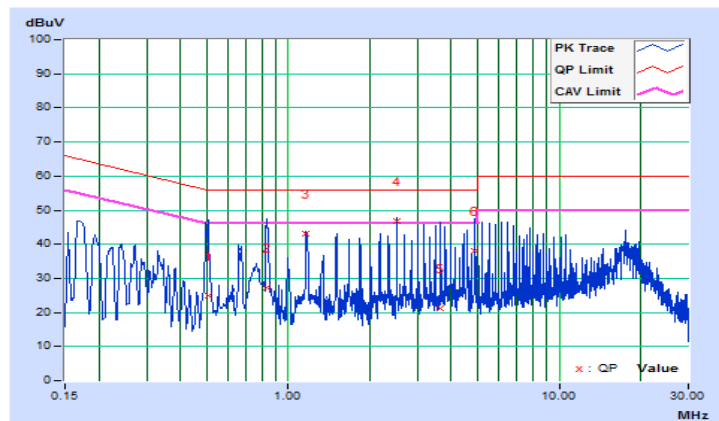

Frequency Range	150kHz ~ 30MHz	Detector Function & Resolution Bandwidth	Quasi-Peak (QP) / Average (AV), 9kHz
Input Power	120Vac, 60Hz	Environmental Conditions	25°C, 65%RH
Tested by	Getaz Yang	Test Date	2017/5/26

Phase Of Power : Neutral (N)										
No	Frequency (MHz)	Correction Factor (dB)	Reading Value (dBuV)		Emission Level (dBuV)		Limit (dBuV)		Margin (dB)	
			Q.P.	AV.	Q.P.	AV.	Q.P.	AV.	Q.P.	AV.
1	0.51000	10.16	27.15	23.49	37.31	33.65	56.00	46.00	-18.69	-12.35
2	0.84200	10.17	33.27	29.28	43.44	39.45	56.00	46.00	-12.56	-6.55
3	1.20600	10.18	16.36	7.76	26.54	17.94	56.00	46.00	-29.46	-28.06
4	1.88200	10.22	19.33	12.62	29.55	22.84	56.00	46.00	-26.45	-23.16
5	2.53390	10.26	40.78	34.97	51.04	45.23	56.00	46.00	-4.96	-0.77
6	4.35800	10.35	31.57	17.14	41.92	27.49	56.00	46.00	-14.08	-18.51

Remarks:

1. Q.P. and AV. are abbreviations of quasi-peak and average individually.
2. The emission levels of other frequencies were very low against the limit.
3. Margin value = Emission level – Limit value
4. Correction factor = Insertion loss + Cable loss
5. Emission Level = Correction Factor + Reading Value

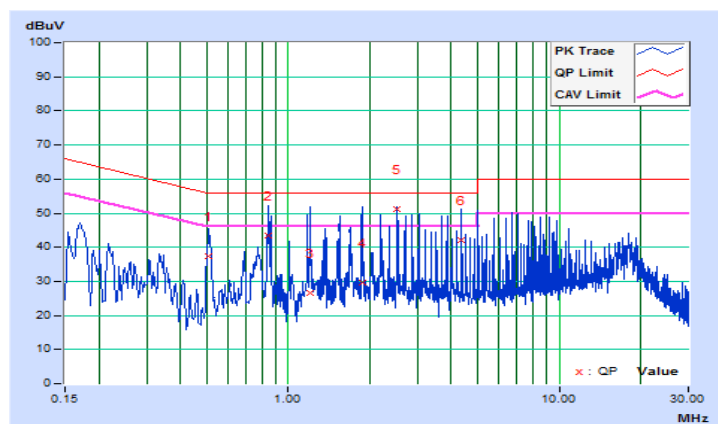

4.3 6 dB Bandwidth Measurement

4.3.1 Limits of 6 dB Bandwidth Measurement

The minimum of 6 dB Bandwidth Measurement is 0.5 MHz.

4.3.2 Test Setup

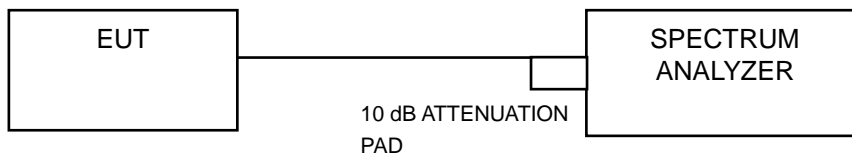

4.3.3 Test Instruments

Refer to section 4.1.2 to get information of above instrument.

4.3.4 Test Procedure

- Set resolution bandwidth (RBW) = 100 kHz
- Set the video bandwidth (VBW) $\geq 3 \times$ RBW, Detector = Peak.
- Trace mode = max hold.
- Sweep = auto couple.
- Measure the maximum width of the emission that is constrained by the frequencies associated with the two amplitude points (upper and lower) that are attenuated by 6 dB relative to the maximum level measured in the fundamental emission

4.3.5 Deviation from Test Standard

No deviation.

4.3.6 EUT Operating Conditions

The software provided by client to enable the EUT under transmission condition continuously at lowest, middle and highest channel frequencies individually.

4.3.7 Test Result

Channel	Frequency (MHz)	6 dB Bandwidth (MHz)	Minimum Limit (MHz)	Pass / Fail
0	2402	0.68	0.5	Pass
19	2440	0.68	0.5	Pass
39	2480	0.68	0.5	Pass

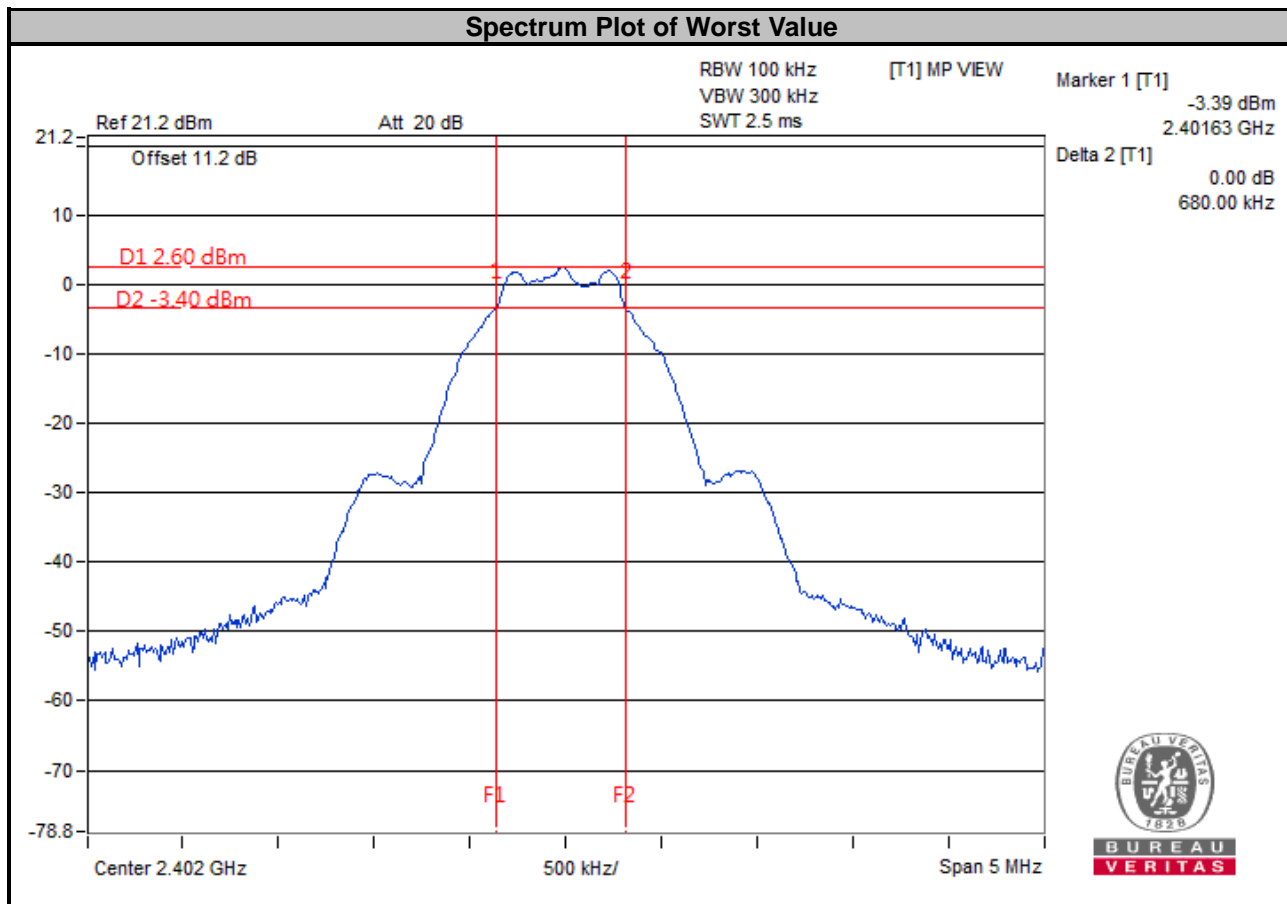

4.4 Conducted Output Power Measurement

4.4.1 Limits of Conducted Output Power Measurement

For systems using digital modulation in the 2400–2483.5 MHz bands: 1 Watt (30 dBm)

4.4.2 Test Setup

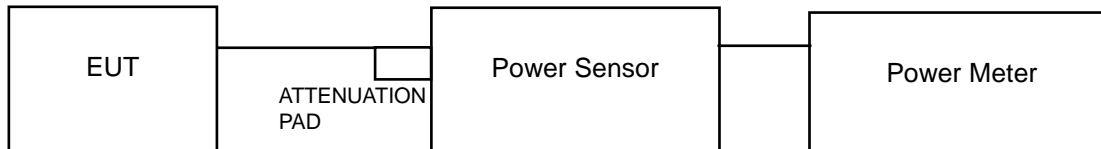

4.4.3 Test Instruments

Refer to section 4.1.2 to get information of above instrument.

4.4.4 Test Procedures

A peak / average power sensor was used on the output port of the EUT. A power meter was used to read the response of the peak / average power sensor. Record the power level.

4.4.5 Deviation from Test Standard

No deviation.

4.4.6 EUT Operating Conditions

The software provided by client to enable the EUT under transmission condition continuously at lowest, middle and highest channel frequencies individually.

4.4.7 Test Results

Channel	Frequency (MHz)	Peak Power (mW)	Peak Power (dBm)	Limit (dBm)	Pass / Fail
0	2402	2.371	3.75	30	Pass
19	2440	2.377	3.76	30	Pass
39	2480	2.328	3.67	30	Pass

4.5 Power Spectral Density Measurement

4.5.1 Limits of Power Spectral Density Measurement

The Maximum of Power Spectral Density Measurement is 8 dBm.

4.5.2 Test Setup

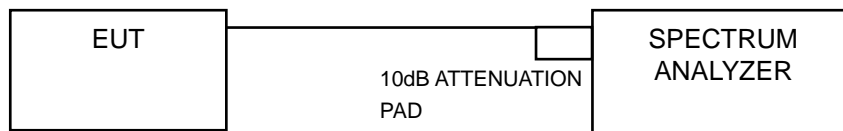

4.5.3 Test Instruments

Refer to section 4.1.2 to get information of above instrument.

4.5.4 Test Procedure

- Set the RBW = 3 kHz, VBW = 10 kHz, Detector = peak.
- Sweep time = auto couple, Trace mode = max hold, allow trace to fully stabilize.
- Use the peak marker function to determine the maximum power level in any 100 kHz band segment within the fundamental EBW.

4.5.5 Deviation from Test Standard

No deviation.

4.5.6 EUT Operating Condition

The software provided by client to enable the EUT under transmission condition continuously at lowest, middle and highest channel frequencies individually.

4.5.7 Test Results

Channel	Frequency (MHz)	PSD (dBm/3 kHz)	Limit (dBm/3 kHz)	Pass / Fail
0	2402	-12.38	8	Pass
19	2440	-12.30	8	Pass
39	2480	-12.33	8	Pass

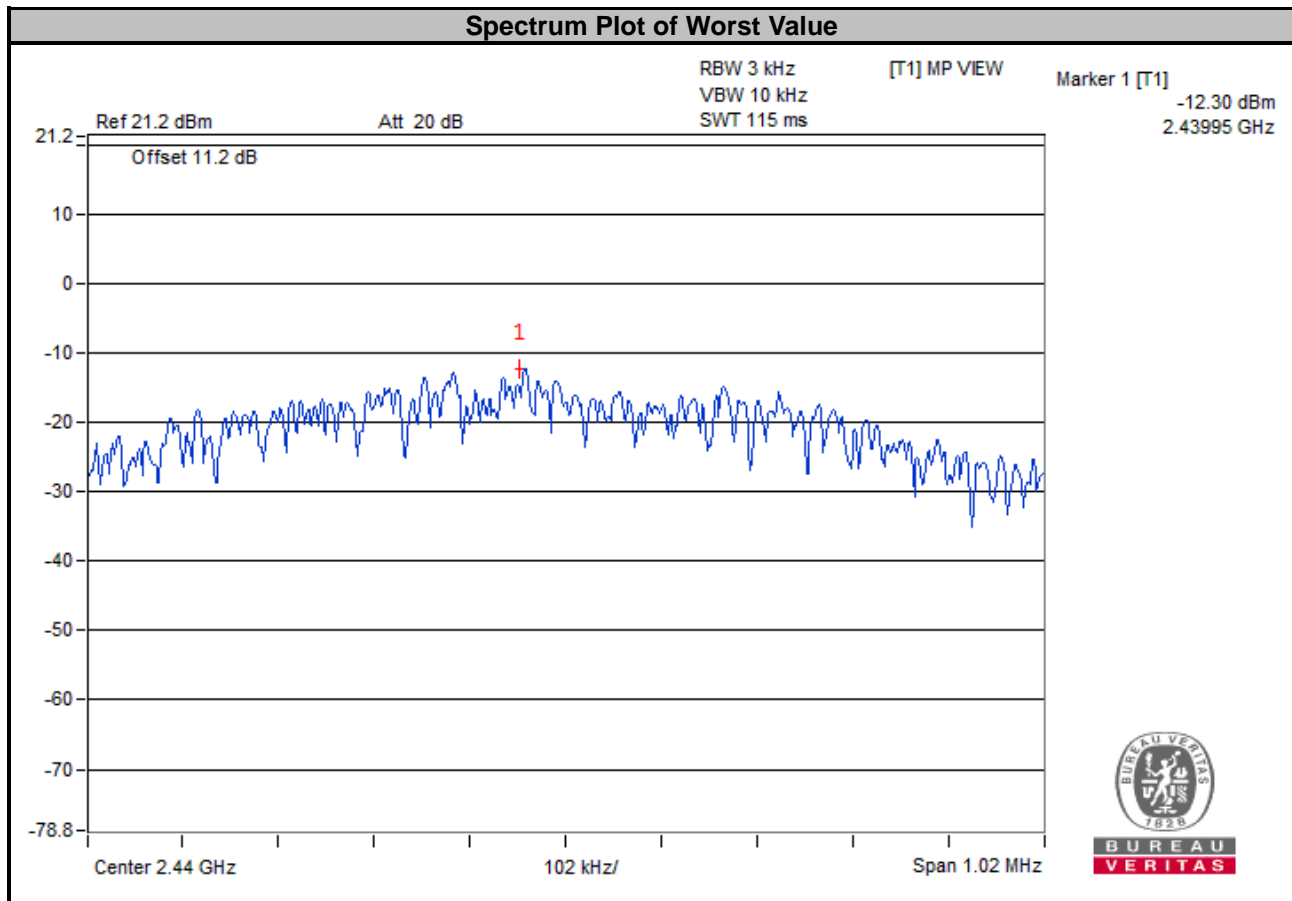

4.6 Conducted Out of Band Emission Measurement

4.6.1 Limits of Conducted Out of Band Emission Measurement

Below -20 dB of the highest emission level of operating band (in 100 kHz Resolution Bandwidth).

4.6.2 Test Setup

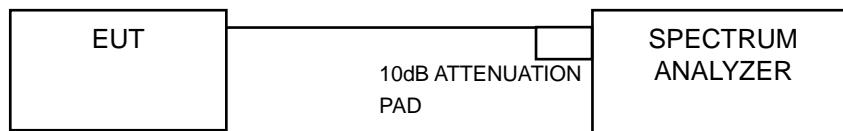

4.6.3 Test Instruments

Refer to section 4.1.2 to get information of above instrument.

4.6.4 Test Procedure

MEASUREMENT PROCEDURE REF

1. Set the RBW = 100 kHz.
2. Set the VBW \geq 300 kHz.
3. Detector = peak.
4. Sweep time = auto couple.
5. Trace mode = max hold.
6. Allow trace to fully stabilize.
7. Use the peak marker function to determine the maximum power level in any 100 kHz band segment within the fundamental EBW.

MEASUREMENT PROCEDURE OOB

1. Set RBW = 100 kHz.
2. Set VBW \geq 300 kHz.
3. Detector = peak.
4. Sweep = auto couple.
5. Trace Mode = max hold.
6. Allow trace to fully stabilize.
7. Use the peak marker function to determine the maximum amplitude level.

4.6.5 Deviation from Test Standard

No deviation.

4.6.6 EUT Operating Condition

The software provided by client to enable the EUT under transmission condition continuously at lowest, middle and highest channel frequencies individually.

4.6.7 TEST RESULTS

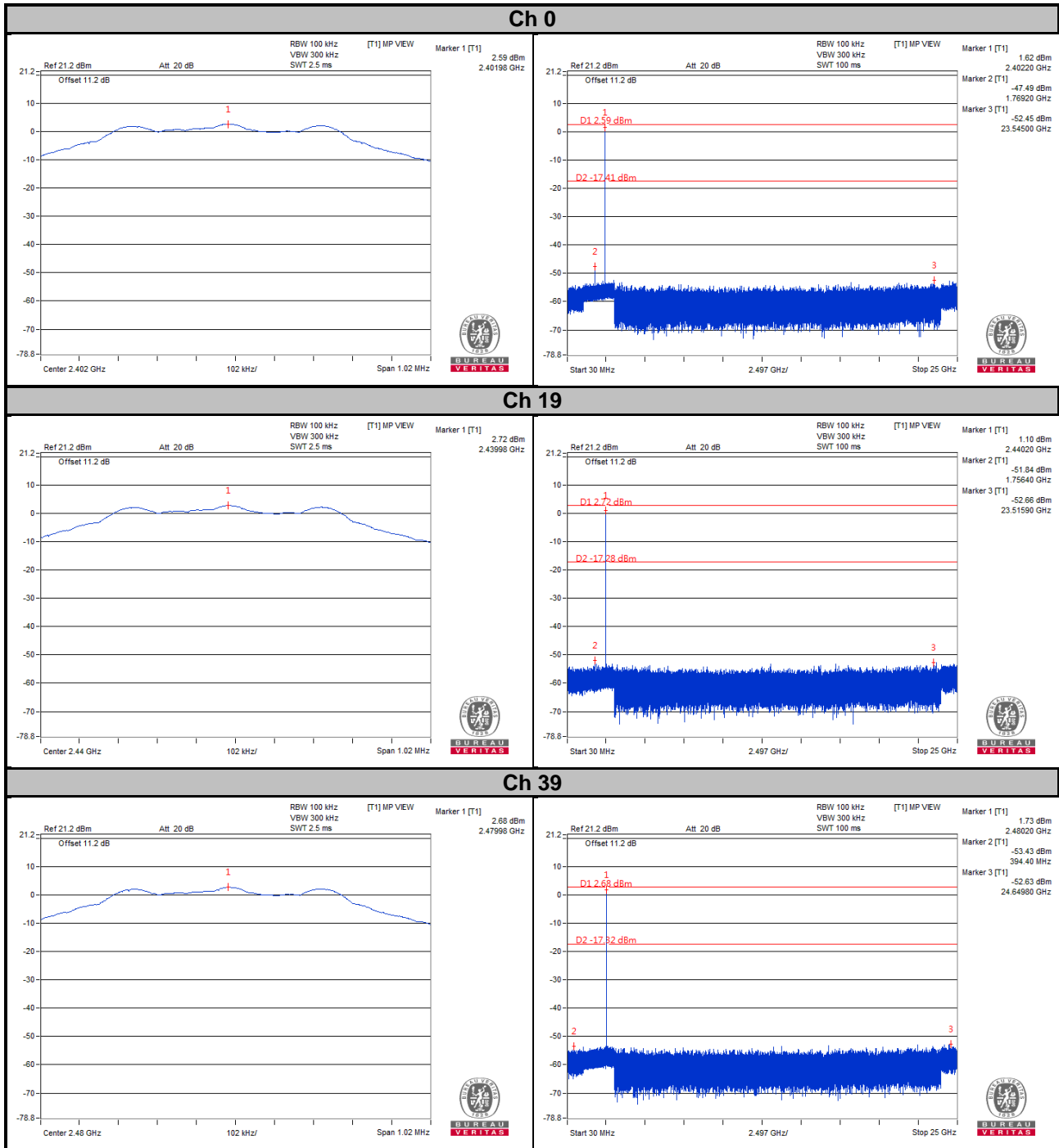

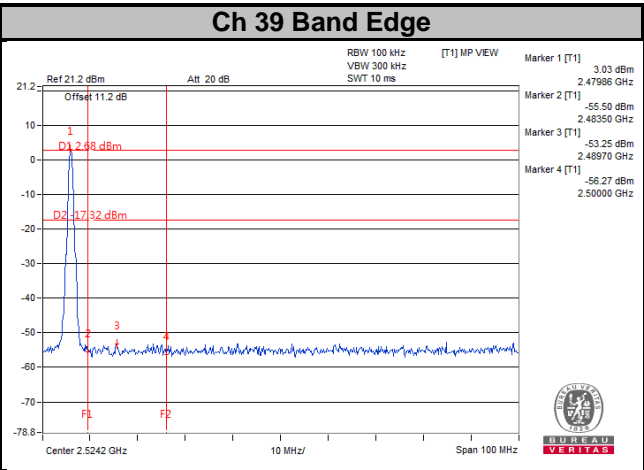
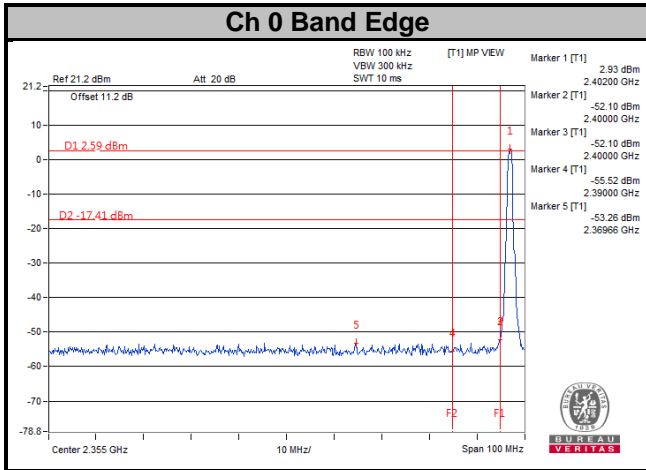

5 Pictures of Test Arrangements

Please refer to the attached file (Test Setup Photo).

Appendix – Information on the Testing Laboratories

We, Bureau Veritas Consumer Products Services (H.K.) Ltd., Taoyuan Branch, were founded in 1988 to provide our best service in EMC, Radio, Telecom and Safety consultation. Our laboratories are accredited and approved according to ISO/IEC 17025.

If you have any comments, please feel free to contact us at the following:

Linko EMC/RF Lab

Tel: 886-2-26052180

Fax: 886-2-26051924

Hsin Chu EMC/RF/Telecom Lab

Tel: 886-3-6668565

Fax: 886-3-6668323

Hwa Ya EMC/RF/Safety

Tel: 886-3-3183232

Fax: 886-3-3270892

Email: service.adt@tw.bureauveritas.com

Web Site: www.bureauveritas-adt.com

The address and road map of all our labs can be found in our web site also.

--- END ---