

FCC Test Report

Report No.: RF170407C07A-2

FCC ID: UK7-DW3A

Test Model: DW3A, DW3B

Received Date: Apr. 07, 2017

Test Date: Jul. 19, 2017 ~ Jul. 27, 2017

Issued Date: Aug. 10, 2017

Applicant: Fossil Group, Inc.

Address: 901 S. Central Expressway, Richardson, TX 75080 USA

Issued By: Bureau Veritas Consumer Products Services (H.K.) Ltd., Taoyuan Branch

Lab Address: No. 47-2, 14th Ling, Chia Pau Vil., Lin Kou Dist., New Taipei City, Taiwan (R.O.C)

Test Location (1): No. 19, Hwa Ya 2nd Rd, Wen Hwa Tsuen, Kwei Shan Hsiang, Taoyuan Hsien 333, Taiwan, R.O.C.

Test Location (2): No.215, Sec. 3, Beixin Rd., Xindian Dist., New Taipei City 231, Taiwan, R.O.C



This report is for your exclusive use. Any copying or replication of this report to or for any other person or entity, or use of our name or trademark, is permitted only with our prior written permission. This report sets forth our findings solely with respect to the test samples identified herein. The results set forth in this report are not indicative or representative of the quality or characteristics of the lot from which a test sample was taken or any similar or identical product unless specifically and expressly noted. Our report includes all of the tests requested by you and the results thereof based upon the information that you provided to us. You have 60 days from date of issuance of this report to notify us of any material error or omission caused by our negligence, provided, however, that such notice shall be in writing and shall specifically address the issue you wish to raise. A failure to raise such issue within the prescribed time shall constitute your unqualified acceptance of the completeness of this report, the tests conducted and the correctness of the report contents. Unless specific mention, the uncertainty of measurement has been explicitly taken into account to declare the compliance or non-compliance to the specification.

Table of Contents

Release Control Record	4
1 Certificate of Conformity	5
2 Summary of Test Results	6
2.1 Measurement Uncertainty	6
2.2 Modification Record	6
3 General Information	7
3.1 General Description of EUT	7
3.2 Description of Test Modes	8
3.2.1 Test Mode Applicability and Tested Channel Detail	9
3.3 Duty Cycle of Test Signal	11
3.4 Description of Support Units	12
3.4.1 Configuration of System under Test	12
3.5 General Description of Applied Standards	12
4 Test Types and Results	13
4.1 Radiated Emission and Bandedge Measurement	13
4.1.1 Limits of Radiated Emission and Bandedge Measurement	13
4.1.2 Test Instruments	14
4.1.3 Test Procedures	15
4.1.4 Deviation from Test Standard	15
4.1.5 Test Set Up	16
4.1.6 EUT Operating Conditions	16
4.1.7 Test Results	17
4.2 Conducted Emission Measurement	81
4.2.1 Limits of Conducted Emission Measurement	81
4.2.2 Test Instruments	81
4.2.3 Test Procedures	82
4.2.4 Deviation from Test Standard	82
4.2.5 Test Setup	82
4.2.6 EUT Operating Conditions	82
4.2.7 Test Results	83
4.3 6 dB Bandwidth Measurement	87
4.3.1 Limits of 6 dB Bandwidth Measurement	87
4.3.2 Test Setup	87
4.3.3 Test Instruments	87
4.3.4 Test Procedure	87
4.3.5 Deviation from Test Standard	87
4.3.6 EUT Operating Conditions	87
4.3.7 Test Result	88
4.4 Conducted Output Power Measurement	90
4.4.1 Limits of Conducted Output Power Measurement	90
4.4.2 Test Setup	90
4.4.3 Test Instruments	90
4.4.4 Test Procedures	90
4.4.5 Deviation from Test Standard	90
4.4.6 EUT Operating Conditions	90
4.4.7 Test Results	91
4.5 Power Spectral Density Measurement	92
4.5.1 Limits of Power Spectral Density Measurement	92
4.5.2 Test Setup	92
4.5.3 Test Instruments	92
4.5.4 Test Procedure	92
4.5.5 Deviation from Test Standard	92
4.5.6 EUT Operating Condition	92

4.5.7 Test Results	93
4.6 Conducted Out of Band Emission Measurement	95
4.6.1 Limits of Conducted Out of Band Emission Measurement.....	95
4.6.2 Test Setup.....	95
4.6.3 Test Instruments	95
4.6.4 Test Procedure	95
4.6.5 Deviation from Test Standard	95
4.6.6 EUT Operating Condition	95
4.6.7 Test Results	96
5 Pictures of Test Arrangements.....	102
Appendix – Information on the Testing Laboratories	103

Release Control Record

Issue No.	Description	Date Issued
RF170407C07A-2	Original Release	Aug. 10, 2017

1 Certificate of Conformity

Product: Smart Watch
Brand: MISFIT, FOSSIL
Test Model: DW3A, DW3B
Sample Status: Identical Prototype
Applicant: Fossil Group, Inc.
Test Date: Jul. 19, 2017 ~ Jul. 27, 2017
Standards: 47 CFR FCC Part 15, Subpart C (Section 15.247)
ANSI C63.10:2013

The above equipment has been tested by **Bureau Veritas Consumer Products Services (H.K.) Ltd., Taoyuan Branch**, and found compliance with the requirement of the above standards. The test record, data evaluation & Equipment Under Test (EUT) configurations represented herein are true and accurate accounts of the measurements of the sample's EMC characteristics under the conditions specified in this report.

Prepared by : Gina Liu , **Date:** Aug. 10, 2017
Gina Liu / Specialist

Approved by : David Huang , **Date:** Aug. 10, 2017
David Huang / Project Engineer

2 Summary of Test Results

47 CFR FCC Part 15, Subpart C (Section 15.247)			
FCC Clause	Test Item	Result	Remarks
15.207	AC Power Conducted Emission	Pass	Meet the requirement of limit. Minimum passing margin is -16.53 dB at 0.58792 MHz.
15.205 / 15.209 / 15.247(d)	Radiated Emissions and Band Edge Measurement	Pass	Meet the requirement of limit. Minimum passing margin is -3.06 dB at 79.41 MHz.
15.247(d)	Antenna Port Emission	Pass	Meet the requirement of limit.
15.247(a)(2)	6 dB Bandwidth	Pass	Meet the requirement of limit.
15.247(b)	Conducted power	Pass	Meet the requirement of limit.
15.247(e)	Power Spectral Density	Pass	Meet the requirement of limit.
15.203	Antenna Requirement	Pass	No antenna connector is used.

2.1 Measurement Uncertainty

Where relevant, the following measurement uncertainty levels have been estimated for tests performed on the EUT:

The listed uncertainties are the worst case uncertainty for the entire range of measurement. Please note that the uncertainty values are provided for informational purposes only and are not used in determining the PASS/FAIL results.

Measurement	Frequency	Expanded Uncertainty (k=2) (\pm)
Conducted Emissions at mains ports	150 kHz ~ 30 MHz	2.44 dB
Radiated Emissions up to 1 GHz	30 MHz ~ 200 MHz	2.0153 dB
	200 MHz ~ 1000 MHz	2.0224 dB
Radiated Emissions above 1 GHz	1 GHz ~ 18 GHz	1.0121 dB
	18 GHz ~ 40 GHz	1.1508 dB

2.2 Modification Record

There were no modifications required for compliance.

3 General Information

3.1 General Description of EUT

Product	Smart Watch
Brand	MISFIT, FOSSIL
Test Model	DW3A, DW3B
Status of EUT	Identical Prototype
Power Supply Rating	3.8 Vdc (Battery) 5 Vdc (Host equipment)
Modulation Type	CCK, DQPSK, DBPSK for DSSS 64QAM, 16QAM, QPSK, BPSK for OFDM
Modulation Technology	DSSS, OFDM
Transfer Rate	802.11b: 11.0 / 5.5 / 2.0 / 1.0 Mbps 802.11g: 54.0 / 48.0 / 36.0 / 24.0 / 18.0 / 12.0 / 9.0 / 6.0 Mbps 802.11n: up to MCS7
Operating Frequency	2412 ~ 2462 MHz
Number of Channel	11 for 802.11b, 802.11g, 802.11n (HT20)
Output Power	116.681 mW
Antenna Type	PCB antenna with -6.65 dBi gain (DW3A) PCB antenna with -6.92 dBi gain (DW3B)
Antenna Connector	N/A
Accessory Device	Refer to Note as below
Data Cable Supplied	Refer to Note as below

Note:

- There're 2 configurations for the EUT listed as below.

Sample	Brand	Model	Difference
A	MISFIT	DW3A	The models are different in the appearance and antenna gain.
B	FOSSIL	DW3B	

- The EUT provides one completed transmitter and one receiver.

Modulation Mode	TX Function
802.11b	1TX
802.11g	1TX
802.11n (HT20)	1TX

- The EUT contains following accessory devices.

Product	Brand	Model	Description
LCD Panel	BOE	WB014ZNM-N00-6D00	1.39"
Battery	GREPOW	ABI403530	3.8 Vdc, 360 mAh
Charger Cable	NA	NA	0.9m non-shielded cable w/o core
eMMC	N/A	N/A	4G

- The above EUT information is declared by manufacturer and for more detailed features description, please refer to the manufacturer's specifications or user's manual.

3.2 Description of Test Modes

11 channels are provided for 802.11b, 802.11g and 802.11n (HT20):

Channel	Frequency (MHz)	Channel	Frequency (MHz)
1	2412	7	2442
2	2417	8	2447
3	2422	9	2452
4	2427	10	2457
5	2432	11	2462
6	2437		

3.2.1 Test Mode Applicability and Tested Channel Detail

EUT Configure Mode	Applicable To				Description
	RE \geq 1G	RE<1G	PLC	APCM	
A	√	√	√	√	Sample A
B	√	√	√	-	Sample B

Where **RE \geq 1G**: Radiated Emission above 1 GHz **RE<1G**: Radiated Emission below 1 GHz
PLC: Power Line Conducted Emission **APCM**: Antenna Port Conducted Measurement

NOTE: The EUT had been pre-tested on the positioned of each 3 axis. The worst case was found when positioned on **Y-plane**.
NOTE: "-" means no effect.

Radiated Emission Test (Above 1 GHz):

- Pre-Scan has been conducted to determine the worst-case mode from all possible combinations between available modulations, data rates and antenna ports (if EUT with antenna diversity architecture).
- Following channel(s) was (were) selected for the final test as listed below.

EUT Configure Mode	Mode	Available Channel	Tested Channel	Modulation Technology	Modulation Type	Data Rate (Mbps)
A, B	802.11b	1 to 11	1, 6, 11	DSSS	DBPSK	1.0
	802.11g	1 to 11	1, 6, 11	OFDM	BPSK	6.0
	802.11n (HT20)	1 to 11	1, 6, 11	OFDM	BPSK	MCS0

Radiated Emission Test (Below 1 GHz):

- Pre-Scan has been conducted to determine the worst-case mode from all possible combinations between available modulations, data rates and antenna ports (if EUT with antenna diversity architecture).
- Following channel(s) was (were) selected for the final test as listed below.

EUT Configure Mode	Mode	Available Channel	Tested Channel	Modulation Technology	Modulation Type	Data Rate (Mbps)
A	802.11g	1 to 11	6	OFDM	BPSK	6.0
B	802.11g	1 to 11	11	OFDM	BPSK	6.0

Power Line Conducted Emission Test:

- Pre-Scan has been conducted to determine the worst-case mode from all possible combinations between available modulations, data rates and antenna ports (if EUT with antenna diversity architecture).
- Following channel(s) was (were) selected for the final test as listed below.

EUT Configure Mode	Mode	Available Channel	Tested Channel	Modulation Technology	Modulation Type	Data Rate (Mbps)
A	802.11g	1 to 11	6	OFDM	BPSK	6.0
B	802.11g	1 to 11	11	OFDM	BPSK	6.0

Bandedge Measurement:

- Pre-Scan has been conducted to determine the worst-case mode from all possible combinations between available modulations, data rates and antenna ports (if EUT with antenna diversity architecture).
- Following channel(s) was (were) selected for the final test as listed below.

EUT Configure Mode	Mode	Available Channel	Tested Channel	Modulation Technology	Modulation Type	Data Rate (Mbps)
A	802.11b	1 to 11	1, 11	DSSS	DBPSK	1.0
	802.11g	1 to 11	1, 11	OFDM	BPSK	6.0
	802.11n (HT20)	1 to 11	1, 11	OFDM	BPSK	MCS0

Antenna Port Conducted Measurement:

- This item includes all test value of each mode, but only includes spectrum plot of worst value of each mode.
- Pre-Scan has been conducted to determine the worst-case mode from all possible combinations between available modulations, data rates and antenna ports (if EUT with antenna diversity architecture).
- Following channel(s) was (were) selected for the final test as listed below.

EUT Configure Mode	Mode	Available Channel	Tested Channel	Modulation Technology	Modulation Type	Data Rate (Mbps)
A	802.11b	1 to 11	1, 6, 11	DSSS	DBPSK	1.0
	802.11g	1 to 11	1, 6, 11	OFDM	BPSK	6.0
	802.11n (HT20)	1 to 11	1, 6, 11	OFDM	BPSK	MCS0

Test Condition:

Applicable To	Environmental Conditions	Input Power	Tested by
RE \geq 1G	25 deg. C, 65 % RH	120 Vac, 60 Hz	Karl Lee
RE<1G	25 deg. C, 65 % RH	120 Vac, 60 Hz	Charles Hsiao
PLC	25 deg. C, 65 % RH	120 Vac, 60 Hz	Getaz Yang
APCM	25 deg. C, 65 % RH	3.8 Vdc	Luke Chen

3.3 Duty Cycle of Test Signal

802.11b: Duty cycle of test signal is 100 %

802.11g: Duty cycle of test signal is > 98 %

802.11n (HT20): Duty cycle = $1.275/1.303 = 0.979$, Duty factor = $10 * \log(1/0.979) = 0.09$

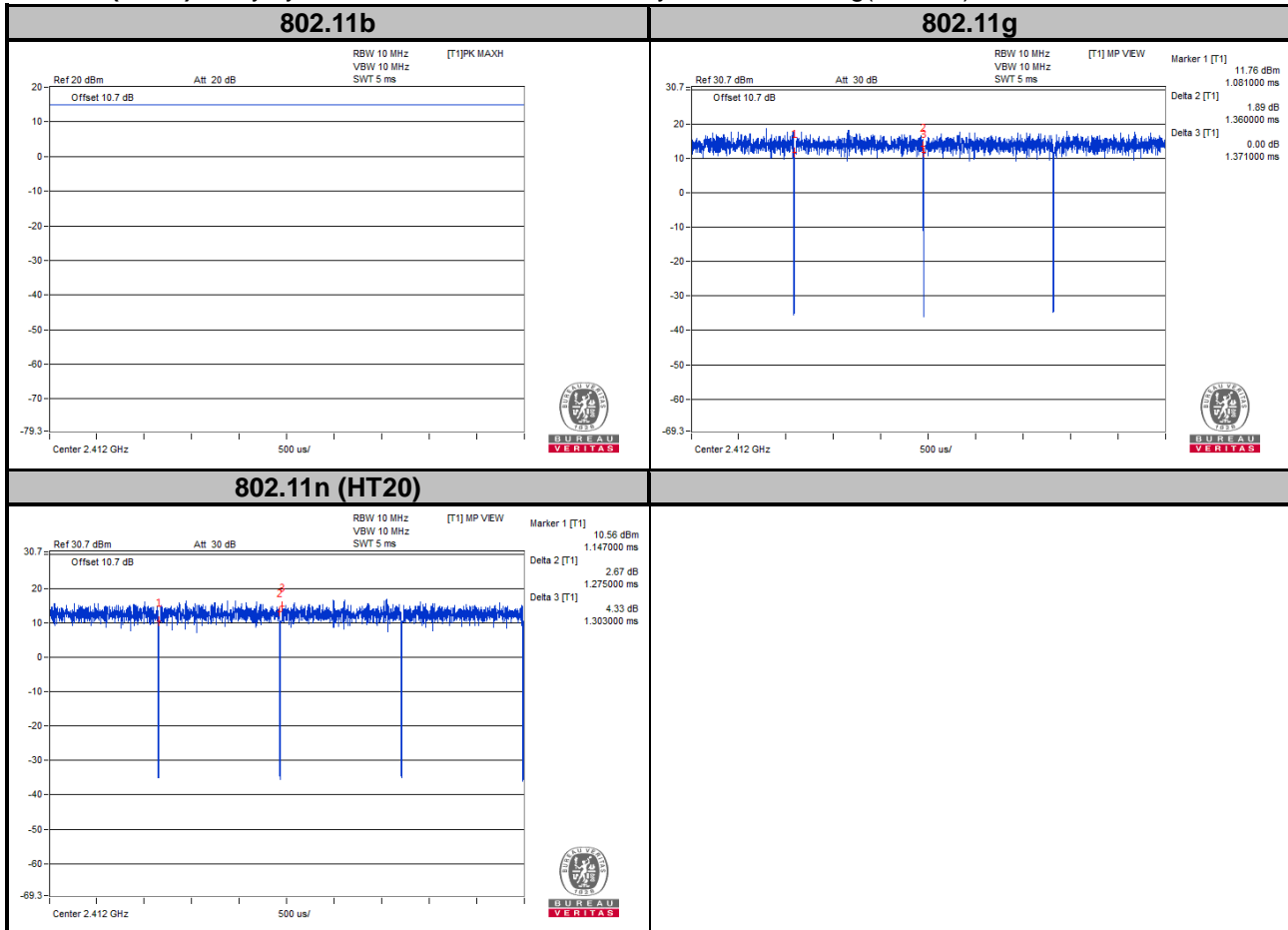

3.4 Description of Support Units

The EUT has been tested as an independent unit together with other necessary accessories or support units.

3.4.1 Configuration of System under Test

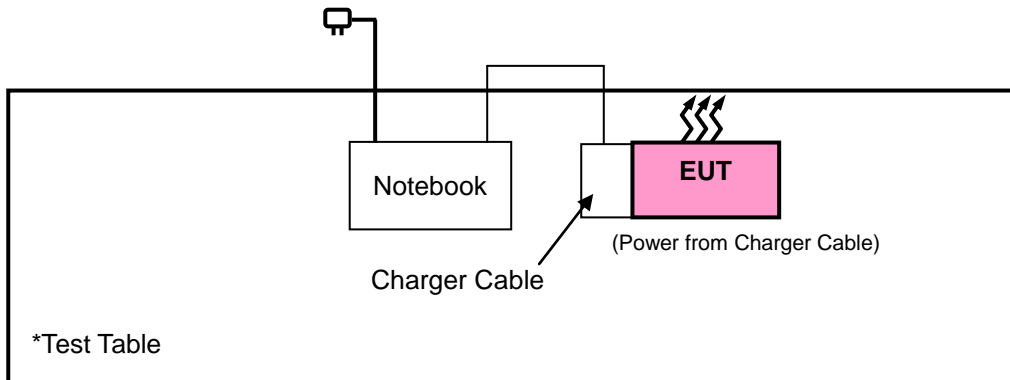

3.5 General Description of Applied Standards

The EUT is a RF Product. According to the specifications of the manufacturer, it must comply with the requirements of the following standards:

FCC Part 15, Subpart C (15.247)

558074 D01 DTS Meas Guidance v04

ANSI C63.10-2013

All test items have been performed and recorded as per the above standards.

4 Test Types and Results

4.1 Radiated Emission and Bandedge Measurement

4.1.1 Limits of Radiated Emission and Bandedge Measurement

Radiated emissions which fall in the restricted bands must comply with the radiated emission limits specified as below table. Other emissions shall be at least 20 dB below the highest level of the desired power:

Frequencies (MHz)	Field Strength (microvolts/meter)	Measurement Distance (meters)
0.009 ~ 0.490	2400/F (kHz)	300
0.490 ~ 1.705	24000/F (kHz)	30
1.705 ~ 30.0	30	30
30 ~ 88	100	3
88 ~ 216	150	3
216 ~ 960	200	3
Above 960	500	3

NOTE:

1. The lower limit shall apply at the transition frequencies.
2. Emission level (dBuV/m) = 20 log Emission level (uV/m).
3. For frequencies above 1000 MHz, the field strength limits are based on average detector, however, the peak field strength of any emission shall not exceed the maximum permitted average limits, specified above by more than 20 dB under any condition of modulation.

4.1.2 Test Instruments

Description & Manufacturer	Model No.	Serial No.	Date of Calibration	Due Date of Calibration
Test Receiver Agilent Technologies	N9038A	MY52260177	Jul. 05, 2017	Jul. 04, 2018
Spectrum Analyzer ROHDE & SCHWARZ	F5U43	101261	Dec. 13, 2016	Dec. 12, 2017
BILOG Antenna SCHWARZBECK	VULB9168	9168-472	Dec. 16, 2016	Dec. 15, 2017
HORN Antenna ETS-Lindgren	3117	00143293	Dec. 29, 2016	Dec. 28, 2017
HORN Antenna SCHWARZBECK	BBHA 9170	9170-480	Dec. 14, 2016	Dec. 13, 2017
Bluetooth Tester	CBT	100980	Jun. 28, 2017	Apr. 27, 2018
Loop Antenna	EM-6879	269	Aug. 11, 2016	Aug. 10, 2017
Preamplifier Agilent	310N	187226	Jun. 23, 2017	Jun. 22, 2018
Preamplifier Agilent	83017A	MY39501357	Jun. 23, 2017	Jun. 22, 2018
Power Meter Anritsu	ML2495A	1232002	Sep. 08, 2016	Sep. 07, 2017
Power Sensor Anritsu	MA2411B	1207325	Sep. 08, 2016	Sep. 07, 2017
RF signal cable ETS-LINDGREN	5D-FB	Cable-CH1-01(R FC-SMS-100-SM S-120+RFC-SMS -100-SMS-400)	Jun. 24, 2017	Jun. 23, 2018
RF signal cable ETS-LINDGREN	8D-FB	Cable-CH1-02(R FC-SMS-100-SM S-24)	Jun. 24, 2017	Jun. 23, 2018
Software BV ADT	E3 8.130425b	NA	NA	NA
Antenna Tower MF	NA	NA	NA	NA
Turn Table MF	NA	NA	NA	NA
Antenna Tower & Turn Table Controller MF	MF-7802	NA	NA	NA

- Note: 1. The calibration interval of the above test instruments is 12 months and the calibrations are traceable to NML/ROC and NIST/USA.
2. The test was performed in HsinTien Chamber 1.
3. The horn antenna and preamplifier (model: 83017A) are used only for the measurement of emission frequency above 1 GHz if tested.
4. The FCC Designation Number is TW0003. The number will be varied with the Lab location and scope as attached.
5. The IC Site Registration No. is IC7450I-1.

4.1.3 Test Procedures

- a. The EUT was placed on the top of a rotating table 0.8 meters (for below 1 GHz) / 1.5 meters (for above 1 GHz) above the ground at 3 meter chamber room for test. The table was rotated 360 degrees to determine the position of the highest radiation.
- b. The EUT was set 3 meters away from the interference-receiving antenna, which was mounted on the top of a variable-height antenna tower.
- c. The height of antenna is varied from one meter to four meters above the ground to determine the maximum value of the field strength. Both horizontal and vertical polarizations of the antenna are set to make the measurement.
- d. For each suspected emission, the EUT was arranged to its worst case and then the antenna was tuned to heights from 1 meter to 4 meters and the rotatable table was turned from 0 degrees to 360 degrees to find the maximum reading.
- e. The test-receiver system was set to quasi-peak detect function and specified bandwidth with maximum hold mode when the test frequency is below 1 GHz.
- f. The test-receiver system was set to peak and average detected function and specified bandwidth with maximum hold mode when the test frequency is above 1 GHz. If the peak reading value also meets average limit, measurement with the average detector is unnecessary.

Note:

1. The resolution bandwidth and video bandwidth of test receiver/spectrum analyzer is 120 kHz & 360 KHz for Quasi-peak detection (QP) at frequency below 1 GHz.
2. The resolution bandwidth of test receiver/spectrum analyzer is 1 MHz and the video bandwidth is 3 MHz for Peak detection (PK) at frequency above 1 GHz.
3. The resolution bandwidth of test receiver/spectrum analyzer is 1 MHz and the video bandwidth is 1/T for Average (Duty cycle < 98 %) detection at frequency above 1 GHz.
4. The resolution bandwidth of test receiver/spectrum analyzer is 1 MHz and the video bandwidth is 10 Hz (Duty cycle \geq 98 %) for Average detection (AV) at frequency above 1 GHz.
5. All modes of operation were investigated and the worst-case emissions are reported.

4.1.4 Deviation from Test Standard

No deviation.

4.1.5 Test Set Up

<Frequency Range below 1 GHz>

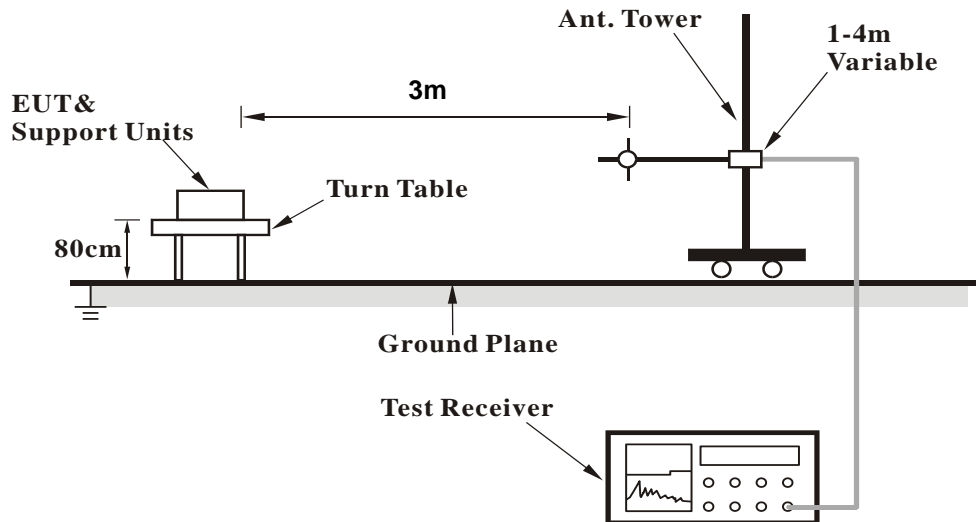

<Frequency Range above 1 GHz>

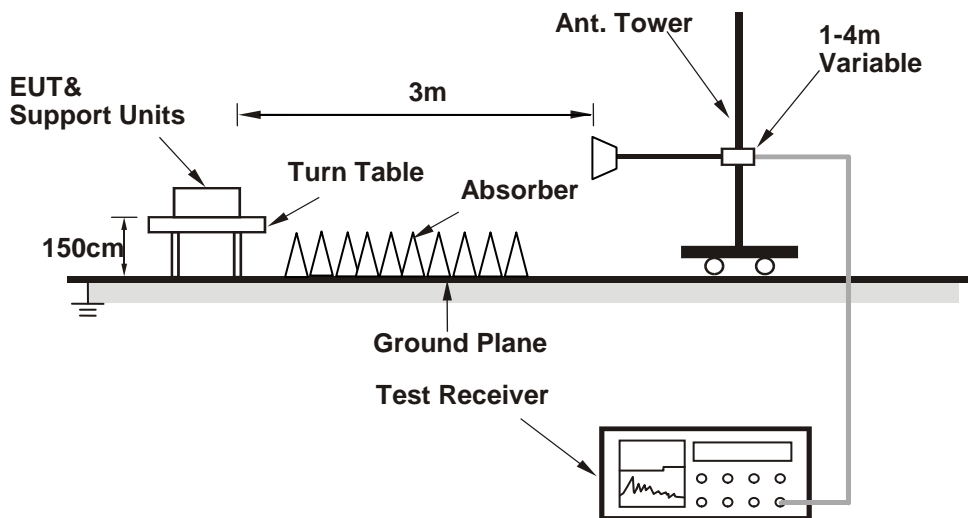

For the actual test configuration, please refer to the attached file (Test Setup Photo).

4.1.6 EUT Operating Conditions

- Placed the EUT on a testing table.
- Use the software to control the EUT under transmission condition continuously at specific channel frequency.

4.1.7 Test Results

Above 1 GHz Data :

Mode A

802.11b

EUT Test Condition		Measurement Detail	
Channel	Channel 1	Frequency Range	1 GHz ~ 25 GHz
Input Power	120 Vac, 60 Hz	Detector Function	Peak (PK) Average (AV)
Environmental Conditions	25 deg. C, 65 % RH	Tested By	Karl Lee

Horizontal

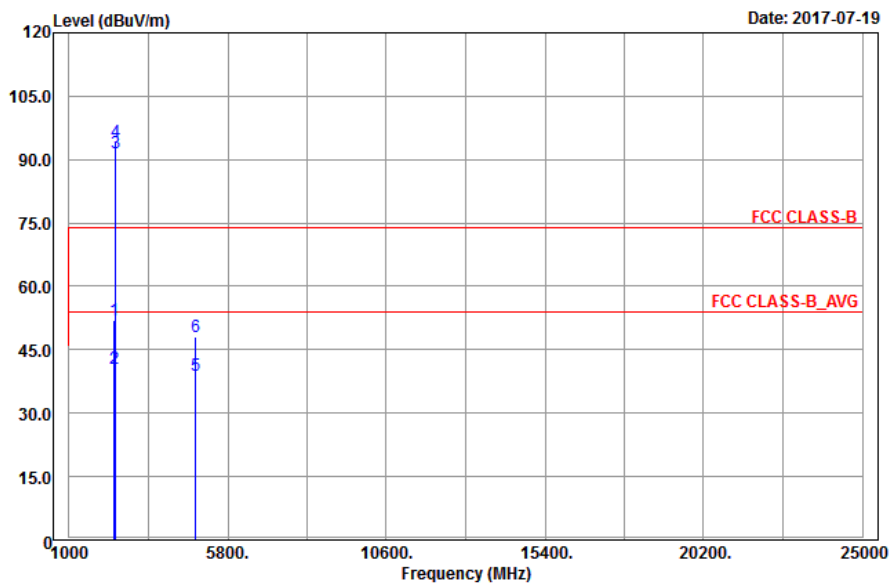

Vertical

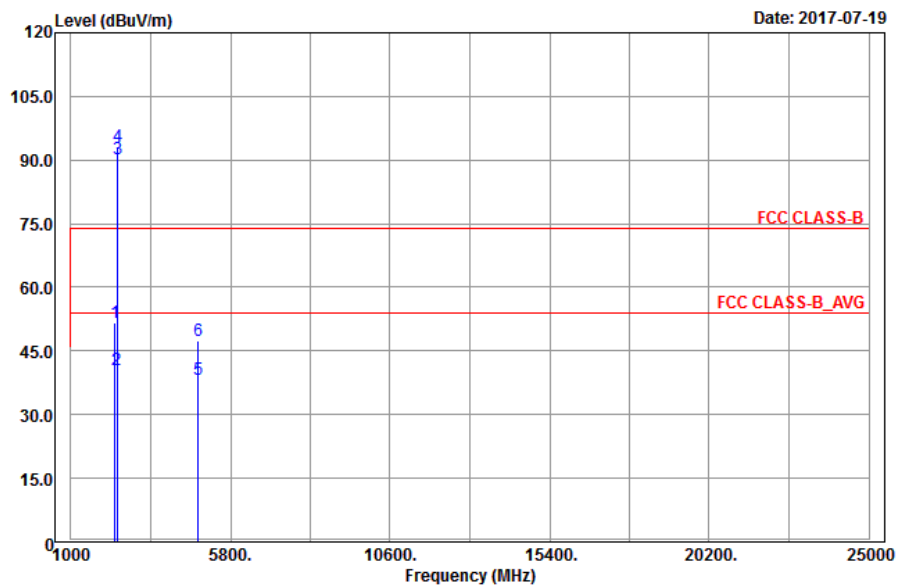

**Band Edge
Peak
Horizontal**

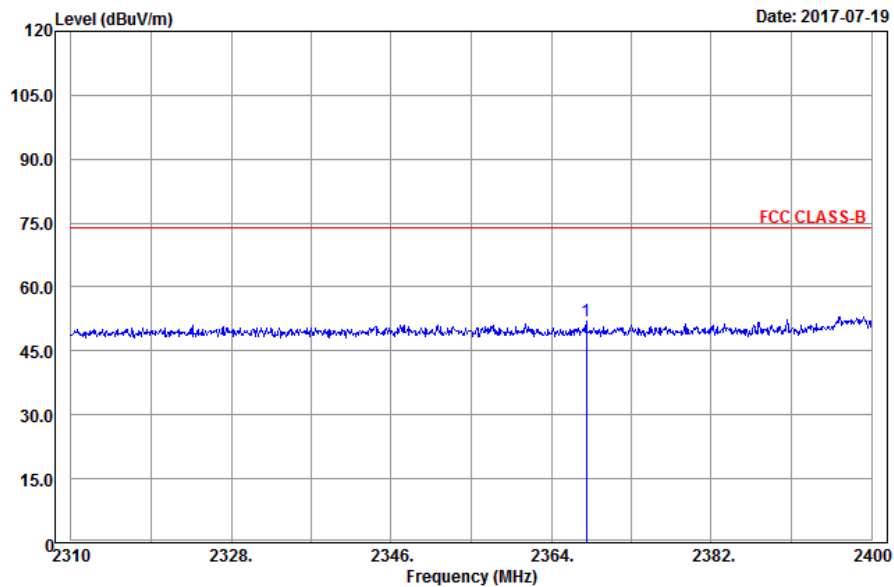

Vertical

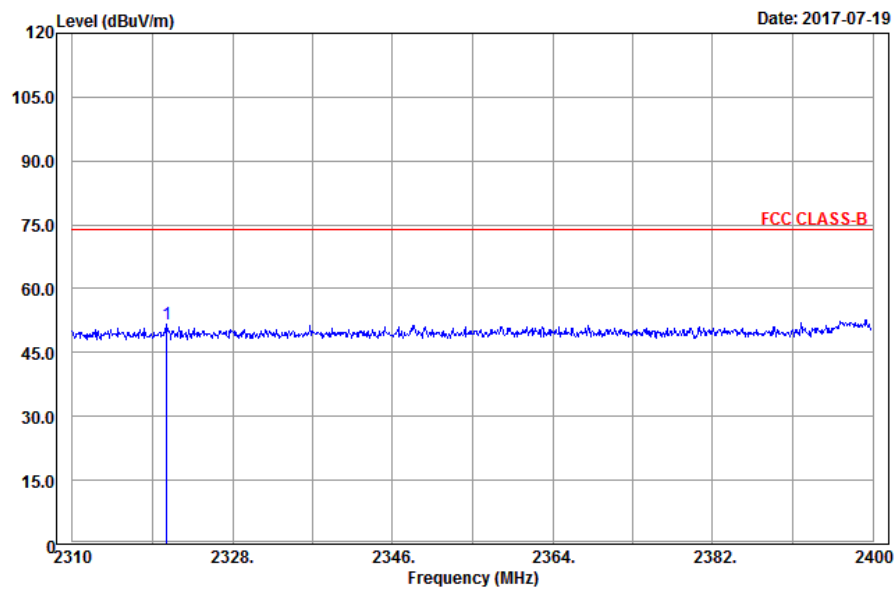

Average Horizontal

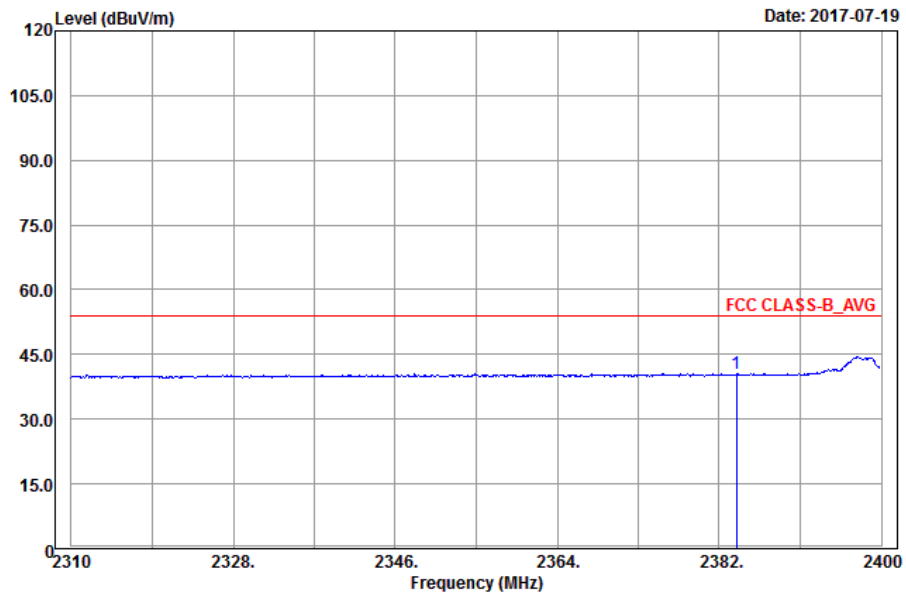

Vertical

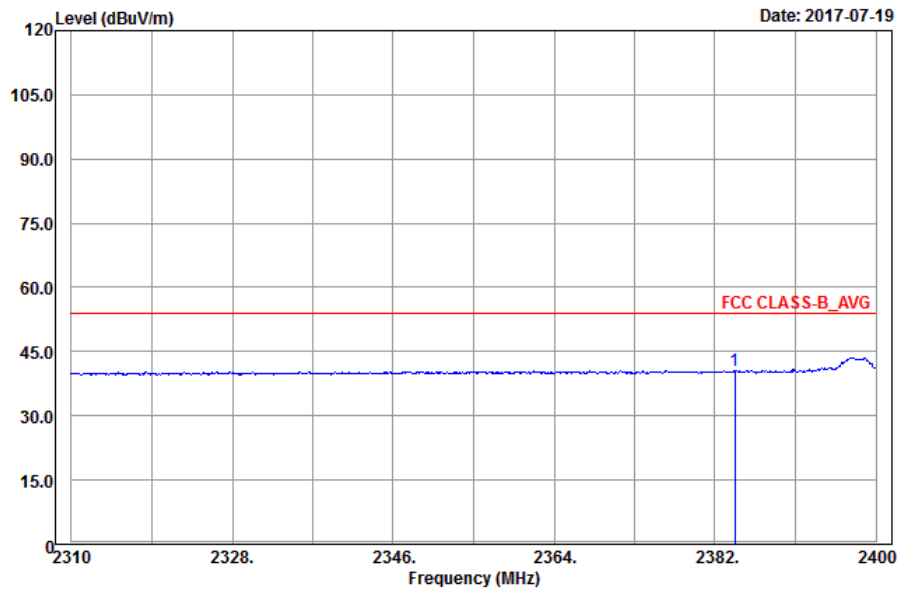

Antennal Polarity & Test Distance: Horizontal at 3 m

Frequency (MHz)	Emission Level (dBuV/m)	Read Level (dBuV)	Limit (dBuV/m)	Margin (dB)	Antenna Factor (dB/m)	Cable Loss (dB)	Preamp Factor (dB)	Antenna Height (cm)	Table Angle (Degree)	Remark
2367.96	52.08	50.44	74	-21.92	31.76	5.37	35.49	108	215	Peak
2383.89	40.54	38.85	54	-13.46	31.78	5.4	35.49	108	215	Average
2412	91.51	89.74			31.81	5.43	35.47	108	215	Average
2412	94.21	92.44			31.81	5.43	35.47	108	215	Peak
4824	38.76	30.63	54	-15.24	33.97	8.26	34.1	121	304	Average
4824	48.01	39.88	74	-25.99	33.97	8.26	34.1	121	304	Peak

Antennal Polarity & Test Distance: Vertical at 3 m

Frequency (MHz)	Emission Level (dBuV/m)	Read Level (dBuV)	Limit (dBuV/m)	Margin (dB)	Antenna Factor (dB/m)	Cable Loss (dB)	Preamp Factor (dB)	Antenna Height (cm)	Table Angle (Degree)	Remark
2320.62	51.65	50.14	74	-22.35	31.73	5.3	35.52	132	14	Peak
2384.25	40.62	38.93	54	-13.38	31.78	5.4	35.49	132	14	Average
2412	90.13	88.36			31.81	5.43	35.47	132	14	Average
2412	93.15	91.38			31.81	5.43	35.47	132	14	Peak
4824	38.14	30.01	54	-15.86	33.97	8.26	34.1	174	135	Average
4824	47.29	39.16	74	-26.71	33.97	8.26	34.1	174	135	Peak

Remarks:

- Emission Level = Read Level + Antenna Factor + Cable Loss - Preamp Factor
Margin value = Emission level – Limit value
- 2412 MHz: Fundamental frequency.

EUT Test Condition		Measurement Detail	
Channel	Channel 6	Frequency Range	1 GHz ~ 25 GHz
Input Power	120 Vac, 60 Hz	Detector Function	Peak (PK) Average (AV)
Environmental Conditions	25 deg. C, 65 % RH	Tested By	Karl Lee

Horizontal

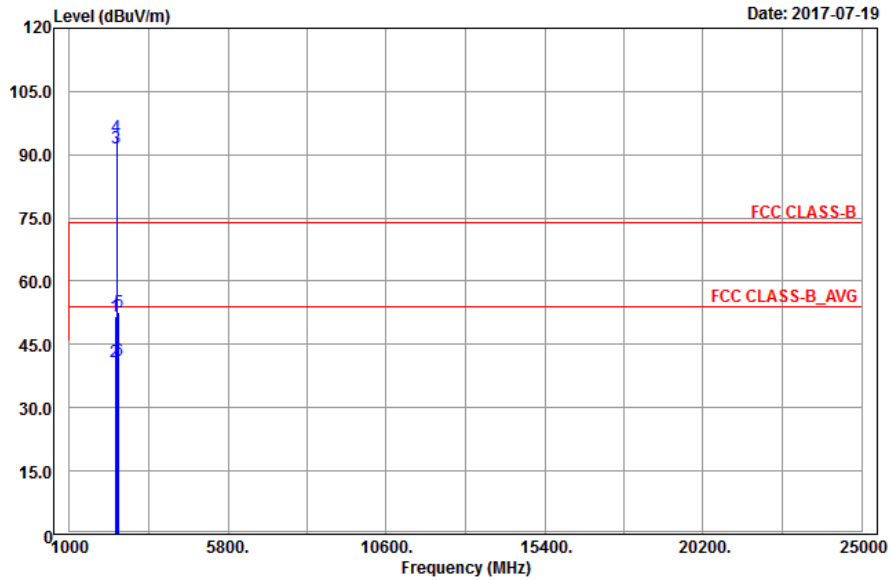

Vertical

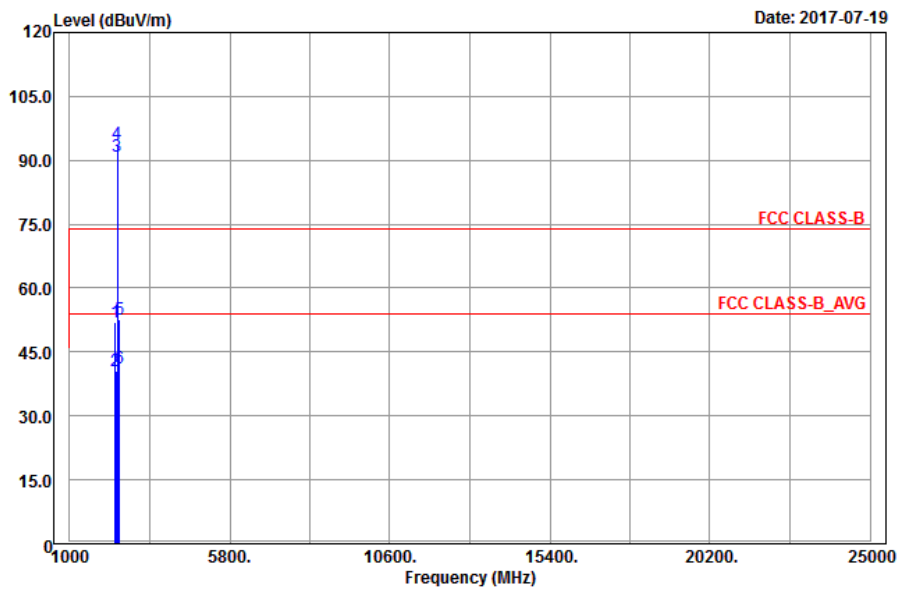

Antennal Polarity & Test Distance: Horizontal at 3 m										
Frequency (MHz)	Emission Level (dBuV/m)	Read Level (dBuV)	Limit (dBuV/m)	Margin (dB)	Antenna Factor (dB/m)	Cable Loss (dB)	Preamp Factor (dB)	Antenna Height (cm)	Table Angle (Degree)	Remark
2381.01	51.62	49.93	74	-22.38	31.78	5.4	35.49	108	215	Peak
2385.78	40.81	39.1	54	-13.19	31.8	5.4	35.49	108	215	Average
2437	91.63	89.78			31.85	5.46	35.46	108	215	Average
2437	94.32	92.47			31.85	5.46	35.46	108	215	Peak
2489.76	52.68	50.67	74	-21.32	31.9	5.53	35.42	108	215	Peak
2496.52	41.17	39.15	54	-12.83	31.9	5.53	35.41	108	215	Average
Antennal Polarity & Test Distance: Vertical at 3 m										
Frequency (MHz)	Emission Level (dBuV/m)	Read Level (dBuV)	Limit (dBuV/m)	Margin (dB)	Antenna Factor (dB/m)	Cable Loss (dB)	Preamp Factor (dB)	Antenna Height (cm)	Table Angle (Degree)	Remark
2370.48	52.07	50.41	74	-21.93	31.78	5.37	35.49	132	14	Peak
2384.43	40.54	38.85	54	-13.46	31.78	5.4	35.49	132	14	Average
2437	91.06	89.21			31.85	5.46	35.46	132	14	Average
2437	93.85	92			31.85	5.46	35.46	132	14	Peak
2488.28	52.58	50.57	74	-21.42	31.9	5.53	35.42	132	14	Peak
2489.88	41.07	39.06	54	-12.93	31.9	5.53	35.42	132	14	Average

Remarks:

- Emission Level = Read Level + Antenna Factor + Cable Loss - Preamp Factor
Margin value = Emission level – Limit value
- 2437 MHz: Fundamental frequency.

EUT Test Condition		Measurement Detail	
Channel	Channel 11	Frequency Range	1 GHz ~ 25 GHz
Input Power	120 Vac, 60 Hz	Detector Function	Peak (PK) Average (AV)
Environmental Conditions	25 deg. C, 65 % RH	Tested By	Karl Lee

Horizontal

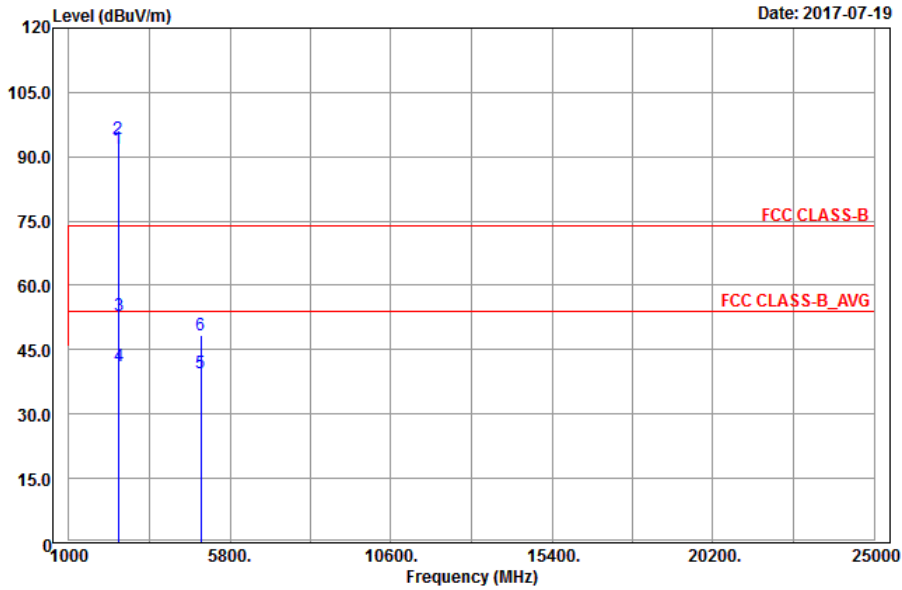

Vertical

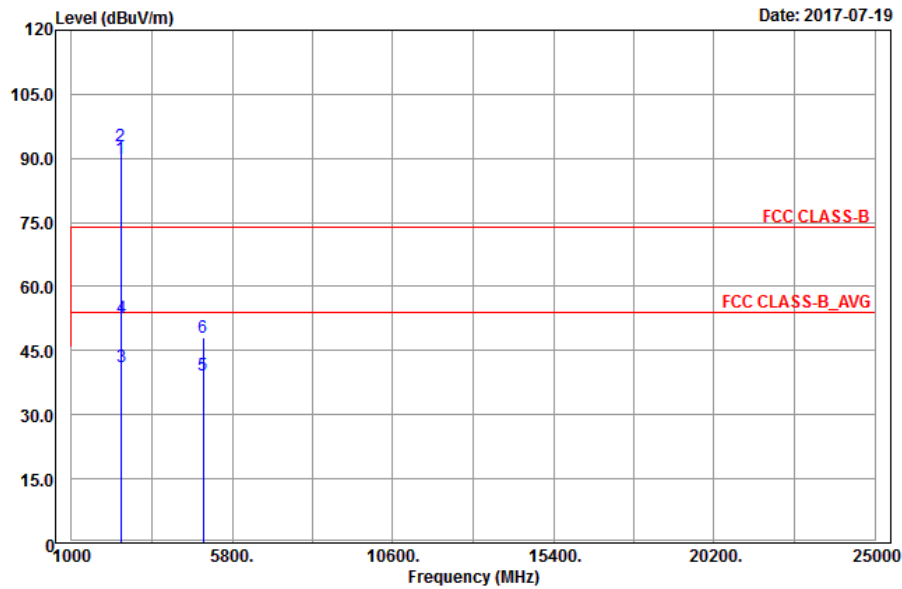

**Band Edge
Peak
Horizontal**

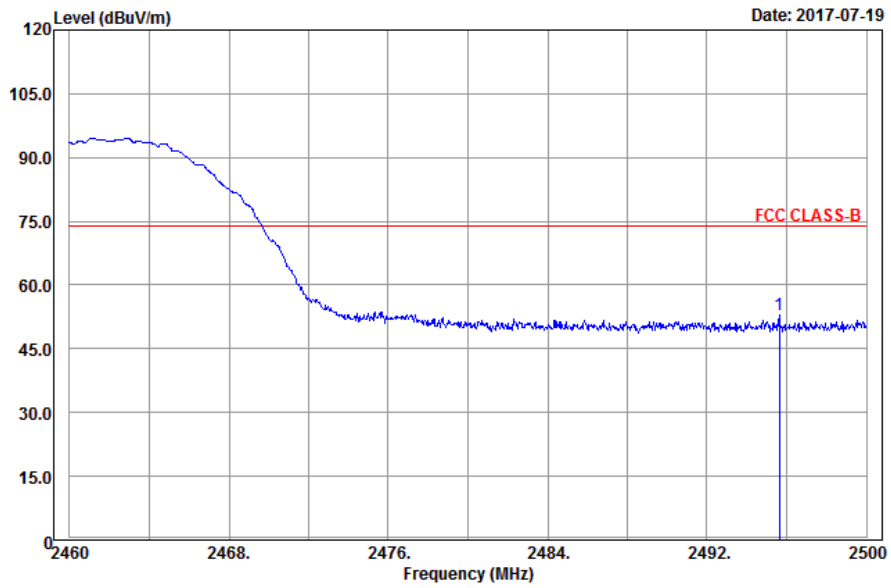

Vertical

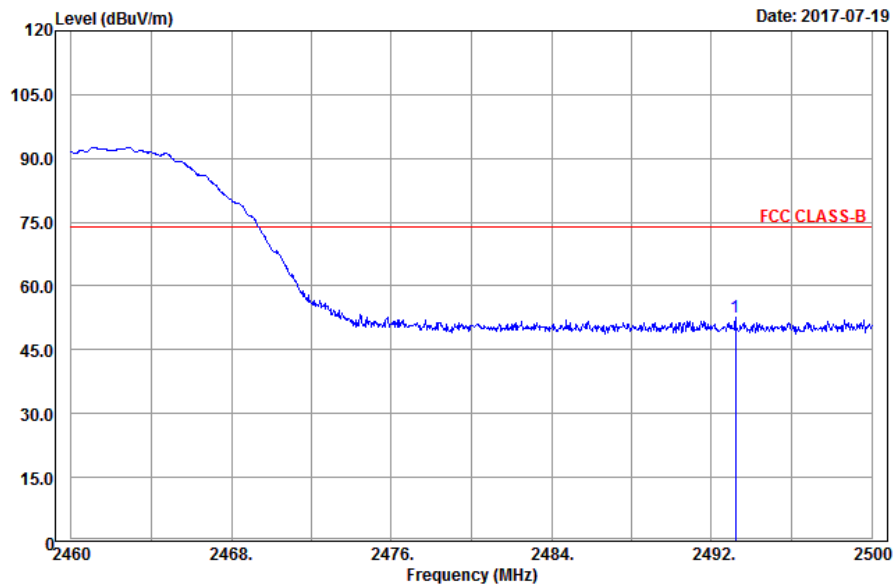

Average Horizontal

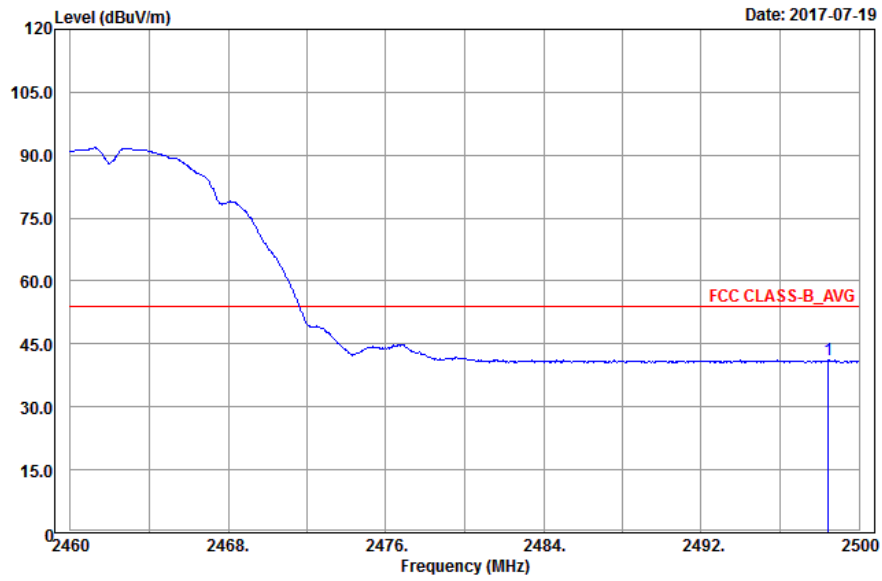

Vertical

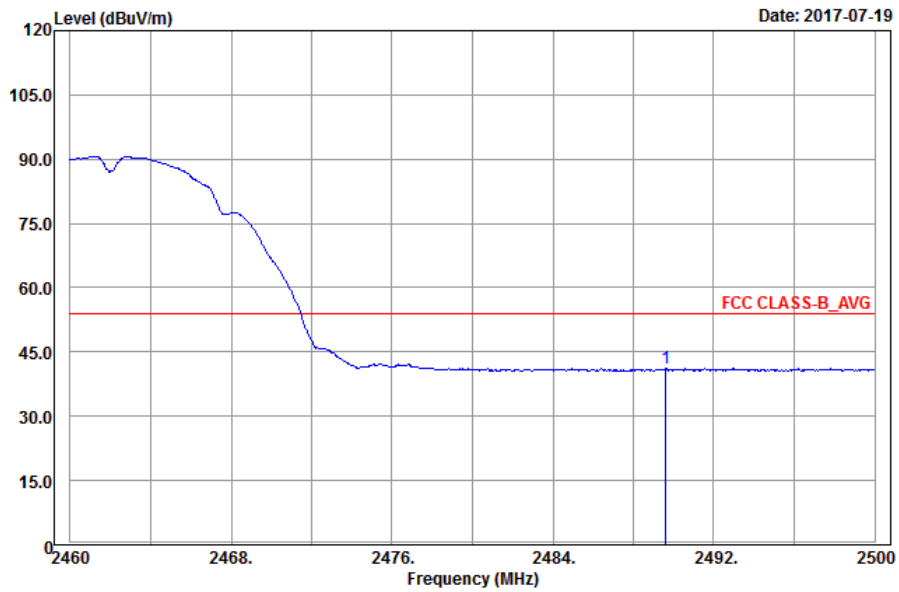

Antennal Polarity & Test Distance: Horizontal at 3 m

Frequency (MHz)	Emission Level (dBuV/m)	Read Level (dBuV)	Limit (dBuV/m)	Margin (dB)	Antenna Factor (dB/m)	Cable Loss (dB)	Preamp Factor (dB)	Antenna Height (cm)	Table Angle (Degree)	Remark
2462	91.78	89.85			31.87	5.5	35.44	108	215	Average
2462	94.29	92.36			31.87	5.5	35.44	108	215	Peak
2495.64	53.02	51	74	-20.98	31.9	5.53	35.41	108	215	Peak
2498.44	41.11	39.09	54	-12.89	31.9	5.53	35.41	108	215	Average
4924	39.42	31.17	54	-14.58	33.99	8.28	34.02	155	274	Average
4924	48.35	40.1	74	-25.65	33.99	8.28	34.02	155	274	Peak

Antennal Polarity & Test Distance: Vertical at 3 m

Frequency (MHz)	Emission Level (dBuV/m)	Read Level (dBuV)	Limit (dBuV/m)	Margin (dB)	Antenna Factor (dB/m)	Cable Loss (dB)	Preamp Factor (dB)	Antenna Height (cm)	Table Angle (Degree)	Remark
2462	90.08	88.15			31.87	5.5	35.44	131	14	Average
2462	92.92	90.99			31.87	5.5	35.44	131	14	Peak
2489.6	41.2	39.19	54	-12.8	31.9	5.53	35.42	132	14	Average
2493.2	52.57	50.55	74	-21.43	31.9	5.53	35.41	132	14	Peak
4924	39.16	30.91	54	-14.84	33.99	8.28	34.02	127	320	Average
4924	48.23	39.98	74	-25.77	33.99	8.28	34.02	127	320	Peak

Remarks:

- Emission Level = Read Level + Antenna Factor + Cable Loss - Preamp Factor
Margin value = Emission level – Limit value
- 2462 MHz: Fundamental frequency.

802.11g

EUT Test Condition		Measurement Detail	
Channel	Channel 1	Frequency Range	1 GHz ~ 25 GHz
Input Power	120 Vac, 60 Hz	Detector Function	Peak (PK) Average (AV)
Environmental Conditions	25 deg. C, 65 % RH	Tested By	Karl Lee

Horizontal

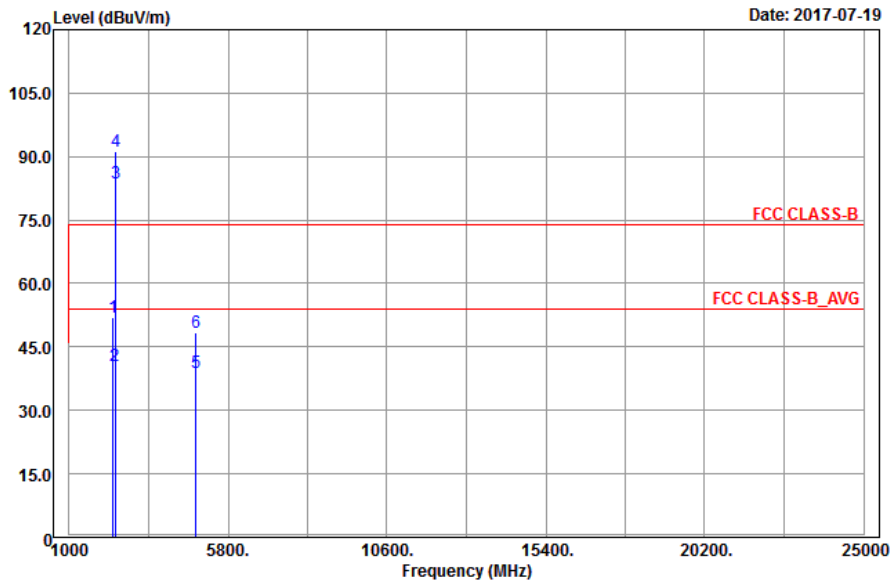

Vertical

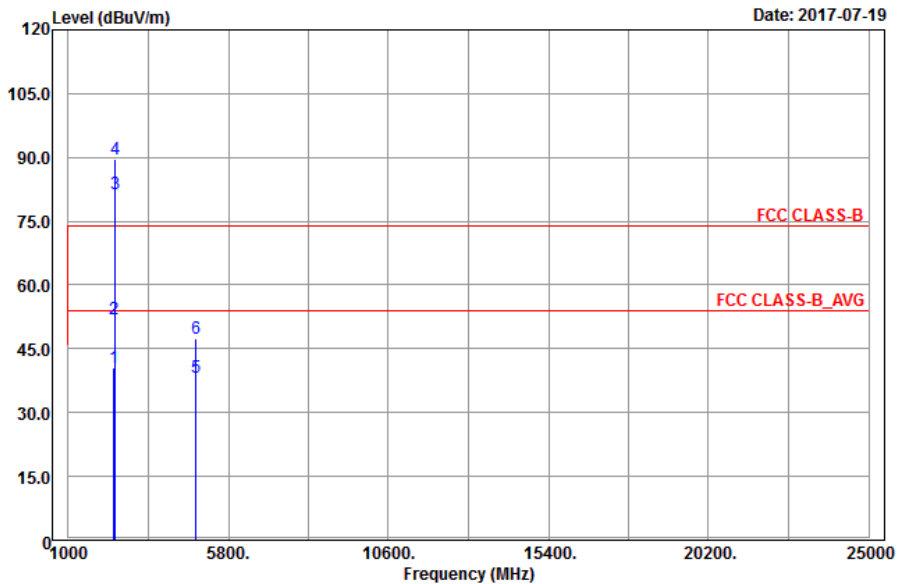

**Band Edge
Peak
Horizontal**

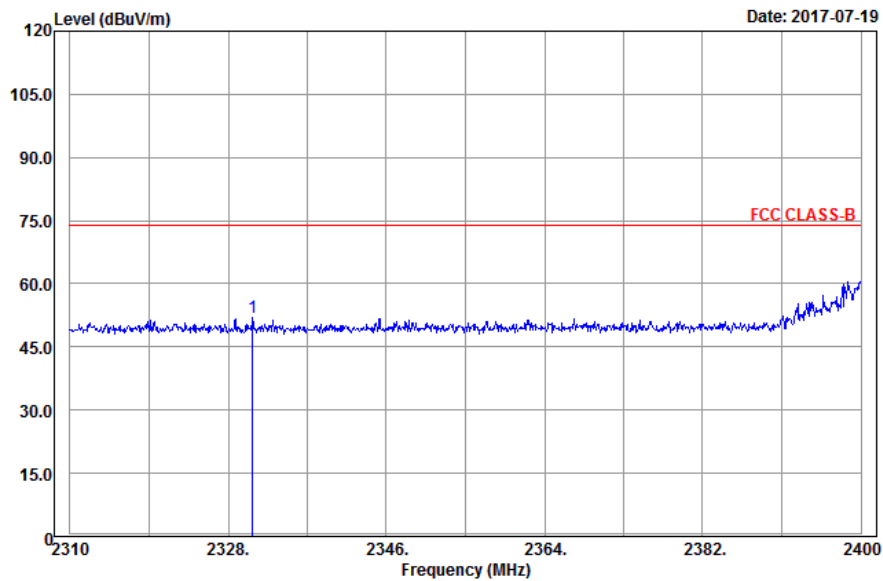

Vertical

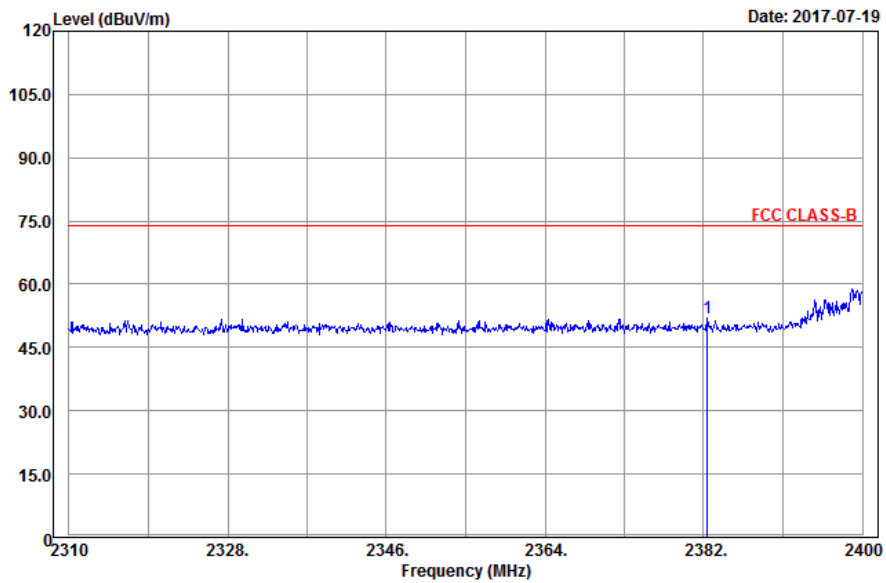

Average Horizontal

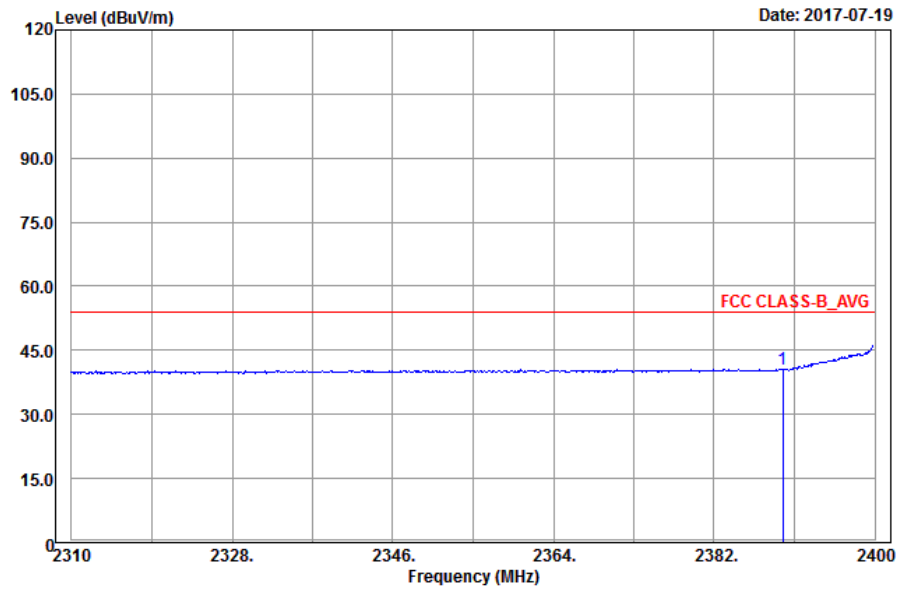

Vertical

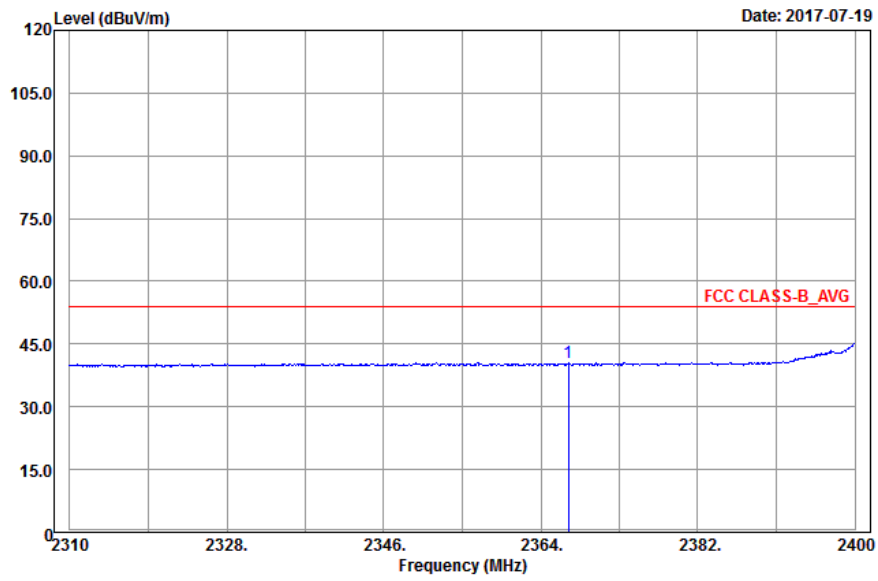

Antennal Polarity & Test Distance: Horizontal at 3 m										
Frequency (MHz)	Emission Level (dBuV/m)	Read Level (dBuV)	Limit (dBuV/m)	Margin (dB)	Antenna Factor (dB/m)	Cable Loss (dB)	Preamp Factor (dB)	Antenna Height (cm)	Table Angle (Degree)	Remark
2330.79	51.86	50.32	74	-22.14	31.73	5.33	35.52	108	215	Peak
2389.74	40.65	38.94	54	-13.35	31.8	5.4	35.49	108	215	Average
2412	83.71	81.94			31.81	5.43	35.47	108	215	Average
2412	91.29	89.52			31.81	5.43	35.47	108	215	Peak
4824	38.97	30.84	54	-15.03	33.97	8.26	34.1	103	146	Average
4824	48.26	40.13	74	-25.74	33.97	8.26	34.1	103	146	Peak
Antennal Polarity & Test Distance: Vertical at 3 m										
Frequency (MHz)	Emission Level (dBuV/m)	Read Level (dBuV)	Limit (dBuV/m)	Margin (dB)	Antenna Factor (dB/m)	Cable Loss (dB)	Preamp Factor (dB)	Antenna Height (cm)	Table Angle (Degree)	Remark
2367.15	40.65	39.01	54	-13.35	31.76	5.37	35.49	132	14	Average
2382.45	51.95	50.26	74	-22.05	31.78	5.4	35.49	132	14	Peak
2412	81.27	79.5			31.81	5.43	35.47	132	14	Average
2412	89.65	87.88			31.81	5.43	35.47	132	14	Peak
4824	38.16	30.03	54	-15.84	33.97	8.26	34.1	150	275	Average
4824	47.32	39.19	74	-26.68	33.97	8.26	34.1	150	275	Peak

Remarks:

- Emission Level = Read Level + Antenna Factor + Cable Loss - Preamp Factor
Margin value = Emission level – Limit value
- 2412 MHz: Fundamental frequency.

EUT Test Condition		Measurement Detail	
Channel	Channel 6	Frequency Range	1 GHz ~ 25 GHz
Input Power	120 Vac, 60 Hz	Detector Function	Peak (PK) Average (AV)
Environmental Conditions	25 deg. C, 65 % RH	Tested By	Karl Lee

Horizontal

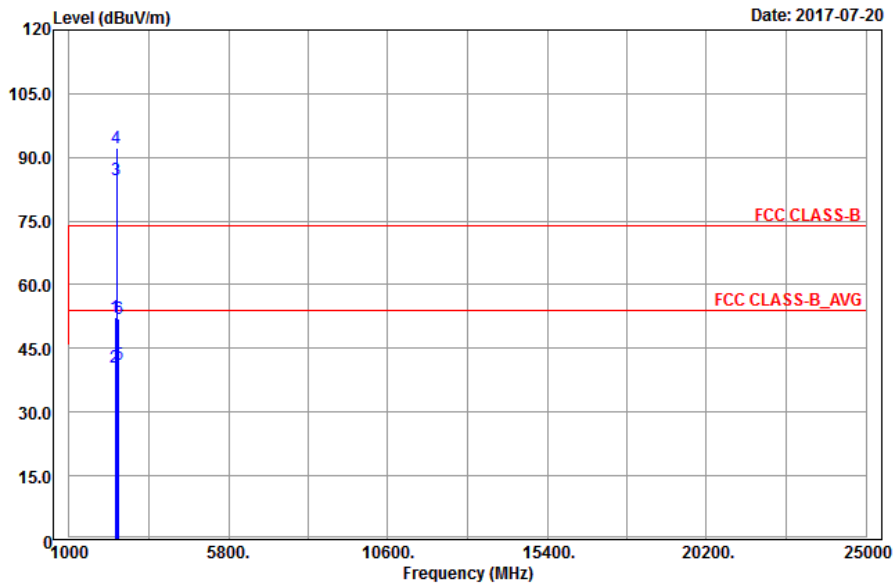

Vertical

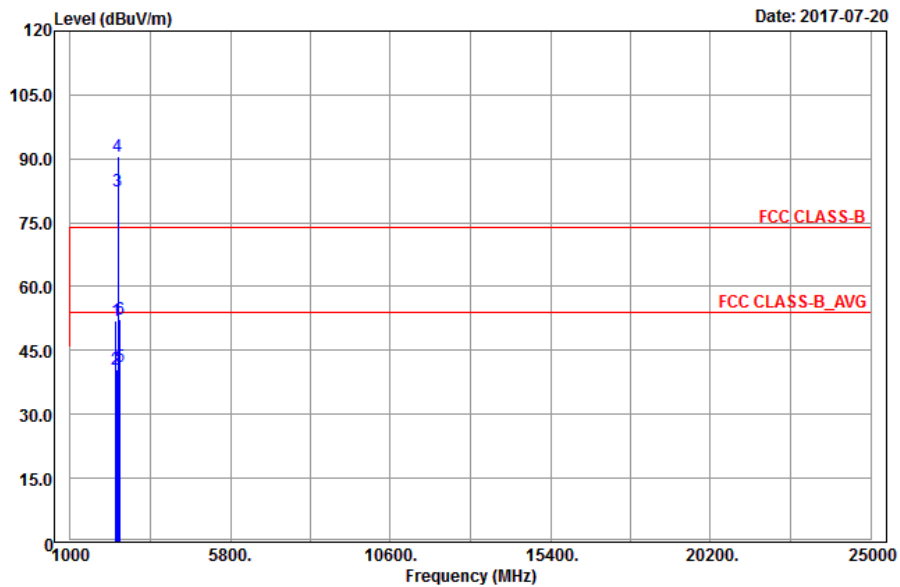

Antennal Polarity & Test Distance: Horizontal at 3 m

Frequency (MHz)	Emission Level (dBuV/m)	Read Level (dBuV)	Limit (dBuV/m)	Margin (dB)	Antenna Factor (dB/m)	Cable Loss (dB)	Preamp Factor (dB)	Antenna Height (cm)	Table Angle (Degree)	Remark
2382.45	52.44	50.75	74	-21.56	31.78	5.4	35.49	108	215	Peak
2389.83	40.69	38.96	54	-13.31	31.8	5.4	35.47	108	215	Average
2437	84.68	82.83			31.85	5.46	35.46	108	215	Average
2437	92.1	90.25			31.85	5.46	35.46	108	215	Peak
2488.48	41.19	39.18	54	-12.81	31.9	5.53	35.42	108	215	Average
2499.92	52.04	50.02	74	-21.96	31.9	5.53	35.41	108	215	Peak

Antennal Polarity & Test Distance: Vertical at 3 m

Frequency (MHz)	Emission Level (dBuV/m)	Read Level (dBuV)	Limit (dBuV/m)	Margin (dB)	Antenna Factor (dB/m)	Cable Loss (dB)	Preamp Factor (dB)	Antenna Height (cm)	Table Angle (Degree)	Remark
2377.14	51.84	50.18	74	-22.16	31.78	5.37	35.49	132	14	Peak
2381.55	40.56	38.87	54	-13.44	31.78	5.4	35.49	132	14	Average
2437	82.28	80.43			31.85	5.46	35.46	132	14	Average
2437	90.49	88.64			31.85	5.46	35.46	132	14	Peak
2492.2	41.22	39.2	54	-12.78	31.9	5.53	35.41	132	14	Average
2493.6	52.3	50.28	74	-21.7	31.9	5.53	35.41	132	14	Peak

Remarks:

- Emission Level = Read Level + Antenna Factor + Cable Loss - Preamp Factor
Margin value = Emission level – Limit value
- 2437 MHz: Fundamental frequency.

EUT Test Condition		Measurement Detail	
Channel	Channel 11	Frequency Range	1 GHz ~ 25 GHz
Input Power	120 Vac, 60 Hz	Detector Function	Peak (PK) Average (AV)
Environmental Conditions	25 deg. C, 65 % RH	Tested By	Karl Lee

Horizontal

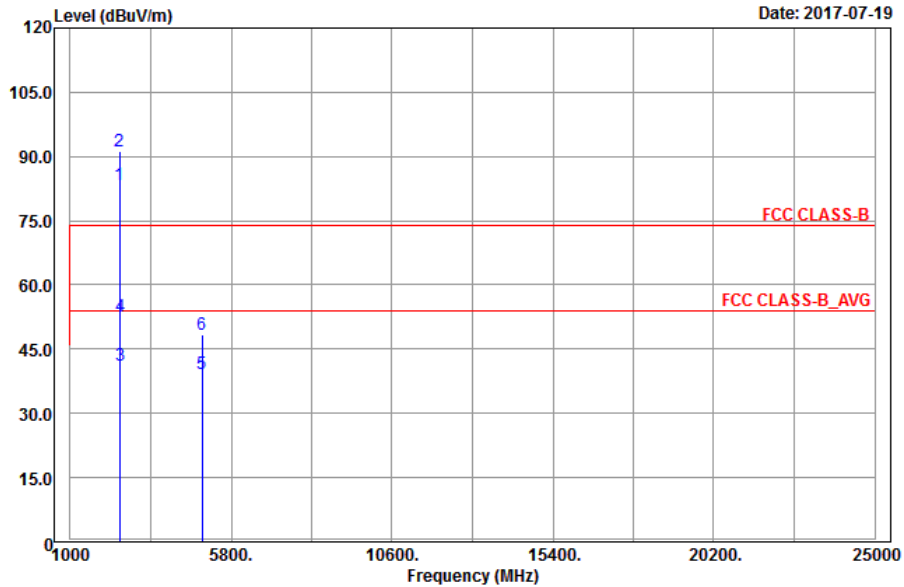

Vertical

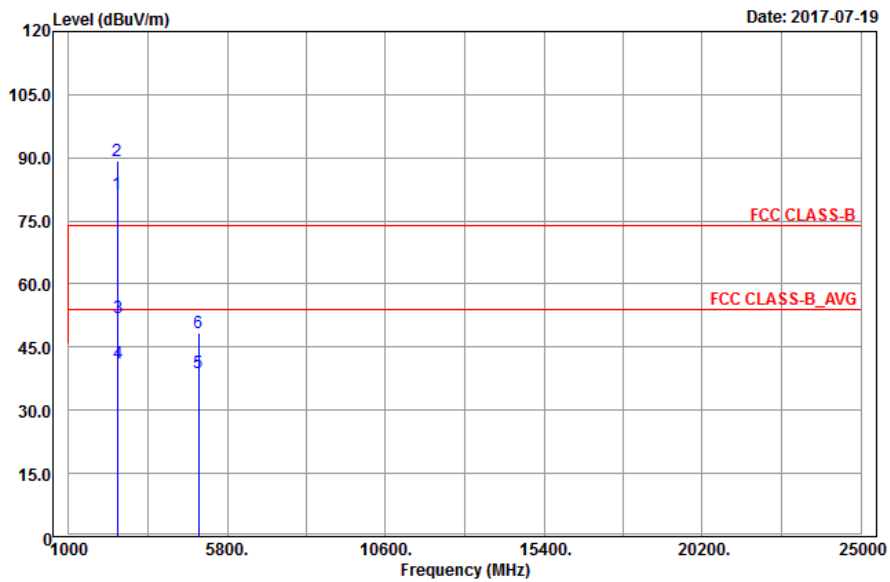

**Band Edge
Peak
Horizontal**

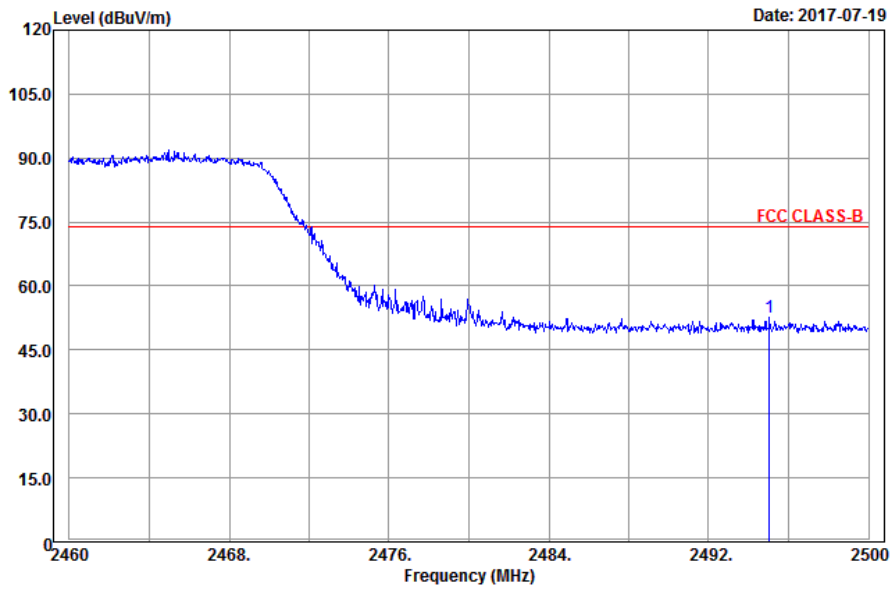

Vertical

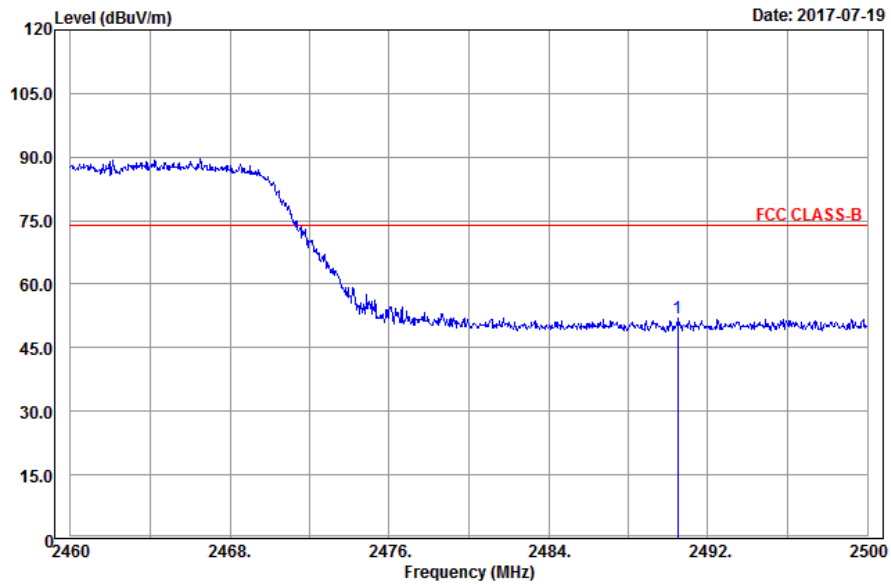

Average Horizontal

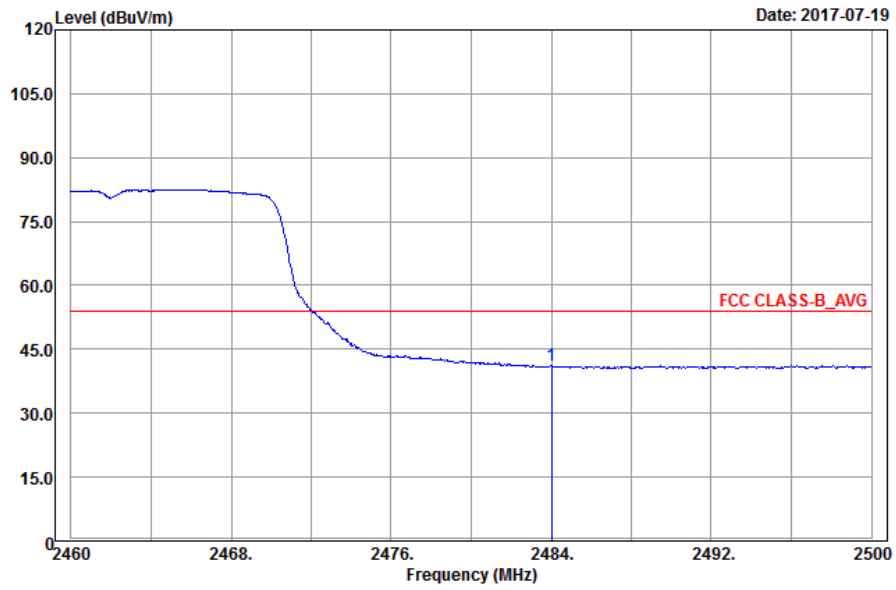

Vertical

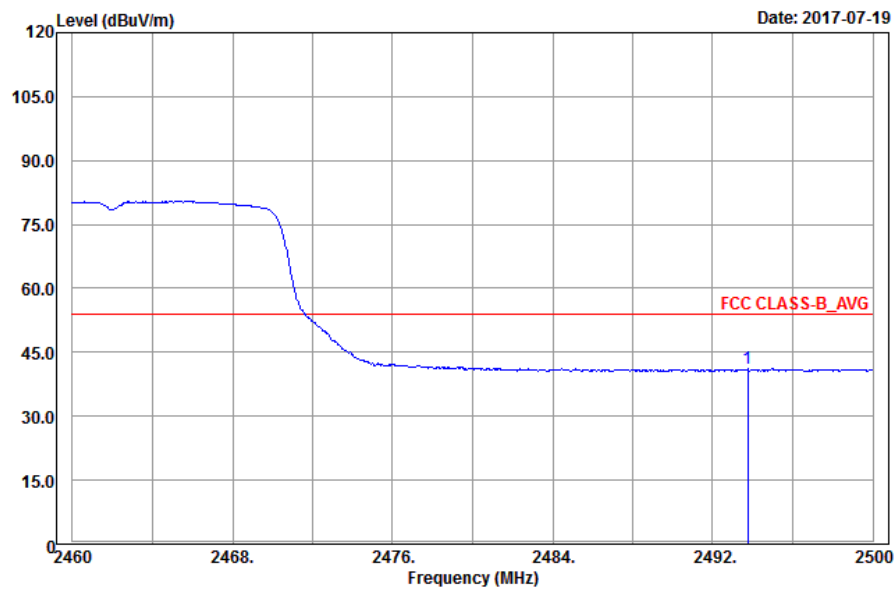

Antennal Polarity & Test Distance: Horizontal at 3 m										
Frequency (MHz)	Emission Level (dBuV/m)	Read Level (dBuV)	Limit (dBuV/m)	Margin (dB)	Antenna Factor (dB/m)	Cable Loss (dB)	Preamp Factor (dB)	Antenna Height (cm)	Table Angle (Degree)	Remark
2462	83.37	81.44			31.87	5.5	35.44	108	215	Average
2462	91.24	89.31			31.87	5.5	35.44	108	215	Peak
2484	41.22	39.26	54	-12.78	31.88	5.5	35.42	108	215	Average
2495.04	52.51	50.49	74	-21.49	31.9	5.53	35.41	108	215	Peak
4924	39.2	30.95	54	-14.8	33.99	8.28	34.02	127	61	Average
4924	48.44	40.19	74	-25.56	33.99	8.28	34.02	127	61	Peak
Antennal Polarity & Test Distance: Vertical at 3 m										
Frequency (MHz)	Emission Level (dBuV/m)	Read Level (dBuV)	Limit (dBuV/m)	Margin (dB)	Antenna Factor (dB/m)	Cable Loss (dB)	Preamp Factor (dB)	Antenna Height (cm)	Table Angle (Degree)	Remark
2462	81.56	79.63			31.87	5.5	35.44	131	14	Average
2462	89.2	87.27			31.87	5.5	35.44	131	14	Peak
2490.48	51.89	49.88	74	-22.11	31.9	5.53	35.42	131	14	Peak
2493.76	41.14	39.12	54	-12.86	31.9	5.53	35.41	131	14	Average
4924	39.04	30.79	54	-14.96	33.99	8.28	34.02	184	209	Average
4924	48.52	40.27	74	-25.48	33.99	8.28	34.02	184	209	Peak

Remarks:

- Emission Level = Read Level + Antenna Factor + Cable Loss - Preamp Factor
Margin value = Emission level – Limit value
- 2462 MHz: Fundamental frequency.

802.11n (HT20)

EUT Test Condition		Measurement Detail	
Channel	Channel 1	Frequency Range	1 GHz ~ 25 GHz
Input Power	120 Vac, 60 Hz	Detector Function	Peak (PK) Average (AV)
Environmental Conditions	25 deg. C, 65 % RH	Tested By	Karl Lee

Horizontal

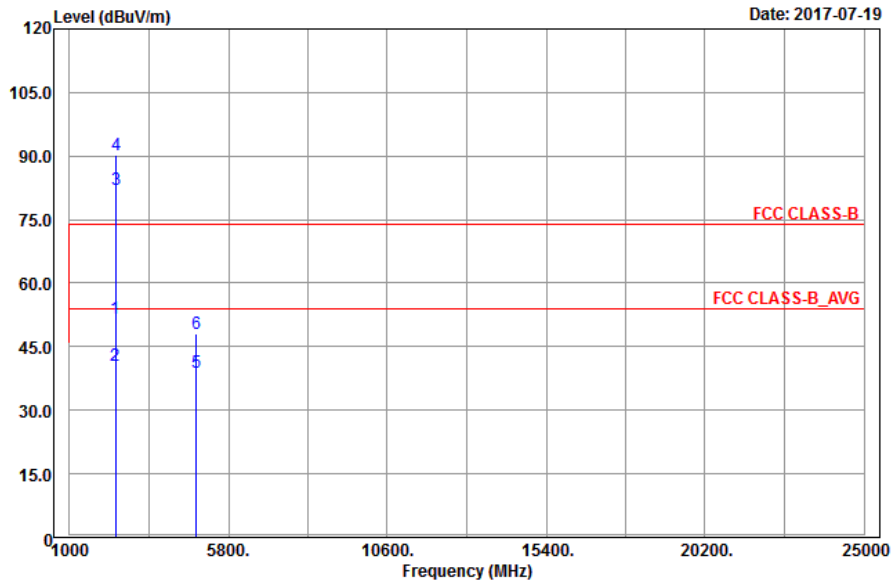

Vertical

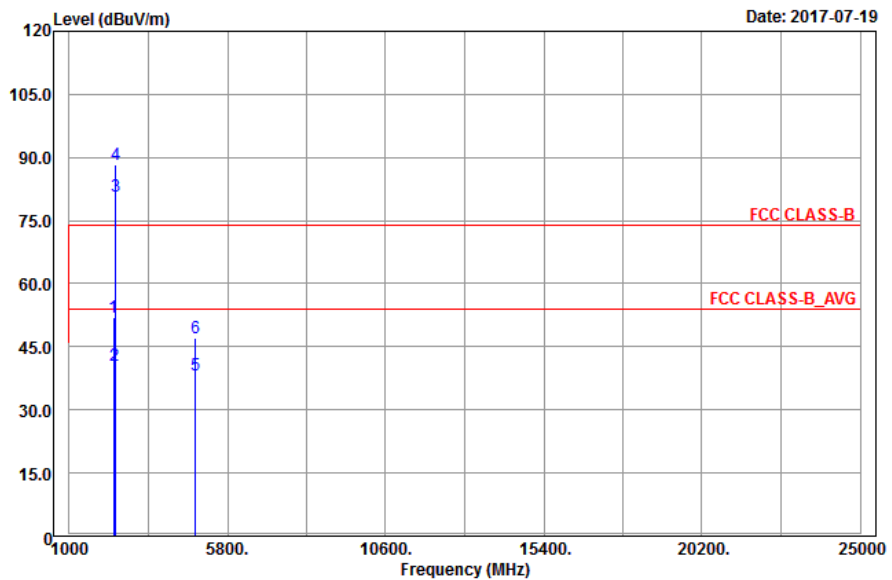

**Band Edge
Peak
Horizontal**

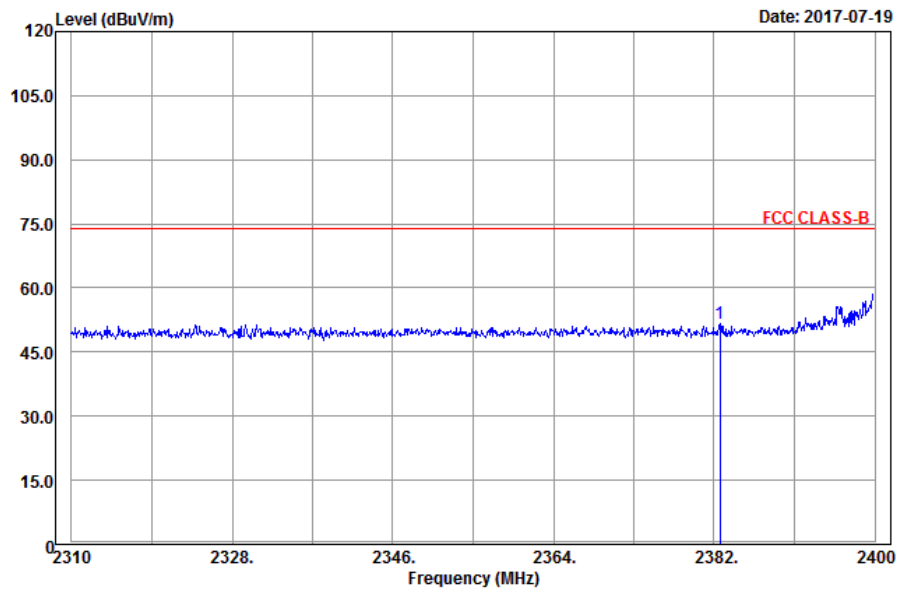

Vertical

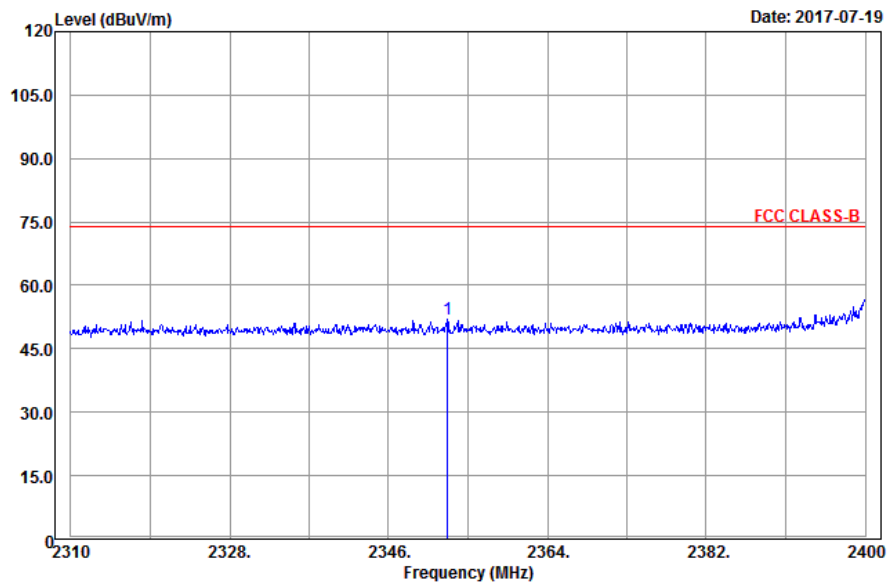

Average Horizontal

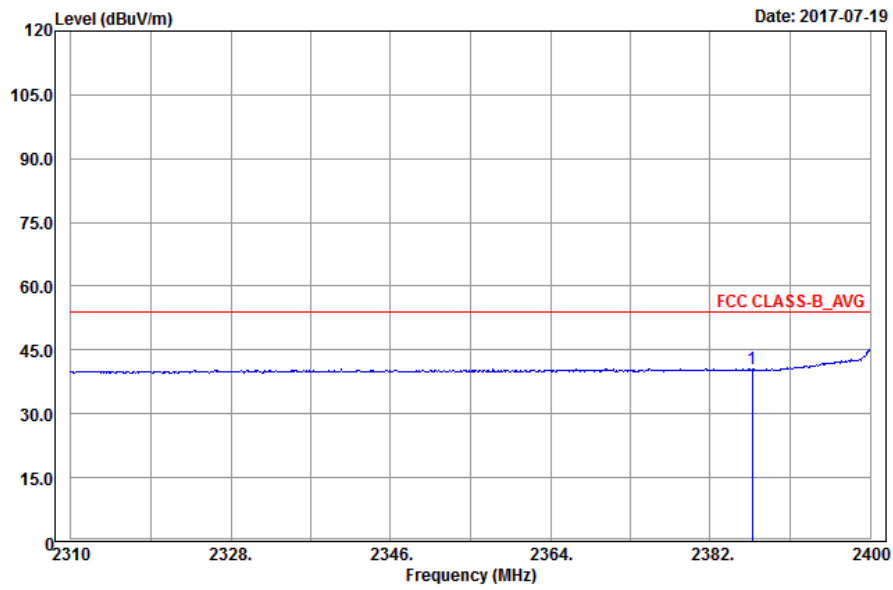

Vertical

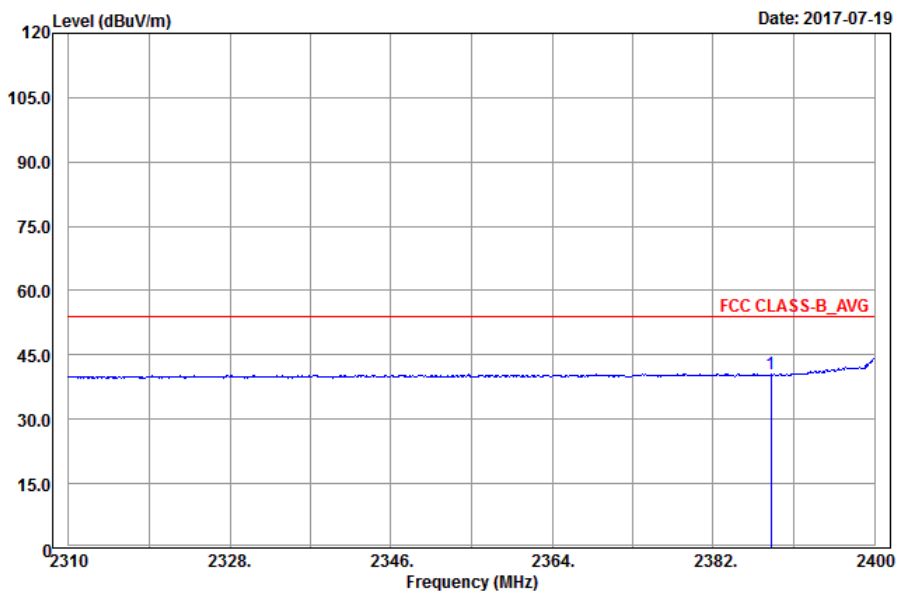

Antennal Polarity & Test Distance: Horizontal at 3 m

Frequency (MHz)	Emission Level (dBuV/m)	Read Level (dBuV)	Limit (dBuV/m)	Margin (dB)	Antenna Factor (dB/m)	Cable Loss (dB)	Preamp Factor (dB)	Antenna Height (cm)	Table Angle (Degree)	Remark
2382.63	51.66	49.97	74	-22.34	31.78	5.4	35.49	108	215	Peak
2386.77	40.51	38.8	54	-13.49	31.8	5.4	35.49	108	215	Average
2412	82.09	80.32			31.81	5.43	35.47	108	215	Average
2412	90.39	88.62			31.81	5.43	35.47	108	215	Peak
4824	39.05	30.92	54	-14.95	33.97	8.26	34.1	145	294	Average
4824	48.11	39.98	74	-25.89	33.97	8.26	34.1	145	294	Peak

Antennal Polarity & Test Distance: Vertical at 3 m

Frequency (MHz)	Emission Level (dBuV/m)	Read Level (dBuV)	Limit (dBuV/m)	Margin (dB)	Antenna Factor (dB/m)	Cable Loss (dB)	Preamp Factor (dB)	Antenna Height (cm)	Table Angle (Degree)	Remark
2352.66	52.01	50.42	74	-21.99	31.76	5.33	35.5	132	14	Peak
2388.48	40.6	38.89	54	-13.4	31.8	5.4	35.49	132	14	Average
2412	80.73	78.96			31.81	5.43	35.47	132	14	Average
2412	88.29	86.52			31.81	5.43	35.47	132	14	Peak
4824	38.32	30.19	54	-15.68	33.97	8.26	34.1	185	326	Average
4824	47.22	39.09	74	-26.78	33.97	8.26	34.1	185	326	Peak

Remarks:

- Emission Level = Read Level + Antenna Factor + Cable Loss - Preamp Factor
Margin value = Emission level – Limit value
- 2412 MHz: Fundamental frequency.

EUT Test Condition		Measurement Detail	
Channel	Channel 6	Frequency Range	1 GHz ~ 25 GHz
Input Power	120 Vac, 60 Hz	Detector Function	Peak (PK) Average (AV)
Environmental Conditions	25 deg. C, 65 % RH	Tested By	Karl Lee

Horizontal

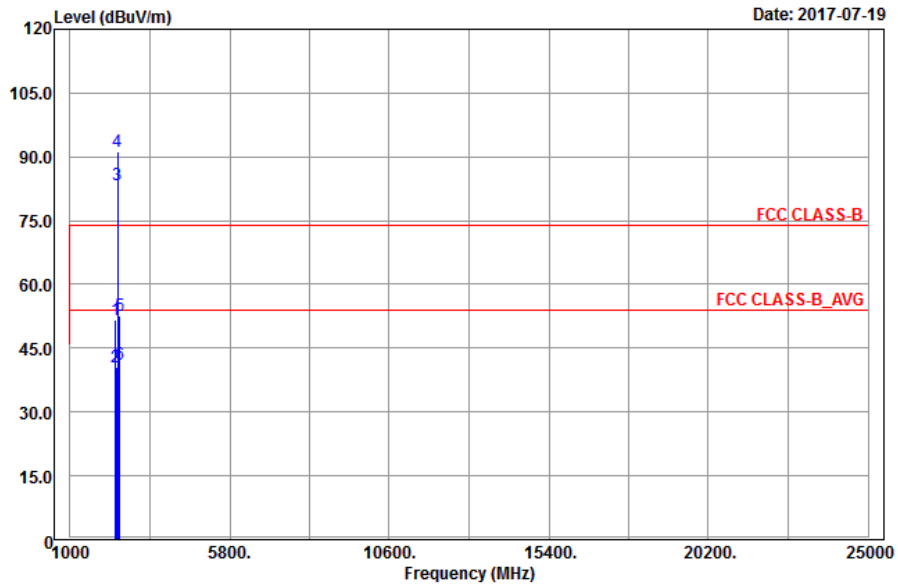

Vertical

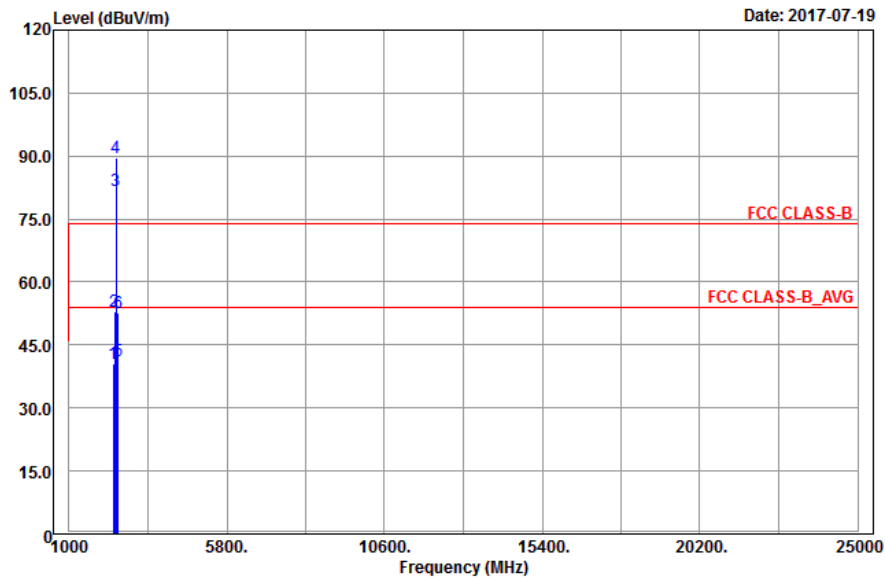

Antennal Polarity & Test Distance: Horizontal at 3 m

Frequency (MHz)	Emission Level (dBuV/m)	Read Level (dBuV)	Limit (dBuV/m)	Margin (dB)	Antenna Factor (dB/m)	Cable Loss (dB)	Preamp Factor (dB)	Antenna Height (cm)	Table Angle (Degree)	Remark
2375.34	51.69	50.03	74	-22.31	31.78	5.37	35.49	108	215	Peak
2383.98	40.59	38.9	54	-13.41	31.78	5.4	35.49	108	215	Average
2437	83.4	81.55			31.85	5.46	35.46	108	215	Average
2437	91.27	89.42			31.85	5.46	35.46	108	215	Peak
2488.44	52.55	50.54	74	-21.45	31.9	5.53	35.42	108	215	Peak
2493	41.18	39.16	54	-12.82	31.9	5.53	35.41	108	215	Average

Antennal Polarity & Test Distance: Vertical at 3 m

Frequency (MHz)	Emission Level (dBuV/m)	Read Level (dBuV)	Limit (dBuV/m)	Margin (dB)	Antenna Factor (dB/m)	Cable Loss (dB)	Preamp Factor (dB)	Antenna Height (cm)	Table Angle (Degree)	Remark
2355.63	40.61	38.98	54	-13.39	31.76	5.37	35.5	132	14	Average
2388.57	52.84	51.13	74	-21.16	31.8	5.4	35.49	132	14	Peak
2437	81.77	79.92			31.85	5.46	35.46	132	14	Average
2437	89.75	87.9			31.85	5.46	35.46	132	14	Peak
2490.8	41.21	39.2	54	-12.79	31.9	5.53	35.42	132	14	Average
2498.44	52.73	50.71	74	-21.27	31.9	5.53	35.41	132	14	Peak

Remarks:

- Emission Level = Read Level + Antenna Factor + Cable Loss - Preamp Factor
Margin value = Emission level – Limit value
- 2437 MHz: Fundamental frequency.

EUT Test Condition		Measurement Detail	
Channel	Channel 11	Frequency Range	1 GHz ~ 25 GHz
Input Power	120 Vac, 60 Hz	Detector Function	Peak (PK) Average (AV)
Environmental Conditions	25 deg. C, 65 % RH	Tested By	Karl Lee

Horizontal

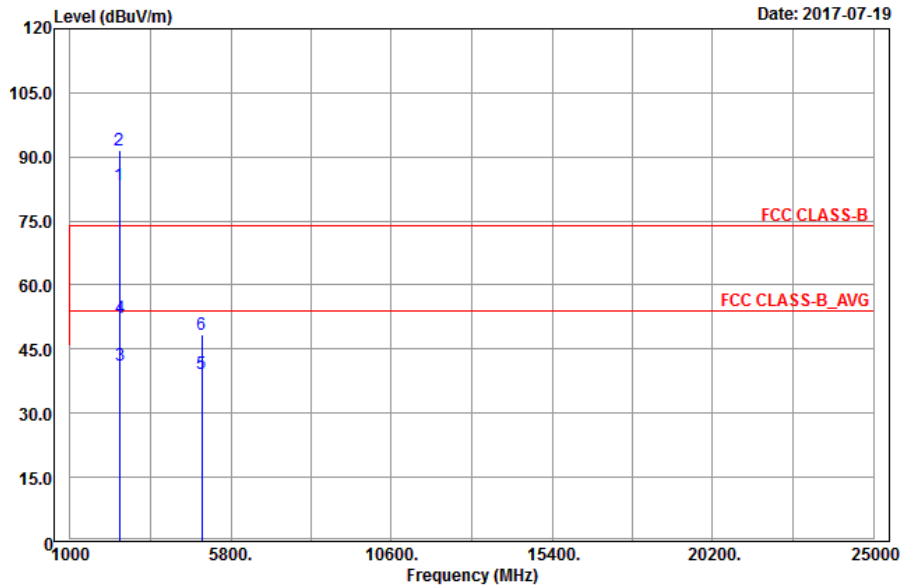

Vertical

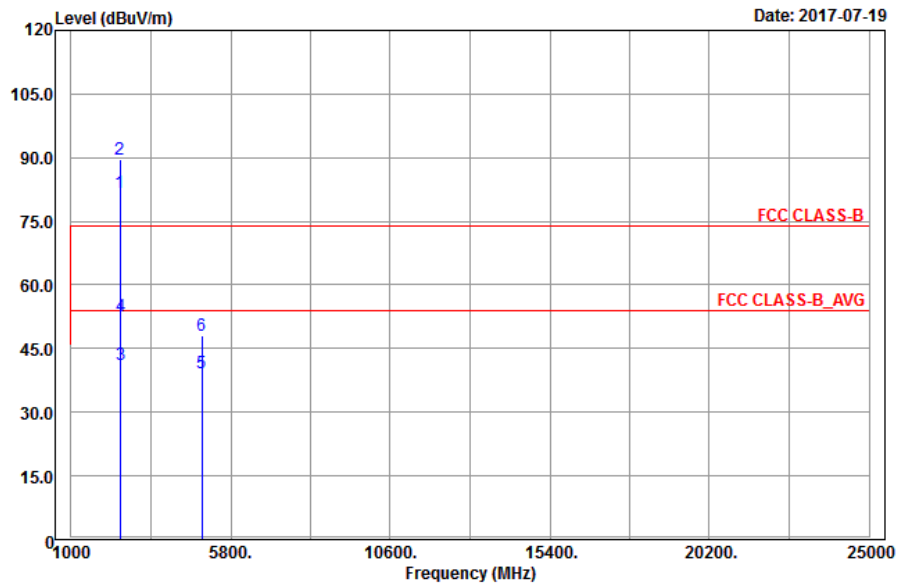

**Band Edge
Peak
Horizontal**

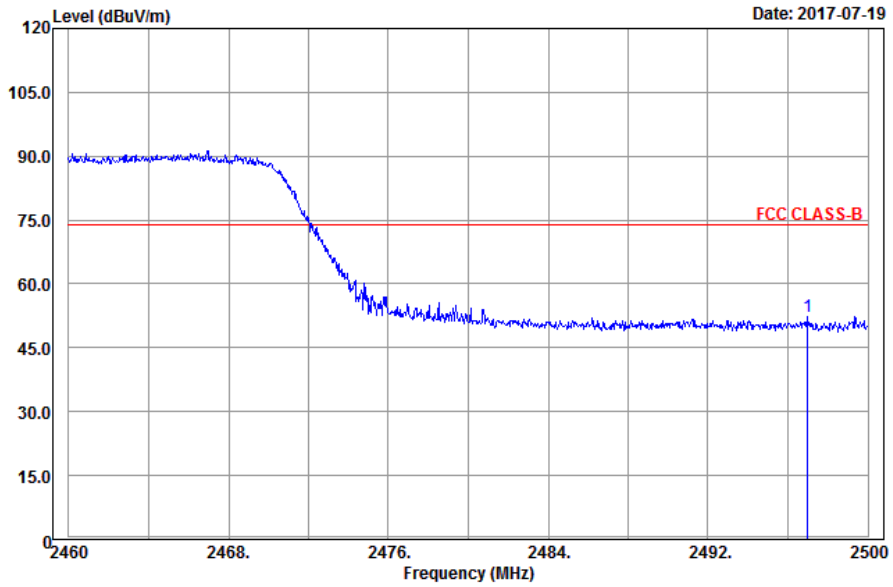

Vertical

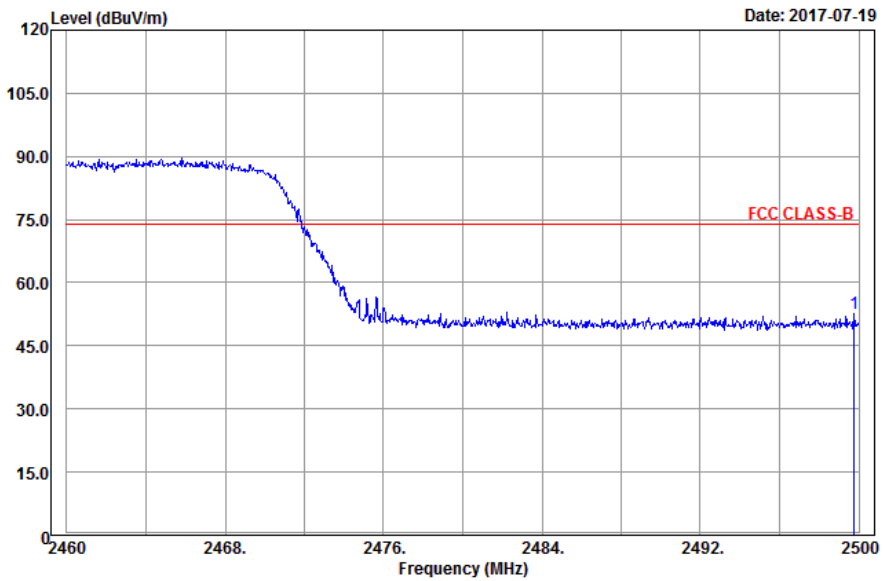

Average Horizontal

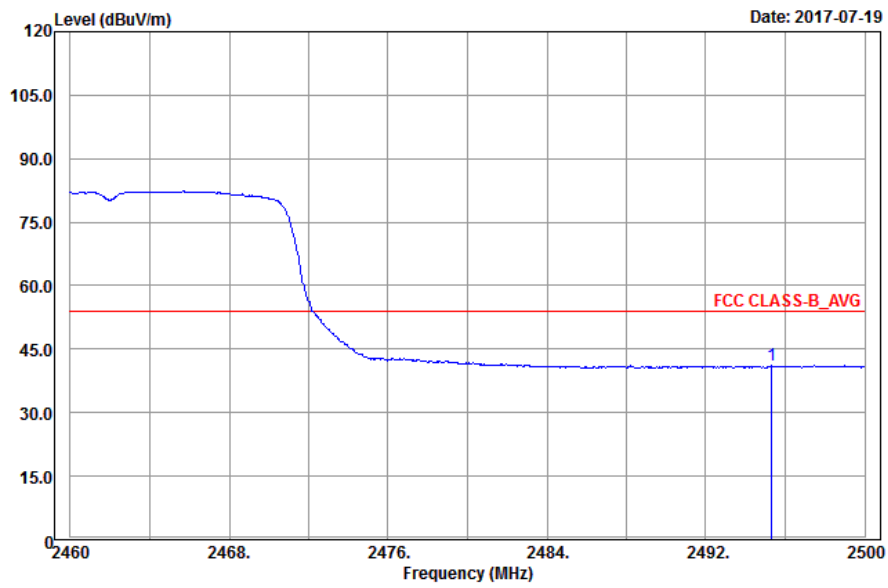

Vertical

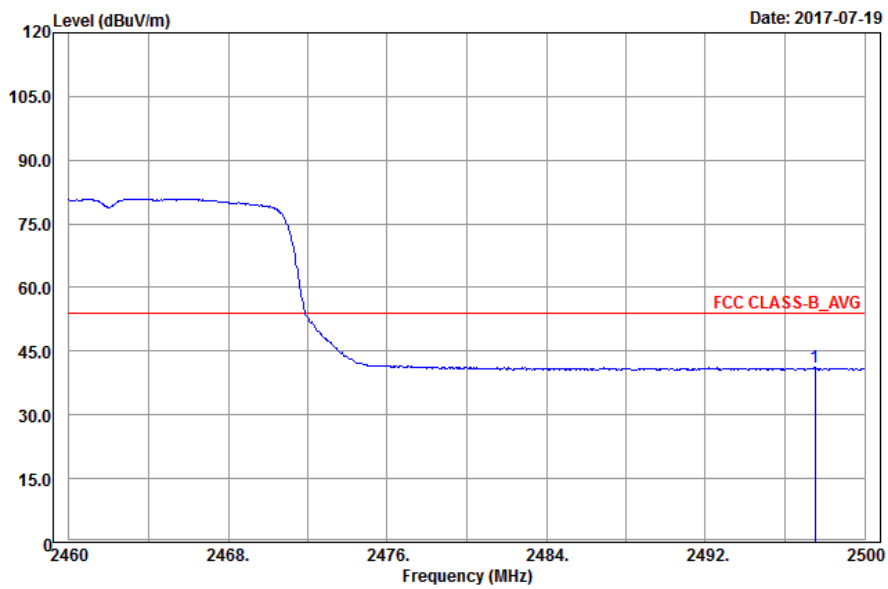

Antennal Polarity & Test Distance: Horizontal at 3 m										
Frequency (MHz)	Emission Level (dBuV/m)	Read Level (dBuV)	Limit (dBuV/m)	Margin (dB)	Antenna Factor (dB/m)	Cable Loss (dB)	Preamp Factor (dB)	Antenna Height (cm)	Table Angle (Degree)	Remark
2462	83.28	81.35			31.87	5.5	35.44	108	215	Average
2462	91.42	89.49			31.87	5.5	35.44	108	215	Peak
2495.32	41.16	39.14	54	-12.84	31.9	5.53	35.41	108	215	Average
2497	52.47	50.45	74	-21.53	31.9	5.53	35.41	108	215	Peak
4924	39.19	30.94	54	-14.81	33.99	8.28	34.02	155	131	Average
4924	48.34	40.09	74	-25.66	33.99	8.28	34.02	155	131	Peak
Antennal Polarity & Test Distance: Vertical at 3 m										
Frequency (MHz)	Emission Level (dBuV/m)	Read Level (dBuV)	Limit (dBuV/m)	Margin (dB)	Antenna Factor (dB/m)	Cable Loss (dB)	Preamp Factor (dB)	Antenna Height (cm)	Table Angle (Degree)	Remark
2462	81.85	79.92			31.87	5.5	35.44	132	14	Average
2462	89.45	87.52			31.87	5.5	35.44	132	14	Peak
2497.52	41.18	39.16	54	-12.82	31.9	5.53	35.41	132	14	Average
2499.76	52.69	50.67	74	-21.31	31.9	5.53	35.41	132	14	Peak
4924	39.17	30.92	54	-14.83	33.99	8.28	34.02	127	212	Average
4924	48.15	39.9	74	-25.85	33.99	8.28	34.02	127	212	Peak

Remarks:

- Emission Level = Read Level + Antenna Factor + Cable Loss - Preamp Factor
Margin value = Emission level – Limit value
- 2462 MHz: Fundamental frequency.

Mode B
802.11b

EUT Test Condition		Measurement Detail	
Channel	Channel 1	Frequency Range	1 GHz ~ 25 GHz
Input Power	120 Vac, 60 Hz	Detector Function	Peak (PK) Average (AV)
Environmental Conditions	25 deg. C, 65 % RH	Tested By	Karl Lee

Horizontal

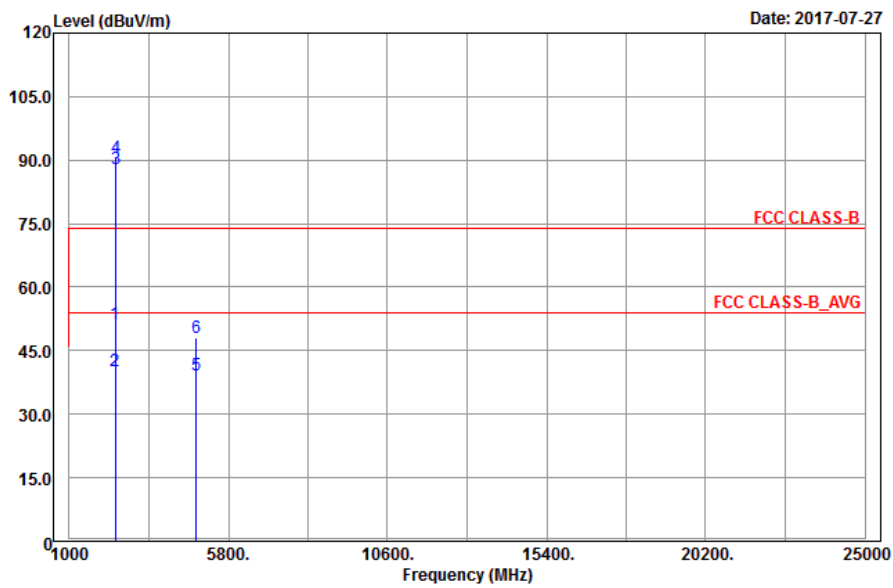

Vertical

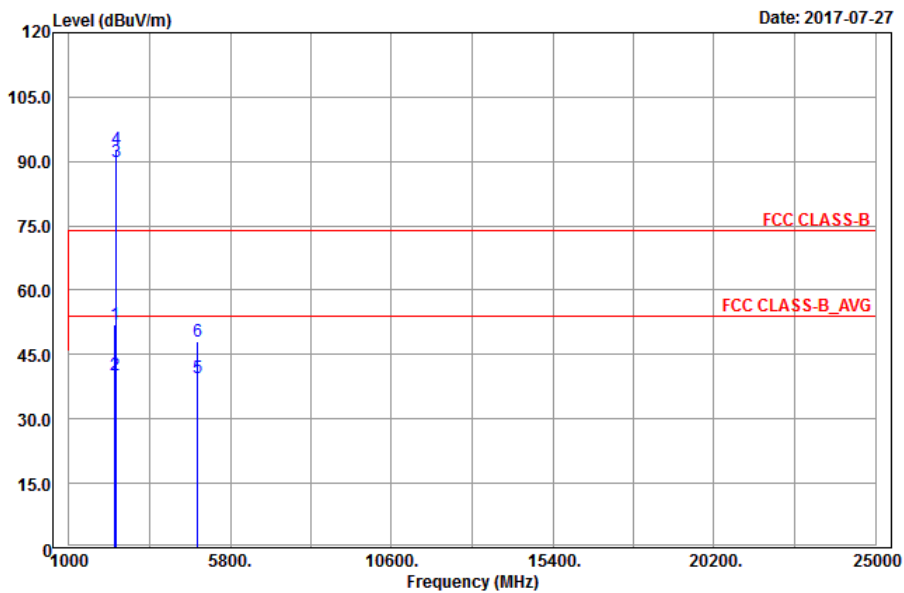

**Band Edge
Peak
Horizontal**

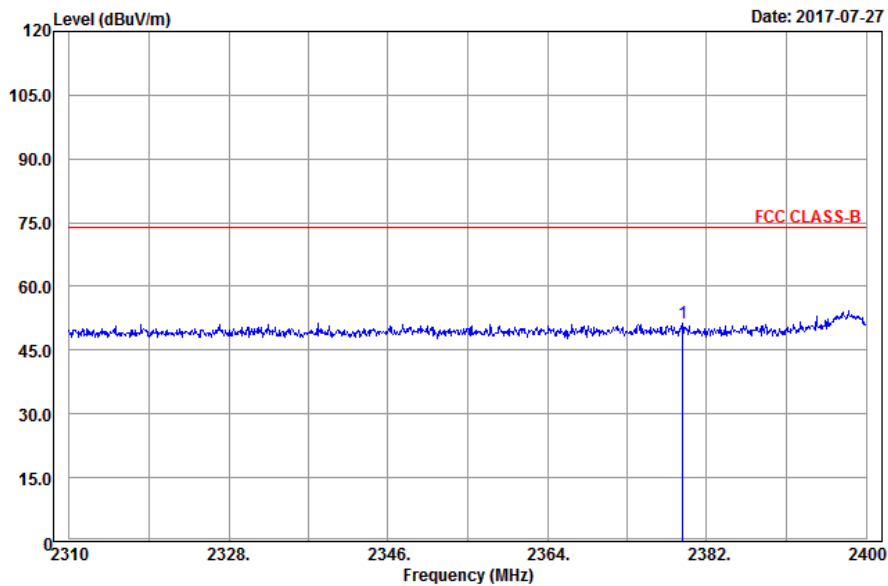

Vertical

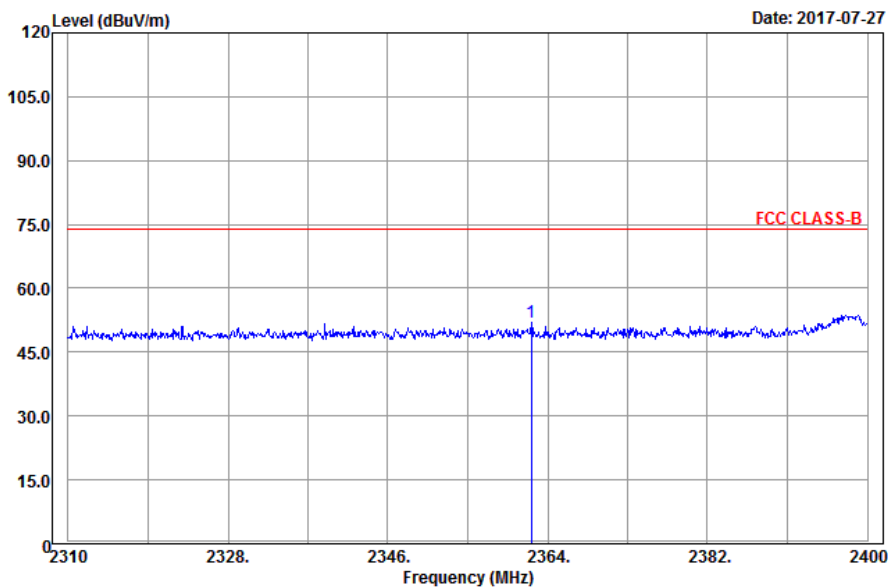

Average Horizontal

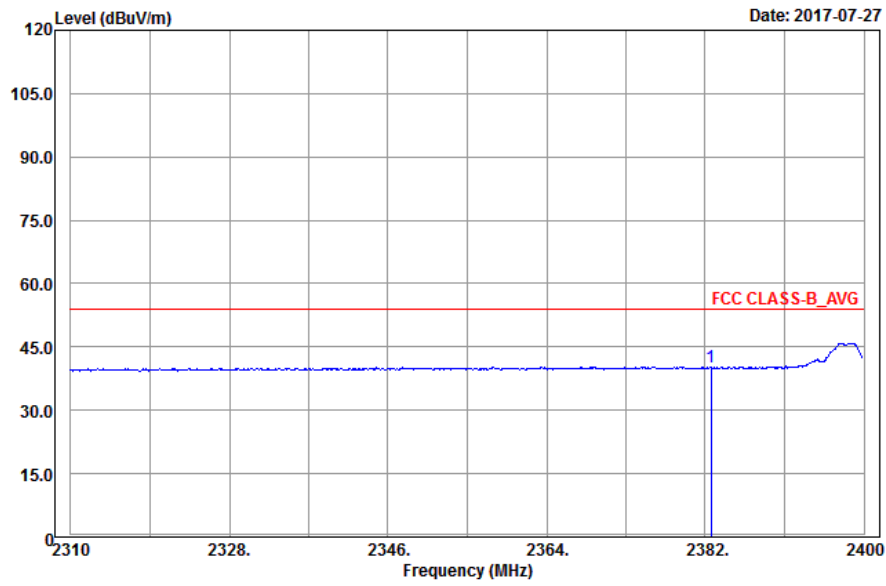

Vertical

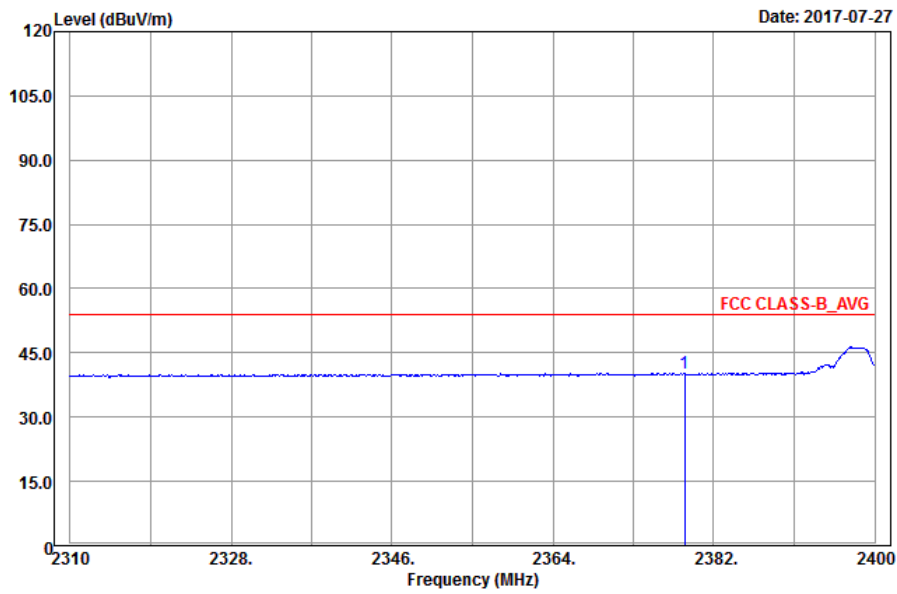

Antennal Polarity & Test Distance: Horizontal at 3 m

Frequency (MHz)	Emission Level (dBuV/m)	Read Level (dBuV)	Limit (dBuV/m)	Margin (dB)	Antenna Factor (dB/m)	Cable Loss (dB)	Preamp Factor (dB)	Antenna Height (cm)	Table Angle (Degree)	Remark
2379.3	51.47	49.81	74	-22.53	31.78	5.37	35.49	112	3	Peak
2382.63	40.27	38.58	54	-13.73	31.78	5.4	35.49	112	3	Average
2412	87.91	86.14			31.81	5.43	35.47	112	3	Average
2412	90.71	88.94			31.81	5.43	35.47	112	3	Peak
4824	39.24	31.11	54	-14.76	33.97	8.26	34.1	106	352	Average
4824	48.08	39.95	74	-25.92	33.97	8.26	34.1	106	352	Peak

Antennal Polarity & Test Distance: Vertical at 3 m

Frequency (MHz)	Emission Level (dBuV/m)	Read Level (dBuV)	Limit (dBuV/m)	Margin (dB)	Antenna Factor (dB/m)	Cable Loss (dB)	Preamp Factor (dB)	Antenna Height (cm)	Table Angle (Degree)	Remark
2362.2	51.96	50.33	74	-22.04	31.76	5.37	35.5	288	184	Peak
2378.76	40.33	38.67	54	-13.67	31.78	5.37	35.49	288	184	Average
2412	89.89	88.12			31.81	5.43	35.47	288	184	Average
2412	92.74	90.97			31.81	5.43	35.47	288	184	Peak
4824	39.52	31.39	54	-14.48	33.97	8.26	34.1	147	123	Average
4824	48.15	40.02	74	-25.85	33.97	8.26	34.1	147	123	Peak

Remarks:

- Emission Level = Read Level + Antenna Factor + Cable Loss - Preamp Factor
Margin value = Emission level – Limit value
- 2412 MHz: Fundamental frequency.

EUT Test Condition		Measurement Detail	
Channel	Channel 6	Frequency Range	1 GHz ~ 25 GHz
Input Power	120 Vac, 60 Hz	Detector Function	Peak (PK) Average (AV)
Environmental Conditions	25 deg. C, 65 % RH	Tested By	Karl Lee

Horizontal

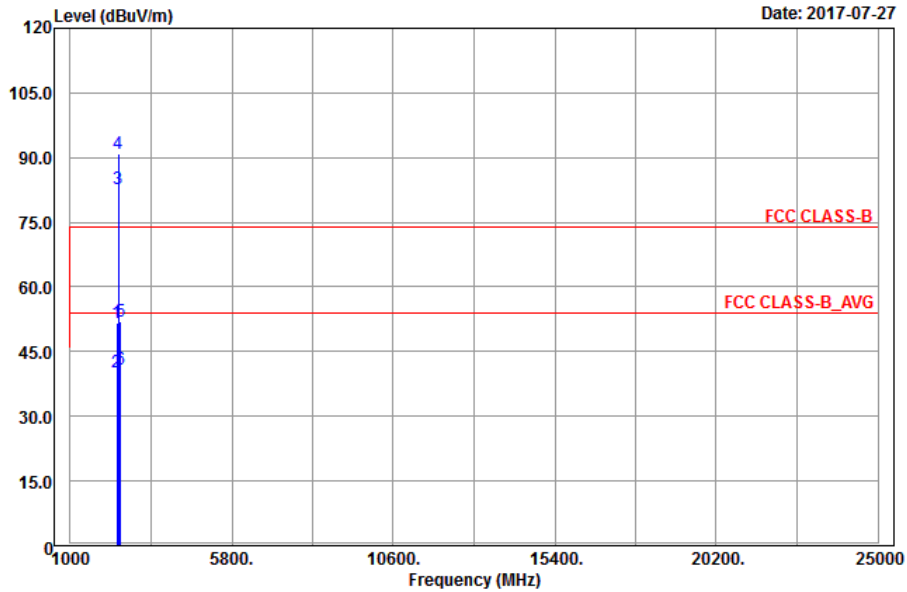

Vertical

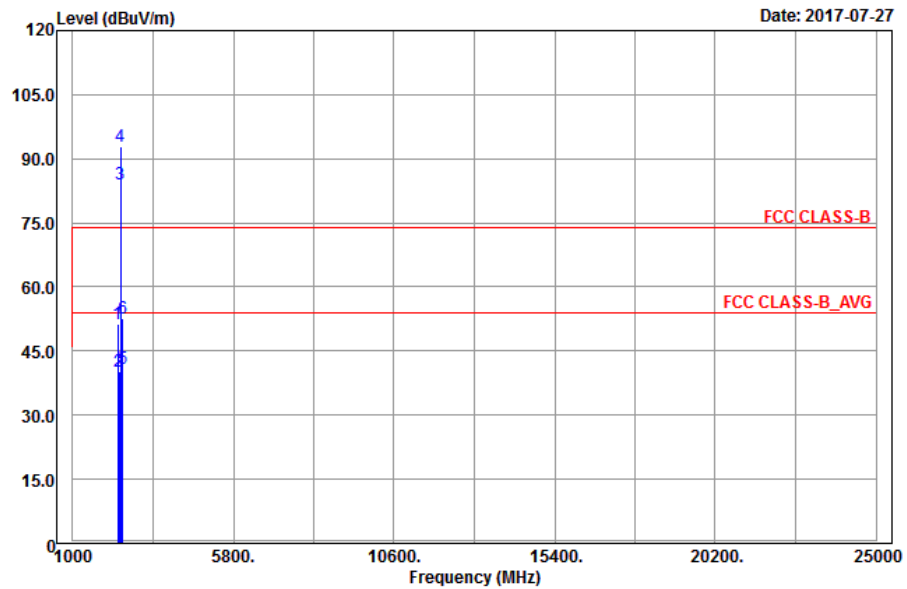

Antennal Polarity & Test Distance: Horizontal at 3 m

Frequency (MHz)	Emission Level (dBuV/m)	Read Level (dBuV)	Limit (dBuV/m)	Margin (dB)	Antenna Factor (dB/m)	Cable Loss (dB)	Preamp Factor (dB)	Antenna Height (cm)	Table Angle (Degree)	Remark
2379.93	51.52	49.86	74	-22.48	31.78	5.37	35.49	120	3	Peak
2384.43	40.36	38.67	54	-13.64	31.78	5.4	35.49	120	3	Average
2437	82.68	80.83			31.85	5.46	35.46	120	3	Average
2437	90.8	88.95			31.85	5.46	35.46	120	3	Peak
2488.84	52.01	50	74	-21.99	31.9	5.53	35.42	120	3	Peak
2498.04	40.87	38.85	54	-13.13	31.9	5.53	35.41	120	3	Average

Antennal Polarity & Test Distance: Vertical at 3 m

Frequency (MHz)	Emission Level (dBuV/m)	Read Level (dBuV)	Limit (dBuV/m)	Margin (dB)	Antenna Factor (dB/m)	Cable Loss (dB)	Preamp Factor (dB)	Antenna Height (cm)	Table Angle (Degree)	Remark
2353.11	51.31	49.72	74	-22.69	31.76	5.33	35.5	288	184	Peak
2384.7	40.31	38.62	54	-13.69	31.78	5.4	35.49	288	184	Average
2437	84.17	82.32			31.85	5.46	35.46	288	184	Average
2437	92.84	90.99			31.85	5.46	35.46	288	184	Peak
2486.28	40.93	38.94	54	-13.07	31.88	5.53	35.42	288	184	Average
2497.16	52.56	50.54	74	-21.44	31.9	5.53	35.41	288	184	Peak

Remarks:

- Emission Level = Read Level + Antenna Factor + Cable Loss - Preamp Factor
Margin value = Emission level – Limit value
- 2437 MHz: Fundamental frequency.

EUT Test Condition		Measurement Detail	
Channel	Channel 11	Frequency Range	1 GHz ~ 25 GHz
Input Power	120 Vac, 60 Hz	Detector Function	Peak (PK) Average (AV)
Environmental Conditions	25 deg. C, 65 % RH	Tested By	Karl Lee

Horizontal

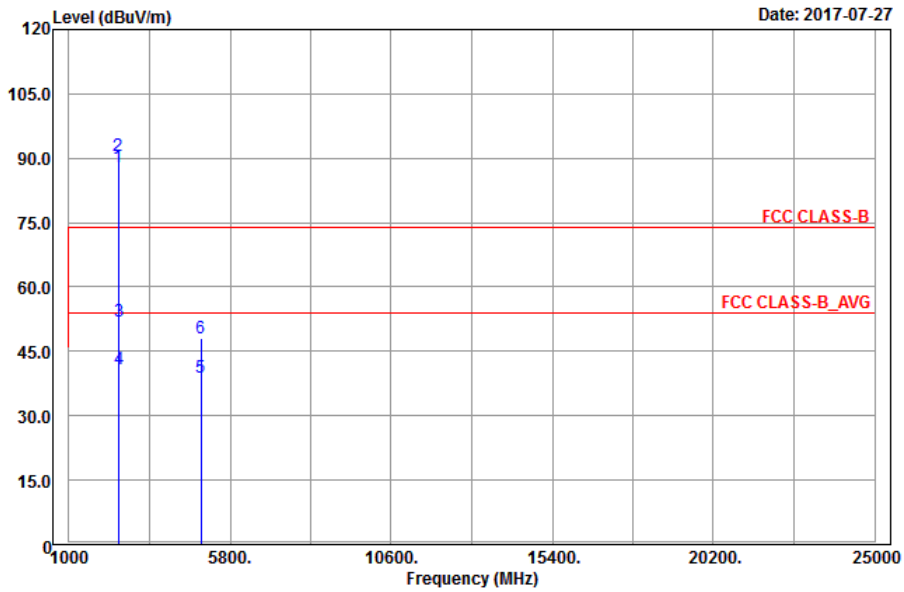

Vertical

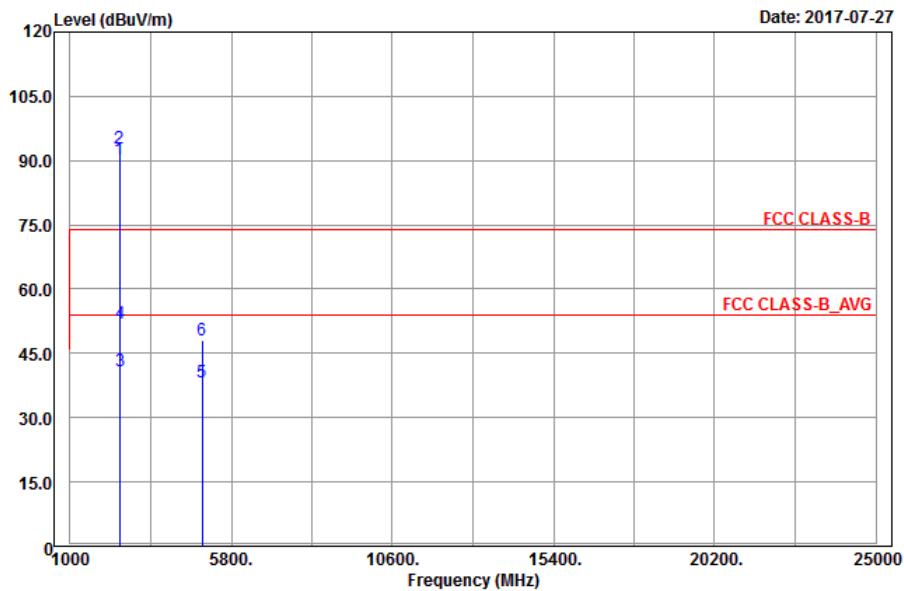

**Band Edge
Peak
Horizontal**

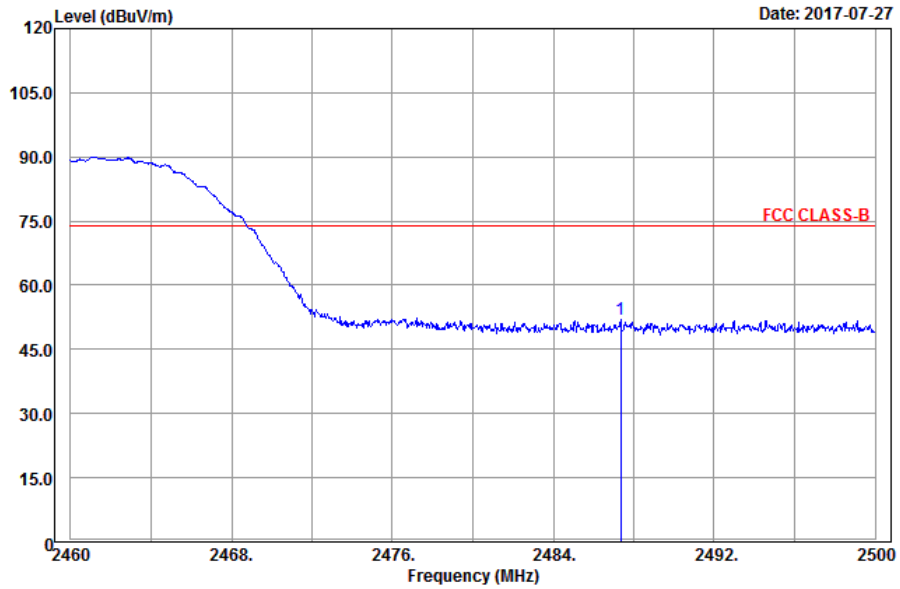

Vertical

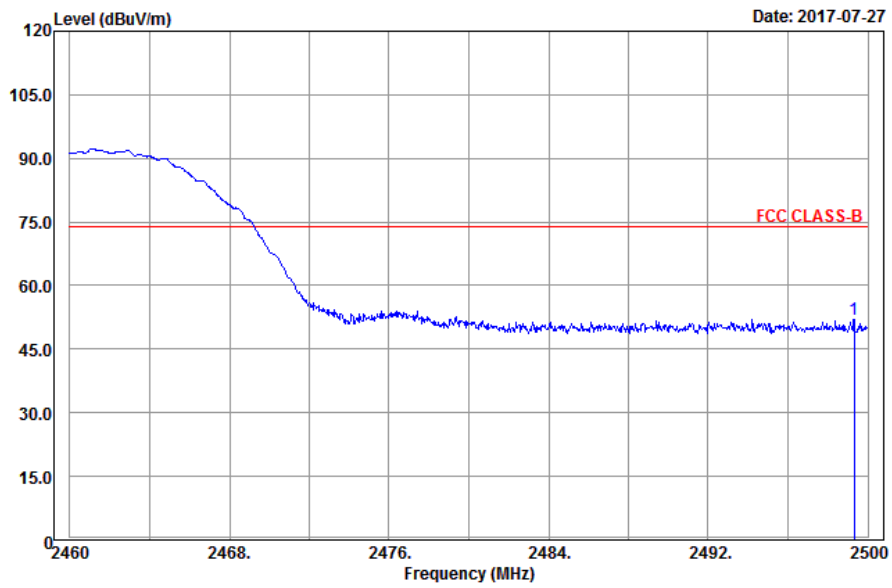

Average Horizontal

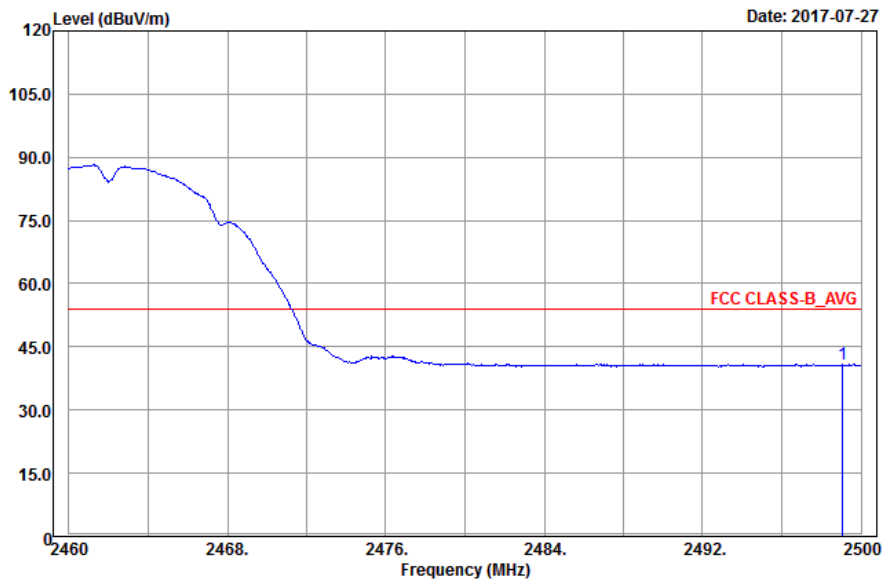

Vertical

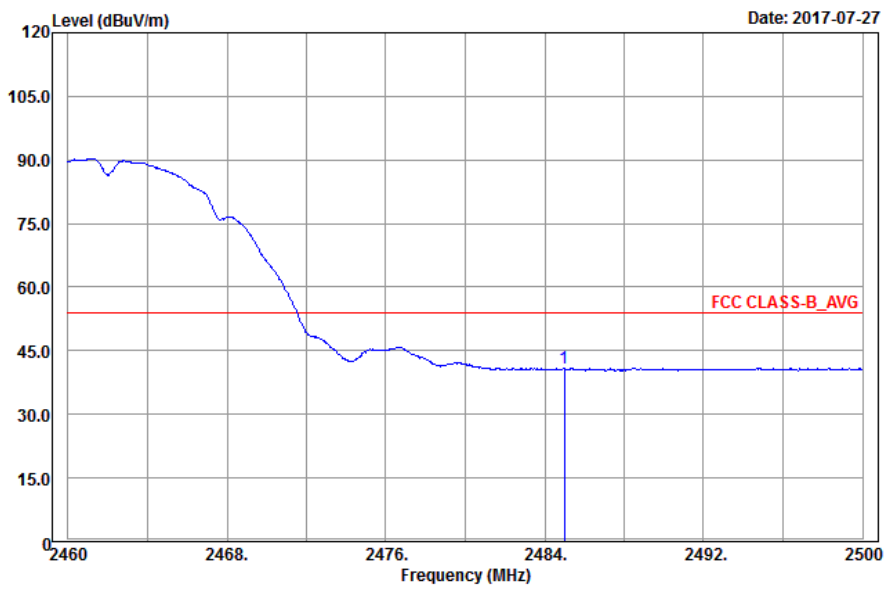

Antennal Polarity & Test Distance: Horizontal at 3 m

Frequency (MHz)	Emission Level (dBuV/m)	Read Level (dBuV)	Limit (dBuV/m)	Margin (dB)	Antenna Factor (dB/m)	Cable Loss (dB)	Preamp Factor (dB)	Antenna Height (cm)	Table Angle (Degree)	Remark
2462	88.04	86.11			31.87	5.5	35.44	140	3	Average
2462	90.69	88.76			31.87	5.5	35.44	140	3	Peak
2487.36	51.85	49.86	74	-22.15	31.88	5.53	35.42	140	3	Peak
2499.08	40.86	38.84	54	-13.14	31.9	5.53	35.41	140	3	Average
4924	38.95	30.7	54	-15.05	33.99	8.28	34.02	167	124	Average
4924	48.08	39.83	74	-25.92	33.99	8.28	34.02	167	124	Peak

Antennal Polarity & Test Distance: Vertical at 3 m

Frequency (MHz)	Emission Level (dBuV/m)	Read Level (dBuV)	Limit (dBuV/m)	Margin (dB)	Antenna Factor (dB/m)	Cable Loss (dB)	Preamp Factor (dB)	Antenna Height (cm)	Table Angle (Degree)	Remark
2462	90.11	88.18			31.87	5.5	35.44	214	166	Average
2462	92.85	90.92			31.87	5.5	35.44	214	166	Peak
2485	40.93	38.94	54	-13.07	31.88	5.53	35.42	214	166	Average
2499.32	52.11	50.09	74	-21.89	31.9	5.53	35.41	214	166	Peak
4924	38.41	30.16	54	-15.59	33.99	8.28	34.02	136	107	Average
4924	47.96	39.71	74	-26.04	33.99	8.28	34.02	136	107	Peak

Remarks:

1. Emission Level = Read Level + Antenna Factor + Cable Loss - Preamp Factor

Margin value = Emission level – Limit value

2. 2462 MHz: Fundamental frequency.

802.11g

EUT Test Condition		Measurement Detail	
Channel	Channel 1	Frequency Range	1 GHz ~ 25 GHz
Input Power	120 Vac, 60 Hz	Detector Function	Peak (PK) Average (AV)
Environmental Conditions	25 deg. C, 65 % RH	Tested By	Karl Lee

Horizontal

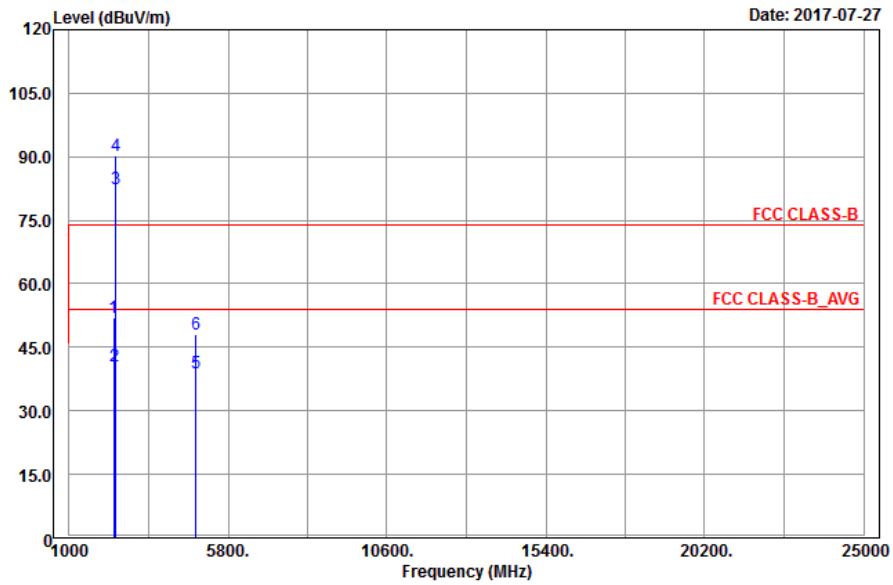

Vertical

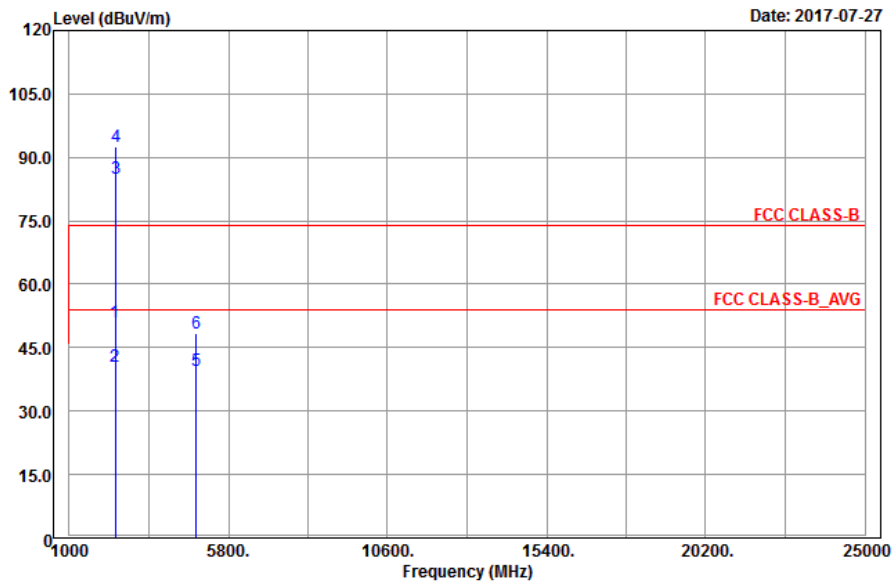

**Band Edge
Peak
Horizontal**

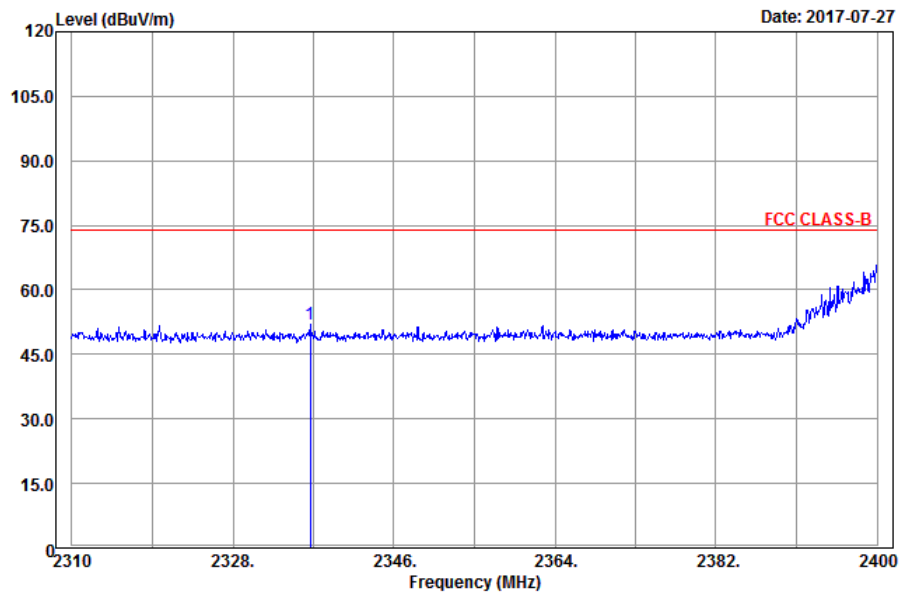

Vertical

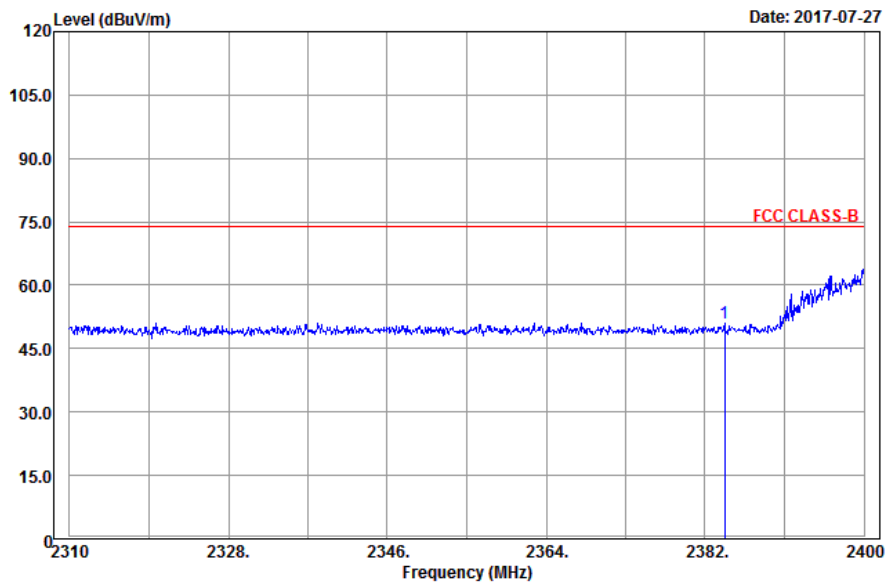

Average Horizontal

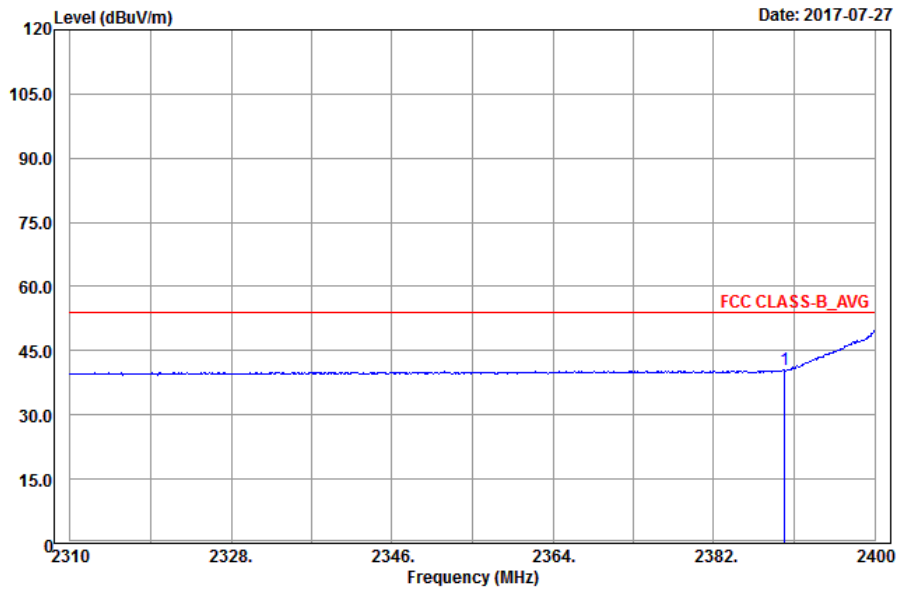

Vertical

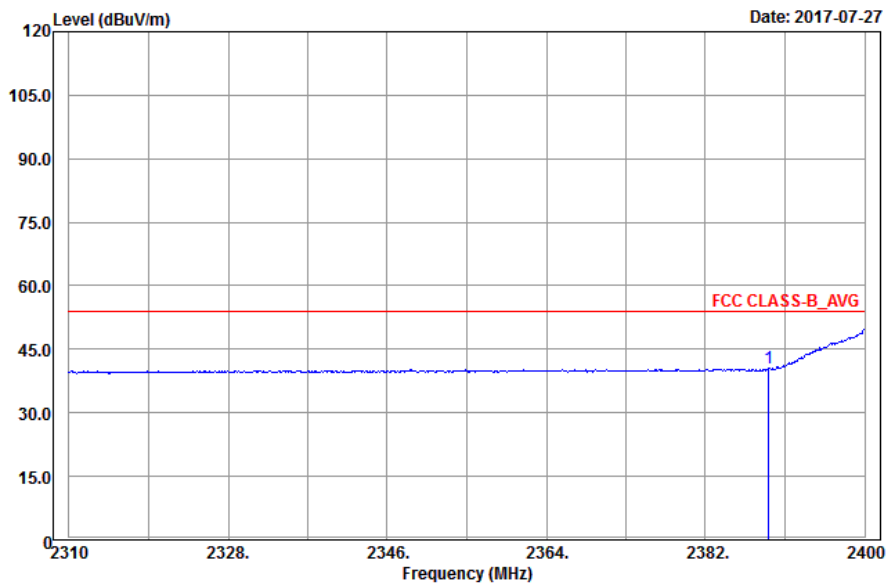

Antennal Polarity & Test Distance: Horizontal at 3 m

Frequency (MHz)	Emission Level (dBuV/m)	Read Level (dBuV)	Limit (dBuV/m)	Margin (dB)	Antenna Factor (dB/m)	Cable Loss (dB)	Preamp Factor (dB)	Antenna Height (cm)	Table Angle (Degree)	Remark
2336.64	51.98	50.43	74	-22.02	31.74	5.33	35.52	112	3	Peak
2389.92	40.54	38.81	54	-13.46	31.8	5.4	35.47	112	3	Average
2412	82.49	80.72			31.81	5.43	35.47	112	3	Average
2412	90.4	88.63			31.81	5.43	35.47	112	3	Peak
4824	38.82	30.69	54	-15.18	33.97	8.26	34.1	173	121	Average
4824	47.93	39.8	74	-26.07	33.97	8.26	34.1	173	121	Peak

Antennal Polarity & Test Distance: Vertical at 3 m

Frequency (MHz)	Emission Level (dBuV/m)	Read Level (dBuV)	Limit (dBuV/m)	Margin (dB)	Antenna Factor (dB/m)	Cable Loss (dB)	Preamp Factor (dB)	Antenna Height (cm)	Table Angle (Degree)	Remark
2384.25	51.15	49.46	74	-22.85	31.78	5.4	35.49	288	184	Peak
2389.2	40.46	38.75	54	-13.54	31.8	5.4	35.49	288	184	Average
2412	85.05	83.28			31.81	5.43	35.47	288	184	Average
2412	92.46	90.69			31.81	5.43	35.47	288	184	Peak
4824	39.41	31.28	54	-14.59	33.97	8.26	34.1	124	315	Average
4824	48.31	40.18	74	-25.69	33.97	8.26	34.1	124	315	Peak

Remarks:

- Emission Level = Read Level + Antenna Factor + Cable Loss - Preamp Factor
Margin value = Emission level – Limit value
- 2412 MHz: Fundamental frequency.

EUT Test Condition		Measurement Detail	
Channel	Channel 6	Frequency Range	1 GHz ~ 25 GHz
Input Power	120 Vac, 60 Hz	Detector Function	Peak (PK) Average (AV)
Environmental Conditions	25 deg. C, 65 % RH	Tested By	Karl Lee

Horizontal

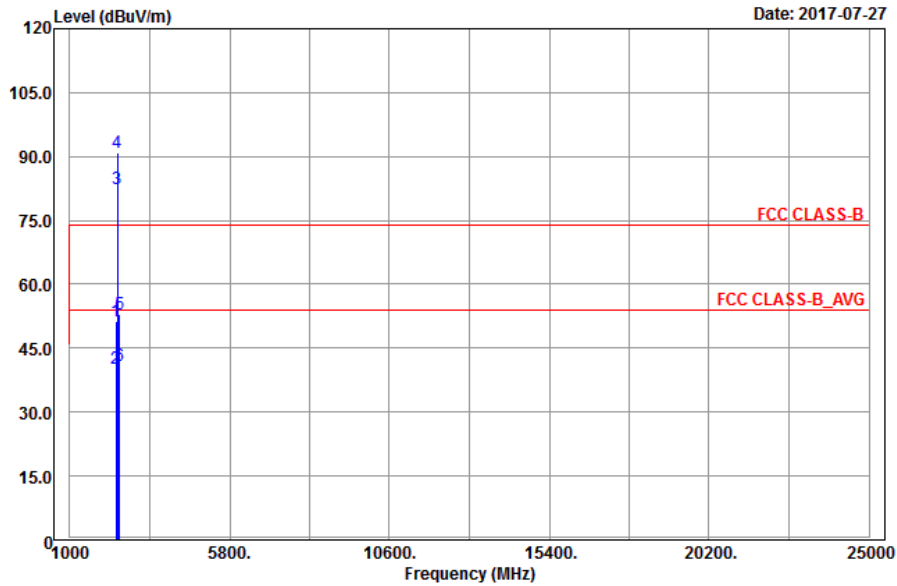

Vertical

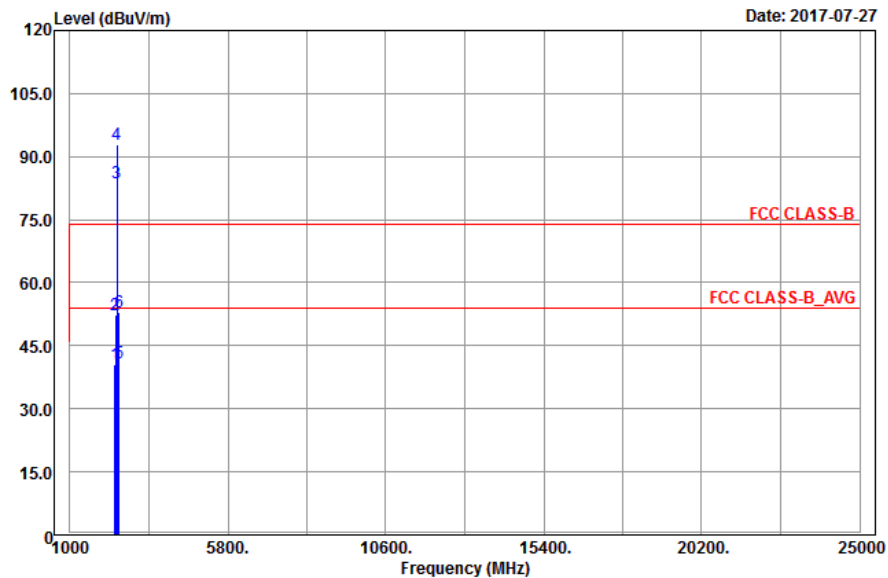

Antennal Polarity & Test Distance: Horizontal at 3 m

Frequency (MHz)	Emission Level (dBuV/m)	Read Level (dBuV)	Limit (dBuV/m)	Margin (dB)	Antenna Factor (dB/m)	Cable Loss (dB)	Preamp Factor (dB)	Antenna Height (cm)	Table Angle (Degree)	Remark
2377.95	51.33	49.67	74	-22.67	31.78	5.37	35.49	120	3	Peak
2385.69	40.26	38.55	54	-13.74	31.8	5.4	35.49	120	3	Average
2437	82.28	80.43			31.85	5.46	35.46	120	3	Average
2437	90.79	88.94			31.85	5.46	35.46	120	3	Peak
2485.96	52.81	50.82	74	-21.19	31.88	5.53	35.42	120	3	Peak
2494.96	40.91	38.89	54	-13.09	31.9	5.53	35.41	120	3	Average

Antennal Polarity & Test Distance: Vertical at 3 m

Frequency (MHz)	Emission Level (dBuV/m)	Read Level (dBuV)	Limit (dBuV/m)	Margin (dB)	Antenna Factor (dB/m)	Cable Loss (dB)	Preamp Factor (dB)	Antenna Height (cm)	Table Angle (Degree)	Remark
2377.23	40.4	38.74	54	-13.6	31.78	5.37	35.49	288	184	Average
2380.38	52.38	50.69	74	-21.62	31.78	5.4	35.49	288	184	Peak
2437	83.65	81.8			31.85	5.46	35.46	288	184	Average
2437	92.74	90.89			31.85	5.46	35.46	288	184	Peak
2483.6	40.85	38.89	54	-13.15	31.88	5.5	35.42	288	184	Average
2497.36	52.94	50.92	74	-21.06	31.9	5.53	35.41	288	184	Peak

Remarks:

- Emission Level = Read Level + Antenna Factor + Cable Loss - Preamp Factor
Margin value = Emission level – Limit value
- 2437 MHz: Fundamental frequency.

EUT Test Condition		Measurement Detail	
Channel	Channel 11	Frequency Range	1 GHz ~ 25 GHz
Input Power	120 Vac, 60 Hz	Detector Function	Peak (PK) Average (AV)
Environmental Conditions	25 deg. C, 65 % RH	Tested By	Karl Lee

Horizontal

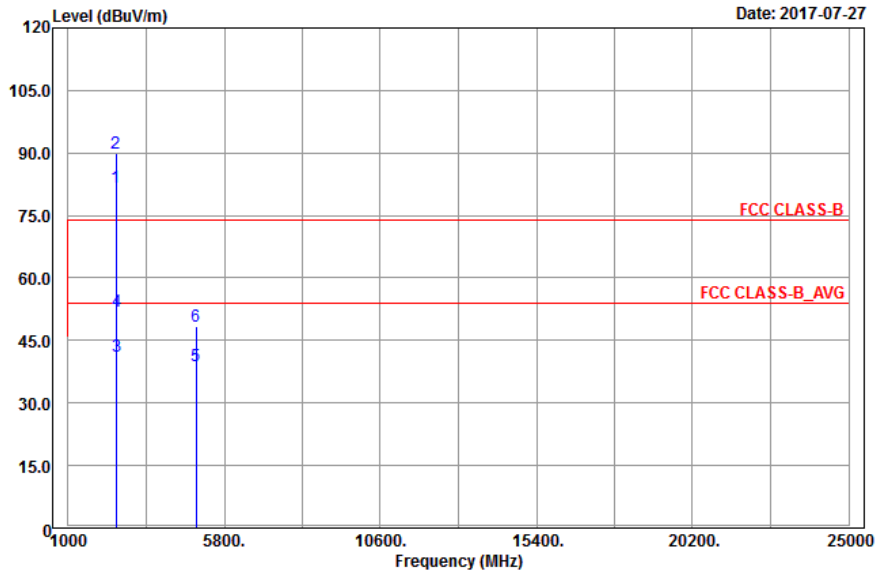

Vertical

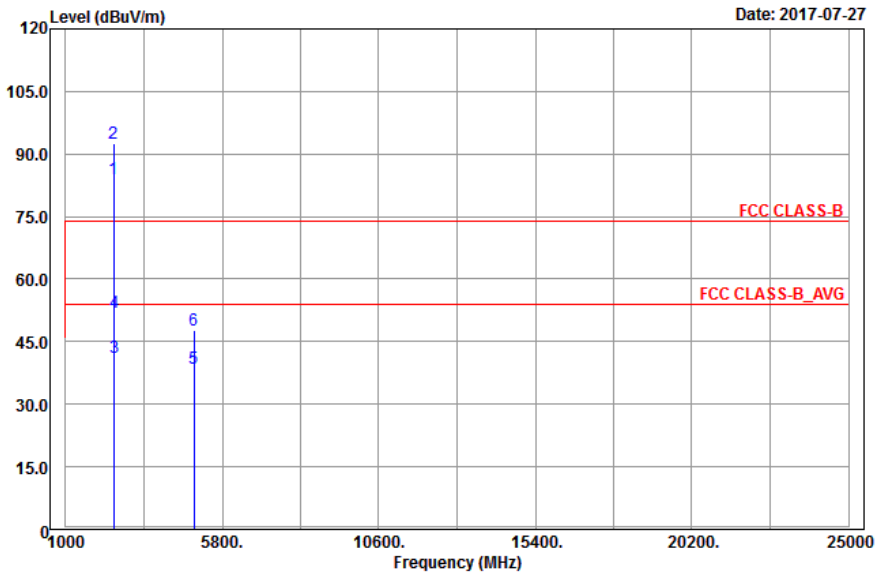

**Band Edge
Peak
Horizontal**

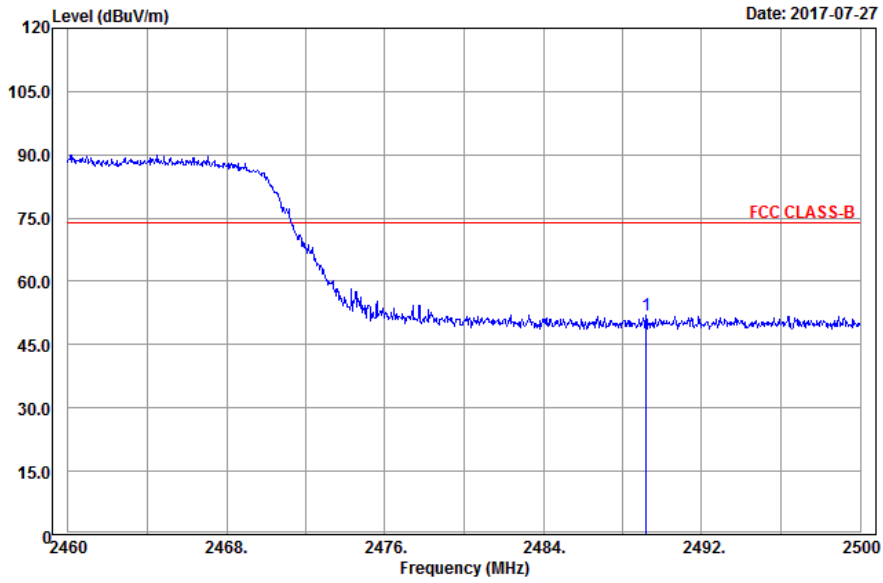

Vertical

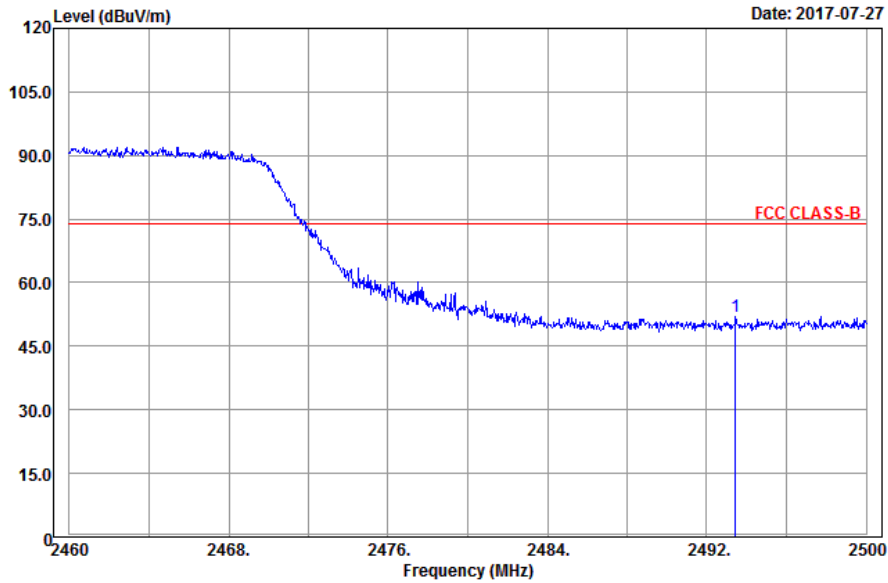

Average Horizontal

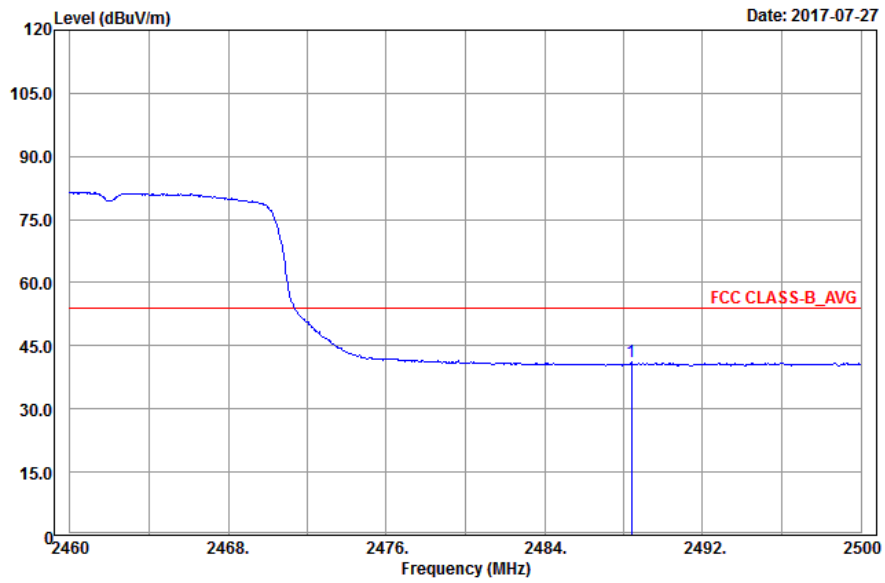

Vertical

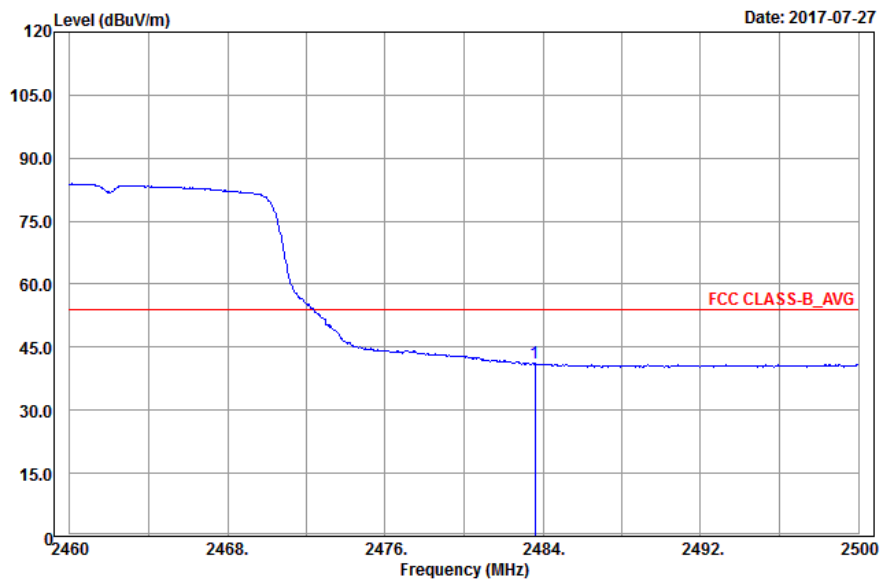

Antennal Polarity & Test Distance: Horizontal at 3 m										
Frequency (MHz)	Emission Level (dBuV/m)	Read Level (dBuV)	Limit (dBuV/m)	Margin (dB)	Antenna Factor (dB/m)	Cable Loss (dB)	Preamp Factor (dB)	Antenna Height (cm)	Table Angle (Degree)	Remark
2462	81.64	79.71			31.87	5.5	35.44	140	3	Average
2462	90.08	88.15			31.87	5.5	35.44	140	3	Peak
2488.4	41.1	39.09	54	-12.9	31.9	5.53	35.42	140	3	Average
2489.2	51.88	49.87	74	-22.12	31.9	5.53	35.42	140	3	Peak
4924	38.87	30.62	54	-15.13	33.99	8.28	34.02	134	288	Average
4924	48.32	40.07	74	-25.68	33.99	8.28	34.02	134	288	Peak
Antennal Polarity & Test Distance: Vertical at 3 m										
Frequency (MHz)	Emission Level (dBuV/m)	Read Level (dBuV)	Limit (dBuV/m)	Margin (dB)	Antenna Factor (dB/m)	Cable Loss (dB)	Preamp Factor (dB)	Antenna Height (cm)	Table Angle (Degree)	Remark
2462	83.97	82.04			31.87	5.5	35.44	214	166	Average
2462	92.65	90.72			31.87	5.5	35.44	214	166	Peak
2483.6	41.11	39.15	54	-12.89	31.88	5.5	35.42	214	166	Average
2493.44	52.06	50.04	74	-21.94	31.9	5.53	35.41	214	166	Peak
4924	38.72	30.47	54	-15.28	33.99	8.28	34.02	151	127	Average
4924	47.84	39.59	74	-26.16	33.99	8.28	34.02	151	127	Peak

Remarks:

- Emission Level = Read Level + Antenna Factor + Cable Loss - Preamp Factor
Margin value = Emission level – Limit value
- 2462 MHz: Fundamental frequency.

802.11n (HT20)

EUT Test Condition		Measurement Detail	
Channel	Channel 1	Frequency Range	1 GHz ~ 25 GHz
Input Power	120 Vac, 60 Hz	Detector Function	Peak (PK) Average (AV)
Environmental Conditions	25 deg. C, 65 % RH	Tested By	Karl Lee

Horizontal

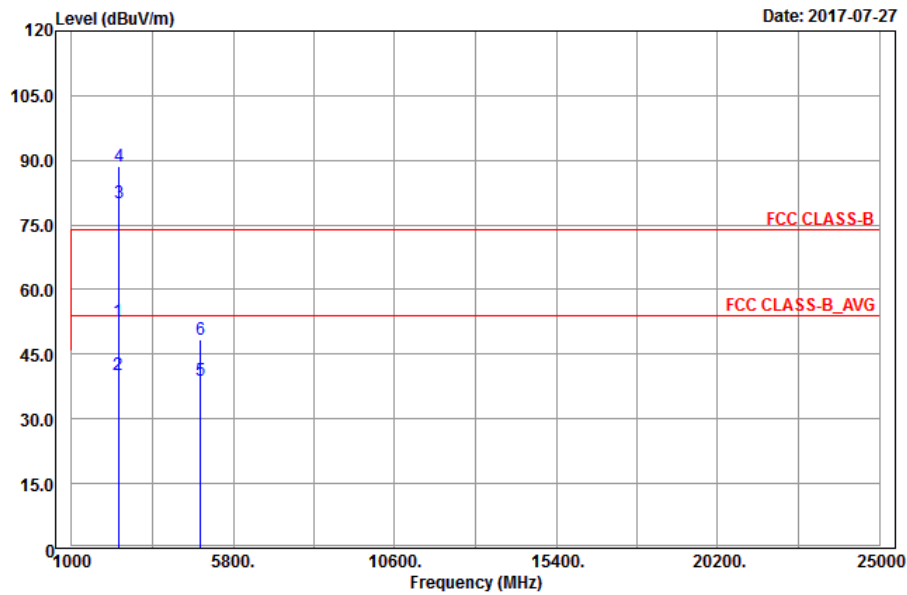

Vertical

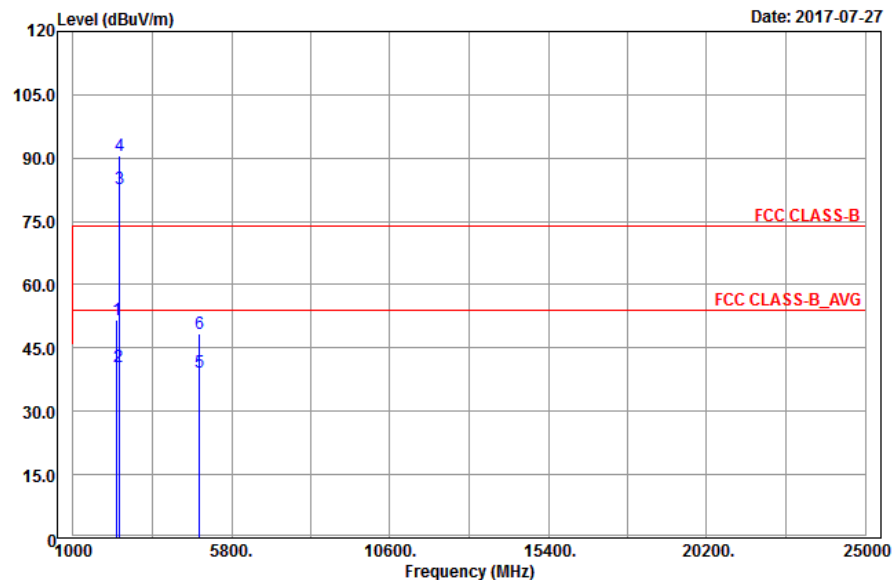

**Band Edge
Peak
Horizontal**

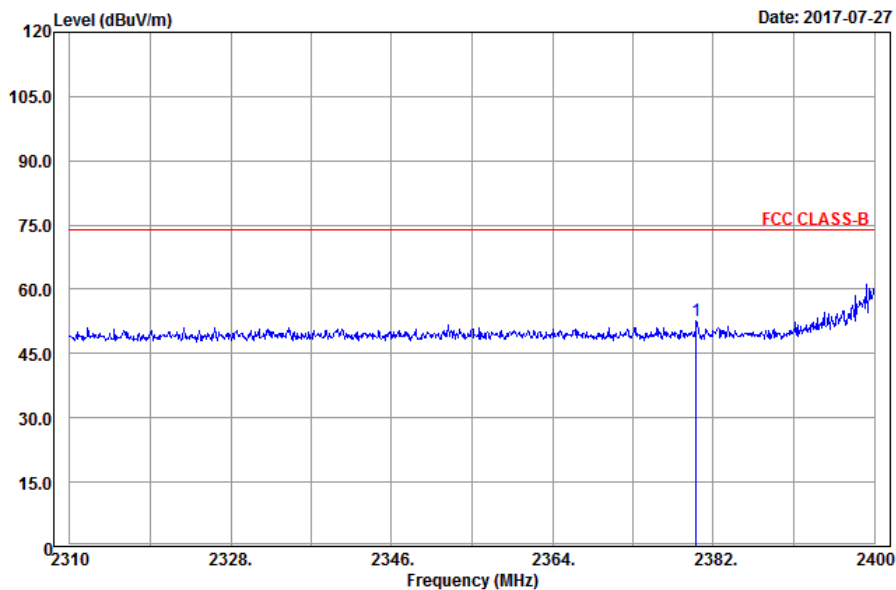

Vertical

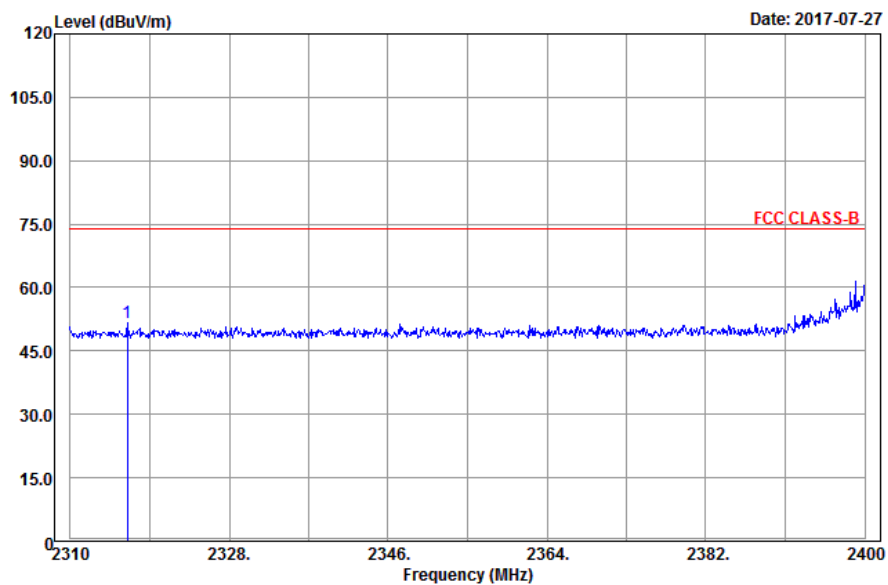

Average Horizontal

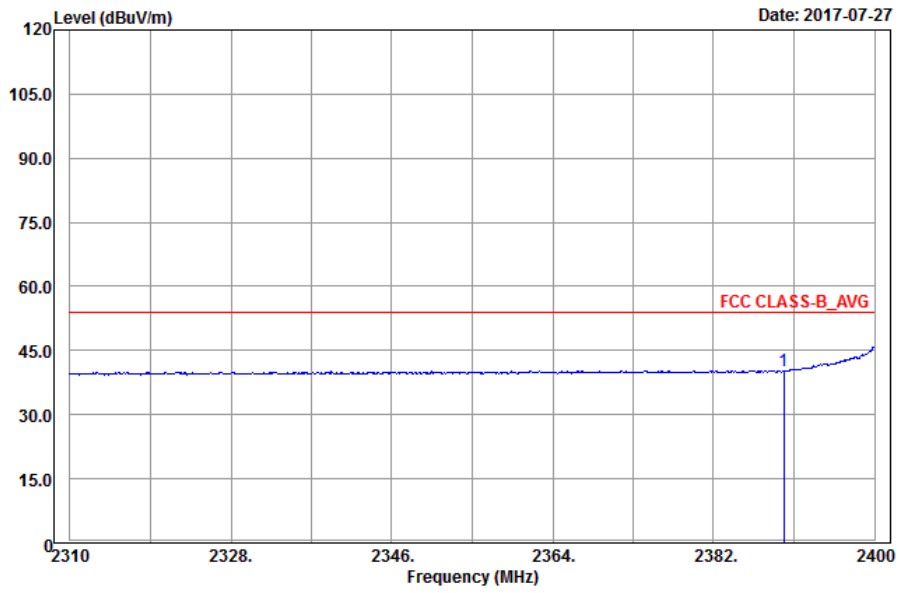

Vertical

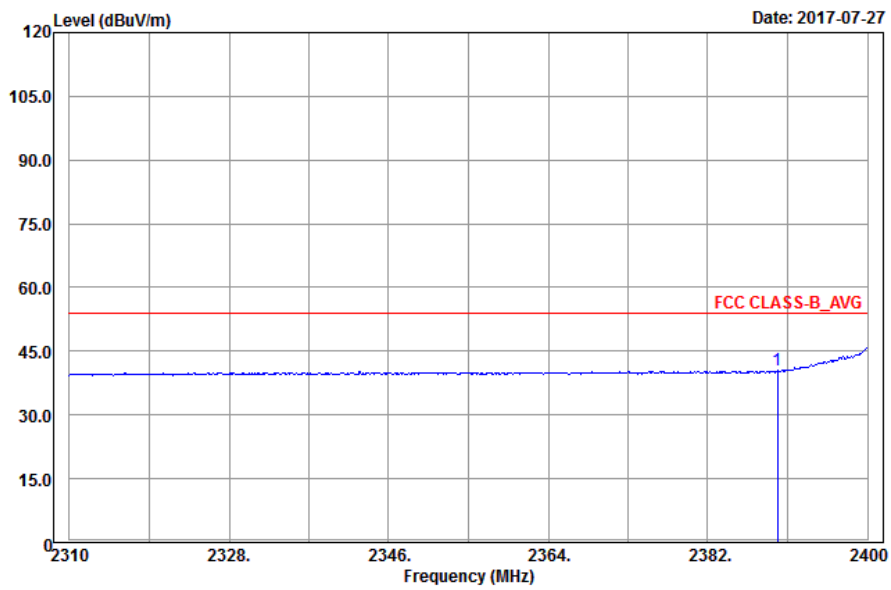

Antennal Polarity & Test Distance: Horizontal at 3 m

Frequency (MHz)	Emission Level (dBuV/m)	Read Level (dBuV)	Limit (dBuV/m)	Margin (dB)	Antenna Factor (dB/m)	Cable Loss (dB)	Preamp Factor (dB)	Antenna Height (cm)	Table Angle (Degree)	Remark
2380.11	52.57	50.91	74	-21.43	31.78	5.37	35.49	112	3	Peak
2389.83	40.33	38.6	54	-13.67	31.8	5.4	35.47	112	3	Average
2412	80.16	78.39			31.81	5.43	35.47	112	3	Average
2412	88.53	86.76			31.81	5.43	35.47	112	3	Peak
4824	39.06	30.93	54	-14.94	33.97	8.26	34.1	148	64	Average
4824	48.26	40.13	74	-25.74	33.97	8.26	34.1	148	64	Peak

Antennal Polarity & Test Distance: Vertical at 3 m

Frequency (MHz)	Emission Level (dBuV/m)	Read Level (dBuV)	Limit (dBuV/m)	Margin (dB)	Antenna Factor (dB/m)	Cable Loss (dB)	Preamp Factor (dB)	Antenna Height (cm)	Table Angle (Degree)	Remark
2316.48	51.56	50.07	74	-22.44	31.71	5.3	35.52	288	184	Peak
2389.83	40.41	38.68	54	-13.59	31.8	5.4	35.47	288	184	Average
2412	82.83	81.06			31.81	5.43	35.47	288	184	Average
2412	90.52	88.75			31.81	5.43	35.47	288	184	Peak
4824	39.21	31.08	54	-14.79	33.97	8.26	34.1	161	227	Average
4824	48.41	40.28	74	-25.59	33.97	8.26	34.1	161	227	Peak

Remarks:

1. Emission Level = Read Level + Antenna Factor + Cable Loss - Preamp Factor

Margin value = Emission level – Limit value

2. 2412 MHz: Fundamental frequency.

EUT Test Condition		Measurement Detail	
Channel	Channel 6	Frequency Range	1 GHz ~ 25 GHz
Input Power	120 Vac, 60 Hz	Detector Function	Peak (PK) Average (AV)
Environmental Conditions	25 deg. C, 65 % RH	Tested By	Karl Lee

Horizontal

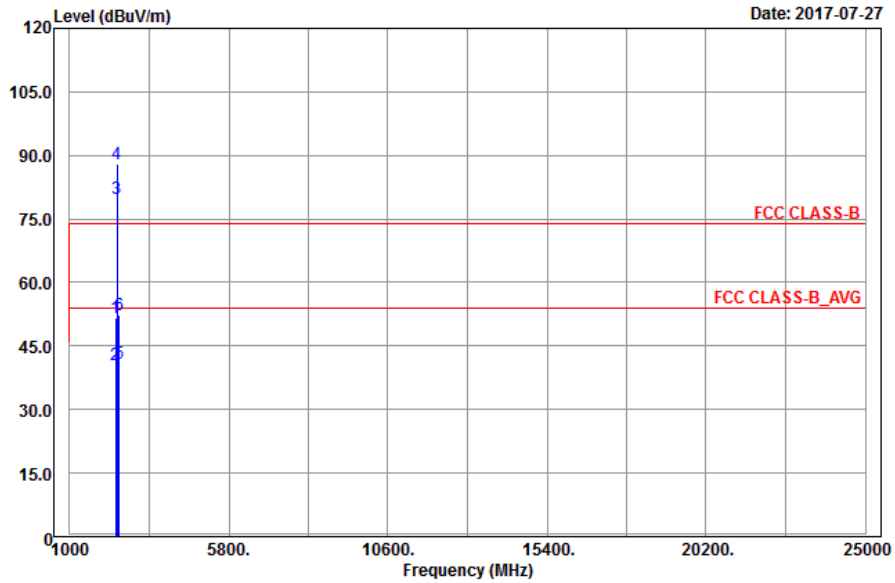

Vertical

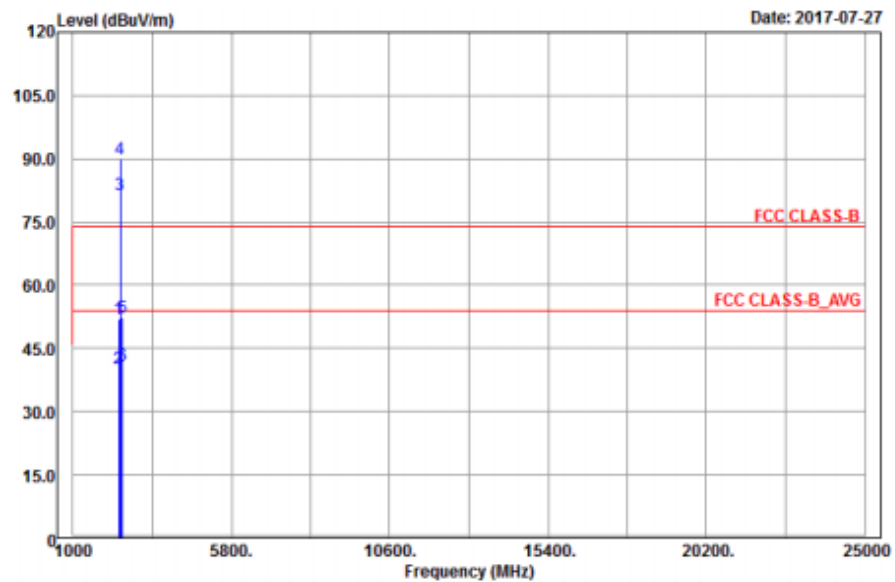

Antennal Polarity & Test Distance: Horizontal at 3 m

Frequency (MHz)	Emission Level (dBuV/m)	Read Level (dBuV)	Limit (dBuV/m)	Margin (dB)	Antenna Factor (dB/m)	Cable Loss (dB)	Preamp Factor (dB)	Antenna Height (cm)	Table Angle (Degree)	Remark
2379.12	51.78	50.12	74	-22.22	31.78	5.37	35.49	120	3	Peak
2382.81	40.44	38.75	54	-13.56	31.78	5.4	35.49	120	3	Average
2437	79.74	77.89			31.85	5.46	35.46	120	3	Average
2437	88.01	86.16			31.85	5.46	35.46	120	3	Peak
2486.44	41.02	39.03	54	-12.98	31.88	5.53	35.42	120	3	Average
2489.88	52.4	50.39	74	-21.6	31.9	5.53	35.42	120	3	Peak

Antennal Polarity & Test Distance: Vertical at 3 m

Frequency (MHz)	Emission Level (dBuV/m)	Read Level (dBuV)	Limit (dBuV/m)	Margin (dB)	Antenna Factor (dB/m)	Cable Loss (dB)	Preamp Factor (dB)	Antenna Height (cm)	Table Angle (Degree)	Remark
2385.42	52	50.31	74	-22	31.78	5.4	35.49	288	184	Peak
2389.2	40.26	38.55	54	-13.74	31.8	5.4	35.49	288	184	Average
2437	81.49	79.64			31.85	5.46	35.46	288	184	Average
2437	89.98	88.13			31.85	5.46	35.46	288	184	Peak
2487.28	52.26	50.27	74	-21.74	31.88	5.53	35.42	288	184	Peak
2499.8	40.94	38.92	54	-13.06	31.9	5.53	35.41	288	184	Average

Remarks:

- Emission Level = Read Level + Antenna Factor + Cable Loss - Preamp Factor
Margin value = Emission level – Limit value
- 2437 MHz: Fundamental frequency.

EUT Test Condition		Measurement Detail	
Channel	Channel 11	Frequency Range	1 GHz ~ 25 GHz
Input Power	120 Vac, 60 Hz	Detector Function	Peak (PK) Average (AV)
Environmental Conditions	25 deg. C, 65 % RH	Tested By	Karl Lee

Horizontal

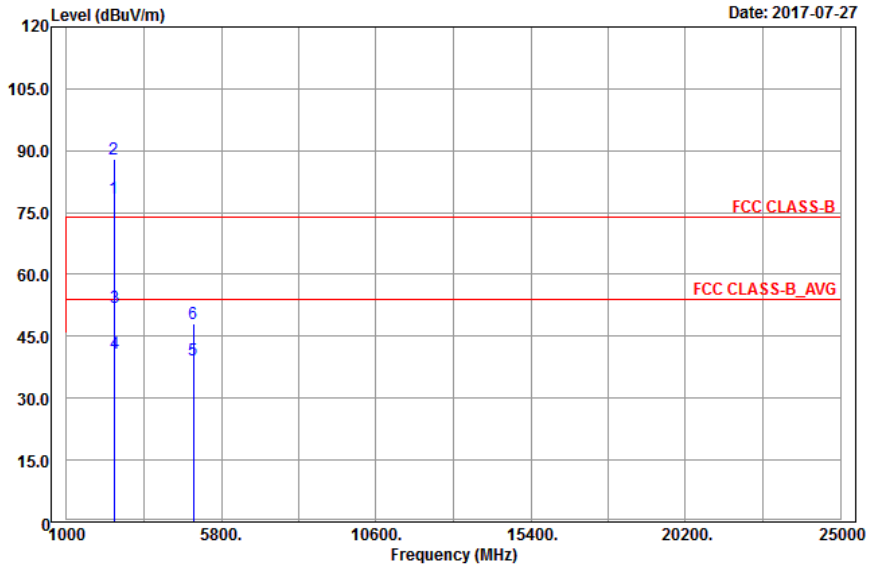

Vertical

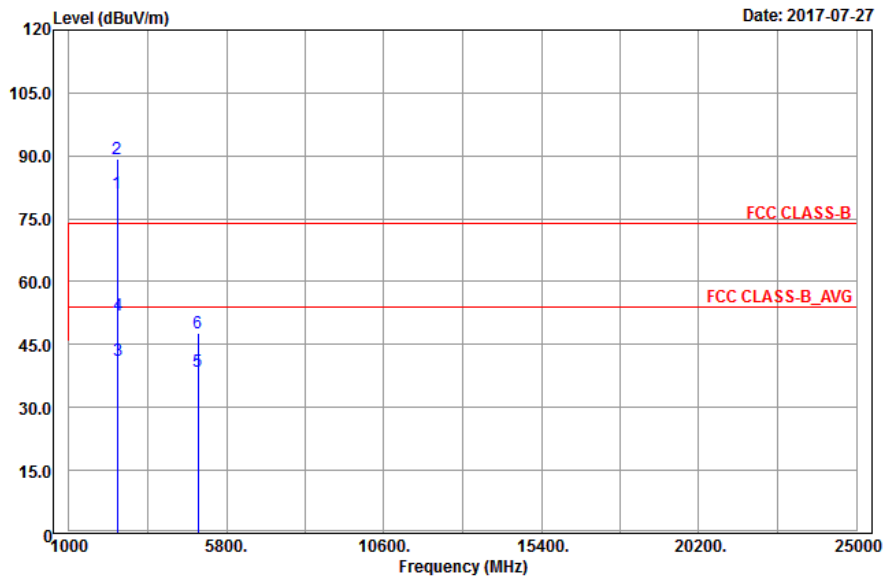

**Band Edge
Peak
Horizontal**

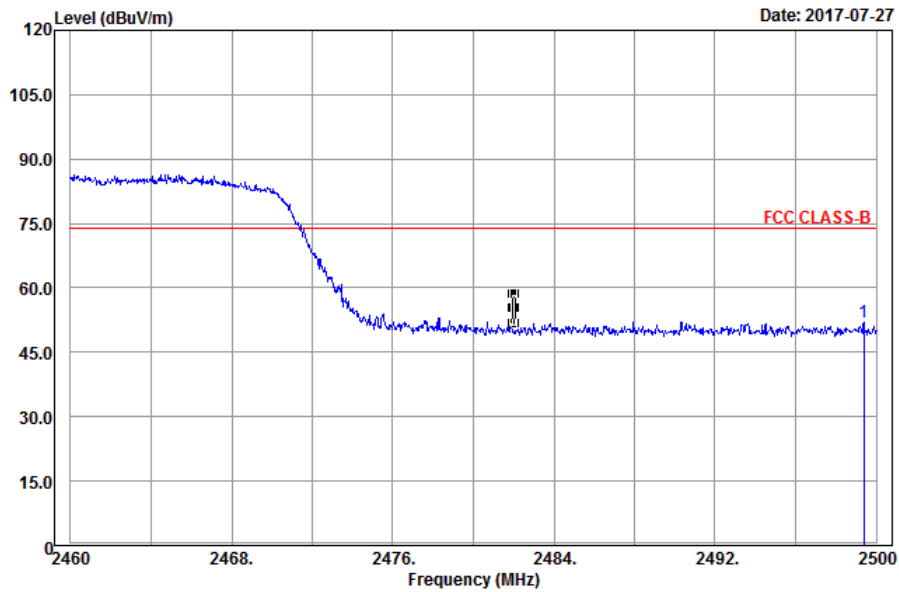

Vertical

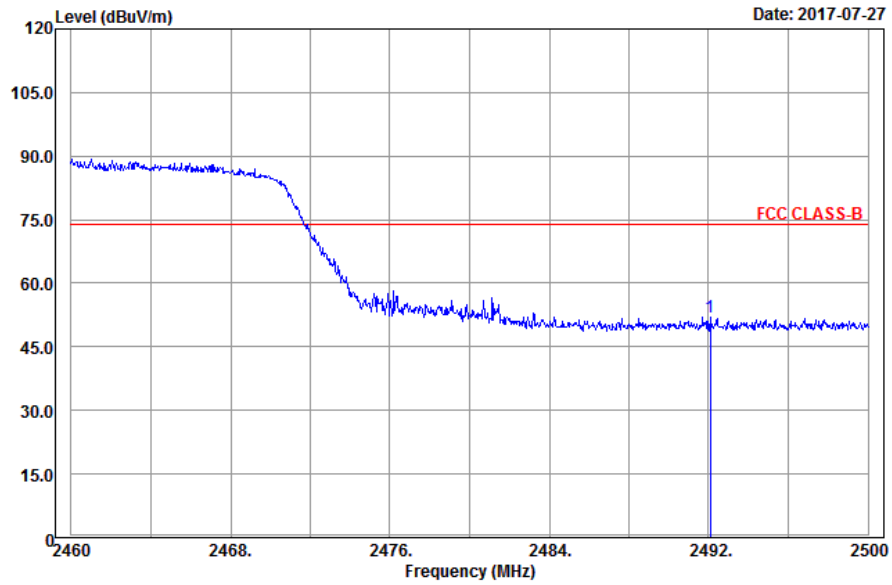

Average Horizontal

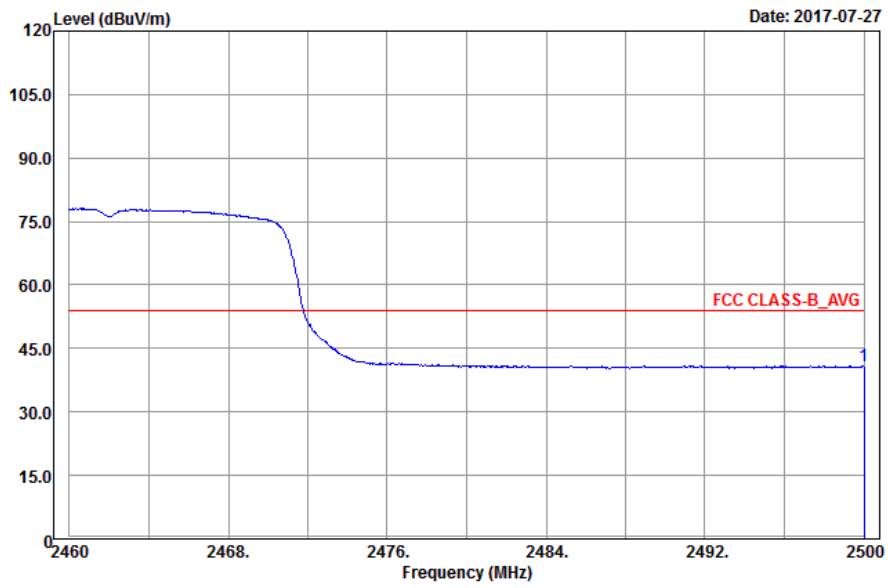

Vertical

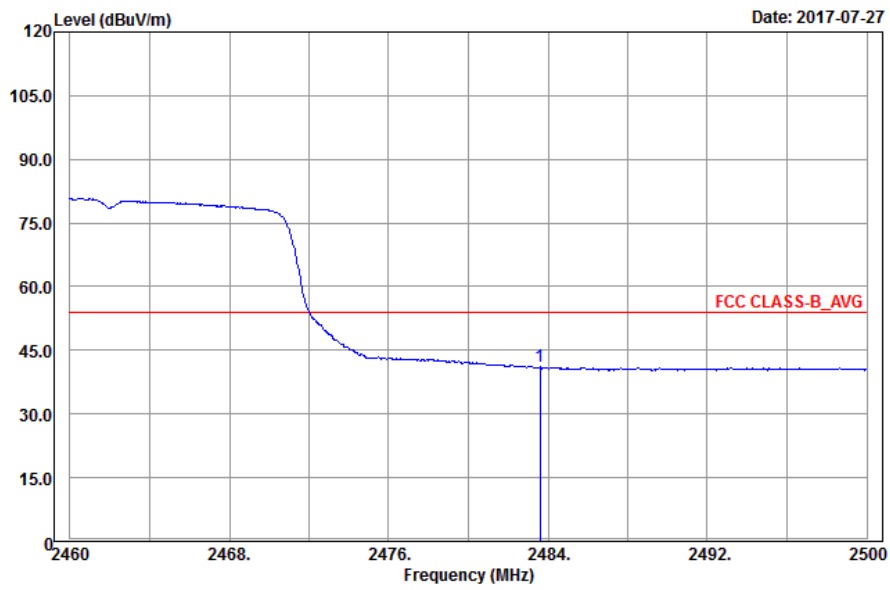

Antennal Polarity & Test Distance: Horizontal at 3 m										
Frequency (MHz)	Emission Level (dBuV/m)	Read Level (dBuV)	Limit (dBuV/m)	Margin (dB)	Antenna Factor (dB/m)	Cable Loss (dB)	Preamp Factor (dB)	Antenna Height (cm)	Table Angle (Degree)	Remark
2462	78.36	76.43			31.87	5.5	35.44	140	3	Average
2462	87.85	85.92			31.87	5.5	35.44	140	3	Peak
2499.4	52.1	50.08	74	-21.9	31.9	5.53	35.41	140	3	Peak
2500	40.93	38.91	54	-13.07	31.9	5.53	35.41	140	3	Average
4924	39.23	30.98	54	-14.77	33.99	8.28	34.02	106	234	Average
4924	48.17	39.92	74	-25.83	33.99	8.28	34.02	106	234	Peak
Antennal Polarity & Test Distance: Vertical at 3 m										
Frequency (MHz)	Emission Level (dBuV/m)	Read Level (dBuV)	Limit (dBuV/m)	Margin (dB)	Antenna Factor (dB/m)	Cable Loss (dB)	Preamp Factor (dB)	Antenna Height (cm)	Table Angle (Degree)	Remark
2462	80.93	79			31.87	5.5	35.44	214	166	Average
2462	89.18	87.25			31.87	5.5	35.44	214	166	Peak
2483.6	41.04	39.08	54	-12.96	31.88	5.5	35.42	214	166	Average
2492.08	52.11	50.09	74	-21.89	31.9	5.53	35.41	214	166	Peak
4924	38.53	30.28	54	-15.47	33.99	8.28	34.02	146	171	Average
4924	47.82	39.57	74	-26.18	33.99	8.28	34.02	146	171	Peak

Remarks:

- Emission Level = Read Level + Antenna Factor + Cable Loss - Preamp Factor
Margin value = Emission level – Limit value
- 2462 MHz: Fundamental frequency.

9 kHz ~ 30 MHz DATA:

The amplitude of spurious emissions attenuated more than 20 dB below the permissible value is not required to be report.

30 MHz ~ 1 GHz WORST-CASE DATA:

Mode A

802.11g

EUT Test Condition		Measurement Detail	
Channel	Channel 6	Frequency Range	30 MHz ~ 1 GHz
Input Power	120 Vac, 60 Hz	Detector Function	Peak (PK) Quasi-peak (QP)
Environmental Conditions	25 deg. C, 65 % RH	Tested By	Charles Hsiao

Horizontal

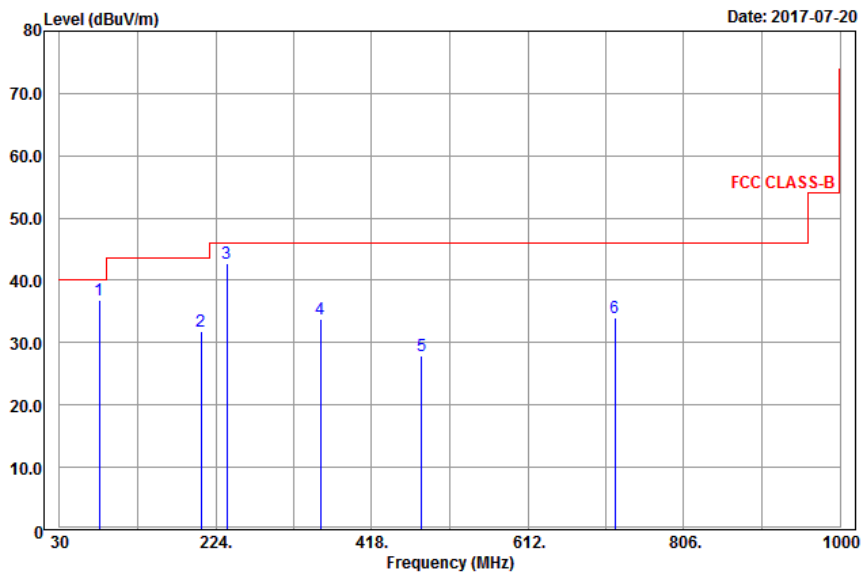

Vertical

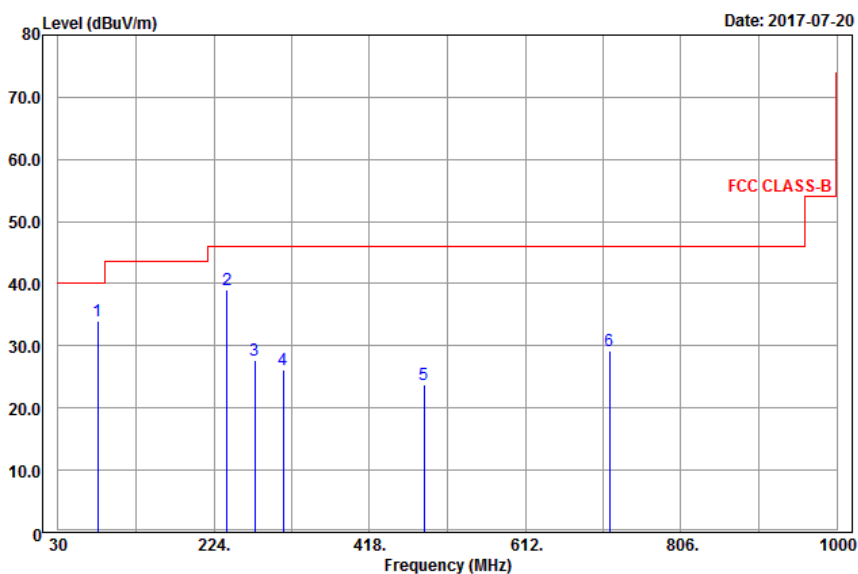

Antennal Polarity & Test Distance: Horizontal at 3 m

Frequency (MHz)	Emission Level (dBuV/m)	Read Level (dBuV)	Limit (dBuV/m)	Margin (dB)	Antenna Factor (dB/m)	Cable Loss (dB)	Preamp Factor (dB)	Antenna Height (cm)	Table Angle (Degree)	Remark
79.41	36.94	59.78	40	-3.06	8.26	1.11	32.21	147	315	Peak
205.5	31.79	51.29	43.5	-11.71	11.12	1.65	32.27	198	88	Peak
238.17	42.81	61.05	46	-3.19	12.05	1.85	32.14	110	0	QP
353.9	33.77	49.39	46	-12.23	14.27	2.19	32.08	105	104	Peak
479.9	28	41.49	46	-18	16.07	2.56	32.12	197	154	Peak
720.7	33.92	43.35	46	-12.08	19.52	3.16	32.11	125	204	Peak

Antennal Polarity & Test Distance: Vertical at 3 m

Frequency (MHz)	Emission Level (dBuV/m)	Read Level (dBuV)	Limit (dBuV/m)	Margin (dB)	Antenna Factor (dB/m)	Cable Loss (dB)	Preamp Factor (dB)	Antenna Height (cm)	Table Angle (Degree)	Remark
79.14	33.97	56.81	40	-6.03	8.26	1.11	32.21	188	111	Peak
240.06	38.92	57.1	46	-7.08	12.1	1.85	32.13	191	132	Peak
275.16	27.75	45.24	46	-18.25	12.69	1.94	32.12	105	116	Peak
310.5	26.12	42.83	46	-19.88	13.3	2.11	32.12	175	310	Peak
486.2	23.69	37.02	46	-22.31	16.15	2.63	32.11	152	161	Peak
717.2	29.22	38.75	46	-16.78	19.47	3.11	32.11	122	220	Peak

Remarks:

- Emission Level = Read Level + Antenna Factor + Cable Loss - Preamp Factor
 Margin value = Emission level – Limit value

Mode B
802.11g

EUT Test Condition		Measurement Detail	
Channel	Channel 11	Frequency Range	30 MHz ~ 1 GHz
Input Power	120 Vac, 60 Hz	Detector Function	Peak (PK) Quasi-peak (QP)
Environmental Conditions	25 deg. C, 65 % RH	Tested By	Charles Hsiao

Horizontal

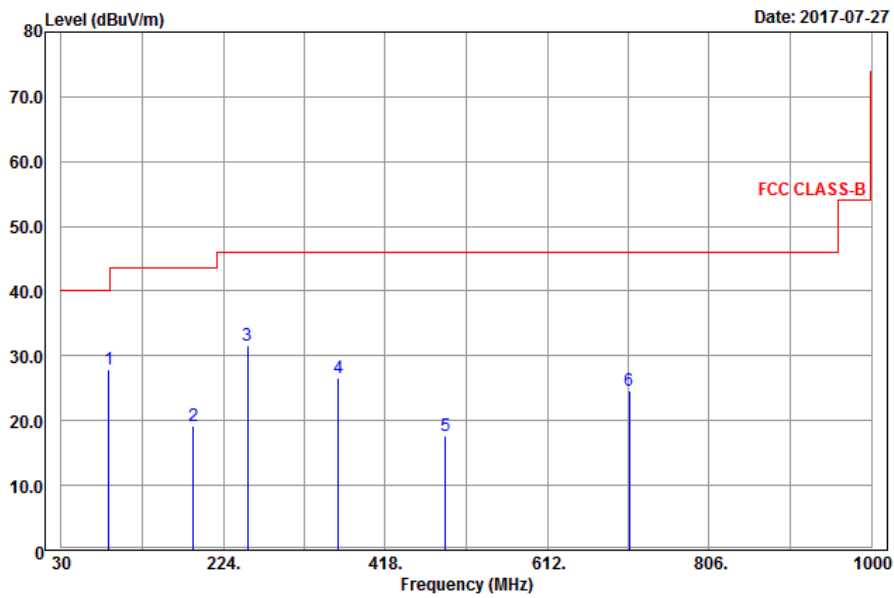

Vertical

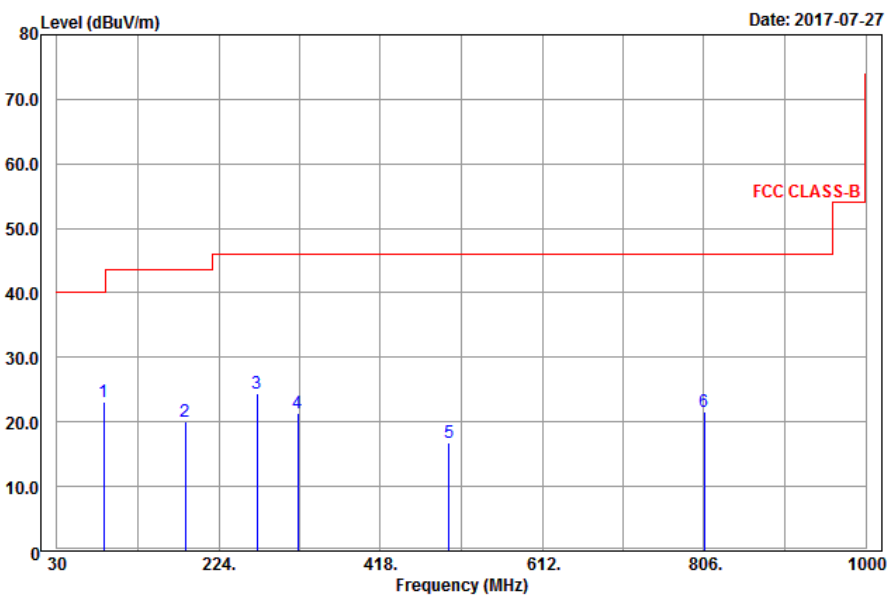

Antennal Polarity & Test Distance: Horizontal at 3 m

Frequency (MHz)	Emission Level (dBuV/m)	Read Level (dBuV)	Limit (dBuV/m)	Margin (dB)	Antenna Factor (dB/m)	Cable Loss (dB)	Preamp Factor (dB)	Antenna Height (cm)	Table Angle (Degree)	Remark
87.24	27.91	48.96	40	-12.09	9.7	1.11	31.86	164	113	Peak
187.95	19.1	39.29	43.5	-24.4	10.45	1.61	32.25	173	166	Peak
252.75	31.67	49.46	46	-14.33	12.37	1.94	32.1	190	244	Peak
362.3	26.63	42.1	46	-19.37	14.38	2.26	32.11	151	137	Peak
490.4	17.71	30.97	46	-28.29	16.22	2.63	32.11	167	125	Peak
710.2	24.57	34.18	46	-21.43	19.38	3.11	32.1	108	246	Peak

Antennal Polarity & Test Distance: Vertical at 3 m

Frequency (MHz)	Emission Level (dBuV/m)	Read Level (dBuV)	Limit (dBuV/m)	Margin (dB)	Antenna Factor (dB/m)	Cable Loss (dB)	Preamp Factor (dB)	Antenna Height (cm)	Table Angle (Degree)	Remark
86.43	23.15	44.51	40	-16.85	9.44	1.11	31.91	139	127	Peak
184.17	19.99	40.51	43.5	-23.51	10.11	1.61	32.24	195	225	Peak
269.76	24.35	41.89	46	-21.65	12.63	1.94	32.11	163	120	Peak
318.9	21.4	37.91	46	-24.6	13.49	2.11	32.11	185	132	Peak
500.2	16.75	29.86	46	-29.25	16.36	2.63	32.1	163	325	Peak
806.8	21.64	29.9	46	-24.36	20.44	3.32	32.02	104	117	Peak

Remarks:

- Emission Level = Read Level + Antenna Factor + Cable Loss - Preamp Factor
Margin value = Emission level – Limit value

4.2 Conducted Emission Measurement

4.2.1 Limits of Conducted Emission Measurement

Frequency (MHz)	Conducted Limit (dBuV)	
	Quasi-peak	Average
0.15 - 0.5	66 - 56	56 - 46
0.50 - 5.0	56	46
5.0 - 30.0	60	50

Note: 1. The lower limit shall apply at the transition frequencies.

2. The limit decreases in line with the logarithm of the frequency in the range of 0.15 to 0.50 MHz.

4.2.2 Test Instruments

Description & Manufacturer	Model No.	Serial No.	Date of Calibration	Due Date of Calibration
Test Receiver ROHDE & SCHWARZ	ESCI	100613	Nov. 21, 2016	Nov. 20, 2017
RF signal cable Woken	5D-FB	Cable-cond1-01	Dec. 22, 2016	Dec. 21, 2017
LISN ROHDE & SCHWARZ (EUT)	ESH3-Z5	835239/001	Mar. 10, 2017	Mar. 09, 2018
LISN ROHDE & SCHWARZ (Peripheral)	ESH3-Z5	100311	Jul. 28, 2016	Jul. 27, 2017
Software ADT	BV ADT_Cond_ V7.3.7.3	NA	NA	NA

Note: 1. The calibration interval of the above test instruments is 12 months and the calibrations are traceable to NML/ROC and NIST/USA.

2. The test was performed in HwaYa Shielded Room 1.

3. The VCCI Site Registration No. is C-2040.

4.2.3 Test Procedures

- a. The EUT was placed 0.4 meters from the conducting wall of the shielded room with EUT being connected to the power mains through a line impedance stabilization network (LISN). Other support units were connected to the power mains through another LISN. The two LISNs provide 50 ohm/50 uH of coupling impedance for the measuring instrument.
- b. Both lines of the power mains connected to the EUT were checked for maximum conducted interference.
- c. The frequency range from 150 kHz to 30 MHz was searched. Emission levels under (Limit – 20 dB) was not recorded.

NOTE: All modes of operation were investigated and the worst-case emissions are reported.

4.2.4 Deviation from Test Standard

No deviation.

4.2.5 Test Setup

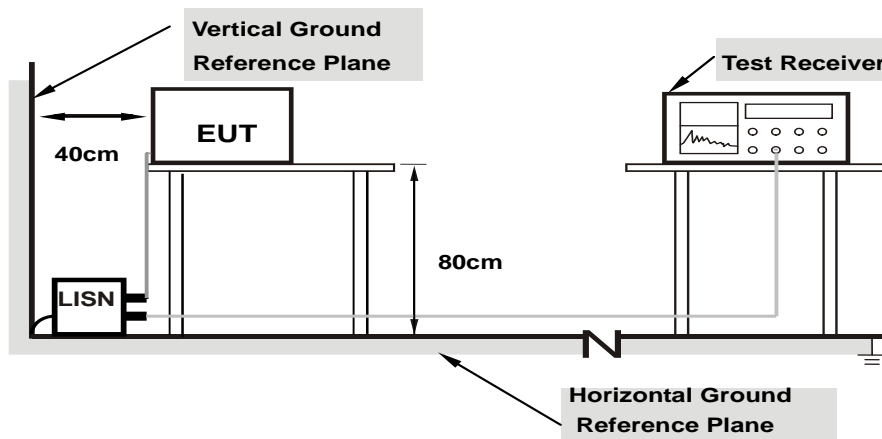

Note: 1. Support units were connected to second LISN.

For the actual test configuration, please refer to the attached file (Test Setup Photo).

4.2.6 EUT Operating Conditions

- a. Placed the EUT on a testing table.
- b. Use the software to control the EUT under transmission condition continuously at specific channel frequency.

4.2.7 Test Results

Mode A

Frequency Range	150kHz ~ 30MHz	Detector Function & Resolution Bandwidth	Quasi-Peak (QP) / Average (AV), 9kHz
Input Power	120Vac, 60Hz	Environmental Conditions	25°C, 65%RH
Tested by	Getaz Yang	Test Date	2017/7/21

Phase Of Power : Line (L)										
No	Frequency (MHz)	Correction Factor (dB)	Reading Value (dBuV)		Emission Level (dBuV)		Limit (dBuV)		Margin (dB)	
			Q.P.	AV.	Q.P.	AV.	Q.P.	AV.	Q.P.	AV.
1	0.15391	10.35	27.44	14.46	37.79	24.81	65.79	55.79	-28.00	-30.98
2	0.19692	10.37	19.05	1.35	29.42	11.72	63.74	53.74	-34.32	-42.02
3	0.55679	10.40	26.90	17.79	37.30	28.19	56.00	46.00	-18.70	-17.81
4	0.77169	10.40	20.68	11.09	31.08	21.49	56.00	46.00	-24.92	-24.51
5	3.04340	10.52	14.80	9.15	25.32	19.67	56.00	46.00	-30.68	-26.33
6	7.44225	10.72	15.26	10.46	25.98	21.18	60.00	50.00	-34.02	-28.82

Remarks:

1. Q.P. and AV. are abbreviations of quasi-peak and average individually.
2. The emission levels of other frequencies were very low against the limit.
3. Margin value = Emission level – Limit value
4. Correction factor = Insertion loss + Cable loss
5. Emission Level = Correction Factor + Reading Value

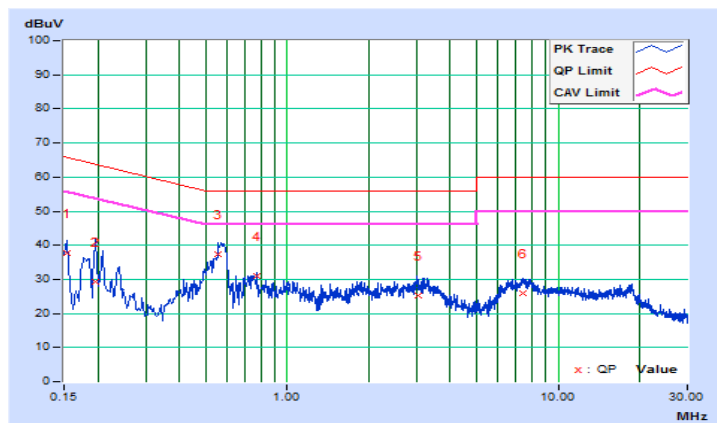

Frequency Range	150kHz ~ 30MHz	Detector Function & Resolution Bandwidth	Quasi-Peak (QP) / Average (AV), 9kHz
Input Power	120Vac, 60Hz	Environmental Conditions	25°C, 65%RH
Tested by	Getaz Yang	Test Date	2017/7/21

Phase Of Power : Neutral (N)										
No	Frequency (MHz)	Correction Factor (dB)	Reading Value (dBuV)		Emission Level (dBuV)		Limit (dBuV)		Margin (dB)	
			Q.P.	AV.	Q.P.	AV.	Q.P.	AV.	Q.P.	AV.
1	0.15000	10.10	30.15	20.54	40.25	30.64	66.00	56.00	-25.75	-25.36
2	0.17237	10.12	28.11	11.39	38.23	21.51	64.85	54.85	-26.62	-33.34
3	0.22429	10.14	19.31	2.00	29.45	12.14	62.66	52.66	-33.21	-40.52
4	0.58792	10.16	27.27	19.31	37.43	29.47	56.00	46.00	-18.57	-16.53
5	3.25845	10.30	14.87	9.51	25.17	19.81	56.00	46.00	-30.83	-26.19
6	7.47734	10.46	16.05	10.70	26.51	21.16	60.00	50.00	-33.49	-28.84

Remarks:

1. Q.P. and AV. are abbreviations of quasi-peak and average individually.
2. The emission levels of other frequencies were very low against the limit.
3. Margin value = Emission level – Limit value
4. Correction factor = Insertion loss + Cable loss
5. Emission Level = Correction Factor + Reading Value

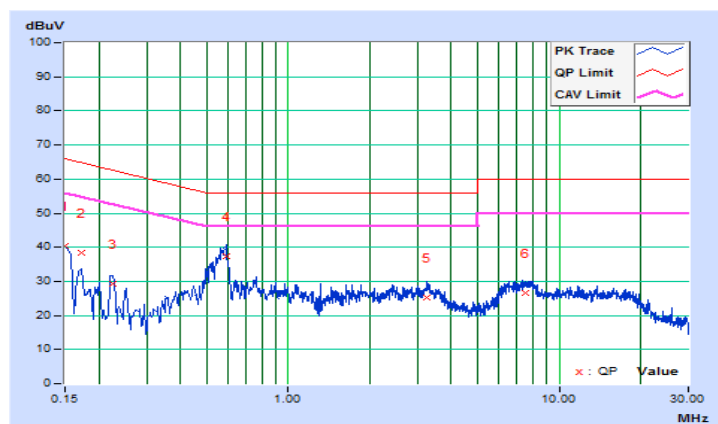

Mode B

Frequency Range	150kHz ~ 30MHz	Detector Function & Resolution Bandwidth	Quasi-Peak (QP) / Average (AV), 9kHz
Input Power	120Vac, 60Hz	Environmental Conditions	25°C, 65%RH
Tested by	Getaz Yang	Test Date	2017/7/25

Phase Of Power : Line (L)										
No	Frequency (MHz)	Correction Factor (dB)	Reading Value (dBuV)		Emission Level (dBuV)		Limit (dBuV)		Margin (dB)	
			Q.P.	AV.	Q.P.	AV.	Q.P.	AV.	Q.P.	AV.
1	0.15391	10.35	39.44	19.24	49.79	29.59	65.79	55.79	-16.00	-26.20
2	0.16564	10.35	39.62	23.95	49.97	34.30	65.18	55.18	-15.21	-20.88
3	0.22429	10.37	32.54	19.89	42.91	30.26	62.66	52.66	-19.75	-22.40
4	0.44325	10.40	23.36	12.48	33.76	22.88	57.00	47.00	-23.24	-24.12
5	1.69054	10.44	15.33	9.21	25.77	19.65	56.00	46.00	-30.23	-26.35
6	3.81367	10.56	11.31	5.83	21.87	16.39	56.00	46.00	-34.13	-29.61

Remarks:

1. Q.P. and AV. are abbreviations of quasi-peak and average individually.
2. The emission levels of other frequencies were very low against the limit.
3. Margin value = Emission level – Limit value
4. Correction factor = Insertion loss + Cable loss
5. Emission Level = Correction Factor + Reading Value

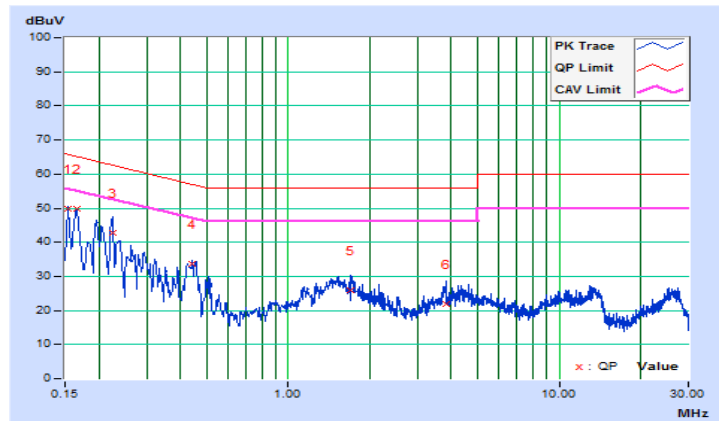

Frequency Range	150kHz ~ 30MHz	Detector Function & Resolution Bandwidth	Quasi-Peak (QP) / Average (AV), 9kHz
Input Power	120Vac, 60Hz	Environmental Conditions	25°C, 65%RH
Tested by	Getaz Yang	Test Date	2017/7/25

Phase Of Power : Neutral (N)										
No	Frequency (MHz)	Correction Factor (dB)	Reading Value (dBuV)		Emission Level (dBuV)		Limit (dBuV)		Margin (dB)	
			Q.P.	AV.	Q.P.	AV.	Q.P.	AV.	Q.P.	AV.
1	0.16173	10.11	39.37	22.03	49.48	32.14	65.37	55.37	-15.89	-23.23
2	0.19692	10.14	33.45	19.29	43.59	29.43	63.74	53.74	-20.15	-24.31
3	0.23216	10.14	29.13	16.79	39.27	26.93	62.37	52.37	-23.10	-25.44
4	0.46280	10.16	15.06	7.89	25.22	18.05	56.64	46.64	-31.42	-28.59
5	1.53023	10.20	14.90	9.47	25.10	19.67	56.00	46.00	-30.90	-26.33
6	13.29151	10.68	10.93	3.66	21.61	14.34	60.00	50.00	-38.39	-35.66

Remarks:

1. Q.P. and AV. are abbreviations of quasi-peak and average individually.
2. The emission levels of other frequencies were very low against the limit.
3. Margin value = Emission level – Limit value
4. Correction factor = Insertion loss + Cable loss
5. Emission Level = Correction Factor + Reading Value

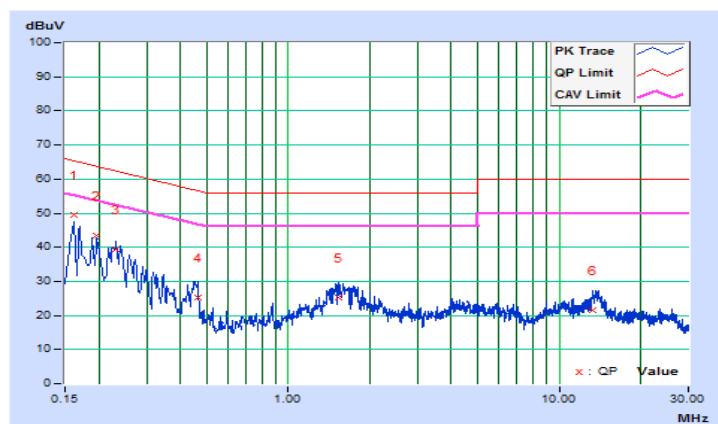

4.3 6 dB Bandwidth Measurement

4.3.1 Limits of 6 dB Bandwidth Measurement

The minimum of 6 dB Bandwidth Measurement is 0.5 MHz.

4.3.2 Test Setup

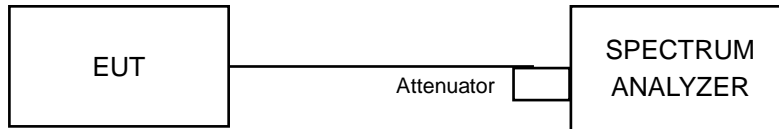

4.3.3 Test Instruments

Refer to section 4.1.2 to get information of above instrument.

4.3.4 Test Procedure

- a. Set resolution bandwidth (RBW) = 100 kHz
- b. Set the video bandwidth (VBW) $\geq 3 \times$ RBW, Detector = Peak.
- c. Trace mode = max hold.
- d. Sweep = auto couple.
- e. Measure the maximum width of the emission that is constrained by the frequencies associated with the two amplitude points (upper and lower) that are attenuated by 6 dB relative to the maximum level measured in the fundamental emission

4.3.5 Deviation from Test Standard

No deviation.

4.3.6 EUT Operating Conditions

The software provided by client to enable the EUT under transmission condition continuously at lowest, middle and highest channel frequencies individually.

4.3.7 Test Result

802.11b

Channel	Frequency (MHz)	6 dB Bandwidth (MHz)	Minimum Limit (MHz)	Pass / Fail
1	2412	8.57	0.5	Pass
6	2437	8.59	0.5	Pass
11	2462	8.08	0.5	Pass

802.11g

Channel	Frequency (MHz)	6 dB Bandwidth (MHz)	Minimum Limit (MHz)	Pass / Fail
1	2412	16.39	0.5	Pass
6	2437	16.37	0.5	Pass
11	2462	16.38	0.5	Pass

802.11n (HT20)

Channel	Frequency (MHz)	6 dB Bandwidth (MHz)	Minimum Limit (MHz)	Pass / Fail
1	2412	17.61	0.5	Pass
6	2437	17.58	0.5	Pass
11	2462	17.59	0.5	Pass

Spectrum Plot of Worst Value

802.11b

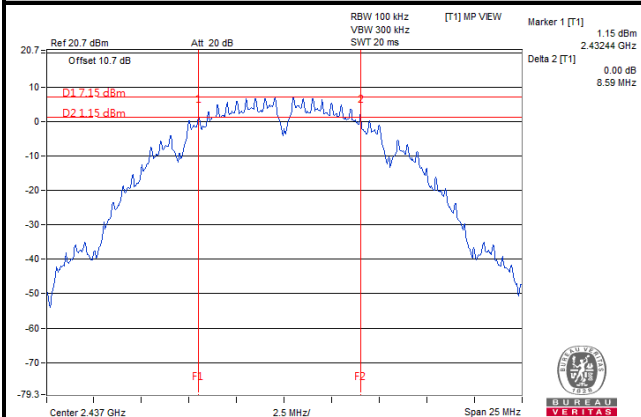

802.11g

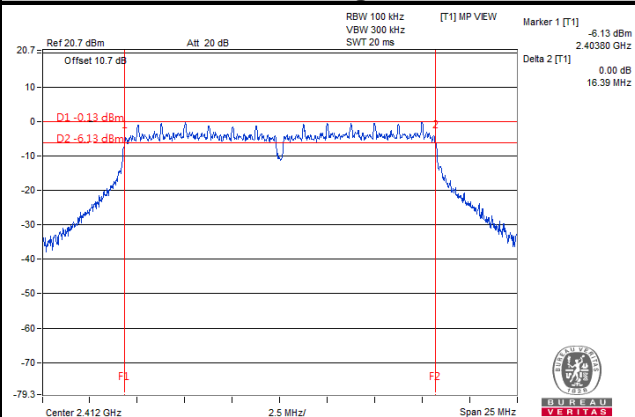

802.11n (HT20)

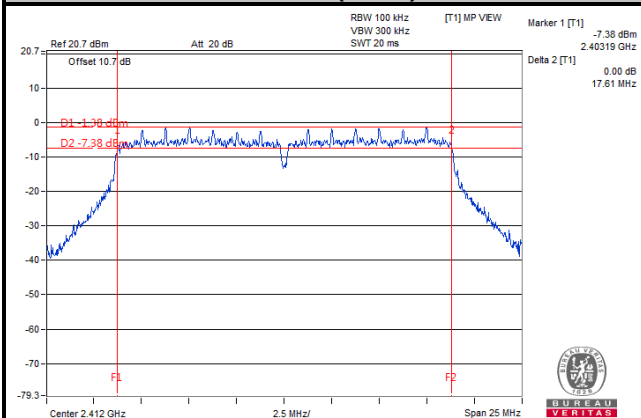

4.4 Conducted Output Power Measurement

4.4.1 Limits of Conducted Output Power Measurement

For systems using digital modulation in the 2400–2483.5 MHz bands: 1 Watt (30 dBm)

4.4.2 Test Setup

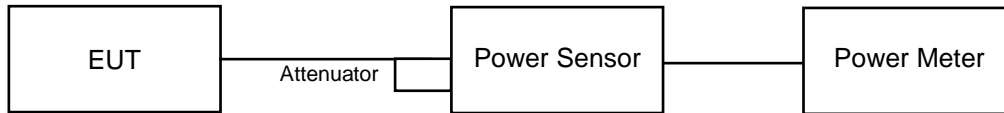

4.4.3 Test Instruments

Refer to section 4.1.2 to get information of above instrument.

4.4.4 Test Procedures

A peak power sensor was used on the output port of the EUT. A power meter was used to read the response of the peak power sensor. Record the power level.

4.4.5 Deviation from Test Standard

No deviation.

4.4.6 EUT Operating Conditions

The software provided by client to enable the EUT under transmission condition continuously at lowest, middle and highest channel frequencies individually.

4.4.7 Test Results

802.11b

Channel	Frequency (MHz)	Peak Power (mW)	Peak Power (dBm)	Limit (dBm)	Pass / Fail
1	2412	76.033	18.81	30	Pass
6	2437	75.509	18.78	30	Pass
11	2462	75.683	18.79	30	Pass

802.11g

Channel	Frequency (MHz)	Peak Power (mW)	Peak Power (dBm)	Limit (dBm)	Pass / Fail
1	2412	116.681	20.67	30	Pass
6	2437	113.501	20.55	30	Pass
11	2462	112.46	20.51	30	Pass

802.11n (HT20)

Channel	Frequency (MHz)	Peak Power (mW)	Peak Power (dBm)	Limit (dBm)	Pass / Fail
1	2412	96.161	19.83	30	Pass
6	2437	92.683	19.67	30	Pass
11	2462	95.06	19.78	30	Pass

4.5 Power Spectral Density Measurement

4.5.1 Limits of Power Spectral Density Measurement

The Maximum of Power Spectral Density Measurement is 8 dBm.

4.5.2 Test Setup

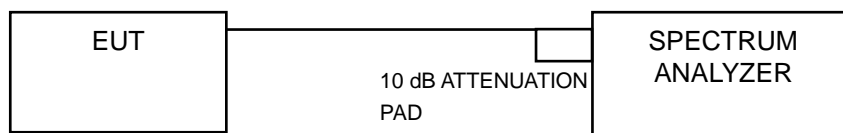

4.5.3 Test Instruments

Refer to section 4.1.2 to get information of above instrument.

4.5.4 Test Procedure

- a. Set analyzer center frequency to DTS channel center frequency.
- b. Set the span to 1.5 times the DTS bandwidth.
- c. Set the RBW to: $3 \text{ kHz} \leq \text{RBW} \leq 100 \text{ kHz}$.
- d. Set the VBW $\geq 3 \times \text{RBW}$.
- e. Detector = peak.
- f. Sweep time = auto couple.
- g. Trace mode = max hold.
- h. Allow trace to fully stabilize.
- i. Use the peak marker function to determine the maximum amplitude level within the RBW.

4.5.5 Deviation from Test Standard

No deviation.

4.5.6 EUT Operating Condition

The software provided by client to enable the EUT under transmission condition continuously at lowest, middle and highest channel frequencies individually.

4.5.7 Test Results

802.11b

Channel	Frequency (MHz)	PSD (dBm/3 kHz)	Limit (dBm/3 kHz)	Pass / Fail
1	2412	-9.69	8	Pass
6	2437	-7.45	8	Pass
11	2462	-7.49	8	Pass

802.11g

Channel	Frequency (MHz)	PSD (dBm/3 kHz)	Limit (dBm/3 kHz)	Pass / Fail
1	2412	-14.53	8	Pass
6	2437	-13.59	8	Pass
11	2462	-13.80	8	Pass

802.11n (HT20)

Channel	Frequency (MHz)	PSD (dBm/3 kHz)	Limit (dBm/3 kHz)	Pass / Fail
1	2412	-15.52	8	Pass
6	2437	-15.02	8	Pass
11	2462	-15.22	8	Pass

Spectrum Plot of Worst Value

802.11b

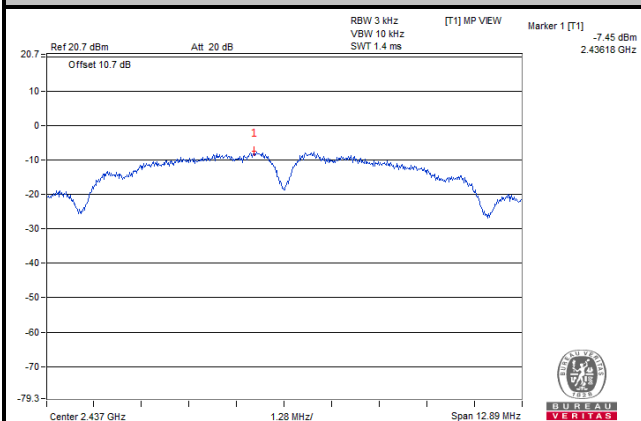

802.11g

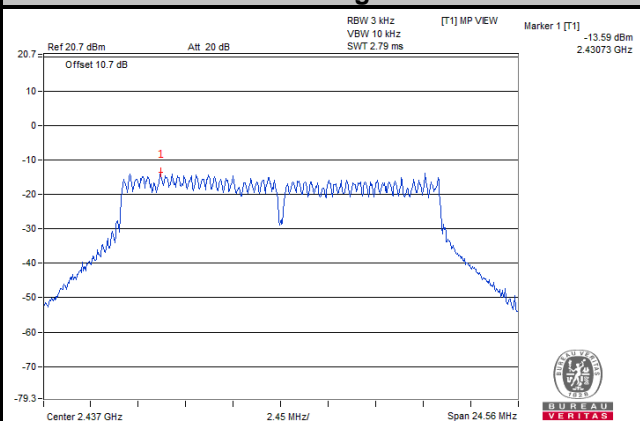

802.11n (HT20)

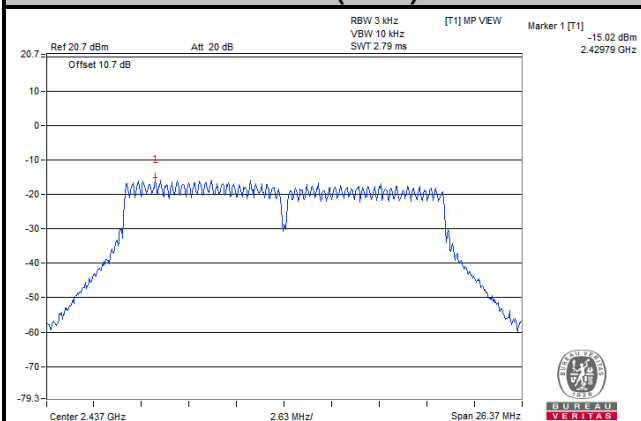

4.6 Conducted Out of Band Emission Measurement

4.6.1 Limits of Conducted Out of Band Emission Measurement

Below 20 dB of the highest emission level of operating band (in 100 kHz Resolution Bandwidth).

4.6.2 Test Setup

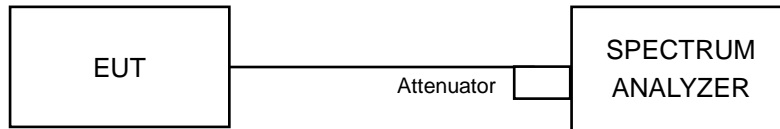

4.6.3 Test Instruments

Refer to section 4.1.2 to get information of above instrument.

4.6.4 Test Procedure

MEASUREMENT PROCEDURE REF

1. Set the RBW = 100 kHz.
2. Set the VBW \geq 300 kHz.
3. Detector = peak.
4. Sweep time = auto couple.
5. Trace mode = max hold.
6. Allow trace to fully stabilize.
7. Use the peak marker function to determine the maximum power level in any 100 kHz band segment within the fundamental EBW.

MEASUREMENT PROCEDURE OOB

1. Set RBW = 100 kHz.
2. Set VBW \geq 300 kHz.
3. Detector = peak.
4. Sweep = auto couple.
5. Trace Mode = max hold.
6. Allow trace to fully stabilize.
7. Use the peak marker function to determine the maximum amplitude level.

4.6.5 Deviation from Test Standard

No deviation.

4.6.6 EUT Operating Condition

The software provided by client to enable the EUT under transmission condition continuously at lowest, middle and highest channel frequencies individually.

4.6.7 Test Results

The spectrum plots are attached on the following images. D1 line indicates the highest level, and D2 line indicates the 20 dB offset below D1. It shows compliance with the requirement.

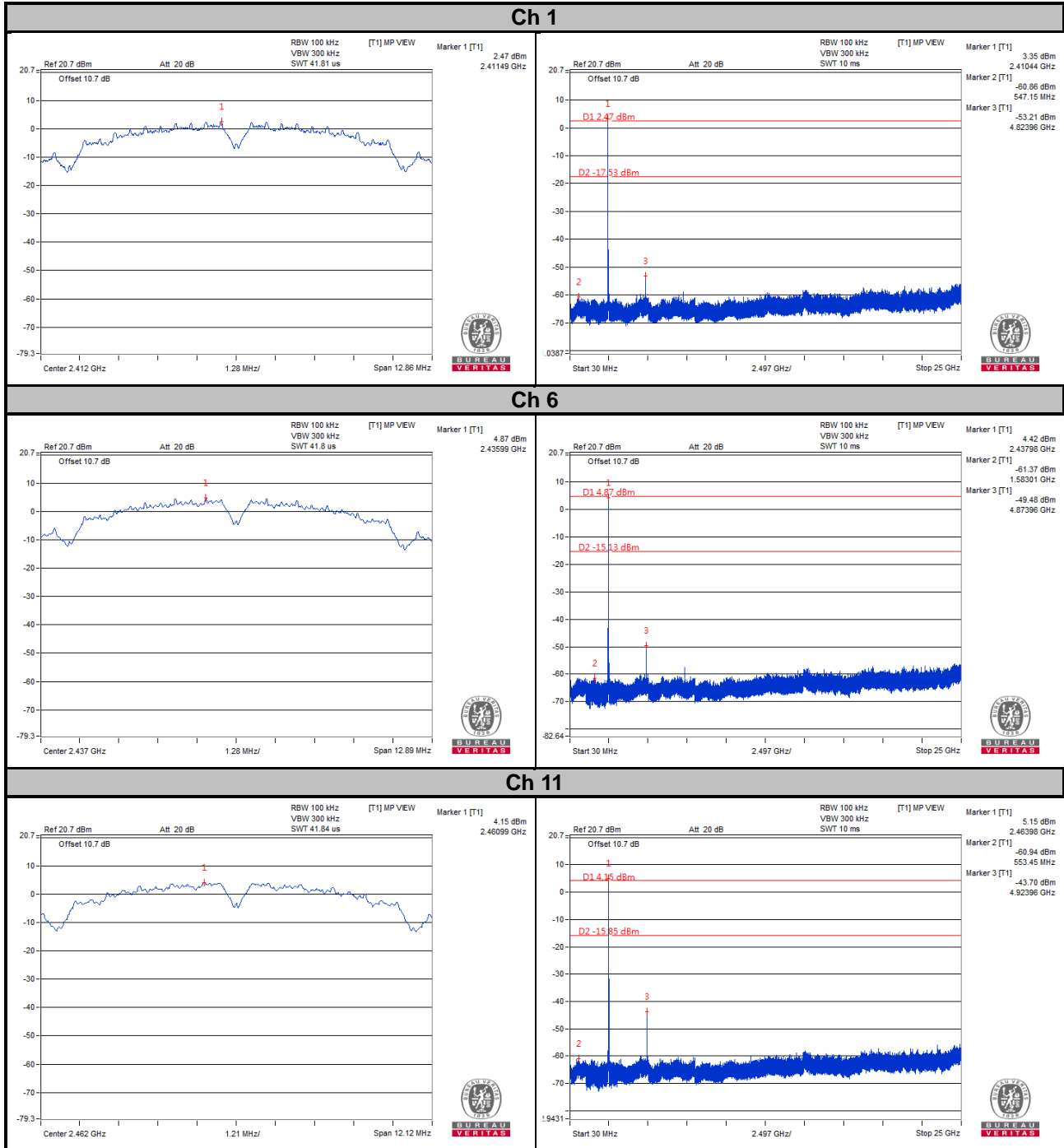

Ch 1 Band Edge

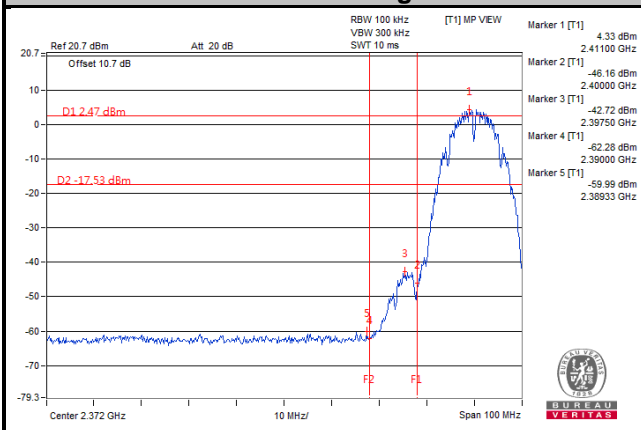

Ch 11 Band Edge

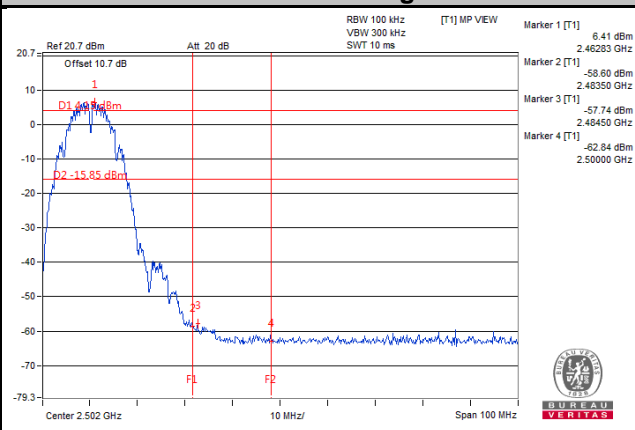

802.11g

Ch 1

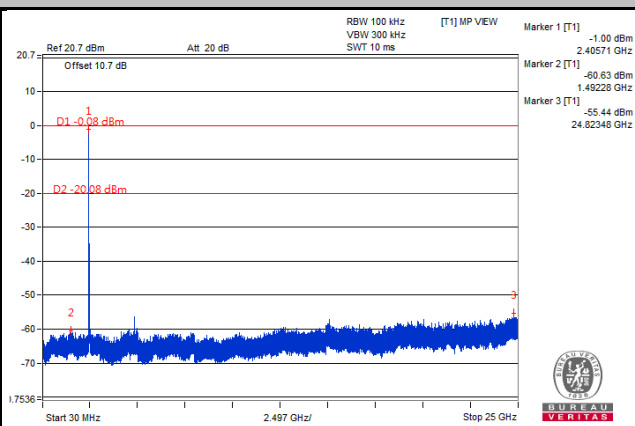
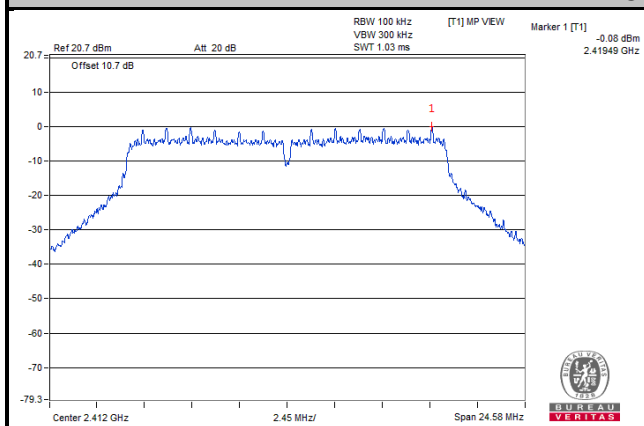

Ch 6

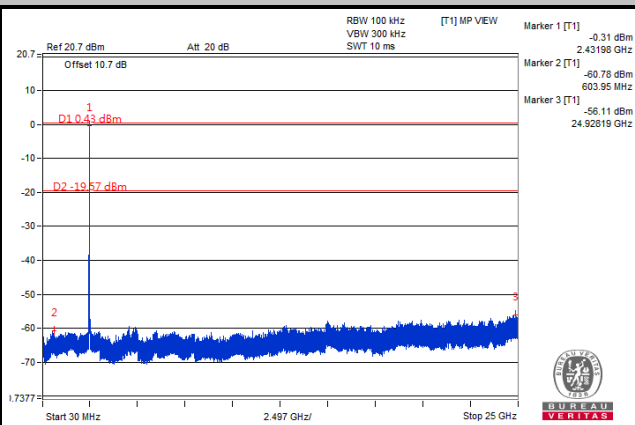
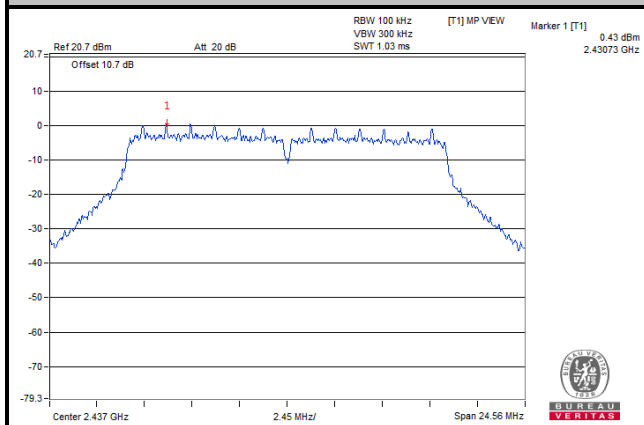

Ch 11

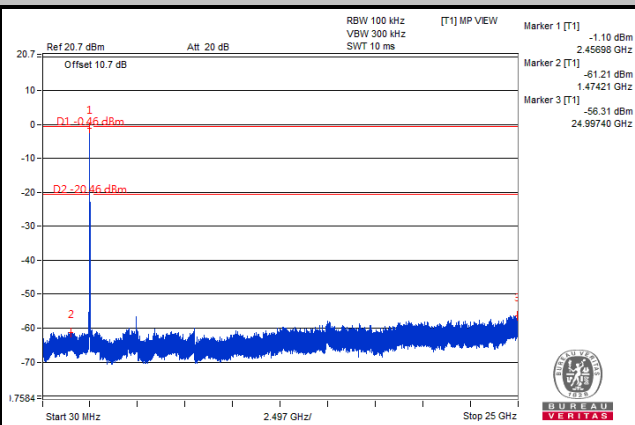
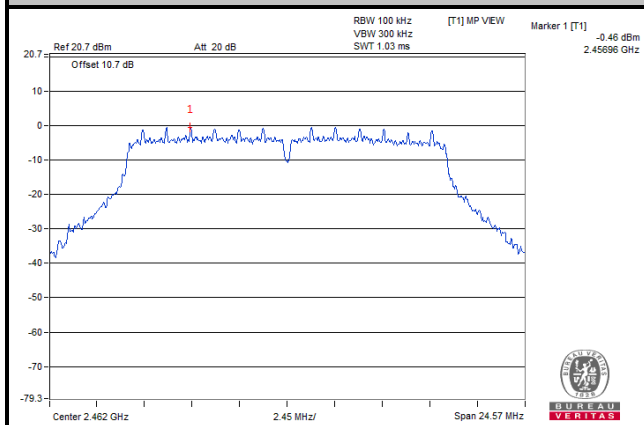

Ch 1 Band Edge

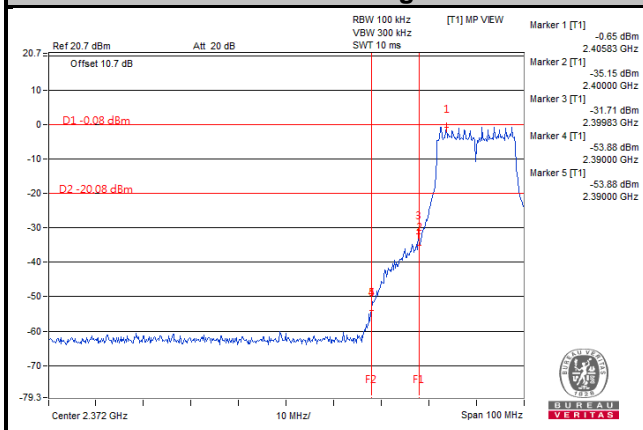

Ch 11 Band Edge

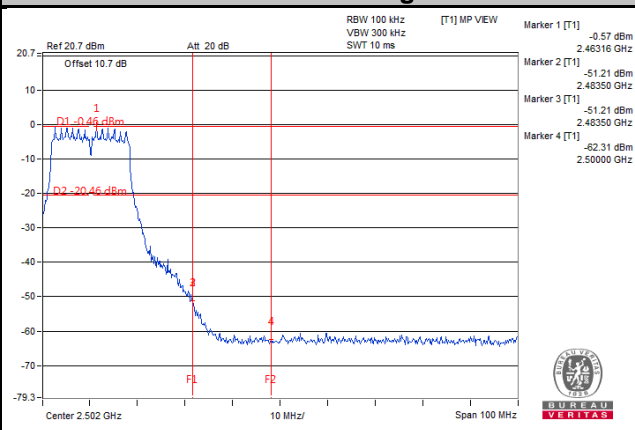

802.11n (HT20)

Ch 1

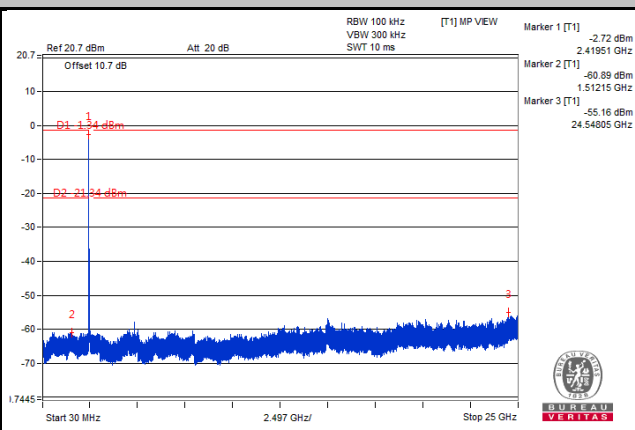
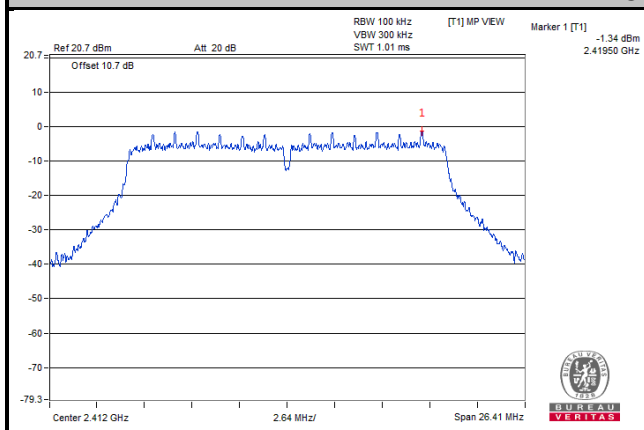

Ch 6

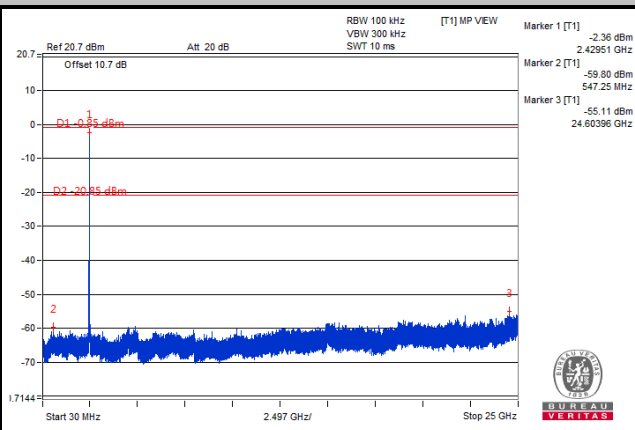
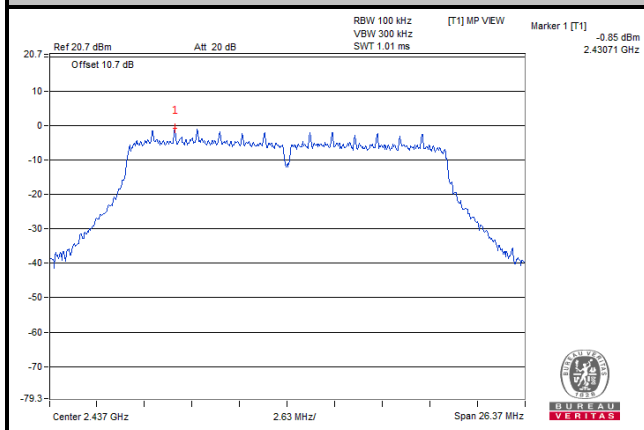

Ch 11

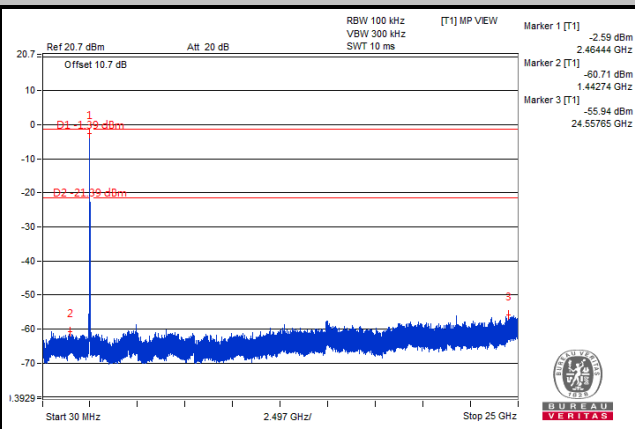
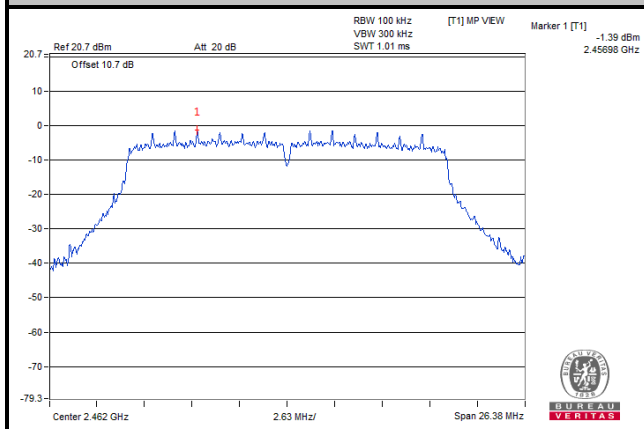

Ch 1 Band Edge

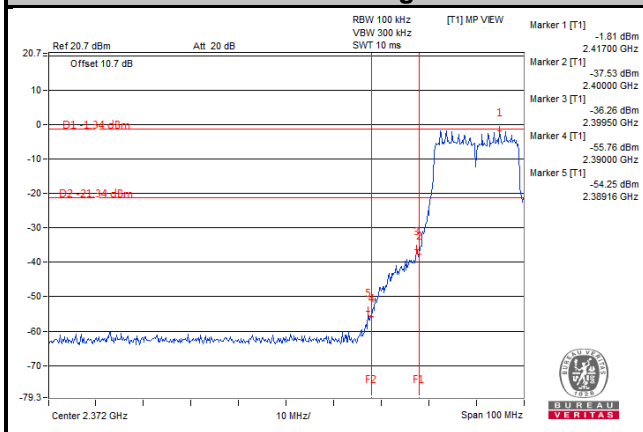

Ch 11 Band Edge

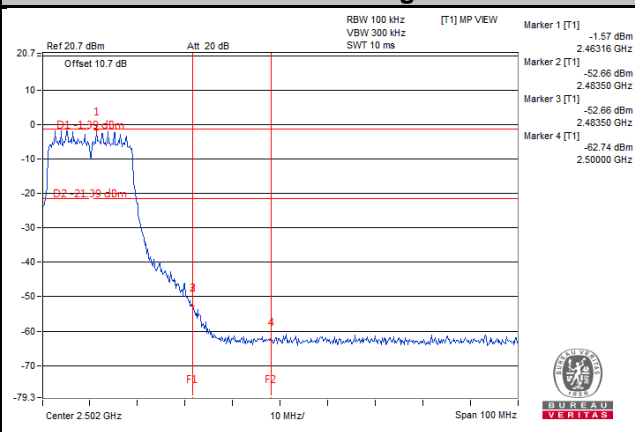

5 Pictures of Test Arrangements

Please refer to the attached file (Test Setup Photo).

Appendix – Information on the Testing Laboratories

We, Bureau Veritas Consumer Products Services (H.K.) Ltd., Taoyuan Branch, were founded in 1988 to provide our best service in EMC, Radio, Telecom and Safety consultation. Our laboratories are FCC recognized accredited test firms and accredited and approved according to ISO/IEC 17025.

If you have any comments, please feel free to contact us at the following:

Linko EMC/RF Lab

Tel: 886-2-26052180

Fax: 886-2-26051924

Hsin Chu EMC/RF/Telecom Lab

Tel: 886-3-6668565

Fax: 886-3-6668323

Hwa Ya EMC/RF/Safety Lab

Tel: 886-3-3183232

Fax: 886-3-3270892

Email: service.adt@tw.bureauveritas.com

Web Site: www.bureauveritas-adt.com

The address and road map of all our labs can be found in our web site also.

--- END ---