

FCC Test Report

Report No.: RF170407C07A

FCC ID: UK7-DW3A

Test Model: DW3A, DW3B

Received Date: Apr. 07, 2017

Test Date: Jul. 19, 2017 ~ Jul. 27, 2017

Issued Date: Aug. 10, 2017

Applicant: Fossil Group, Inc.

Address: 901 S. Central Expressway, Richardson, TX 75080 USA

Issued By: Bureau Veritas Consumer Products Services (H.K.) Ltd., Taoyuan Branch

Lab Address: No. 47-2, 14th Ling, Chia Pau Vil., Lin Kou Dist., New Taipei City, Taiwan
(R.O.C)

Test Location (1): No. 19, Hwa Ya 2nd Rd, Wen Hwa Tsuen, Kwei Shan Hsiang, Taoyuan
Hsien 333, Taiwan, R.O.C.

Test Location (2): No.215, Sec. 3, Beixin Rd., Xindian Dist., New Taipei City 231, Taiwan,
R.O.C



This report is for your exclusive use. Any copying or replication of this report to or for any other person or entity, or use of our name or trademark, is permitted only with our prior written permission. This report sets forth our findings solely with respect to the test samples identified herein. The results set forth in this report are not indicative or representative of the quality or characteristics of the lot from which a test sample was taken or any similar or identical product unless specifically and expressly noted. Our report includes all of the tests requested by you and the results thereof based upon the information that you provided to us. You have 60 days from date of issuance of this report to notify us of any material error or omission caused by our negligence, provided, however, that such notice shall be in writing and shall specifically address the issue you wish to raise. A failure to raise such issue within the prescribed time shall constitute your unqualified acceptance of the completeness of this report, the tests conducted and the correctness of the report contents. Unless specific mention, the uncertainty of measurement has been explicitly taken into account to declare the compliance or non-compliance to the specification.

Table of Contents

Release Control Record	4
1 Certificate of Conformity	5
2 Summary of Test Results	6
2.1 Measurement Uncertainty	6
2.2 Modification Record	6
3 General Information	7
3.1 General Description of EUT	7
3.2 Description of Test Modes	8
3.2.1 Test Mode Applicability and Tested Channel Detail	9
3.3 Description of Support Units	11
3.3.1 Configuration of System under Test	11
3.4 General Description of Applied Standards	11
4 Test Types and Results	12
4.1 Radiated Emission and Bandedge Measurement	12
4.1.1 Limits of Radiated Emission and Bandedge Measurement	12
4.1.2 Test Instruments	13
4.1.3 Test Procedures	14
4.1.4 Deviation from Test Standard	14
4.1.5 Test Set Up	15
4.1.6 EUT Operating Conditions	15
4.1.7 Test Results	16
4.2 Conducted Emission Measurement	40
4.2.1 Limits of Conducted Emission Measurement	40
4.2.2 Test Instruments	40
4.2.3 Test Procedures	41
4.2.4 Deviation from Test Standard	41
4.2.5 Test Setup	41
4.2.6 EUT Operating Condition	41
4.2.7 Test Results	42
4.3 Number of Hopping Frequency Used	46
4.3.1 Limits of Hopping Frequency Used Measurement	46
4.3.2 Test Setup	46
4.3.3 Test Instruments	46
4.3.4 Test Procedure	46
4.3.5 Deviation from Test Standard	46
4.3.6 Test Results	46
4.4 Dwell Time on Each Channel	48
4.4.1 Limits of Dwell Time on Each Channel Measurement	48
4.4.2 Test Setup	48
4.4.3 Test Instruments	48
4.4.4 Test Procedures	48
4.4.5 Deviation from Test Standard	48
4.4.6 Test Results	49
4.5 Channel Bandwidth	52
4.5.1 Limits of Channel Bandwidth Measurement	52
4.5.2 Test Setup	52
4.5.3 Test Instruments	52
4.5.4 Test Procedure	52
4.5.5 Deviation from Test Standard	52
4.5.6 EUT Operating Condition	52
4.5.7 Test Results	53
4.6 Hopping Channel Separation	54
4.6.1 Limits of Hopping Channel Separation Measurement	54

4.6.2 Test Setup	54
4.6.3 Test Instruments	54
4.6.4 Test Procedure	54
4.6.5 Deviation from Test Standard	54
4.6.6 Test Results	55
4.7 Maximum Output Power	56
4.7.1 Limits of Maximum Output Power Measurement	56
4.7.2 Test Setup	56
4.7.3 Test Instruments	56
4.7.4 Test Procedure	56
4.7.5 Deviation from Test Standard	56
4.7.6 EUT Operating Condition	56
4.7.7 Test Results	57
4.8 Conducted Out of Band Emission Measurement	58
4.8.1 Limits Of Conducted Out Of Band Emission Measurement	58
4.8.2 Test Instruments	58
4.8.3 Test Procedure	58
4.8.4 Deviation from Test Standard	58
4.8.5 EUT Operating Condition	58
4.8.6 Test Results	58
5 Pictures of Test Arrangements.....	62
Appendix – Information on the Testing Laboratories	63

Release Control Record

Issue No.	Description	Date Issued
RF170407C07A	Original Release	Aug. 10, 2017

1 Certificate of Conformity

Product: Smart Watch

Brand: MISFIT, FOSSIL

Test Model: DW3A, DW3B

Sample Status: Identical Prototype

Applicant: Fossil Group, Inc.

Test Date: Jul. 19, 2017 ~ Jul. 27, 2017

Standards: 47 CFR FCC Part 15, Subpart C (Section 15.247)
ANSI C63.10:2013

The above equipment has been tested by **Bureau Veritas Consumer Products Services (H.K.) Ltd., Taoyuan Branch**, and found compliance with the requirement of the above standards. The test record, data evaluation & Equipment Under Test (EUT) configurations represented herein are true and accurate accounts of the measurements of the sample's EMC characteristics under the conditions specified in this report.

Prepared by :

Gina Liu

Date:

Aug. 10, 2017

Gina Liu / Specialist

Approved by :

David Huang

Date:

Aug. 10, 2017

David Huang / Project Engineer

2 Summary of Test Results

47 CFR FCC Part 15, Subpart C (Section 15.247)			
FCC Clause	Test Item	Result	Remarks
15.207	AC Power Conducted Emission	Pass	Meet the requirement of limit. Minimum passing margin is -13.98 dB at 0.57228 MHz.
15.247(a)(1)(iii)	Number of Hopping Frequency Used	Pass	Meet the requirement of limit.
15.247(a)(1)(iii)	Dwell Time on Each Channel	Pass	Meet the requirement of limit.
15.247(a)(1)	1. Hopping Channel Separation 2. Spectrum Bandwidth of a Frequency Hopping Sequence Spread Spectrum System	Pass	Meet the requirement of limit.
15.247(b)	Maximum Peak Output Power	Pass	Meet the requirement of limit.
15.205 & 209	Radiated Emissions	Pass	Meet the requirement of limit. Minimum passing margin is -3.18 dB at 240.06 MHz.
15.247(d)	Band Edge Measurement	Pass	Meet the requirement of limit.
15.247(d)	Antenna Port Emission	Pass	Meet the requirement of limit.
15.203	Antenna Requirement	Pass	No antenna connector is used.

Note: If The Frequency Hopping System operating in 2400-2483.5 MHz band and the output power less than 125 mW. The hopping channel carrier frequencies separated by a minimum of 25 kHz or two-thirds of the 20 dB bandwidth of hopping channel whichever is greater.

2.1 Measurement Uncertainty

Where relevant, the following measurement uncertainty levels have been estimated for tests performed on the EUT:

The listed uncertainties are the worst case uncertainty for the entire range of measurement. Please note that the uncertainty values are provided for informational purposes only and are not used in determining the PASS/FAIL results.

Measurement	Frequency	Expanded Uncertainty (k=2) (±)
Conducted Emissions at mains ports	150 kHz ~ 30 MHz	2.44 dB
Radiated Emissions up to 1 GHz	30 MHz ~ 200 MHz	2.0153 dB
	200 MHz ~1000 MHz	2.0224 dB
Radiated Emissions above 1 GHz	1 GHz ~ 18 GHz	1.0121 dB
	18 GHz ~ 40 GHz	1.1508 dB

2.2 Modification Record

There were no modifications required for compliance.

3 General Information

3.1 General Description of EUT

Product	Smart Watch
Brand	MISFIT, FOSSIL
Test Model	DW3A, DW3B
Status of EUT	Identical Prototype
Power Supply Rating	3.8 Vdc (Battery) 5 Vdc (Host equipment)
Modulation Type	GFSK, $\pi/4$ -DQPSK, 8DPSK
Transfer Rate	1/2/3 Mbps
Operating Frequency	2402 ~ 2480 MHz
Number of Channel	79
Output Power	3.69 mW
Antenna Type	PCB antenna with -6.65 dBi gain (DW3A) PCB antenna with -6.92 dBi gain (DW3B)
Antenna Connector	N/A
Accessory Device	Refer to Note as below
Data Cable Supplied	Refer to Note as below

Note:

- There're 2 configurations for the EUT listed as below.

Sample	Brand	Model	Difference
A	MISFIT	DW3A	The models are different in the appearance and antenna gain.
B	FOSSIL	DW3B	

- The EUT contains following accessory devices.

Product	Brand	Model	Description
LCD Panel	BOE	WB014ZNM-N00-6D00	1.39"
Battery	GREPOW	ABI403530	3.8 Vdc, 360 mAh
Charger Cable	NA	NA	0.9m non-shielded cable w/o core
eMMC	N/A	N/A	4G

- The above EUT information is declared by manufacturer and for more detailed features description, please refer to the manufacturer's specifications or User's Manual.

3.2 Description of Test Modes

79 channels are provided to this EUT:

Channel	Freq. (MHz)	Channel	Freq. (MHz)	Channel	Freq. (MHz)	Channel	Freq. (MHz)
0	2402	20	2422	40	2442	60	2462
1	2403	21	2423	41	2443	61	2463
2	2404	22	2424	42	2444	62	2464
3	2405	23	2425	43	2445	63	2465
4	2406	24	2426	44	2446	64	2466
5	2407	25	2427	45	2447	65	2467
6	2408	26	2428	46	2448	66	2468
7	2409	27	2429	47	2449	67	2469
8	2410	28	2430	48	2450	68	2470
9	2411	29	2431	49	2451	69	2471
10	2412	30	2432	50	2452	70	2472
11	2413	31	2433	51	2453	71	2473
12	2414	32	2434	52	2454	72	2474
13	2415	33	2435	53	2455	73	2475
14	2416	34	2436	54	2456	74	2476
15	2417	35	2437	55	2457	75	2477
16	2418	36	2438	56	2458	76	2478
17	2419	37	2439	57	2459	77	2479
18	2420	38	2440	58	2460	78	2480
19	2421	39	2441	59	2461		

3.2.1 Test Mode Applicability and Tested Channel Detail

EUT Configure Mode	Applicable To				Description
	RE \geq 1G	RE $<$ 1G	PLC	APCM	
A	√	√	√	√	Sample A
B	√	√	√	-	Sample B

Where **RE \geq 1G**: Radiated Emission above 1 GHz **RE $<$ 1G**: Radiated Emission below 1 GHz
PLC: Power Line Conducted Emission **APCM**: Antenna Port Conducted Measurement

Note:

1. For Radiated emission test, pre-tested GFSK, $\pi/4$ -DQPSK, 8DPSK modulation type and found 8DPSK was the worse, therefore chosen for the final test and presented in the test report.
2. The EUT had been pre-tested on the positioned of each 3 axis. The worst case was found when positioned on **Y-plane**.
3. "-" means no effect.

Radiated Emission Test (Above 1 GHz):

- Pre-Scan has been conducted to determine the worst-case mode from all possible combinations between available modulations, data rates and antenna ports (if EUT with antenna diversity architecture).
- Following channel(s) was (were) selected for the final test as listed below.

EUT Configure Mode	Available Channel	Tested Channel	Modulation Technology	Modulation Type	Packet Type
A, B	0 to 78	0, 39, 78	FHSS	8DPSK	DH5

Radiated Emission Test (Below 1 GHz):

- Pre-Scan has been conducted to determine the worst-case mode from all possible combinations between available modulations, data rates and antenna ports (if EUT with antenna diversity architecture).
- Following channel(s) was (were) selected for the final test as listed below.

EUT Configure Mode	Available Channel	Tested Channel	Modulation Technology	Modulation Type	Packet Type
A, B	0 to 78	39	FHSS	8DPSK	DH5

Power Line Conducted Emission Test:

- Pre-Scan has been conducted to determine the worst-case mode from all possible combinations between available modulations, data rates and antenna ports (if EUT with antenna diversity architecture).
- Following channel(s) was (were) selected for the final test as listed below.

EUT Configure Mode	Available Channel	Tested Channel	Modulation Technology	Modulation Type	Packet Type
A, B	0 to 78	39	FHSS	8DPSK	DH5

Antenna Port Conducted Measurement:

- This item includes all test value of each mode, but only includes spectrum plot of worst value of each mode.
- Pre-Scan has been conducted to determine the worst-case mode from all possible combinations between available modulations, data rates and antenna ports (if EUT with antenna diversity architecture).
- Following channel(s) was (were) selected for the final test as listed below.

EUT Configure Mode	Available Channel	Tested Channel	Modulation Technology	Modulation Type	Packet Type
A	0 to 78	0, 39, 78	FHSS	GFSK	DH5
	0 to 78	0, 39, 78	FHSS	$\pi/4$ -DQPSK	DH5
	0 to 78	0, 39, 78	FHSS	8DPSK	DH5

Test Condition:

Applicable To	Environmental Conditions	Input Power	Tested by
RE \geq 1G	25 deg. C, 65 % RH	120 Vac, 60 Hz	Charles Hsiao, Harry Hsueh
RE<1G	25 deg. C, 65 % RH	120 Vac, 60 Hz	Charles Hsiao
PLC	25 deg. C, 65 % RH	120 Vac, 60 Hz	Getaz Yang
APCM	25 deg. C, 65 % RH	3.8 Vdc	Luke Chen

3.3 Description of Support Units

The EUT has been tested as an independent unit together with other necessary accessories or support units. The following support units or accessories were used to form a representative test configuration during the tests.

No.	Product	Brand	Model No.	Serial No.	FCC ID
1.	Bluetooth Tester	R&S	CBT	100980	N/A

No.	Signal Cable Description Of The Above Support Units
1.	N/A

Note:

1. All power cords of the above support units are non-shielded (1.8m).

3.3.1 Configuration of System under Test

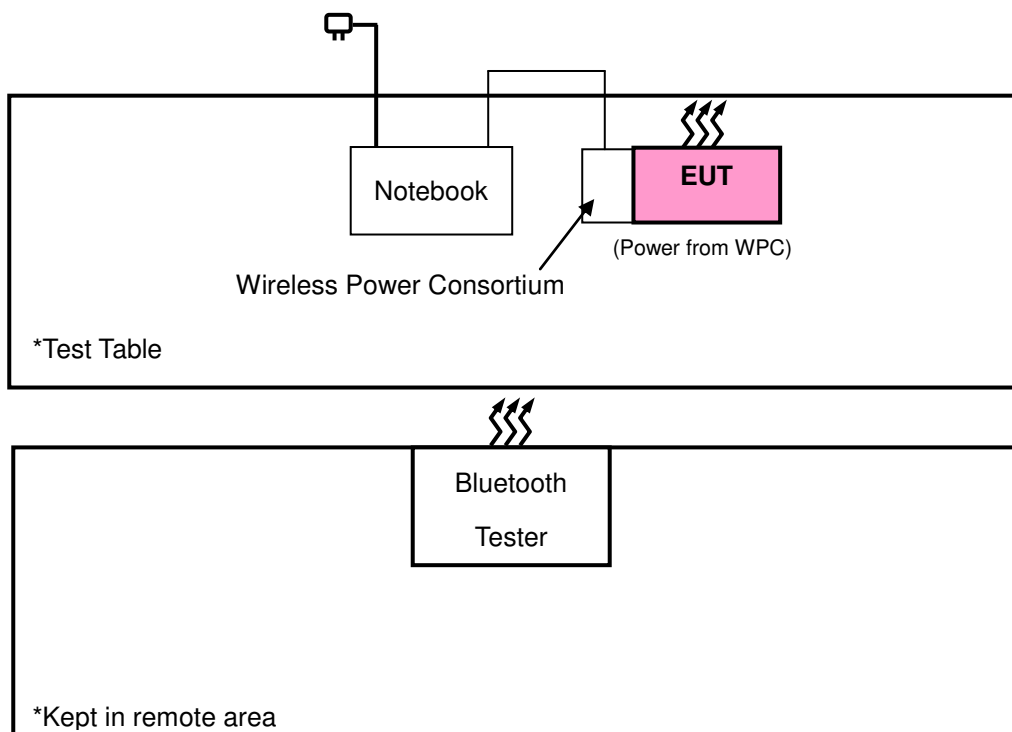

3.4 General Description of Applied Standards

The EUT is a RF Product. According to the specifications of the manufacturer, it must comply with the requirements of the following standards:

FCC Part 15, Subpart C (15.247)

FCC Public Notice DA 00-705

ANSI C63.10-2013

All test items have been performed and recorded as per the above standards.

4 Test Types and Results

4.1 Radiated Emission and Bandedge Measurement

4.1.1 Limits of Radiated Emission and Bandedge Measurement

Radiated emissions which fall in the restricted bands must comply with the radiated emission limits specified as below table. Other emissions shall be at least 20 dB below the highest level of the desired power:

Frequencies (MHz)	Field Strength (microvolts/meter)	Measurement Distance (meters)
0.009 ~ 0.490	2400/F (kHz)	300
0.490 ~ 1.705	24000/F (kHz)	30
1.705 ~ 30.0	30	30
30 ~ 88	100	3
88 ~ 216	150	3
216 ~ 960	200	3
Above 960	500	3

Note:

1. The lower limit shall apply at the transition frequencies.
2. Emission level (dBuV/m) = 20 log Emission level (uV/m).
3. For frequencies above 1000 MHz, the field strength limits are based on average detector, however, the peak field strength of any emission shall not exceed the maximum permitted average limits, specified above by more than 20 dB under any condition of modulation.

4.1.2 Test Instruments

Description & Manufacturer	Model No.	Serial No.	Date of Calibration	Due Date of Calibration
Test Receiver Agilent Technologies	N9038A	MY52260177	Jul. 05, 2017	Jul. 04, 2018
Spectrum Analyzer ROHDE & SCHWARZ	FSU43	101261	Dec. 13, 2016	Dec. 12, 2017
BILOG Antenna SCHWARZBECK	VULB9168	9168-472	Dec. 16, 2016	Dec. 15, 2017
HORN Antenna ETS-Lindgren	3117	00143293	Dec. 29, 2016	Dec. 28, 2017
HORN Antenna SCHWARZBECK	BBHA 9170	9170-480	Dec. 14, 2016	Dec. 13, 2017
Bluetooth Tester	CBT	100980	Jun. 28, 2017	Apr. 27, 2018
Loop Antenna	EM-6879	269	Aug. 11, 2016	Aug. 10, 2017
Preamplifier Agilent	310N	187226	Jun. 23, 2017	Jun. 22, 2018
Preamplifier Agilent	83017A	MY39501357	Jun. 23, 2017	Jun. 22, 2018
Power Meter Anritsu	ML2495A	1232002	Sep. 08, 2016	Sep. 07, 2017
Power Sensor Anritsu	MA2411B	1207325	Sep. 08, 2016	Sep. 07, 2017
RF signal cable ETS-LINDGREN	5D-FB	Cable-CH1-01(R FC-SMS-100-SM S-120+RFC-SMS -100-SMS-400)	Jun. 24, 2017	Jun. 23, 2018
RF signal cable ETS-LINDGREN	8D-FB	Cable-CH1-02(R FC-SMS-100-SM S-24)	Jun. 24, 2017	Jun. 23, 2018
Software BV ADT	E3 8.130425b	NA	NA	NA
Antenna Tower MF	NA	NA	NA	NA
Turn Table MF	NA	NA	NA	NA
Antenna Tower & Turn Table Controller MF	MF-7802	NA	NA	NA

- Note: 1. The calibration interval of the above test instruments is 12 months and the calibrations are traceable to NML/ROC and NIST/USA.
2. The test was performed in HsinTien Chamber 1.
3. The horn antenna and preamplifier (model: 83017A) are used only for the measurement of emission frequency above 1 GHz if tested.
4. The FCC Designation Number is TW0003. The number will be varied with the Lab location and scope as attached.
5. The IC Site Registration No. is IC7450I-1.

4.1.3 Test Procedures

- a. The EUT was placed on the top of a rotating table 0.8 meters (for below 1 GHz) / 1.5 meters (for above 1 GHz) above the ground at 3 meter chamber room for test. The table was rotated 360 degrees to determine the position of the highest radiation.
- b. The EUT was set 3 meters away from the interference-receiving antenna, which was mounted on the top of a variable-height antenna tower.
- c. The height of antenna is varied from one meter to four meters above the ground to determine the maximum value of the field strength. Both horizontal and vertical polarizations of the antenna are set to make the measurement.
- d. For each suspected emission, the EUT was arranged to its worst case and then the antenna was tuned to heights from 1 meter to 4 meters and the rotatable table was turned from 0 degrees to 360 degrees to find the maximum reading.
- e. The test-receiver system was set to quasi-peak detect function and specified bandwidth with maximum hold mode when the test frequency is below 1 GHz.
- f. The test-receiver system was set to peak and average detected function and specified bandwidth with maximum hold mode when the test frequency is above 1 GHz. If the peak reading value also meets average limit, measurement with the average detector is unnecessary.

Note:

1. The resolution bandwidth and video bandwidth of test receiver/spectrum analyzer is 120 kHz & 360 kHz for Quasi-peak detection (QP) at frequency below 1 GHz.
2. The resolution bandwidth of test receiver/spectrum analyzer is 1 MHz and the video bandwidth is 3 MHz for Peak detection (PK) at frequency above 1 GHz.
3. The resolution bandwidth of test receiver/spectrum analyzer is 1 MHz and the video bandwidth is 1/T for Average (Duty cycle < 98 %) detection at frequency above 1 GHz.
4. The resolution bandwidth of test receiver/spectrum analyzer is 1 MHz and the video bandwidth is 10 Hz (Duty cycle \geq 98 %) for Average detection (AV) at frequency above 1 GHz.
5. All modes of operation were investigated and the worst-case emissions are reported.

4.1.4 Deviation from Test Standard

No deviation.

4.1.5 Test Set Up

<Frequency Range below 1 GHz>

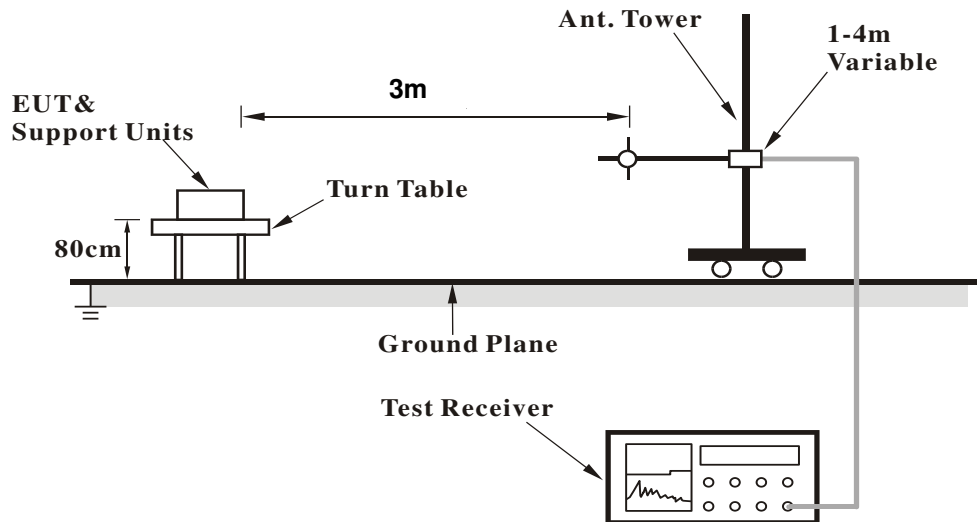

<Frequency Range above 1 GHz>

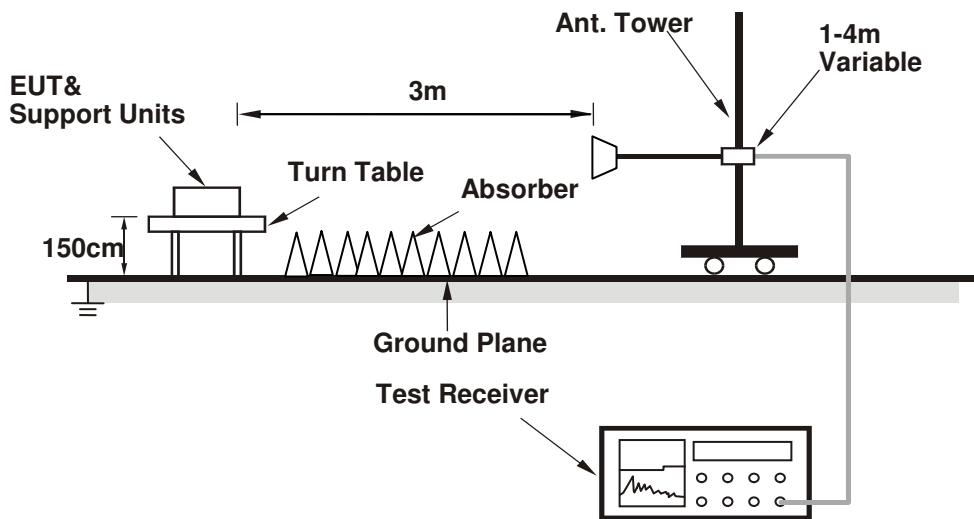

For the actual test configuration, please refer to the attached file (Test Setup Photo).

4.1.6 EUT Operating Conditions

Set the EUT under transmission condition continuously at specific channel frequency.

4.1.7 Test Results

ABOVE 1 GHz DATA :

Mode A

8DPSK

EUT Test Condition		Measurement Detail	
Channel	Channel 0	Frequency Range	1 GHz ~ 25 GHz
Input Power	120 Vac, 60 Hz	Detector Function	Peak (PK) Average (AV)
Environmental Conditions	25 deg. C, 65 % RH	Tested By	Charles Hsiao

Horizontal

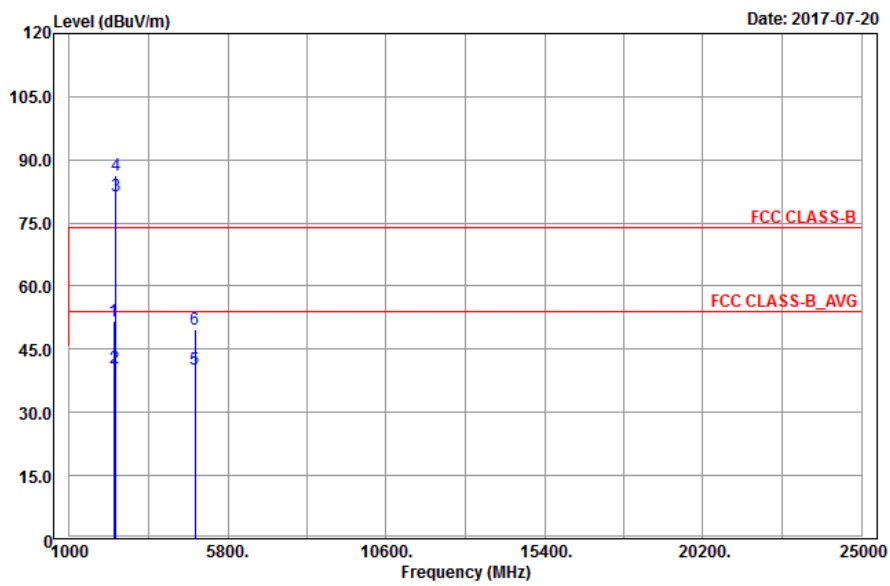

Vertical

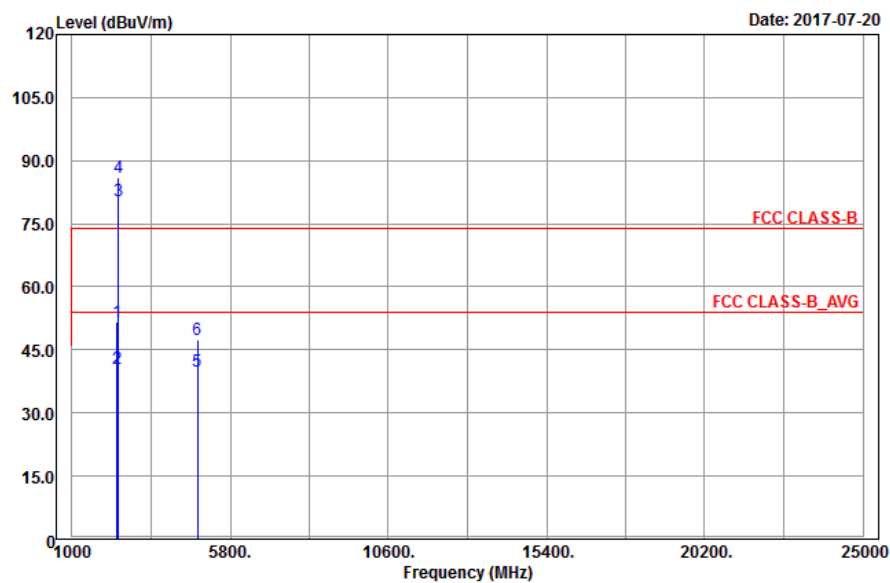

**Band Edge
Peak
Horizontal**

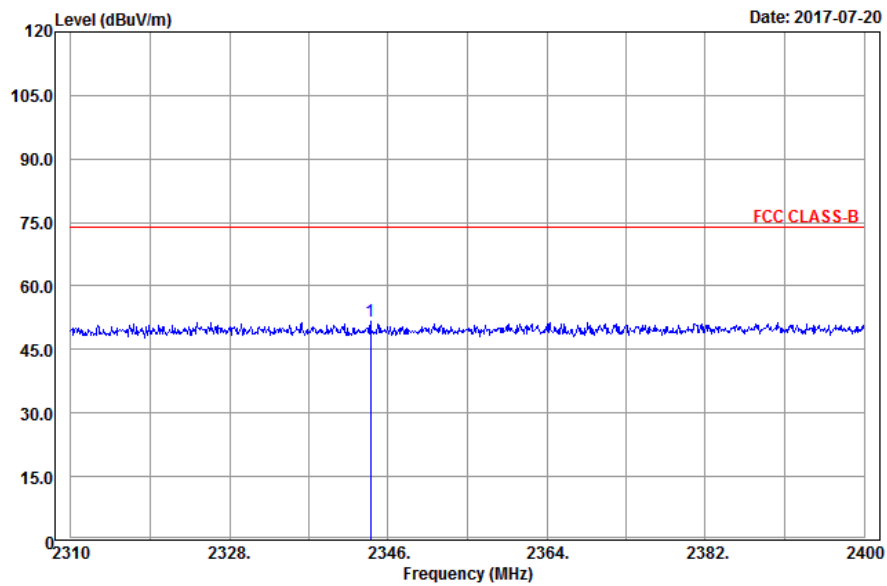

Vertical

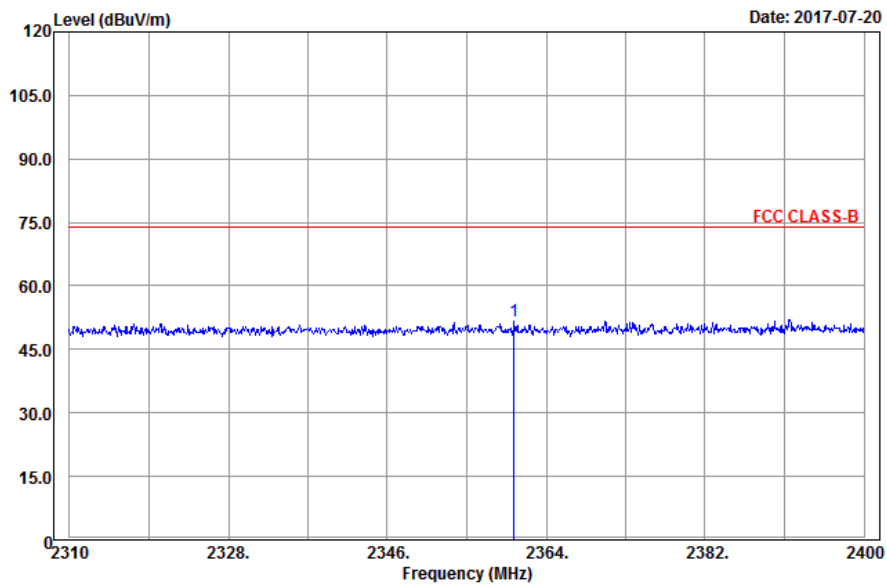

Average Horizontal

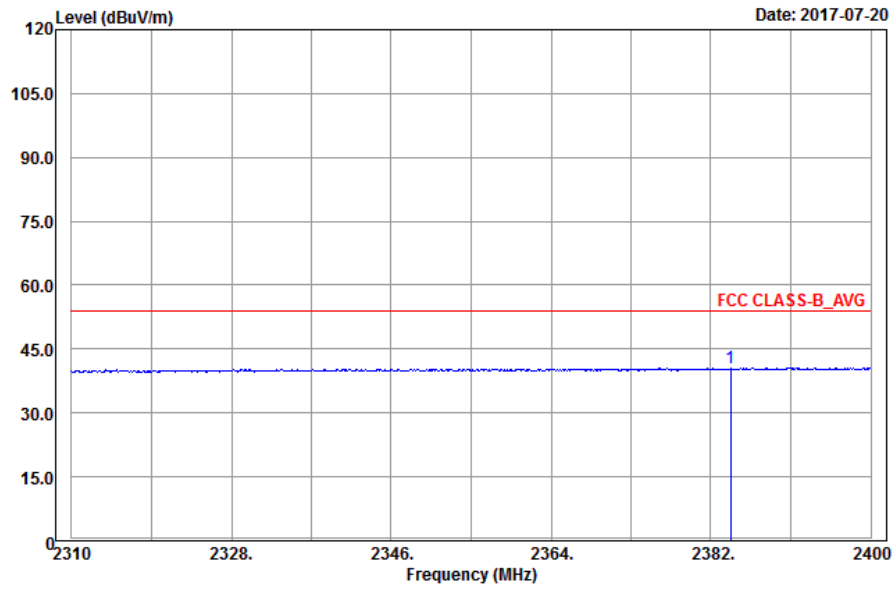

Vertical

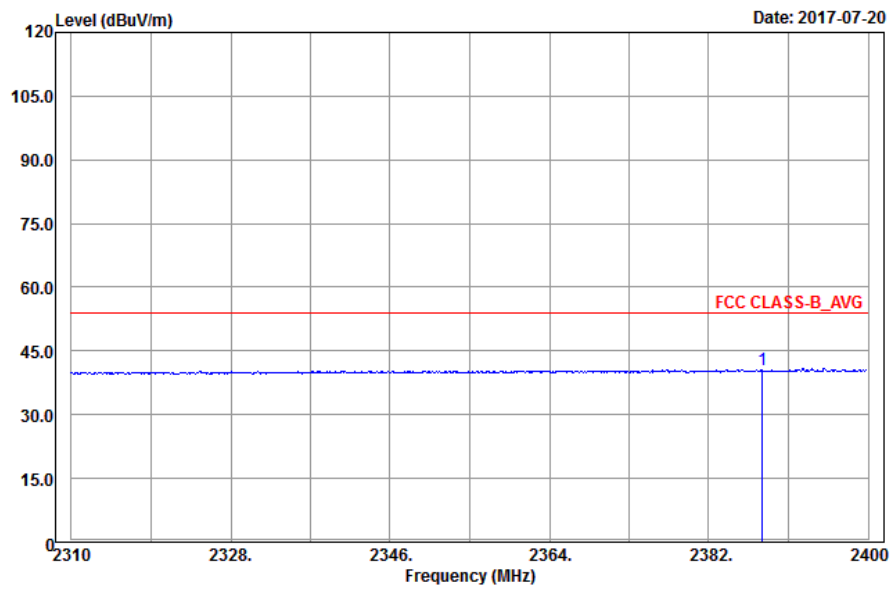

Antenna Polarity & Test Distance: Horizontal at 3 m

Frequency (MHz)	Emission Level (dBuV/m)	Read Level (dBuV)	Limit (dBuV/m)	Margin (dB)	Antenna Factor (dB/m)	Cable Loss (dB)	Preamp Factor (dB)	Antenna Height (cm)	Table Angle (Degree)	Remark
2344.02	51.67	50.1	74	-22.33	31.74	5.33	35.5	100	72	Peak
2384.25	40.53	38.84	54	-13.47	31.78	5.4	35.49	100	72	Average
2402	81.35	79.62			31.8	5.4	35.47	100	72	Average
2402	86.48	84.75			31.8	5.4	35.47	100	72	Peak
4804	40.1	32.01	54	-13.9	33.96	8.25	34.12	106	323	Average
4804	49.58	41.49	74	-24.42	33.96	8.25	34.12	106	323	Peak

Antenna Polarity & Test Distance: Vertical at 3 m

Frequency (MHz)	Emission Level (dBuV/m)	Read Level (dBuV)	Limit (dBuV/m)	Margin (dB)	Antenna Factor (dB/m)	Cable Loss (dB)	Preamp Factor (dB)	Antenna Height (cm)	Table Angle (Degree)	Remark
2360.4	51.79	50.16	74	-22.21	31.76	5.37	35.5	100	295	Peak
2388.03	40.64	38.93	54	-13.36	31.8	5.4	35.49	100	295	Average
2402	80.47	78.74			31.8	5.4	35.47	100	295	Average
2402	85.88	84.15			31.8	5.4	35.47	100	295	Peak
4804	39.88	31.79	54	-14.12	33.96	8.25	34.12	147	145	Average
4804	47.54	39.45	74	-26.46	33.96	8.25	34.12	147	145	Peak

Remarks:

- Emission Level = Read Level + Antenna Factor + Cable Loss - Preamp Factor
Margin value = Emission level – Limit value
- 2402 MHz: Fundamental frequency.

EUT Test Condition		Measurement Detail	
Channel	Channel 39	Frequency Range	1 GHz ~ 25 GHz
Input Power	120 Vac, 60 Hz	Detector Function	Peak (PK) Average (AV)
Environmental Conditions	25 deg. C, 65 % RH	Tested By	Charles Hsiao

Horizontal

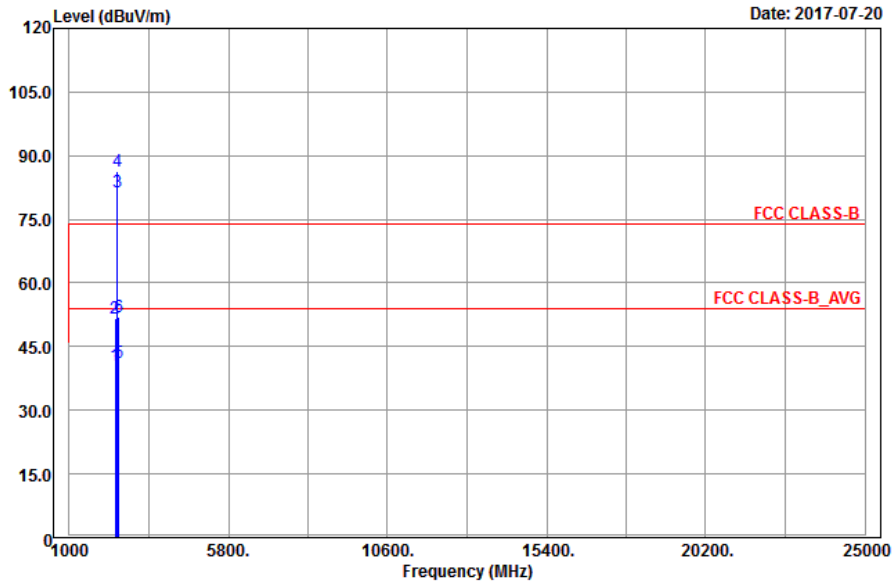

Vertical

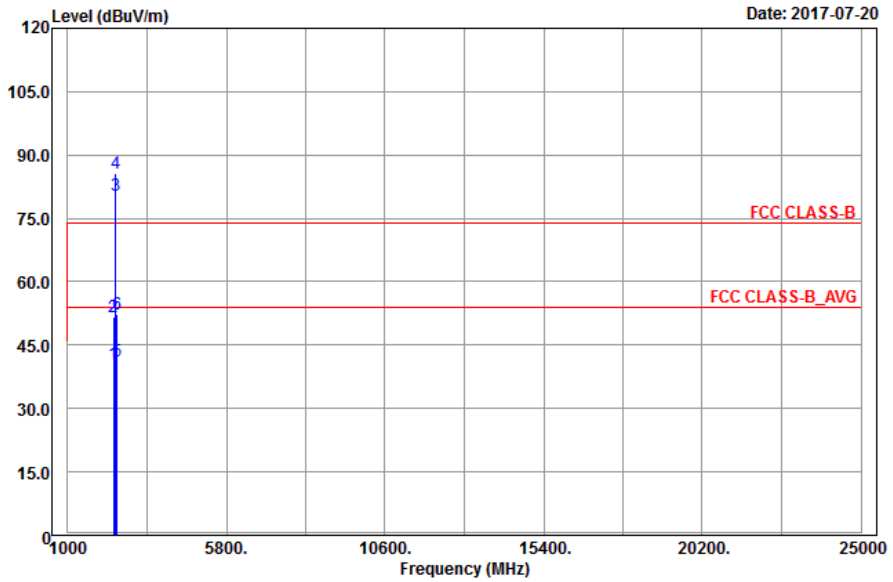

Antenna Polarity & Test Distance: Horizontal at 3 m

Frequency (MHz)	Emission Level (dBuV/m)	Read Level (dBuV)	Limit (dBuV/m)	Margin (dB)	Antenna Factor (dB/m)	Cable Loss (dB)	Preamp Factor (dB)	Antenna Height (cm)	Table Angle (Degree)	Remark
2382.81	40.57	38.88	54	-13.43	31.78	5.4	35.49	100	72	Average
2387.76	51.58	49.87	74	-22.42	31.8	5.4	35.49	100	72	Peak
2441	81.54	79.67			31.85	5.46	35.44	100	72	Average
2441	86.29	84.42			31.85	5.46	35.44	100	72	Peak
2487.04	41.1	39.11	54	-12.9	31.88	5.53	35.42	100	72	Average
2494.12	51.92	49.9	74	-22.08	31.9	5.53	35.41	100	72	Peak

Antenna Polarity & Test Distance: Vertical at 3 m

Frequency (MHz)	Emission Level (dBuV/m)	Read Level (dBuV)	Limit (dBuV/m)	Margin (dB)	Antenna Factor (dB/m)	Cable Loss (dB)	Preamp Factor (dB)	Antenna Height (cm)	Table Angle (Degree)	Remark
2384.07	40.56	38.87	54	-13.44	31.78	5.4	35.49	100	295	Average
2388.48	51.81	50.1	74	-22.19	31.8	5.4	35.49	100	295	Peak
2441	80.58	78.71			31.85	5.46	35.44	100	295	Average
2441	85.65	83.78			31.85	5.46	35.44	100	295	Peak
2490.12	41.27	39.26	54	-12.73	31.9	5.53	35.42	100	295	Average
2496.6	52.37	50.35	74	-21.63	31.9	5.53	35.41	100	295	Peak

Remarks:

- Emission Level = Read Level + Antenna Factor + Cable Loss - Preamp Factor
Margin value = Emission level – Limit value
- 2441 MHz: Fundamental frequency.

EUT Test Condition		Measurement Detail	
Channel	Channel 78	Frequency Range	1 GHz ~ 25 GHz
Input Power	120 Vac, 60 Hz	Detector Function	Peak (PK) Average (AV)
Environmental Conditions	25 deg. C, 65 % RH	Tested By	Charles Hsiao

Horizontal

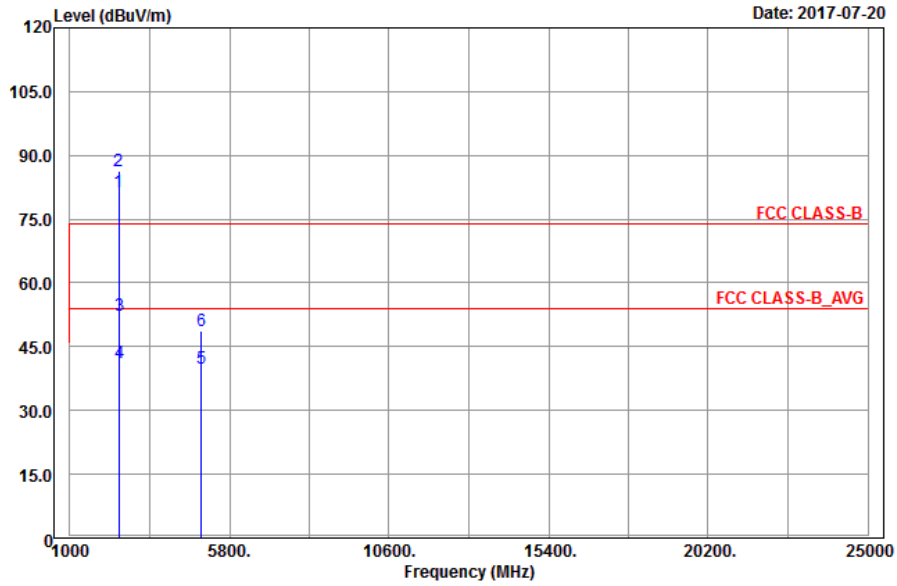

Vertical

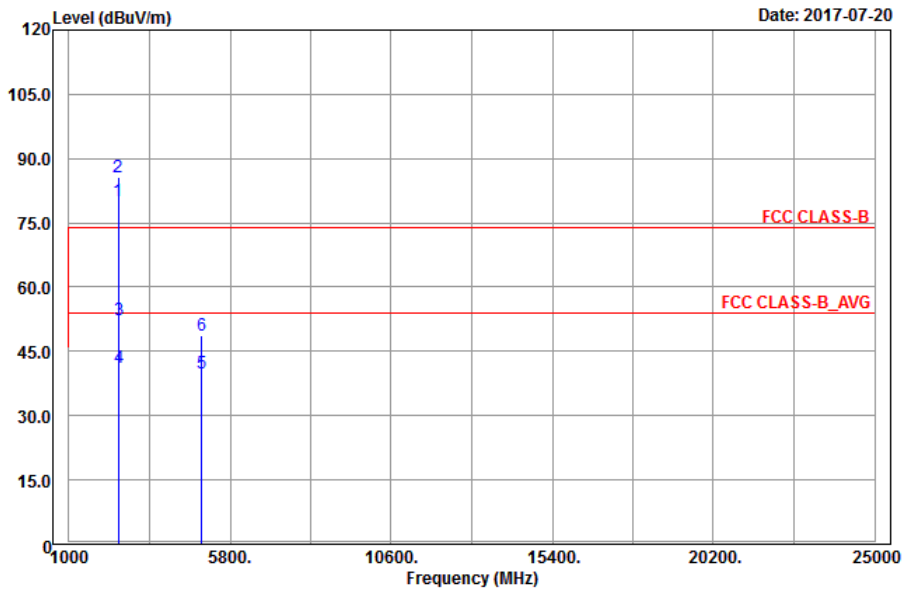

**Band Edge
Peak
Horizontal**

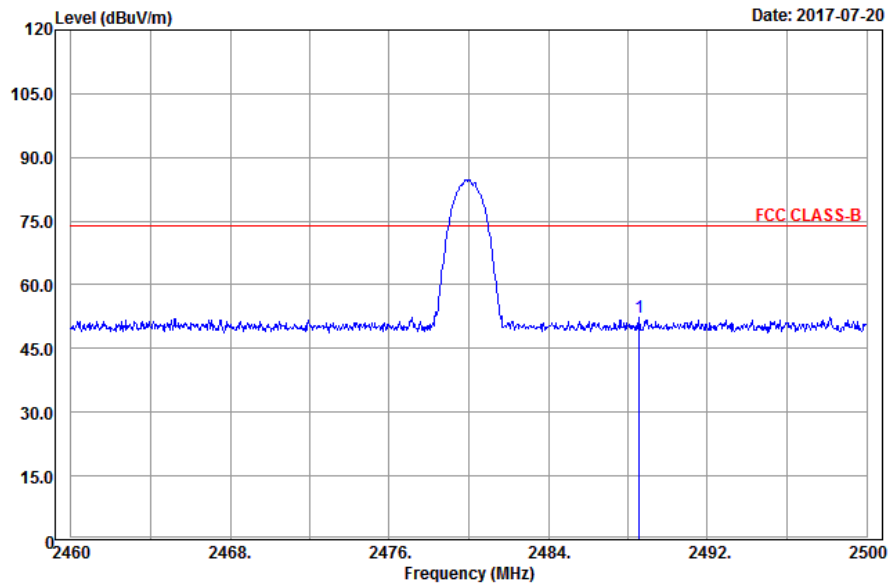

Vertical

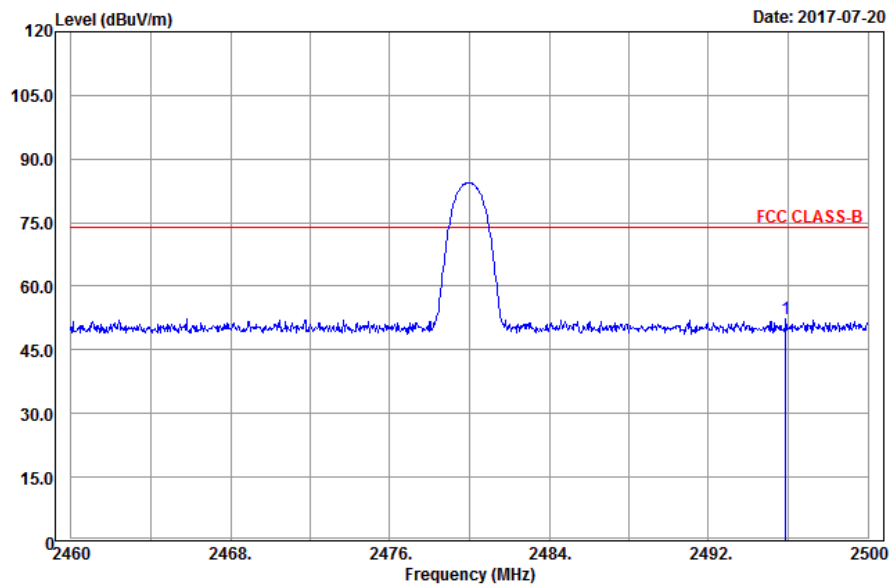

Average Horizontal

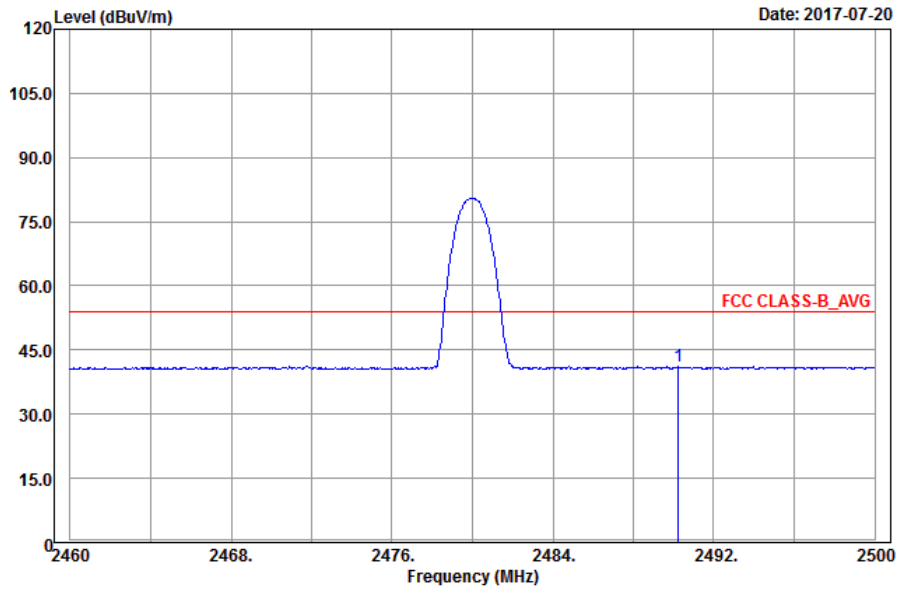

Vertical

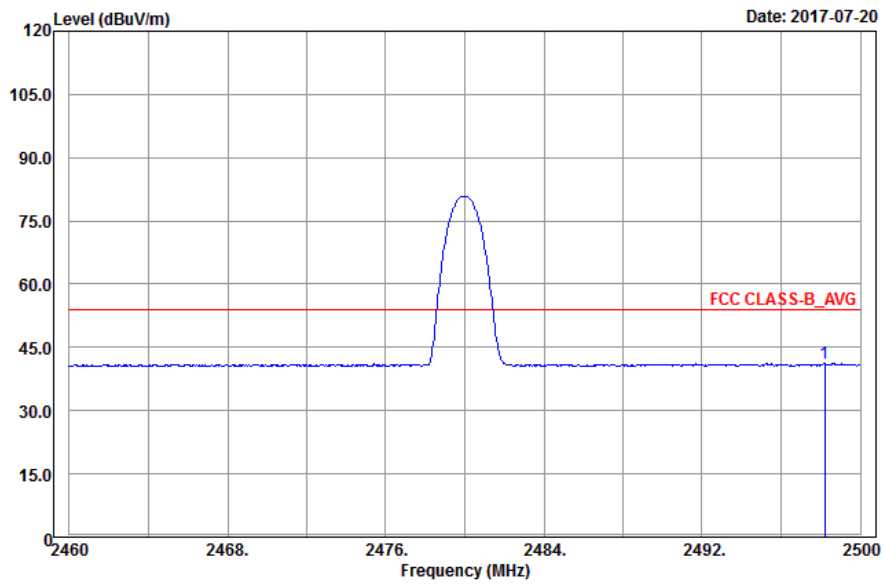

Antenna Polarity & Test Distance: Horizontal at 3 m

Frequency (MHz)	Emission Level (dBuV/m)	Read Level (dBuV)	Limit (dBuV/m)	Margin (dB)	Antenna Factor (dB/m)	Cable Loss (dB)	Preamp Factor (dB)	Antenna Height (cm)	Table Angle (Degree)	Remark
2480	81.35	79.39			31.88	5.5	35.42	109	72	Average
2480	86.48	84.52			31.88	5.5	35.42	109	72	Peak
2488.56	52.21	50.2	74	-21.79	31.9	5.53	35.42	109	72	Peak
2490.24	41.06	39.05	54	-12.94	31.9	5.53	35.42	109	72	Average
4960	39.93	31.66	54	-14.07	33.99	8.29	34.01	105	17	Average
4960	48.83	40.56	74	-25.17	33.99	8.29	34.01	105	17	Peak

Antenna Polarity & Test Distance: Vertical at 3 m

Frequency (MHz)	Emission Level (dBuV/m)	Read Level (dBuV)	Limit (dBuV/m)	Margin (dB)	Antenna Factor (dB/m)	Cable Loss (dB)	Preamp Factor (dB)	Antenna Height (cm)	Table Angle (Degree)	Remark
2480	80.19	78.23			31.88	5.5	35.42	100	295	Average
2480	85.64	83.68			31.88	5.5	35.42	100	295	Peak
2495.88	52.31	50.29	74	-21.69	31.9	5.53	35.41	100	295	Peak
2498.2	41.18	39.16	54	-12.82	31.9	5.53	35.41	100	295	Average
4960	40.03	31.76	54	-13.97	33.99	8.29	34.01	199	310	Average
4960	48.69	40.42	74	-25.31	33.99	8.29	34.01	199	310	Peak

Remarks:

1. Emission Level = Read Level + Antenna Factor + Cable Loss - Preamp Factor

Margin value = Emission level – Limit value

2. 2480 MHz: Fundamental frequency.

Mode B
8DPSK

EUT Test Condition		Measurement Detail	
Channel	Channel 0	Frequency Range	1 GHz ~ 25 GHz
Input Power	120 Vac, 60 Hz	Detector Function	Peak (PK) Average (AV)
Environmental Conditions	25 deg. C, 65 % RH	Tested By	Harry Hsueh

Horizontal

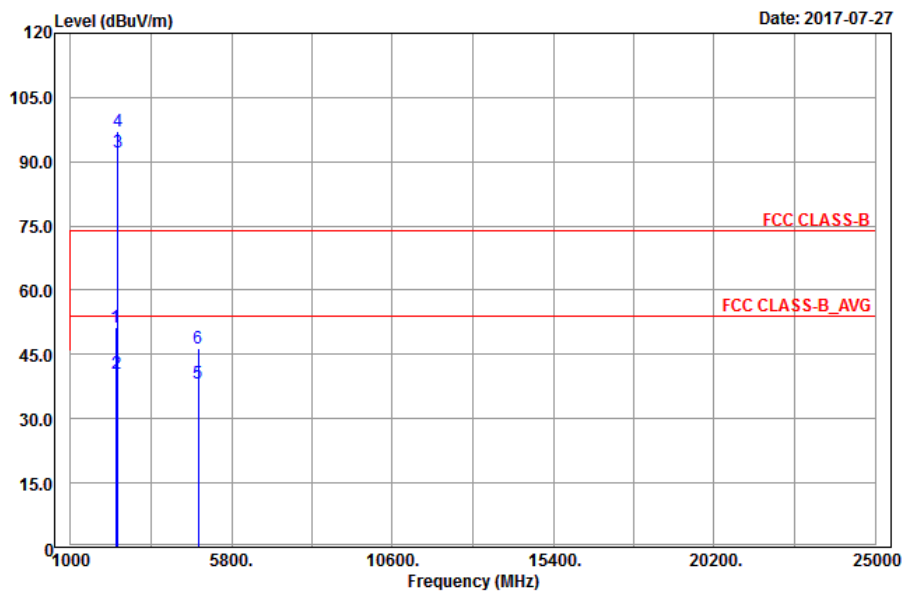

Vertical

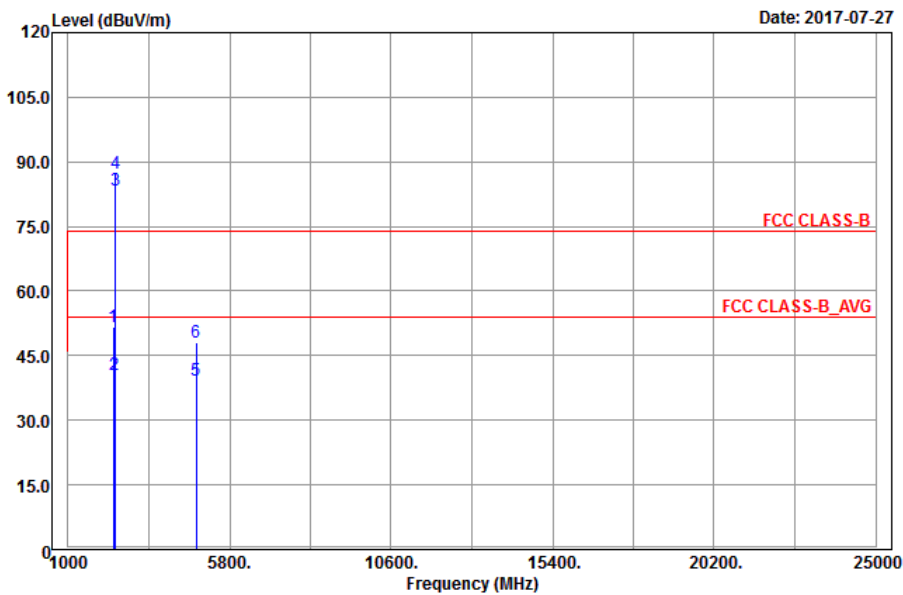

**Band Edge
Peak
Horizontal**

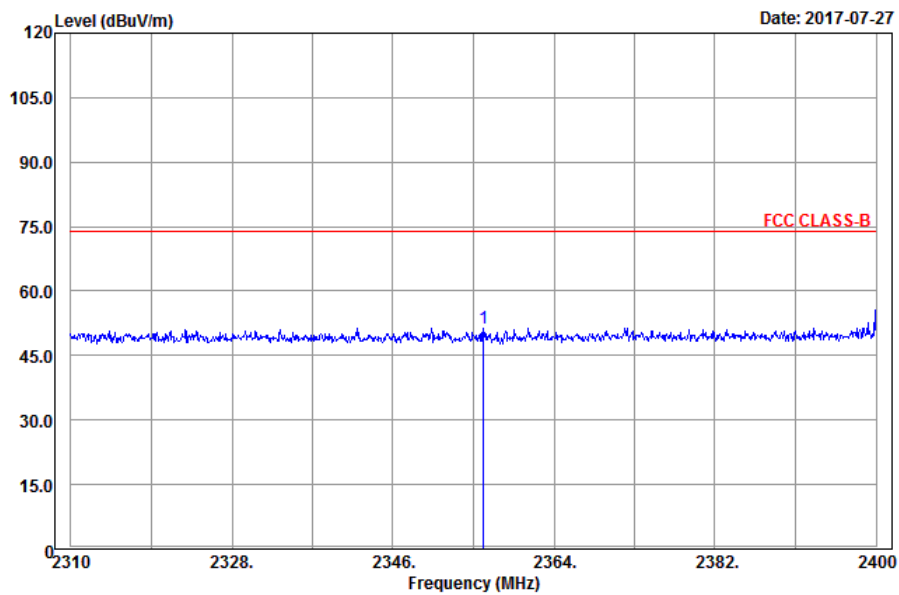

Vertical

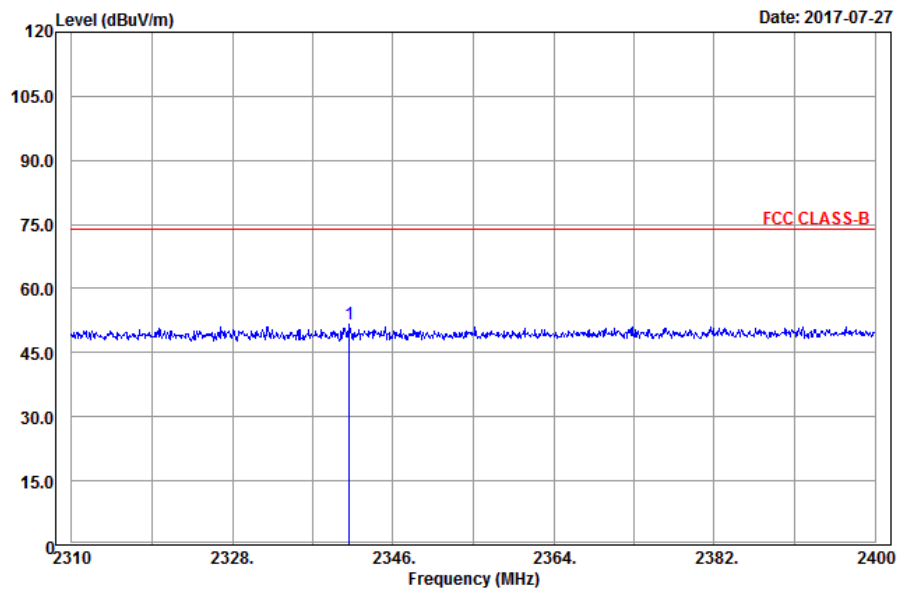

Average Horizontal

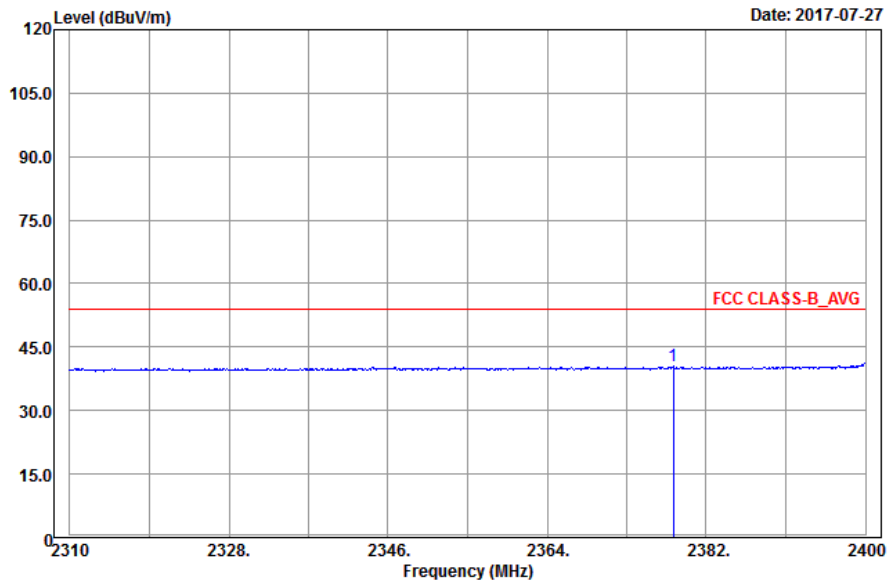

Vertical

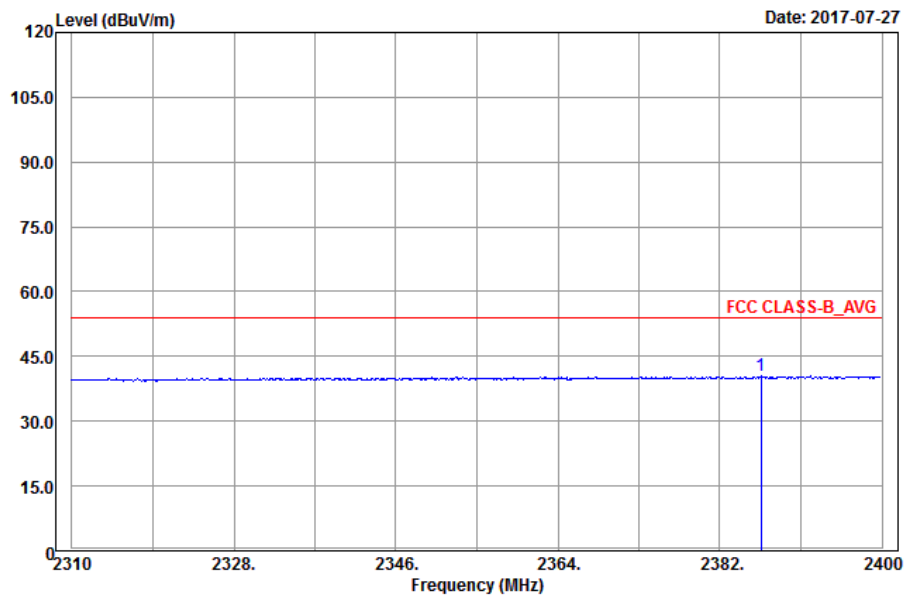

Antenna Polarity & Test Distance: Horizontal at 3 m

Frequency (MHz)	Emission Level (dBuV/m)	Read Level (dBuV)	Limit (dBuV/m)	Margin (dB)	Antenna Factor (dB/m)	Cable Loss (dB)	Preamp Factor (dB)	Antenna Height (cm)	Table Angle (Degree)	Remark
2356.17	51.47	49.84	74	-22.53	31.76	5.37	35.5	125	339	Peak
2378.31	40.49	38.83	54	-13.51	31.78	5.37	35.49	125	339	Average
2402	92.06	90.33			31.8	5.4	35.47	125	339	Average
2402	97.12	95.39			31.8	5.4	35.47	125	339	Peak
4804	38.21	30.12	54	-15.79	33.96	8.25	34.12	152	304	Average
4804	46.49	38.4	74	-27.51	33.96	8.25	34.12	152	304	Peak

Antenna Polarity & Test Distance: Vertical at 3 m

Frequency (MHz)	Emission Level (dBuV/m)	Read Level (dBuV)	Limit (dBuV/m)	Margin (dB)	Antenna Factor (dB/m)	Cable Loss (dB)	Preamp Factor (dB)	Antenna Height (cm)	Table Angle (Degree)	Remark
2341.14	51.61	50.04	74	-22.39	31.74	5.33	35.5	147	199	Peak
2386.59	40.4	38.69	54	-13.6	31.8	5.4	35.49	147	199	Average
2402	83.42	81.69			31.8	5.4	35.47	147	199	Average
2402	87.4	85.67			31.8	5.4	35.47	147	199	Peak
4804	39.13	31.04	54	-14.87	33.96	8.25	34.12	164	274	Average
4804	48.01	39.92	74	-25.99	33.96	8.25	34.12	164	274	Peak

Remarks:

- Emission Level = Read Level + Antenna Factor + Cable Loss - Preamp Factor
Margin value = Emission level – Limit value
- 2402 MHz: Fundamental frequency.

EUT Test Condition		Measurement Detail	
Channel	Channel 39	Frequency Range	1 GHz ~ 25 GHz
Input Power	120 Vac, 60 Hz	Detector Function	Peak (PK) Average (AV)
Environmental Conditions	25 deg. C, 65 % RH	Tested By	Harry Hsueh

Horizontal

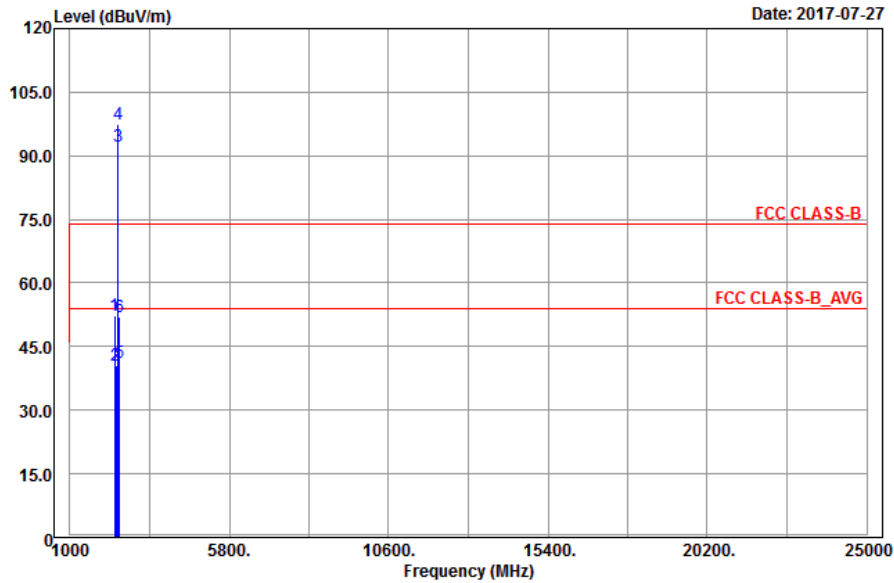

Vertical

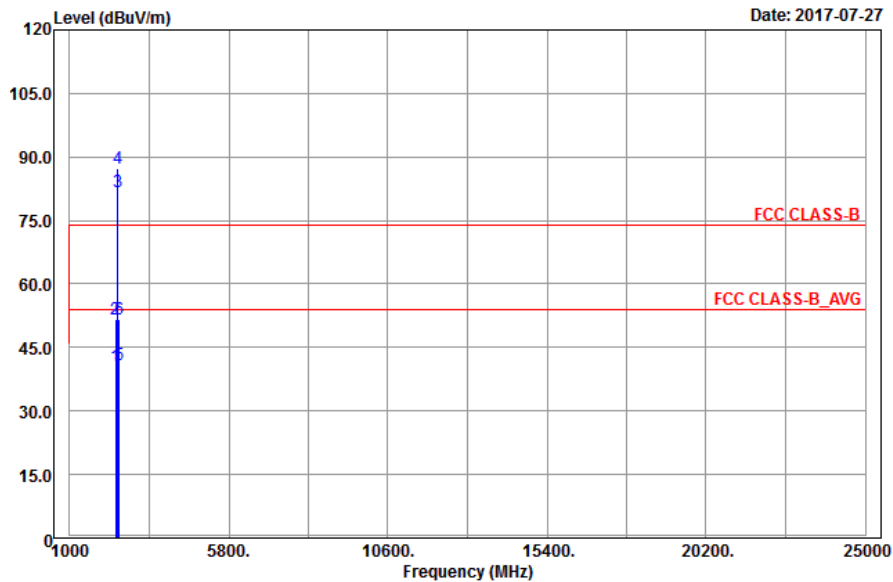

Antenna Polarity & Test Distance: Horizontal at 3 m

Frequency (MHz)	Emission Level (dBuV/m)	Read Level (dBuV)	Limit (dBuV/m)	Margin (dB)	Antenna Factor (dB/m)	Cable Loss (dB)	Preamp Factor (dB)	Antenna Height (cm)	Table Angle (Degree)	Remark
2347.62	52.21	50.64	74	-21.79	31.74	5.33	35.5	124	338	Peak
2380.74	40.46	38.77	54	-13.54	31.78	5.4	35.49	124	338	Average
2441	92.17	90.3			31.85	5.46	35.44	124	338	Average
2441	97.32	95.45			31.85	5.46	35.44	124	338	Peak
2488.88	41.04	39.03	54	-12.96	31.9	5.53	35.42	124	338	Average
2489.72	51.84	49.83	74	-22.16	31.9	5.53	35.42	124	338	Peak

Antenna Polarity & Test Distance: Vertical at 3 m

Frequency (MHz)	Emission Level (dBuV/m)	Read Level (dBuV)	Limit (dBuV/m)	Margin (dB)	Antenna Factor (dB/m)	Cable Loss (dB)	Preamp Factor (dB)	Antenna Height (cm)	Table Angle (Degree)	Remark
2385.33	40.42	38.73	54	-13.58	31.78	5.4	35.49	147	199	Average
2386.68	51.69	49.98	74	-22.31	31.8	5.4	35.49	147	199	Peak
2441	81.88	80.01			31.85	5.46	35.44	147	199	Average
2441	87.25	85.38			31.85	5.46	35.44	147	199	Peak
2494.08	40.97	38.95	54	-13.03	31.9	5.53	35.41	147	199	Average
2495.8	51.75	49.73	74	-22.25	31.9	5.53	35.41	147	199	Peak

Remarks:

- Emission Level = Read Level + Antenna Factor + Cable Loss - Preamp Factor
Margin value = Emission level – Limit value
- 2441 MHz: Fundamental frequency.

EUT Test Condition		Measurement Detail	
Channel	Channel 78	Frequency Range	1 GHz ~ 25 GHz
Input Power	120 Vac, 60 Hz	Detector Function	Peak (PK) Average (AV)
Environmental Conditions	25 deg. C, 65 % RH	Tested By	Harry Hsueh

Horizontal

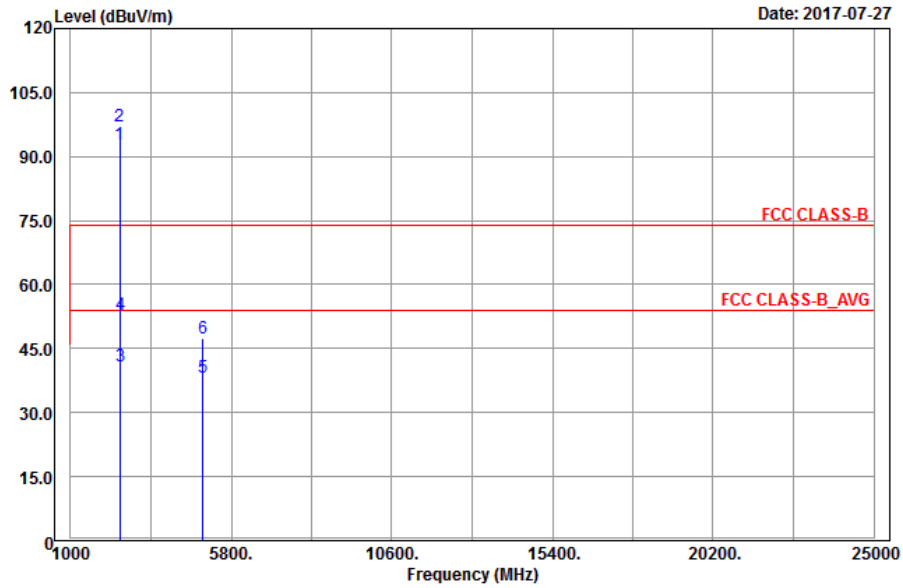

Vertical

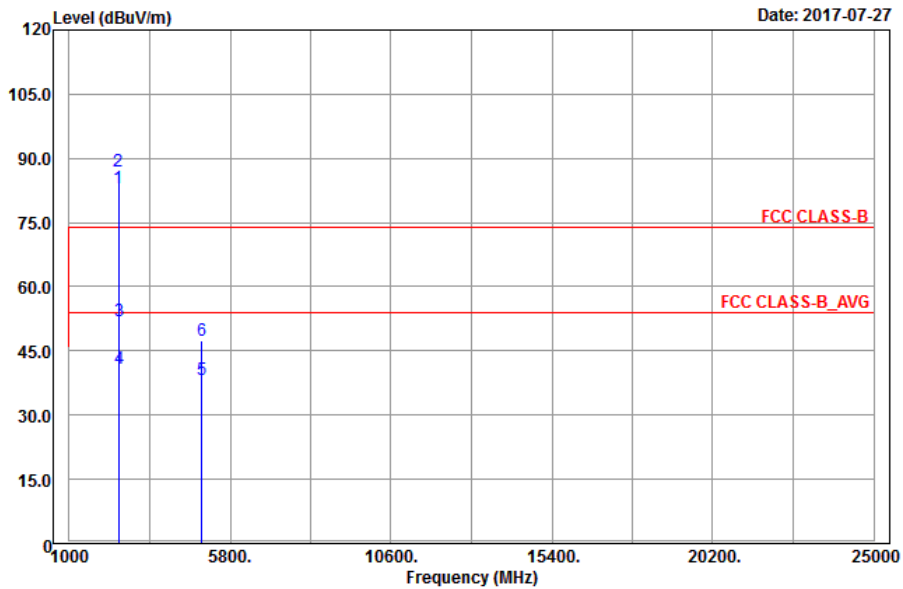

**Band Edge
Peak
Horizontal**

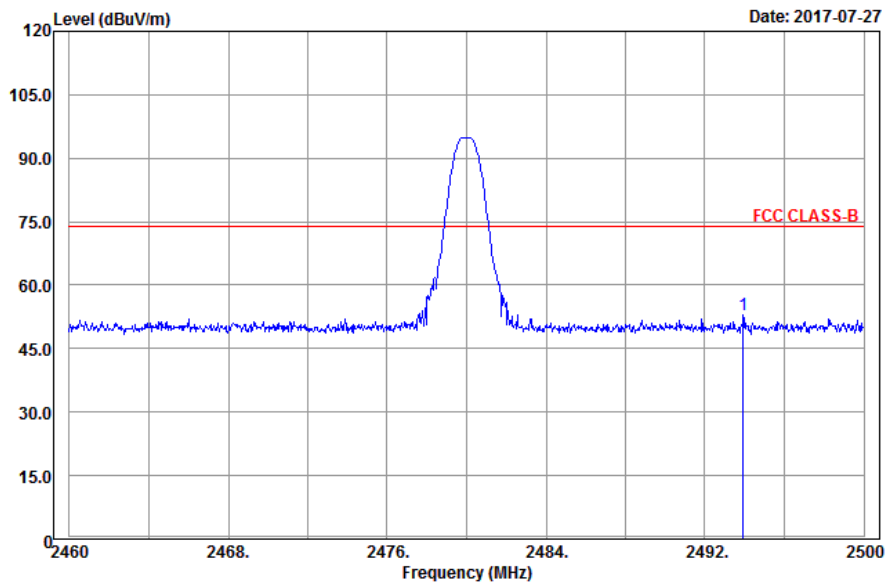

Vertical

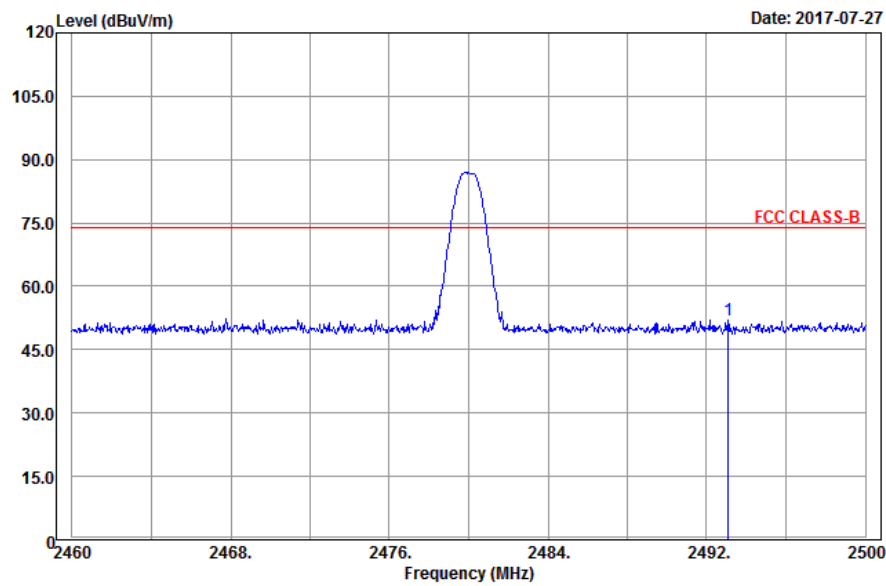

**Average
Horizontal**

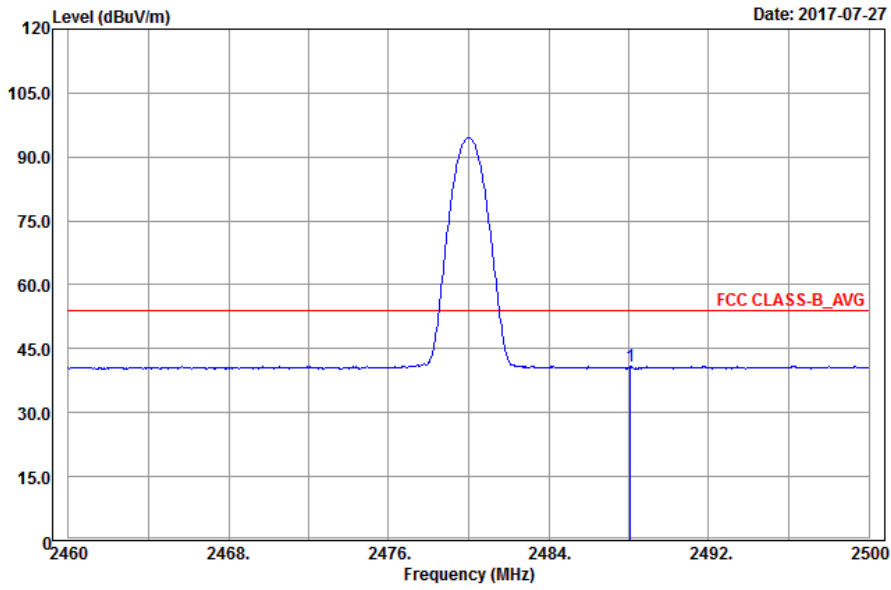

Vertical

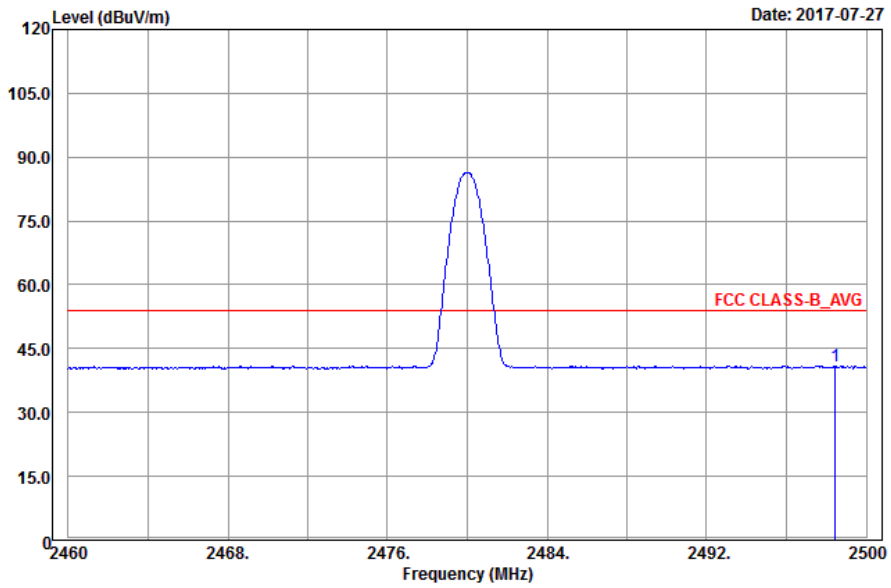

Antenna Polarity & Test Distance: Horizontal at 3 m

Frequency (MHz)	Emission Level (dBuV/m)	Read Level (dBuV)	Limit (dBuV/m)	Margin (dB)	Antenna Factor (dB/m)	Cable Loss (dB)	Preamp Factor (dB)	Antenna Height (cm)	Table Angle (Degree)	Remark
2480	92.95	90.99			31.88	5.5	35.42	120	338	Average
2480	97.03	95.07			31.88	5.5	35.42	120	338	Peak
2488.08	40.9	38.89	54	-13.1	31.9	5.53	35.42	120	338	Average
2493.92	52.9	50.88	74	-21.1	31.9	5.53	35.41	120	338	Peak
4960	38.4	30.13	54	-15.6	33.99	8.29	34.01	196	82	Average
4960	47.34	39.07	74	-26.66	33.99	8.29	34.01	196	82	Peak

Antenna Polarity & Test Distance: Vertical at 3 m

Frequency (MHz)	Emission Level (dBuV/m)	Read Level (dBuV)	Limit (dBuV/m)	Margin (dB)	Antenna Factor (dB/m)	Cable Loss (dB)	Preamp Factor (dB)	Antenna Height (cm)	Table Angle (Degree)	Remark
2480	82.91	80.95			31.88	5.5	35.42	140	203	Average
2480	87	85.04			31.88	5.5	35.42	140	203	Peak
2493.08	51.94	49.92	74	-22.06	31.9	5.53	35.41	140	203	Peak
2498.44	40.92	38.9	54	-13.08	31.9	5.53	35.41	140	203	Average
4960	38.41	30.14	54	-15.59	33.99	8.29	34.01	137	108	Average
4960	47.26	38.99	74	-26.74	33.99	8.29	34.01	137	108	Peak

Remarks:

1. Emission Level = Read Level + Antenna Factor + Cable Loss - Preamp Factor

Margin value = Emission level – Limit value

2. 2480 MHz: Fundamental frequency.

9 kHz ~ 30 MHz DATA:

The amplitude of spurious emissions attenuated more than 20 dB below the permissible value is not required to be report.

30 MHz ~ 1 GHz WORST-CASE DATA:

Mode A

EUT Test Condition		Measurement Detail	
Channel	Channel 39	Frequency Range	30 MHz ~ 1 GHz
Input Power	120 Vac, 60 Hz	Detector Function	Peak (PK) Quasi-peak (QP)
Environmental Conditions	25 deg. C, 65 % RH	Tested By	Charles Hsiao

Horizontal

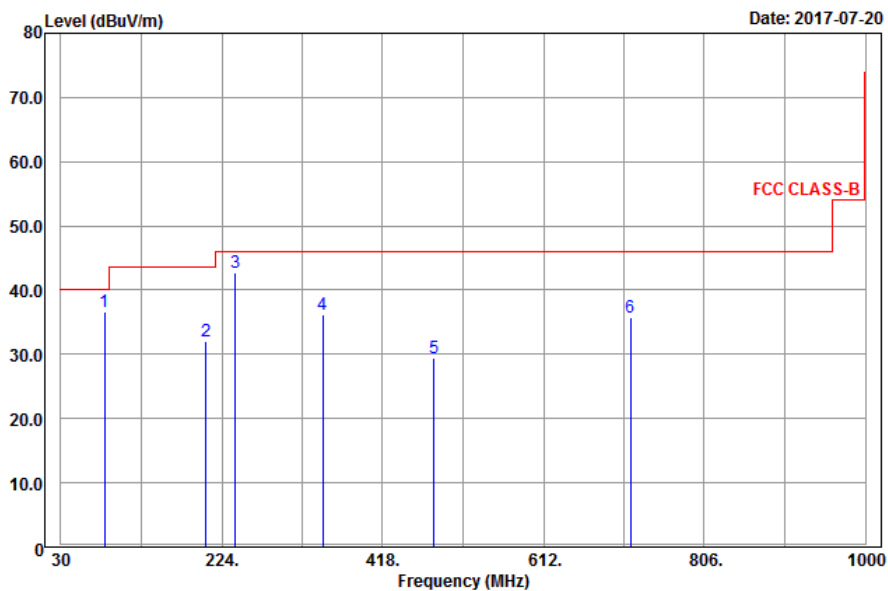

Vertical

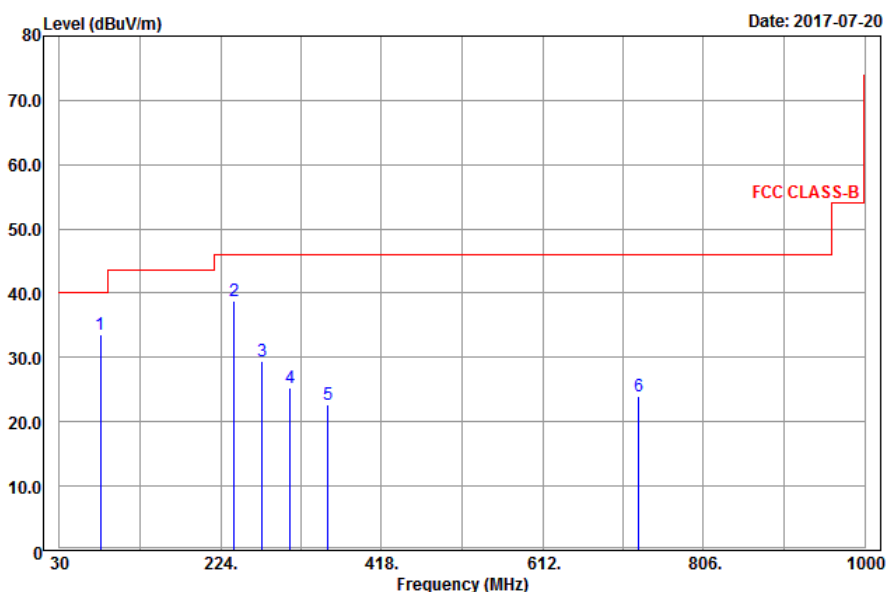

Antenna Polarity & Test Distance: Horizontal at 3 m

Frequency (MHz)	Emission Level (dBuV/m)	Read Level (dBuV)	Limit (dBuV/m)	Margin (dB)	Antenna Factor (dB/m)	Cable Loss (dB)	Preamp Factor (dB)	Antenna Height (cm)	Table Angle (Degree)	Remark
82.65	36.73	59.12	40	-3.27	8.61	1.11	32.11	105	185	Peak
205.23	32.04	51.54	43.5	-11.46	11.12	1.65	32.27	144	159	Peak
240.06	42.82	61	46	-3.18	12.1	1.85	32.13	114	360	QP
346.2	36.27	51.99	46	-9.73	14.16	2.19	32.07	188	75	Peak
479.9	29.4	42.89	46	-16.6	16.07	2.56	32.12	115	312	Peak
717.2	35.75	45.28	46	-10.25	19.47	3.11	32.11	149	194	Peak

Antenna Polarity & Test Distance: Vertical at 3 m

Frequency (MHz)	Emission Level (dBuV/m)	Read Level (dBuV)	Limit (dBuV/m)	Margin (dB)	Antenna Factor (dB/m)	Cable Loss (dB)	Preamp Factor (dB)	Antenna Height (cm)	Table Angle (Degree)	Remark
79.41	33.63	56.47	40	-6.37	8.26	1.11	32.21	141	313	Peak
240.06	38.72	56.9	46	-7.28	12.1	1.85	32.13	182	273	Peak
274.08	29.38	46.88	46	-16.62	12.68	1.94	32.12	199	198	Peak
307.7	25.26	42.05	46	-20.74	13.23	2.11	32.13	188	308	Peak
353.2	22.58	38.21	46	-23.42	14.26	2.19	32.08	142	107	Peak
728.4	23.87	33.23	46	-22.13	19.6	3.16	32.12	124	219	Peak

Remarks:

- Emission Level = Read Level + Antenna Factor + Cable Loss - Preamp Factor
Margin value = Emission level – Limit value

Mode B

EUT Test Condition		Measurement Detail	
Channel	Channel 39	Frequency Range	30 MHz ~ 1 GHz
Input Power	120 Vac, 60 Hz	Detector Function	Peak (PK) Quasi-peak (QP)
Environmental Conditions	25 deg. C, 65 % RH	Tested By	Charles Hsiao

Horizontal

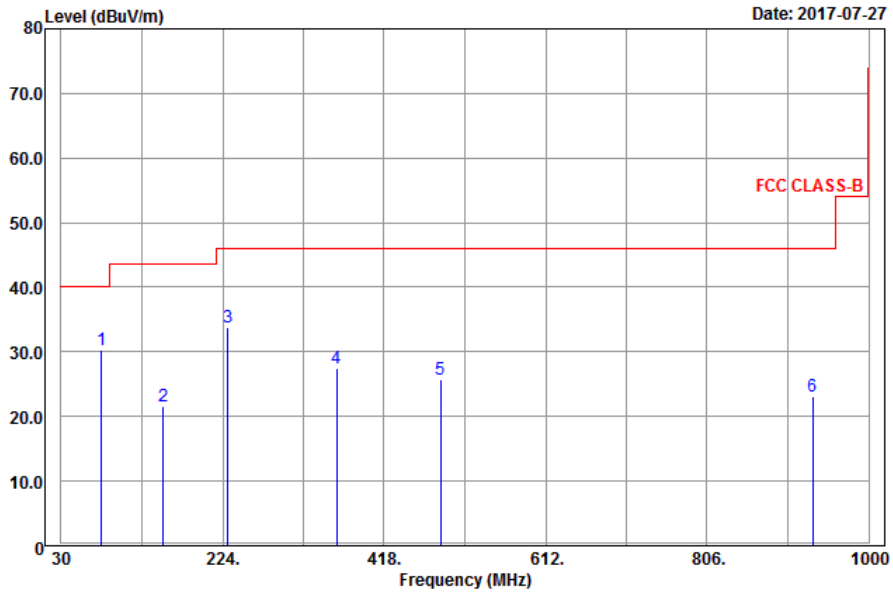

Vertical

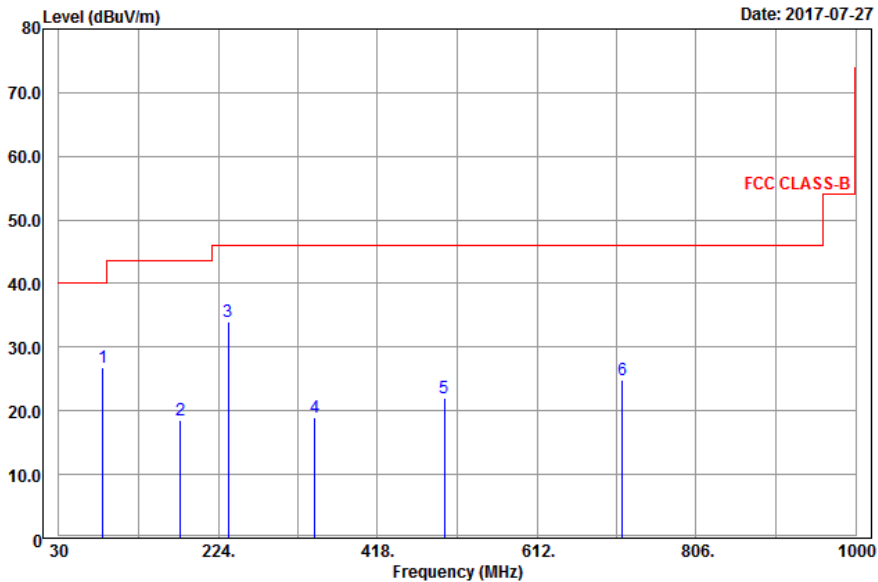

Antenna Polarity & Test Distance: Horizontal at 3 m

Frequency (MHz)	Emission Level (dBuV/m)	Read Level (dBuV)	Limit (dBuV/m)	Margin (dB)	Antenna Factor (dB/m)	Cable Loss (dB)	Preamp Factor (dB)	Antenna Height (cm)	Table Angle (Degree)	Remark
78.33	30.25	53.06	40	-9.75	8.29	1.11	32.21	152	127	Peak
152.58	21.5	43.78	43.5	-22	8.47	1.52	32.27	199	341	Peak
230.07	33.72	52.29	46	-12.28	11.76	1.85	32.18	134	191	Peak
360.9	27.43	42.91	46	-18.57	14.36	2.26	32.1	155	164	Peak
485.5	25.65	38.98	46	-20.35	16.15	2.63	32.11	108	254	Peak
932.8	23.04	29.03	46	-22.96	21.63	3.62	31.24	172	134	Peak

Antenna Polarity & Test Distance: Vertical at 3 m

Frequency (MHz)	Emission Level (dBuV/m)	Read Level (dBuV)	Limit (dBuV/m)	Margin (dB)	Antenna Factor (dB/m)	Cable Loss (dB)	Preamp Factor (dB)	Antenna Height (cm)	Table Angle (Degree)	Remark
83.73	26.75	48.9	40	-13.25	8.8	1.11	32.06	194	136	Peak
177.69	18.47	39.54	43.5	-25.03	9.56	1.61	32.24	177	244	Peak
236.55	34.11	52.43	46	-11.89	11.98	1.85	32.15	146	108	Peak
342	19.02	34.8	46	-26.98	14.11	2.19	32.08	137	54	Peak
499.5	21.91	35.03	46	-24.09	16.35	2.63	32.1	148	101	Peak
715.8	24.89	34.43	46	-21.11	19.46	3.11	32.11	168	162	Peak

Remarks:

- Emission Level = Read Level + Antenna Factor + Cable Loss - Preamp Factor
Margin value = Emission level – Limit value

4.2 Conducted Emission Measurement

4.2.1 Limits of Conducted Emission Measurement

Frequency (MHz)	Conducted Limit (dBuV)	
	Quasi-peak	Average
0.15 - 0.5	66 - 56	56 - 46
0.50 - 5.0	56	46
5.0 - 30.0	60	50

- Note: 1. The lower limit shall apply at the transition frequencies.
 2. The limit decreases in line with the logarithm of the frequency in the range of 0.15 to 0.50 MHz.
 3. All emanations from a class A/B digital device or system, including any network of conductors and apparatus connected thereto, shall not exceed the level of field strengths specified above.

4.2.2 Test Instruments

Description & Manufacturer	Model No.	Serial No.	Date Of Calibration	Due Date Of Calibration
Test Receiver ROHDE & SCHWARZ	ESCI	100613	Nov. 21, 2016	Nov. 20, 2017
RF signal cable (with 10dB PAD) Woken	5D-FB	Cable-cond1-01	Dec. 22, 2016	Dec. 21, 2017
LISN ROHDE & SCHWARZ (EUT)	ESH3-Z5	835239/001	Mar. 10, 2017	Mar. 09, 2018
LISN ROHDE & SCHWARZ (Peripheral)	ESH3-Z5	100311	Jul. 28, 2016	Jul. 27, 2017
Software ADT	BV ADT_Cond_ V7.3.7.3	NA	NA	NA

- Note: 1. The calibration interval of the above test instruments is 12 months and the calibrations are traceable to NML/ROC and NIST/USA.
 2. The test was performed in HwaYa Shielded Room 1.
 3. The VCCI Site Registration No. is C-2040.

4.2.3 Test Procedures

- a. The EUT was placed 0.4 meters from the conducting wall of the shielded room with EUT being connected to the power mains through a line impedance stabilization network (LISN). Other support units were connected to the power mains through another LISN. The two LISNs provide 50 ohm/ 50 uH of coupling impedance for the measuring instrument.
- b. Both lines of the power mains connected to the EUT were checked for maximum conducted interference.
- c. The frequency range from 150 kHz to 30 MHz was searched. Emission levels under (Limit – 20 dB) was not recorded.

Note: All modes of operation were investigated and the worst-case emissions are reported.

4.2.4 Deviation from Test Standard

No deviation.

4.2.5 Test Setup

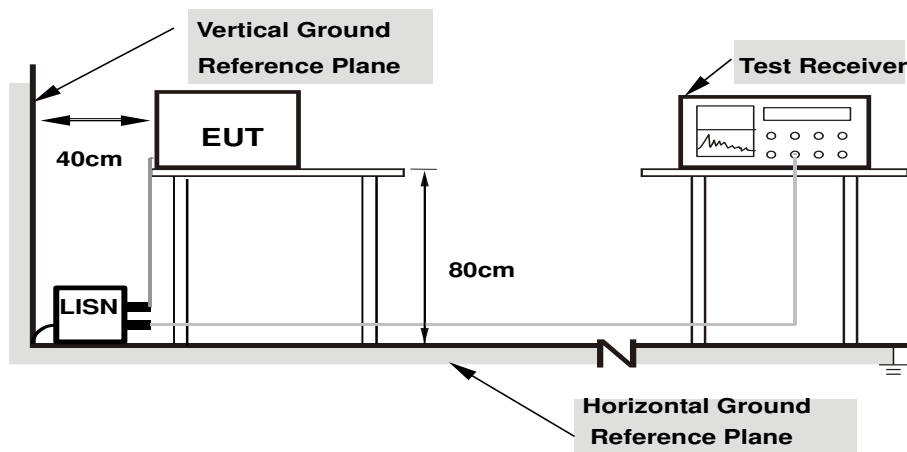

- Note:**
- 1.Support units were connected to second LISN.
 - 2.Both of LISNs (AMN) are 80 cm from EUT and at least 80 from other units and other metal planes

For the actual test configuration, please refer to the attached file (Test Setup Photo).

4.2.6 EUT Operating Condition

Set the EUT under transmission condition continuously at specific channel frequency.

4.2.7 Test Results

CONDUCTED WORST-CASE DATA : 8DPSK

Mode A

Frequency Range	150kHz ~ 30MHz	Detector Function & Resolution Bandwidth	Quasi-Peak (QP) / Average (AV), 9kHz
Input Power	120Vac, 60Hz	Environmental Conditions	25°C, 65%RH
Tested by	Getaz Yang	Test Date	2017/7/21

Phase Of Power : Line (L)										
No	Frequency (MHz)	Correction Factor (dB)	Reading Value (dBuV)		Emission Level (dBuV)		Limit (dBuV)		Margin (dB)	
			Q.P.	AV.	Q.P.	AV.	Q.P.	AV.	Q.P.	AV.
1	0.16569	10.35	29.00	13.77	39.35	24.12	65.17	55.17	-25.82	-31.05
2	0.18910	10.36	24.13	3.92	34.49	14.28	64.08	54.08	-29.59	-39.80
3	0.27903	10.38	14.07	2.17	24.45	12.55	60.84	50.84	-36.39	-38.29
4	0.57228	10.40	29.70	21.62	40.10	32.02	56.00	46.00	-15.90	-13.98
5	2.86354	10.51	14.91	9.77	25.42	20.28	56.00	46.00	-30.58	-25.72
6	6.89084	10.70	14.82	9.64	25.52	20.34	60.00	50.00	-34.48	-29.66

Remarks:

1. Q.P. and AV. are abbreviations of quasi-peak and average individually.
2. The emission levels of other frequencies were very low against the limit.
3. Margin value = Emission level – Limit value
4. Correction factor = Insertion loss + Cable loss
5. Emission Level = Correction Factor + Reading Value

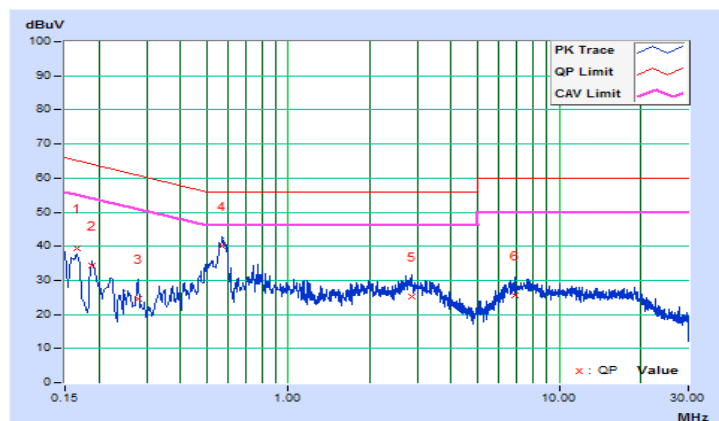

Frequency Range	150kHz ~ 30MHz	Detector Function & Resolution Bandwidth	Quasi-Peak (QP) / Average (AV), 9kHz
Input Power	120Vac, 60Hz	Environmental Conditions	25°C, 65%RH
Tested by	Getaz Yang	Test Date	2017/7/21

Phase Of Power : Neutral (N)										
No	Frequency (MHz)	Correction Factor (dB)	Reading Value (dBuV)		Emission Level (dBuV)		Limit (dBuV)		Margin (dB)	
			Q.P.	AV.	Q.P.	AV.	Q.P.	AV.	Q.P.	AV.
1	0.15391	10.11	29.42	17.28	39.53	27.39	65.79	55.79	-26.26	-28.40
2	0.17744	10.12	28.75	15.38	38.87	25.50	64.60	54.60	-25.73	-29.10
3	0.55664	10.16	26.43	17.34	36.59	27.50	56.00	46.00	-19.41	-18.50
4	0.76789	10.17	17.74	10.25	27.91	20.42	56.00	46.00	-28.09	-25.58
5	2.84399	10.28	15.05	9.70	25.33	19.98	56.00	46.00	-30.67	-26.02
6	6.51939	10.43	15.58	10.06	26.01	20.49	60.00	50.00	-33.99	-29.51

Remarks:

1. Q.P. and AV. are abbreviations of quasi-peak and average individually.
2. The emission levels of other frequencies were very low against the limit.
3. Margin value = Emission level – Limit value
4. Correction factor = Insertion loss + Cable loss
5. Emission Level = Correction Factor + Reading Value

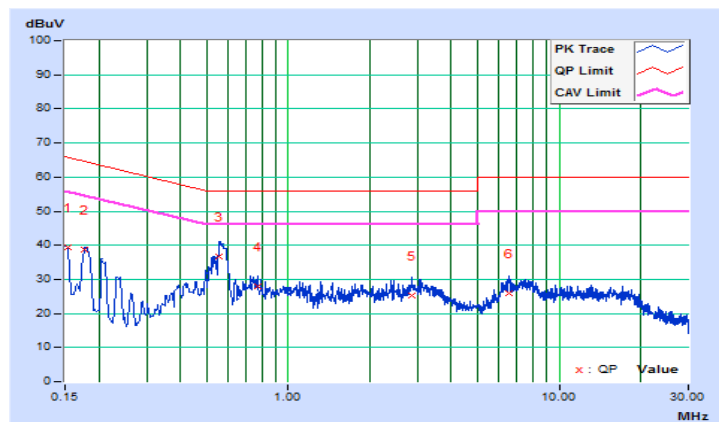

Mode B

Frequency Range	150kHz ~ 30MHz	Detector Function & Resolution Bandwidth	Quasi-Peak (QP) / Average (AV), 9kHz
Input Power	120Vac, 60Hz	Environmental Conditions	25°C, 65%RH
Tested by	Getaz Yang	Test Date	2017/7/25

Phase Of Power : Line (L)										
No	Frequency (MHz)	Correction Factor (dB)	Reading Value (dBuV)		Emission Level (dBuV)		Limit (dBuV)		Margin (dB)	
			Q.P.	AV.	Q.P.	AV.	Q.P.	AV.	Q.P.	AV.
1	0.16173	10.35	39.18	22.65	49.53	33.00	65.37	55.37	-15.84	-22.37
2	0.18910	10.36	34.59	18.59	44.95	28.95	64.08	54.08	-19.13	-25.13
3	0.23586	10.38	31.61	18.06	41.99	28.44	62.24	52.24	-20.25	-23.80
4	0.41588	10.40	20.93	11.60	31.33	22.00	57.53	47.53	-26.20	-25.53
5	1.47940	10.43	17.38	11.63	27.81	22.06	56.00	46.00	-28.19	-23.94
6	4.00526	10.57	10.99	5.89	21.56	16.46	56.00	46.00	-34.44	-29.54

Remarks:

1. Q.P. and AV. are abbreviations of quasi-peak and average individually.
2. The emission levels of other frequencies were very low against the limit.
3. Margin value = Emission level – Limit value
4. Correction factor = Insertion loss + Cable loss
5. Emission Level = Correction Factor + Reading Value

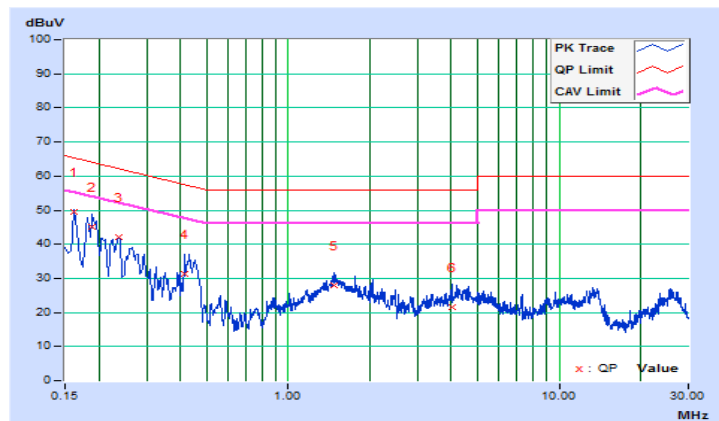

Frequency Range	150kHz ~ 30MHz	Detector Function & Resolution Bandwidth	Quasi-Peak (QP) / Average (AV), 9kHz
Input Power	120Vac, 60Hz	Environmental Conditions	25°C, 65%RH
Tested by	Getaz Yang	Test Date	2017/7/25

Phase Of Power : Neutral (N)										
No	Frequency (MHz)	Correction Factor (dB)	Reading Value (dBuV)		Emission Level (dBuV)		Limit (dBuV)		Margin (dB)	
			Q.P.	AV.	Q.P.	AV.	Q.P.	AV.	Q.P.	AV.
1	0.16569	10.12	37.33	22.32	47.45	32.44	65.17	55.17	-17.72	-22.73
2	0.19301	10.14	33.53	19.77	43.67	29.91	63.91	53.91	-20.24	-24.00
3	0.27903	10.15	22.31	9.82	32.46	19.97	60.84	50.84	-28.38	-30.87
4	0.44325	10.16	18.15	8.31	28.31	18.47	57.00	47.00	-28.69	-28.53
5	1.59670	10.21	14.86	9.30	25.07	19.51	56.00	46.00	-30.93	-26.49
6	13.79590	10.70	11.60	4.54	22.30	15.24	60.00	50.00	-37.70	-34.76

Remarks:

1. Q.P. and AV. are abbreviations of quasi-peak and average individually.
2. The emission levels of other frequencies were very low against the limit.
3. Margin value = Emission level – Limit value
4. Correction factor = Insertion loss + Cable loss
5. Emission Level = Correction Factor + Reading Value

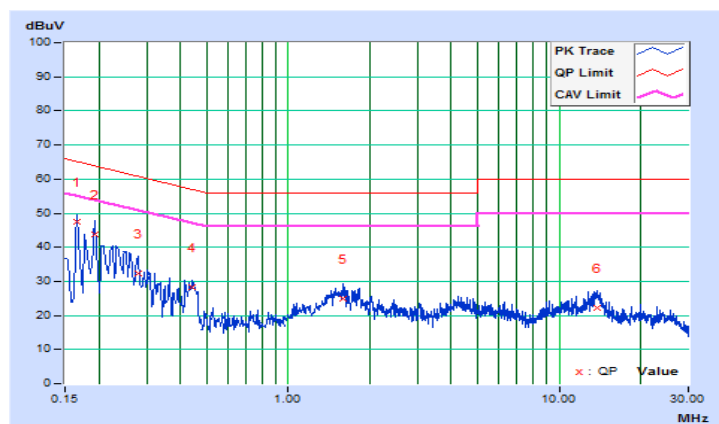

4.3 Number of Hopping Frequency Used

4.3.1 Limits of Hopping Frequency Used Measurement

At least 15 channels frequencies, and should be equally spaced.

4.3.2 Test Setup

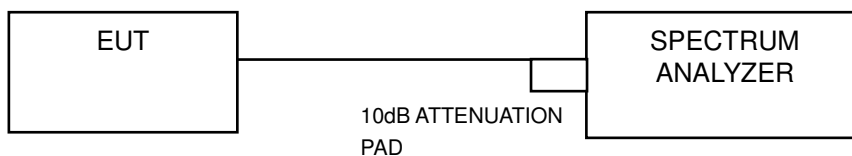

4.3.3 Test Instruments

Refer to section 4.1.2 to get information of above instrument.

4.3.4 Test Procedure

- Check the calibration of the measuring instrument (SA) using either an internal calibrator or a known signal from an external generator.
- Turn on the EUT and connect its antenna terminal to measurement via a low loss cable. Then set it to any one measured frequency within its operating range and make sure the instrument is operated in its linear range.
- Set the SA on MaxHold Mode, and then keep the EUT in hopping mode. Record all the signals from each channel until each one has been recorded.
- Set the SA on View mode and then plot the result on SA screen.
- Repeat above procedures until all frequencies measured were complete.

4.3.5 Deviation from Test Standard

No deviation.

4.3.6 Test Results

There are 79 hopping frequencies in the hopping mode. Please refer to next page for the test result. On the plots, it shows that the hopping frequencies are equally spaced.

8DPSK

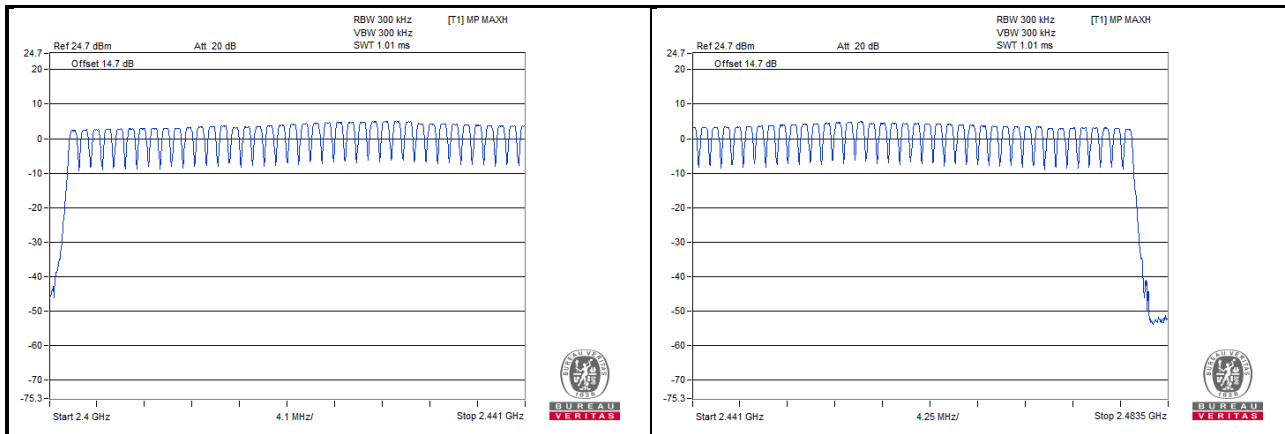

4.4 Dwell Time on Each Channel

4.4.1 Limits of Dwell Time on Each Channel Measurement

The average time of occupancy on any channel shall not be greater than 0.4 seconds within a period of 0.4 seconds multiplied by the number of hopping channels employed.

4.4.2 Test Setup

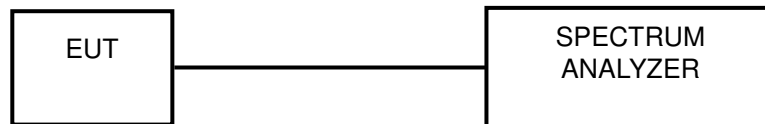

4.4.3 Test Instruments

Refer to section 4.1.2 to get information of above instrument.

4.4.4 Test Procedures

- a. Check the calibration of the measuring instrument (SA) using either an internal calibrator or a known signal from an external generator.
- b. Turn on the EUT and connect its antenna terminal to measurement via a low loss cable. Then set it to any one measured frequency within its operating range and make sure the instrument is operated in its linear range.
- c. Adjust the center frequency of SA on any frequency be measured and set SA to zero span mode. And then, set RBW and VBW of spectrum analyzer to proper value.
- d. Measure the time duration of one transmission on the measured frequency. And then plot the result with time difference of this time duration.
- e. Repeat above procedures until all different time-slot modes have been completed.

4.4.5 Deviation from Test Standard

No deviation.

4.4.6 Test Results

GFSK

Mode	Number of transmission in a 31.6 (79 Hopping*0.4)	Length of transmission time (msec)	Result (msec)	Limit (sec)
DH1	50 (times / 5 sec) * 6.32 = 316 times	0.42	132.72	0.4
DH3	27 (times / 5 sec) * 6.32 = 170.64 times	1.67	284.97	0.4
DH5	17 (times / 5 sec) * 6.32 = 107.44 times	2.915	313.19	0.4

Note: Test plots of the transmitting time slot are shown as below.

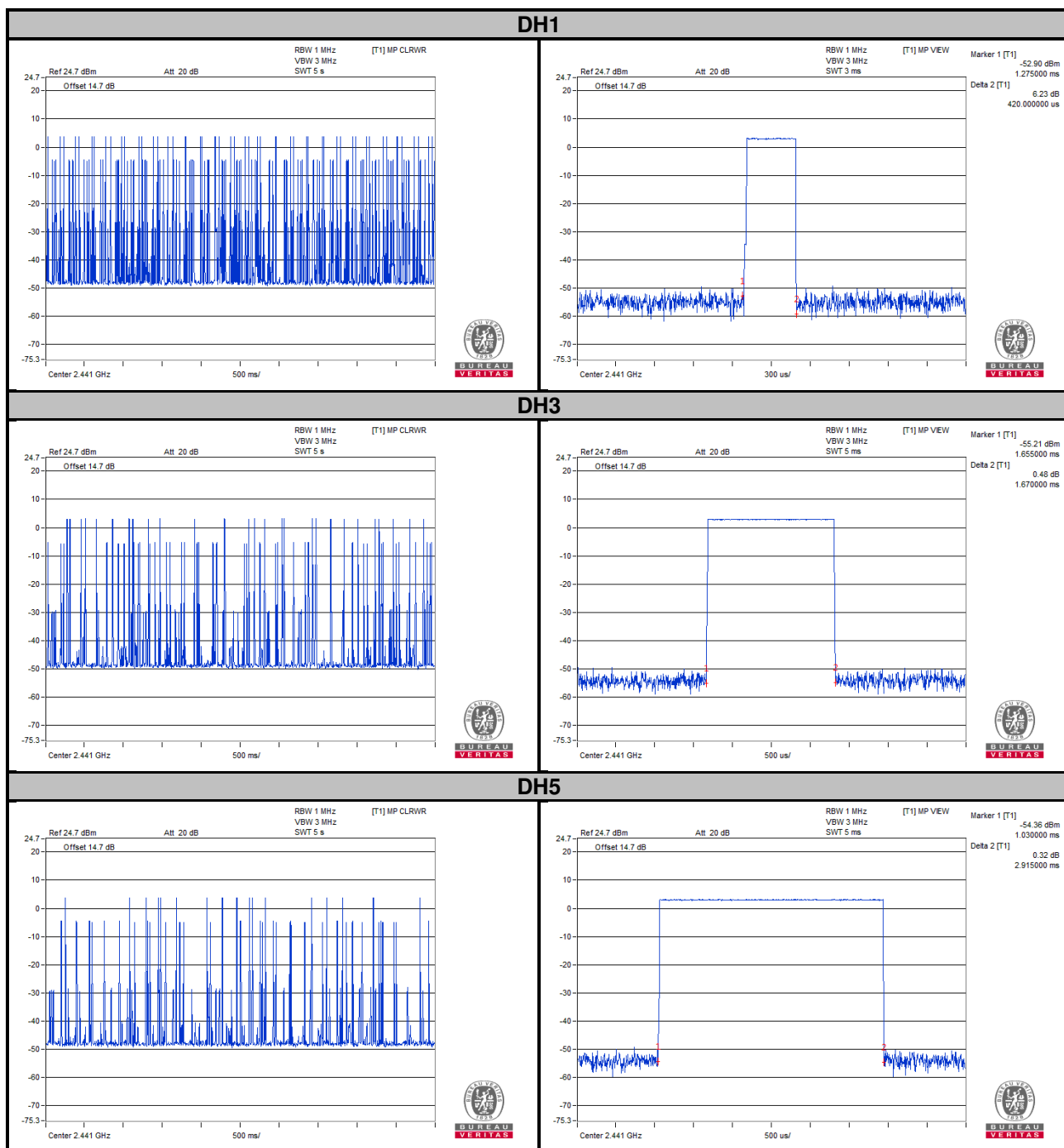

π/4-DQPSK

Mode	Number of transmission in a 31.6 (79 Hopping*0.4)	Length of transmission time (msec)	Result (msec)	Limit (sec)
2DH1	52 (times / 5 sec) * 6.32 = 328.64 times	0.411	135.07	0.4
2DH3	25 (times / 5 sec) * 6.32 = 158 times	1.67	263.86	0.4
2DH5	18 (times / 5 sec) * 6.32 = 113.76 times	2.92	332.18	0.4

Note: Test plots of the transmitting time slot are shown as below.

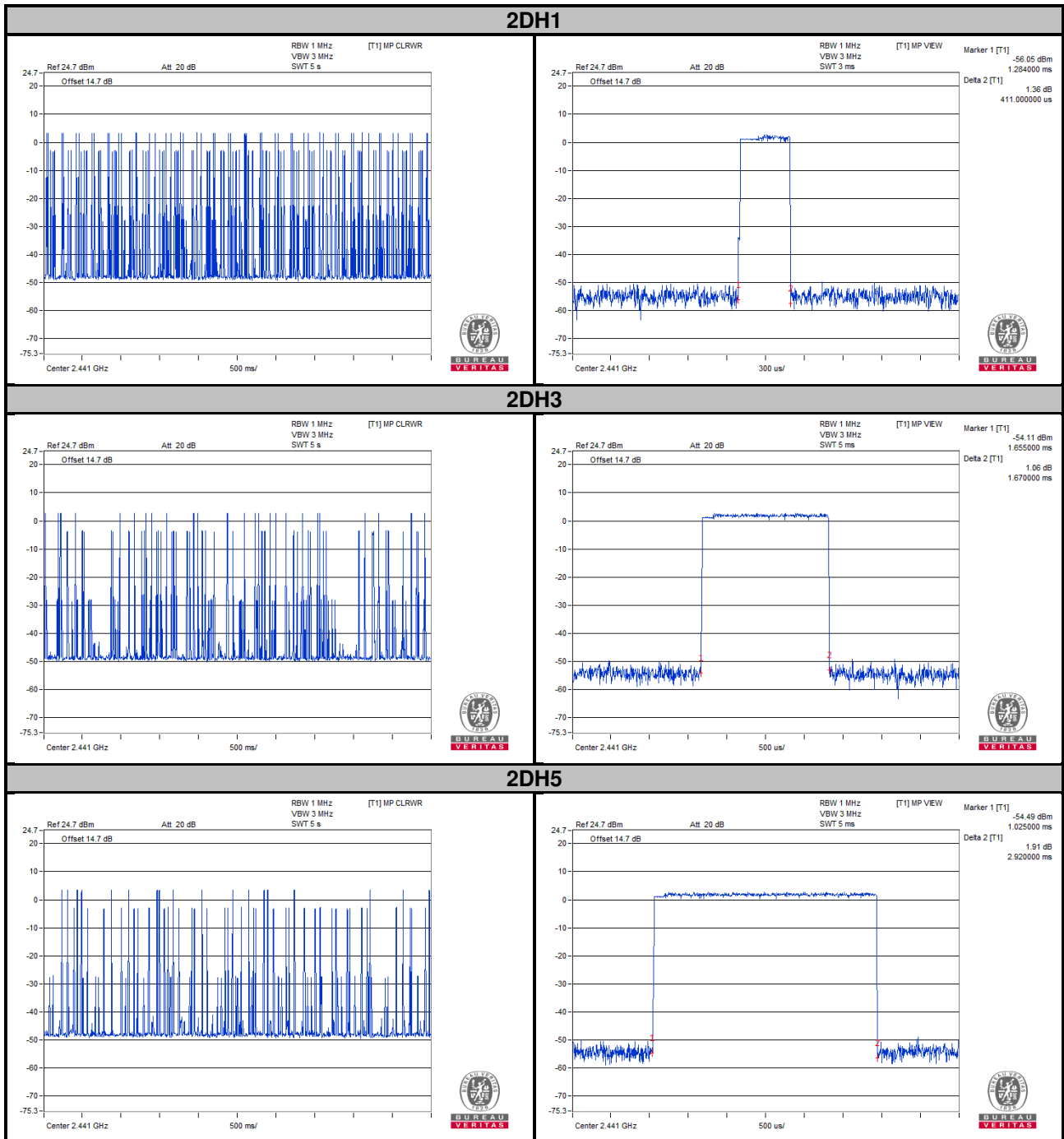

8DPSK

Mode	Number of transmission in a 31.6 (79 Hopping*0.4)	Length of transmission time (msec)	Result (msec)	Limit (sec)
3DH1	50 (times / 5 sec) * 6.32 = 316 times	0.429	135.56	0.4
3DH3	25 (times / 5 sec) * 6.32 = 158 times	1.695	267.81	0.4
3DH5	17 (times / 5 sec) * 6.32 = 107.44 times	2.915	313.19	0.4

Note: Test plots of the transmitting time slot are shown as below.



4.5 Channel Bandwidth

4.5.1 Limits of Channel Bandwidth Measurement

For frequency hopping system operating in the 2400-2483.5 MHz, if the 20 dB bandwidth of hopping channel is greater than 25 kHz, two-thirds 20 dB bandwidth of hopping channel shall be a minimum limit for the hopping channel separation.

4.5.2 Test Setup

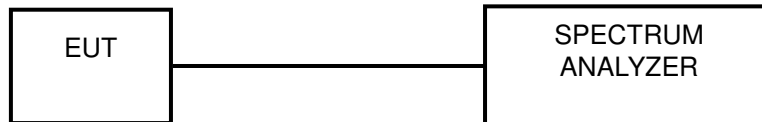

4.5.3 Test Instruments

Refer to section 4.1.2 to get information of above instrument.

4.5.4 Test Procedure

- Check the calibration of the measuring instrument using either an internal calibrator or a known signal from an external generator.
- Turn on the EUT and connect it to measurement instrument. Then set it to any one convenient frequency within its operating range. Set a reference level on the measuring instrument equal to the highest peak value.
- Measure the frequency difference of two frequencies that were attenuated 20 dB from the reference level. Record the frequency difference as the emission bandwidth.
- Repeat above procedures until all frequencies measured were complete.

4.5.5 Deviation from Test Standard

No deviation.

4.5.6 EUT Operating Condition

The software provided by client enabled the EUT to transmit and receive data at lowest, middle and highest channel frequencies individually.

4.5.7 Test Results

Channel	Frequency (MHz)	20 dB Bandwidth (MHz)		
		GFSK	$\pi/4$ -DQPSK	8DPSK
0	2402	0.93	1.29	1.23
39	2441	0.93	1.29	1.23
78	2480	0.93	1.28	1.23

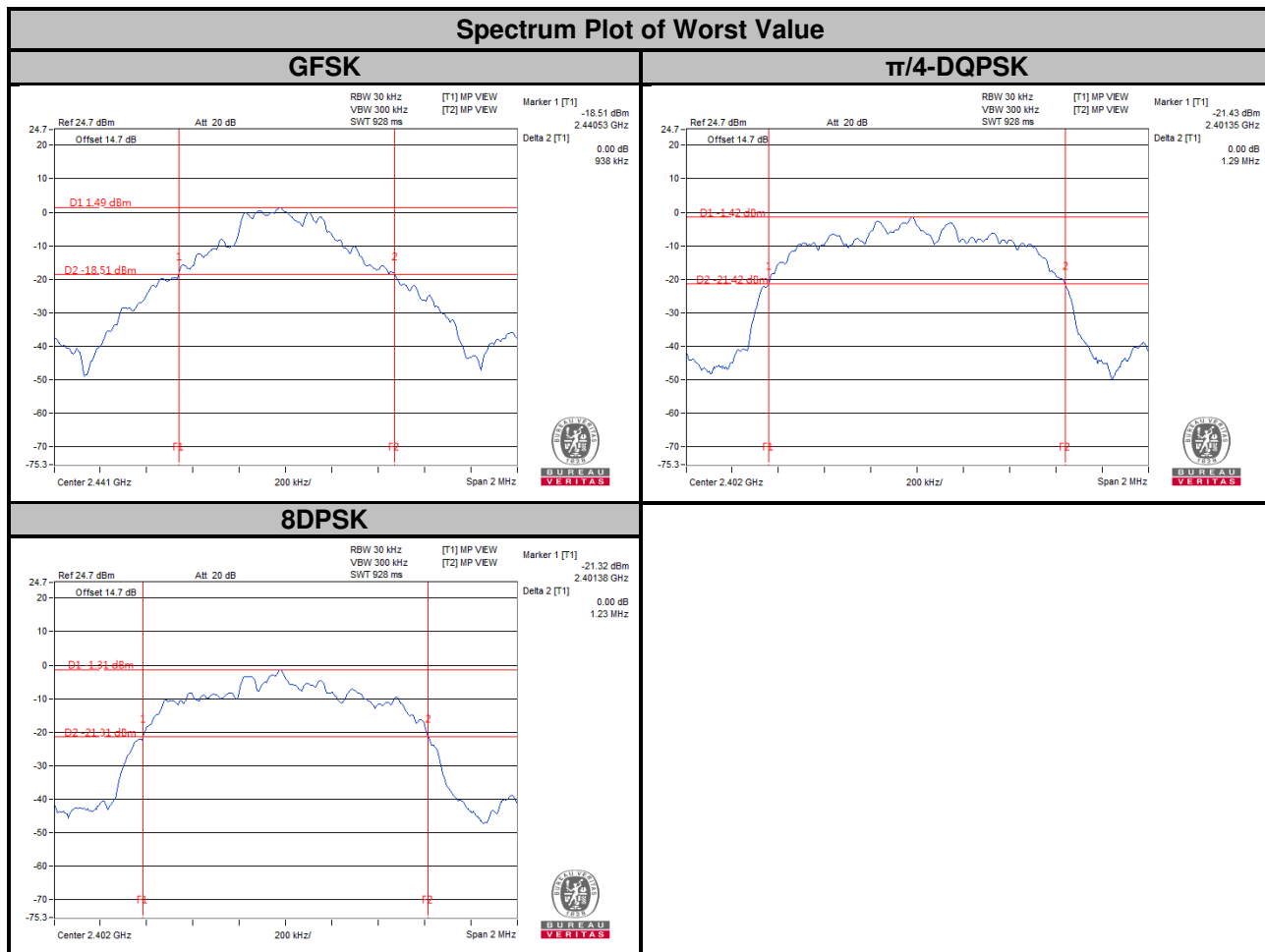

4.6 Hopping Channel Separation

4.6.1 Limits of Hopping Channel Separation Measurement

At least 25 kHz or two-third of 20 dB hopping channel bandwidth (whichever is greater).

4.6.2 Test Setup

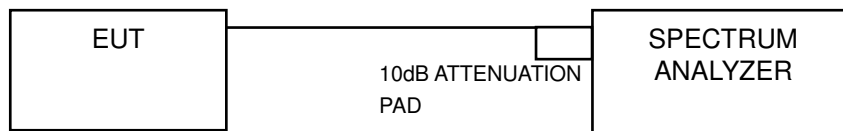

4.6.3 Test Instruments

Refer to section 4.1.2 to get information of above instrument.

4.6.4 Test Procedure

Measurement Procedure REF

- Check the calibration of the measuring instrument using either an internal calibrator or a known signal from an external generator.
- Turn on the EUT and connect it to measurement instrument. Then set it to any one convenient frequency within its operating range.
- By using the MaxHold function record the separation of two adjacent channels.
- Measure the frequency difference of these two adjacent channels by SA MARK function. And then plot the result on SA screen.
- Repeat above procedures until all frequencies measured were complete.

4.6.5 Deviation from Test Standard

No deviation.

4.6.6 Test Results

Channel	Freq. (MHz)	Adjacent Channel Separation (MHz)			20 dB Bandwidth (MHz)			Minimum Limit (MHz)			Pass / Fail
		GFSK	$\pi/4$ -DQPSK	8DPSK	GFSK	$\pi/4$ -DQPSK	8DPSK	GFSK	$\pi/4$ -DQPSK	8DPSK	
0	2402	1.00	1.00	1.00	0.93	1.29	1.23	0.62	0.86	0.82	Pass
39	2441	1.00	1.00	1.00	0.93	1.29	1.23	0.62	0.86	0.82	Pass
78	2480	1.00	1.00	1.00	0.93	1.28	1.23	0.62	0.86	0.82	Pass

Note:

- The minimum limit is two-third 20 dB bandwidth.

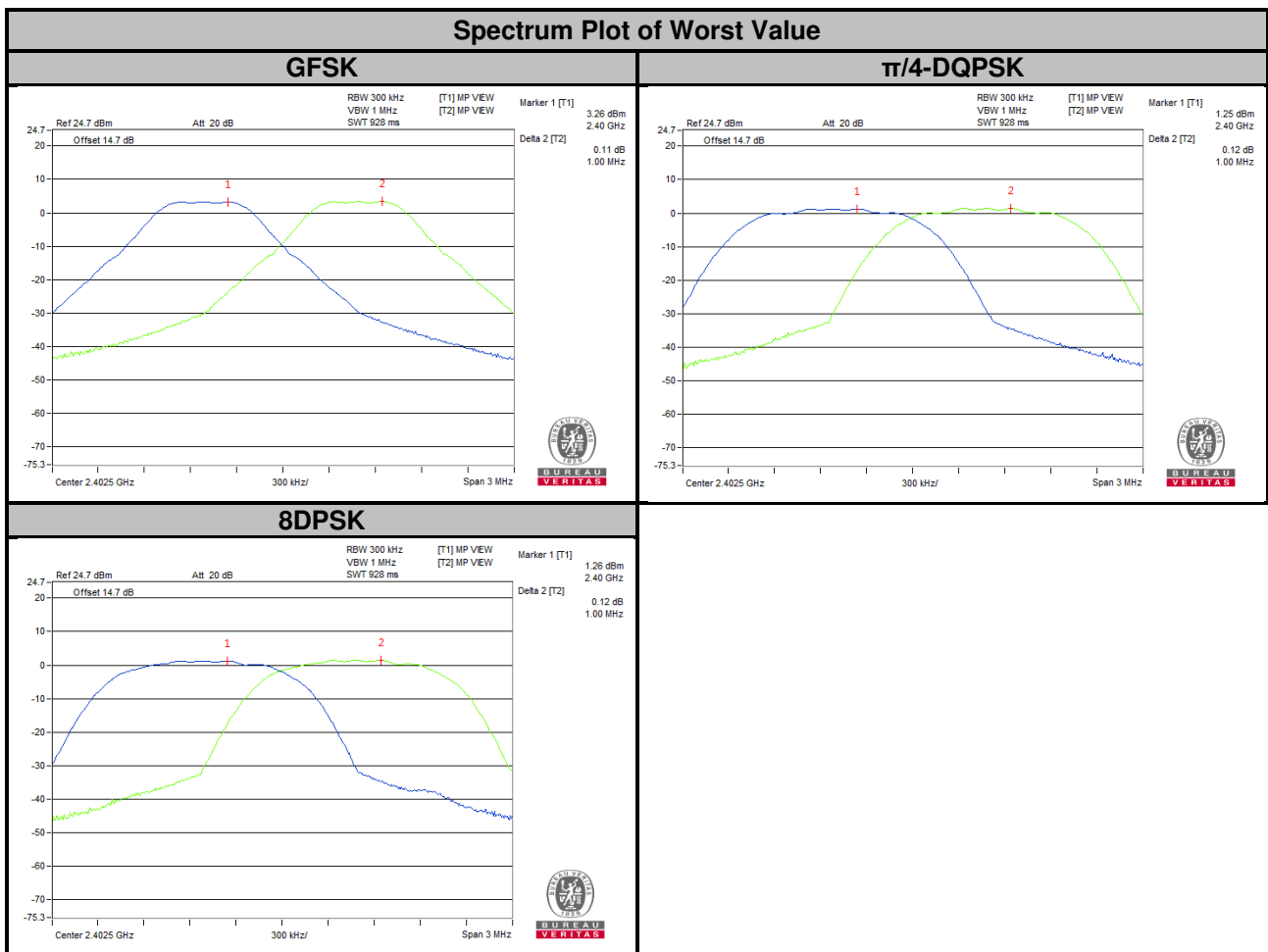

4.7 Maximum Output Power

4.7.1 Limits of Maximum Output Power Measurement

The Maximum Output Power Measurement is 125 mW.

4.7.2 Test Setup

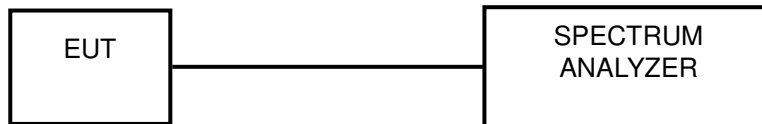

4.7.3 Test Instruments

Refer to section 4.1.2 to get information of above instrument.

4.7.4 Test Procedure

- Check the calibration of the measuring instrument using either an internal calibrator or a known signal from an external generator.
- Turn on the EUT and connect it to measurement instrument. Then set it to any one convenient frequency within its operating range. Set a reference level on the measuring instrument equal to the highest peak value.
- The center frequency of the spectrum analyzer is set to the fundamental frequency and using 3 MHz RBW and 10 MHz VBW.
- Measure the captured power within the band and recording the plot.
- Repeat above procedures until all frequencies required were complete.

4.7.5 Deviation from Test Standard

No deviation.

4.7.6 EUT Operating Condition

The software provided by client enabled the EUT to transmit and receive data at lowest, middle and highest channel frequencies individually.

4.7.7 Test Results

Channel	Freq. (MHz)	Output Power (mW)			Output Power (dBm)			Power Limit (mW)	Pass / Fail
		GFSK	$\pi/4$ -DQPSK	8DPSK	GFSK	$\pi/4$ -DQPSK	8DPSK		
0	2402	2.63	2.523	2.799	4.20	4.02	4.47	125	Pass
39	2441	3.483	3.311	3.69	5.42	5.20	5.67	125	Pass
78	2480	3.027	2.844	3.199	4.81	4.54	5.05	125	Pass

Spectrum Plot of Worst Value

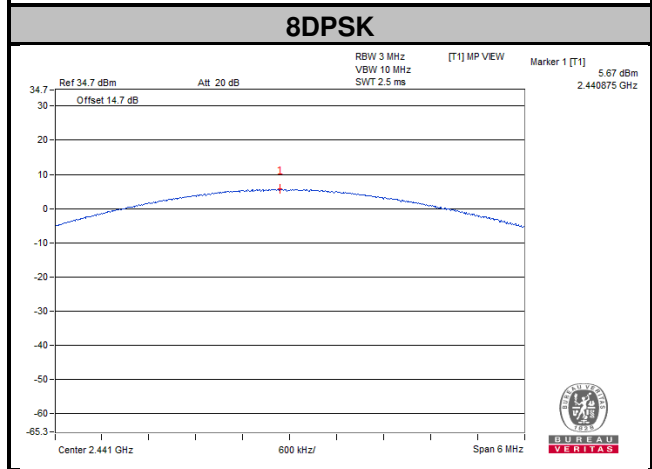
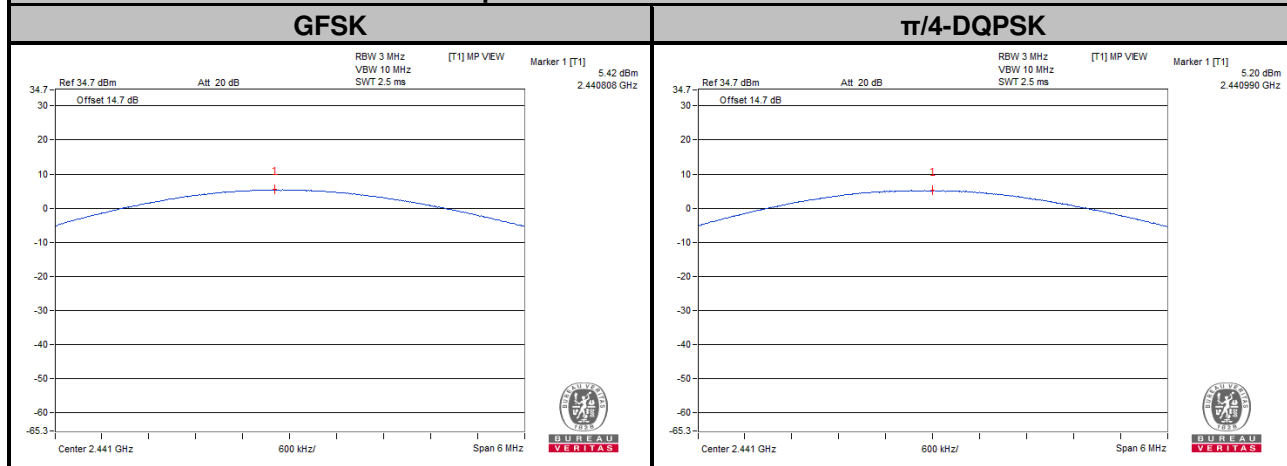

4.8 Conducted Out of Band Emission Measurement

4.8.1 Limits Of Conducted Out Of Band Emission Measurement

Below -20 dB of the highest emission level of operating band (in 100 kHz RBW).

4.8.2 Test Instruments

Refer to section 4.1.2 to get information of above instrument.

4.8.3 Test Procedure

The transmitter output was connected to the spectrum analyzer via a low lose cable. Set both RBW and VBW of spectrum analyzer to 100 kHz and 300 kHz with suitable frequency span including 100 MHz bandwidth from band edge. The band edges was measured and recorded.

4.8.4 Deviation from Test Standard

No deviation.

4.8.5 EUT Operating Condition

The software provided by client enabled the EUT to transmit and receive data at lowest, middle and highest channel frequencies individually.

4.8.6 Test Results

The spectrum plots are attached on the following images. D1 line indicates the highest level, D2 line indicates the 20 dB offset below D1. It shows compliance with the requirement.

GFSK

Hopping Disabled_Low Channel

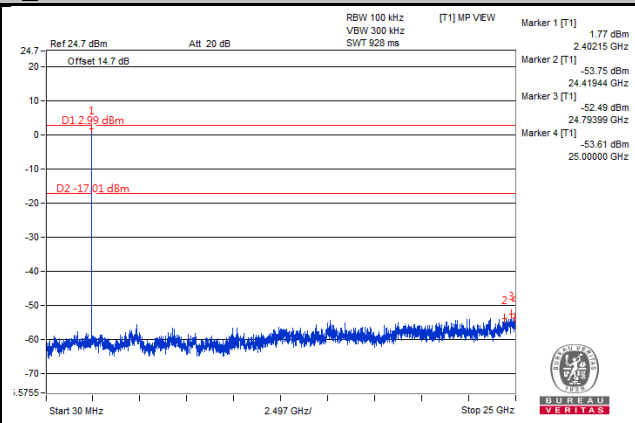
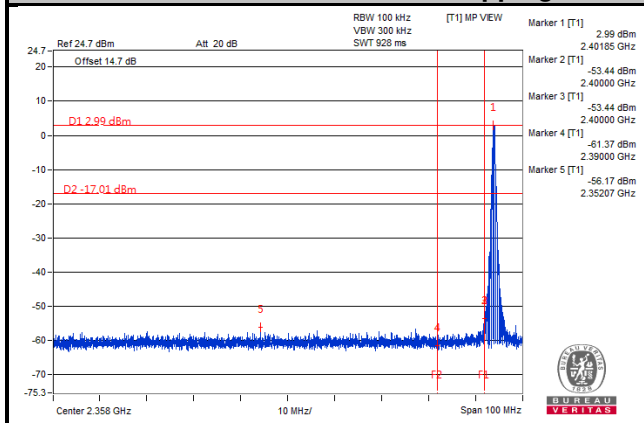

Hopping Disabled_High Channel

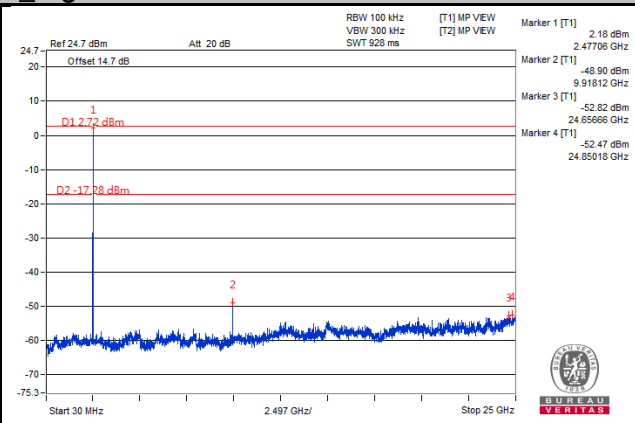
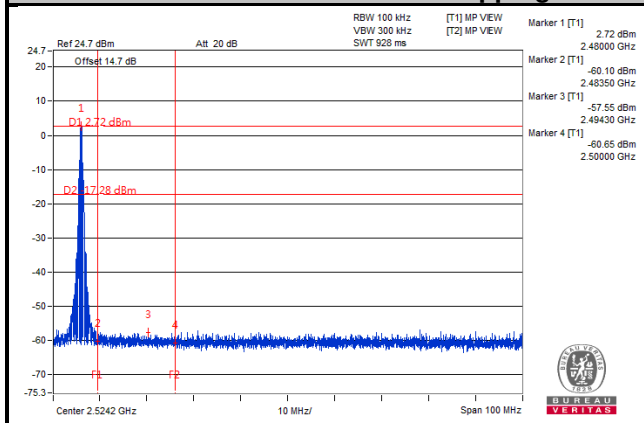

Hopping Enabled_Low Channel

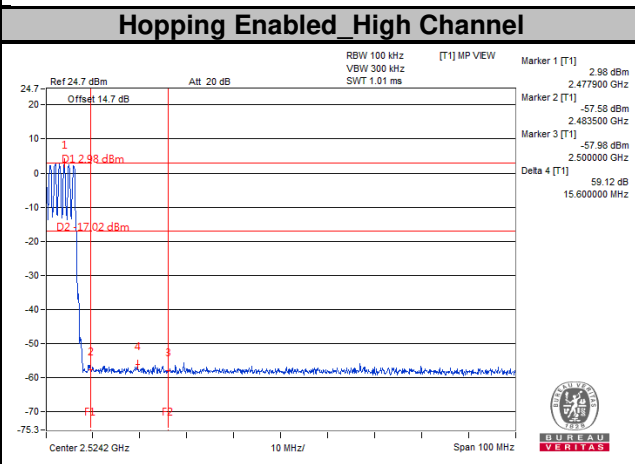
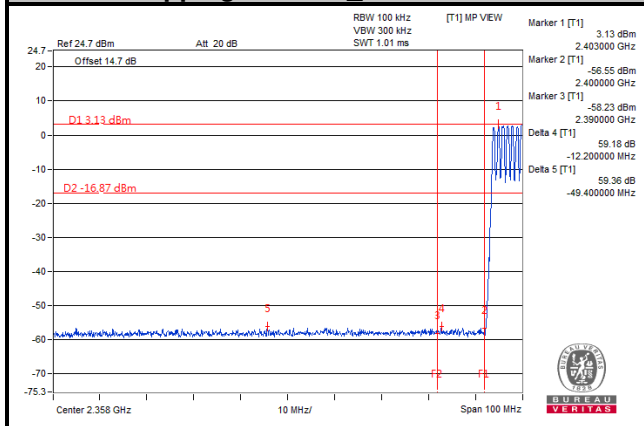

$\pi/4$ -DQPSK

Hopping Disabled_Low Channel

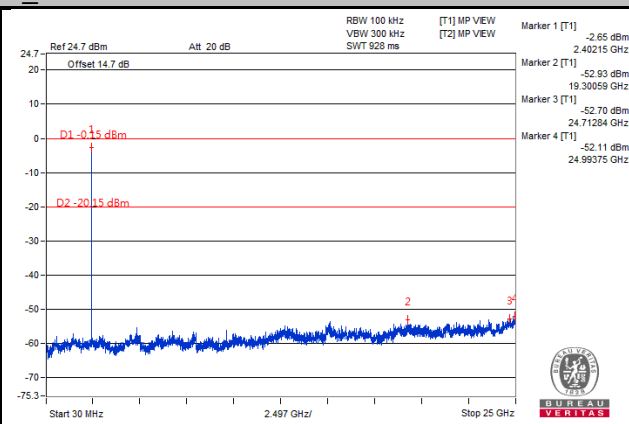
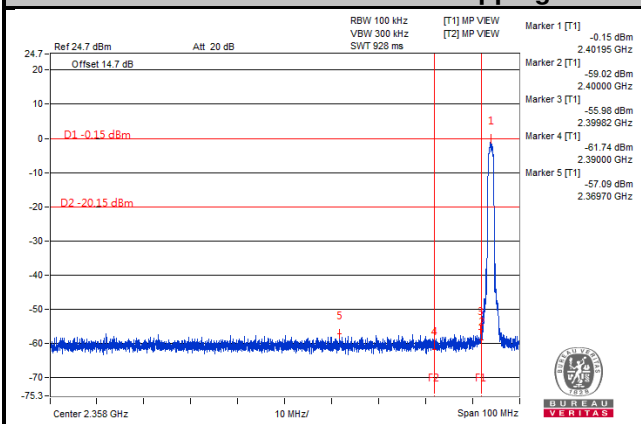

Hopping Disabled_High Channel

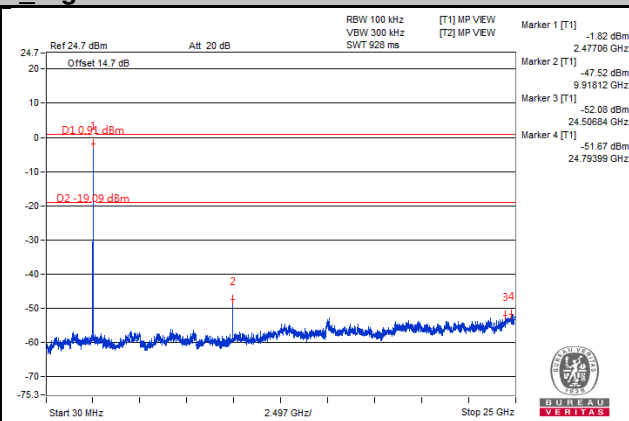
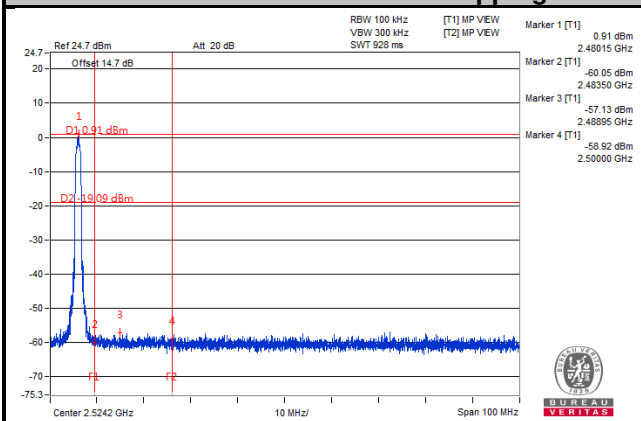

Hopping Enabled_Low Channel

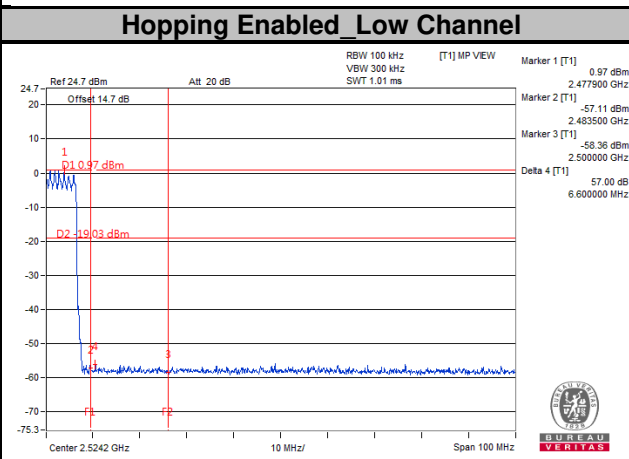
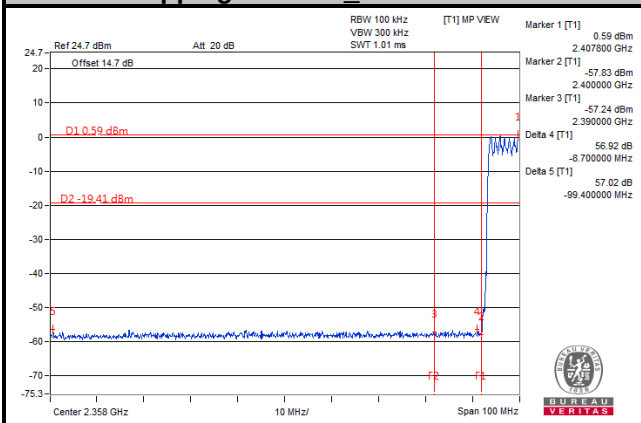

8DPSK

Hopping Disabled_Low Channel

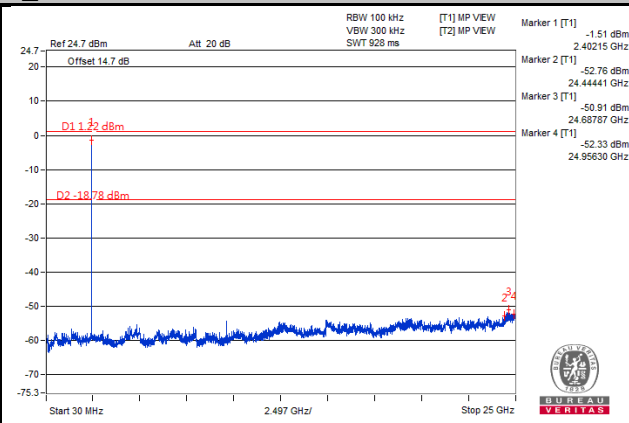
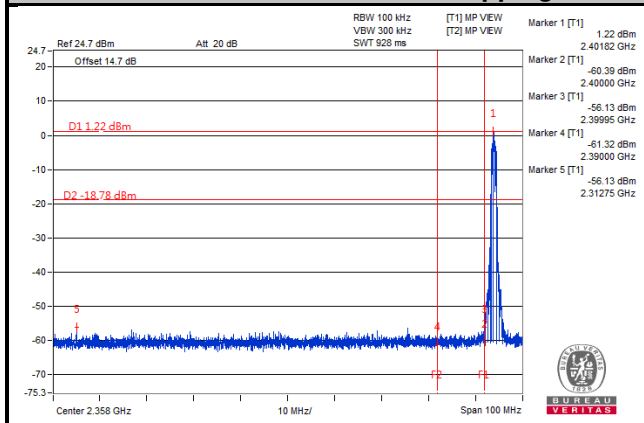

Hopping Disabled_High Channel

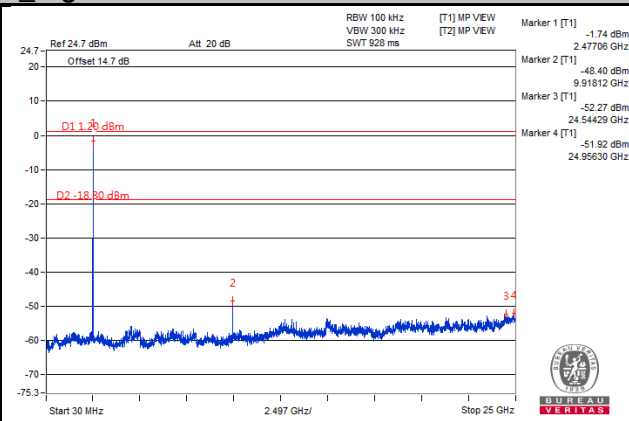
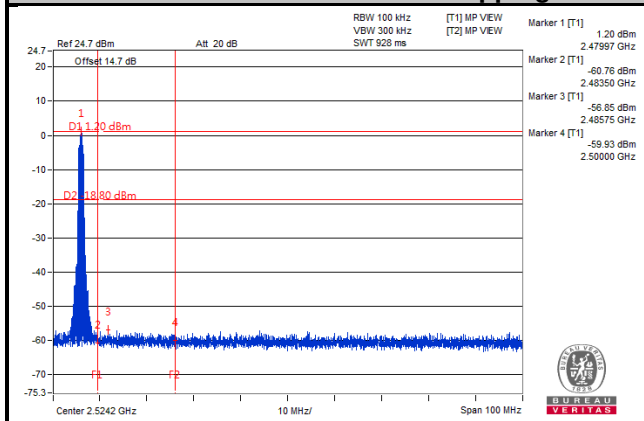

Hopping Enabled_Low Channel

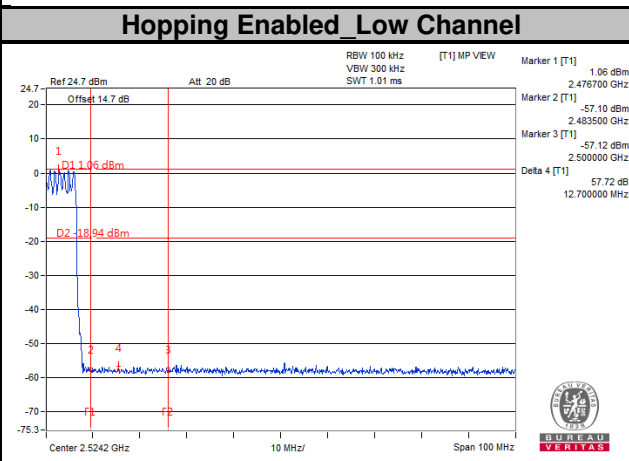
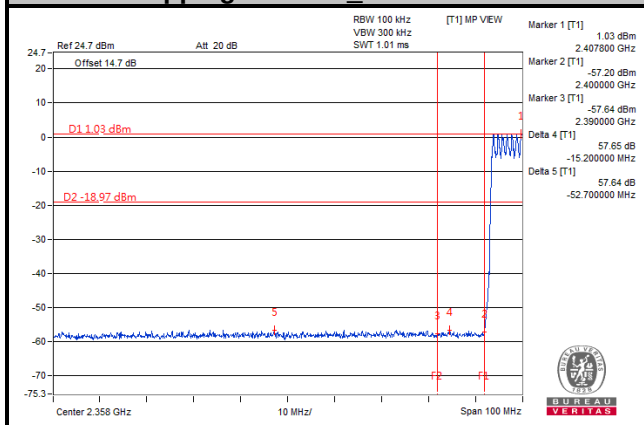

5 Pictures of Test Arrangements

Please refer to the attached file (Test Setup Photo).

Appendix – Information on the Testing Laboratories

We, Bureau Veritas Consumer Products Services (H.K.) Ltd., Taoyuan Branch, were founded in 1988 to provide our best service in EMC, Radio, Telecom and Safety consultation. Our laboratories are FCC recognized accredited test firms and accredited and approved according to ISO/IEC 17025.

If you have any comments, please feel free to contact us at the following:

Linko EMC/RF Lab

Tel: 886-2-26052180

Fax: 886-2-26051924

Hsin Chu EMC/RF/Telecom Lab

Tel: 886-3-6668565

Fax: 886-3-6668323

Hwa Ya EMC/RF/Safety

Tel: 886-3-3183232

Fax: 886-3-3270892

Email: service.adt@tw.bureauveritas.com

Web Site: www.bureauveritas-adt.com

The address and road map of all our labs can be found in our web site also.

--- END ---