

Variant FCC Test Report

Report No.: RF160720C23-1

FCC ID: UK7-DW2

Test Model: DW2e

Received Date: Jul. 20, 2016

Test Date: Aug. 10, 2016

Issued Date: Aug. 19, 2016

Applicant: Fossil Group, Inc.

Address: 901 S. Central Expwy., Richardson, TX 75080 USA

Issued By: Bureau Veritas Consumer Products Services (H.K.) Ltd., Taoyuan Branch

Lab Address: No. 47-2, 14th Ling, Chia Pau Vil., Lin Kou Dist., New Taipei City, Taiwan
(R.O.C)

Test Location: No. 19, Hwa Ya 2nd Rd, Wen Hwa Tsuen, Kwei Shan Hsiang, Taoyuan
Hsien 333, Taiwan, R.O.C.



This report is for your exclusive use. Any copying or replication of this report to or for any other person or entity, or use of our name or trademark, is permitted only with our prior written permission. This report sets forth our findings solely with respect to the test samples identified herein. The results set forth in this report are not indicative or representative of the quality or characteristics of the lot from which a test sample was taken or any similar or identical product unless specifically and expressly noted. Our report includes all of the tests requested by you and the results thereof based upon the information that you provided to us. You have 60 days from date of issuance of this report to notify us of any material error or omission caused by our negligence, provided, however, that such notice shall be in writing and shall specifically address the issue you wish to raise. A failure to raise such issue within the prescribed time shall constitute your unqualified acceptance of the completeness of this report, the tests conducted and the correctness of the report contents. Unless specifically mentioned, the uncertainty of measurement has been explicitly taken into account to declare the compliance or non-compliance to the specification.

Table of Contents

Release Control Record	3
1 Certificate of Conformity	4
2 Summary of Test Results.....	5
2.1 Measurement Uncertainty.....	5
2.2 Modification Record	5
3 General Information	6
3.1 General Description of EUT	6
3.2 Description of Test Modes.....	7
3.2.1 Test Mode Applicability and Tested Channel Detail.....	8
3.3 Description of Support Units	9
3.3.1 Configuration of System under Test	9
3.4 General Description of Applied Standards.....	9
4 Test Types and Results	10
4.1 Radiated Emission and Bandedge Measurement	10
4.1.1 Limits of Radiated Emission and Bandedge Measurement	10
4.1.2 Test Instruments	11
4.1.3 Test Procedures.....	12
4.1.4 Deviation from Test Standard	12
4.1.5 Test Set Up	13
4.1.6 EUT Operating Conditions.....	13
4.1.7 Test Results	14
5 Pictures of Test Arrangements.....	19
Appendix – Information on the Testing Laboratories	20

Release Control Record

Issue No.	Description	Date Issued
RF160720C23-1	Original Release	Aug. 19, 2016

1 Certificate of Conformity

Product: Smart Watch

Brand: FOSSIL

Test Model: DW2e

Sample Status: Identical Prototype

Applicant: Fossil Group, Inc.

Test Date: Aug. 10, 2016

Standards: 47 CFR FCC Part 15, Subpart C (Section 15.247)
ANSI C63.10:2013

This report is issued as a supplementary report to BV CPS report no.: RF160517C19-1. This report shall be used by combining with its original report.

Prepared by : Evonne Liu , **Date:** Aug. 19, 2016
Evonne Liu / Specialist

Approved by : Stanley Wu , **Date:** Aug. 19, 2016
Stanley Wu / Assistant Manager

2 Summary of Test Results

47 CFR FCC Part 15, Subpart C (Section 15.247)			
FCC Clause	Test Item	Result	Remarks
15.207	AC Power Conducted Emission	N/A	Refer to Note
15.247(a)(1)(iii)	Number of Hopping Frequency Used	N/A	Refer to Note
15.247(a)(1)(iii)	Dwell Time on Each Channel	N/A	Refer to Note
15.247(a)(1)	1. Hopping Channel Separation 2. Spectrum Bandwidth of a Frequency Hopping Sequence Spread Spectrum System	N/A	Refer to Note
15.247(b)	Maximum Peak Output Power	N/A	Refer to Note
15.205 & 209	Radiated Emissions	Pass	Meet the requirement of limit. Minimum passing margin is -15.87 dB at 2488.68 MHz.
15.247(d)	Band Edge Measurement	N/A	Refer to Note
15.247(d)	Antenna Port Emission	N/A	Refer to Note
15.203	Antenna Requirement	Pass	No antenna connector is used.

Note: Only radiated emission test were performed for this addendum. Refer to original report for other test data.

2.1 Measurement Uncertainty

Where relevant, the following measurement uncertainty levels have been estimated for tests performed on the EUT:

The listed uncertainties are the worst case uncertainty for the entire range of measurement. Please note that the uncertainty values are provided for informational purposes only and are not used in determining the PASS/FAIL results.

Measurement	Frequency	Expanded Uncertainty (k=2) (±)
Radiated Emissions up to 1 GHz	30 MHz ~ 200 MHz	2.93 dB
	200 MHz ~1000 MHz	2.95 dB
Radiated Emissions above 1 GHz	1 GHz ~ 18 GHz	2.26 dB
	18 GHz ~ 40 GHz	1.94 dB

2.2 Modification Record

There were no modifications required for compliance.

3 General Information

3.1 General Description of EUT

Product	Smart Watch
Brand	FOSSIL
Test Model	DW2e
Status of EUT	Identical Prototype
Power Supply Rating	3.8 Vdc (from battery) 5 Vdc (from wireless charger)
Modulation Type	GFSK, $\pi/4$ -DQPSK, 8DPSK
Transfer Rate	1/2/3 Mbps
Operating Frequency	2402 ~ 2480 MHz
Number of Channel	79
Antenna Type	Loop antenna with -6.05 dBi gain
Antenna Connector	N/A
Accessory Device	N/A
Data Cable Supplied	N/A

Note:

1. This report is issued as a supplementary report to BV CPS report no.: RF160517C19-1. The difference compared with original report is changing the model, material of EUT, and antenna gain. Therefore, only radiated emission test were performed and presented in this report.
2. The WLAN/BT Module (Brand: FOSSIL, Model: DW2) was installed in the EUT.
3. The EUT contains following accessory devices.

Product	Brand	Model	Description
Battery	FOSSIL	APP00169	3.8 Vdc, 400 mAh
Wireless Charger	FOSSIL	FW1D25S2-00	O/P: 5 Vdc, 0.25 A I/P: 5 Vdc (from USB port)
LCD Panel	AUO	H140QVN01.1	1.4 inch

4. The above EUT information is declared by manufacturer and for more detailed features description, please refer to the manufacturer's specifications or User's Manual.

3.2 Description of Test Modes

79 channels are provided to this EUT:

Channel	Freq. (MHz)	Channel	Freq. (MHz)	Channel	Freq. (MHz)	Channel	Freq. (MHz)
0	2402	20	2422	40	2442	60	2462
1	2403	21	2423	41	2443	61	2463
2	2404	22	2424	42	2444	62	2464
3	2405	23	2425	43	2445	63	2465
4	2406	24	2426	44	2446	64	2466
5	2407	25	2427	45	2447	65	2467
6	2408	26	2428	46	2448	66	2468
7	2409	27	2429	47	2449	67	2469
8	2410	28	2430	48	2450	68	2470
9	2411	29	2431	49	2451	69	2471
10	2412	30	2432	50	2452	70	2472
11	2413	31	2433	51	2453	71	2473
12	2414	32	2434	52	2454	72	2474
13	2415	33	2435	53	2455	73	2475
14	2416	34	2436	54	2456	74	2476
15	2417	35	2437	55	2457	75	2477
16	2418	36	2438	56	2458	76	2478
17	2419	37	2439	57	2459	77	2479
18	2420	38	2440	58	2460	78	2480
19	2421	39	2441	59	2461		

3.2.1 Test Mode Applicability and Tested Channel Detail

EUT Configure Mode	Applicable To		Description
	RE \geq 1G	RE $<$ 1G	
-	√	√	Standalone

Where **RE \geq 1G**: Radiated Emission above 1 GHz **RE $<$ 1G**: Radiated Emission below 1 GHz

NOTE:

1. For Radiated emission test, pre-tested GFSK, $\pi/4$ -DQPSK, 8DPSK modulation type and found 8DPSK was the worse, therefore chosen for the final test and presented in the test report.
2. The EUT had been pre-tested on the positioned of each 3 axis. The worst case was found when positioned on **Y-plane**.

Radiated Emission Test (Above 1 GHz):

- Pre-Scan has been conducted to determine the worst-case mode from all possible combinations between available modulations, data rates and antenna ports (if EUT with antenna diversity architecture).
- Following channel(s) was (were) selected for the final test as listed below.

EUT Configure Mode	Available Channel	Tested Channel	Modulation Technology	Modulation Type	Packet Type
-	0 to 78	78	FHSS	8DPSK	DH5

Radiated Emission Test (Below 1 GHz):

- Pre-Scan has been conducted to determine the worst-case mode from all possible combinations between available modulations, data rates and antenna ports (if EUT with antenna diversity architecture).
- Following channel(s) was (were) selected for the final test as listed below.

EUT Configure Mode	Available Channel	Tested Channel	Modulation Technology	Modulation Type	Packet Type
-	0 to 78	78	FHSS	8DPSK	DH5

Test Condition:

Applicable To	Environmental Conditions	Input Power	Tested by
RE \geq 1G	25 deg. C, 65 % RH	3.8 Vdc / 5 Vdc	Getaz Yang
RE $<$ 1G	25 deg. C, 65 % RH	3.8 Vdc / 5 Vdc	Getaz Yang

3.3 Description of Support Units

The EUT has been tested as an independent unit together with other necessary accessories or support units.

3.3.1 Configuration of System under Test

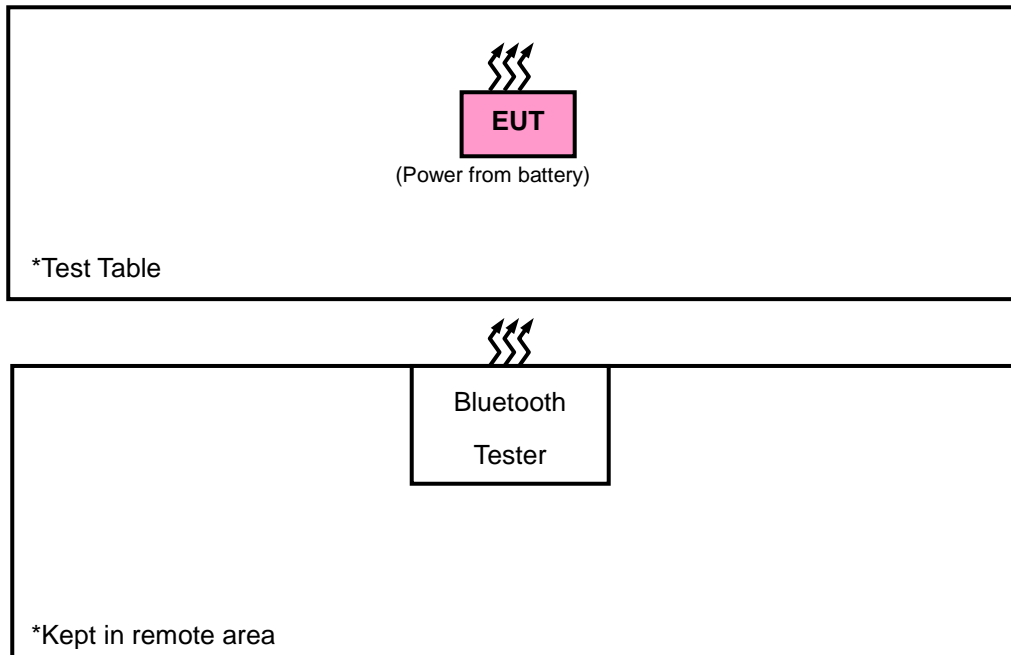

3.4 General Description of Applied Standards

The EUT is a RF Product. According to the specifications of the manufacturer, it must comply with the requirements of the following standards:

FCC Part 15, Subpart C (15.247)

FCC Public Notice DA 00-705

ANSI C63.10-2013

All test items have been performed and recorded as per the above standards.

NOTE: The EUT has been verified to comply with the requirements of FCC Part 15, Subpart B, Class B (DoC). The test report has been issued separately.

4 Test Types and Results

4.1 Radiated Emission and Bandedge Measurement

4.1.1 Limits of Radiated Emission and Bandedge Measurement

Radiated emissions which fall in the restricted bands must comply with the radiated emission limits specified as below table. Other emissions shall be at least 20 dB below the highest level of the desired power:

Frequencies (MHz)	Field Strength (microvolts/meter)	Measurement Distance (meters)
0.009 ~ 0.490	2400/F (kHz)	300
0.490 ~ 1.705	24000/F (kHz)	30
1.705 ~ 30.0	30	30
30 ~ 88	100	3
88 ~ 216	150	3
216 ~ 960	200	3
Above 960	500	3

NOTE:

1. The lower limit shall apply at the transition frequencies.
2. Emission level (dBuV/m) = 20 log Emission level (uV/m).
3. For frequencies above 1000 MHz, the field strength limits are based on average detector, however, the peak field strength of any emission shall not exceed the maximum permitted average limits, specified above by more than 20 dB under any condition of modulation.

4.1.2 Test Instruments

Description & Manufacturer	Model No.	Serial No.	Date of Calibration	Due Date of Calibration
Test Receiver Agilent	N9038A	MY51210203	Jan. 21, 2016	Jan. 20, 2017
Spectrum Analyzer Agilent	N9010A	MY52220314	Sep. 03, 2015	Sep. 02, 2016
Spectrum Analyzer ROHDE & SCHWARZ	F5U43	101261	Dec. 17, 2015	Dec. 16, 2016
BILOG Antenna SCHWARZBECK	VULB9168	9168-472	Jan. 07, 2016	Jan. 06, 2017
HORN Antenna SCHWARZBECK	BBHA 9120 D	9120D-969	Jan. 04, 2016	Jan. 03, 2017
HORN Antenna SCHWARZBECK	BBHA 9170	9170-480	Jan. 08, 2016	Jan. 07, 2017
Loop Antenna	LPA600	270	Aug. 20, 2015	Aug. 19, 2017
Bluetooth Tester	CBT	100980	Apr. 27, 2015	Apr. 26, 2017
Agilent Communications Tester-Wireless	8960 Series 10	MY53201073	Jul. 03, 2015	Jul. 02, 2017
Preamplifier EMCI	EMC 012645	980115	Dec. 21, 2015	Dec. 20, 2016
Preamplifier EMCI	EMC 184045	980116	Dec. 21, 2015	Dec. 20, 2016
Preamplifier EMCI	EMC 330H	980112	Dec. 28, 2015	Dec. 27, 2016
Power Meter Anritsu	ML2495A	1232002	Sep. 21, 2015	Sep. 20, 2016
Power Sensor Anritsu	MA2411B	1207325	Sep. 21, 2015	Sep. 20, 2016
RF signal cable HUBER+SUHNNER	SUCOFLEX 104	309219/4 2950114	Oct. 12, 2015	Oct. 11, 2016
RF signal cable HUBER+SUHNNER	SUCOFLEX 104	250130/4	Oct. 12, 2015	Oct. 11, 2016
RF Coaxial Cable Worken	8D-FB	Cable-Ch10-01	Oct. 12, 2015	Oct. 11, 2016
Software BV ADT	E3 6.120103	NA	NA	NA
Antenna Tower MF	MFA-440H	NA	NA	NA
Turn Table MF	MFT-201SS	NA	NA	NA
Antenna Tower & Turn Table Controller MF	MF-7802	NA	NA	NA

- Note: 1. The calibration interval of the above test instruments is 12 months and the calibrations are traceable to NML/ROC and NIST/USA.
2. The test was performed in HwaYa Chamber 10.
3. The horn antenna and preamplifier (model: EMC 184045) are used only for the measurement of emission frequency above 1 GHz if tested.
4. The FCC Site Registration No. is 690701.
5. The IC Site Registration No. is IC7450F-10.

4.1.3 Test Procedures

- a. The EUT was placed on the top of a rotating table 0.8 meters (for below 1 GHz) / 1.5 meters (for above 1 GHz) above the ground at 3 meter chamber room for test. The table was rotated 360 degrees to determine the position of the highest radiation.
- b. The EUT was set 3 meters away from the interference-receiving antenna, which was mounted on the top of a variable-height antenna tower.
- c. The height of antenna is varied from one meter to four meters above the ground to determine the maximum value of the field strength. Both horizontal and vertical polarizations of the antenna are set to make the measurement.
- d. For each suspected emission, the EUT was arranged to its worst case and then the antenna was tuned to heights from 1 meter to 4 meters and the rotatable table was turned from 0 degrees to 360 degrees to find the maximum reading.
- e. The test-receiver system was set to quasi-peak detect function and specified bandwidth with maximum hold mode when the test frequency is below 1 GHz.
- f. The test-receiver system was set to peak and average detected function and specified bandwidth with maximum hold mode when the test frequency is above 1 GHz. If the peak reading value also meets average limit, measurement with the average detector is unnecessary.

Note:

1. The resolution bandwidth and video bandwidth of test receiver/spectrum analyzer is 120 kHz for Quasi-peak detection (QP) at frequency below 1 GHz.
2. The resolution bandwidth of test receiver/spectrum analyzer is 1 MHz and the video bandwidth is 3 MHz for Peak detection (PK) at frequency above 1 GHz.
3. The resolution bandwidth of test receiver/spectrum analyzer is 1 MHz and the video bandwidth is 3 MHz for RMS Average (Duty cycle < 98 %) for Average detection (AV) at frequency above 1 GHz, then the measurement results was added to a correction factor ($10 \log(1/\text{duty cycle})$).
4. The resolution bandwidth of test receiver/spectrum analyzer is 1 MHz and the video bandwidth is 10 Hz (Duty cycle \geq 98 %) for Average detection (AV) at frequency above 1 GHz.
5. All modes of operation were investigated and the worst-case emissions are reported.

4.1.4 Deviation from Test Standard

No deviation.

4.1.5 Test Set Up

<Frequency Range below 1 GHz>

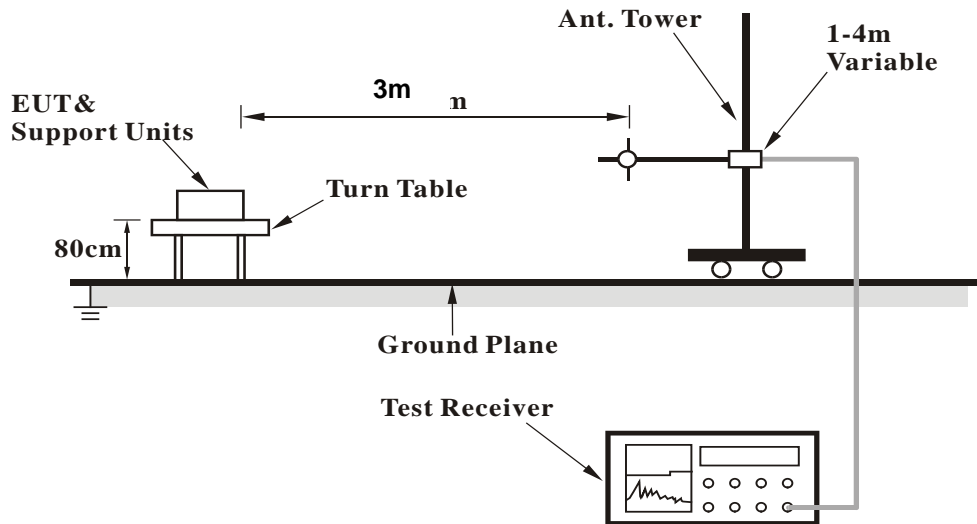

<Frequency Range above 1 GHz>

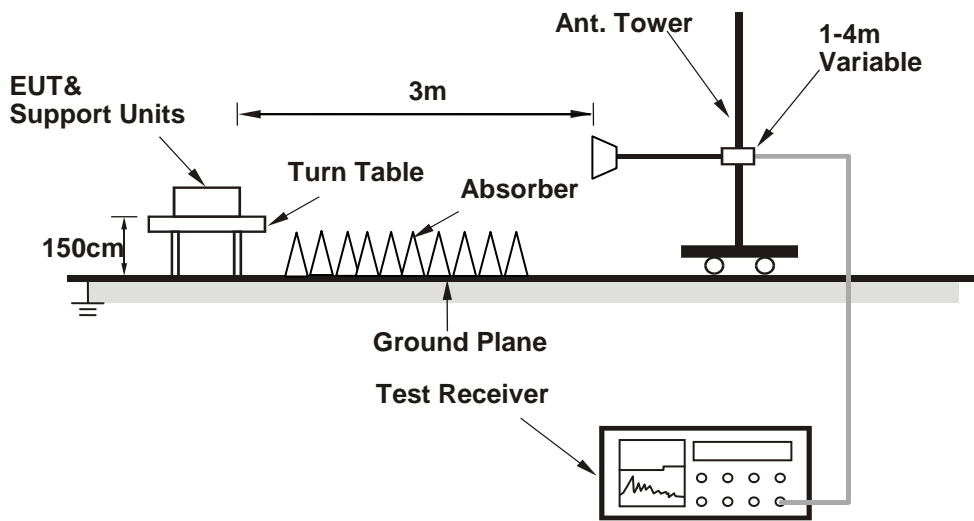

For the actual test configuration, please refer to the attached file (Test Setup Photo).

4.1.6 EUT Operating Conditions

Set the EUT under transmission condition continuously at specific channel frequency.

4.1.7 Test Results

ABOVE 1 GHz DATA :

8DPSK

EUT Test Condition		Measurement Detail	
Channel	Channel 78	Frequency Range	1 GHz ~ 25 GHz
Input Power	120 Vac, 60 Hz	Detector Function	Peak (PK) Average (AV)
Environmental Conditions	25 deg. C, 65 % RH	Tested By	Getaz Yang

Horizontal

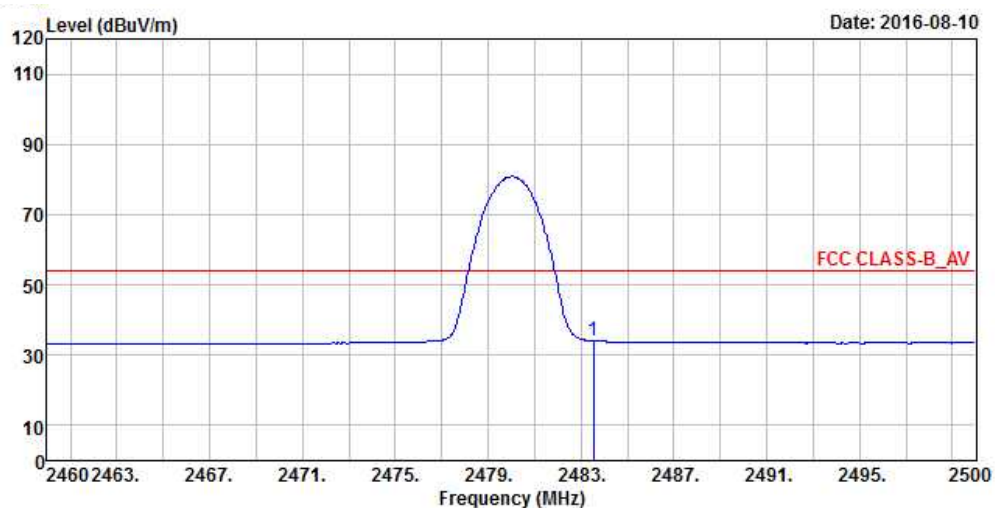
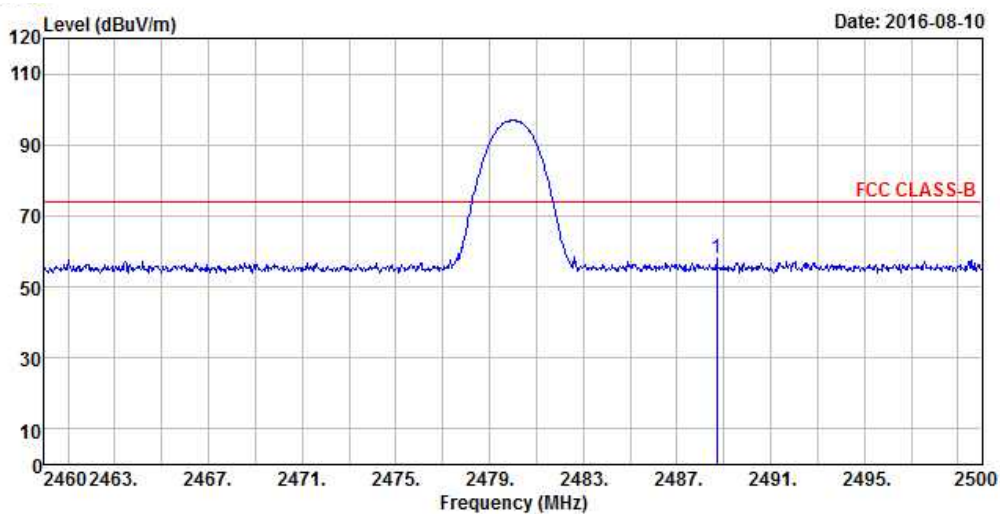

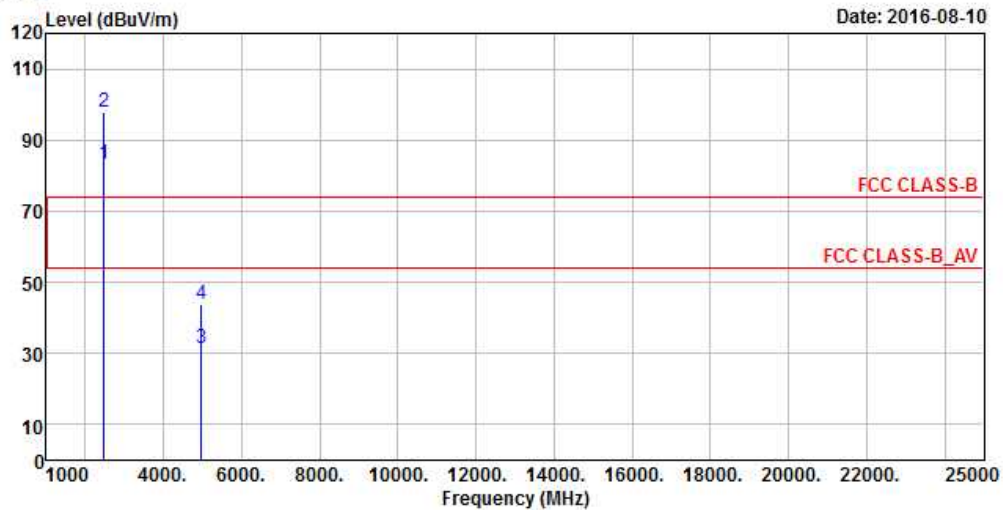

Vertical

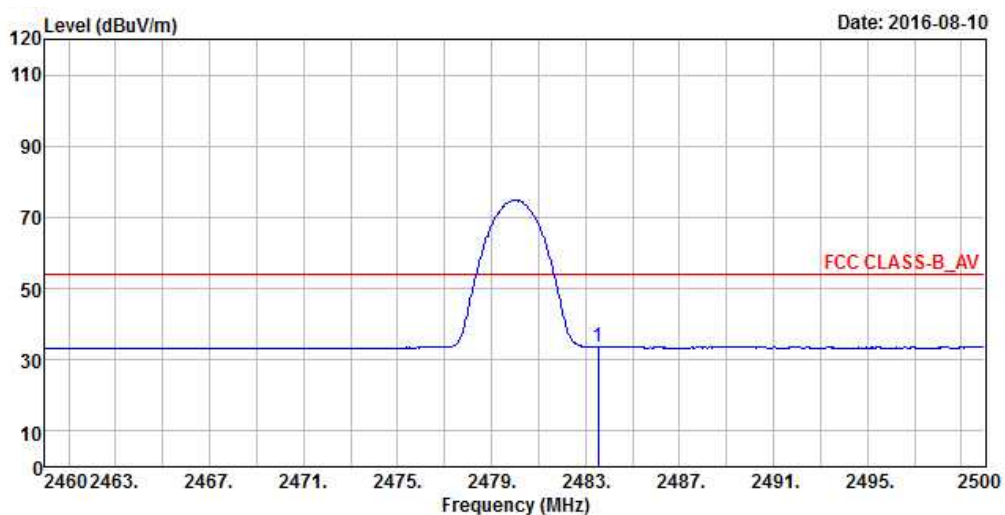
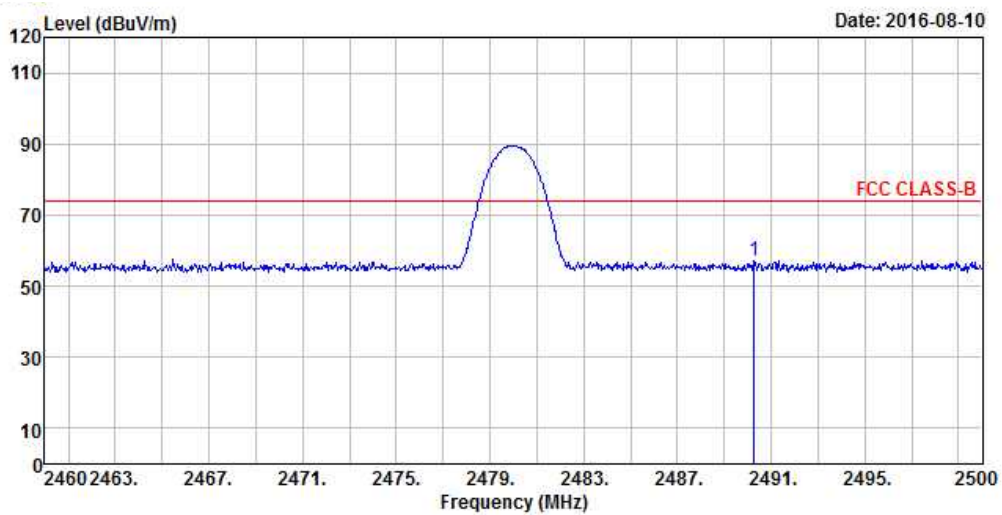

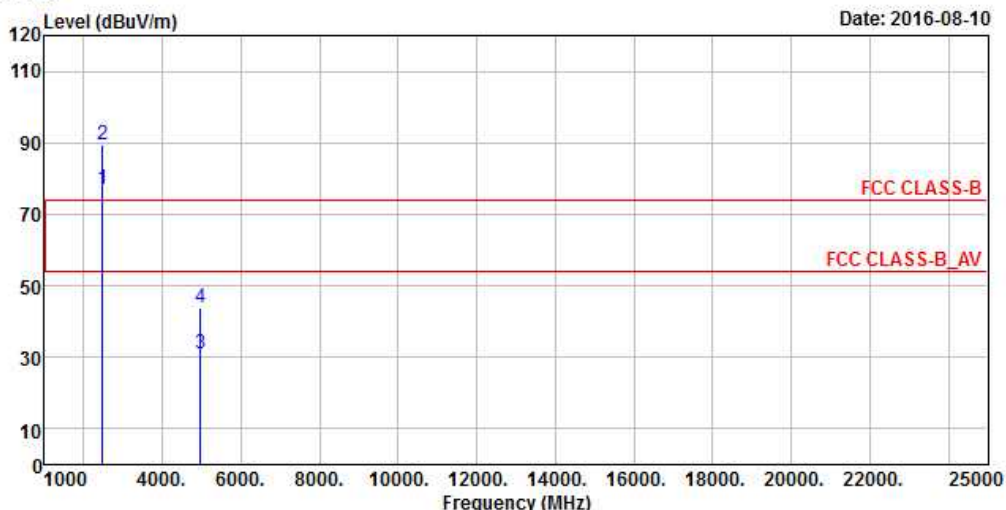

Antenna Polarity & Test Distance: Horizontal at 3 m

Frequency (MHz)	Emission Level (dBuV/m)	Read Level (dBuV)	Limit (dBuV/m)	Margin (dB)	Antenna Factor (dB/m)	Cable Loss (dB)	Preamp Factor (dB)	Antenna Height (cm)	Table Angle (Degree)	Remark
2488.68	58.13	64.09	74	-15.87	27.2	4.16	37.32	166	176	Peak
2483.52	34.09	40.11	54	-19.91	27.15	4.15	37.32	166	176	Average
2480	83.15	89.17			27.15	4.15	37.32	166	176	Average
2480	97.89	103.91			27.15	4.15	37.32	166	176	Peak
4960	31.25	46.22	54	-22.75	31.16	6.91	53.04	128	62	Average
4960	43.98	58.95	74	-30.02	31.16	6.91	53.04	128	62	Peak

Antenna Polarity & Test Distance: Vertical at 3 m

Frequency (MHz)	Emission Level (dBuV/m)	Read Level (dBuV)	Limit (dBuV/m)	Margin (dB)	Antenna Factor (dB/m)	Cable Loss (dB)	Preamp Factor (dB)	Antenna Height (cm)	Table Angle (Degree)	Remark
2490.28	57.32	63.28	74	-16.68	27.2	4.16	37.32	197	312	Peak
2483.52	33.5	39.52	54	-20.5	27.15	4.15	37.32	197	312	Average
2480	77.19	83.21			27.15	4.15	37.32	197	312	Average
2480	89.41	95.43			27.15	4.15	37.32	197	312	Peak
4960	31.01	45.98	54	-22.99	31.16	6.91	53.04	169	241	Average
4960	43.78	58.75	74	-30.22	31.16	6.91	53.04	169	241	Peak

Remarks:

- Emission Level = Read Level + Antenna Factor + Cable Loss - Preamp Factor
Margin value = Emission level – Limit value
- 2480 MHz: Fundamental frequency.

9 kHz ~ 30 MHz DATA:

The amplitude of spurious emissions attenuated more than 20 dB below the permissible value is not required to be report.

30 MHz ~ 1 GHz WORST-CASE DATA:

EUT Test Condition		Measurement Detail	
Channel	Channel 78	Frequency Range	30 MHz ~ 1 GHz
Input Power	120 Vac, 60 Hz	Detector Function	Peak (PK) Quasi-peak (QP)
Environmental Conditions	25 deg. C, 65 % RH	Tested By	Getaz Yang

Horizontal

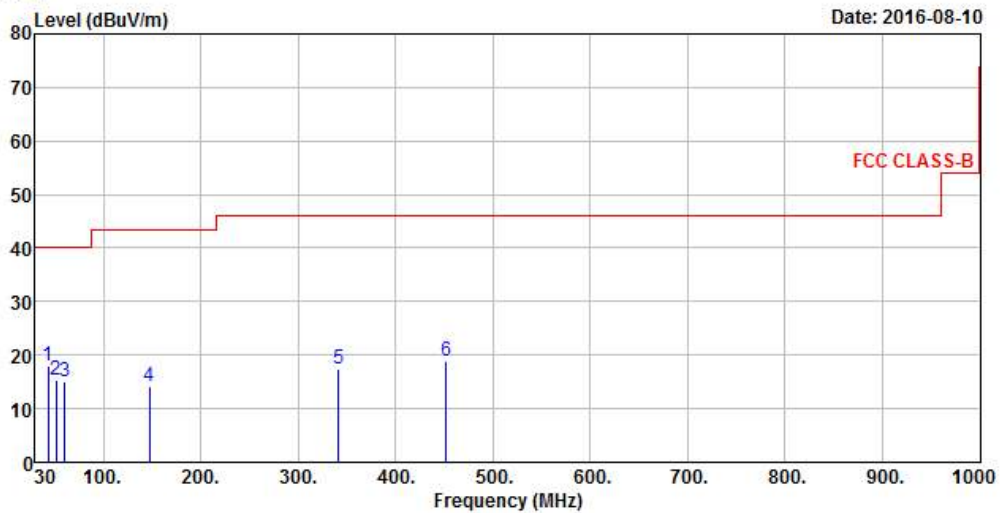

Vertical

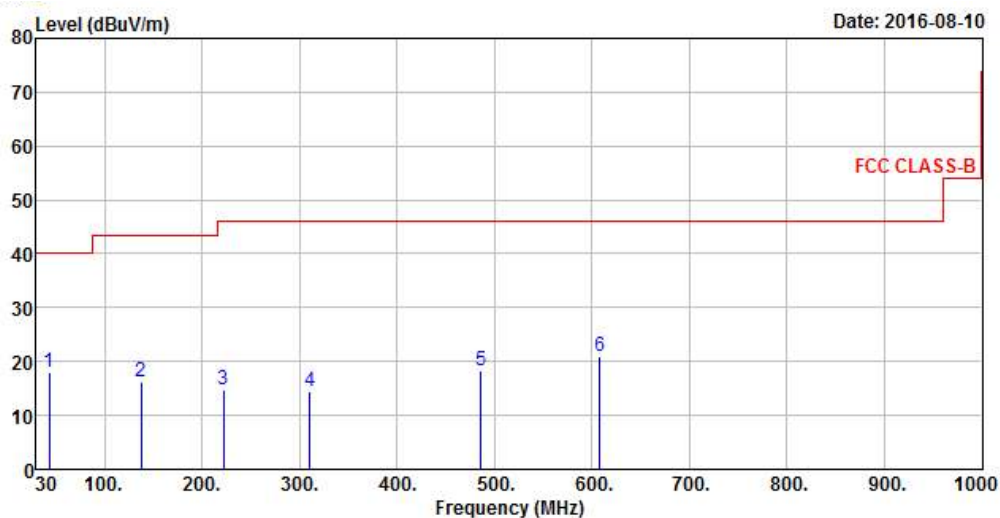

Antenna Polarity & Test Distance: Horizontal at 3 m

Frequency (MHz)	Emission Level (dBuV/m)	Read Level (dBuV)	Limit (dBuV/m)	Margin (dB)	Antenna Factor (dB/m)	Cable Loss (dB)	Preamp Factor (dB)	Antenna Height (cm)	Table Angle (Degree)	Remark
43.58	18.11	34.96	40	-21.89	13.59	0.67	31.11	133	184	Peak
51.34	15.4	33.13	40	-24.6	12.87	0.71	31.31	121	296	Peak
60.07	15.12	33.73	40	-24.88	11.94	0.81	31.36	102	308	Peak
147.37	14.14	32	43.5	-29.36	12.61	1.15	31.62	131	342	Peak
341.37	17.43	33.57	46	-28.57	13.94	1.74	31.82	102	143	Peak
451.95	18.77	32.39	46	-27.23	16.37	1.99	31.98	110	309	Peak

Antenna Polarity & Test Distance: Vertical at 3 m

Frequency (MHz)	Emission Level (dBuV/m)	Read Level (dBuV)	Limit (dBuV/m)	Margin (dB)	Antenna Factor (dB/m)	Cable Loss (dB)	Preamp Factor (dB)	Antenna Height (cm)	Table Angle (Degree)	Remark
43.58	17.9	34.75	40	-22.1	13.59	0.67	31.11	110	317	Peak
137.67	16.33	34.66	43.5	-27.17	12.21	1.15	31.69	140	58	Peak
222.06	14.83	34.89	46	-31.17	10.3	1.38	31.74	103	249	Peak
310.33	14.48	31.57	46	-31.52	13.2	1.66	31.95	123	74	Peak
485.9	18.34	31.04	46	-27.66	17.04	2.06	31.8	105	135	Peak
608.12	21.09	31.22	46	-24.91	19.7	2.28	32.11	137	264	Peak

Remarks:

- Emission Level = Read Level + Antenna Factor + Cable Loss - Preamp Factor
Margin value = Emission level – Limit value

5 Pictures of Test Arrangements

Please refer to the attached file (Test Setup Photo).

Appendix – Information on the Testing Laboratories

We, Bureau Veritas Consumer Products Services (H.K.) Ltd., Taoyuan Branch, were founded in 1988 to provide our best service in EMC, Radio, Telecom and Safety consultation. Our laboratories are accredited and approved according to ISO/IEC 17025.

If you have any comments, please feel free to contact us at the following:

Linko EMC/RF Lab

Tel: 886-2-26052180

Fax: 886-2-26051924

Hsin Chu EMC/RF/Telecom Lab

Tel: 886-3-6668565

Fax: 886-3-6668323

Hwa Ya EMC/RF/Safety

Tel: 886-3-3183232

Fax: 886-3-3270892

Email: service.adt@tw.bureauveritas.com

Web Site: www.bureauveritas-adt.com

The address and road map of all our labs can be found in our web site also.

--- END ---