

## Variant FCC Test Report

**Report No.:** RF160517C23

**FCC ID:** UK7-DW2

**Test Model:** DW2d

**Received Date:** May 17, 2016

**Test Date:** May 26, 2016 ~ Jun. 01, 2016

**Issued Date:** Jun. 08, 2016

**Applicant:** Fossil Group, Inc.

**Address:** 901 S. Central Expwy., Richardson, TX 75080 USA

**Issued By:** Bureau Veritas Consumer Products Services (H.K.) Ltd., Taoyuan Branch

**Lab Address:** No. 47-2, 14th Ling, Chia Pau Vil., Lin Kou Dist., New Taipei City, Taiwan  
( R.O.C )

**Test Location (1):** No. 19, Hwa Ya 2nd Rd, Wen Hwa Tsuen, Kwei Shan Hsiang, Taoyuan  
Hsien 333, Taiwan, R.O.C.



This report is for your exclusive use. Any copying or replication of this report to or for any other person or entity, or use of our name or trademark, is permitted only with our prior written permission. This report sets forth our findings solely with respect to the test samples identified herein. The results set forth in this report are not indicative or representative of the quality or characteristics of the lot from which a test sample was taken or any similar or identical product unless specifically and expressly noted. Our report includes all of the tests requested by you and the results thereof based upon the information that you provided to us. You have 60 days from date of issuance of this report to notify us of any material error or omission caused by our negligence, provided, however, that such notice shall be in writing and shall specifically address the issue you wish to raise. A failure to raise such issue within the prescribed time shall constitute your unqualified acceptance of the completeness of this report, the tests conducted and the correctness of the report contents. Unless specifically mentioned, the uncertainty of measurement has been explicitly taken into account to declare the compliance or non-compliance to the specification.

## Table of Contents

<b>Release Control Record .....</b>	<b>3</b>
<b>1 Certificate of Conformity .....</b>	<b>4</b>
<b>2 Summary of Test Results.....</b>	<b>5</b>
2.1 Measurement Uncertainty.....	5
2.2 Modification Record .....	5
<b>3 General Information .....</b>	<b>6</b>
3.1 General Description of EUT .....	6
3.2 Description of Test Modes.....	7
3.2.1 Test Mode Applicability and Tested Channel Detail.....	8
3.3 Description of Support Units .....	9
3.3.1 Configuration of System under Test .....	9
3.4 General Description of Applied Standards.....	10
<b>4 Test Types and Results .....</b>	<b>11</b>
4.1 Radiated Emission and Bandedge Measurement .....	11
4.1.1 Limits of Radiated Emission and Bandedge Measurement .....	11
4.1.2 Test Instruments .....	12
4.1.3 Test Procedures.....	13
4.1.4 Deviation from Test Standard .....	13
4.1.5 Test Set Up .....	14
4.1.6 EUT Operating Conditions.....	14
4.1.7 Test Results .....	15
4.2 Conducted Emission Measurement.....	19
4.2.1 Limits of Conducted Emission Measurement .....	19
4.2.2 Test Instruments .....	19
4.2.3 Test Procedures.....	20
4.2.4 Deviation from Test Standard .....	20
4.2.5 Test Setup.....	20
4.2.6 EUT Operating Conditions.....	20
4.2.7 Test Results .....	21
<b>5 Pictures of Test Arrangements.....</b>	<b>23</b>
<b>Appendix – Information on the Testing Laboratories .....</b>	<b>24</b>

### Release Control Record

Issue No.	Description	Date Issued
RF160517C23	Original Release	Jun. 08, 2016

**1 Certificate of Conformity**

**Product:** Smart Watch

**Brand:** MICHAEL KORS

**Test Model:** DW2d

**Sample Status:** Identical Prototype

**Applicant:** Fossil Group, Inc.

**Test Date:** May 26, 2016 ~ Jun. 01, 2016

**Standards:** 47 CFR FCC Part 15, Subpart C (Section 15.247)  
ANSI C63.10:2013

This report is issued as a supplementary report to BV CPS report no.: RF160517C19. This report shall be used by combining with its original report.

**Prepared by :**  , **Date:** Jun. 08, 2016  
Ivonne Wu / Supervisor

**Approved by :**  , **Date:** Jun. 08, 2016  
Stanley Wu / Assistant Manager

## 2 Summary of Test Results

47 CFR FCC Part 15, Subpart C (Section 15.247)			
FCC Clause	Test Item	Result	Remarks
15.207	AC Power Conducted Emission	Pass	Meet the requirement of limit. Minimum passing margin is -1.16 dB at 0.79124 MHz.
15.205 / 15.209 / 15.247(d)	Radiated Emissions and Band Edge Measurement	Pass	Meet the requirement of limit. Minimum passing margin is -11.06 dB at 63.95 MHz.
15.247(d)	Antenna Port Emission	N/A	Refer to Note
15.247(a)(2)	6 dB Bandwidth	N/A	Refer to Note
15.247(b)	Conducted power	N/A	Refer to Note
15.247(e)	Power Spectral Density	N/A	Refer to Note
15.203	Antenna Requirement	Pass	No antenna connector is used.

Note: Only conducted emission and radiated emission tests were performed for this addendum. Refer to original report for other test data.

### 2.1 Measurement Uncertainty

Where relevant, the following measurement uncertainty levels have been estimated for tests performed on the EUT:

The listed uncertainties are the worst case uncertainty for the entire range of measurement. Please note that the uncertainty values are provided for informational purposes only and are not used in determining the PASS/FAIL results.

Measurement	Frequency	Expanded Uncertainty (k=2) ( $\pm$ )
Conducted Emissions at mains ports	150 kHz ~ 30 MHz	2.44 dB
Radiated Emissions up to 1 GHz	30 MHz ~ 200 MHz	2.93 dB
	200 MHz ~ 1000 MHz	2.95 dB
Radiated Emissions above 1 GHz	1 GHz ~ 18 GHz	2.26 dB
	18 GHz ~ 40 GHz	1.94 dB

### 2.2 Modification Record

There were no modifications required for compliance.

### 3 General Information

#### 3.1 General Description of EUT

<b>Product</b>	Smart Watch
<b>Brand</b>	MICHAEL KORS
<b>Test Model</b>	DW2d
<b>Status of EUT</b>	Identical Prototype
<b>Power Supply Rating</b>	3.8 Vdc (from battery) 5 Vdc (from wireless charger)
<b>Modulation Type</b>	CCK, DQPSK, DBPSK for DSSS 64QAM, 16QAM, QPSK, BPSK for OFDM
<b>Modulation Technology</b>	DSSS, OFDM
<b>Transfer Rate</b>	802.11b: 11.0 / 5.5 / 2.0 / 1.0 Mbps 802.11g: 54.0 / 48.0 / 36.0 / 24.0 / 18.0 / 12.0 / 9.0 / 6.0 Mbps 802.11n: up to MCS7
<b>Operating Frequency</b>	2412 ~ 2462 MHz
<b>Number of Channel</b>	11
<b>Antenna Type</b>	Loop antenna with -6.55 dBi gain
<b>Antenna Connector</b>	N/A
<b>Accessory Device</b>	N/A
<b>Data Cable Supplied</b>	N/A

Note:

1. This report is issued as a supplementary report to BV CPS report no.: RF160517C19. The difference compared with original report is changing the strap, material of EUT, and antenna gain. Therefore, only conducted emission and radiated emission tests were performed and presented in this report.
2. The WLAN/BT Module (Brand: FOSSIL, Model: DW2) was installed in the EUT.
3. The EUT contains following accessory devices.

Product	Brand	Model	Description
Battery	MICHAEL KORS	APP00169	3.8 Vdc, 400 mAh
Wireless Charger	MICHAEL KORS	FW1D25S2-00	O/P: 5 Vdc, 0.25 A I/P: 5 Vdc (from USB port)
LCD Panel	AUO	H140QVN01.1	1.4 inch

4. The above EUT information is declared by manufacturer and for more detailed features description, please refer to the manufacturer's specifications or user's manual.

### 3.2 Description of Test Modes

11 channels are provided for 802.11b, 802.11g and 802.11n (HT20):

Channel	Frequency (MHz)	Channel	Frequency (MHz)
1	2412	7	2442
2	2417	8	2447
3	2422	9	2452
4	2427	10	2457
5	2432	11	2462
6	2437		

### 3.2.1 Test Mode Applicability and Tested Channel Detail

EUT Configure Mode	Applicable To			Description
	RE $\geq$ 1G	RE $<$ 1G	PLC	
A	√	√	-	Standalone
B	√	√	√	EUT with Wireless Charger

Where **RE $\geq$ 1G**: Radiated Emission above 1 GHz      **RE $<$ 1G**: Radiated Emission below 1 GHz  
**PLC**: Power Line Conducted Emission

**NOTE:** The EUT had been pre-tested on the positioned of each 3 axis. The worst case was found when positioned on **X-plane**.  
**NOTE:** "-" means no effect.

#### **Radiated Emission Test (Above 1 GHz):**

- Pre-Scan has been conducted to determine the worst-case mode from all possible combinations between available modulations, data rates and antenna ports (if EUT with antenna diversity architecture).
- Following channel(s) was (were) selected for the final test as listed below.

EUT Configure Mode	Mode	Available Channel	Tested Channel	Modulation Technology	Modulation Type	Data Rate (Mbps)
A, B	802.11n (HT20)	1 to 11	1	OFDM	BPSK	MCS0

#### **Radiated Emission Test (Below 1 GHz):**

- Pre-Scan has been conducted to determine the worst-case mode from all possible combinations between available modulations, data rates and antenna ports (if EUT with antenna diversity architecture).
- Following channel(s) was (were) selected for the final test as listed below.

EUT Configure Mode	Mode	Available Channel	Tested Channel	Modulation Technology	Modulation Type	Data Rate (Mbps)
A, B	802.11n (HT20)	1 to 11	1	OFDM	BPSK	MCS0

#### **Power Line Conducted Emission Test:**

- Pre-Scan has been conducted to determine the worst-case mode from all possible combinations between available modulations, data rates and antenna ports (if EUT with antenna diversity architecture).
- Following channel(s) was (were) selected for the final test as listed below.

EUT Configure Mode	Mode	Available Channel	Tested Channel	Modulation Technology	Modulation Type	Data Rate (Mbps)
B	802.11n (HT20)	1 to 11	1	OFDM	BPSK	MCS0

#### **Test Condition:**

Applicable To	Environmental Conditions	Input Power	Tested by
RE $\geq$ 1G	25 deg. C, 65 % RH	3.8 Vdc / 5 Vdc	Toby Tian
RE $<$ 1G	25 deg. C, 65 % RH	3.8 Vdc / 5 Vdc	Toby Tian
PLC	25 deg. C, 65 % RH	5 Vdc	Toby Tian



### 3.3 Description of Support Units

The EUT has been tested as an independent unit together with other necessary accessories or support units. The following support units or accessories were used to form a representative test configuration during the tests.

No.	Product	Brand	Model No.	Serial No.	FCC ID
1.	Adapter	Salcomp	TC U250	N/A	N/A
2.	USB Cable	ASAP	LA05US014-1N	N/A	N/A

No.	Signal Cable Description Of The Above Support Units
1.	N/A
2.	N/A

Note:

1. All power cords of the above support units are non-shielded (1.8m).

#### 3.3.1 Configuration of System under Test

##### <Mode A>

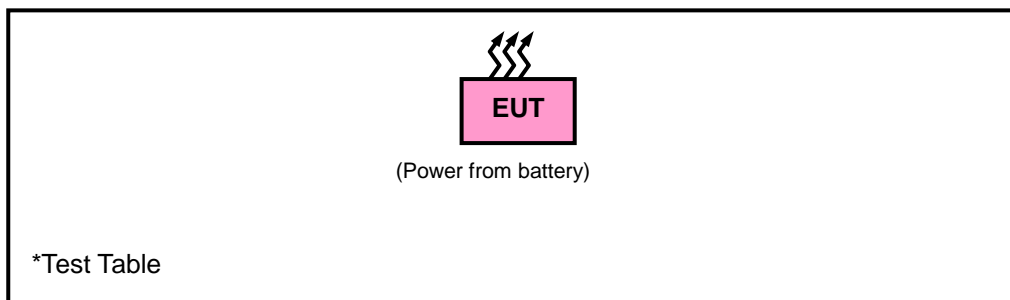

##### <Mode B>

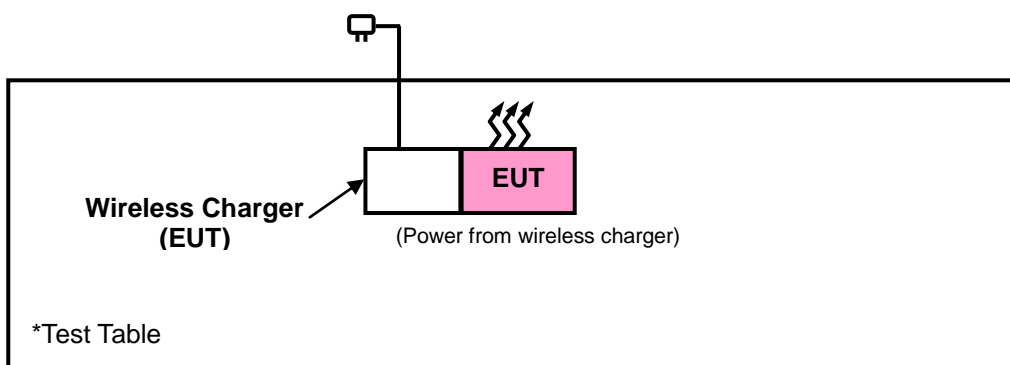

### 3.4 General Description of Applied Standards

The EUT is a RF Product. According to the specifications of the manufacturer, it must comply with the requirements of the following standards:

**FCC Part 15, Subpart C (15.247)**

**558074 D01 DTS Meas Guidance v03r05**

ANSI C63.10-2013

All test items have been performed and recorded as per the above standards.

**NOTE:** The EUT has been verified to comply with the requirements of FCC Part 15, Subpart B, Class B (DoC).  
The test report has been issued separately.

## 4 Test Types and Results

### 4.1 Radiated Emission and Bandedge Measurement

#### 4.1.1 Limits of Radiated Emission and Bandedge Measurement

Radiated emissions which fall in the restricted bands must comply with the radiated emission limits specified as below table. Other emissions shall be at least 20 dB below the highest level of the desired power:

Frequencies (MHz)	Field Strength (microvolts/meter)	Measurement Distance (meters)
0.009 ~ 0.490	2400/F (kHz)	300
0.490 ~ 1.705	24000/F (kHz)	30
1.705 ~ 30.0	30	30
30 ~ 88	100	3
88 ~ 216	150	3
216 ~ 960	200	3
Above 960	500	3

**NOTE:**

1. The lower limit shall apply at the transition frequencies.
2. Emission level (dBuV/m) = 20 log Emission level (uV/m).
3. For frequencies above 1000 MHz, the field strength limits are based on average detector, however, the peak field strength of any emission shall not exceed the maximum permitted average limits, specified above by more than 20 dB under any condition of modulation.

4.1.2 Test Instruments

Description & Manufacturer	Model No.	Serial No.	Date of Calibration	Due Date of Calibration
Test Receiver Agilent	N9038A	MY51210203	Jan. 21, 2016	Jan. 20, 2017
Spectrum Analyzer Agilent	N9010A	MY52220314	Sep. 03, 2015	Sep. 02, 2016
Spectrum Analyzer ROHDE & SCHWARZ	FSU43	101261	Dec. 17, 2015	Dec. 16, 2016
BILOG Antenna SCHWARZBECK	VULB9168	9168-472	Jan. 07, 2016	Jan. 06, 2017
HORN Antenna SCHWARZBECK	BBHA 9120 D	9120D-969	Jan. 04, 2016	Jan. 03, 2017
HORN Antenna SCHWARZBECK	BBHA 9170	9170-480	Jan. 08, 2016	Jan. 07, 2017
Loop Antenna	EM-6879	269	Jul. 31, 2015	Jul. 30, 2016
Bluetooth Tester	CBT	100980	Apr. 27, 2015	Apr. 26, 2017
Agilent Communications Tester-Wireless	8960 Series 10	MY53201073	Jul. 03, 2015	Jul. 02, 2017
Preamplifier EMCI	EMC 012645	980115	Dec. 21, 2015	Dec. 20, 2016
Preamplifier EMCI	EMC 184045	980116	Dec. 21, 2015	Dec. 20, 2016
Preamplifier EMCI	EMC 330H	980112	Dec. 28, 2015	Dec. 27, 2016
Power Meter Anritsu	ML2495A	1232002	Sep. 21, 2015	Sep. 20, 2016
Power Sensor Anritsu	MA2411B	1207325	Sep. 21, 2015	Sep. 20, 2016
RF signal cable HUBER+SUHNNER	SUCOFLEX 104	309219/4 2950114	Oct. 12, 2015	Oct. 11, 2016
RF signal cable HUBER+SUHNNER	SUCOFLEX 104	250130/4	Oct. 12, 2015	Oct. 11, 2016
RF Coaxial Cable Worken	8D-FB	Cable-Ch10-01	Oct. 12, 2015	Oct. 11, 2016
Software BV ADT	E3 6.120103	NA	NA	NA
Antenna Tower MF	MFA-440H	NA	NA	NA
Turn Table MF	MFT-201SS	NA	NA	NA
Antenna Tower & Turn Table Controller MF	MF-7802	NA	NA	NA

- Note: 1. The calibration interval of the above test instruments is 12 months and the calibrations are traceable to NML/ROC and NIST/USA.
2. The test was performed in HwaYa Chamber 10.
3. The horn antenna and preamplifier (model: EMC 184045) are used only for the measurement of emission frequency above 1 GHz if tested.
4. The FCC Site Registration No. is 690701.
5. The IC Site Registration No. is IC7450F-10.

#### 4.1.3 Test Procedures

- a. The EUT was placed on the top of a rotating table 0.8 meters (for below 1 GHz) / 1.5 meters (for above 1 GHz) above the ground at 3 meter chamber room for test. The table was rotated 360 degrees to determine the position of the highest radiation.
- b. The EUT was set 3 meters away from the interference-receiving antenna, which was mounted on the top of a variable-height antenna tower.
- c. The height of antenna is varied from one meter to four meters above the ground to determine the maximum value of the field strength. Both horizontal and vertical polarizations of the antenna are set to make the measurement.
- d. For each suspected emission, the EUT was arranged to its worst case and then the antenna was tuned to heights from 1 meter to 4 meters and the rotatable table was turned from 0 degrees to 360 degrees to find the maximum reading.
- e. The test-receiver system was set to quasi-peak detect function and specified bandwidth with maximum hold mode when the test frequency is below 1 GHz.
- f. The test-receiver system was set to peak and average detected function and specified bandwidth with maximum hold mode when the test frequency is above 1 GHz. If the peak reading value also meets average limit, measurement with the average detector is unnecessary.

**Note:**

1. The resolution bandwidth and video bandwidth of test receiver/spectrum analyzer is 120 kHz for Quasi-peak detection (QP) at frequency below 1 GHz.
2. The resolution bandwidth of test receiver/spectrum analyzer is 1 MHz and the video bandwidth is 3 MHz for Peak detection (PK) at frequency above 1 GHz.
3. The resolution bandwidth of test receiver/spectrum analyzer is 1 MHz and the video bandwidth is 3 MHz for RMS Average (Duty cycle < 98 %) for Average detection (AV) at frequency above 1 GHz, then the measurement results was added to a correction factor ( $10 \log(1/\text{duty cycle})$ ).
4. The resolution bandwidth of test receiver/spectrum analyzer is 1MHz and the video bandwidth is 10 Hz (Duty cycle  $\geq 98$  %) for Average detection (AV) at frequency above 1 GHz.
5. All modes of operation were investigated and the worst-case emissions are reported.

#### 4.1.4 Deviation from Test Standard

No deviation.

#### 4.1.5 Test Set Up

##### <Frequency Range below 1 GHz>

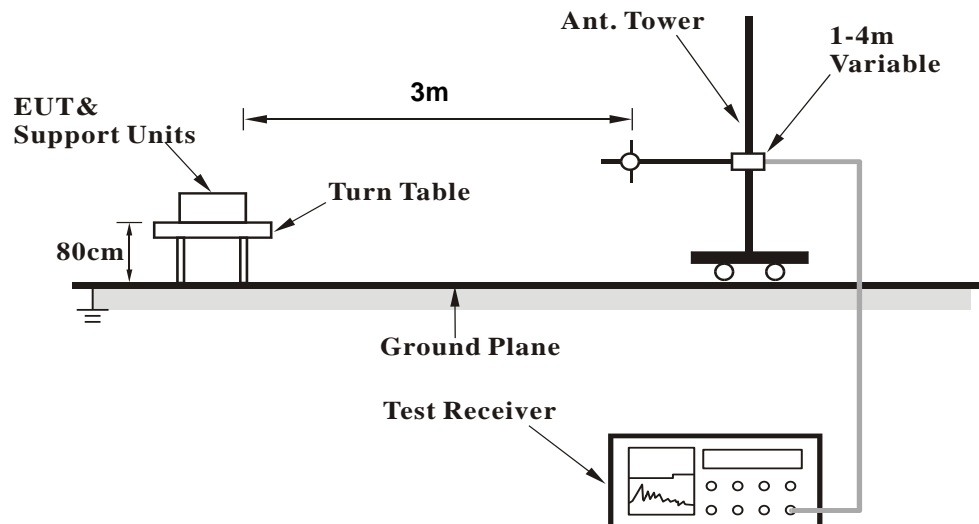

##### <Frequency Range above 1 GHz>

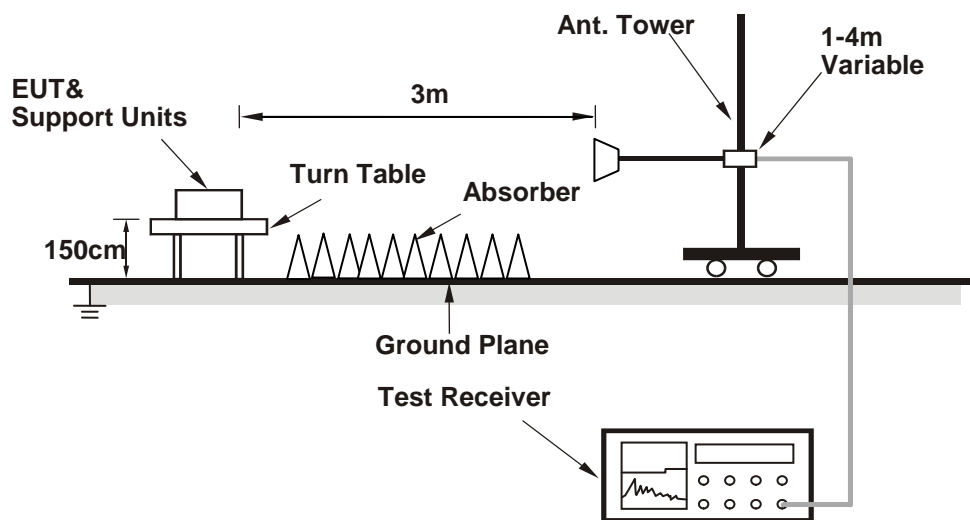

For the actual test configuration, please refer to the attached file (Test Setup Photo).

#### 4.1.6 EUT Operating Conditions

- Placed the EUT on a testing table.
- Use the software to control the EUT under transmission condition continuously at specific channel frequency.

4.1.7 Test Results

Above 1 GHz Data :

Mode A

802.11n (HT20)

EUT Test Condition		Measurement Detail	
Channel	Channel 1	Frequency Range	1 GHz ~ 25 GHz
Input Power	120 Vac, 60 Hz	Detector Function	Peak (PK) Average (AV)
Environmental Conditions	25 deg. C, 65 % RH	Tested By	Toby Tian

Antennal Polarity & Test Distance: Horizontal at 3 m										
Frequency (MHz)	Emission Level (dBuV/m)	Read Level (dBuV)	Limit (dBuV/m)	Margin (dB)	Antenna Factor (dB/m)	Cable Loss (dB)	Preamp Factor (dB)	Antenna Height (cm)	Table Angle (Degree)	Remark
2366	34.5	41.12	54	-19.5	26.81	4.07	37.5	177	265	Average
2366	58.87	65.49	74	-15.13	26.81	4.07	37.5	177	265	Peak
2412	80.98	87.45			26.96	4.09	37.52	177	265	Average
2412	90.59	97.06			26.96	4.09	37.52	177	265	Peak
2500	34.8	40.69	54	-19.2	27.2	4.16	37.25	177	265	Average
2500	57.23	63.12	74	-16.77	27.2	4.16	37.25	177	265	Peak
Antennal Polarity & Test Distance: Vertical at 3 m										
Frequency (MHz)	Emission Level (dBuV/m)	Read Level (dBuV)	Limit (dBuV/m)	Margin (dB)	Antenna Factor (dB/m)	Cable Loss (dB)	Preamp Factor (dB)	Antenna Height (cm)	Table Angle (Degree)	Remark
2390	35.03	41.56	54	-18.97	26.91	4.08	37.52	163	187	Average
2390	57.93	64.46	74	-16.07	26.91	4.08	37.52	163	187	Peak
2412	78.51	84.98			26.96	4.09	37.52	163	187	Average
2412	85.22	91.69			26.96	4.09	37.52	163	187	Peak
2500	35.6	41.49	54	-18.4	27.2	4.16	37.25	163	187	Average
2500	56.26	62.15	74	-17.74	27.2	4.16	37.25	163	187	Peak

Remarks:

- Emission Level = Read Level + Antenna Factor + Cable Loss - Preamp Factor  
Margin value = Emission level – Limit value
- 2412 MHz: Fundamental frequency.

**Mode B**  
**802.11n (HT20)**

EUT Test Condition		Measurement Detail	
Channel	Channel 1	Frequency Range	1 GHz ~ 25 GHz
Input Power	120 Vac, 60 Hz	Detector Function	Peak (PK) Average (AV)
Environmental Conditions	25 deg. C, 65 % RH	Tested By	Toby Tian

Antennal Polarity & Test Distance: Horizontal at 3 m										
Frequency (MHz)	Emission Level (dBuV/m)	Read Level (dBuV)	Limit (dBuV/m)	Margin (dB)	Antenna Factor (dB/m)	Cable Loss (dB)	Preamp Factor (dB)	Antenna Height (cm)	Table Angle (Degree)	Remark
2388	35.92	42.43	54	-18.08	26.91	4.08	37.5	108	77	Average
2388	56.7	63.21	74	-17.3	26.91	4.08	37.5	108	77	Peak
2412	81.58	88.05			26.96	4.09	37.52	108	77	Average
2412	89.51	95.98			26.96	4.09	37.52	108	77	Peak
2496	35.28	41.17	54	-18.72	27.2	4.16	37.25	108	77	Average
2496	57.75	63.64	74	-16.25	27.2	4.16	37.25	108	77	Peak

Antennal Polarity & Test Distance: Vertical at 3 m										
Frequency (MHz)	Emission Level (dBuV/m)	Read Level (dBuV)	Limit (dBuV/m)	Margin (dB)	Antenna Factor (dB/m)	Cable Loss (dB)	Preamp Factor (dB)	Antenna Height (cm)	Table Angle (Degree)	Remark
2360	35.37	42	54	-18.63	26.81	4.05	37.49	200	19	Average
2360	56.18	62.81	74	-17.82	26.81	4.05	37.49	200	19	Peak
2412	78.47	84.94			26.96	4.09	37.52	200	19	Average
2412	88.35	94.82			26.96	4.09	37.52	200	19	Peak
2496	34.72	40.61	54	-19.28	27.2	4.16	37.25	200	19	Average
2496	56.89	62.78	74	-17.11	27.2	4.16	37.25	200	19	Peak

Remarks:

- Emission Level = Read Level + Antenna Factor + Cable Loss - Preamp Factor  
Margin value = Emission level – Limit value
- 2412 MHz: Fundamental frequency.



**9 kHz ~ 30 MHz DATA:**

The amplitude of spurious emissions attenuated more than 20 dB below the permissible value is not required to be report.

**30 MHz ~ 1 GHz WORST-CASE DATA:**

Mode A

802.11n (HT20)

EUT Test Condition		Measurement Detail	
Channel	Channel 1	Frequency Range	30 MHz ~ 1 GHz
Input Power	120 Vac, 60 Hz	Detector Function	Peak (PK) Quasi-peak (QP)
Environmental Conditions	25 deg. C, 65 % RH	Tested By	Toby Tian

Antennal Polarity & Test Distance: Horizontal at 3 m										
Frequency (MHz)	Emission Level (dBuV/m)	Read Level (dBuV)	Limit (dBuV/m)	Margin (dB)	Antenna Factor (dB/m)	Cable Loss (dB)	Preamp Factor (dB)	Antenna Height (cm)	Table Angle (Degree)	Remark
30.97	20.27	38.66	40	-19.73	12.14	0.59	31.12	138	318	Peak
167.74	28.09	46.74	43.5	-15.41	11.96	1.15	31.76	123	117	Peak
267.65	28.74	47.19	46	-17.26	12	1.54	31.99	120	352	Peak
349.13	20.99	36.95	46	-25.01	14.12	1.76	31.84	124	310	Peak
482.02	22.93	35.75	46	-23.07	16.96	2.05	31.83	113	324	Peak
574.17	22.59	33.46	46	-23.41	19.01	2.22	32.1	137	145	Peak
Antennal Polarity & Test Distance: Vertical at 3 m										
Frequency (MHz)	Emission Level (dBuV/m)	Read Level (dBuV)	Limit (dBuV/m)	Margin (dB)	Antenna Factor (dB/m)	Cable Loss (dB)	Preamp Factor (dB)	Antenna Height (cm)	Table Angle (Degree)	Remark
31.94	27.81	46.03	40	-12.19	12.3	0.59	31.11	137	303	Peak
63.95	28.94	48.17	40	-11.06	11.47	0.84	31.54	133	20	Peak
159.01	22.76	40.74	43.5	-20.74	12.73	1.14	31.85	130	8	Peak
256.01	18.35	37.08	46	-27.65	11.65	1.51	31.89	127	198	Peak
443.22	19.45	33.26	46	-26.55	16.2	1.98	31.99	108	208	Peak
563.5	22.55	33.65	46	-23.45	18.77	2.2	32.07	134	237	Peak

Remarks:

- Emission Level = Read Level + Antenna Factor + Cable Loss - Preamp Factor  
Margin value = Emission level – Limit value

**Mode B**
**802.11n (HT20)**

EUT Test Condition		Measurement Detail	
Channel	Channel 1	Frequency Range	30 MHz ~ 1 GHz
Input Power	120 Vac, 60 Hz	Detector Function	Peak (PK) Quasi-peak (QP)
Environmental Conditions	25 deg. C, 65 % RH	Tested By	Toby Tian

**Antennal Polarity & Test Distance: Horizontal at 3 m**

Frequency (MHz)	Emission Level (dBuV/m)	Read Level (dBuV)	Limit (dBuV/m)	Margin (dB)	Antenna Factor (dB/m)	Cable Loss (dB)	Preamp Factor (dB)	Antenna Height (cm)	Table Angle (Degree)	Remark
33.88	19.78	37.63	40	-20.22	12.63	0.6	31.08	139	16	Peak
104.69	21.72	43.01	43.5	-21.78	9.53	1.08	31.9	123	193	Peak
208.48	21.66	42.22	43.5	-21.84	9.73	1.33	31.62	113	357	Peak
558.65	22.04	33.24	46	-23.96	18.66	2.19	32.05	109	5	Peak
608.12	21.58	31.71	46	-24.42	19.7	2.28	32.11	140	87	Peak
693.48	23.89	32.53	46	-22.11	20.74	2.44	31.82	137	282	Peak

**Antennal Polarity & Test Distance: Vertical at 3 m**

Frequency (MHz)	Emission Level (dBuV/m)	Read Level (dBuV)	Limit (dBuV/m)	Margin (dB)	Antenna Factor (dB/m)	Cable Loss (dB)	Preamp Factor (dB)	Antenna Height (cm)	Table Angle (Degree)	Remark
30	28.77	47.35	40	-11.23	11.98	0.58	31.14	107	303	Peak
39.7	28.58	45.39	40	-11.42	13.54	0.64	30.99	119	356	Peak
63.95	27.96	47.19	40	-12.04	11.47	0.84	31.54	126	215	Peak
93.05	23.11	45.55	43.5	-20.39	8.53	0.99	31.96	120	347	Peak
590.66	20.78	31.3	46	-25.22	19.39	2.24	32.15	132	334	Peak
632.37	22.8	32.61	46	-23.2	20	2.32	32.13	104	325	Peak

## Remarks:

- Emission Level = Read Level + Antenna Factor + Cable Loss - Preamp Factor  
Margin value = Emission level – Limit value

## 4.2 Conducted Emission Measurement

### 4.2.1 Limits of Conducted Emission Measurement

Frequency (MHz)	Conducted Limit (dBuV)	
	Quasi-peak	Average
0.15 - 0.5	66 - 56	56 - 46
0.50 - 5.0	56	46
5.0 - 30.0	60	50

Note: 1. The lower limit shall apply at the transition frequencies.

2. The limit decreases in line with the logarithm of the frequency in the range of 0.15 to 0.50 MHz.

### 4.2.2 Test Instruments

Description & Manufacturer	Model No.	Serial No.	Date of Calibration	Due Date of Calibration
Test Receiver ROHDE & SCHWARZ	ESCI	100613	Nov. 16, 2015	Nov. 15, 2016
RF signal cable (with 10dB PAD) Woken	5D-FB	Cable-cond1-01	Dec. 26, 2015	Dec. 25, 2016
LISN ROHDE & SCHWARZ (EUT)	ESH3-Z5	835239/001	Feb. 26, 2016	Feb. 25, 2017
LISN ROHDE & SCHWARZ (Peripheral)	ESH3-Z5	100311	Jul. 24, 2015	Jul. 23, 2016
Software ADT	BV ADT_Cond_ V7.3.7.3	NA	NA	NA

Note: 1. The calibration interval of the above test instruments is 12 months and the calibrations are traceable to NML/ROC and NIST/USA.

2. The test was performed in HwaYa Shielded Room 1.

3. The VCCI Site Registration No. is C-2040.

#### 4.2.3 Test Procedures

- a. The EUT was placed 0.4 meters from the conducting wall of the shielded room with EUT being connected to the power mains through a line impedance stabilization network (LISN). Other support units were connected to the power mains through another LISN. The two LISNs provide 50 ohm/50 uH of coupling impedance for the measuring instrument.
- b. Both lines of the power mains connected to the EUT were checked for maximum conducted interference.
- c. The frequency range from 150 kHz to 30 MHz was searched. Emission levels under (Limit – 20 dB) was not recorded.

**NOTE:** All modes of operation were investigated and the worst-case emissions are reported.

#### 4.2.4 Deviation from Test Standard

No deviation.

#### 4.2.5 Test Setup

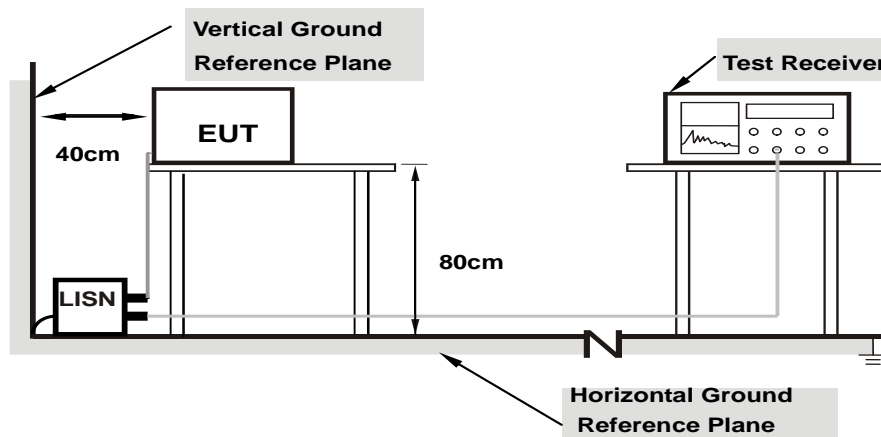

**Note: 1. Support units were connected to second LISN.**

For the actual test configuration, please refer to the attached file (Test Setup Photo).

#### 4.2.6 EUT Operating Conditions

- a. Placed the EUT on a testing table.
- b. Use the software to control the EUT under transmission condition continuously at specific channel frequency.

#### 4.2.7 Test Results

Frequency Range	150kHz ~ 30MHz	Detector Function & Resolution Bandwidth	Quasi-Peak (QP) / Average (AV), 9kHz
Input Power	120Vac, 60Hz	Environmental Conditions	25°C, 65%RH
Tested by	Toby Tian	Test Date	2016/5/28

Phase Of Power : Line (L)										
No	Frequency (MHz)	Correction Factor (dB)	Reading Value (dBuV)		Emission Level (dBuV)		Limit (dBuV)		Margin (dB)	
			Q.P.	AV.	Q.P.	AV.	Q.P.	AV.	Q.P.	AV.
1	0.16173	10.02	40.40	32.61	50.42	42.63	65.37	55.37	-14.96	-12.75
2	0.31813	10.08	36.08	22.85	46.16	32.93	59.76	49.76	-13.59	-16.82
3	0.47453	10.13	37.62	33.15	47.75	43.28	56.43	46.43	-8.68	-3.15
4	0.79515	10.17	35.90	31.49	46.07	41.66	56.00	46.00	-9.93	-4.34
5	1.42857	10.23	36.35	32.28	46.58	42.51	56.00	46.00	-9.42	-3.49
6	3.80194	10.40	35.20	31.29	45.60	41.69	56.00	46.00	-10.40	-4.31

Remarks:

1. Q.P. and AV. are abbreviations of quasi-peak and average individually.
2. The emission levels of other frequencies were very low against the limit.
3. Margin value = Emission level – Limit value
4. Correction factor = Insertion loss + Cable loss
5. Emission Level = Correction Factor + Reading Value

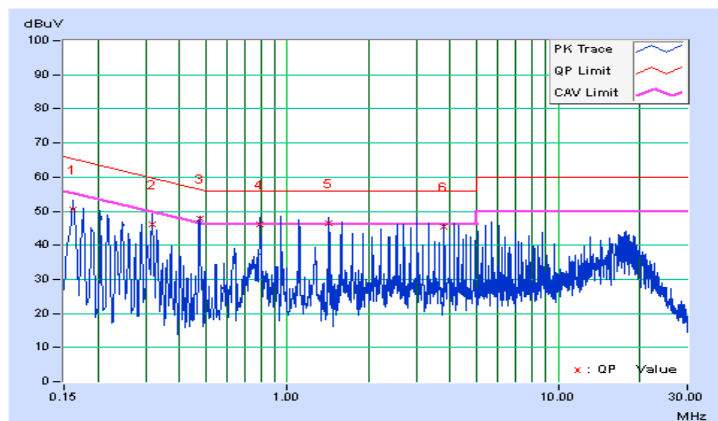

Frequency Range	150kHz ~ 30MHz	Detector Function & Resolution Bandwidth	Quasi-Peak (QP) / Average (AV), 9kHz
Input Power	120Vac, 60Hz	Environmental Conditions	25°C, 65%RH
Tested by	Toby Tian	Test Date	2016/5/28

Phase Of Power : Neutral (N)										
No	Frequency (MHz)	Correction Factor (dB)	Reading Value (dBuV)		Emission Level (dBuV)		Limit (dBuV)		Margin (dB)	
			Q.P.	AV.	Q.P.	AV.	Q.P.	AV.	Q.P.	AV.
1	0.15802	10.03	44.41	40.39	54.44	50.42	65.57	55.57	-11.13	-5.15
2	0.47537	10.14	41.14	34.74	51.28	44.88	56.42	46.42	-5.14	-1.54
3	0.79124	10.18	41.40	34.66	51.58	44.84	56.00	46.00	-4.42	-1.16
4	1.11047	10.22	41.64	34.16	51.86	44.38	56.00	46.00	-4.14	-1.62
5	2.37870	10.31	41.19	34.38	51.50	44.69	56.00	46.00	-4.50	-1.31
6	3.80585	10.42	39.97	34.14	50.39	44.56	56.00	46.00	-5.61	-1.44

Remarks:

1. Q.P. and AV. are abbreviations of quasi-peak and average individually.
2. The emission levels of other frequencies were very low against the limit.
3. Margin value = Emission level – Limit value
4. Correction factor = Insertion loss + Cable loss
5. Emission Level = Correction Factor + Reading Value

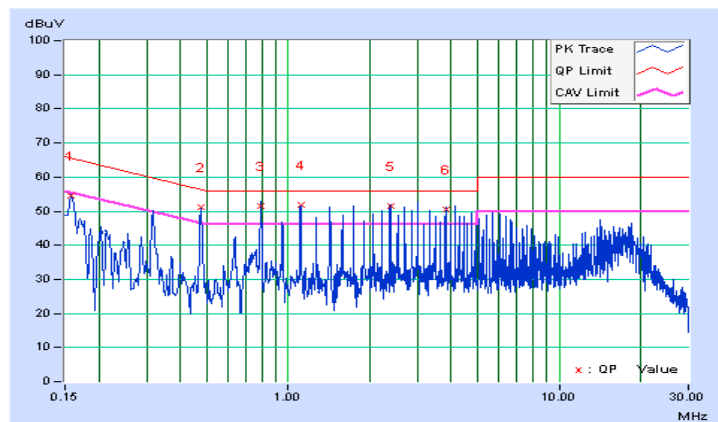

## 5 Pictures of Test Arrangements

Please refer to the attached file (Test Setup Photo).

## Appendix – Information on the Testing Laboratories

We, Bureau Veritas Consumer Products Services (H.K.) Ltd., Taoyuan Branch, were founded in 1988 to provide our best service in EMC, Radio, Telecom and Safety consultation. Our laboratories are accredited and approved according to ISO/IEC 17025.

If you have any comments, please feel free to contact us at the following:

**Linko EMC/RF Lab**

Tel: 886-2-26052180

Fax: 886-2-26051924

**Hsin Chu EMC/RF/Telecom Lab**

Tel: 886-3-6668565

Fax: 886-3-6668323

**Hwa Ya EMC/RF/Safety Lab**

Tel: 886-3-3183232

Fax: 886-3-3270892

**Email:** [service.adt@tw.bureauveritas.com](mailto:service.adt@tw.bureauveritas.com)

**Web Site:** [www.bureauveritas-adt.com](http://www.bureauveritas-adt.com)

The address and road map of all our labs can be found in our web site also.

--- END ---