

## FCC Test Report

**Report No.:** RF200122C13-2

**FCC ID:** UK7-DW11

**Test Model:** DW11M2

**Series Model:** DW11F1, DW11F2, DW11M1 (Refer to section 3.1 for more details)

**Received Date:** Jan. 22, 2020

**Test Date:** Jul. 29 ~ Aug. 03, 2020

**Issued Date:** Aug. 18, 2020

**Applicant:** Fossil Group, Inc.

**Address:** 901 S. Central Expy, Richardson, Texas, United States, 75080

**Issued By:** Bureau Veritas Consumer Products Services (H.K.) Ltd., Taoyuan Branch  
Lin Kou Laboratories

**Lab Address:** No. 47-2, 14th Ling, Chia Pau Vil., Lin Kou Dist., New Taipei City, Taiwan

**Test Location:** No.19, Hwa Ya 2nd Rd., Wen Hwa Vil., Kwei Shan Dist., Taoyuan City  
33383, Taiwan

**FCC Registration /  
Designation Number:** 788550 / TW0003



This report is for your exclusive use. Any copying or replication of this report to or for any other person or entity, or use of our name or trademark, is permitted only with our prior written permission. This report sets forth our findings solely with respect to the test samples identified herein. The results set forth in this report are not indicative or representative of the quality or characteristics of the lot from which a test sample was taken or any similar or identical product unless specifically and expressly noted. Our report includes all of the tests requested by you and the results thereof based upon the information that you provided to us. You have 60 days from date of issuance of this report to notify us of any material error or omission caused by our negligence, provided, however, that such notice shall be in writing and shall specifically address the issue you wish to raise. A failure to raise such issue within the prescribed time shall constitute your unqualified acceptance of the completeness of this report, the tests conducted and the correctness of the report contents. Unless specific mention, the uncertainty of measurement has been explicitly taken into account to declare the compliance or non-compliance to the specification.

## Table of Contents

<b>Release Control Record .....</b>	<b>3</b>
<b>1 Certificate of Conformity .....</b>	<b>4</b>
<b>2 Summary of Test Results.....</b>	<b>5</b>
2.1 Measurement Uncertainty.....	5
2.2 Modification Record .....	5
<b>3 General Information .....</b>	<b>6</b>
3.1 General Description of EUT .....	6
3.2 Description of Test Modes.....	7
3.2.1 Test Mode Applicability and Tested Channel Detail.....	7
3.3 Description of Support Units .....	9
3.3.1 Configuration of System under Test .....	9
3.4 General Description of Applied Standards and references.....	9
<b>4 Test Types and Results.....</b>	<b>10</b>
4.1 Radiated Emission Measurement.....	10
4.1.1 Limits of Radiated Emission Measurement .....	10
4.1.2 Test Instruments .....	11
4.1.3 Test Procedures.....	12
4.1.4 Deviation from Test Standard .....	12
4.1.5 Test Set Up .....	13
4.1.6 EUT Operating Conditions.....	13
4.1.7 Test Results .....	14
4.2 Conducted Emission Measurement.....	22
4.2.1 Limits of Conducted Emission Measurement .....	22
4.2.2 Test Instruments .....	22
4.2.3 Test Procedures.....	23
4.2.4 Deviation from Test Standard .....	23
4.2.5 Test Setup.....	23
4.2.6 EUT Operating Conditions.....	23
4.2.7 Test Results .....	24
4.3 Frequency Stability .....	26
4.3.1 Limits of Frequency Stability Measurement .....	26
4.3.2 Test Setup.....	26
4.3.3 Test Instruments .....	26
4.3.4 Test Procedure .....	26
4.3.5 Deviation from Test Standard .....	26
4.3.6 EUT Operating Conditions.....	26
4.3.7 Test Results .....	27
4.4 20 dB Bandwidth.....	28
4.4.1 Limits of 20 dB Bandwidth Measurement.....	28
4.4.2 Test Setup.....	28
4.4.3 Test Instruments .....	28
4.4.4 Test Procedures.....	28
4.4.5 Deviation from Test Standard .....	28
4.4.6 EUT Operating Conditions.....	28
4.4.7 Test Results .....	29
<b>5 Pictures of Test Arrangements.....</b>	<b>30</b>
<b>Appendix – Information of the Testing Laboratories .....</b>	<b>31</b>

### Release Control Record

Issue No.	Description	Date Issued
RF200122C13-2	Original Release	Aug. 18, 2020

## 1 Certificate of Conformity

**Product:** Smart Watch

**Test Model:** DW11M2

**Series Model:** DW11F1, DW11F2, DW11M1 (Refer to section 3.1 for more details)

**Sample Status:** Identical Prototype

**Applicant:** Fossil Group, Inc.

**Test Date:** Jul. 29 ~ Aug. 03, 2020

**Standards:** 47 CFR FCC Part 15, Subpart C (Section 15.225)

47 CFR FCC Part 15, Subpart C (Section 15.215)

ANSI C63.10:2013

The above equipment has been tested by **Bureau Veritas Consumer Products Services (H.K.) Ltd., Taoyuan Branch**, and found compliance with the requirement of the above standards. The test record, data evaluation & Equipment Under Test (EUT) configurations represented herein are true and accurate accounts of the measurements of the sample's RF characteristics under the conditions specified in this report.

**Prepared by :** , **Date:** Aug. 18, 2020  
Lena Wang / Specialist

**Approved by :** , **Date:** Aug. 18, 2020  
Dylan Chiou / Senior Project Engineer

## 2 Summary of Test Results

47 CFR FCC Part 15, Subpart C (Section 15.225, 15.215)			
FCC Clause	Test Item	Result	Remarks
15.207	Conducted emission test	Pass	Meet the requirement of limit. Minimum passing margin is -8.82 dB at 13.56000 MHz.
15.225 (a)	The field strength of any emissions within the band 13.553-13.567 MHz	Pass	Meet the requirement of limit. Minimum passing margin is -71.47 dB at 13.56 MHz.
15.225 (b)	The field strength of any emissions within the bands 13.410-13.553 MHz and 13.567-13.710 MHz	Pass	Meet the requirement of limit.
15.225 (c)	The field strength of any emissions within the bands 13.110-13.410 MHz and 13.710-14.010 MHz	Pass	Meet the requirement of limit.
15.225 (d)	The field strength of any emissions appearing outside of the 13.110-14.010 MHz band	Pass	Meet the requirement of limit. Minimum passing margin is -7.4 dB at 40.67 MHz.
15.225 (e)	The frequency tolerance	Pass	Meet the requirement of limit.
15.215 (c)	20 dB Bandwidth	Pass	Meet the requirement of limit.
15.203	Antenna Requirement	Pass	No antenna connector is used.

Note: Determining compliance based on the results of the compliance measurement, not taking into account measurement instrumentation uncertainty.

### 2.1 Measurement Uncertainty

Where relevant, the following measurement uncertainty levels have been estimated for tests performed on the EUT as specified in CISPR 16-4-2:

Measurement	Frequency	Expanded Uncertainty (k=2) ( $\pm$ )
Conducted Emissions at mains ports	150 kHz ~ 30 MHz	2.79 dB
Radiated Emissions up to 1 GHz	9 kHz ~ 30 MHz	3.04 dB
	30 MHz ~ 200 MHz	2.93 dB
	200 MHz ~ 1000 MHz	2.95 dB

### 2.2 Modification Record

There were no modifications required for compliance.

### 3 General Information

#### 3.1 General Description of EUT

<b>Product</b>	Smart Watch
<b>Test Model</b>	DW11M2
<b>Series Model</b>	DW11F1, DW11F2, DW11M1
<b>Model Difference</b>	Refer to Note
<b>Status of EUT</b>	Identical Prototype
<b>Power Supply Rating</b>	3.85 Vdc (Battery) 5 Vdc (adapter)
<b>Modulation Type</b>	ASK
<b>Data Rate</b>	Type A: 106 kbit/s
<b>Operating Frequency</b>	13.56 MHz
<b>Field Strength (Maximum)</b>	12.53 dBuV/m (30m)
<b>Antenna Type</b>	Loop Antenna
<b>Accessory Device</b>	Refer to Note
<b>Data Cable Supplied</b>	Refer to Note

Note:

1. All models are listed as below. DW11M2 antenna gain is maximum as a representative for the final test.

Model	WLAN/BT Antenna Gain (dBi)	Difference
DW11F1	-6.43	The models have the same layout, circuit, components, and NFC antenna but different in appearance, 2.4GHz antenna gain and brand.
DW11F2	-5.95	
DW11M1	-6.10	
DW11M2	-4.99	

2. The above Antenna information is declared by manufacturer and for more detailed features description, please refer to the manufacturer's specifications, the laboratory shall not be held responsible.
3. The EUT accessories list refers to user manual.
4. The above EUT information is declared by manufacturer and for more detailed features description, please refers to the manufacturer's specifications or user's manual.

### 3.2 Description of Test Modes

One channel was provided to this EUT:

Channel	Frequency (MHz)
1	13.56

#### 3.2.1 Test Mode Applicability and Tested Channel Detail

EUT Configure Mode	Applicable To				Description
	RE	PLC	FS	EB	
-	√	√	√	√	-

Where **RE:** Radiated Emission **PLC:** Power Line Conducted Emission  
**FS:** Frequency Stability **EB:** 20 dB Bandwidth measurement

**NOTE:** The EUT had been pre-tested on the positioned of each 3 axis, with and without tag. When positioned on **Z-plane** without tag, the worst case was found.

**NOTE:** "-" means no effect.

#### Radiated Emission Test:

- Pre-Scan has been conducted to determine the worst-case mode from all possible combinations between available modulations, data rates and antenna ports (if EUT with antenna diversity architecture).
- Following channel(s) was (were) selected for the final test as listed below.

EUT Configure Mode	Available Channel	Tested Channel	Modulation Type	Axis
-	1	1	ASK	Z

#### Power Line Conducted Emission Test:

- Pre-Scan has been conducted to determine the worst-case mode from all possible combinations between available modulations, data rates and antenna ports (if EUT with antenna diversity architecture).
- Following channel(s) was (were) selected for the final test as listed below.

EUT Configure Mode	Available Channel	Tested Channel	Modulation Type	Axis
-	1	1	ASK	Z

#### Frequency Stability:

- This item includes all test value of each mode, but only includes spectrum plot of worst value of each mode.
- Pre-Scan has been conducted to determine the worst-case mode from all possible combinations between available modulations, data rates and antenna ports (if EUT with antenna diversity architecture).
- Following channel(s) was (were) selected for the final test as listed below.

EUT Configure Mode	Available Channel	Tested Channel	Modulation Type	Axis
-	1	1	ASK	Z

**20 dB Bandwidth:**

- This item includes all test value of each mode, but only includes spectrum plot of worst value of each mode.
- Pre-Scan has been conducted to determine the worst-case mode from all possible combinations between available modulations, data rates and antenna ports (if EUT with antenna diversity architecture).
- Following channel(s) was (were) selected for the final test as listed below.

EUT Configure Mode	Available Channel	Tested Channel	Modulation Type	Axis
-	1	1	ASK	Z

**Test Condition:**

Applicable To	Environmental Conditions	Input Power	Tested By
RE	25 deg. C, 65 % RH	120 Vac, 60 Hz	Jisyong Wang
FS	25 deg. C, 65 % RH	3.85 Vdc	Jisyong Wang
PLC	25 deg. C, 65 % RH	120 Vac, 60 Hz	Jisyong Wang
EB	25 deg. C, 68 % RH	3.85 Vdc	Jisyong Wang



### 3.3 Description of Support Units

The EUT has been tested as an independent unit together with other necessary accessories or support units. The following support units or accessories were used to form a representative test configuration during the tests.

No.	Product	Brand	Model No.	Serial No.	FCC ID
A	Adapter	ASUS	AD827M	N/A	N/A
B	Charging Dock	Simula Technology Inc.	CB847D-6040-102	N/A	N/A

No.	Signal Cable Description Of The Above Support Units
1.	0.95m shielded cable

Note:

1. All power cords of the above support units are non-shielded (1.8m).

#### 3.3.1 Configuration of System under Test

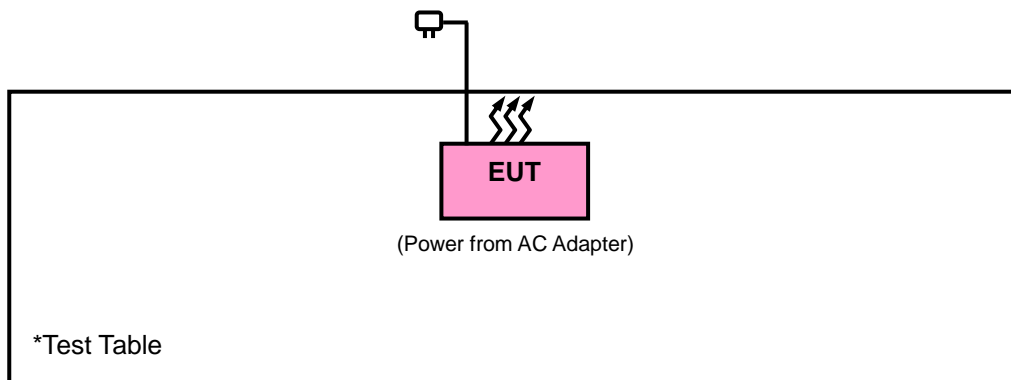

### 3.4 General Description of Applied Standards and references

The EUT is a RF Product. According to the specifications of the manufacturer, it must comply with the requirements of the following standards and references:

**FCC Part 15, Subpart C (15.225)**

**FCC Part 15, Subpart C (15.215)**

ANSI C63.10-2013

All test items have been performed and recorded as per the above standards.

References Test Guidance :

KDB 414788 D01 Radiated Test Site v01r01

All test items have been performed as a reference to the above KDB test guidance.

## 4 Test Types and Results

### 4.1 Radiated Emission Measurement

#### 4.1.1 Limits of Radiated Emission Measurement

- a. The field strength of any emissions within the band 13.553-13.567 MHz shall not exceed 15,848 microvolts/meter at 30 meters.
- b. Within the bands 13.410-13.553 MHz and 13.567-13.710 MHz, the field strength of any emissions shall not exceed 334 microvolts/meter at 30 meters.
- c. Within the bands 13.110-13.410 MHz and 13.710-14.010 MHz the field strength of any emissions shall not exceed 106 microvolts/meter at 30 meters.
- d. The field strength of any emissions appearing outside of the 13.110-14.010 MHz band shall not exceed the general radiated emission limits in §15.209 as below table:

Frequencies (MHz)	Field Strength (microvolts/meter)	Measurement Distance (meters)
0.009 ~ 0.490	2400/F (kHz)	300
0.490 ~ 1.705	24000/F (kHz)	30
1.705 ~ 30.0	30	30
30 ~ 88	100	3
88 ~ 216	150	3
216 ~ 960	200	3
Above 960	500	3

**NOTE:**

1. The lower limit shall apply at the transition frequencies.
2. Emission level (dBuV/m) = 20 log Emission level (uV/m).
3. For frequencies above 1000 MHz, the field strength limits are based on average detector, however, the peak field strength of any emission shall not exceed the maximum permitted average limits, specified above by more than 20 dB under any condition of modulation.

#### 4.1.2 Test Instruments

Description & Manufacturer	Model No.	Serial No.	Date of Calibration	Due Date of Calibration
Test Receiver Agilent	N9038A	MY51210203	Mar. 18, 2020	Mar. 17, 2021
Spectrum Analyzer Agilent	N9010A	MY52220314	Dec. 12, 2019	Dec. 11, 2020
Spectrum Analyzer ROHDE & SCHWARZ	FSU43	101261	Apr. 16, 2020	Apr. 15, 2021
Spectrum Analyzer ROHDE & SCHWARZ	FSW26	102023	Oct. 08, 2019	Oct. 07, 2020
BILOG Antenna SCHWARZBECK	VULB 9168	9168-472	Nov. 08, 2019	Nov. 07, 2020
Loop Antenna	HLA 6121	45745	Jul. 06, 2020	Jul. 05, 2021
Preamplifier EMCI	EMC001340	980201	Oct. 14, 2019	Oct. 13, 2020
Preamplifier EMCI	EMC 330H	980112	Oct. 08, 2019	Oct. 07, 2020
RF Coaxial Cable WOKEN	8D-FB	Cable-Ch10-01	Oct. 08, 2019	Oct. 07, 2020
Software BV ADT	E3 6.120103	NA	NA	NA
Antenna Tower MF	MFA-440H	NA	NA	NA
Turn Table MF	MFT-201SS	NA	NA	NA
Antenna Tower & Turn Table Controller MF	MF-7802	NA	NA	NA
Temperature & Humidity Chamber	GTH-120-40-CP-AR	MAA1306-019	Sep. 10, 2019	Sep. 09, 2020
Digital Multimeter Fluke	87-III	70360742	Jun. 23, 2020	Jun. 22, 2021
DC power supply Keysight	U8002A	MY56330015	NA	NA

Note: 1. The calibration interval of the above test instruments is 12 months and the calibrations are traceable to NML/ROC and NIST/USA.

2. The test was performed in HwaYa Chamber 10.

#### 4.1.3 Test Procedures

##### **For Radiated Emission below 30 MHz**

- a. The EUT was placed on the top of a rotating table 0.8 meters above the ground at a 3 meter chamber room. The table was rotated 360 degrees to determine the position of the highest radiation.
- b. The EUT was set 3 meters away from the interference-receiving antenna, which was mounted on the top of a variable-height antenna tower.
- c. Parallel, perpendicular, and ground-parallel orientations of the antenna are set to make the measurement.
- d. For each suspected emission, the EUT was arranged to its worst case and the rotatable table was turned from 0 degrees to 360 degrees to find the maximum reading.
- e. The test-receiver system was set to Quasi-Peak Detect Function and Specified Bandwidth with Maximum Hold Mode, except for the frequency band (9kHz-90kHz, 110Hz-490kHz) set to average detect function.

##### **Note:**

1. The resolution bandwidth and video bandwidth of test receiver/spectrum analyzer is 9 kHz at frequency below 30 MHz.
2. There is a comparison data of both open-field test site and semi-Anechoic chamber, and the result came out very similar.

##### **For Radiated Emission above 30 MHz**

- a. The EUT was placed on the top of a rotating table 0.8 meters above the ground at 3 meter chamber room for test. The table was rotated 360 degrees to determine the position of the highest radiation.
- b. The EUT was set 3 meters away from the interference-receiving antenna, which was mounted on the top of a variable-height antenna tower.
- c. The height of antenna is varied from one meter to four meters above the ground to determine the maximum value of the field strength. Both horizontal and vertical polarizations of the antenna are set to make the measurement.
- d. For each suspected emission, the EUT was arranged to its worst case and then the antenna was tuned to heights from 1 meter to 4 meters and the rotatable table was turned from 0 degrees to 360 degrees to find the maximum reading.
- e. The test-receiver system was set to quasi-peak detect function and specified bandwidth with maximum hold mode when the test frequency is below 1 GHz.
- f. The test-receiver system was set to peak and average detected function and specified bandwidth with maximum hold mode when the test frequency is above 1 GHz. If the peak reading value also meets average limit, measurement with the average detector is unnecessary.

##### **Note:**

1. The resolution bandwidth and video bandwidth of test receiver/spectrum analyzer is 120 kHz for Quasi-peak detection (QP) or Peak detection (PK) at frequency below 1 GHz.
2. All modes of operation were investigated and the worst-case emissions are reported.

#### 4.1.4 Deviation from Test Standard

No deviation.

#### 4.1.5 Test Set Up

##### <Radiated Emission below 30 MHz>

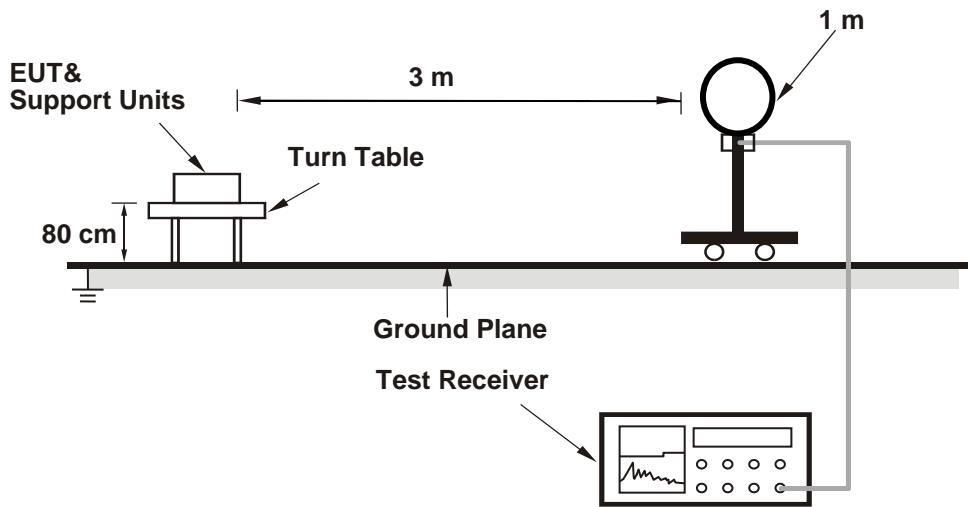

##### <Radiated Emission 30 MHz to 1 GHz>

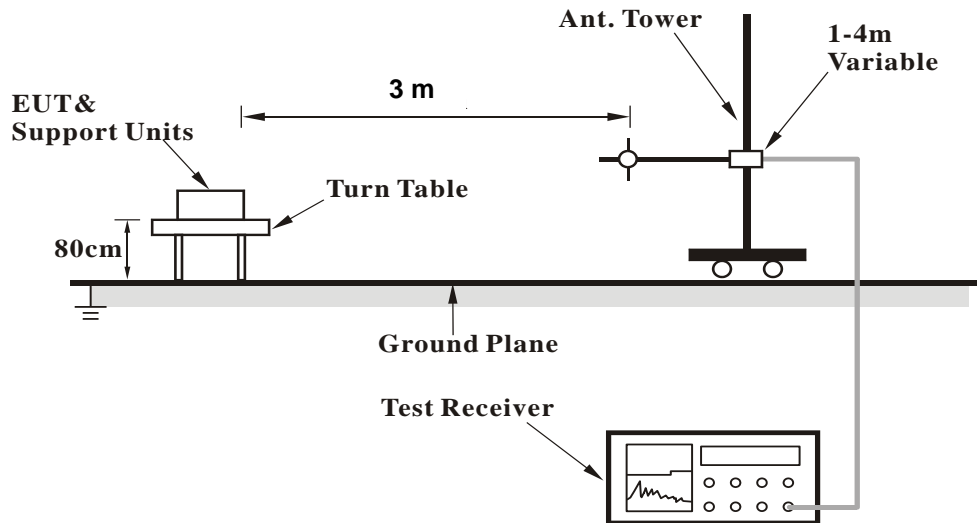

For the actual test configuration, please refer to the attached file (Test Setup Photo).

#### KDB 414788 OFS and Chamber Correlation Justification

- Base on FCC 15.31 (f) (2): measurements may be performed at a distance closer than that specified in the regulations; however, an attempt should be made to avoid making measurements in the near field.
- Open-field site and chamber correlation testing had been performed and chamber measured test result is the worst case test result.

#### 4.1.6 EUT Operating Conditions

- a. Placed the EUT on the testing table.
- b. Set the EUT under transmission condition continuously at specific channel frequency.

4.1.7 Test Results

EUT Test Condition		Measurement Detail	
Channel	Channel 1	Frequency Range	13.553 ~ 13.567 MHz
Input Power	120 Vac, 60 Hz	Detector Function	Quasi-Peak
Environmental Conditions	25 deg. C, 65 % RH	Tested By	Jisyong Wang

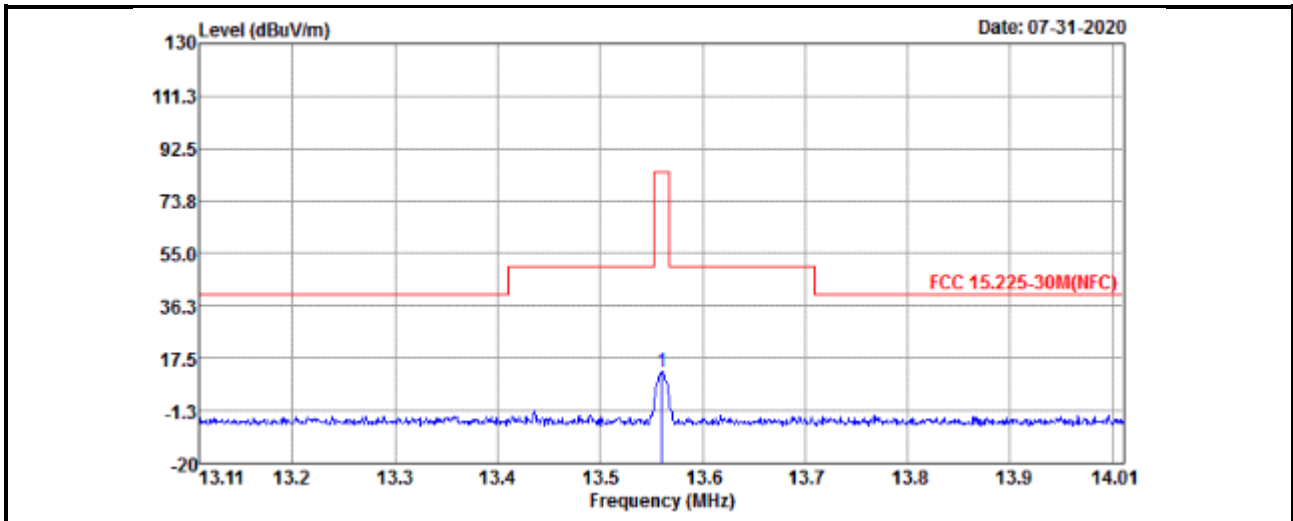

Antenna Polarity & Test Distance: Loop Antenna Parallel at 30 m								
Frequency (MHz)	Emission Level (dBuV/m)	Read Level (dBuV)	Factor (dB/m)	Limit (dBuV/m)	Margin (dB)	Antenna Height (cm)	Table Angle (Degree)	Remark
13.56	12.53	31.16	-18.63	84	-71.47	100	360	QP

Remarks:

1. Emission level (dBuV/m) = Raw Value (dBuV) + Factor (dB/m)
2. The other emission levels were very low against the limit.
3. Margin value = Emission level – Limit value.
4. Above limits have been translated by the formula
5. The factor value already contains the test distance interpolation coefficient.

The measured field strength was extrapolated to distance 30 meters, using the formula that the limit of field strength varies as the inverse distance square (40dB per decade of distance)

EUT Test Condition		Measurement Detail	
Channel	Channel 1	Frequency Range	13.553 ~ 13.567 MHz
Input Power	120 Vac, 60 Hz	Detector Function	Quasi-Peak
Environmental Conditions	25 deg. C, 65 % RH	Tested By	Jisyong Wang

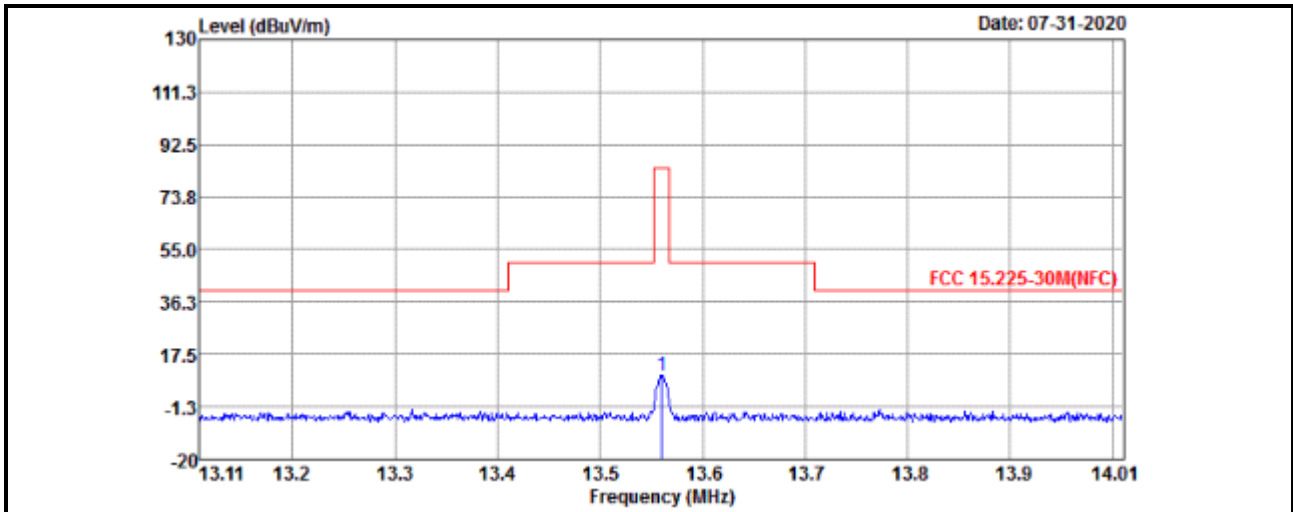

Antenna Polarity & Test Distance: Loop Antenna Perpendicular at 30 m								
Frequency (MHz)	Emission Level (dBuV/m)	Read Level (dBuV)	Factor (dB/m)	Limit (dBuV/m)	Margin (dB)	Antenna Height (cm)	Table Angle (Degree)	Remark
13.56	9.76	28.39	-18.63	84	-74.24	100	0	QP

Remarks:

1. Emission level (dBuV/m) = Raw Value (dBuV) + Factor (dB/m)
2. The other emission levels were very low against the limit.
3. Margin value = Emission level – Limit value.
4. Above limits have been translated by the formula
5. The factor value already contains the test distance interpolation coefficient.

The measured field strength was extrapolated to distance 30 meters, using the formula that the limit of field strength varies as the inverse distance square (40dB per decade of distance)

EUT Test Condition		Measurement Detail	
Channel	Channel 1	Frequency Range	13.553 ~ 13.567 MHz
Input Power	120 Vac, 60 Hz	Detector Function	Quasi-Peak
Environmental Conditions	25 deg. C, 65 % RH	Tested By	Jisyong Wang

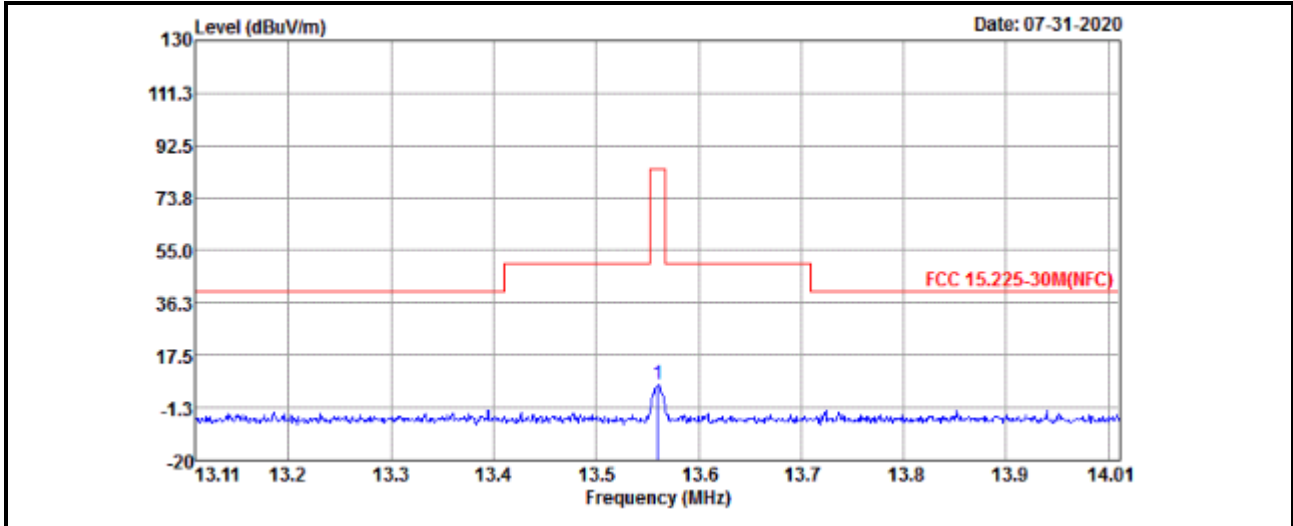

Antenna Polarity & Test Distance: Loop Antenna Ground-parallel at 30 m								
Frequency (MHz)	Emission Level (dBuV/m)	Read Level (dBuV)	Factor (dB/m)	Limit (dBuV/m)	Margin (dB)	Antenna Height (cm)	Table Angle (Degree)	Remark
13.56	6.91	25.54	-18.63	84	-77.09	100	360	QP

Remarks:

1. Emission level (dBuV/m) = Raw Value (dBuV) + Factor (dB/m)
2. The other emission levels were very low against the limit.
3. Margin value = Emission level – Limit value.
4. Above limits have been translated by the formula
5. The factor value already contains the test distance interpolation coefficient.

The measured field strength was extrapolated to distance 30 meters, using the formula that the limit of field strength varies as the inverse distance square (40dB per decade of distance)



EUT Test Condition		Measurement Detail	
Channel	Channel 1	Frequency Range	Below 30 MHz
Input Power	120 Vac, 60 Hz	Detector Function	Quasi-Peak
Environmental Conditions	25 deg. C, 65 % RH	Tested By	Jisyong Wang

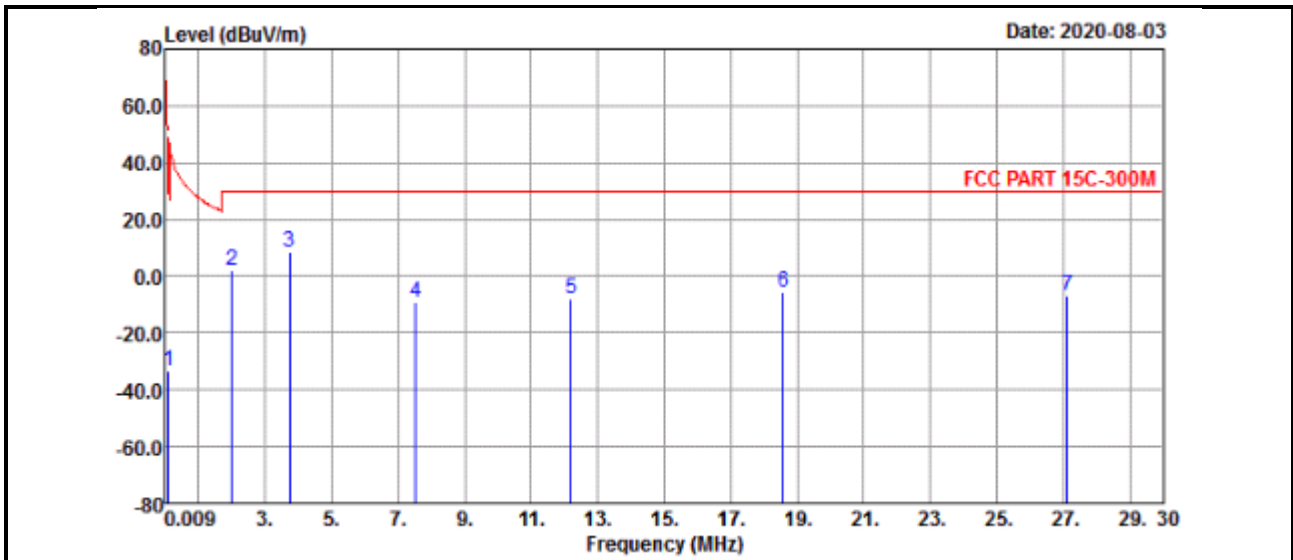

Antenna Polarity & Test Distance: Loop Antenna Parallel at 30 m or 300m (for 9kHz-490kHz)								
Frequency (MHz)	Emission Level (dBuV/m)	Read Level (dBuV)	Factor (dB/m)	Limit (dBuV/m)	Margin (dB)	Antenna Height (cm)	Table Angle (Degree)	Remark
0.09656	-33.18	27.47	-60.65	27.9	-61.08	100	211	QP
2.001	1.94	22.45	-20.51	29.54	-27.6	100	111	QP
3.732	8.79	29.15	-20.36	29.54	-20.75	100	165	QP
7.523	-9.11	10.15	-19.26	29.54	-38.65	100	132	QP
12.209	-7.78	10.91	-18.69	29.54	-37.32	100	111	QP
18.597	-5.48	12.96	-18.44	29.54	-35.02	100	102	QP
27.12	-6.55	11.7	-18.25	29.54	-36.09	100	147	QP

Remarks:

1. Emission level (dBuV/m) = Raw Value (dBuV) + Factor (dB/m)
2. The other emission levels were very low against the limit.
3. Margin value = Emission level – Limit value.
4. The factor value already contains the test distance interpolation coefficient.

The measured field strength was extrapolated to distance 30 meters, using the formula that the limit of field strength varies as the inverse distance square (40dB per decade of distance)

EUT Test Condition		Measurement Detail	
Channel	Channel 1	Frequency Range	Below 30 MHz
Input Power	120 Vac, 60 Hz	Detector Function	Quasi-Peak
Environmental Conditions	25 deg. C, 65 % RH	Tested By	Jisyong Wang

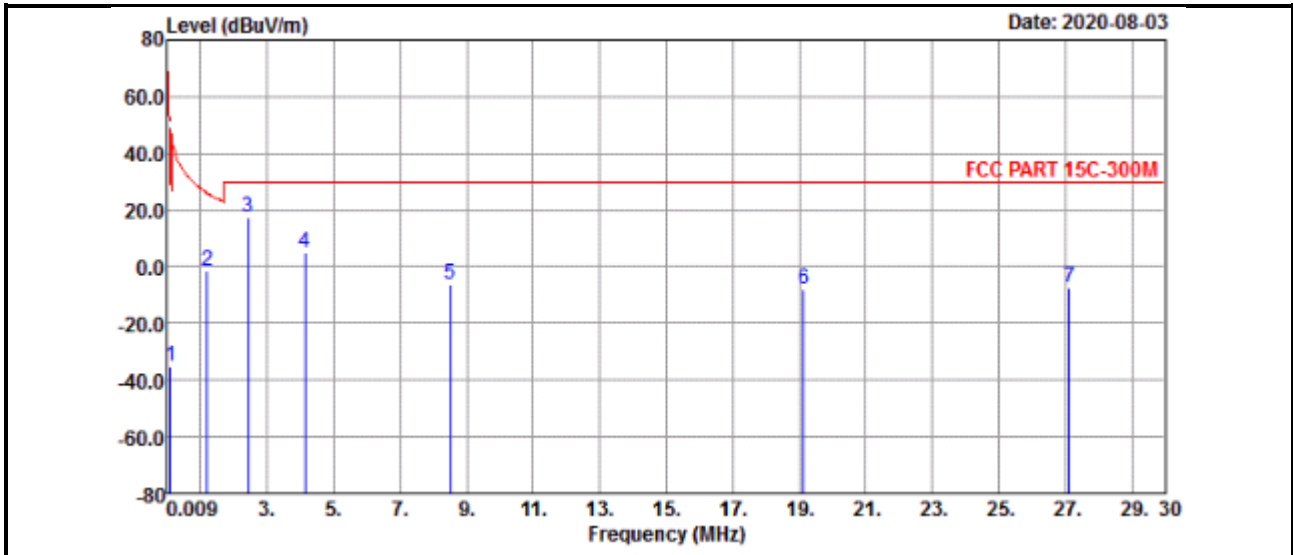

Antenna Polarity & Test Distance: Loop Antenna Perpendicular at 30 m or 300m (for 9kHz-490kHz)								
Frequency (MHz)	Emission Level (dBuV/m)	Read Level (dBuV)	Factor (dB/m)	Limit (dBuV/m)	Margin (dB)	Antenna Height (cm)	Table Angle (Degree)	Remark
0.09501	-35.25	25.38	-60.63	28.04	-63.29	100	105	QP
1.195	-1.66	18.62	-20.28	26.05	-27.71	100	145	QP
2.419	17.57	38.17	-20.6	29.54	-11.97	100	156	QP
4.15	5.15	25.34	-20.19	29.54	-24.39	100	102	QP
8.508	-5.97	13.09	-19.06	29.54	-35.51	100	197	QP
19.135	-8.1	10.32	-18.42	29.54	-37.64	100	111	QP
27.12	-7.21	11.04	-18.25	29.54	-36.75	100	146	QP

Remarks:

1. Emission level (dBuV/m) = Raw Value (dBuV) + Factor (dB/m)
2. The other emission levels were very low against the limit.
3. Margin value = Emission level – Limit value.
4. The factor value already contains the test distance interpolation coefficient.

The measured field strength was extrapolated to distance 30 meters, using the formula that the limit of field strength varies as the inverse distance square (40dB per decade of distance)

EUT Test Condition		Measurement Detail	
Channel	Channel 1	Frequency Range	Below 30 MHz
Input Power	120 Vac, 60 Hz	Detector Function	Quasi-Peak
Environmental Conditions	25 deg. C, 65 % RH	Tested By	Jisyong Wang

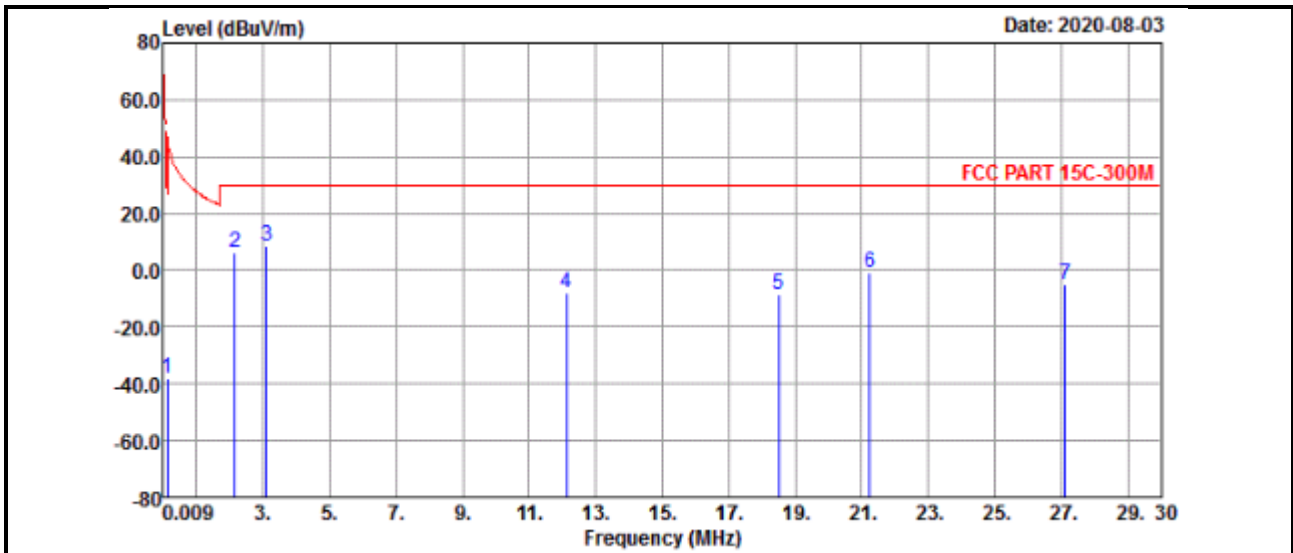

Antenna Polarity & Test Distance: Loop Antenna Ground-parallel at 30 m or 300m (for 9kHz-490kHz)								
Frequency (MHz)	Emission Level (dBuV/m)	Read Level (dBuV)	Factor (dB/m)	Limit (dBuV/m)	Margin (dB)	Antenna Height (cm)	Table Angle (Degree)	Remark
0.10742	-38.18	22.49	-60.67	26.98	-65.16	100	144	QP
2.15	6.47	27.02	-20.55	29.54	-23.07	100	145	QP
3.105	8.39	29.04	-20.65	29.54	-21.15	100	102	QP
12.12	-7.88	10.81	-18.69	29.54	-37.42	100	165	QP
18.508	-8.74	9.71	-18.45	29.54	-38.28	100	182	QP
21.254	-0.76	17.61	-18.37	29.54	-30.3	100	195	QP
27.12	-5.1	13.15	-18.25	29.54	-34.64	100	145	QP

Remarks:

1. Emission level (dBuV/m) = Raw Value (dBuV) + Factor (dB/m)
2. The other emission levels were very low against the limit.
3. Margin value = Emission level – Limit value.
4. The factor value already contains the test distance interpolation coefficient.

The measured field strength was extrapolated to distance 30 meters, using the formula that the limit of field strength varies as the inverse distance square (40dB per decade of distance)

EUT Test Condition		Measurement Detail	
Channel	Channel 1	Frequency Range	Below 1000 MHz
Input Power	120 Vac, 60 Hz	Detector Function	Quasi-Peak or Peak
Environmental Conditions	25 deg. C, 65 % RH	Tested By	Jisyong Wang

Horizontal

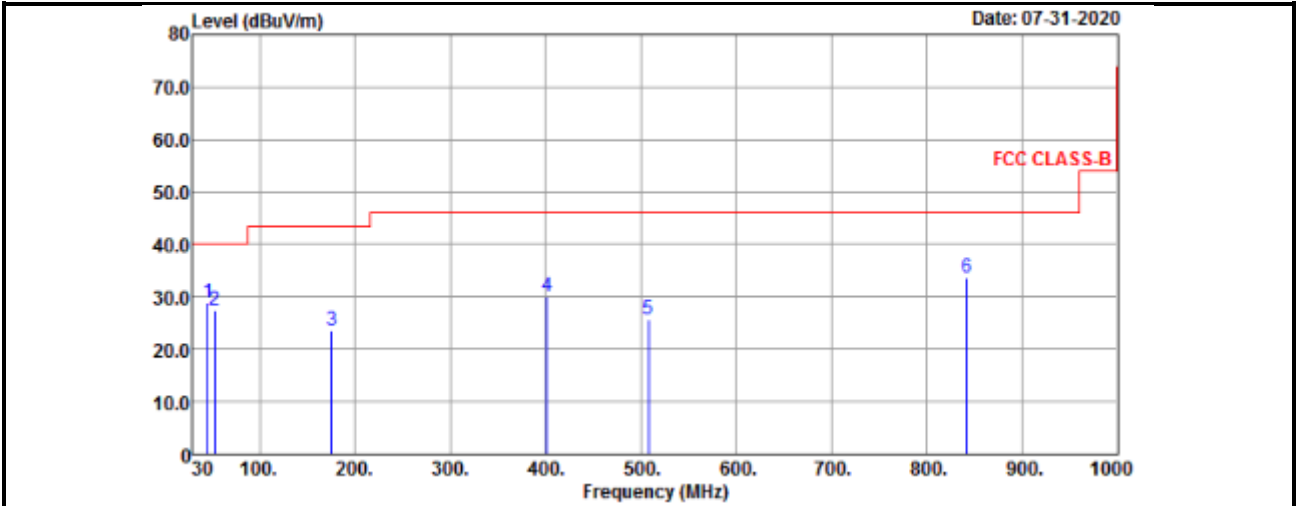

Vertical

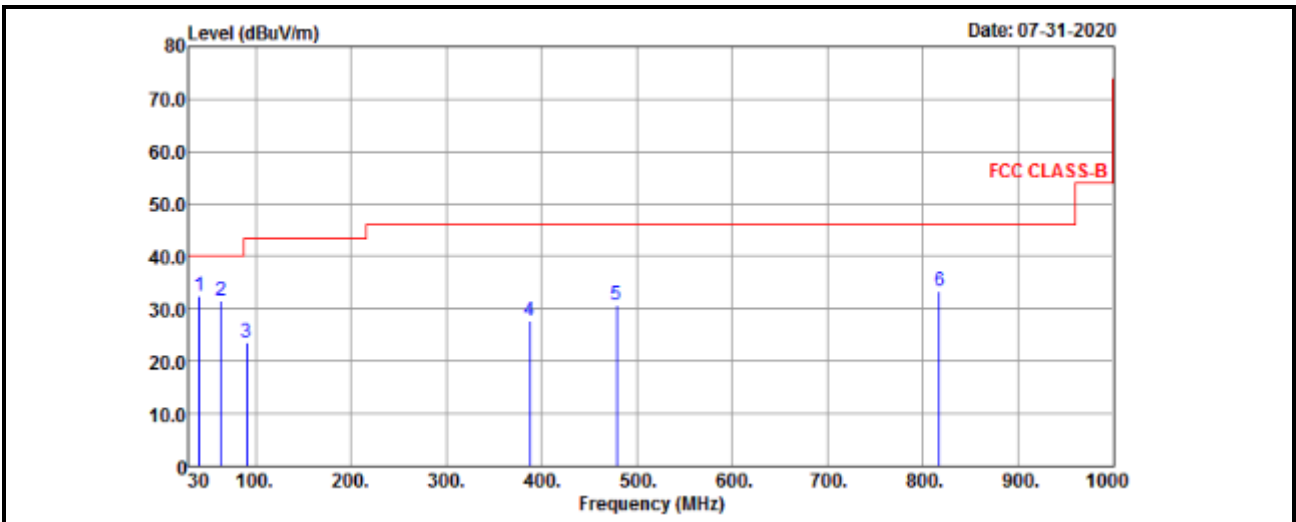

**Antenna Polarity & Test Distance: Horizontal at 3 m**

Frequency (MHz)	Emission Level (dBuV/m)	Read Level (dBuV)	Factor (dB/m)	Limit (dBuV/m)	Margin (dB)	Antenna Height (cm)	Table Angle (Degree)	Remark
45.52	28.93	40.71	-11.78	40	-11.07	145	132	QP
53.28	27.45	39.3	-11.85	40	-12.55	165	295	QP
175.5	23.72	36.56	-12.84	43.5	-19.78	147	152	QP
401.51	30.2	38.52	-8.32	46	-15.8	165	132	QP
508.21	25.69	30.98	-5.29	46	-20.31	102	214	QP
841.89	33.68	31.27	2.41	46	-12.32	152	132	QP

**Antenna Polarity & Test Distance: Vertical at 3 m**

Frequency (MHz)	Emission Level (dBuV/m)	Read Level (dBuV)	Factor (dB/m)	Limit (dBuV/m)	Margin (dB)	Antenna Height (cm)	Table Angle (Degree)	Remark
40.67	32.6	44.66	-12.06	40	-7.4	154	132	QP
63.95	31.45	44.17	-12.72	40	-8.55	165	295	QP
90.14	23.67	41.2	-17.53	43.5	-19.83	111	154	QP
387.93	27.76	36.36	-8.6	46	-18.24	102	231	QP
479.11	30.74	36.57	-5.83	46	-15.26	145	152	QP
817.64	33.5	31.39	2.11	46	-12.5	174	152	QP

Remarks:

1. Emission Level = Read Level + Factor
2. Margin value = Emission level – Limit value.
3. The other emission levels were very low against the limit.
4. Correction Factor(dB/m) = Antenna Factor(dB/m) + Cable Factor(dB)  
– Pre-Amplifier Factor (dB)

## 4.2 Conducted Emission Measurement

### 4.2.1 Limits of Conducted Emission Measurement

Frequency (MHz)	Conducted Limit (dBuV)	
	Quasi-Peak	Average
0.15 - 0.5	66 - 56	56 - 46
0.50 - 5.0	56	46
5.0 - 30.0	60	50

Note:

1. The lower limit shall apply at the transition frequencies.
2. The limit decreases in line with the logarithm of the frequency in the range of 0.15 to 0.50 MHz.
3. All emanations from a class A/B digital device or system, including any network of conductors and apparatus connected thereto, shall not exceed the level of field strengths specified above.

### 4.2.2 Test Instruments

Description & Manufacturer	Model No.	Serial No.	Date of Calibration	Due Date of Calibration
Test Receiver ROHDE & SCHWARZ	ESR3	102412	Feb. 17, 2020	Feb. 16, 2021
RF signal cable (with 10dB PAD) Woken	5D-FB	Cable-cond2-01	Sep. 05, 2019	Sep. 04, 2020
LISN ROHDE & SCHWARZ (EUT)	ESH2-Z5	100100	Jan. 20, 2020	Jan. 19, 2021
LISN ROHDE & SCHWARZ (Peripheral)	ESH3-Z5	100312	Aug. 13, 2019	Aug. 12, 2020
Software ADT	BV ADT_Cond_ V7.3.7.4	NA	NA	NA

- Note: 1. The calibration interval of the above test instruments is 12 months and the calibrations are traceable to NML/ROC and NIST/USA.
2. The test was performed in HwaYa Shielded Room 2 (Conduction 2).
  3. The VCCI Site Registration No. is C-12047.

#### 4.2.3 Test Procedures

- a. The EUT was placed 0.4 meters from the conducting wall of the shielded room with EUT being connected to the power mains through a line impedance stabilization network (LISN). Other support units were connected to the power mains through another LISN. The two LISNs provide 50 ohm/50 uH of coupling impedance for the measuring instrument.
- b. Both lines of the power mains connected to the EUT were checked for maximum conducted interference.
- c. The frequency range from 150 kHz to 30 MHz was searched. Emission levels under (Limit – 20 dB) was not recorded.

**Note:** The resolution bandwidth and video bandwidth of test receiver is 9 kHz for quasi-peak detection (QP) and average detection (AV) at frequency 0.15 MHz - 30 MHz.

#### 4.2.4 Deviation from Test Standard

No deviation.

#### 4.2.5 Test Setup

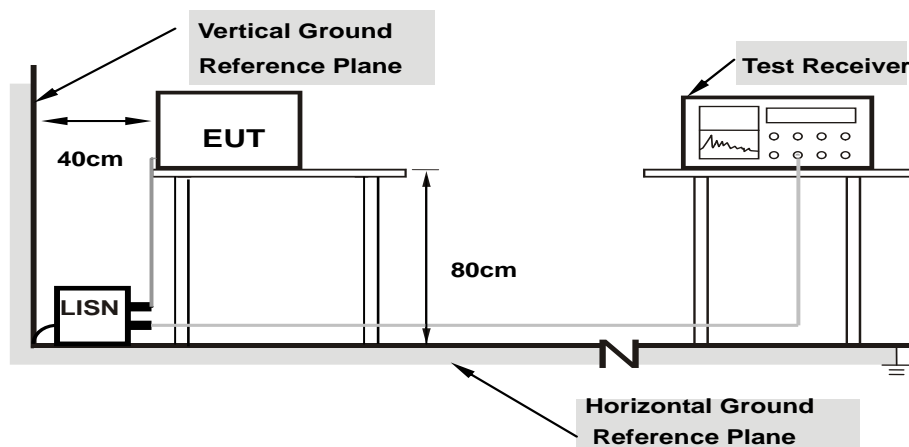

- Note:**
1. Support units were connected to second LISN.
  2. Both of LISNs (AMN) are 80 cm from EUT and at least 80 cm from other units and other metal planes

For the actual test configuration, please refer to the attached file (Test Setup Photo).

#### 4.2.6 EUT Operating Conditions

- a. Placed the EUT on the testing table.
- b. Set the EUT under transmission condition continuously at specific channel frequency.

#### 4.2.7 Test Results

Frequency Range	150kHz ~ 30MHz	Detector Function & Resolution Bandwidth	Quasi-Peak (QP) / Average (AV), 9kHz
Input Power	120Vac, 60Hz	Environmental Conditions	25°C, 65%RH
Tested by	Jisyong Wang	Test Date	2020/7/29

Phase Of Power : Line (L)										
No	Frequency (MHz)	Correction Factor (dB)	Reading Value (dBuV)		Emission Level (dBuV)		Limit (dBuV)		Margin (dB)	
			Q.P.	AV.	Q.P.	AV.	Q.P.	AV.	Q.P.	AV.
1	0.16575	10.16	31.04	26.02	41.20	36.18	65.17	55.17	-23.97	-18.99
2	0.20625	10.17	24.48	17.92	34.65	28.09	63.35	53.35	-28.70	-25.26
3	0.27150	10.18	20.18	16.42	30.36	26.60	61.07	51.07	-30.71	-24.47
4	0.45304	10.21	19.23	12.63	29.44	22.84	56.82	46.82	-27.38	-23.98
5	3.33150	10.36	11.90	8.15	22.26	18.51	56.00	46.00	-33.74	-27.49
6	13.56000	10.51	32.52	30.35	43.03	40.86	60.00	50.00	-16.97	-9.14

Remarks:

1. Q.P. and AV. are abbreviations of quasi-peak and average individually.
2. The emission levels of other frequencies were very low against the limit.
3. Margin value = Emission level – Limit value
4. Correction factor = Insertion loss + Cable loss
5. Emission Level = Correction Factor + Reading Value

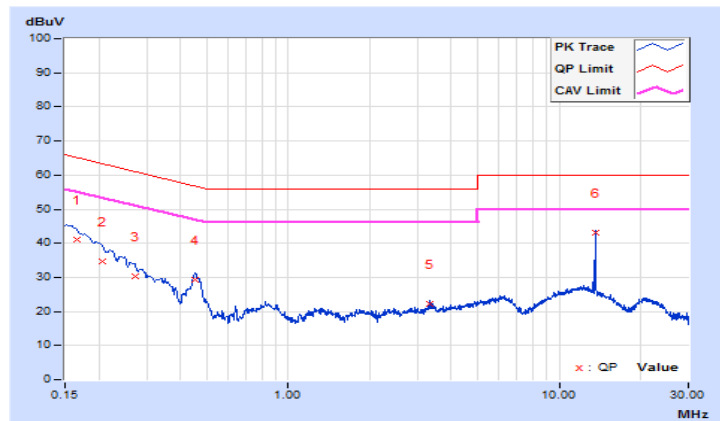



Frequency Range	150kHz ~ 30MHz	Detector Function & Resolution Bandwidth	Quasi-Peak (QP) / Average (AV), 9kHz
Input Power	120Vac, 60Hz	Environmental Conditions	25°C, 65%RH
Tested by	Jisyong Wang	Test Date	2020/7/29

Phase Of Power : Neutral (N)										
No	Frequency (MHz)	Correction Factor (dB)	Reading Value (dBuV)		Emission Level (dBuV)		Limit (dBuV)		Margin (dB)	
			Q.P.	AV.	Q.P.	AV.	Q.P.	AV.	Q.P.	AV.
1	0.16307	10.12	30.23	25.01	40.35	35.13	65.31	55.31	-24.96	-20.18
2	0.18364	10.13	28.31	22.32	38.44	32.45	64.32	54.32	-25.88	-21.87
3	0.46271	10.19	15.09	9.01	25.28	19.20	56.64	46.64	-31.36	-27.44
4	1.24800	10.25	11.62	6.45	21.87	16.70	56.00	46.00	-34.13	-29.30
5	6.42975	10.46	13.79	8.66	24.25	19.12	60.00	50.00	-35.75	-30.88
<b>6</b>	<b>13.56000</b>	<b>10.64</b>	<b>32.65</b>	<b>30.54</b>	<b>43.29</b>	<b>41.18</b>	<b>60.00</b>	<b>50.00</b>	<b>-16.71</b>	<b>-8.82</b>

Remarks:

1. Q.P. and AV. are abbreviations of quasi-peak and average individually.
2. The emission levels of other frequencies were very low against the limit.
3. Margin value = Emission level – Limit value
4. Correction factor = Insertion loss + Cable loss
5. Emission Level = Correction Factor + Reading Value

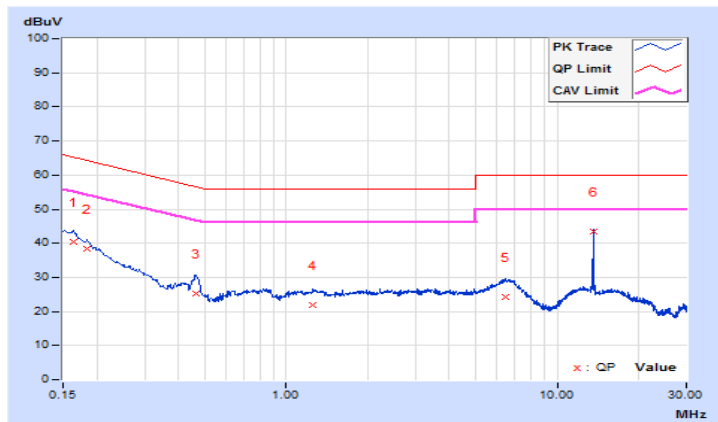

### 4.3 Frequency Stability

#### 4.3.1 Limits of Frequency Stability Measurement

The frequency tolerance of the carrier signal shall be maintained within +/- 0.01 % of the operating frequency over a temperature variation of -20 degrees to 50 degrees C at normal supply voltage, and for a variation in the primary supply voltage from 85 % to 115 % of the rated supply voltage at a temperature of 20 degrees C.

#### 4.3.2 Test Setup

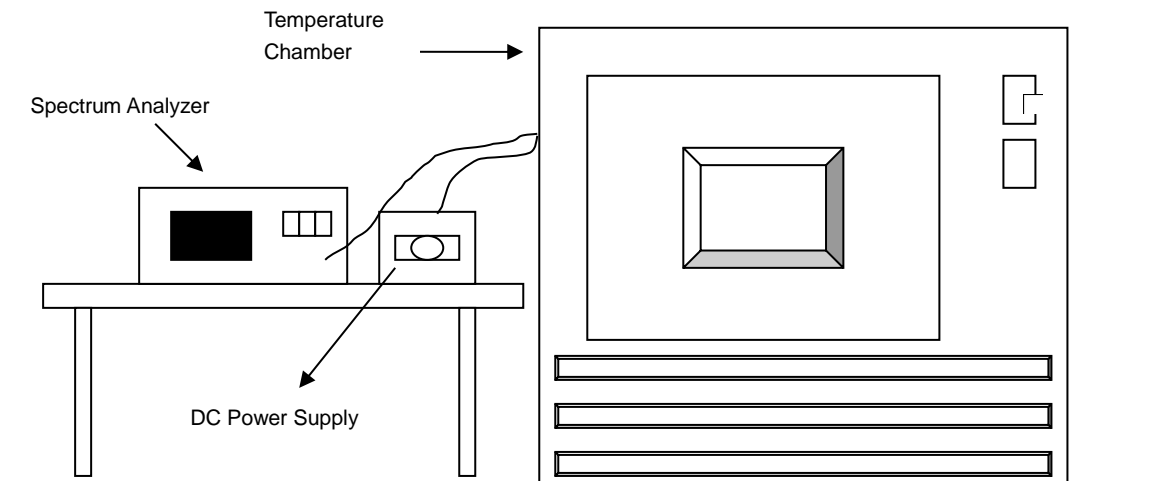

#### 4.3.3 Test Instruments

Refer to section 4.1.2 to get information of above instrument.

#### 4.3.4 Test Procedure

- The EUT was placed inside the environmental test chamber and powered by nominal DC voltage.
- Turned the EUT on and coupled its output to a spectrum analyzer.
- Turned the EUT off and set the chamber to the highest temperature specified.
- Allowed sufficient time (approximately 30 min) for the temperature of the chamber to stabilize then turned the EUT on and measured the operating frequency after 2, 5, and 10 minutes.
- Repeated step c and d with the every 10 degrees reduction until the lowest temperature achieved.
- The test chamber was allowed to stabilize at +20 degree C for a minimum of 30 minutes. The supply voltage was then adjusted on the EUT from 85 % to 115 % and the frequency record.

#### 4.3.5 Deviation from Test Standard

No deviation.

#### 4.3.6 EUT Operating Conditions

- Placed the EUT on the testing table.
- Set the EUT under transmission condition continuously at specific channel frequency.

4.3.7 Test Results

Frequency Stability Versus Temperature									
Temp. (°C)	Power Supply (Vdc)	0 Minute		2 Minute		5 Minute		10 Minute	
		Measured Frequency	Frequency Drift	Measured Frequency	Frequency Drift	Measured Frequency	Frequency Drift	Measured Frequency	Frequency Drift
		(MHz)	%	(MHz)	%	(MHz)	%	(MHz)	%
50	5	13.56004	0.00029	13.56004	0.00029	13.56004	0.00029	13.56004	0.00029
40	5	13.56001	0.00007	13.56001	0.00007	13.56001	0.00007	13.56001	0.00007
30	5	13.55994	-0.00044	13.55994	-0.00044	13.55994	-0.00044	13.55994	-0.00044
20	5	13.55998	-0.00015	13.55998	-0.00015	13.55998	-0.00015	13.55999	-0.00007
10	5	13.55999	-0.00007	13.55998	-0.00015	13.55998	-0.00015	13.55999	-0.00007
0	5	13.55995	-0.00037	13.55995	-0.00037	13.55995	-0.00037	13.55996	-0.00029
-10	5	13.56005	0.00037	13.56005	0.00037	13.56005	0.00037	13.56005	0.00037
-20	5	13.55995	-0.00037	13.55995	-0.00037	13.55994	-0.00044	13.55995	-0.00037

Frequency Stability Versus Voltage									
Temp. (°C)	Power Supply (Vdc)	0 Minute		2 Minute		5 Minute		10 Minute	
		Measured Frequency	Frequency Drift	Measured Frequency	Frequency Drift	Measured Frequency	Frequency Drift	Measured Frequency	Frequency Drift
		(MHz)	%	(MHz)	%	(MHz)	%	(MHz)	%
20	5.75	13.55998	-0.00015	13.55998	-0.00015	13.55998	-0.00015	13.55999	-0.00007
	5	13.55998	-0.00015	13.55998	-0.00015	13.55998	-0.00015	13.55999	-0.00007
	4.25	13.55998	-0.00015	13.55998	-0.00015	13.55998	-0.00015	13.55999	-0.00007

#### 4.4 20 dB Bandwidth

##### 4.4.1 Limits of 20 dB Bandwidth Measurement

The 20 dB bandwidth shall be specified in operating frequency band.

##### 4.4.2 Test Setup

Refer to section 4.1.5.

##### 4.4.3 Test Instruments

Refer to section 4.1.2 to get information of above instrument.

##### 4.4.4 Test Procedures

The bandwidth of the fundamental frequency was measured by spectrum analyzer with 1 kHz RBW and 3 kHz VBW. The 20 dB bandwidth is defined as the total spectrum the power of which is higher than peak power minus 20 dB.

##### 4.4.5 Deviation from Test Standard

No deviation.

Note: The signal look like CW signal, so RBW can't be match 1~5 % OBW.

##### 4.4.6 EUT Operating Conditions

- a. Placed the EUT on the testing table.
- b. Set the EUT under transmission condition continuously at specific channel frequency.

4.4.7 Test Results

20 dBc Point (Low)	20 dBc Point (High)	Operating Frequency Band (MHz)	20 dBc Bandwidth (kHz)	Pass / Fail
13.558397436	13.560961538	13.553~13.567	2.564102	Pass

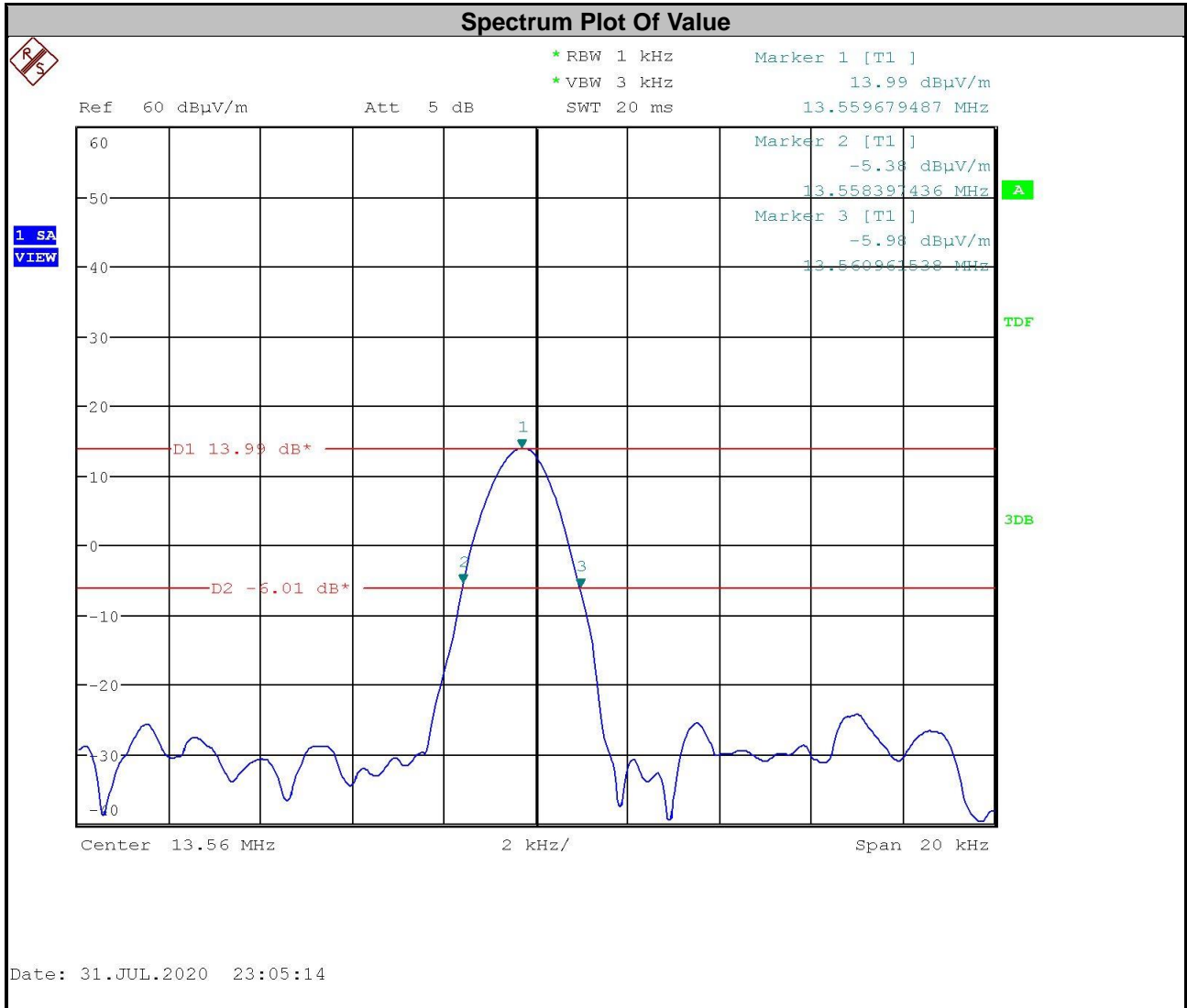

## 5 Pictures of Test Arrangements

Please refer to the attached file (Test Setup Photo).

## Appendix – Information of the Testing Laboratories

We, Bureau Veritas Consumer Products Services (H.K.) Ltd., Taoyuan Branch, were founded in 1988 to provide our best service in EMC, Radio, Telecom and Safety consultation. Our laboratories are FCC recognized accredited test firms and accredited according to ISO/IEC 17025.

If you have any comments, please feel free to contact us at the following:

**Lin Kou EMC/RF Lab**

Tel: 886-2-26052180

Fax: 886-2-26051924

**Hsin Chu EMC/RF/Telecom Lab**

Tel: 886-3-6668565

Fax: 886-3-6668323

**Hwa Ya EMC/RF/Safety Lab**

Tel: 886-3-3183232

Fax: 886-3-3270892

**Email:** [service.adt@tw.bureauveritas.com](mailto:service.adt@tw.bureauveritas.com)

**Web Site:** [www.bureauveritas-adt.com](http://www.bureauveritas-adt.com)

The address and road map of all our labs can be found in our web site also.

--- END ---