

Variant FCC Test Report

Report No.: RF190226C07A-2

FCC ID: UK7-DW10

Test Model: DW10E2

Series Model: DW10F1, DW10F2, DW10M1, DW10M2, DW10M3, DW10E1, DW10D1, DW10S1 (Refer to section 3.1 for more details)

Received Date: Sep. 23, 2019

Test Date: Sep. 26, 2019 ~ Oct. 13, 2019

Issued Date: Oct. 16, 2019

Applicant: Fossil Group, Inc.

Address: 901 S. Central Expressway, Richardson, TX 75080, USA

Issued By: Bureau Veritas Consumer Products Services (H.K.) Ltd., Taoyuan Branch
Lin Kou Laboratories

Lab Address: No. 47-2, 14th Ling, Chia Pau Vil., Lin Kou Dist., New Taipei City, Taiwan

Test Location (1): No.19, Hwa Ya 2nd Rd., Wen Hwa Vil., Kwei Shan Dist., Taoyuan City
33383, Taiwan

Test Location (2): B2F., No.215, Sec. 3, Beixin Rd., Xindian Dist., New Taipei City 231, Taiwan

FCC Registration / 427177 / TW0011

Designation Number: 788550 / TW0003



This report is for your exclusive use. Any copying or replication of this report to or for any other person or entity, or use of our name or trademark, is permitted only with our prior written permission. This report sets forth our findings solely with respect to the test samples identified herein. The results set forth in this report are not indicative or representative of the quality or characteristics of the lot from which a test sample was taken or any similar or identical product unless specifically and expressly noted. Our report includes all of the tests requested by you and the results thereof based upon the information that you provided to us. You have 60 days from date of issuance of this report to notify us of any material error or omission caused by our negligence, provided, however, that such notice shall be in writing and shall specifically address the issue you wish to raise. A failure to raise such issue within the prescribed time shall constitute your unqualified acceptance of the completeness of this report, the tests conducted and the correctness of the report contents. Unless specific mention, the uncertainty of measurement has been explicitly taken into account to declare the compliance or non-compliance to the specification. The report must not be used by the client to claim product certification, approval, or endorsement by TAF or any government agencies.

Table of Contents

Release Control Record	4
1 Certificate of Conformity	5
2 Summary of Test Results	6
2.1 Measurement Uncertainty.....	7
2.2 Modification Record	7
3 General Information	8
3.1 General Description of EUT	8
3.2 Description of Test Modes.....	10
3.2.1 Test Mode Applicability and Tested Channel Detail.....	11
3.3 Description of Support Units	14
3.3.1 Configuration of System under Test	14
3.4 General Description of Applied Standards.....	14
4 Test Types and Results	15
<Bluetooth LE>	15
4.1 Radiated Emission and Bandedge Measurement	15
4.1.1 Limits of Radiated Emission and Bandedge Measurement	15
4.1.2 Test Instruments	16
4.1.3 Test Procedures.....	17
4.1.4 Deviation from Test Standard	17
4.1.5 Test Set Up	18
4.1.6 EUT Operating Conditions.....	19
4.1.7 Test Results	20
4.2 Conducted Emission Measurement.....	28
4.2.1 Limits of Conducted Emission Measurement	28
4.2.2 Test Instruments	28
4.2.3 Test Procedures.....	28
4.2.4 Deviation from Test Standard	29
4.2.5 Test Setup.....	29
4.2.6 EUT Operating Conditions.....	29
4.2.7 Test Results	30
4.3 Conducted Output Power Measurement	32
4.3.1 Limits of Conducted Output Power Measurement.....	32
4.3.2 Test Setup.....	32
4.3.3 Test Instruments	32
4.3.4 Test Procedures.....	32
4.3.5 Deviation from Test Standard	32
4.3.6 EUT Operating Conditions.....	32
4.3.7 Test Results	32
<WLAN>	33
4.4 Radiated Emission and Bandedge Measurement	33
4.4.1 Limits of Radiated Emission and Bandedge Measurement	33
4.4.2 Test Instruments	33
4.4.3 Test Procedures.....	34
4.4.4 Deviation from Test Standard	35
4.4.5 Test Set Up	35
4.4.6 EUT Operating Conditions.....	36
4.4.7 Test Results	37
4.5 Conducted Emission Measurement.....	69
4.5.1 Limits of Conducted Emission Measurement	69
4.5.2 Test Instruments	69
4.5.3 Test Procedures.....	70
4.5.4 Deviation from Test Standard	70
4.5.5 Test Setup.....	70

4.5.6 EUT Operating Conditions.....	70
4.5.7 Test Results	71
4.6 Conducted Output Power Measurement	73
4.6.1 Limits of Conducted Output Power Measurement.....	73
4.6.2 Test Setup.....	73
4.6.3 Test Instruments	73
4.6.4 Test Procedures.....	73
4.6.5 Deviation from Test Standard	73
4.6.6 EUT Operating Conditions.....	73
4.6.7 Test Results	74
5 Pictures of Test Arrangements.....	75
Annex A- Band-edge measurement	76
Appendix – Information of the Testing Laboratories	90

Release Control Record

Issue No.	Description	Date Issued
RF190226C07A-2	Original Release	Oct. 16, 2019

1 Certificate of Conformity

Product: Smart Watch

Test Model: DW10E2

Series Model: DW10F1, DW10F2, DW10M1, DW10M2, DW10M3, DW10E1, DW10D1, DW10S1
(Refer to section 3.1 for more details)

Sample Status: Identical Prototype

Applicant: Fossil Group, Inc.

Test Date: Sep. 26, 2019 ~ Oct. 13, 2019

Standards: 47 CFR FCC Part 15, Subpart C (Section 15.247)
ANSI C63.10:2013

This report is issued as a supplementary report to BV CPS report no.: RF190226C07-2 R1. This report shall be used by combining with its original report.

Prepared by : Rona Chen, **Date:** Oct. 16, 2019
Rona Chen / Specialist

Approved by : Dylan Chiou, **Date:** Oct. 16, 2019
Dylan Chiou / Project Engineer

2 Summary of Test Results

<Bluetooth LE>

47 CFR FCC Part 15, Subpart C (Section 15.247)			
FCC Clause	Test Item	Result	Remarks
15.207	AC Power Conducted Emission	Pass	Meet the requirement of limit. Minimum passing margin is -21.06 dB at 0.15802 MHz.
15.205 & 209	Radiated Emissions	Pass	Meet the requirement of limit. Minimum passing margin is -11.43 dB at 4804 MHz.
15.247(d)	Band Edge Measurement	N/A	Refer to Note
15.247(d)	Antenna Port Emission	N/A	Refer to Note
15.247(a)(2)	6 dB Bandwidth	N/A	Refer to Note
---	Occupied Bandwidth Measurement	N/A	Refer to Note
15.247(b)	Conducted Power	Pass	Meet the requirement of limit.
15.247(e)	Power Spectral Density	N/A	Refer to Note
15.203	Antenna Requirement	Pass	No antenna connector is used.

Note:

1. Only AC Power Conducted Emission, Conducted Power, and Radiated Emissions tests were performed for this addendum. Refer to original report for other test data.
2. Determining compliance based on the results of the compliance measurement, not taking into account measurement instrumentation uncertainty.

<WLAN>

47 CFR FCC Part 15, Subpart C (Section 15.247)			
FCC Clause	Test Item	Result	Remarks
15.207	AC Power Conducted Emission	Pass	Meet the requirement of limit. Minimum passing margin is -21.61 dB at 0.17737 MHz.
15.205 / 15.209 / 15.247(d)	Radiated Emissions and Band Edge Measurement	Pass	Meet the requirement of limit. Minimum passing margin is -0.34 dB at 2483.52 MHz.
15.247(d)	Antenna Port Emission	N/A	Refer to Note
15.247(a)(2)	6 dB Bandwidth	N/A	Refer to Note
---	Occupied Bandwidth Measurement	N/A	Refer to Note
15.247(b)	Conducted power	Pass	Meet the requirement of limit.
15.247(e)	Power Spectral Density	N/A	Refer to Note
15.203	Antenna Requirement	N/A	Refer to Note

Note:

1. Only AC Power Conducted Emission, Conducted Power, and Radiated Emissions tests were performed for this addendum. Refer to original report for other test data.
2. Determining compliance based on the results of the compliance measurement, not taking into account measurement instrumentation uncertainty.

2.1 Measurement Uncertainty

Where relevant, the following measurement uncertainty levels have been estimated for tests performed on the EUT as specified in CISPR 16-4-2:

Measurement	Frequency	Expanded Uncertainty (k=2) (±)
Conducted Emissions at mains ports	150 kHz ~ 30 MHz	2.94 dB
Radiated Emissions up to 1 GHz	9 kHz ~ 30 MHz	3.04 dB
	30 MHz ~ 200 MHz	2.0153 dB
	200 MHz ~ 1000 MHz	2.0224 dB
Radiated Emissions above 1 GHz	1 GHz ~ 18 GHz	1.0121 dB
	18 GHz ~ 40 GHz	1.1508 dB

2.2 Modification Record

There were no modifications required for compliance.

3 General Information

3.1 General Description of EUT

Product	Smart Watch	
Test Model	DW10E2	
Series Model	DW10F1, DW10F2, DW10M1, DW10M2, DW10M3, DW10E1, DW10D1, DW10S1	
Status of EUT	Identical Prototype	
Power Supply Rating	5.0 Vdc (Host equipment or Adapter) 3.85 Vdc (Battery)	
Modulation Type	Bluetooth LE	GFSK
	WLAN	CCK, DQPSK, DBPSK for DSSS 64QAM, 16QAM, QPSK, BPSK for OFDM
Transfer Rate	Bluetooth LE	1 Mbps
	WLAN	802.11b: 11.0 / 5.5 / 2.0 / 1.0 Mbps 802.11g: 54.0 / 48.0 / 36.0 / 24.0 / 18.0 / 12.0 / 9.0 / 6.0 Mbps 802.11n: up to 72.2 Mbps
Operating Frequency	Bluetooth LE	2402 ~ 2480 MHz
	WLAN	2412 ~ 2472 MHz
Number of Channel	Bluetooth LE	40
	WLAN	13 for 802.11b, 802.11g, 802.11n (HT20)
Output Power	Bluetooth LE	1.816 mW
	WLAN	82.604 mW
Antenna Type	Loop antenna	
Antenna Connector	N/A	
Accessory Device	Refer to Note as below	
Data Cable Supplied	Refer to Note as below	

Note:

1. This report is issued as a supplementary report to BV CPS report no: RF190226C07-2 R1. The difference compared with original report is adding models (DW10F2, DW10M3, DW10E2, DW10S1) with different appearance and antenna. Therefore, only AC Power Conducted Emission, Conducted Power, and Radiated Emissions tests were re-tested.
2. All models are listed as below (New model is marked in blue). Model: DW10E2 antenna gain is maximum as a representative for the final test.

Sample	Model	Antenna Gain (dBi)		Description
		WLAN / BT	GPS	
A	DW10F1	-7.45	-6.48	The models have the same layout, circuit, and components, but different in appearance and antenna.
H	DW10F2	-6.11	-3.68	
B	DW10M1	-8.00	-6.36	
C	DW10M2	-6.21	-5.17	
G	DW10M3	-6.86	-4.87	
D	DW10E1	-6.80	-5.47	
I	DW10E2	-5.50	-4.76	
E	DW10D1	-7.15	-5.61	
F	DW10S1	-5.55	-4.78	

3. The EUT provides one completed transmitter and one receiver.

Modulation Mode	Tx Function
802.11b	1TX
802.11g	1TX
802.11n (HT20)	1TX

4. The EUT's accessories list refers to user manual.

5. The above EUT information is declared by manufacturer and for more detailed features description, please refers to the manufacturer's specifications or User's Manual.

3.2 Description of Test Modes

<Bluetooth LE>

40 channels are provided to this EUT:

Channel	Freq. (MHz)	Channel	Freq. (MHz)	Channel	Freq. (MHz)	Channel	Freq. (MHz)
0	2402	10	2422	20	2442	30	2462
1	2404	11	2424	21	2444	31	2464
2	2406	12	2426	22	2446	32	2466
3	2408	13	2428	23	2448	33	2468
4	2410	14	2430	24	2450	34	2470
5	2412	15	2432	25	2452	35	2472
6	2414	16	2434	26	2454	36	2474
7	2416	17	2436	27	2456	37	2476
8	2418	18	2438	28	2458	38	2478
9	2420	19	2440	29	2460	39	2480

<WLAN>

13 channels are provided for 802.11b, 802.11g and 802.11n (HT20):

Channel	Frequency (MHz)	Channel	Frequency (MHz)
1	2412	8	2447
2	2417	9	2452
3	2422	10	2457
4	2427	11	2462
5	2432	12	2467
6	2437	13	2472
7	2442		

3.2.1 Test Mode Applicability and Tested Channel Detail

<Bluetooth LE>

EUT Configure Mode	Applicable To				Description
	RE \geq 1G	RE $<$ 1G	PLC	APCM	
-	√	√	√	√	-

Where **RE \geq 1G**: Radiated Emission above 1 GHz **RE $<$ 1G**: Radiated Emission below 1 GHz
PLC: Power Line Conducted Emission **APCM**: Antenna Port Conducted Measurement

Note:

1. The EUT had been pre-tested on the positioned of each 3 axis. The worst case was found when positioned on **Z-plane**.

Radiated Emission Test (Above 1 GHz):

- Pre-Scan has been conducted to determine the worst-case mode from all possible combinations between available modulations, data rates and antenna ports (if EUT with antenna diversity architecture).
- Following channel(s) was (were) selected for the final test as listed below.

EUT Configure Mode	Available Channel	Tested Channel	Modulation Type	Data Rate (Mbps)
-	0 to 39	0, 19, 39	GFSK	1

Radiated Emission Test (Below 1 GHz):

- Pre-Scan has been conducted to determine the worst-case mode from all possible combinations between available modulations, data rates and antenna ports (if EUT with antenna diversity architecture).
- Following channel(s) was (were) selected for the final test as listed below.

EUT Configure Mode	Available Channel	Tested Channel	Modulation Type	Data Rate (Mbps)
-	0 to 39	0	GFSK	1

Power Line Conducted Emission Test:

- Pre-Scan has been conducted to determine the worst-case mode from all possible combinations between available modulations, data rates and antenna ports (if EUT with antenna diversity architecture).
- Following channel(s) was (were) selected for the final test as listed below.

EUT Configure Mode	Available Channel	Tested Channel	Modulation Type	Data Rate (Mbps)
-	0 to 39	0	GFSK	1

Antenna Port Conducted Measurement:

- This item includes all test value of each mode, but only includes spectrum plot of worst value of each mode.
- Pre-Scan has been conducted to determine the worst-case mode from all possible combinations between available modulations, data rates and antenna ports (if EUT with antenna diversity architecture).
- Following channel(s) was (were) selected for the final test as listed below.

EUT Configure Mode	Available Channel	Tested Channel	Modulation Type	Data Rate (Mbps)
-	0 to 39	0, 19, 39	GFSK	1

<WLAN>

EUT Configure Mode	Applicable To				Description
	RE≥1G	RE<1G	PLC	APCM	
-	√	√	√	√	-

Where **RE≥1G**: Radiated Emission above 1 GHz **RE<1G**: Radiated Emission below 1 GHz
PLC: Power Line Conducted Emission **APCM**: Antenna Port Conducted Measurement

Note:

1. The EUT had been pre-tested on the positioned of each 3 axis. The worst case was found when positioned on **Z-plane**.

Radiated Emission Test (Above 1 GHz):

- Pre-Scan has been conducted to determine the worst-case mode from all possible combinations between available modulations, data rates and antenna ports (if EUT with antenna diversity architecture).
- Following channel(s) was (were) selected for the final test as listed below.

EUT Configure Mode	Mode	Available Channel	Tested Channel	Modulation Technology	Modulation Type	Data Rate (Mbps)
-	802.11b	1 to 13	1, 6, 11, 12, 13	DSSS	DBPSK	1.0
-	802.11g	1 to 13	1, 6, 11, 12, 13	OFDM	BPSK	6.0
-	802.11n (HT20)	1 to 13	1, 6, 11, 12, 13	OFDM	BPSK	6.5

Radiated Emission Test (Below 1 GHz):

- Pre-Scan has been conducted to determine the worst-case mode from all possible combinations between available modulations, data rates and antenna ports (if EUT with antenna diversity architecture).
- Following channel(s) was (were) selected for the final test as listed below.

EUT Configure Mode	Mode	Available Channel	Tested Channel	Modulation Technology	Modulation Type	Data Rate (Mbps)
-	802.11n (HT20)	1 to 13	13	OFDM	BPSK	6.5

Power Line Conducted Emission Test:

- Pre-Scan has been conducted to determine the worst-case mode from all possible combinations between available modulations, data rates and antenna ports (if EUT with antenna diversity architecture).
- Following channel(s) was (were) selected for the final test as listed below.

EUT Configure Mode	Mode	Available Channel	Tested Channel	Modulation Technology	Modulation Type	Data Rate (Mbps)
-	802.11n (HT20)	1 to 13	13	OFDM	BPSK	6.5

Antenna Port Conducted Measurement:

- This item includes all test value of each mode, but only includes spectrum plot of worst value of each mode.
- Pre-Scan has been conducted to determine the worst-case mode from all possible combinations between available modulations, data rates and antenna ports (if EUT with antenna diversity architecture).
- Following channel(s) was (were) selected for the final test as listed below.

EUT Configure Mode	Mode	Available Channel	Tested Channel	Modulation Technology	Modulation Type	Data Rate (Mbps)
-	802.11b	1 to 13	1, 6, 11, 12, 13	DSSS	DBPSK	1.0
-	802.11g	1 to 13	1, 6, 11, 12, 13	OFDM	BPSK	6.0
-	802.11n (HT20)	1 to 13	1, 6, 11, 12, 13	OFDM	BPSK	6.5

Test Condition:

Applicable To	Environmental Conditions	Input Power	Tested by
RE \geq 1G	25 deg. C, 65 % RH	120 Vac, 60 Hz	Charles Hsiao, Karl Lee
RE $<$ 1G	25 deg. C, 65 % RH	120 Vac, 60 Hz	Charles Hsiao, Karl Lee
PLC	25 deg. C, 65 % RH	120 Vac, 60 Hz	Jisyong Wang
APCM	25 deg. C, 65 % RH	3.8 Vdc	Wayne Lin

3.3 Description of Support Units

The EUT has been tested as an independent unit together with other necessary accessories or support units. The following support units or accessories were used to form a representative test configuration during the tests.

No.	Product	Brand	Model No.	Serial No.	FCC ID
1.	Adapter	SALCOMP	TC U250	N/A	N/A
2.	Cradle	Simula Technology Inc.	CB846E-6040-102	N/A	N/A

No.	Signal Cable Description Of The Above Support Units
1.	1m shielded cable

3.3.1 Configuration of System under Test

<Bluetooth LE & WLAN>

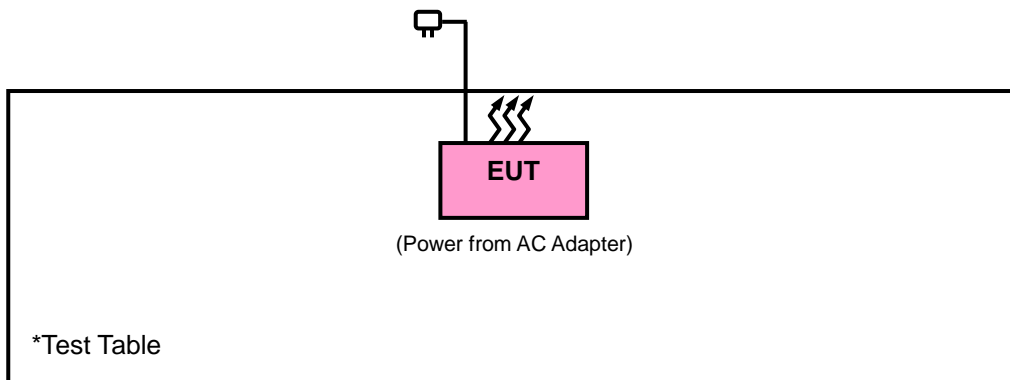

3.4 General Description of Applied Standards

The EUT is a RF Product. According to the specifications of the manufacturer, it must comply with the requirements of the following standards:

FCC Part 15, Subpart C (15.247)

KDB 558074 D01 15.247 Meas Guidance v05r02

ANSI C63.10-2013

All test items have been performed and recorded as per the above standards.

4 Test Types and Results

<BLUETOOTH LE>

4.1 Radiated Emission and Bandedge Measurement

4.1.1 Limits of Radiated Emission and Bandedge Measurement

Radiated emissions which fall in the restricted bands must comply with the radiated emission limits specified as below table. Other emissions shall be at least 20 dB below the highest level of the desired power:

Frequencies (MHz)	Field Strength (microvolts/meter)	Measurement Distance (meters)
0.009 ~ 0.490	2400/F (kHz)	300
0.490 ~ 1.705	24000/F (kHz)	30
1.705 ~ 30.0	30	30
30 ~ 88	100	3
88 ~ 216	150	3
216 ~ 960	200	3
Above 960	500	3

Note:

1. The lower limit shall apply at the transition frequencies.
2. Emission level (dBuV/m) = 20 log Emission level (uV/m).
3. For frequencies above 1000 MHz, the field strength limits are based on average detector, however, the peak field strength of any emission shall not exceed the maximum permitted average limits, specified above by more than 20 dB under any condition of modulation.

4.1.2 Test Instruments

Description & Manufacturer	Model No.	Serial No.	Date Of Calibration	Due Date Of Calibration
Test Receiver Agilent Technologies	N9038A	MY52260177	Aug. 26, 2019	Aug. 25, 2020
Spectrum Analyzer R&S	FSU43	101261	Apr. 15, 2019	Apr. 14, 2020
HORN Antenna ETS-Lindgren	3117	00143293	Nov. 25, 2018	Nov. 24, 2019
BILOG Antenna SCHWARZBECK	VULB 9168	9168-616	Nov. 27, 2018	Nov. 26, 2019
HORN Antenna SCHWARZBECK	BBHA 9170	9170-480	Nov. 25, 2018	Nov. 24, 2019
Fixed Attenuator Mini-Circuits	MDCS18N-10	MDCS18N-10-01	Apr. 15, 2019	Apr. 14, 2020
Loop Antenna	EM-6879	269	Sep. 16, 2019	Sep. 15, 2020
Preamplifier Agilent	310N	187226	Jun. 18, 2019	Jun. 17, 2020
Preamplifier Agilent	83017A	MY39501357	Jun. 18, 2019	Jun. 17, 2020
Power Meter Anritsu	ML2495A	1012010	Sep. 04, 2019	Sep. 03, 2020
Power Sensor Anritsu	MA2411B	1315050	Sep. 04, 2019	Sep. 03, 2020
Preamplifier EMCI	EMC 184045	980116	Oct. 12, 2018	Oct. 11, 2019
			Oct. 08, 2019	Oct. 07, 2020
RF signal cable ETS-LINDGREN	5D-FB	Cable-CH1-01(RFC -SMS-100-SMS-120 +RFC-SMS-100-SM S-400)	Jun. 18, 2019	Jun. 17, 2020
RF signal cable ETS-LINDGREN	8D-FB	Cable-CH1-02(RFC -SMS-100-SMS-24)	Jun. 18, 2019	Jun. 17, 2020
Boresight Antenna Fixture	FBA-01	FBA-SIP01	NA	NA
Software BV ADT	E3 8.130425b	NA	NA	NA
Antenna Tower MF	NA	NA	NA	NA
Turn Table MF	NA	NA	NA	NA
Antenna Tower & Turn Table Controller MF	MF-7802	NA	NA	NA

- Note: 1. The calibration interval of the above test instruments is 12 / 24 months and the calibrations are traceable to NML/ROC and NIST/USA.
2. The test was performed in HsinTien Chamber 1.

4.1.3 Test Procedures

For Radiated Emission below 30 MHz

- a. The EUT was placed on the top of a rotating table 0.8 meters above the ground at a 3 meter chamber room. The table was rotated 360 degrees to determine the position of the highest radiation.
- b. The EUT was set 3 meters away from the interference-receiving antenna, which was mounted on the top of a variable-height antenna tower.
- c. Parallel, perpendicular, and ground-parallel orientations of the antenna are set to make the measurement.
- d. For each suspected emission, the EUT was arranged to its worst case and the rotatable table was turned from 0 degrees to 360 degrees to find the maximum reading.
- e. The test-receiver system was set to Quasi-Peak Detect Function and Specified Bandwidth with Maximum Hold Mode.

Note:

1. The resolution bandwidth and video bandwidth of test receiver/spectrum analyzer is 9 kHz at frequency below 30 MHz.

For Radiated Emission above 30 MHz

- a. The EUT was placed on the top of a rotating table 0.8 meters (for 30 MHz ~ 1 GHz) / 1.5 meters (for above 1 GHz) above the ground at 3 meter chamber room for test. The table was rotated 360 degrees to determine the position of the highest radiation.
- b. The EUT was set 3 meters away from the interference-receiving antenna, which was mounted on the top of a variable-height antenna tower.
- c. The height of antenna is varied from one meter to four meters above the ground to determine the maximum value of the field strength. Both horizontal and vertical polarizations of the antenna are set to make the measurement.
- d. For each suspected emission, the EUT was arranged to its worst case and then the antenna was tuned to heights from 1 meter to 4 meters and the rotatable table was turned from 0 degrees to 360 degrees to find the maximum reading.
- e. The test-receiver system was set to quasi-peak detect function and specified bandwidth with maximum hold mode when the test frequency is below 1 GHz.
- f. The test-receiver system was set to peak and average detected function and specified bandwidth with maximum hold mode when the test frequency is above 1 GHz. If the peak reading value also meets average limit, measurement with the average detector is unnecessary.

Note:

1. The resolution bandwidth and video bandwidth of test receiver/spectrum analyzer is 120 kHz for Quasi-peak detection (QP) or Peak detection (PK) at frequency below 1 GHz.
2. The resolution bandwidth of test receiver/spectrum analyzer is 1 MHz and the video bandwidth is 3 MHz for Peak detection (PK) at frequency above 1 GHz.
3. The resolution bandwidth of test receiver/spectrum analyzer is 1 MHz and the video bandwidth is $\geq 1/T$ (Duty cycle < 98 %) or 10 Hz (Duty cycle ≥ 98 %) for Average detection (AV) at frequency above 1 GHz. (GFSK: RBW = 1 MHz, VBW = 3 kHz)
4. All modes of operation were investigated and the worst-case emissions are reported.

4.1.4 Deviation from Test Standard

No deviation.

4.1.5 Test Set Up

<Radiated Emission below 30 MHz>

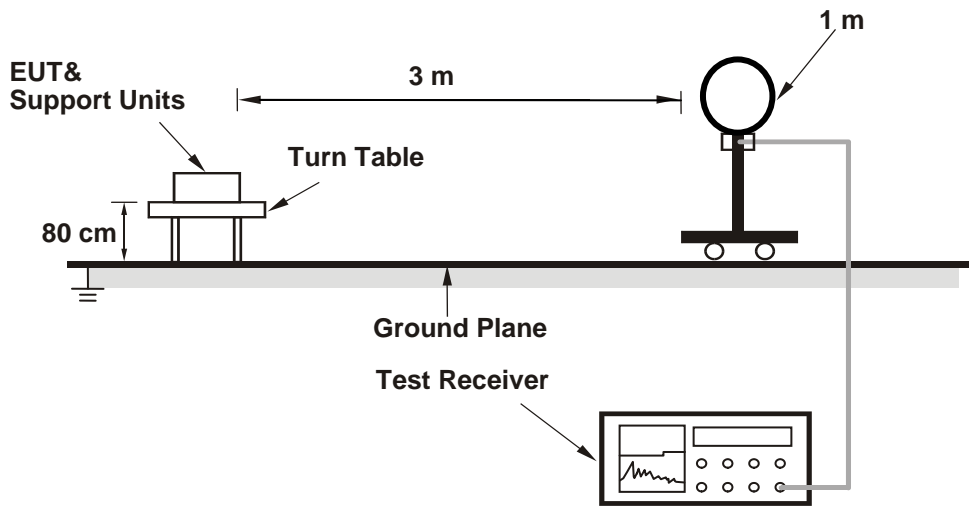

<Radiated Emission 30 MHz to 1 GHz>

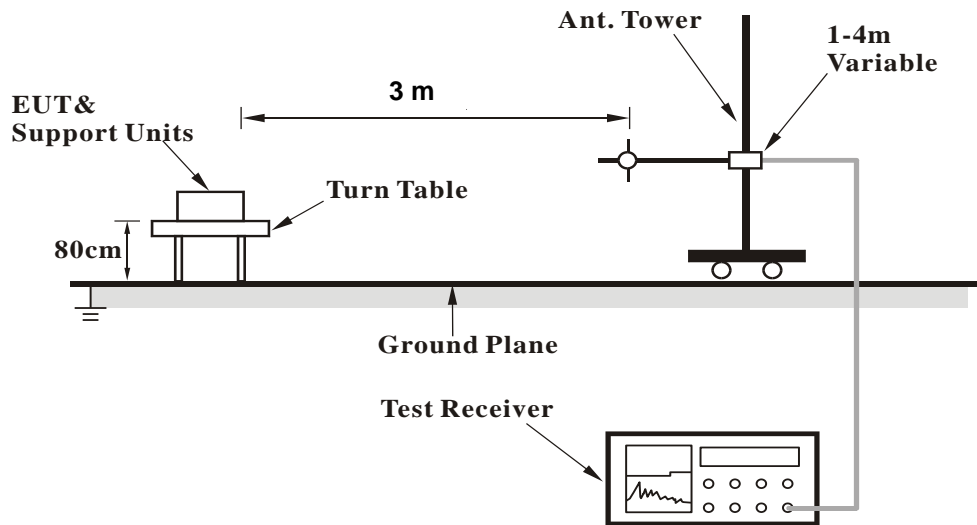

<Radiated Emission above 1 GHz>

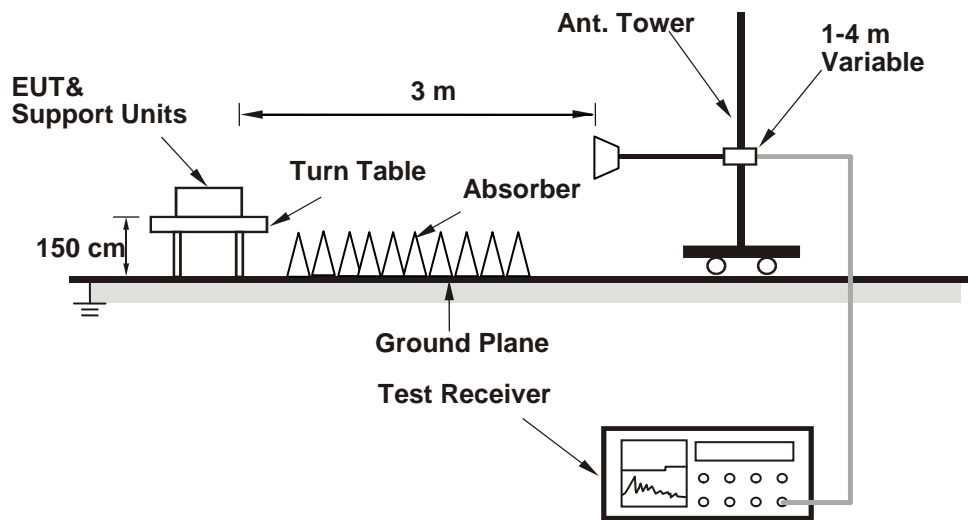

For the actual test configuration, please refer to the attached file (Test Setup Photo).

4.1.6 EUT Operating Conditions

- Placed the EUT on the testing table.
- Set the EUT under transmission condition continuously at specific channel frequency.

4.1.7 Test Results

Above 1 GHz Data:

EUT Test Condition		Measurement Detail	
Channel	Channel 0	Frequency Range	1 GHz ~ 25 GHz
Input Power	120 Vac, 60 Hz	Detector Function	Peak (PK) Average (AV)
Environmental Conditions	25 deg. C, 65 % RH	Tested By	Charles Hsiao

Horizontal

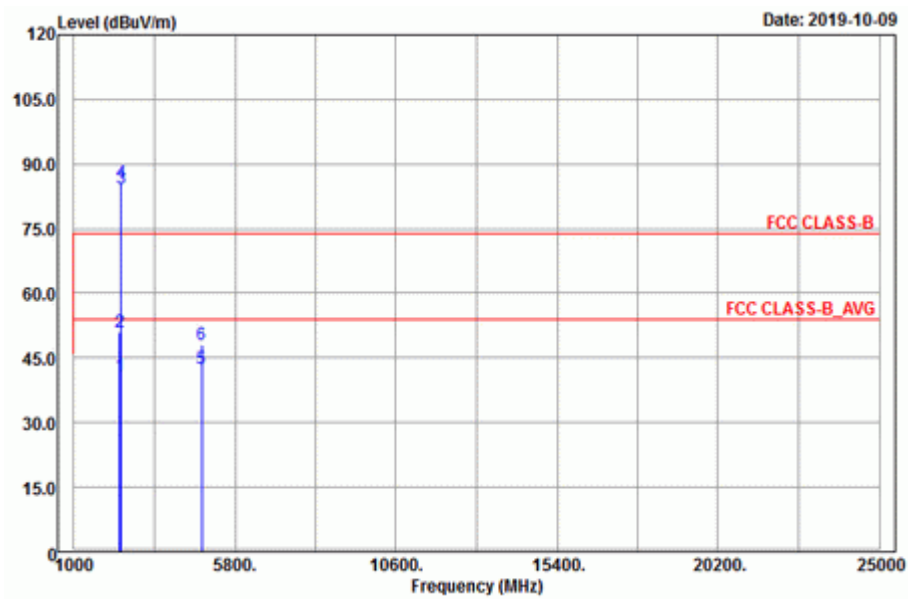

Vertical

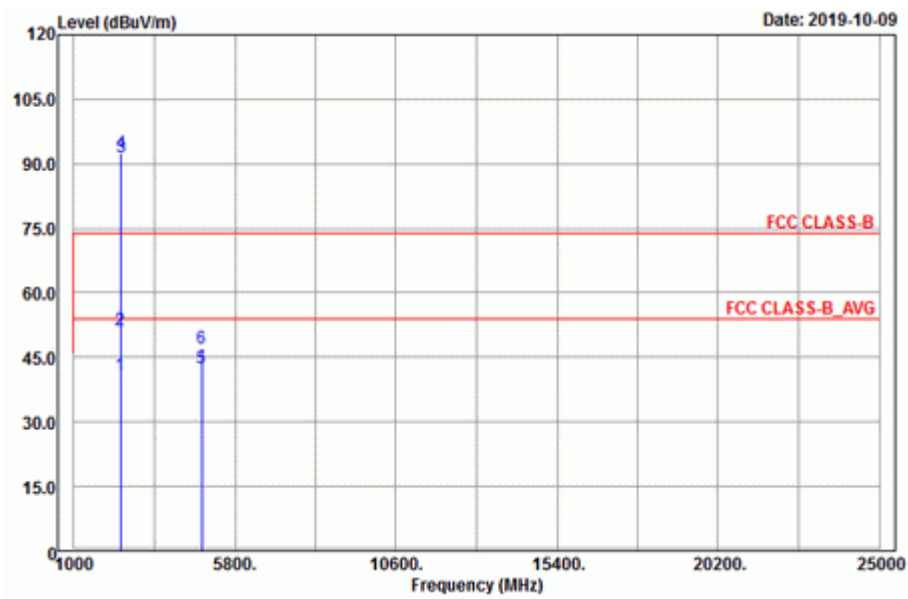

Antenna Polarity & Test Distance: Horizontal at 3 m

Frequency (MHz)	Emission Level (dBuV/m)	Read Level (dBuV)	Factor (dB/m)	Limit (dBuV/m)	Margin (dB)	Antenna Height (cm)	Table Angle (Degree)	Remark
2372.37	40.88	36.43	4.45	54	-13.12	163	165	Average
2372.37	51.14	46.69	4.45	74	-22.86	163	165	Peak
2402	84.35	79.83	4.52			163	165	Average
2402	85.74	81.22	4.52			163	165	Peak
4804	42.57	32.22	10.35	54	-11.43	164	188	Average
4804	48.07	37.72	10.35	74	-25.93	164	188	Peak

Antenna Polarity & Test Distance: Vertical at 3 m

Frequency (MHz)	Emission Level (dBuV/m)	Read Level (dBuV)	Factor (dB/m)	Limit (dBuV/m)	Margin (dB)	Antenna Height (cm)	Table Angle (Degree)	Remark
2389.47	40.8	36.31	4.49	54	-13.2	147	7	Average
2389.47	51.37	46.88	4.49	74	-22.63	147	7	Peak
2402	91.44	86.92	4.52			147	7	Average
2402	92.63	88.11	4.52			147	7	Peak
4804	42.37	32.02	10.35	54	-11.63	164	44	Average
4804	47.2	36.85	10.35	74	-26.8	164	44	Peak

Remarks:

- Emission Level = Read Level + Factor
Margin value = Emission level – Limit value
- 2402 MHz: Fundamental frequency.
- The emission levels of other frequencies were very low against the limit.

EUT Test Condition		Measurement Detail	
Channel	Channel 19	Frequency Range	1 GHz ~ 25 GHz
Input Power	120 Vac, 60 Hz	Detector Function	Peak (PK) Average (AV)
Environmental Conditions	25 deg. C, 65 % RH	Tested By	Charles Hsiao

Horizontal

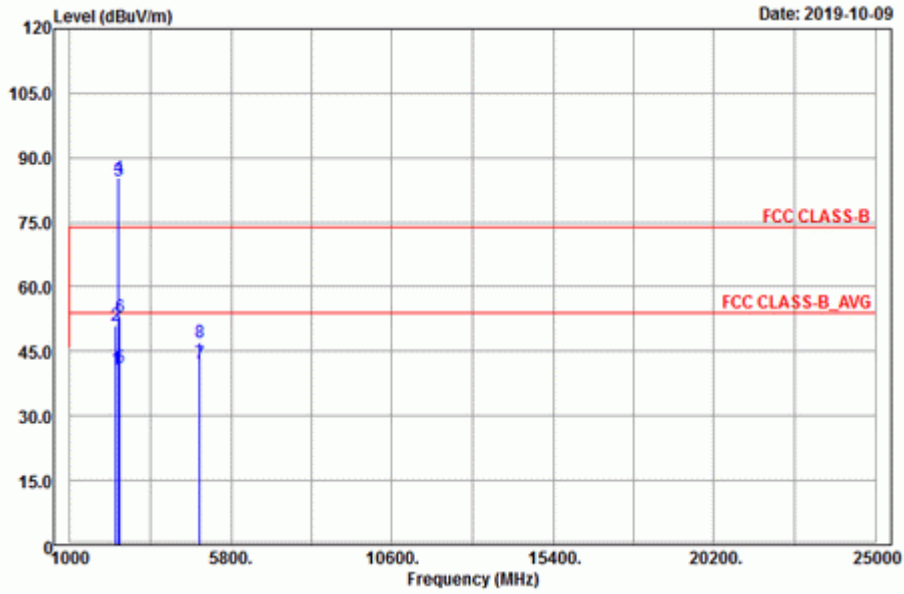

Vertical

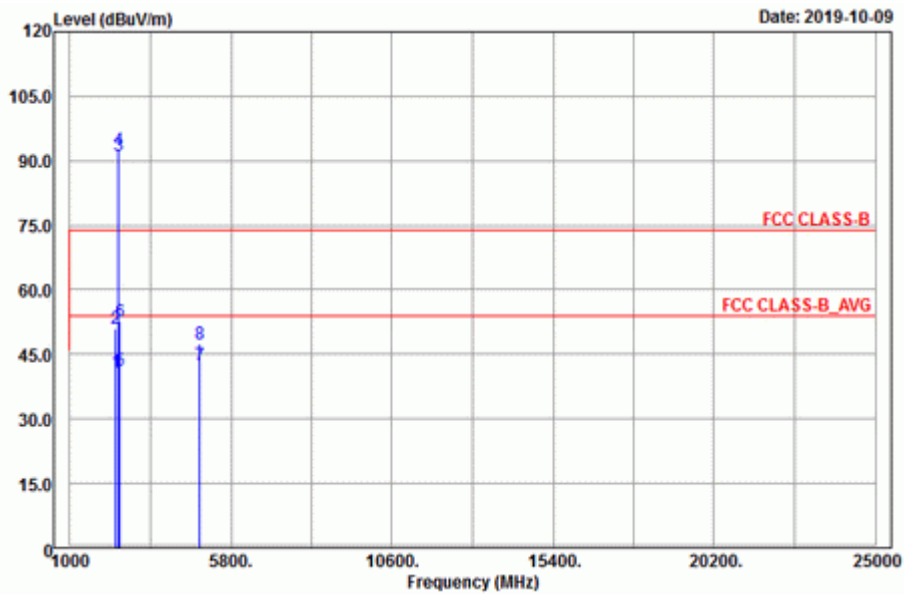

Antenna Polarity & Test Distance: Horizontal at 3 m

Frequency (MHz)	Emission Level (dBuV/m)	Read Level (dBuV)	Factor (dB/m)	Limit (dBuV/m)	Margin (dB)	Antenna Height (cm)	Table Angle (Degree)	Remark
2366.43	40.82	36.39	4.43	54	-13.18	163	165	Average
2366.43	50.87	46.44	4.43	74	-23.13	163	165	Peak
2440	84.59	80	4.59			163	165	Average
2440	85.27	80.68	4.59			163	165	Peak
2484.76	41.26	36.6	4.66	54	-12.74	163	165	Average
2484.76	52.85	48.19	4.66	74	-21.15	163	165	Peak
4880	42.07	31.86	10.21	54	-11.93	105	255	Average
4880	47.1	36.89	10.21	74	-26.9	105	255	Peak

Antenna Polarity & Test Distance: Vertical at 3 m

Frequency (MHz)	Emission Level (dBuV/m)	Read Level (dBuV)	Factor (dB/m)	Limit (dBuV/m)	Margin (dB)	Antenna Height (cm)	Table Angle (Degree)	Remark
2375.97	40.81	36.34	4.47	54	-13.19	147	7	Average
2375.97	51.06	46.59	4.47	74	-22.94	147	7	Peak
2440	91.38	86.79	4.59			147	7	Average
2440	92.56	87.97	4.59			147	7	Peak
2496.56	41.36	36.69	4.67	54	-12.64	147	7	Average
2496.56	52.5	47.83	4.67	74	-21.5	147	7	Peak
4880	42.36	32.15	10.21	54	-11.64	133	325	Average
4880	47.54	37.33	10.21	74	-26.46	133	325	Peak

Remarks:

- Emission Level = Read Level + Factor
Margin value = Emission level – Limit value
- 2440 MHz: Fundamental frequency.
- The emission levels of other frequencies were very low against the limit.

EUT Test Condition		Measurement Detail	
Channel	Channel 39	Frequency Range	1 GHz ~ 25 GHz
Input Power	120 Vac, 60 Hz	Detector Function	Peak (PK) Average (AV)
Environmental Conditions	25 deg. C, 65 % RH	Tested By	Charles Hsiao

Horizontal

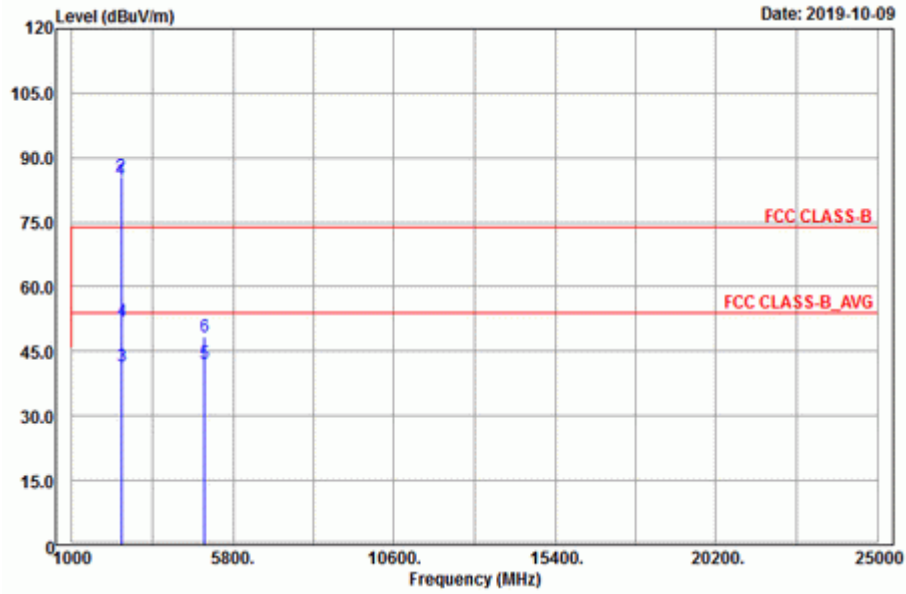

Vertical

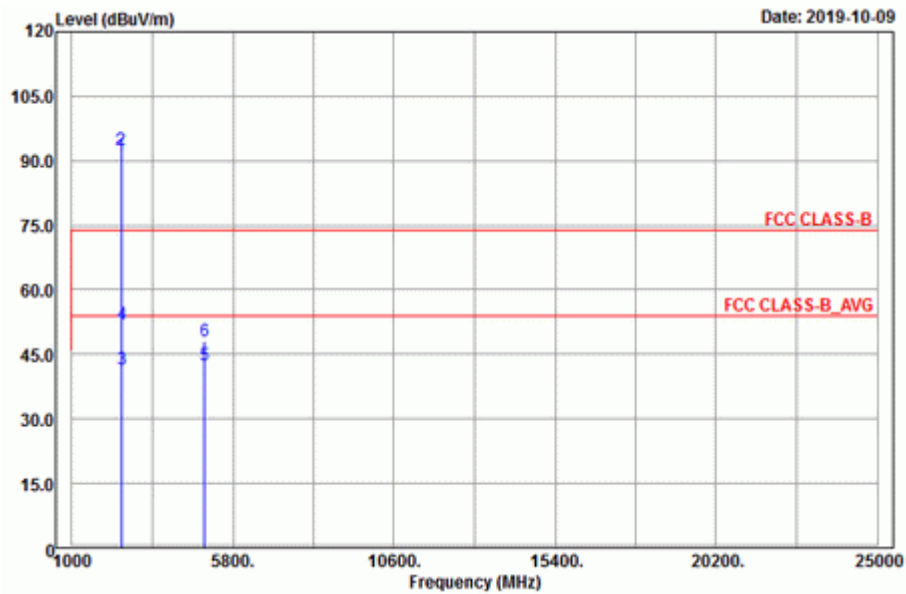

Antenna Polarity & Test Distance: Horizontal at 3 m

Frequency (MHz)	Emission Level (dBuV/m)	Read Level (dBuV)	Factor (dB/m)	Limit (dBuV/m)	Margin (dB)	Antenna Height (cm)	Table Angle (Degree)	Remark
2480	84.59	79.95	4.64			163	165	Average
2480	85.54	80.9	4.64			163	165	Peak
2498.16	41.42	36.75	4.67	54	-12.58	163	165	Average
2498.16	51.83	47.16	4.67	74	-22.17	163	165	Peak
4960	42.15	31.79	10.36	54	-11.85	154	44	Average
4960	48.48	38.12	10.36	74	-25.52	154	44	Peak

Antenna Polarity & Test Distance: Vertical at 3 m

Frequency (MHz)	Emission Level (dBuV/m)	Read Level (dBuV)	Factor (dB/m)	Limit (dBuV/m)	Margin (dB)	Antenna Height (cm)	Table Angle (Degree)	Remark
2480	91.28	86.64	4.64			147	7	Average
2480	92.66	88.02	4.64			147	7	Peak
2490.12	41.4	36.72	4.68	54	-12.6	147	7	Average
2490.12	51.92	47.24	4.68	74	-22.08	147	7	Peak
4960	42.37	32.01	10.36	54	-11.63	133	325	Average
4960	47.95	37.59	10.36	74	-26.05	133	325	Peak

Remarks:

- Emission Level = Read Level + Factor
Margin value = Emission level – Limit value
- 2480 MHz: Fundamental frequency.
- The emission levels of other frequencies were very low against the limit.

9 kHz ~ 30 MHz Data:

The amplitude of spurious emissions attenuated more than 20 dB below the permissible value is not required to be report.

30 MHz ~ 1 GHz Worst-Case Data:

EUT Test Condition		Measurement Detail	
Channel	Channel 0	Frequency Range	30 MHz ~ 1 GHz
Input Power	120 Vac, 60 Hz	Detector Function	Peak (PK) Quasi-peak (QP)
Environmental Conditions	25 deg. C, 65 % RH	Tested By	Charles Hsiao

Horizontal

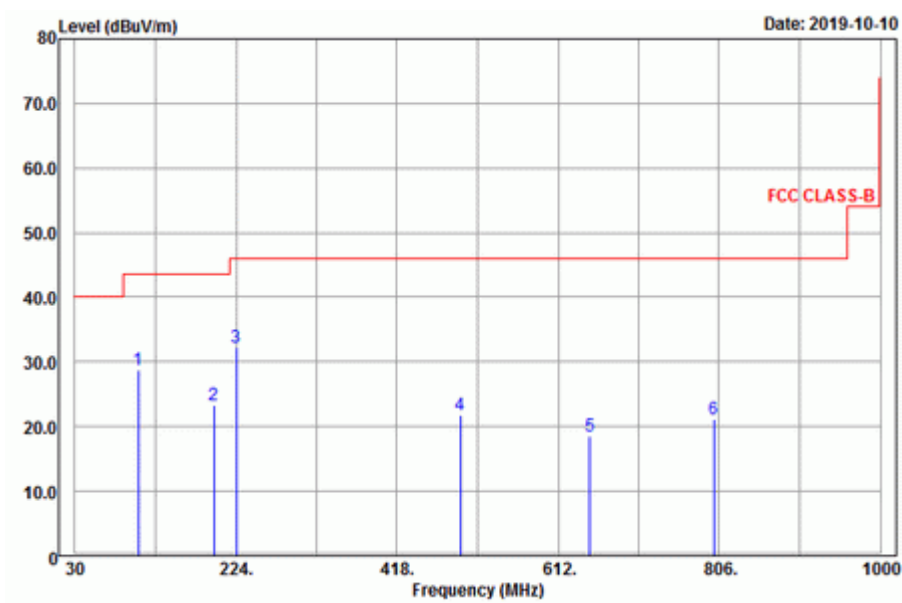

Vertical

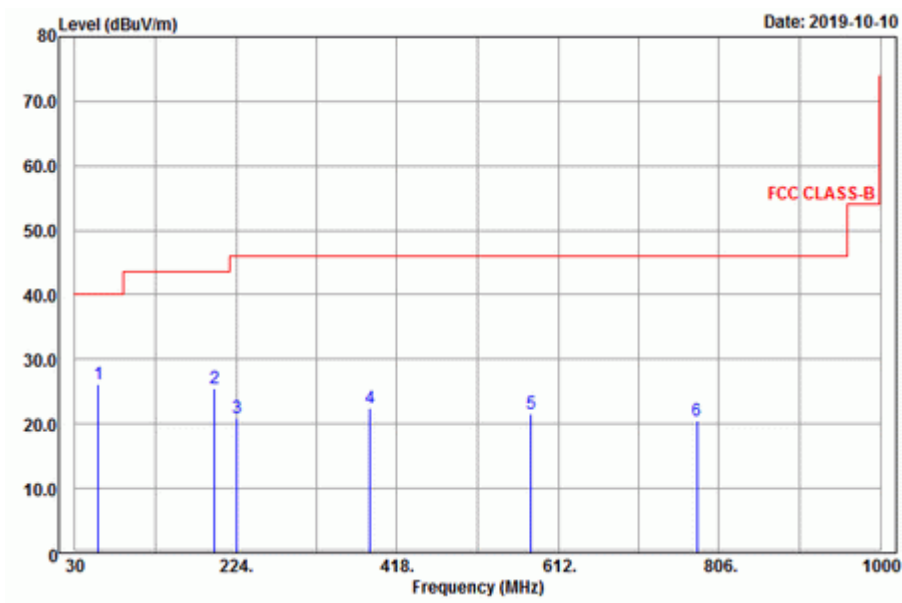

Antenna Polarity & Test Distance: Horizontal at 3 m

Frequency (MHz)	Emission Level (dBuV/m)	Read Level (dBuV)	Factor (dB/m)	Limit (dBuV/m)	Margin (dB)	Antenna Height (cm)	Table Angle (Degree)	Remark
106.14	28.8	46	-17.2	43.5	-14.7	101	1	Peak
197.4	23.42	41.73	-18.31	43.5	-20.08	154	185	Peak
224.67	32.19	49.81	-17.62	46	-13.81	167	155	Peak
494.6	21.78	34.19	-12.41	46	-24.22	164	15	Peak
650	18.53	28.6	-10.07	46	-27.47	105	285	Peak
799.8	21.08	28.67	-7.59	46	-24.92	199	295	Peak

Antenna Polarity & Test Distance: Vertical at 3 m

Frequency (MHz)	Emission Level (dBuV/m)	Read Level (dBuV)	Factor (dB/m)	Limit (dBuV/m)	Margin (dB)	Antenna Height (cm)	Table Angle (Degree)	Remark
58.08	26.09	41.95	-15.86	40	-13.91	136	265	Peak
198.48	25.58	43.86	-18.28	43.5	-17.92	164	189	Peak
224.94	20.94	38.56	-17.62	46	-25.06	154	224	Peak
385.4	22.47	36.64	-14.17	46	-23.53	165	85	Peak
579.3	21.64	32.58	-10.94	46	-24.36	164	292	Peak
779.5	20.43	28.55	-8.12	46	-25.57	180	8	Peak

Remarks:

- Emission Level = Read Level + Factor
Margin value = Emission level – Limit value
- The emission levels of other frequencies were very low against the limit.

4.2 Conducted Emission Measurement

4.2.1 Limits of Conducted Emission Measurement

Frequency (MHz)	Conducted Limit (dBuV)	
	Quasi-Peak	Average
0.15 - 0.5	66 - 56	56 - 46
0.50 - 5.0	56	46
5.0 - 30.0	60	50

- Note: 1. The lower limit shall apply at the transition frequencies.
 2. The limit decreases in line with the logarithm of the frequency in the range of 0.15 to 0.50 MHz.

4.2.2 Test Instruments

Description & Manufacturer	Model No.	Serial No.	Date of Calibration	Due Date of Calibration
Test Receiver ROHDE & SCHWARZ	ESCI	100613	Dec. 10, 2018	Dec. 09, 2019
RF signal cable Woken	5D-FB	Cable-cond1-01	Sep. 05, 2019	Sep. 04, 2020
LISN ROHDE & SCHWARZ (EUT)	ENV216	101826	Feb. 21, 2019	Feb. 20, 2020
LISN ROHDE & SCHWARZ (Peripheral)	ESH3-Z5	100311	Aug. 22, 2019	Aug. 21, 2020
Software ADT	BV ADT_Cond_ V7.3.7.4	NA	NA	NA

- Note: 1. The calibration interval of the above test instruments is 12 months and the calibrations are traceable to NML/ROC and NIST/USA.
 2. The test was performed in HwaYa Shielded Room 1.
 3. The VCCI Site Registration No. is C-12040.

4.2.3 Test Procedures

- The EUT was placed 0.4 meters from the conducting wall of the shielded room with EUT being connected to the power mains through a line impedance stabilization network (LISN). Other support units were connected to the power mains through another LISN. The two LISNs provide 50 ohm/50 uH of coupling impedance for the measuring instrument.
- Both lines of the power mains connected to the EUT were checked for maximum conducted interference.
- The frequency range from 150 kHz to 30 MHz was searched. Emission levels under (Limit – 20 dB) was not recorded.

Note: The resolution bandwidth and video bandwidth of test receiver is 9 kHz for quasi-peak detection (QP) and average detection (AV) at frequency 0.15 MHz - 30 MHz.

4.2.4 Deviation from Test Standard

No deviation.

4.2.5 Test Setup

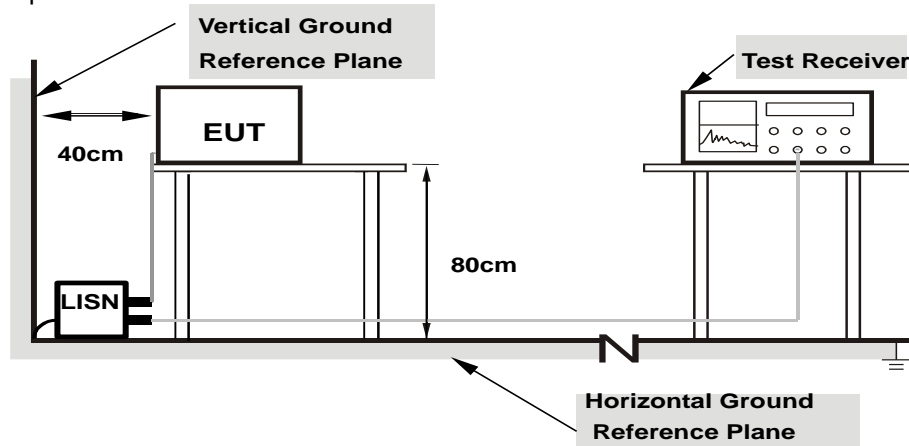

Note: 1.Support units were connected to second LISN.

2.Both of LISNs (AMN) are 80 cm from EUT and at least 80 from other units and other metal planes

4.2.6 EUT Operating Conditions

- a. Placed the EUT on the testing table.
- b. Set the EUT under transmission condition continuously at specific channel frequency.

4.2.7 Test Results

Frequency Range	150kHz ~ 30MHz	Detector Function & Resolution Bandwidth	Quasi-Peak (QP) / Average (AV), 9kHz
Input Power	120Vac, 60Hz	Environmental Conditions	25°C, 65%RH
Tested by	Jisyong Wang	Test Date	2019/10/13

Phase Of Power : Line (L)										
No	Frequency (MHz)	Correction Factor (dB)	Reading Value (dBuV)		Emission Level (dBuV)		Limit (dBuV)		Margin (dB)	
			Q.P.	AV.	Q.P.	AV.	Q.P.	AV.	Q.P.	AV.
1	0.15802	9.67	34.84	17.32	44.51	26.99	65.57	55.57	-21.06	-28.58
2	0.17346	9.67	32.19	15.46	41.86	25.13	64.79	54.79	-22.93	-29.66
3	0.18508	9.66	30.97	15.35	40.63	25.01	64.25	54.25	-23.62	-29.24
4	0.20084	9.66	28.88	14.35	38.54	24.01	63.58	53.58	-25.04	-29.57
5	0.23216	9.66	24.84	10.15	34.50	19.81	62.37	52.37	-27.87	-32.56
6	12.63072	9.95	15.81	1.22	25.76	11.17	60.00	50.00	-34.24	-38.83

Remarks:

1. Q.P. and AV. are abbreviations of quasi-peak and average individually.
2. The emission levels of other frequencies were very low against the limit.
3. Margin value = Emission level – Limit value
4. Correction factor = Insertion loss + Cable loss
5. Emission Level = Correction Factor + Reading Value

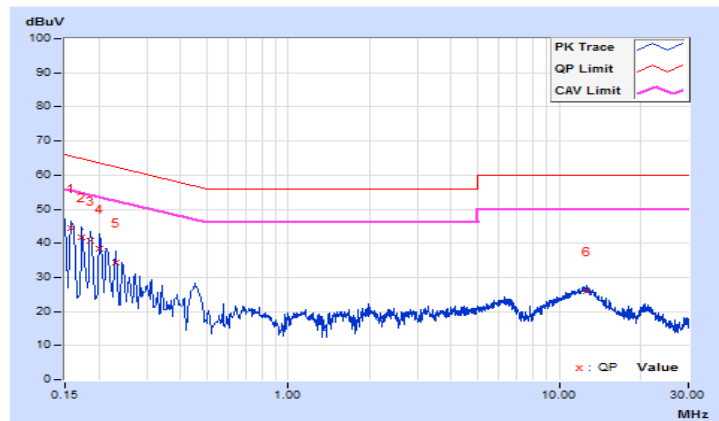

Frequency Range	150kHz ~ 30MHz	Detector Function & Resolution Bandwidth	Quasi-Peak (QP) / Average (AV), 9kHz
Input Power	120Vac, 60Hz	Environmental Conditions	25°C, 65%RH
Tested by	Jisyong Wang	Test Date	2019/10/13

Phase Of Power : Neutral (N)										
No	Frequency (MHz)	Correction Factor (dB)	Reading Value (dBuV)		Emission Level (dBuV)		Limit (dBuV)		Margin (dB)	
			Q.P.	AV.	Q.P.	AV.	Q.P.	AV.	Q.P.	AV.
1	0.16139	9.64	33.68	16.79	43.32	26.43	65.39	55.39	-22.07	-28.96
2	0.17374	9.64	32.84	16.02	42.48	25.66	64.78	54.78	-22.30	-29.12
3	0.19301	9.64	29.42	13.17	39.06	22.81	63.91	53.91	-24.85	-31.10
4	0.24407	9.64	23.90	10.25	33.54	19.89	61.96	51.96	-28.42	-32.07
5	0.29043	9.65	19.41	1.26	29.06	10.91	60.51	50.51	-31.45	-39.60
6	6.33725	9.85	19.06	1.74	28.91	11.59	60.00	50.00	-31.09	-38.41

Remarks:

1. Q.P. and AV. are abbreviations of quasi-peak and average individually.
2. The emission levels of other frequencies were very low against the limit.
3. Margin value = Emission level – Limit value
4. Correction factor = Insertion loss + Cable loss
5. Emission Level = Correction Factor + Reading Value

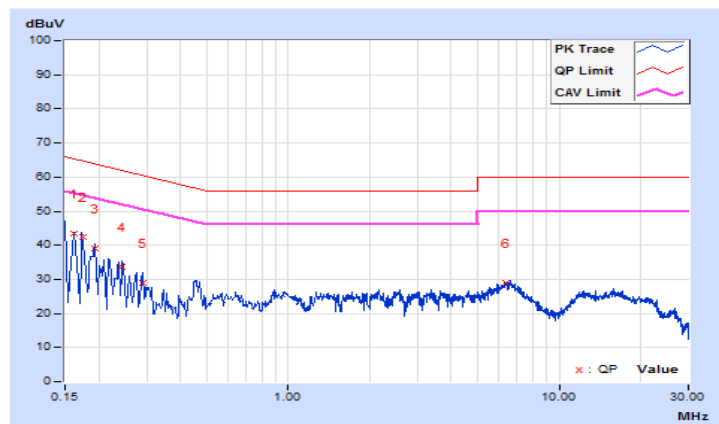

4.3 Conducted Output Power Measurement

4.3.1 Limits of Conducted Output Power Measurement

For systems using digital modulation in the 2400–2483.5 MHz bands: 1 Watt (30 dBm)

4.3.2 Test Setup

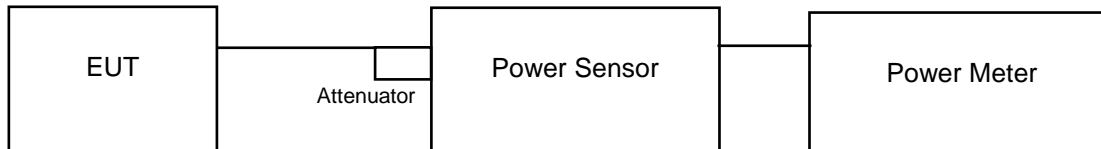

4.3.3 Test Instruments

Refer to section 4.1.2 to get information of above instrument.

4.3.4 Test Procedures

A peak power sensor was used on the output port of the EUT. A power meter was used to read the response of the peak power sensor. Record the power level.

4.3.5 Deviation from Test Standard

No deviation.

4.3.6 EUT Operating Conditions

The software provided by client to enable the EUT under transmission condition continuously at lowest, middle and highest channel frequencies individually.

4.3.7 Test Results

Channel	Frequency (MHz)	Peak Power (mW)	Peak Power (dBm)	Limit (dBm)	Pass / Fail
0	2402	1.807	2.57	30	Pass
19	2440	1.816	2.59	30	Pass
39	2480	1.77	2.48	30	Pass

<WLAN>

4.4 Radiated Emission and Bandedge Measurement

4.4.1 Limits of Radiated Emission and Bandedge Measurement

Radiated emissions which fall in the restricted bands must comply with the radiated emission limits specified as below table. Other emissions shall be at least 20 dB below the highest level of the desired power:

Frequencies (MHz)	Field Strength (microvolts/meter)	Measurement Distance (meters)
0.009 ~ 0.490	2400/F (kHz)	300
0.490 ~ 1.705	24000/F (kHz)	30
1.705 ~ 30.0	30	30
30 ~ 88	100	3
88 ~ 216	150	3
216 ~ 960	200	3
Above 960	500	3

NOTE:

1. The lower limit shall apply at the transition frequencies.
2. Emission level (dBuV/m) = 20 log Emission level (uV/m).
3. For frequencies above 1000 MHz, the field strength limits are based on average detector, however, the peak field strength of any emission shall not exceed the maximum permitted average limits, specified above by more than 20 dB under any condition of modulation.

4.4.2 Test Instruments

Refer to section 4.1.2.

4.4.3 Test Procedures

For Radiated Emission below 30 MHz

- a. The EUT was placed on the top of a rotating table 0.8 meters above the ground at a 3 meter chamber room. The table was rotated 360 degrees to determine the position of the highest radiation.
- b. The EUT was set 3 meters away from the interference-receiving antenna, which was mounted on the top of a variable-height antenna tower.
- c. Parallel, perpendicular, and ground-parallel orientations of the antenna are set to make the measurement.
- d. For each suspected emission, the EUT was arranged to its worst case and the rotatable table was turned from 0 degrees to 360 degrees to find the maximum reading.
- e. The test-receiver system was set to Quasi-Peak Detect Function and Specified Bandwidth with Maximum Hold Mode.

Note:

1. The resolution bandwidth and video bandwidth of test receiver/spectrum analyzer is 9 kHz at frequency below 30 MHz.

For Radiated Emission above 30 MHz

- a. The EUT was placed on the top of a rotating table 0.8 meters (for 30 MHz ~ 1 GHz) / 1.5 meters (for above 1 GHz) above the ground at 3 meter chamber room for test. The table was rotated 360 degrees to determine the position of the highest radiation.
- b. The EUT was set 3 meters away from the interference-receiving antenna, which was mounted on the top of a variable-height antenna tower.
- c. The height of antenna is varied from one meter to four meters above the ground to determine the maximum value of the field strength. Both horizontal and vertical polarizations of the antenna are set to make the measurement.
- d. For each suspected emission, the EUT was arranged to its worst case and then the antenna was tuned to heights from 1 meter to 4 meters and the rotatable table was turned from 0 degrees to 360 degrees to find the maximum reading.
- e. The test-receiver system was set to quasi-peak detect function and specified bandwidth with maximum hold mode when the test frequency is below 1 GHz.
- f. The test-receiver system was set to peak and average detected function and specified bandwidth with maximum hold mode when the test frequency is above 1 GHz. If the peak reading value also meets average limit, measurement with the average detector is unnecessary.

Note:

1. The resolution bandwidth and video bandwidth of test receiver/spectrum analyzer is 120 kHz for Quasi-peak detection (QP) or Peak detection (PK) at frequency below 1 GHz.
2. The resolution bandwidth of test receiver/spectrum analyzer is 1 MHz and the video bandwidth is 3 MHz for Peak detection (PK) at frequency above 1 GHz.
3. The resolution bandwidth of test receiver/spectrum analyzer is 1 MHz and the video bandwidth is $\geq 1/T$ (Duty cycle < 98 %) or 10 Hz (Duty cycle ≥ 98 %) for Average detection (AV) at frequency above 1 GHz.
(11b: RBW = 1 MHz, VBW = 300 Hz ; 11g: RBW = 1 MHz, VBW = 1 kHz ;
11n (HT20): RBW = 1 MHz, VBW = 1 kHz)
4. All modes of operation were investigated and the worst-case emissions are reported.

4.4.4 Deviation from Test Standard

No deviation.

4.4.5 Test Set Up

<Radiated Emission below 30 MHz>

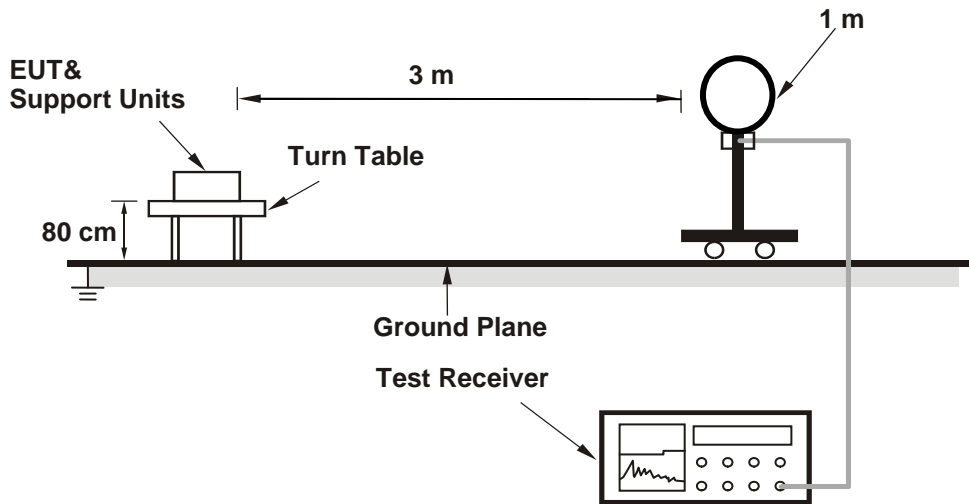

<Radiated Emission 30 MHz to 1 GHz>

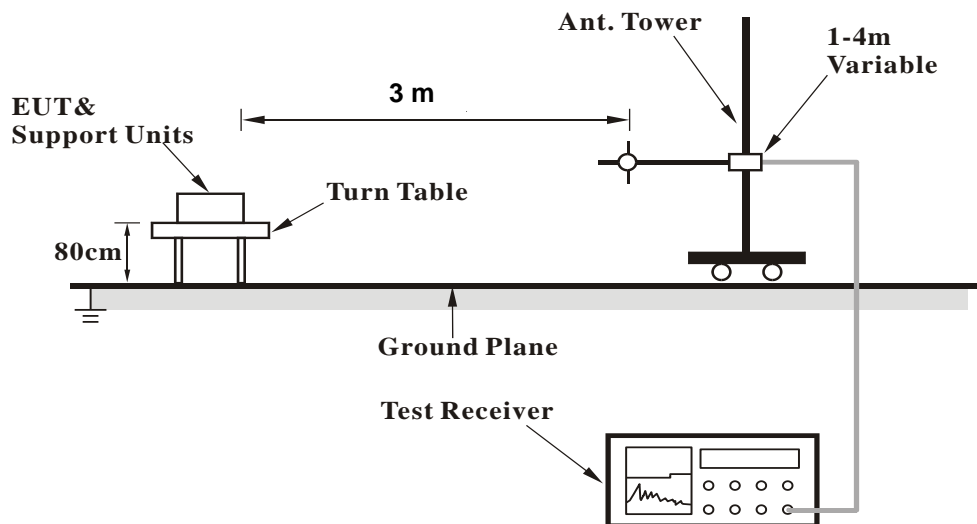

<Radiated Emission above 1 GHz>

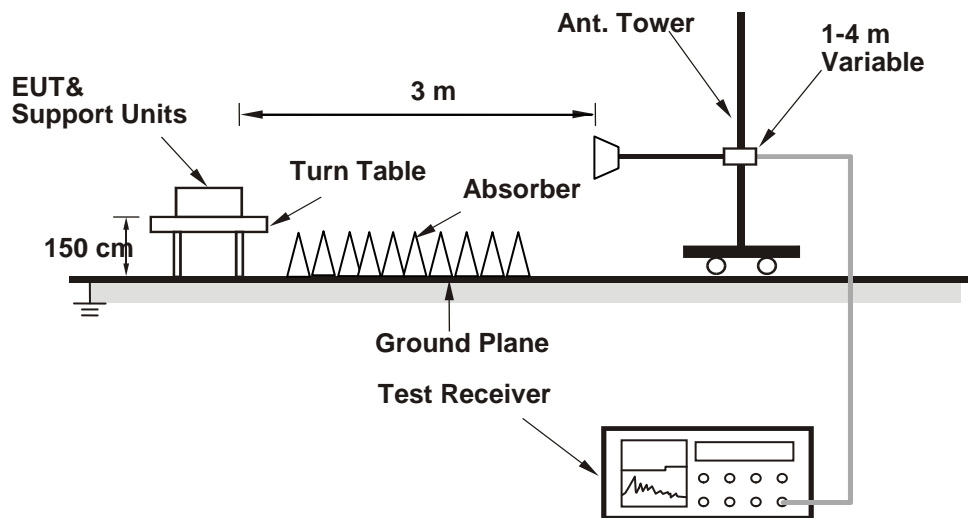

For the actual test configuration, please refer to the attached file (Test Setup Photo).

4.4.6 EUT Operating Conditions

- Placed the EUT on a testing table.
- Use the software to control the EUT under transmission condition continuously at specific channel frequency.

4.4.7 Test Results

Above 1 GHz Data :
802.11b

EUT Test Condition		Measurement Detail	
Channel	Channel 1	Frequency Range	1 GHz ~ 25 GHz
Input Power	120 Vac, 60 Hz	Detector Function	Peak (PK) Average (AV)
Environmental Conditions	25 deg. C, 65 % RH	Tested By	Karl Lee

Horizontal

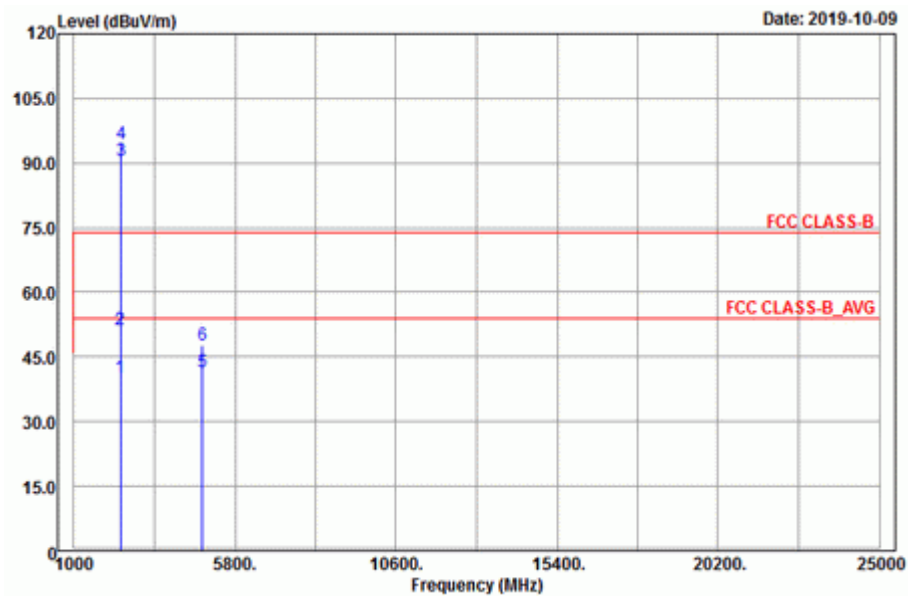

Vertical

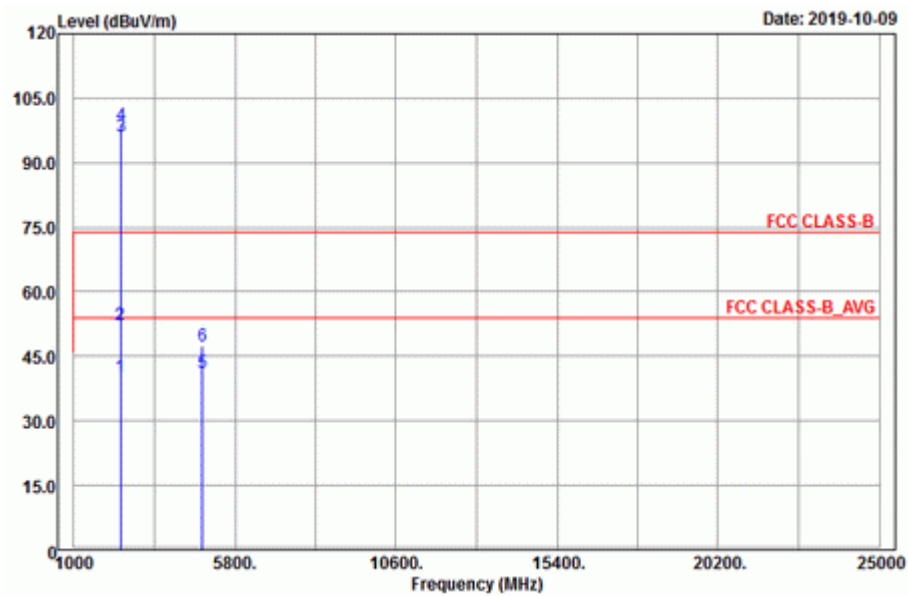

Antenna Polarity & Test Distance: Horizontal at 3 m

Frequency (MHz)	Emission Level (dBuV/m)	Read Level (dBuV)	Factor (dB/m)	Limit (dBuV/m)	Margin (dB)	Antenna Height (cm)	Table Angle (Degree)	Remark
2388.93	40.19	35.7	4.49	54	-13.81	279	139	Average
2388.93	51.18	46.69	4.49	74	-22.82	279	139	Peak
2412	90.57	86.02	4.55			279	139	Average
2412	94.34	89.79	4.55			279	139	Peak
4824	41.54	31.25	10.29	54	-12.46	156	294	Average
4824	47.64	37.35	10.29	74	-26.36	156	294	Peak

Antenna Polarity & Test Distance: Vertical at 3 m

Frequency (MHz)	Emission Level (dBuV/m)	Read Level (dBuV)	Factor (dB/m)	Limit (dBuV/m)	Margin (dB)	Antenna Height (cm)	Table Angle (Degree)	Remark
2389.2	40.36	35.87	4.49	54	-13.64	211	360	Average
2389.2	52.35	47.86	4.49	74	-21.65	211	360	Peak
2412	95.97	91.42	4.55			211	360	Average
2412	98.87	94.32	4.55			211	360	Peak
4824	41.16	30.87	10.29	54	-12.84	145	127	Average
4824	47.51	37.22	10.29	74	-26.49	145	127	Peak

Remarks:

- Emission Level = Read Level + Factor
Margin value = Emission level – Limit value
- 2412 MHz: Fundamental frequency.
- The emission levels of other frequencies were very low against the limit.

EUT Test Condition		Measurement Detail	
Channel	Channel 6	Frequency Range	1 GHz ~ 25 GHz
Input Power	120 Vac, 60 Hz	Detector Function	Peak (PK) Average (AV)
Environmental Conditions	25 deg. C, 65 % RH	Tested By	Karl Lee

Horizontal

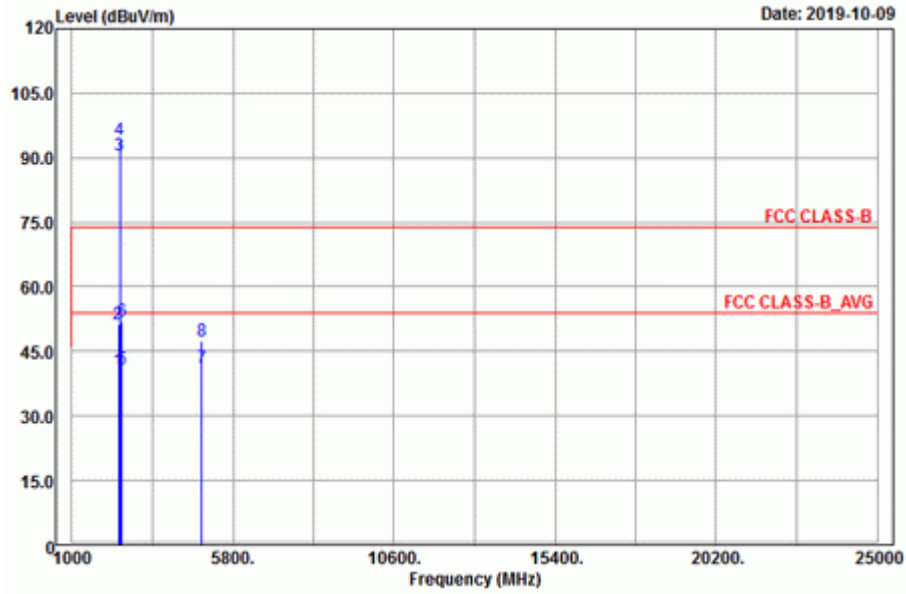

Vertical

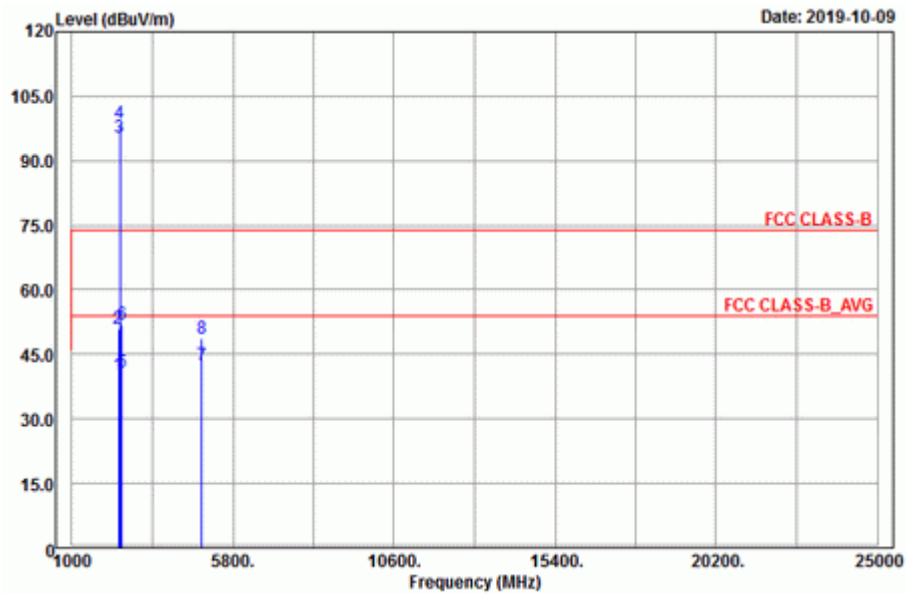

Antenna Polarity & Test Distance: Horizontal at 3 m

Frequency (MHz)	Emission Level (dBuV/m)	Read Level (dBuV)	Factor (dB/m)	Limit (dBuV/m)	Margin (dB)	Antenna Height (cm)	Table Angle (Degree)	Remark
2381.73	40.39	35.92	4.47	54	-13.61	279	139	Average
2381.73	51.48	47.01	4.47	74	-22.52	279	139	Peak
2437	90.62	86.03	4.59			279	139	Average
2437	94.26	89.67	4.59			279	139	Peak
2493.48	40.73	36.06	4.67	54	-13.27	279	139	Average
2493.48	52.12	47.45	4.67	74	-21.88	279	139	Peak
4874	41.35	31.14	10.21	54	-12.65	141	127	Average
4874	47.48	37.27	10.21	74	-26.52	141	127	Peak

Antenna Polarity & Test Distance: Vertical at 3 m

Frequency (MHz)	Emission Level (dBuV/m)	Read Level (dBuV)	Factor (dB/m)	Limit (dBuV/m)	Margin (dB)	Antenna Height (cm)	Table Angle (Degree)	Remark
2381.82	40.17	35.7	4.47	54	-13.83	211	360	Average
2381.82	50.96	46.49	4.47	74	-23.04	211	360	Peak
2437	95.62	91.03	4.59			211	360	Average
2437	98.78	94.19	4.59			211	360	Peak
2491.88	40.78	36.11	4.67	54	-13.22	211	360	Average
2491.88	52.1	47.43	4.67	74	-21.9	211	360	Peak
4874	42.54	32.33	10.21	54	-11.46	104	131	Average
4874	48.87	38.66	10.21	74	-25.13	104	131	Peak

Remarks:

- Emission Level = Read Level + Factor
Margin value = Emission level – Limit value
- 2437 MHz: Fundamental frequency.
- The emission levels of other frequencies were very low against the limit.

EUT Test Condition		Measurement Detail	
Channel	Channel 11	Frequency Range	1 GHz ~ 25 GHz
Input Power	120 Vac, 60 Hz	Detector Function	Peak (PK) Average (AV)
Environmental Conditions	25 deg. C, 65 % RH	Tested By	Karl Lee

Horizontal

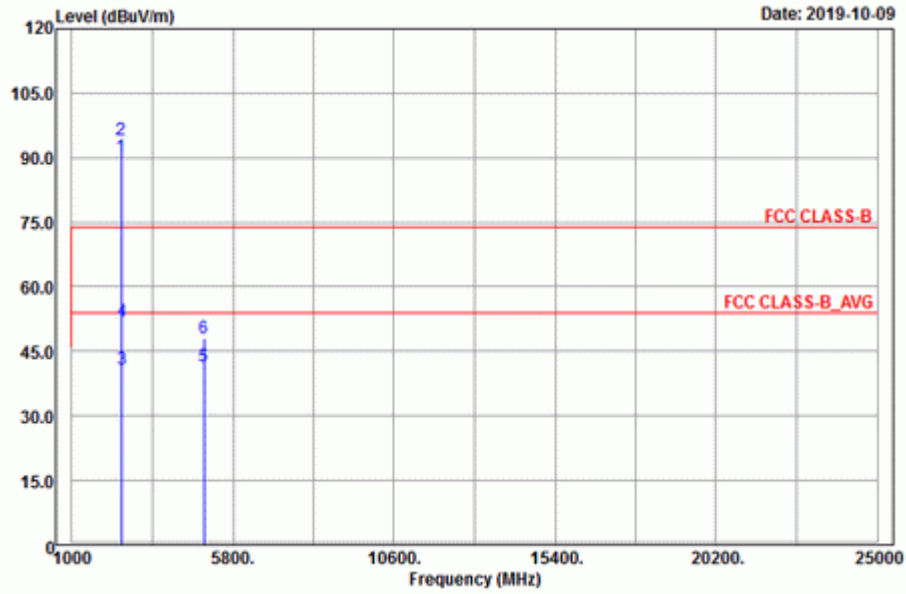

Vertical

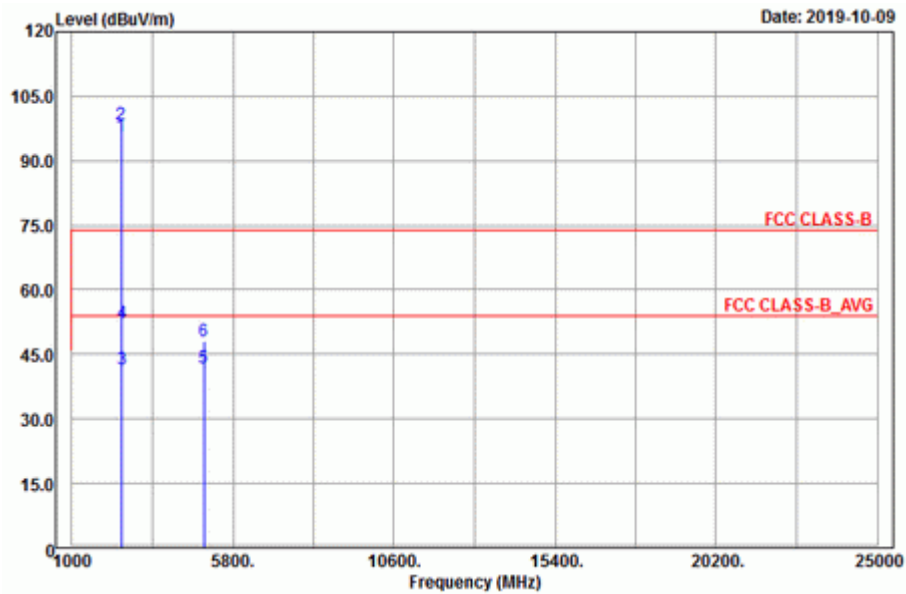

Antenna Polarity & Test Distance: Horizontal at 3 m

Frequency (MHz)	Emission Level (dBuV/m)	Read Level (dBuV)	Factor (dB/m)	Limit (dBuV/m)	Margin (dB)	Antenna Height (cm)	Table Angle (Degree)	Remark
2462	90.32	85.7	4.62			280	139	Average
2462	94.22	89.6	4.62			280	139	Peak
2495.44	40.71	36.04	4.67	54	-13.29	280	139	Average
2495.44	51.89	47.22	4.67	74	-22.11	280	139	Peak
4924	41.62	31.37	10.25	54	-12.38	148	110	Average
4924	47.92	37.67	10.25	74	-26.08	148	110	Peak

Antenna Polarity & Test Distance: Vertical at 3 m

Frequency (MHz)	Emission Level (dBuV/m)	Read Level (dBuV)	Factor (dB/m)	Limit (dBuV/m)	Margin (dB)	Antenna Height (cm)	Table Angle (Degree)	Remark
2462	95.65	91.03	4.62			211	360	Average
2462	98.38	93.76	4.62			211	360	Peak
2483.64	41.44	36.78	4.66	54	-12.56	211	360	Average
2483.64	52.24	47.58	4.66	74	-21.76	211	360	Peak
4924	41.89	31.64	10.25	54	-12.11	106	128	Average
4924	48.11	37.86	10.25	74	-25.89	106	128	Peak

Remarks:

- Emission Level = Read Level + Factor
Margin value = Emission level – Limit value
- 2462 MHz: Fundamental frequency.
- The emission levels of other frequencies were very low against the limit.

EUT Test Condition		Measurement Detail	
Channel	Channel 12	Frequency Range	1 GHz ~ 25 GHz
Input Power	120 Vac, 60 Hz	Detector Function	Peak (PK) Average (AV)
Environmental Conditions	25 deg. C, 65 % RH	Tested By	Karl Lee

Horizontal

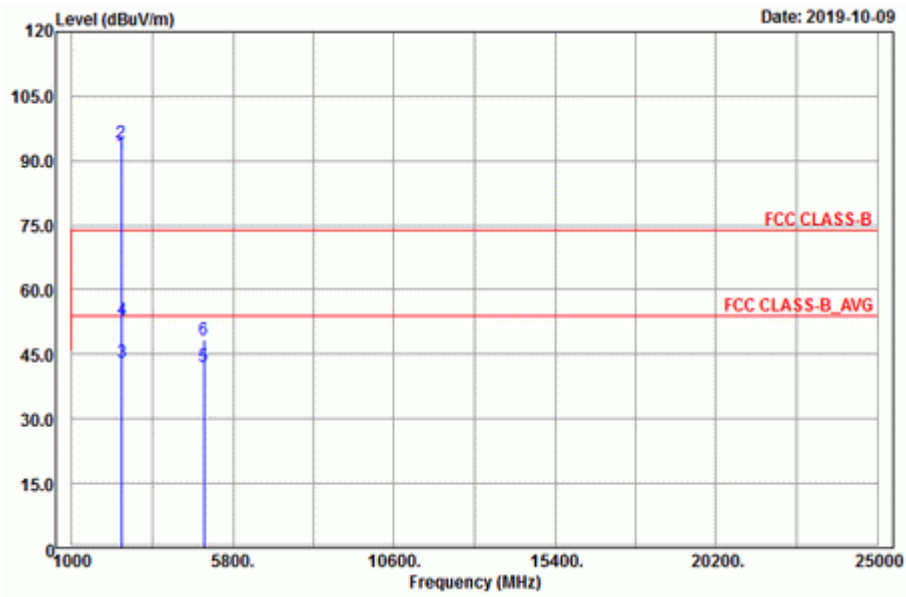

Vertical

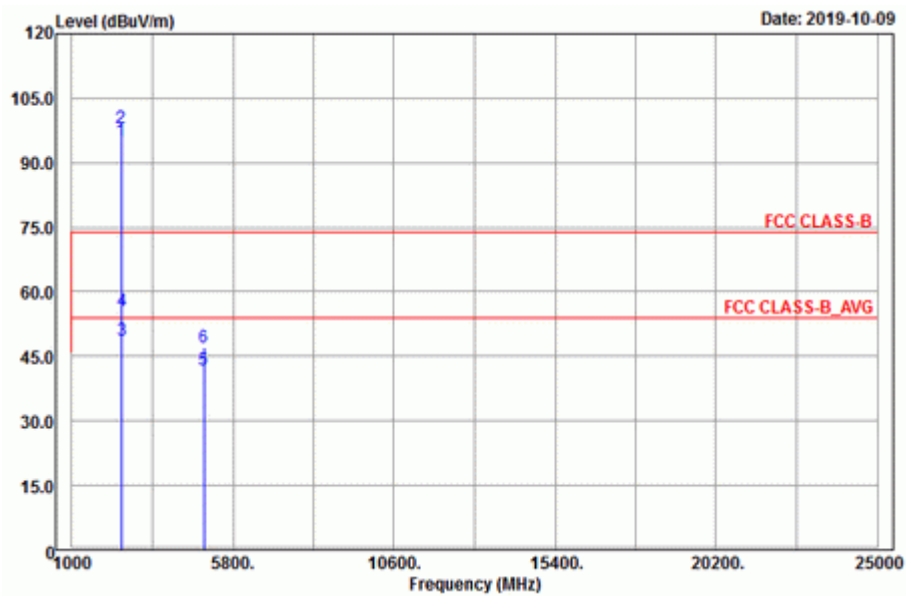

Antenna Polarity & Test Distance: Horizontal at 3 m

Frequency (MHz)	Emission Level (dBuV/m)	Read Level (dBuV)	Factor (dB/m)	Limit (dBuV/m)	Margin (dB)	Antenna Height (cm)	Table Angle (Degree)	Remark
2467	91.57	86.94	4.63			280	139	Average
2467	94.03	89.4	4.63			280	139	Peak
2484.44	43.2	38.54	4.66	54	-10.8	280	139	Average
2484.44	52.87	48.21	4.66	74	-21.13	280	139	Peak
4934	42.15	31.89	10.26	54	-11.85	148	55	Average
4934	48.5	38.24	10.26	74	-25.5	148	55	Peak

Antenna Polarity & Test Distance: Vertical at 3 m

Frequency (MHz)	Emission Level (dBuV/m)	Read Level (dBuV)	Factor (dB/m)	Limit (dBuV/m)	Margin (dB)	Antenna Height (cm)	Table Angle (Degree)	Remark
2467	95.19	90.56	4.63			211	360	Average
2467	98.2	93.57	4.63			211	360	Peak
2484.64	48.64	43.98	4.66	54	-5.36	211	360	Average
2484.64	55.49	50.83	4.66	74	-18.51	211	360	Peak
4934	41.81	31.55	10.26	54	-12.19	133	329	Average
4934	47.04	36.78	10.26	74	-26.96	133	329	Peak

Remarks:

- Emission Level = Read Level + Factor
Margin value = Emission level – Limit value
- 2467 MHz: Fundamental frequency.
- The emission levels of other frequencies were very low against the limit.

EUT Test Condition		Measurement Detail	
Channel	Channel 13	Frequency Range	1 GHz ~ 25 GHz
Input Power	120 Vac, 60 Hz	Detector Function	Peak (PK) Average (AV)
Environmental Conditions	25 deg. C, 65 % RH	Tested By	Karl Lee

Horizontal

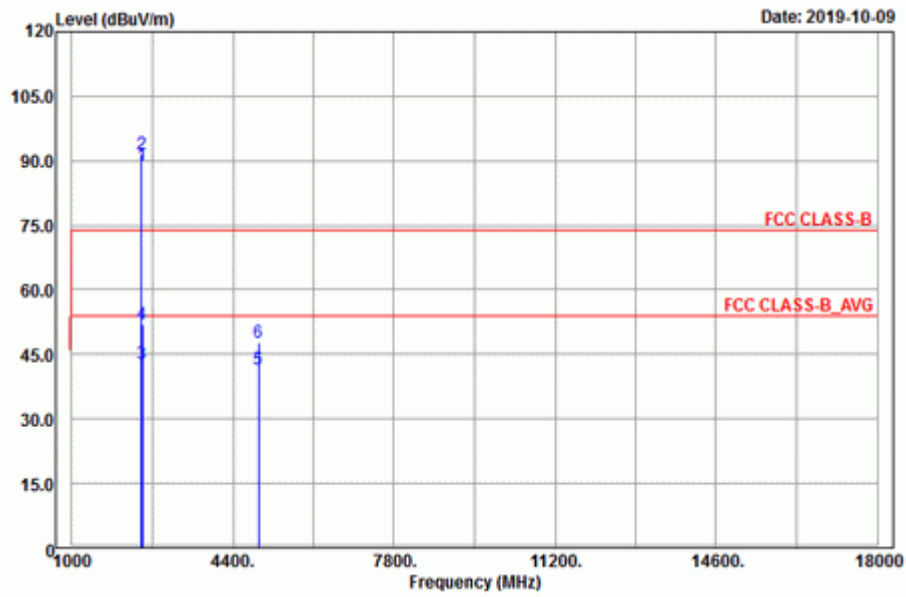

Vertical

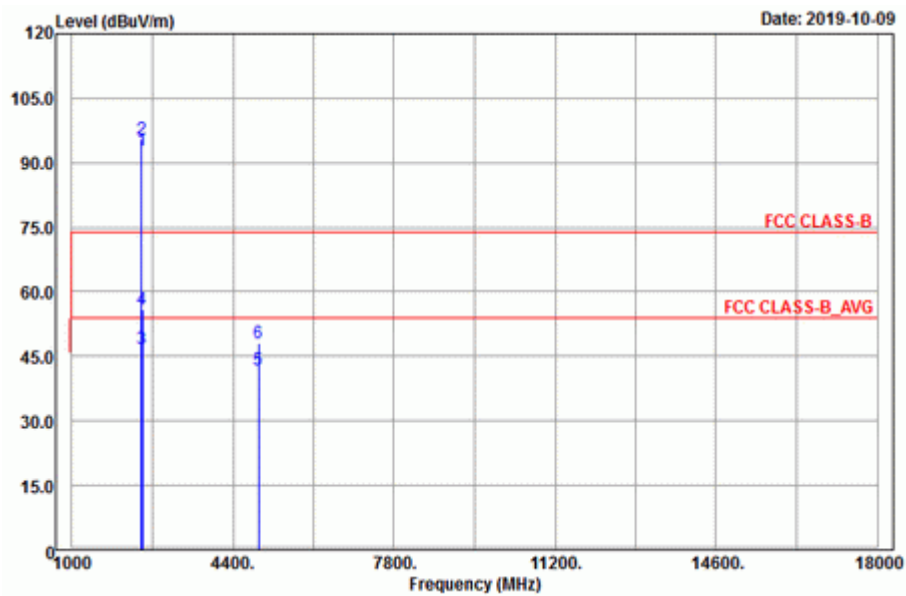

Antenna Polarity & Test Distance: Horizontal at 3 m

Frequency (MHz)	Emission Level (dBuV/m)	Read Level (dBuV)	Factor (dB/m)	Limit (dBuV/m)	Margin (dB)	Antenna Height (cm)	Table Angle (Degree)	Remark
2472	88.79	84.15	4.64			280	158	Average
2472	91.45	86.81	4.64			280	158	Peak
2485.48	42.81	38.15	4.66	54	-11.19	280	158	Average
2485.48	52.06	47.4	4.66	74	-21.94	280	158	Peak
4944	41.63	31.28	10.35	54	-12.37	109	325	Average
4944	47.85	37.5	10.35	74	-26.15	109	325	Peak

Antenna Polarity & Test Distance: Vertical at 3 m

Frequency (MHz)	Emission Level (dBuV/m)	Read Level (dBuV)	Factor (dB/m)	Limit (dBuV/m)	Margin (dB)	Antenna Height (cm)	Table Angle (Degree)	Remark
2472	92.78	88.14	4.64			190	357	Average
2472	95.45	90.81	4.64			190	357	Peak
2486.72	46.6	41.94	4.66	54	-7.4	190	357	Average
2486.72	55.84	51.18	4.66	74	-18.16	190	357	Peak
4944	42.01	31.66	10.35	54	-11.99	146	115	Average
4944	48.21	37.86	10.35	74	-25.79	146	115	Peak

Remarks:

- Emission Level = Read Level + Factor
Margin value = Emission level – Limit value
- 2472 MHz: Fundamental frequency.
- The emission levels of other frequencies were very low against the limit.

802.11g

EUT Test Condition		Measurement Detail	
Channel	Channel 1	Frequency Range	1 GHz ~ 25 GHz
Input Power	120 Vac, 60 Hz	Detector Function	Peak (PK) Average (AV)
Environmental Conditions	25 deg. C, 65 % RH	Tested By	Karl Lee

Horizontal

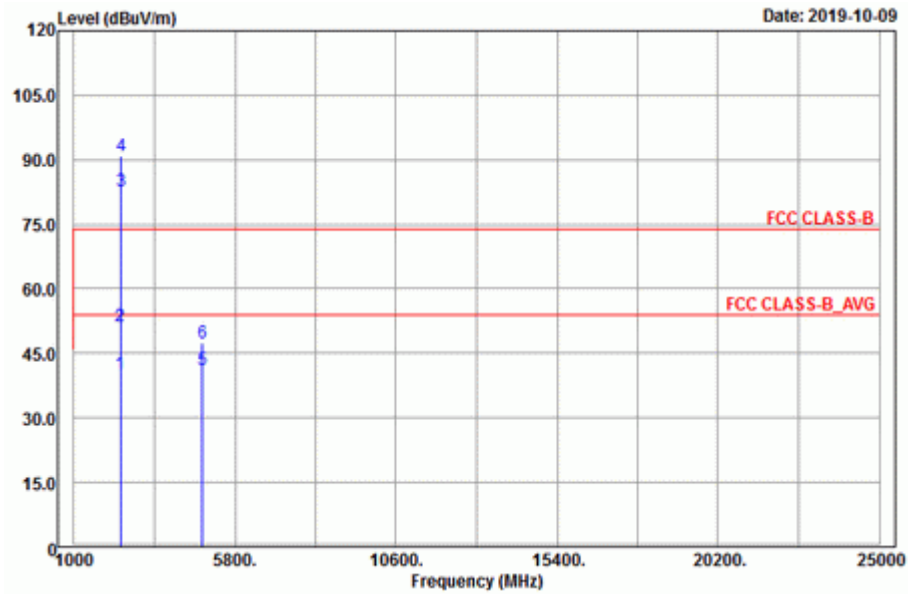

Vertical

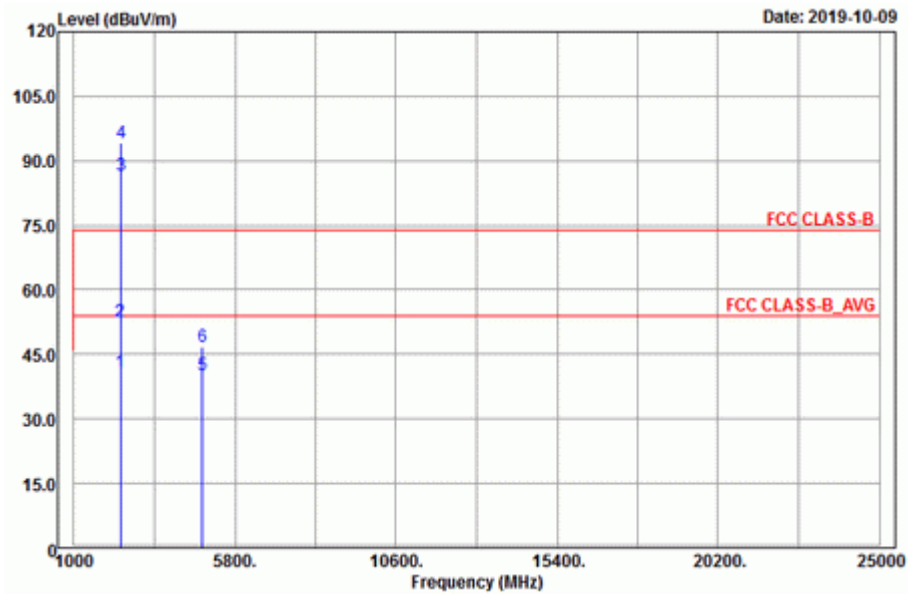

Antenna Polarity & Test Distance: Horizontal at 3 m

Frequency (MHz)	Emission Level (dBuV/m)	Read Level (dBuV)	Factor (dB/m)	Limit (dBuV/m)	Margin (dB)	Antenna Height (cm)	Table Angle (Degree)	Remark
2379.75	40.25	35.78	4.47	54	-13.75	280	139	Average
2379.75	51.42	46.95	4.47	74	-22.58	280	139	Peak
2412	82.57	78.02	4.55			280	139	Average
2412	90.81	86.26	4.55			280	139	Peak
4824	41.17	30.88	10.29	54	-12.83	190	264	Average
4824	47.54	37.25	10.29	74	-26.46	190	264	Peak

Antenna Polarity & Test Distance: Vertical at 3 m

Frequency (MHz)	Emission Level (dBuV/m)	Read Level (dBuV)	Factor (dB/m)	Limit (dBuV/m)	Margin (dB)	Antenna Height (cm)	Table Angle (Degree)	Remark
2389.38	40.87	36.38	4.49	54	-13.13	211	360	Average
2389.38	52.67	48.18	4.49	74	-21.33	211	360	Peak
2412	86.57	82.02	4.55			211	360	Average
2412	94.16	89.61	4.55			211	360	Peak
4824	40.36	30.07	10.29	54	-13.64	104	187	Average
4824	46.75	36.46	10.29	74	-27.25	104	187	Peak

Remarks:

- Emission Level = Read Level + Factor
Margin value = Emission level – Limit value
- 2412 MHz: Fundamental frequency.
- The emission levels of other frequencies were very low against the limit.

EUT Test Condition		Measurement Detail	
Channel	Channel 6	Frequency Range	1 GHz ~ 25 GHz
Input Power	120 Vac, 60 Hz	Detector Function	Peak (PK) Average (AV)
Environmental Conditions	25 deg. C, 65 % RH	Tested By	Karl Lee

Horizontal

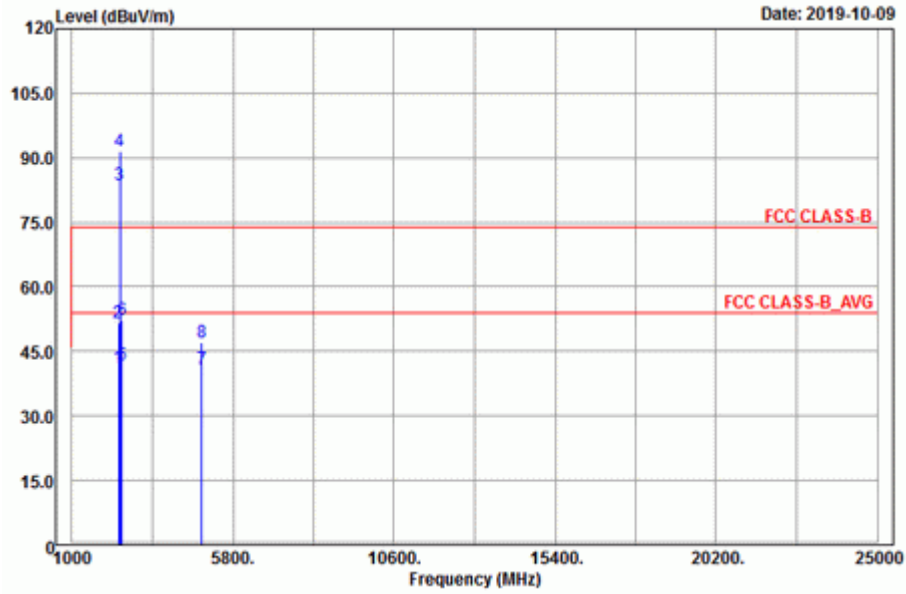

Vertical

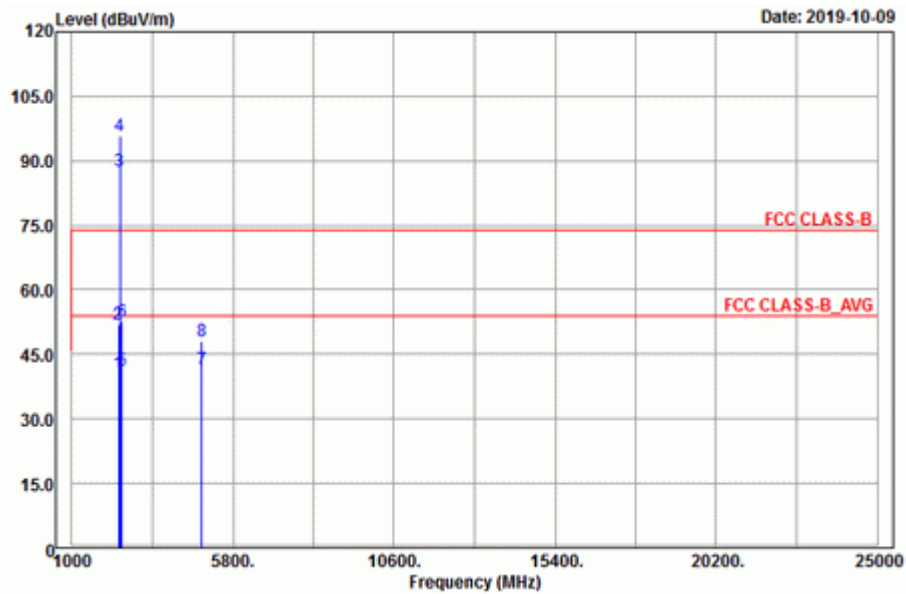

Antenna Polarity & Test Distance: Horizontal at 3 m

Frequency (MHz)	Emission Level (dBuV/m)	Read Level (dBuV)	Factor (dB/m)	Limit (dBuV/m)	Margin (dB)	Antenna Height (cm)	Table Angle (Degree)	Remark
2388.39	41.17	36.68	4.49	54	-12.83	280	136	Average
2388.39	51.57	47.08	4.49	74	-22.43	280	136	Peak
2437	83.64	79.05	4.59			280	136	Average
2437	91.43	86.84	4.59			280	136	Peak
2489.16	41.79	37.11	4.68	54	-12.21	280	136	Average
2489.16	52.24	47.56	4.68	74	-21.76	280	136	Peak
4874	40.92	30.71	10.21	54	-13.08	150	63	Average
4874	47.09	36.88	10.21	74	-26.91	150	63	Peak

Antenna Polarity & Test Distance: Vertical at 3 m

Frequency (MHz)	Emission Level (dBuV/m)	Read Level (dBuV)	Factor (dB/m)	Limit (dBuV/m)	Margin (dB)	Antenna Height (cm)	Table Angle (Degree)	Remark
2385.15	40.5	36.03	4.47	54	-13.5	148	6	Average
2385.15	52.05	47.58	4.47	74	-21.95	148	6	Peak
2437	87.63	83.04	4.59			148	6	Average
2437	95.89	91.3	4.59			148	6	Peak
2488.28	41.34	36.66	4.68	54	-12.66	148	6	Average
2488.28	52.68	48	4.68	74	-21.32	148	6	Peak
4874	41.68	31.47	10.21	54	-12.32	150	174	Average
4874	47.93	37.72	10.21	74	-26.07	150	174	Peak

Remarks:

- Emission Level = Read Level + Factor
Margin value = Emission level – Limit value
- 2437 MHz: Fundamental frequency.
- The emission levels of other frequencies were very low against the limit.

EUT Test Condition		Measurement Detail	
Channel	Channel 11	Frequency Range	1 GHz ~ 25 GHz
Input Power	120 Vac, 60 Hz	Detector Function	Peak (PK) Average (AV)
Environmental Conditions	25 deg. C, 65 % RH	Tested By	Karl Lee

Horizontal

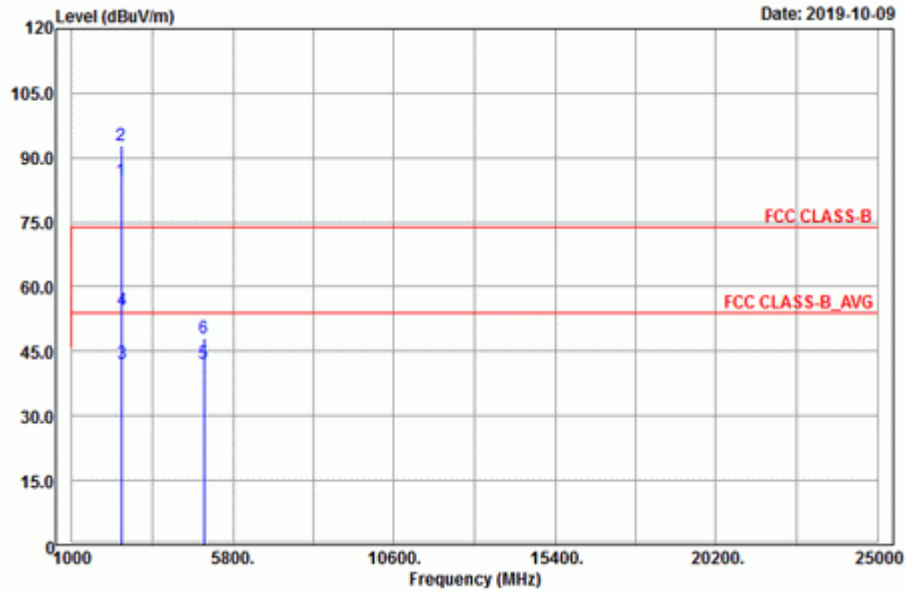

Vertical

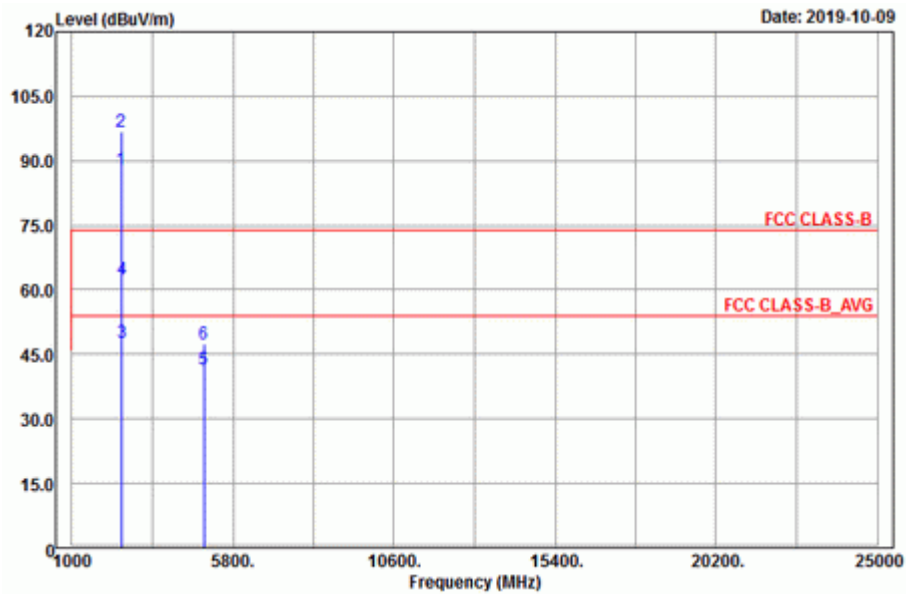

Antenna Polarity & Test Distance: Horizontal at 3 m

Frequency (MHz)	Emission Level (dBuV/m)	Read Level (dBuV)	Factor (dB/m)	Limit (dBuV/m)	Margin (dB)	Antenna Height (cm)	Table Angle (Degree)	Remark
2462	84.56	79.94	4.62			280	136	Average
2462	92.79	88.17	4.62			280	136	Peak
2483.84	42.09	37.43	4.66	54	-11.91	280	136	Average
2483.84	54.63	49.97	4.66	74	-19.37	280	136	Peak
4924	42.03	31.78	10.25	54	-11.97	100	360	Average
4924	48.12	37.87	10.25	74	-25.88	100	360	Peak

Antenna Polarity & Test Distance: Vertical at 3 m

Frequency (MHz)	Emission Level (dBuV/m)	Read Level (dBuV)	Factor (dB/m)	Limit (dBuV/m)	Margin (dB)	Antenna Height (cm)	Table Angle (Degree)	Remark
2462	87.79	83.17	4.62			148	6	Average
2462	96.65	92.03	4.62			148	6	Peak
2483.52	47.85	43.19	4.66	54	-6.15	148	6	Average
2483.52	62.44	57.78	4.66	74	-11.56	148	6	Peak
4924	41.37	31.12	10.25	54	-12.63	136	154	Average
4924	47.56	37.31	10.25	74	-26.44	136	154	Peak

Remarks:

- Emission Level = Read Level + Factor
Margin value = Emission level – Limit value
- 2462 MHz: Fundamental frequency.
- The emission levels of other frequencies were very low against the limit.

EUT Test Condition		Measurement Detail	
Channel	Channel 12	Frequency Range	1 GHz ~ 25 GHz
Input Power	120 Vac, 60 Hz	Detector Function	Peak (PK) Average (AV)
Environmental Conditions	25 deg. C, 65 % RH	Tested By	Karl Lee

Horizontal

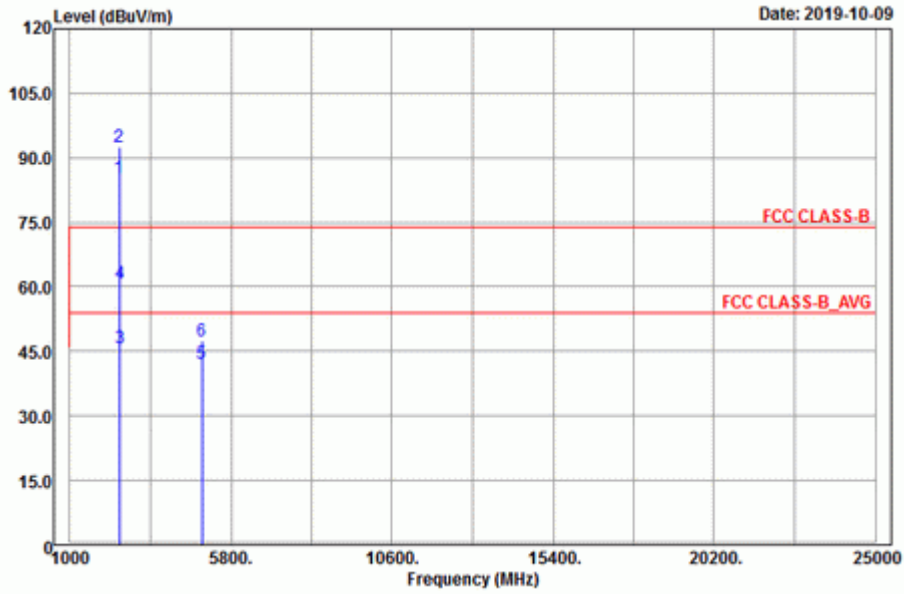

Vertical

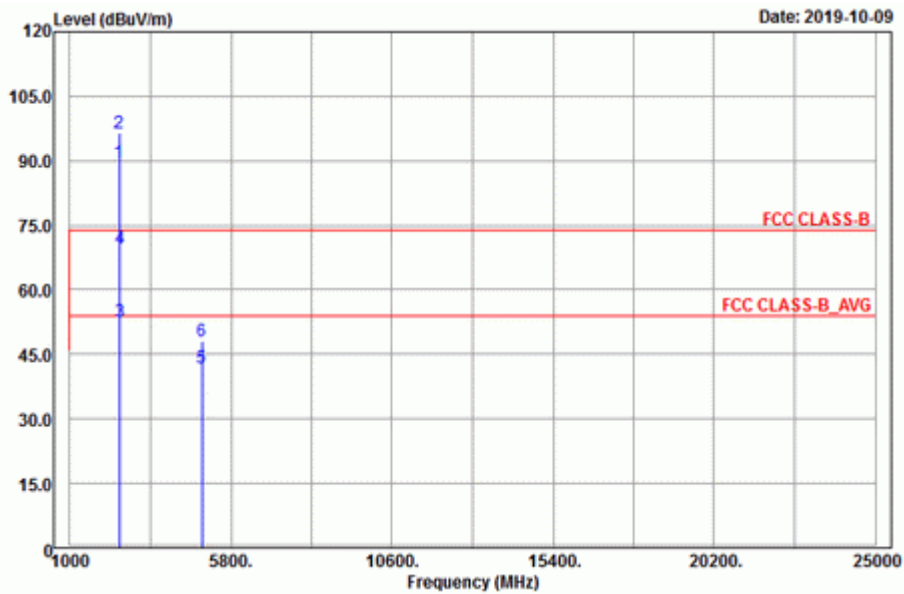

Antenna Polarity & Test Distance: Horizontal at 3 m

Frequency (MHz)	Emission Level (dBuV/m)	Read Level (dBuV)	Factor (dB/m)	Limit (dBuV/m)	Margin (dB)	Antenna Height (cm)	Table Angle (Degree)	Remark
2467	85.28	80.65	4.63			280	136	Average
2467	92.58	87.95	4.63			280	136	Peak
2483.64	45.77	41.11	4.66	54	-8.23	280	136	Average
2483.64	60.9	56.24	4.66	74	-13.1	280	136	Peak
4934	42.04	31.78	10.26	54	-11.96	145	1	Average
4934	47.28	37.02	10.26	74	-26.72	145	1	Peak

Antenna Polarity & Test Distance: Vertical at 3 m

Frequency (MHz)	Emission Level (dBuV/m)	Read Level (dBuV)	Factor (dB/m)	Limit (dBuV/m)	Margin (dB)	Antenna Height (cm)	Table Angle (Degree)	Remark
2467	89.71	85.08	4.63			148	6	Average
2467	96.36	91.73	4.63			148	6	Peak
2483.72	52.77	48.11	4.66	54	-1.23	148	6	Average
2483.72	69.61	64.95	4.66	74	-4.39	148	6	Peak
4934	41.85	31.59	10.26	54	-12.15	132	178	Average
4934	48.09	37.83	10.26	74	-25.91	132	178	Peak

Remarks:

- Emission Level = Read Level + Factor
Margin value = Emission level – Limit value
- 2467 MHz: Fundamental frequency.
- The emission levels of other frequencies were very low against the limit.

EUT Test Condition		Measurement Detail	
Channel	Channel 13	Frequency Range	1 GHz ~ 25 GHz
Input Power	120 Vac, 60 Hz	Detector Function	Peak (PK) Average (AV)
Environmental Conditions	25 deg. C, 65 % RH	Tested By	Karl Lee

Horizontal

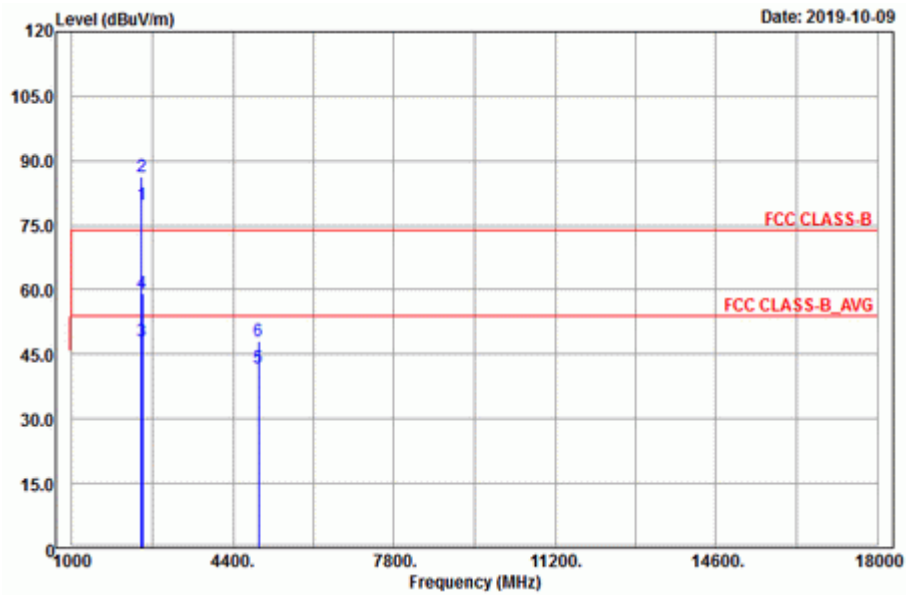

Vertical

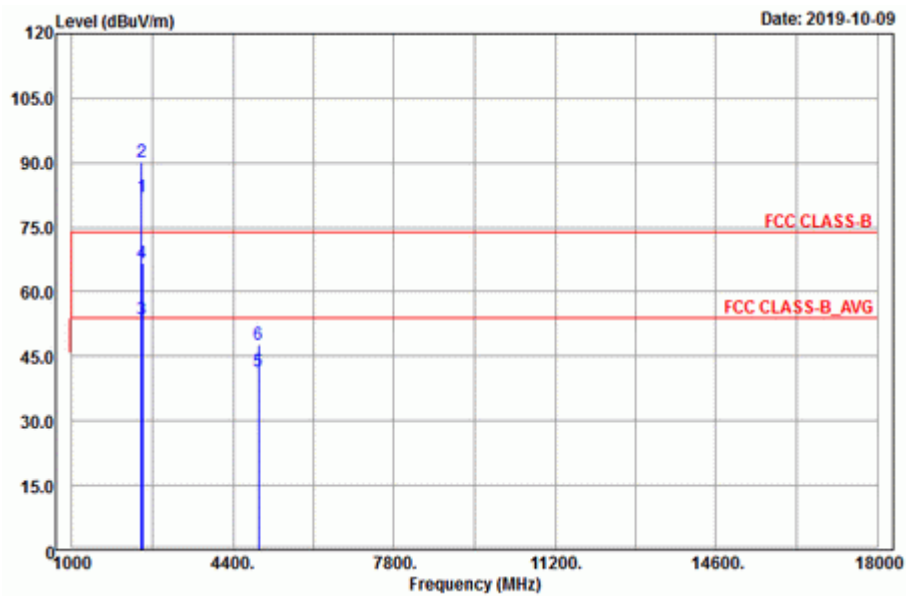

Antenna Polarity & Test Distance: Horizontal at 3 m

Frequency (MHz)	Emission Level (dBuV/m)	Read Level (dBuV)	Factor (dB/m)	Limit (dBuV/m)	Margin (dB)	Antenna Height (cm)	Table Angle (Degree)	Remark
2472	79.65	75.01	4.64			280	158	Average
2472	86.4	81.76	4.64			280	158	Peak
2483.52	48.05	43.39	4.66	54	-5.95	280	158	Average
2483.52	59.3	54.64	4.66	74	-14.7	280	158	Peak
4944	41.96	31.61	10.35	54	-12.04	131	26	Average
4944	48.15	37.8	10.35	74	-25.85	131	26	Peak

Antenna Polarity & Test Distance: Vertical at 3 m

Frequency (MHz)	Emission Level (dBuV/m)	Read Level (dBuV)	Factor (dB/m)	Limit (dBuV/m)	Margin (dB)	Antenna Height (cm)	Table Angle (Degree)	Remark
2472	82.15	77.51	4.64			101	359	Average
2472	90.33	85.69	4.64			101	359	Peak
2483.52	53.49	48.83	4.66	54	-0.51	101	359	Average
2483.52	66.63	61.97	4.66	74	-7.37	101	359	Peak
4944	41.48	31.13	10.35	54	-12.52	152	173	Average
4944	47.87	37.52	10.35	74	-26.13	152	173	Peak

Remarks:

- Emission Level = Read Level + Factor
Margin value = Emission level – Limit value
- 2472 MHz: Fundamental frequency.
- The emission levels of other frequencies were very low against the limit.

802.11n (HT20)

EUT Test Condition		Measurement Detail	
Channel	Channel 1	Frequency Range	1 GHz ~ 25 GHz
Input Power	120 Vac, 60 Hz	Detector Function	Peak (PK) Average (AV)
Environmental Conditions	25 deg. C, 65 % RH	Tested By	Karl Lee

Horizontal

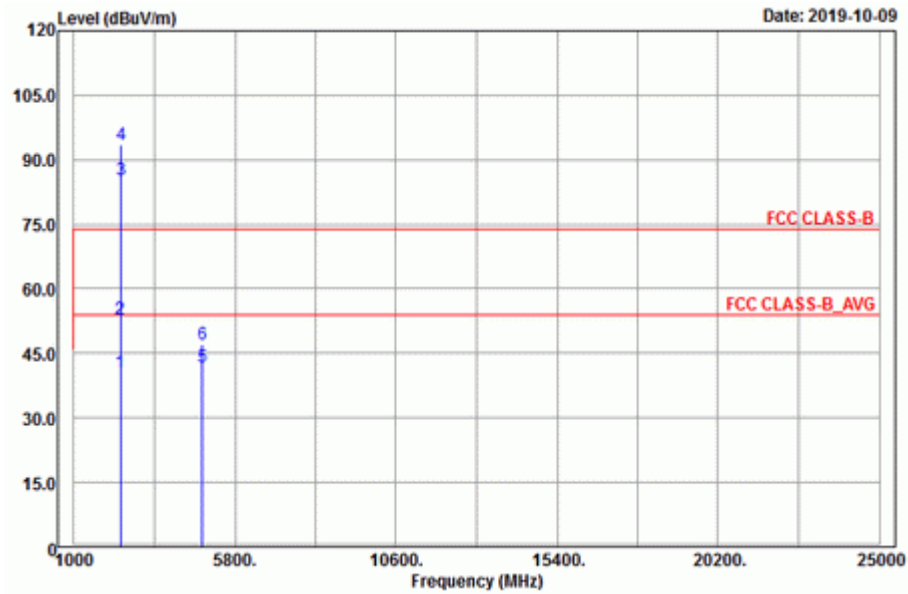

Vertical

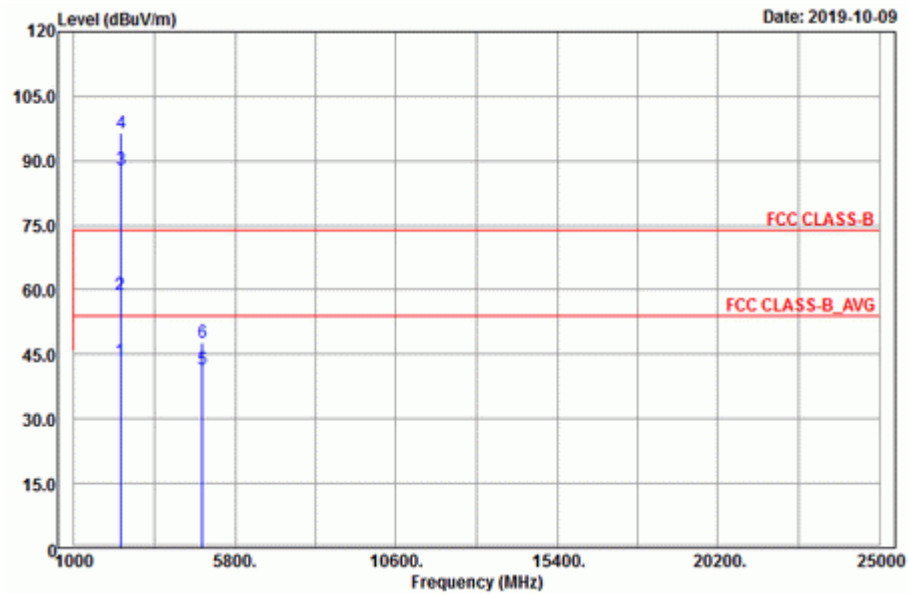

Antenna Polarity & Test Distance: Horizontal at 3 m

Frequency (MHz)	Emission Level (dBuV/m)	Read Level (dBuV)	Factor (dB/m)	Limit (dBuV/m)	Margin (dB)	Antenna Height (cm)	Table Angle (Degree)	Remark
2389.92	40.68	36.18	4.5	54	-13.32	280	136	Average
2389.92	52.83	48.33	4.5	74	-21.17	280	136	Peak
2412	85.21	80.66	4.55			280	136	Average
2412	93.58	89.03	4.55			280	136	Peak
4824	41.75	31.46	10.29	54	-12.25	113	325	Average
4824	46.97	36.68	10.29	74	-27.03	113	325	Peak

Antenna Polarity & Test Distance: Vertical at 3 m

Frequency (MHz)	Emission Level (dBuV/m)	Read Level (dBuV)	Factor (dB/m)	Limit (dBuV/m)	Margin (dB)	Antenna Height (cm)	Table Angle (Degree)	Remark
2389.83	43.34	38.84	4.5	54	-10.66	148	6	Average
2389.83	58.74	54.24	4.5	74	-15.26	148	6	Peak
2412	88	83.45	4.55			148	6	Average
2412	96.43	91.88	4.55			148	6	Peak
4824	41.55	31.26	10.29	54	-12.45	113	324	Average
4824	47.76	37.47	10.29	74	-26.24	113	324	Peak

Remarks:

- Emission Level = Read Level + Factor
Margin value = Emission level – Limit value
- 2412 MHz: Fundamental frequency.
- The emission levels of other frequencies were very low against the limit.

EUT Test Condition		Measurement Detail	
Channel	Channel 6	Frequency Range	1 GHz ~ 25 GHz
Input Power	120 Vac, 60 Hz	Detector Function	Peak (PK) Average (AV)
Environmental Conditions	25 deg. C, 65 % RH	Tested By	Karl Lee

Horizontal

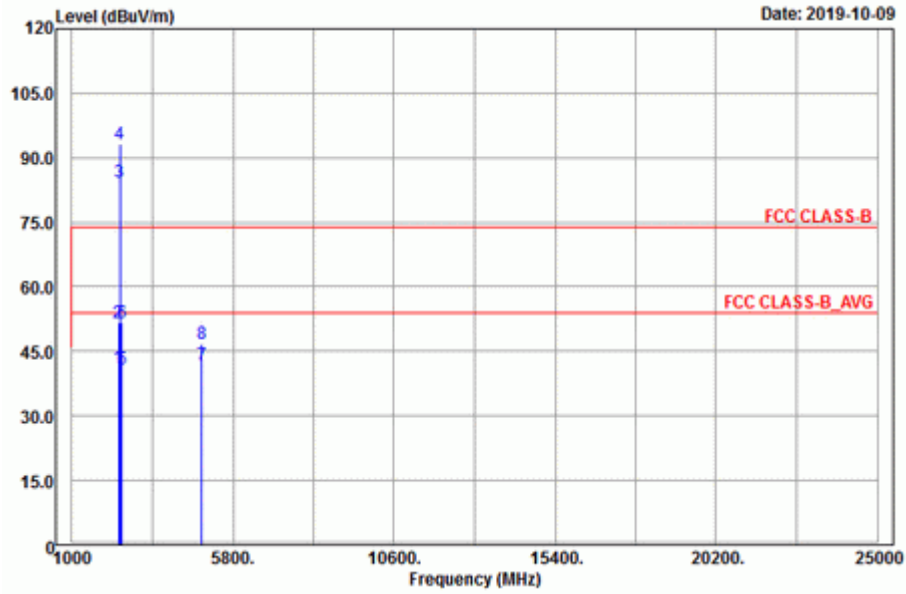

Vertical

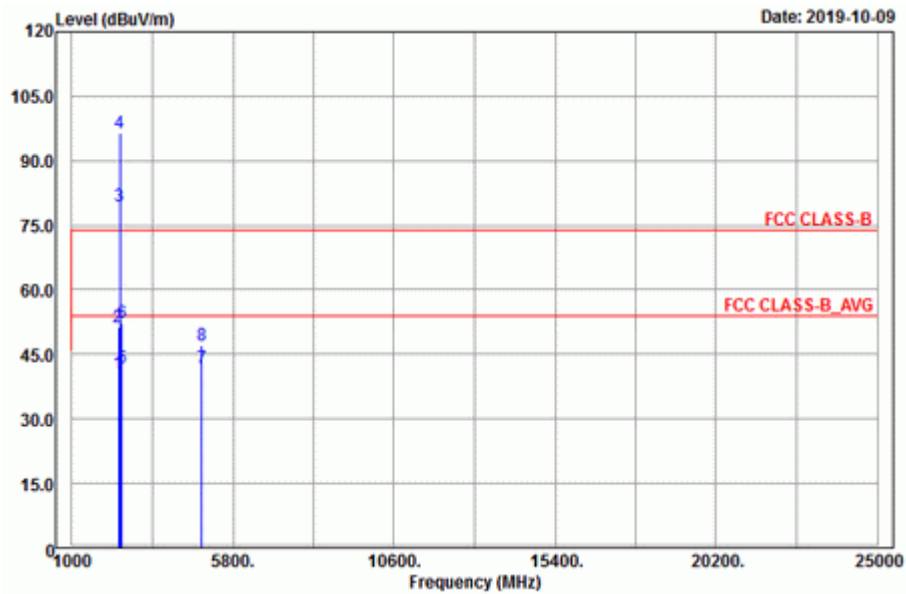

Antenna Polarity & Test Distance: Horizontal at 3 m

Frequency (MHz)	Emission Level (dBuV/m)	Read Level (dBuV)	Factor (dB/m)	Limit (dBuV/m)	Margin (dB)	Antenna Height (cm)	Table Angle (Degree)	Remark
2385.78	41.08	36.59	4.49	54	-12.92	280	136	Average
2385.78	51.67	47.18	4.49	74	-22.33	280	136	Peak
2437	84.31	79.72	4.59			280	136	Average
2437	93.28	88.69	4.59			280	136	Peak
2489.04	40.8	36.12	4.68	54	-13.2	280	136	Average
2489.04	51.67	46.99	4.68	74	-22.33	280	136	Peak
4874	41.76	31.55	10.21	54	-12.24	174	159	Average
4874	46.69	36.48	10.21	74	-27.31	174	159	Peak

Antenna Polarity & Test Distance: Vertical at 3 m

Frequency (MHz)	Emission Level (dBuV/m)	Read Level (dBuV)	Factor (dB/m)	Limit (dBuV/m)	Margin (dB)	Antenna Height (cm)	Table Angle (Degree)	Remark
2385.6	40.62	36.13	4.49	54	-13.38	148	6	Average
2385.6	51.24	46.75	4.49	74	-22.76	148	6	Peak
2437	79.31	74.72	4.59			148	6	Average
2437	96.6	92.01	4.59			148	6	Peak
2488.6	41.81	37.13	4.68	54	-12.19	148	6	Average
2488.6	52.22	47.54	4.68	74	-21.78	148	6	Peak
4874	41.77	31.56	10.21	54	-12.23	133	325	Average
4874	47.07	36.86	10.21	74	-26.93	133	325	Peak

Remarks:

- Emission Level = Read Level + Factor
Margin value = Emission level – Limit value
- 2437 MHz: Fundamental frequency.
- The emission levels of other frequencies were very low against the limit.

EUT Test Condition		Measurement Detail	
Channel	Channel 11	Frequency Range	1 GHz ~ 25 GHz
Input Power	120 Vac, 60 Hz	Detector Function	Peak (PK) Average (AV)
Environmental Conditions	25 deg. C, 65 % RH	Tested By	Karl Lee

Horizontal

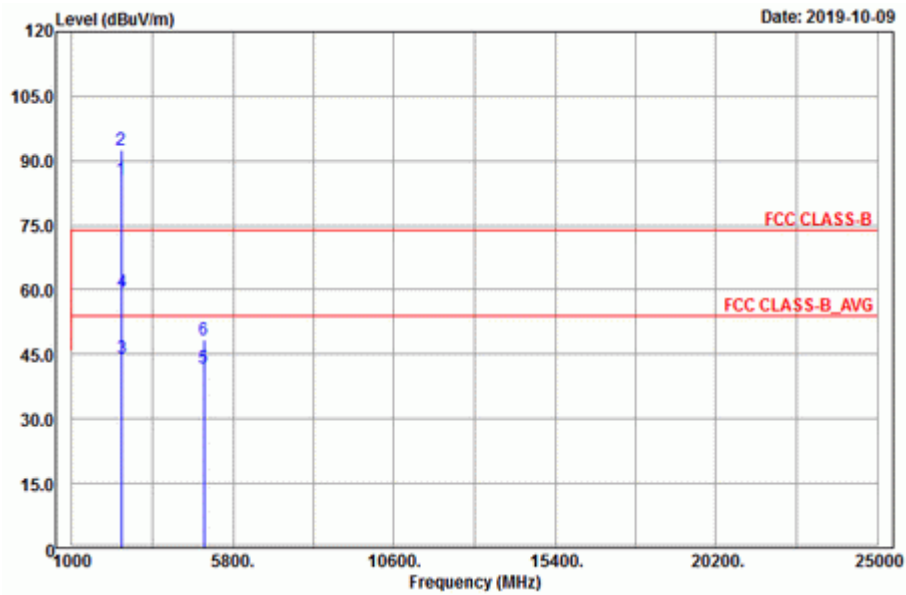

Vertical

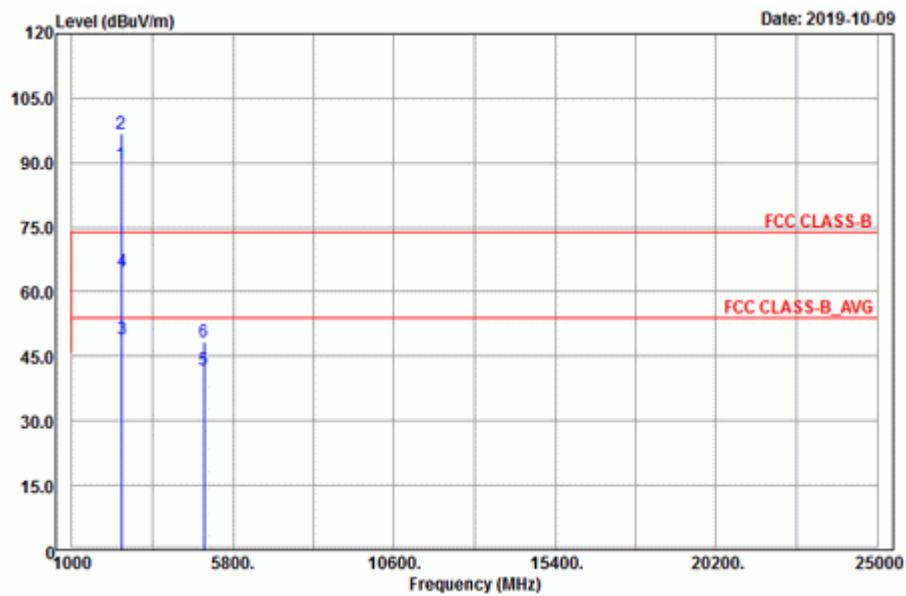

Antenna Polarity & Test Distance: Horizontal at 3 m

Frequency (MHz)	Emission Level (dBuV/m)	Read Level (dBuV)	Factor (dB/m)	Limit (dBuV/m)	Margin (dB)	Antenna Height (cm)	Table Angle (Degree)	Remark
2462	85.61	80.99	4.62			230	136	Average
2462	92.66	88.04	4.62			230	136	Peak
2483.56	44.25	39.59	4.66	54	-9.75	230	136	Average
2483.56	59.54	54.88	4.66	74	-14.46	230	136	Peak
4924	41.79	31.54	10.25	54	-12.21	157	222	Average
4924	48.37	38.12	10.25	74	-25.63	157	222	Peak

Antenna Polarity & Test Distance: Vertical at 3 m

Frequency (MHz)	Emission Level (dBuV/m)	Read Level (dBuV)	Factor (dB/m)	Limit (dBuV/m)	Margin (dB)	Antenna Height (cm)	Table Angle (Degree)	Remark
2462	89.44	84.82	4.62			148	6	Average
2462	96.85	92.23	4.62			148	6	Peak
2483.52	48.9	44.24	4.66	54	-5.1	148	6	Average
2483.52	64.69	60.03	4.66	74	-9.31	148	6	Peak
4924	41.81	31.56	10.25	54	-12.19	124	205	Average
4924	48.55	38.3	10.25	74	-25.45	124	205	Peak

Remarks:

- Emission Level = Read Level + Factor
Margin value = Emission level – Limit value
- 2462 MHz: Fundamental frequency.
- The emission levels of other frequencies were very low against the limit.

EUT Test Condition		Measurement Detail	
Channel	Channel 12	Frequency Range	1 GHz ~ 25 GHz
Input Power	120 Vac, 60 Hz	Detector Function	Peak (PK) Average (AV)
Environmental Conditions	25 deg. C, 65 % RH	Tested By	Karl Lee

Horizontal

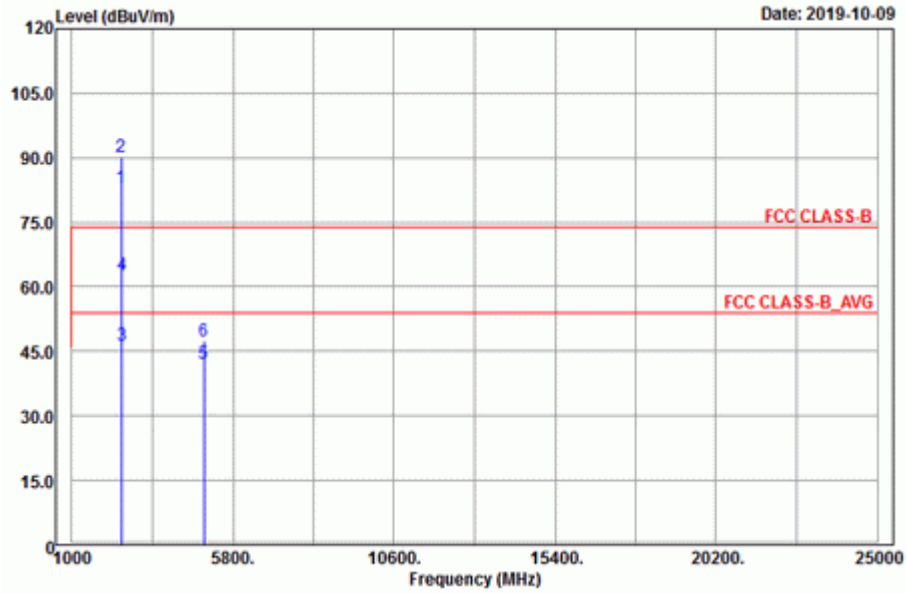

Vertical

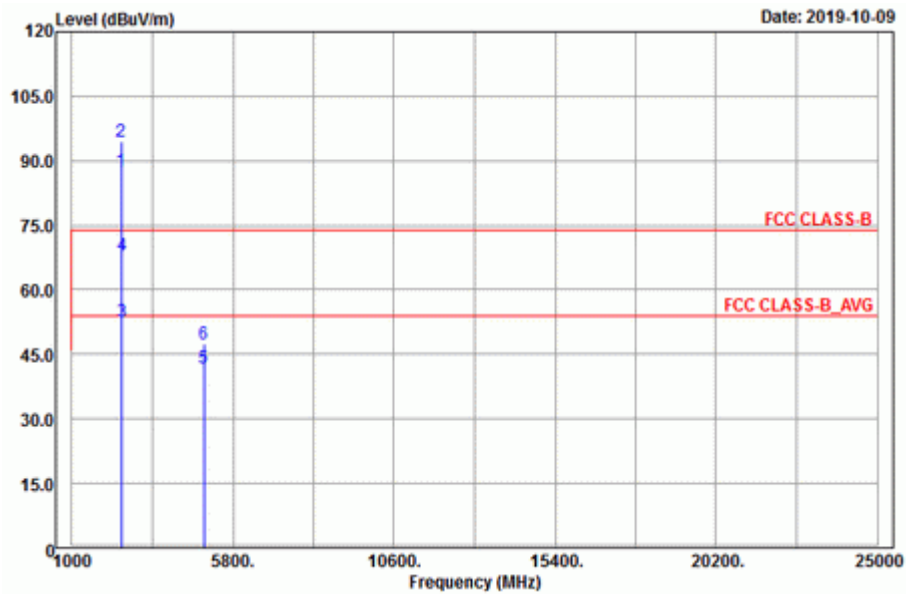

Antenna Polarity & Test Distance: Horizontal at 3 m

Frequency (MHz)	Emission Level (dBuV/m)	Read Level (dBuV)	Factor (dB/m)	Limit (dBuV/m)	Margin (dB)	Antenna Height (cm)	Table Angle (Degree)	Remark
2467	83.11	78.48	4.63			230	136	Average
2467	90.22	85.59	4.63			230	136	Peak
2483.6	46.41	41.75	4.66	54	-7.59	230	136	Average
2483.6	62.91	58.25	4.66	74	-11.09	230	136	Peak
4934	42.11	31.85	10.26	54	-11.89	118	256	Average
4934	47.48	37.22	10.26	74	-26.52	118	256	Peak

Antenna Polarity & Test Distance: Vertical at 3 m

Frequency (MHz)	Emission Level (dBuV/m)	Read Level (dBuV)	Factor (dB/m)	Limit (dBuV/m)	Margin (dB)	Antenna Height (cm)	Table Angle (Degree)	Remark
2467	87.49	82.86	4.63			148	6	Average
2467	94.65	90.02	4.63			148	6	Peak
2483.64	52.56	47.9	4.66	54	-1.44	148	6	Average
2483.64	68.07	63.41	4.66	74	-5.93	148	6	Peak
4934	41.72	31.46	10.26	54	-12.28	147	341	Average
4934	47.3	37.04	10.26	74	-26.7	147	341	Peak

Remarks:

- Emission Level = Read Level + Factor
Margin value = Emission level – Limit value
- 2467 MHz: Fundamental frequency.
- The emission levels of other frequencies were very low against the limit.

EUT Test Condition		Measurement Detail	
Channel	Channel 13	Frequency Range	1 GHz ~ 25 GHz
Input Power	120 Vac, 60 Hz	Detector Function	Peak (PK) Average (AV)
Environmental Conditions	25 deg. C, 65 % RH	Tested By	Karl Lee

Horizontal

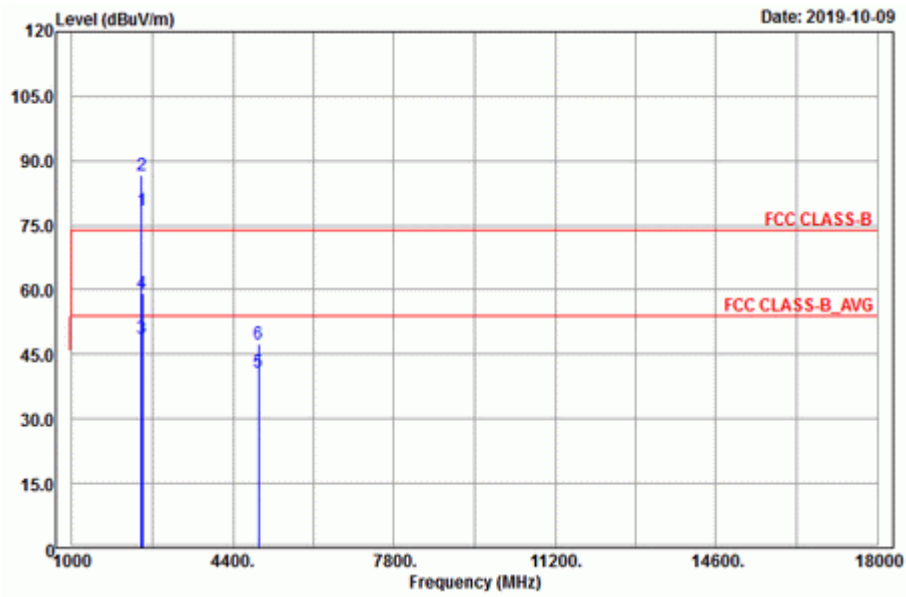

Vertical

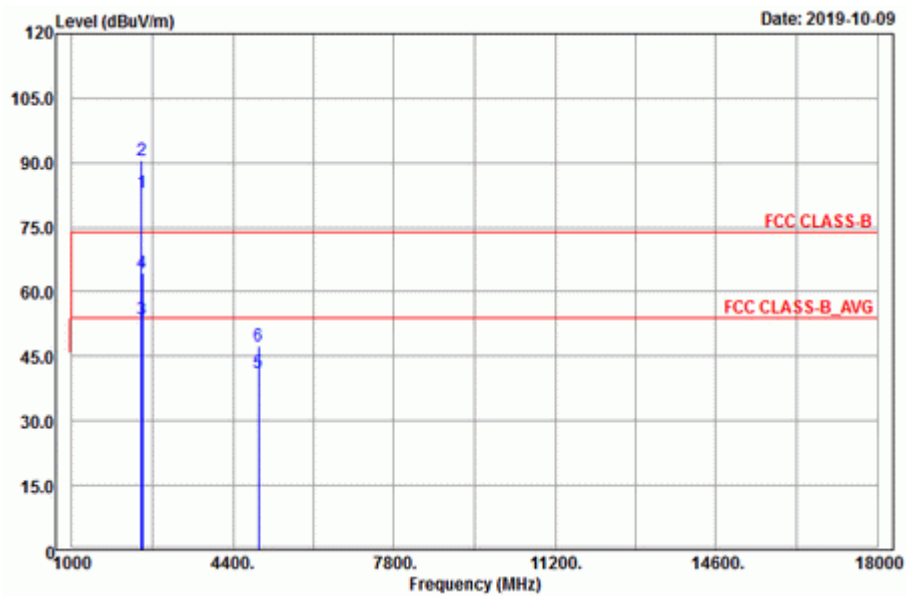

Antenna Polarity & Test Distance: Horizontal at 3 m

Frequency (MHz)	Emission Level (dBuV/m)	Read Level (dBuV)	Factor (dB/m)	Limit (dBuV/m)	Margin (dB)	Antenna Height (cm)	Table Angle (Degree)	Remark
2472	78.48	73.84	4.64			280	158	Average
2472	86.64	82	4.64			280	158	Peak
2483.52	48.71	44.05	4.66	54	-5.29	280	158	Average
2483.52	59.35	54.69	4.66	74	-14.65	280	158	Peak
4944	40.92	30.57	10.35	54	-13.08	152	27	Average
4944	47.55	37.2	10.35	74	-26.45	152	27	Peak

Antenna Polarity & Test Distance: Vertical at 3 m

Frequency (MHz)	Emission Level (dBuV/m)	Read Level (dBuV)	Factor (dB/m)	Limit (dBuV/m)	Margin (dB)	Antenna Height (cm)	Table Angle (Degree)	Remark
2472	83.11	78.47	4.64			101	359	Average
2472	90.72	86.08	4.64			101	359	Peak
2483.52	53.66	49	4.66	54	-0.34	101	359	Average
2483.52	64.57	59.91	4.66	74	-9.43	101	359	Peak
4944	41.3	30.95	10.35	54	-12.7	181	86	Average
4944	47.56	37.21	10.35	74	-26.44	181	86	Peak

Remarks:

- Emission Level = Read Level + Factor
Margin value = Emission level – Limit value
- 2472 MHz: Fundamental frequency.
- The emission levels of other frequencies were very low against the limit.

9 kHz ~ 30 MHz Data:

The amplitude of spurious emissions attenuated more than 20 dB below the permissible value is not required to be report.

30 MHz ~ 1 GHz Worst-Case Data:

802.11n (HT20)

EUT Test Condition		Measurement Detail	
Channel	Channel 13	Frequency Range	30 MHz ~ 1 GHz
Input Power	120 Vac, 60 Hz	Detector Function	Peak (PK) Quasi-peak (QP)
Environmental Conditions	25 deg. C, 65 % RH	Tested By	Karl Lee

Horizontal

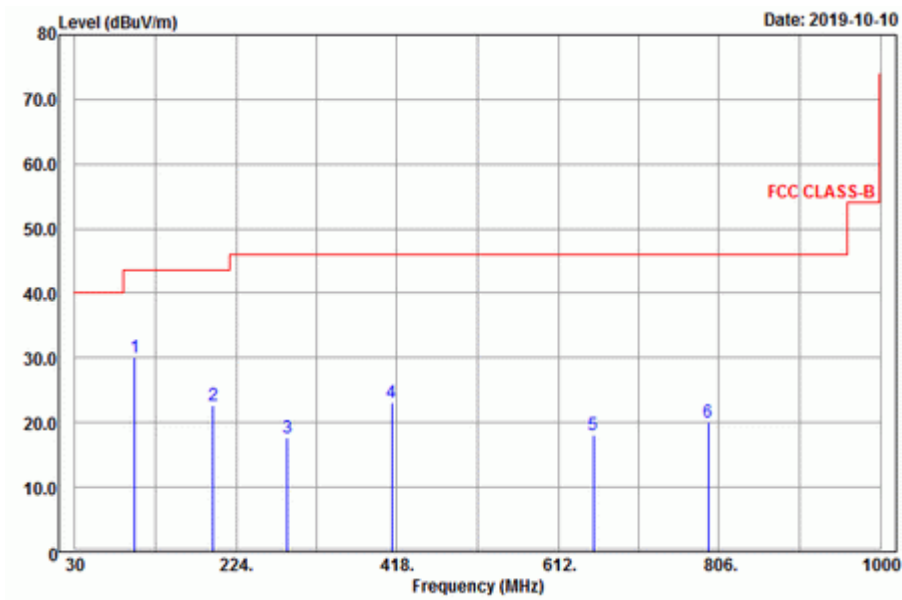

Vertical

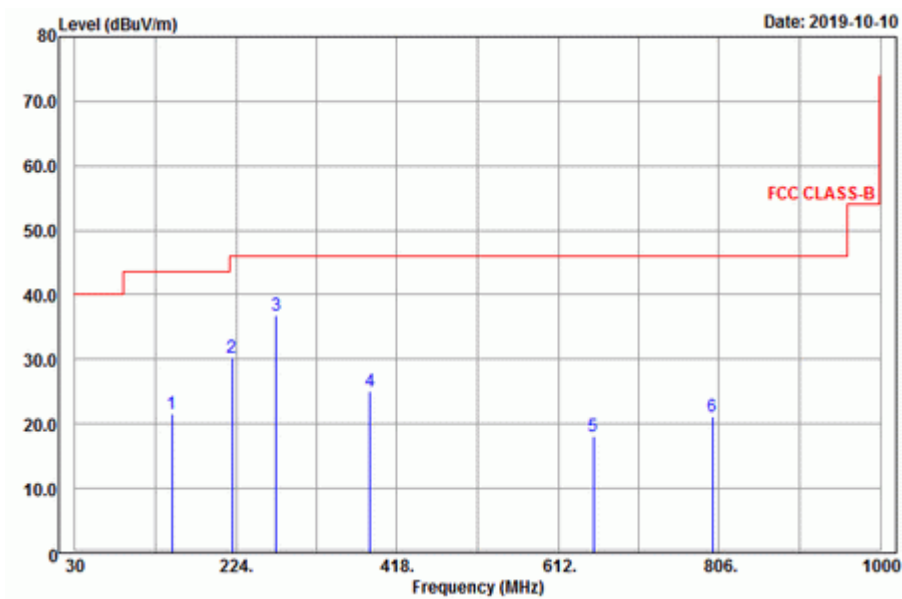

Antenna Polarity & Test Distance: Horizontal at 3 m

Frequency (MHz)	Emission Level (dBuV/m)	Read Level (dBuV)	Factor (dB/m)	Limit (dBuV/m)	Margin (dB)	Antenna Height (cm)	Table Angle (Degree)	Remark
102.36	30.1	47.25	-17.15	43.5	-13.4	126	32	Peak
196.86	22.78	41.11	-18.33	43.5	-20.72	164	225	Peak
286.23	17.74	34	-16.26	46	-28.26	188	195	Peak
412	23.2	36.92	-13.72	46	-22.8	141	145	Peak
654.9	18.09	28.07	-9.98	46	-27.91	105	185	Peak
792.8	20.07	27.87	-7.8	46	-25.93	195	222	Peak

Antenna Polarity & Test Distance: Vertical at 3 m

Frequency (MHz)	Emission Level (dBuV/m)	Read Level (dBuV)	Factor (dB/m)	Limit (dBuV/m)	Margin (dB)	Antenna Height (cm)	Table Angle (Degree)	Remark
146.91	21.5	42.5	-21	43.5	-22	146	215	Peak
219	30.22	48.1	-17.88	46	-15.78	165	6	Peak
272.46	36.8	53.31	-16.51	46	-9.2	127	178	Peak
385.4	25.08	39.25	-14.17	46	-20.92	100	0	Peak
654.9	18.19	28.17	-9.98	46	-27.81	100	0	Peak
798.4	21.21	28.84	-7.63	46	-24.79	100	0	Peak

Remarks:

- Emission Level = Read Level + Factor
Margin value = Emission level – Limit value.
- The emission levels of other frequencies were very low against the limit.

4.5 Conducted Emission Measurement

4.5.1 Limits of Conducted Emission Measurement

Frequency (MHz)	Conducted Limit (dBuV)	
	Quasi-Peak	Average
0.15 - 0.5	66 - 56	56 - 46
0.50 - 5.0	56	46
5.0 - 30.0	60	50

Note: 3. The lower limit shall apply at the transition frequencies.

4. The limit decreases in line with the logarithm of the frequency in the range of 0.15 to 0.50 MHz.

4.5.2 Test Instruments

Description & Manufacturer	Model No.	Serial No.	Date of Calibration	Due Date of Calibration
Test Receiver ROHDE & SCHWARZ	ESCI	100613	Dec. 10, 2018	Dec. 09, 2019
RF signal cable Woken	5D-FB	Cable-cond1-01	Sep. 05, 2019	Sep. 04, 2020
LISN ROHDE & SCHWARZ (EUT)	ENV216	101826	Feb. 21, 2019	Feb. 20, 2020
LISN ROHDE & SCHWARZ (Peripheral)	ESH3-Z5	100311	Aug. 22, 2019	Aug. 21, 2020
Software ADT	BV ADT_Cond_ V7.3.7.4	NA	NA	NA

Note: 1. The calibration interval of the above test instruments is 12 months and the calibrations are traceable to NML/ROC and NIST/USA.

2. The test was performed in HwaYa Shielded Room 1.

3. The VCCI Site Registration No. is C-12040.

4.5.3 Test Procedures

- a. The EUT was placed 0.4 meters from the conducting wall of the shielded room with EUT being connected to the power mains through a line impedance stabilization network (LISN). Other support units were connected to the power mains through another LISN. The two LISNs provide 50 ohm/50 uH of coupling impedance for the measuring instrument.
- b. Both lines of the power mains connected to the EUT were checked for maximum conducted interference.
- c. The frequency range from 150 kHz to 30 MHz was searched. Emission levels under (Limit – 20 dB) was not recorded.

Note: The resolution bandwidth and video bandwidth of test receiver is 9 kHz for quasi-peak detection (QP) and average detection (AV) at frequency 0.15 MHz – 30 MHz.

4.5.4 Deviation from Test Standard

No deviation.

4.5.5 Test Setup

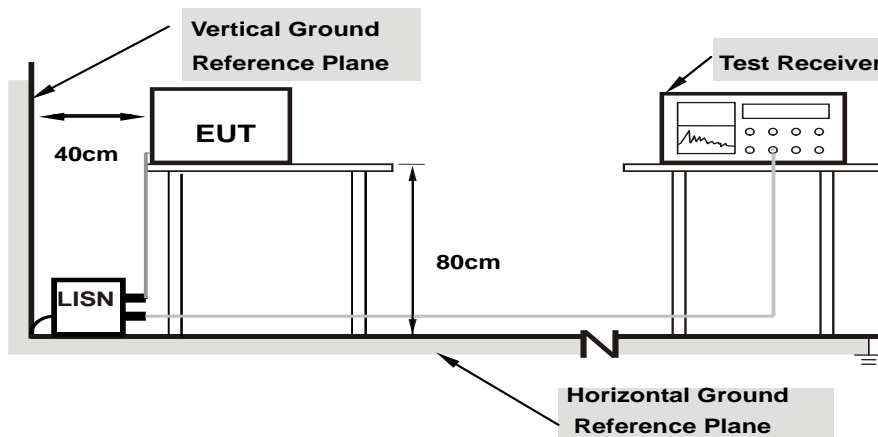

Note: 1.Support units were connected to second LISN.

For the actual test configuration, please refer to the attached file (Test Setup Photo).

4.5.6 EUT Operating Conditions

- a. Placed the EUT on a testing table.
- b. Use the software to control the EUT under transmission condition continuously at specific channel frequency.

4.5.7 Test Results

Frequency Range	150kHz ~ 30MHz	Detector Function & Resolution Bandwidth	Quasi-Peak (QP) / Average (AV), 9kHz
Input Power	120Vac, 60Hz	Environmental Conditions	25°C, 65%RH
Tested by	Jisyong Wang	Test Date	2019/10/13

Phase Of Power : Line (L)										
No	Frequency (MHz)	Correction Factor (dB)	Reading Value (dBuV)		Emission Level (dBuV)		Limit (dBuV)		Margin (dB)	
			Q.P.	AV.	Q.P.	AV.	Q.P.	AV.	Q.P.	AV.
1	0.16967	9.67	32.98	16.34	42.65	26.01	64.98	54.98	-22.33	-28.97
2	0.19692	9.66	29.35	13.58	39.01	23.24	63.74	53.74	-24.73	-30.50
3	0.22429	9.66	26.66	13.56	36.32	23.22	62.66	52.66	-26.34	-29.44
4	0.29467	9.67	19.12	1.20	28.79	10.87	60.39	50.39	-31.60	-39.52
5	0.45097	9.69	16.99	1.90	26.68	11.59	56.86	46.86	-30.18	-35.27
6	12.29837	9.95	16.87	0.52	26.82	10.47	60.00	50.00	-33.18	-39.53

Remarks:

1. Q.P. and AV. are abbreviations of quasi-peak and average individually.
2. The emission levels of other frequencies were very low against the limit.
3. Margin value = Emission level – Limit value
4. Correction factor = Insertion loss + Cable loss
5. Emission Level = Correction Factor + Reading Value

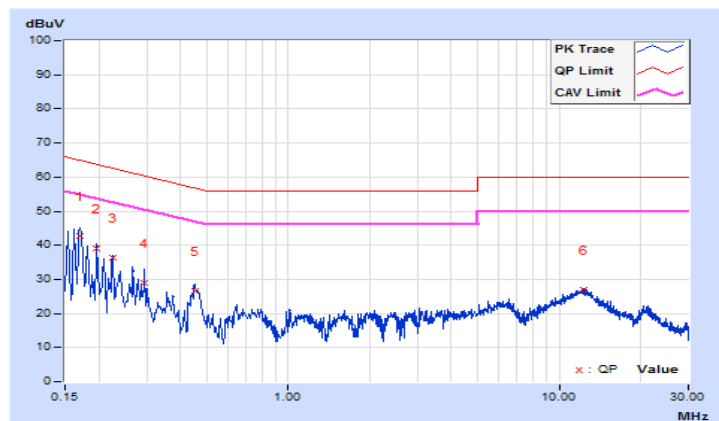

Frequency Range	150kHz ~ 30MHz	Detector Function & Resolution Bandwidth	Quasi-Peak (QP) / Average (AV), 9kHz
Input Power	120Vac, 60Hz	Environmental Conditions	25°C, 65%RH
Tested by	Jisyong Wang	Test Date	2019/10/13

Phase Of Power : Neutral (N)										
No	Frequency (MHz)	Correction Factor (dB)	Reading Value (dBuV)		Emission Level (dBuV)		Limit (dBuV)		Margin (dB)	
			Q.P.	AV.	Q.P.	AV.	Q.P.	AV.	Q.P.	AV.
1	0.16564	9.64	33.40	16.79	43.04	26.43	65.18	55.18	-22.14	-28.75
2	0.17737	9.64	33.36	16.90	43.00	26.54	64.61	54.61	-21.61	-28.07
3	0.19301	9.64	29.32	13.01	38.96	22.65	63.91	53.91	-24.95	-31.26
4	0.20474	9.64	29.04	14.91	38.68	24.55	63.42	53.42	-24.74	-28.87
5	0.22038	9.64	26.09	12.67	35.73	22.31	62.80	52.80	-27.07	-30.49
6	6.61323	9.85	18.96	1.86	28.81	11.71	60.00	50.00	-31.19	-38.29

Remarks:

1. Q.P. and AV. are abbreviations of quasi-peak and average individually.
2. The emission levels of other frequencies were very low against the limit.
3. Margin value = Emission level – Limit value
4. Correction factor = Insertion loss + Cable loss
5. Emission Level = Correction Factor + Reading Value

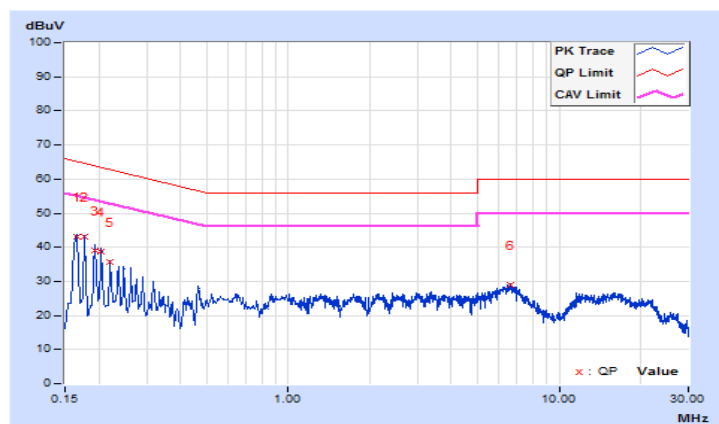

4.6 Conducted Output Power Measurement

4.6.1 Limits of Conducted Output Power Measurement

For systems using digital modulation in the 2400–2483.5 MHz bands: 1 Watt (30 dBm)

4.6.2 Test Setup

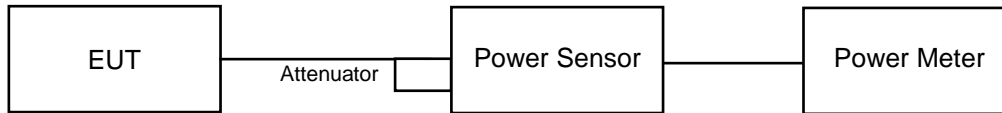

4.6.3 Test Instruments

Refer to section 4.1.2 to get information of above instrument.

4.6.4 Test Procedures

A peak power sensor was used on the output port of the EUT. A power meter was used to read the response of the peak power sensor. Record the power level.

4.6.5 Deviation from Test Standard

No deviation.

4.6.6 EUT Operating Conditions

The software provided by client to enable the EUT under transmission condition continuously at lowest, middle and highest channel frequencies individually.

4.6.7 Test Results

802.11b

Channel	Frequency (MHz)	Peak Power (mW)	Peak Power (dBm)	Limit (dBm)	Pass / Fail
1	2412	62.806	17.98	30	Pass
6	2437	62.517	17.96	30	Pass
11	2462	65.013	18.13	30	Pass
12	2467	61.518	17.89	30	Pass
13	2472	39.628	15.98	30	Pass

802.11g

Channel	Frequency (MHz)	Peak Power (mW)	Peak Power (dBm)	Limit (dBm)	Pass / Fail
1	2412	78.343	18.94	30	Pass
6	2437	76.913	18.86	30	Pass
11	2462	81.658	19.12	30	Pass
12	2467	73.282	18.65	30	Pass
13	2472	54.576	17.37	30	Pass

802.11n (HT20)

Channel	Frequency (MHz)	Peak Power (mW)	Peak Power (dBm)	Limit (dBm)	Pass / Fail
1	2412	80.353	19.05	30	Pass
6	2437	78.524	18.95	30	Pass
11	2462	82.604	19.17	30	Pass
12	2467	75.162	18.76	30	Pass
13	2472	58.076	17.64	30	Pass

5 Pictures of Test Arrangements

Please refer to the attached file (Test Setup Photo).

Annex A- Band-edge measurement

<Bluetooth LE>

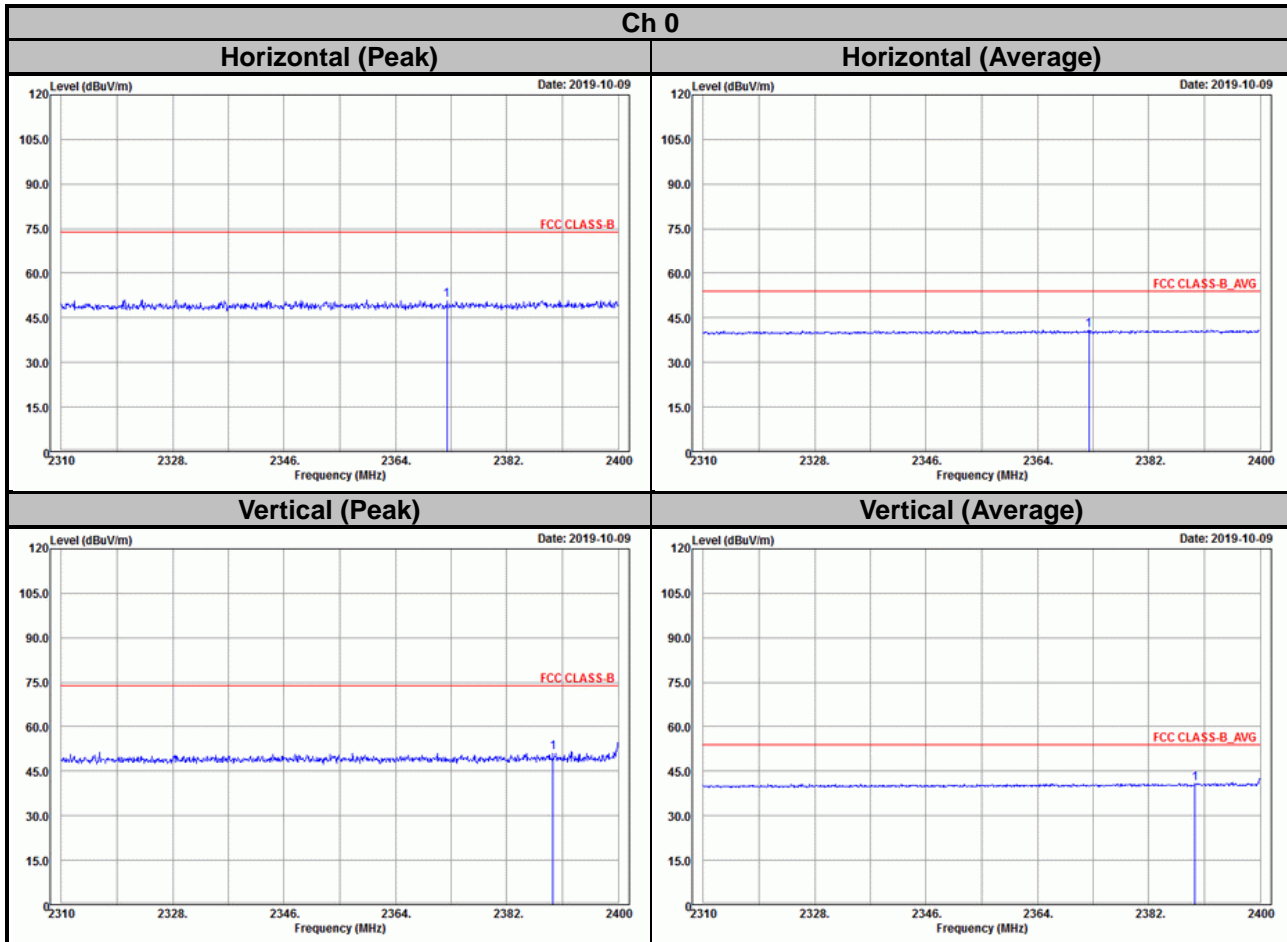

Ch 39

Horizontal (Peak)

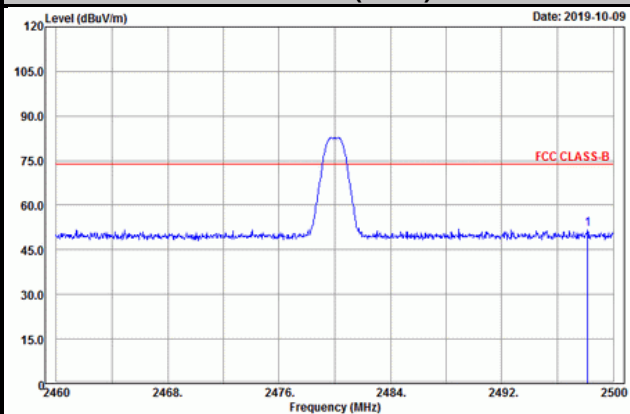

Horizontal (Average)

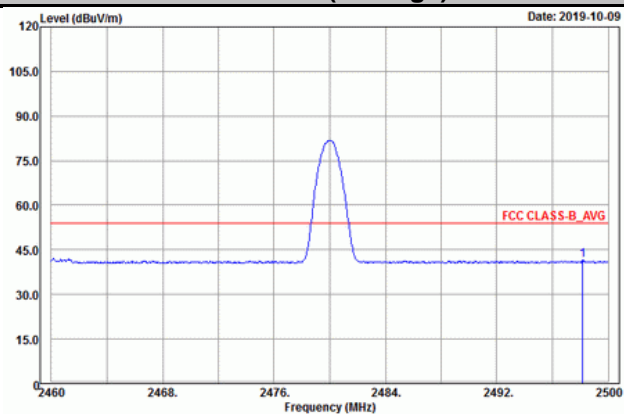

Vertical (Peak)

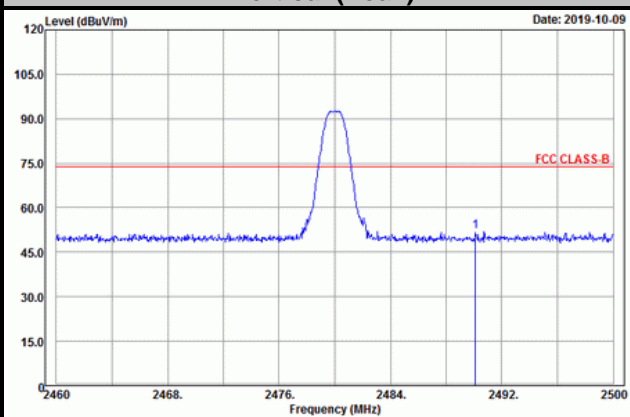

Vertical (Average)

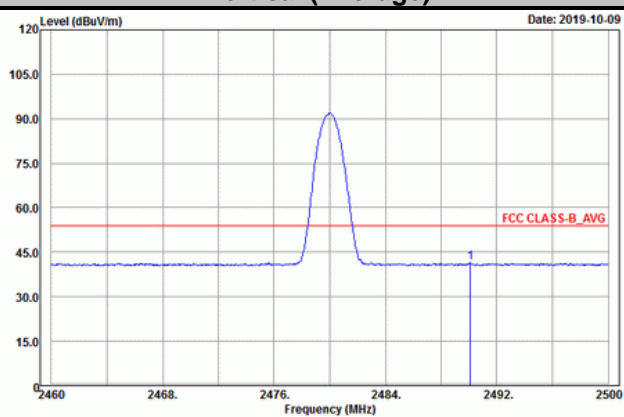

<WLAN>
802.11b

Ch 1

Horizontal (Peak)

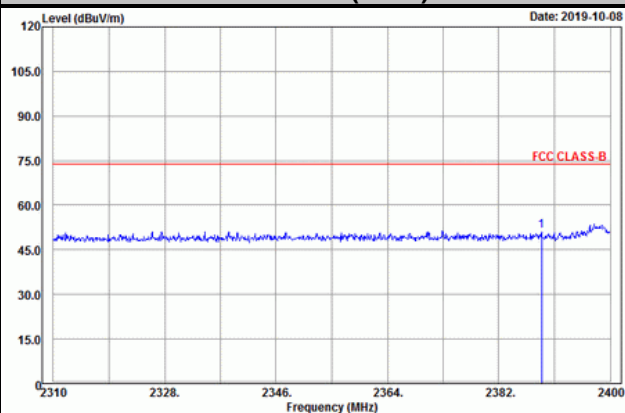

Horizontal (Average)

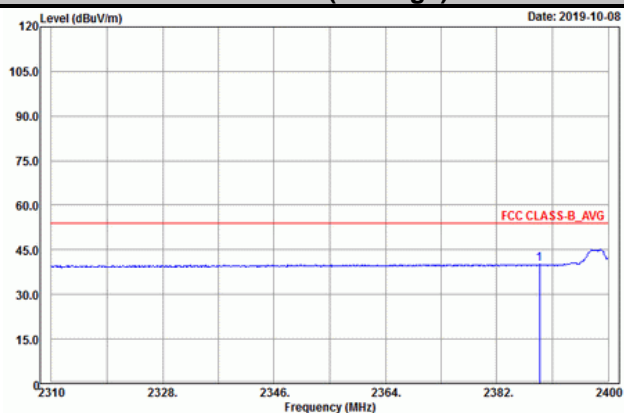

Vertical (Peak)

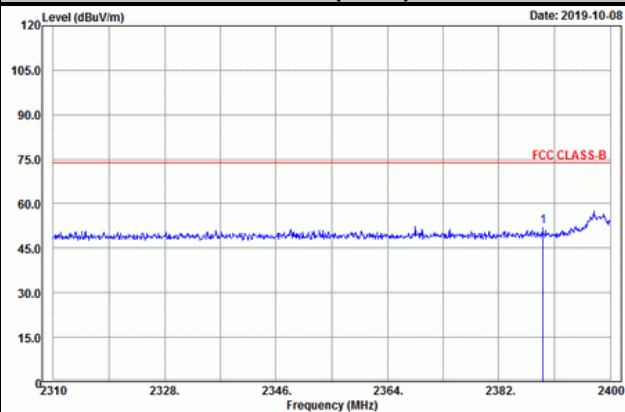

Vertical (Average)

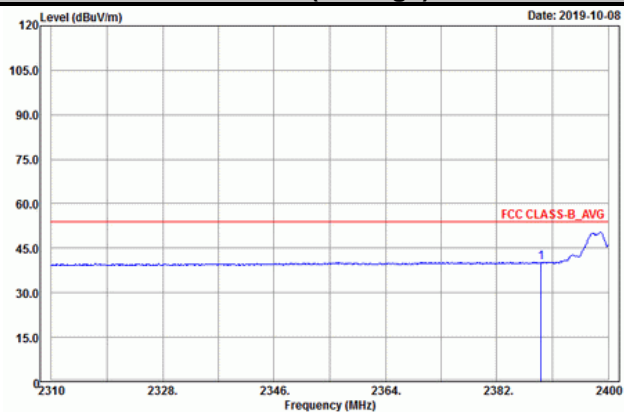

Ch 11

Horizontal (Peak)

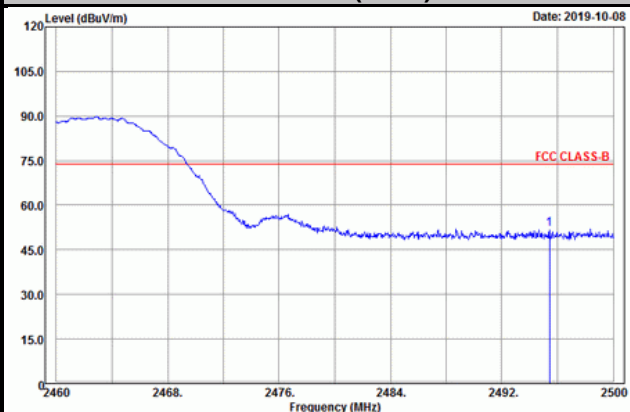

Horizontal (Average)

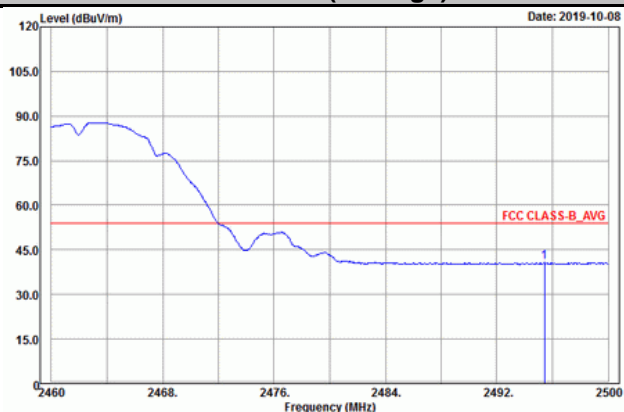

Vertical (Peak)

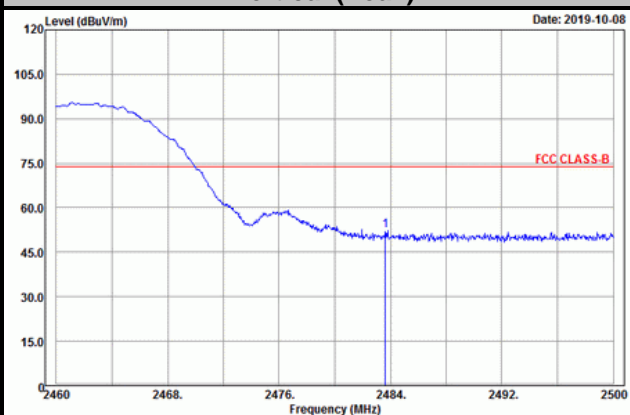

Vertical (Average)



Ch 12

Horizontal (Peak)

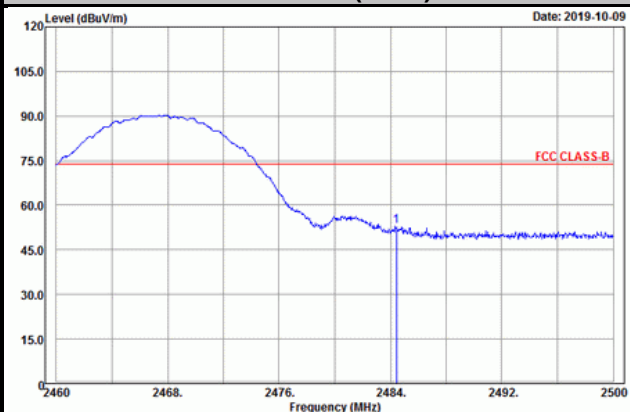

Horizontal (Average)

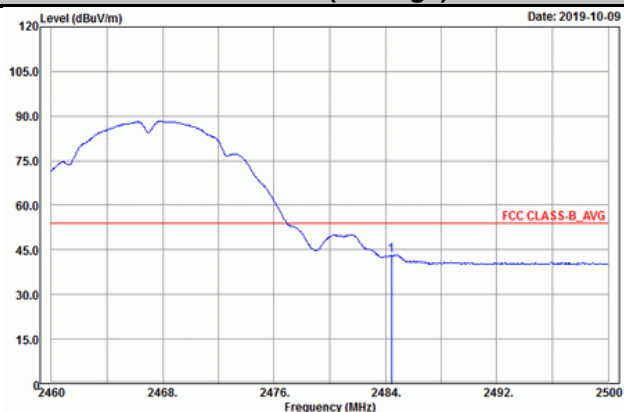

Vertical (Peak)

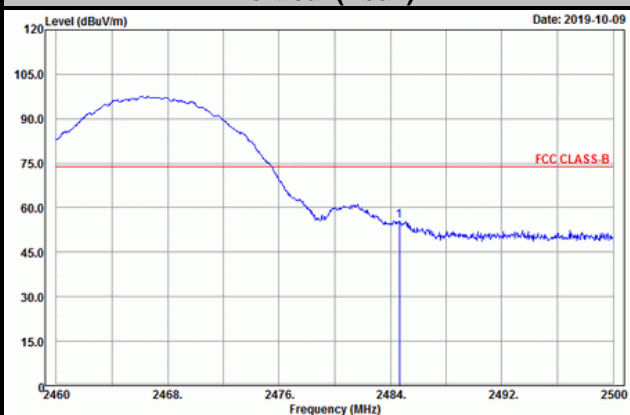

Vertical (Average)

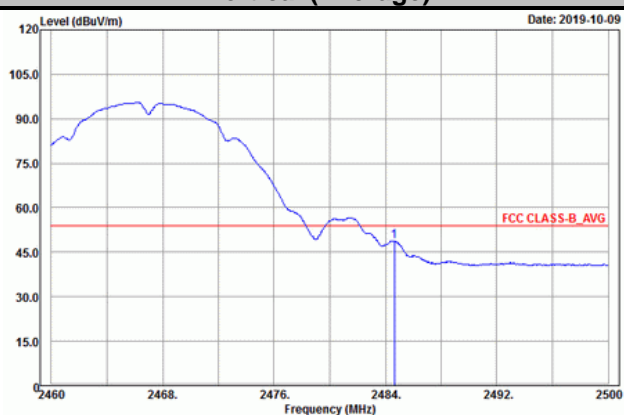

Ch 13

Horizontal (Peak)

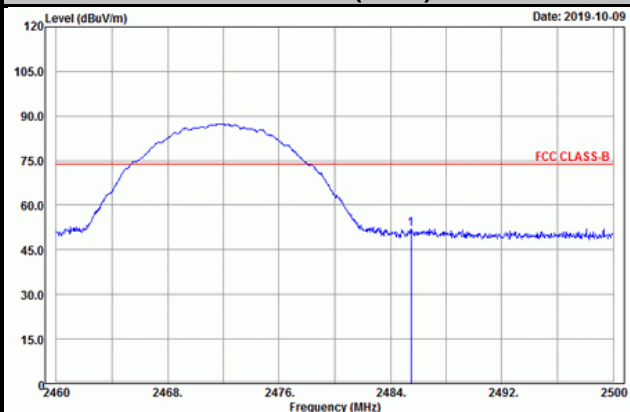

Horizontal (Average)

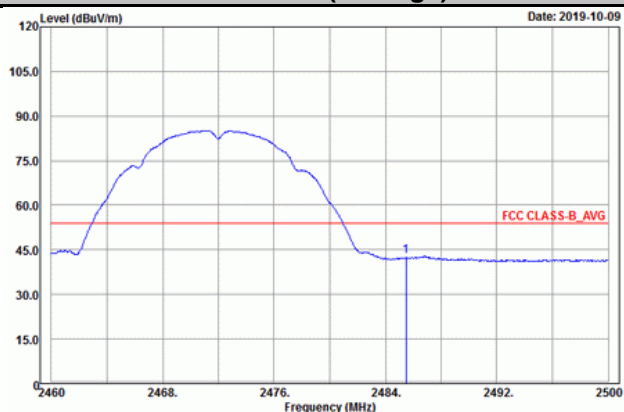

Vertical (Peak)

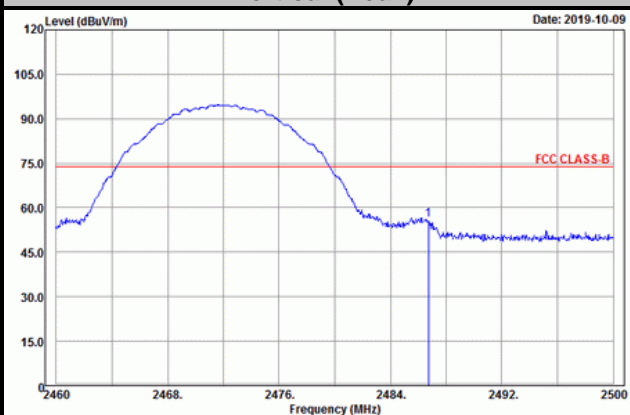

Vertical (Average)

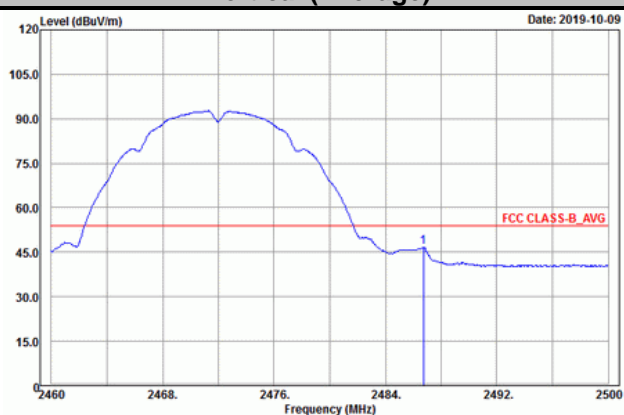

802.11g

Ch 1

Horizontal (Peak)

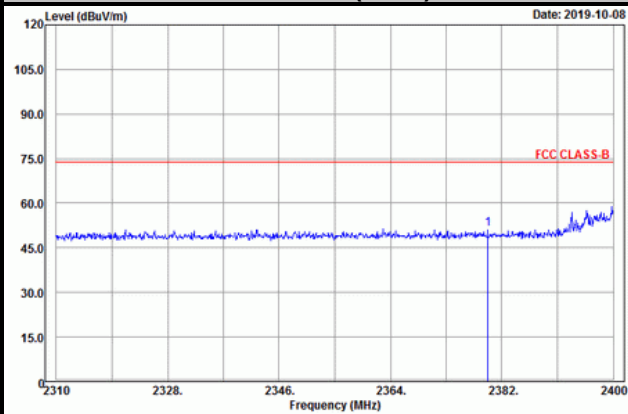

Horizontal (Average)

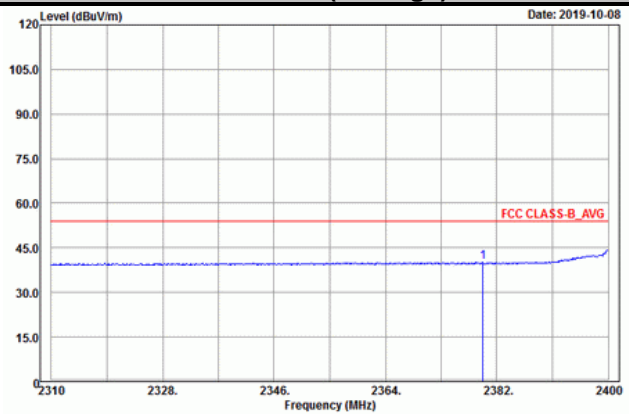

Vertical (Peak)

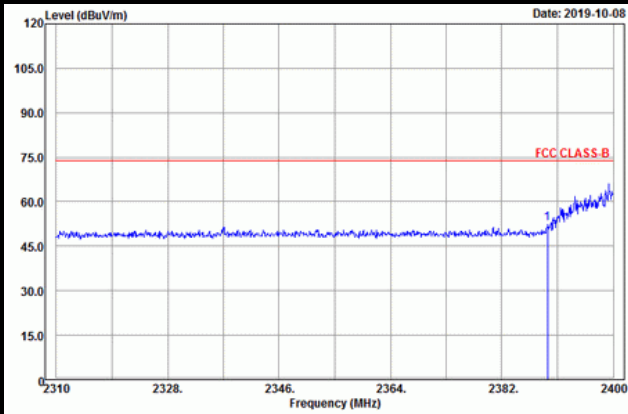

Vertical (Average)

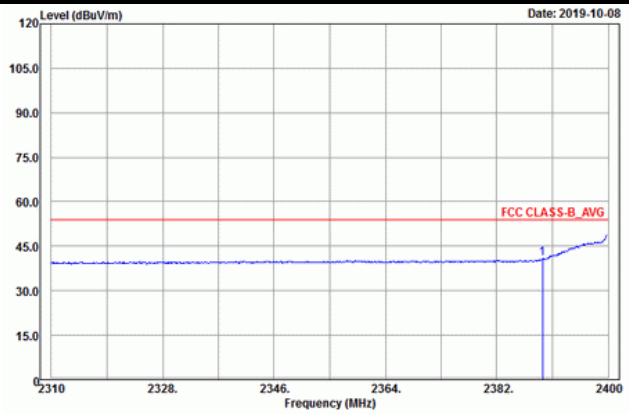

Ch 11

Horizontal (Peak)

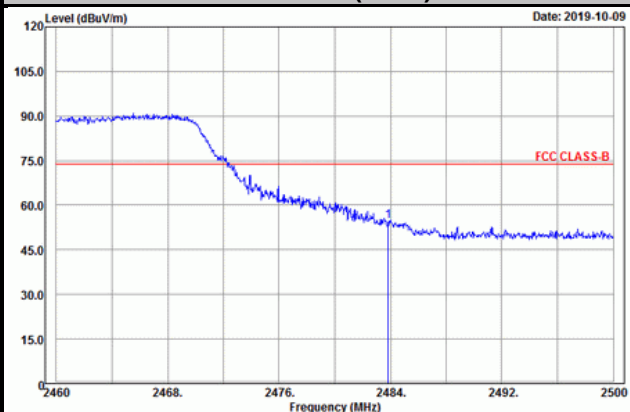

Horizontal (Average)

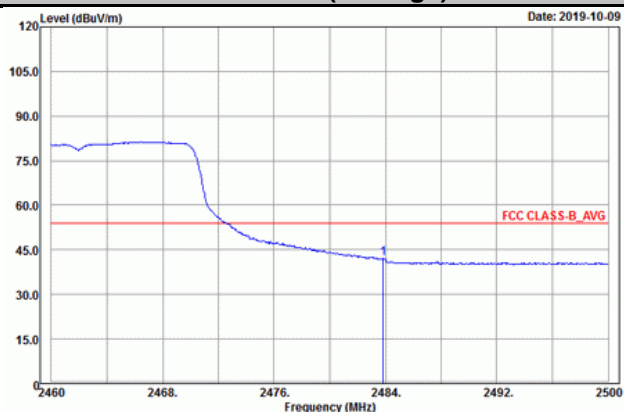

Vertical (Peak)

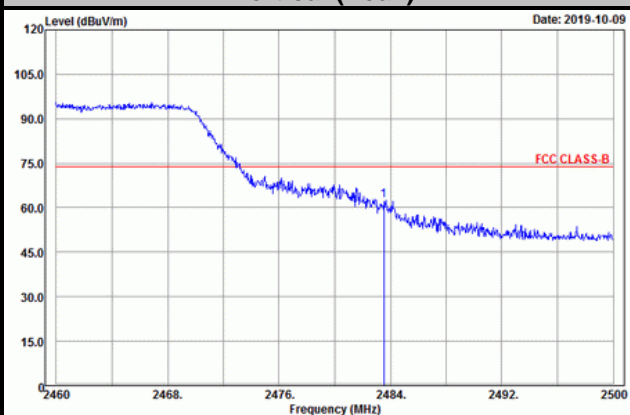

Vertical (Average)

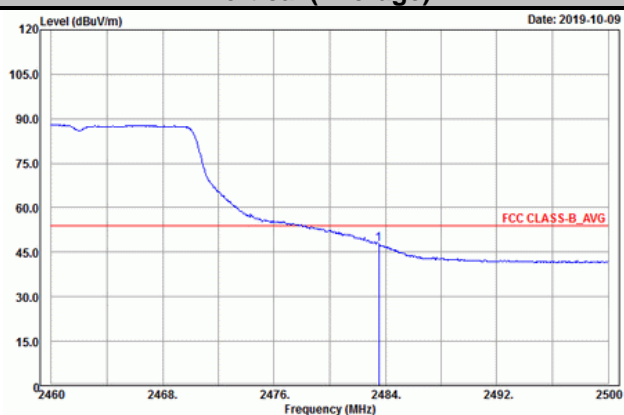

Ch 12

Horizontal (Peak)

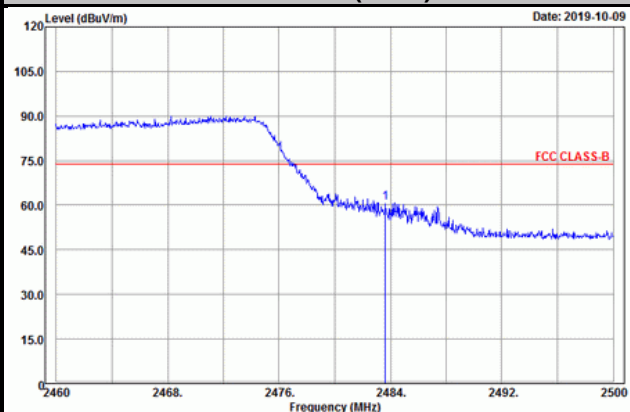

Horizontal (Average)

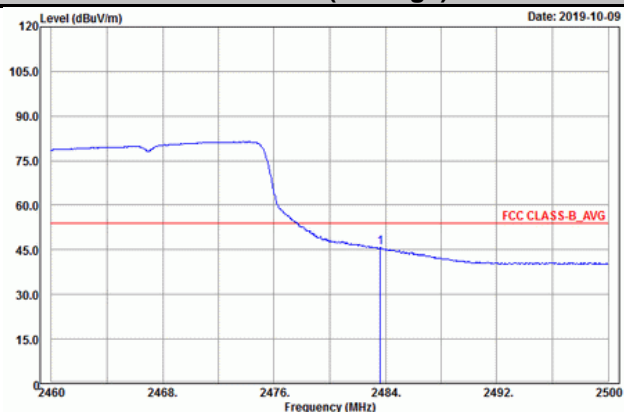

Vertical (Peak)

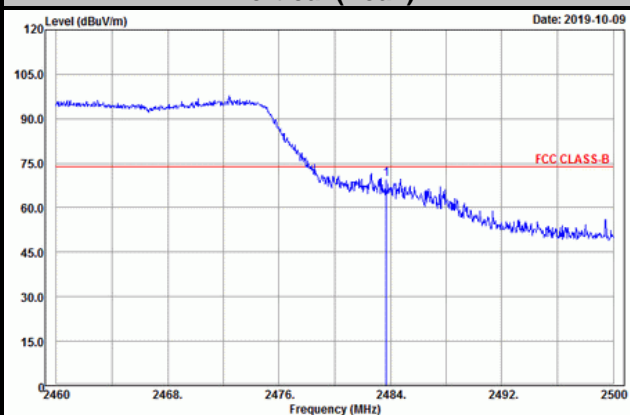

Vertical (Average)

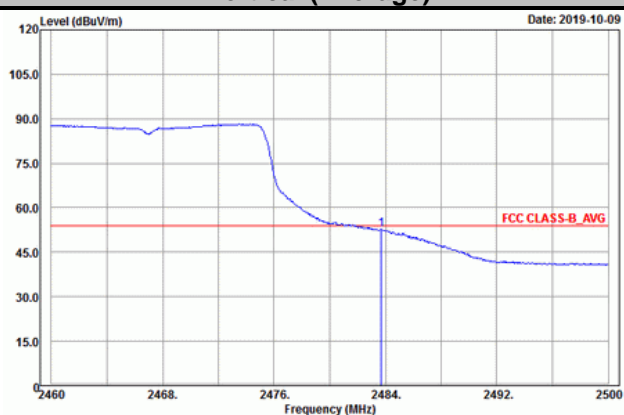

Ch 13

Horizontal (Peak)

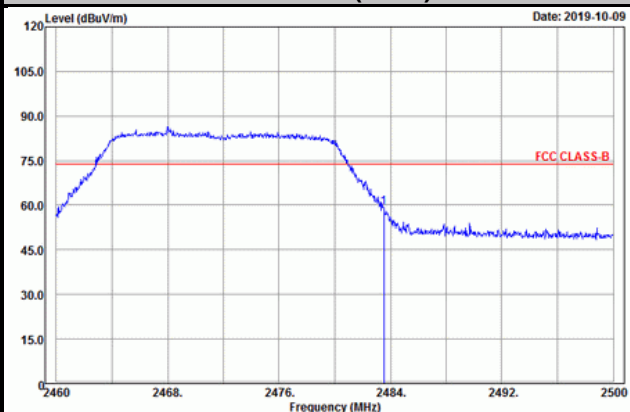

Horizontal (Average)

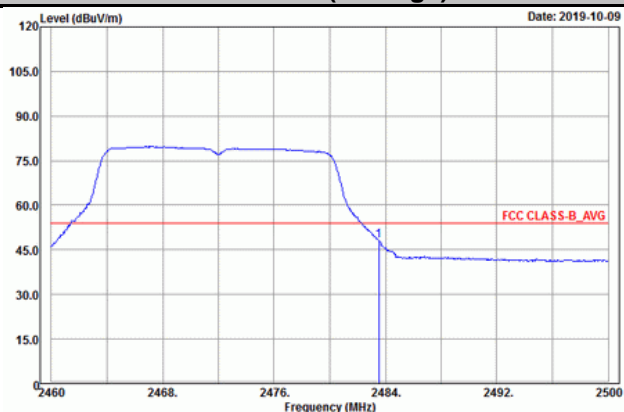

Vertical (Peak)

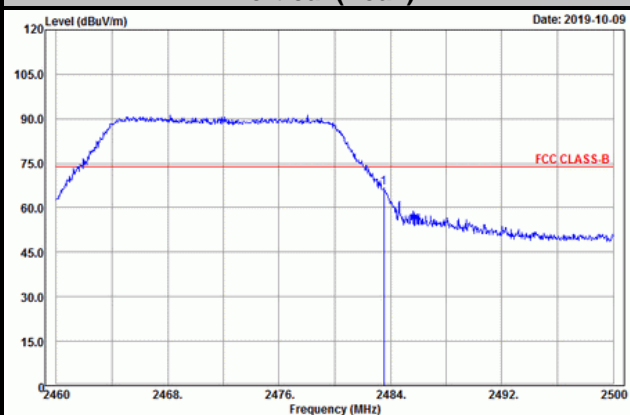

Vertical (Average)



802.11n (HT20)

Ch 1

Horizontal (Peak)

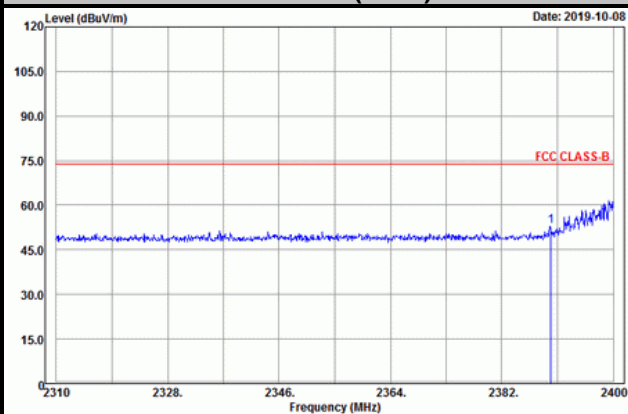

Horizontal (Average)

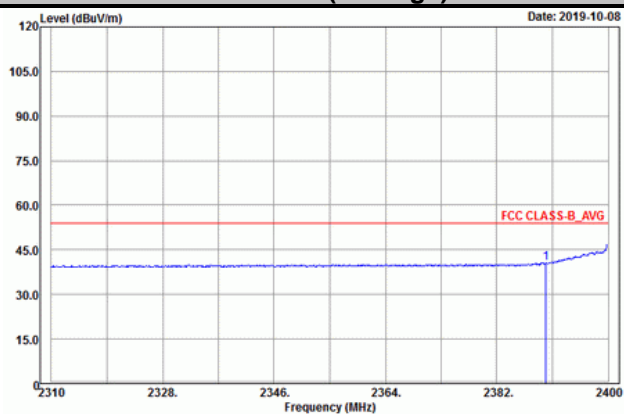

Vertical (Peak)

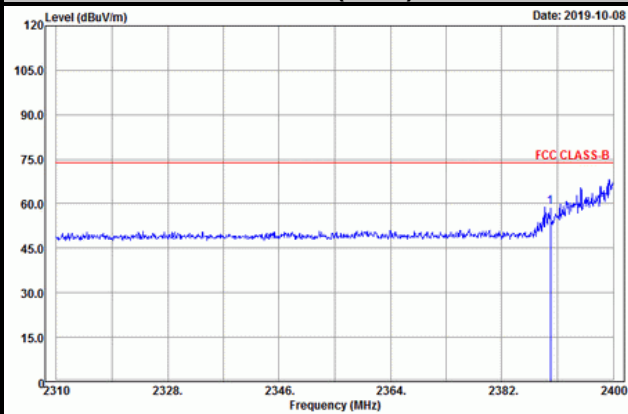

Vertical (Average)

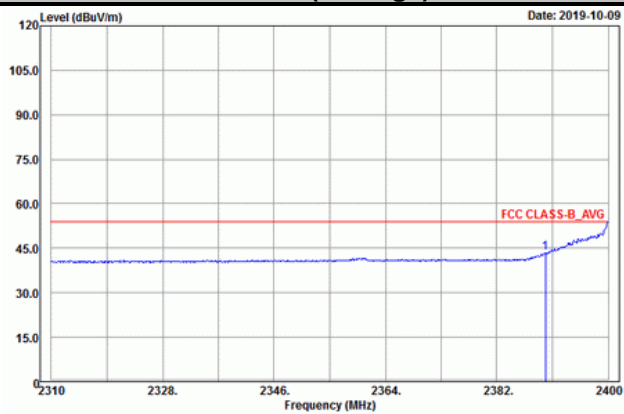

Ch 11

Horizontal (Peak)

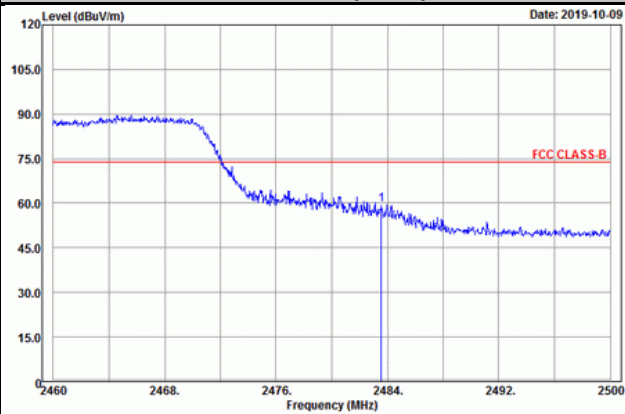

Horizontal (Average)

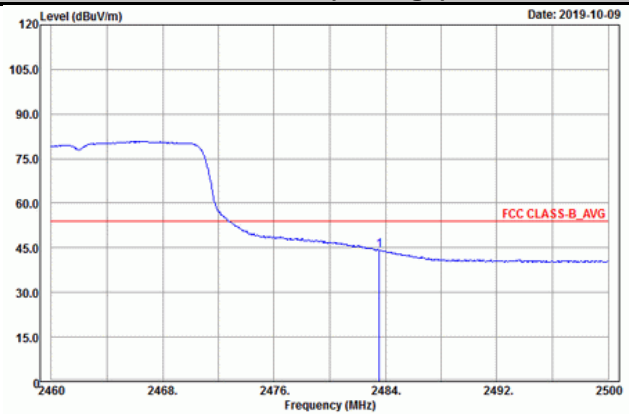

Vertical (Peak)

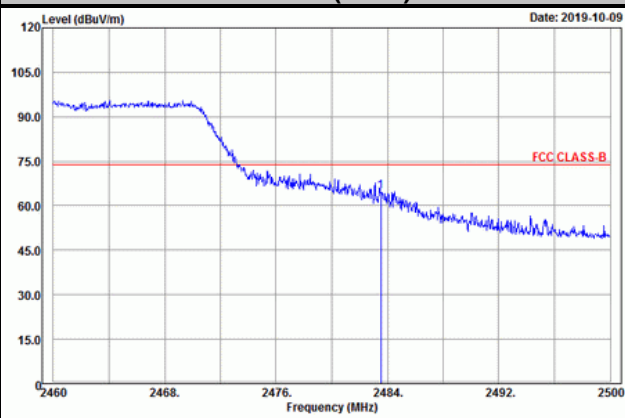

Vertical (Average)

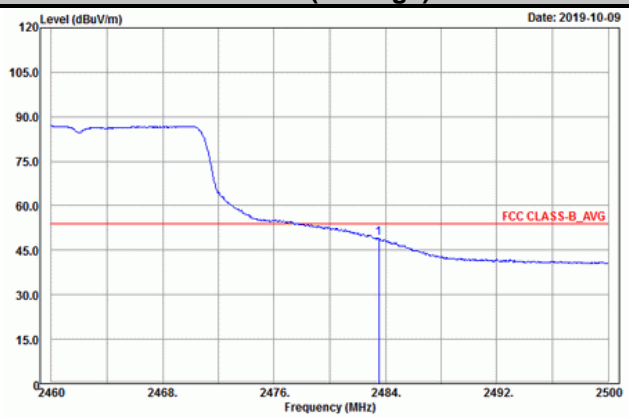

Ch 12

Horizontal (Peak)

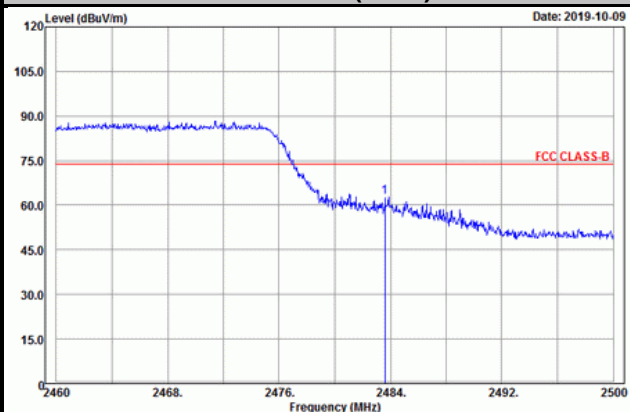

Horizontal (Average)

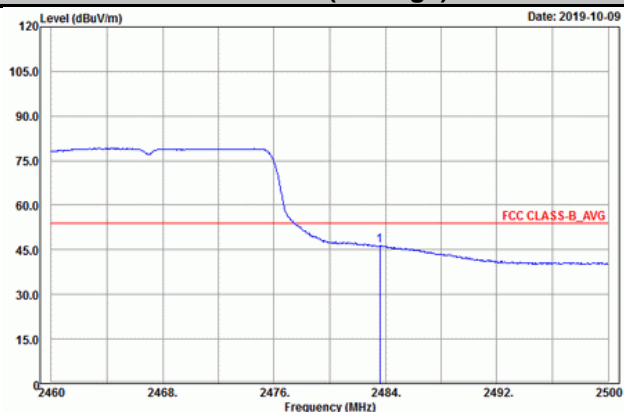

Vertical (Peak)

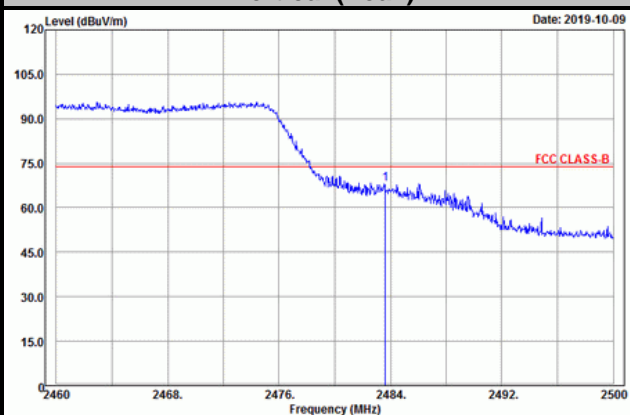

Vertical (Average)

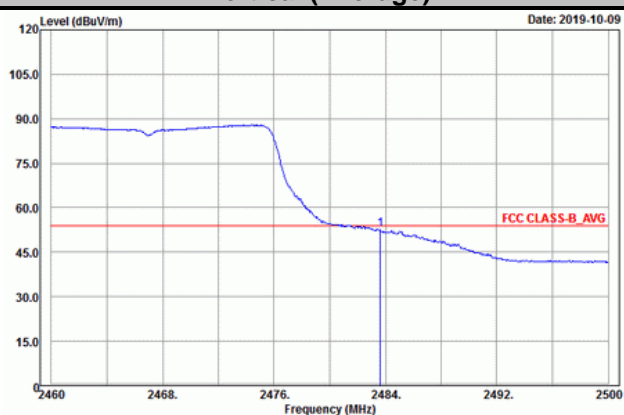

Ch 13

Horizontal (Peak)

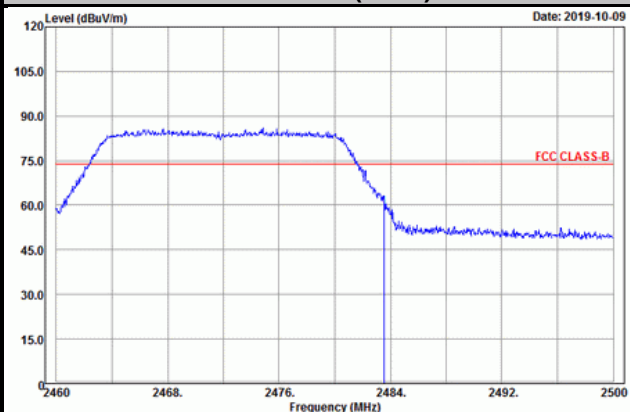

Horizontal (Average)

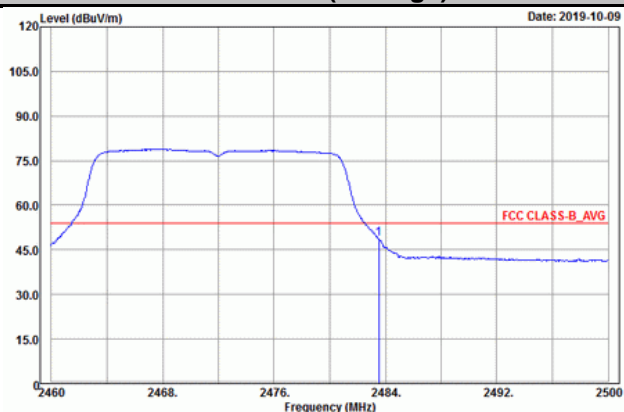

Vertical (Peak)

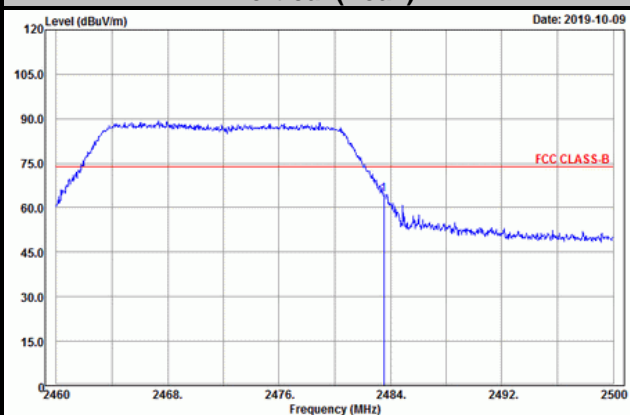

Vertical (Average)

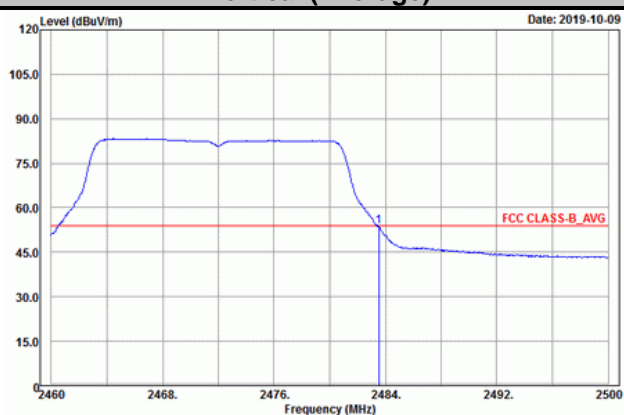

Appendix – Information of the Testing Laboratories

We, Bureau Veritas Consumer Products Services (H.K.) Ltd., Taoyuan Branch, were founded in 1988 to provide our best service in EMC, Radio, Telecom and Safety consultation. Our laboratories are FCC recognized accredited test firms and accredited according to ISO/IEC 17025.

If you have any comments, please feel free to contact us at the following:

Lin Kou EMC/RF Lab

Tel: 886-2-26052180

Fax: 886-2-26051924

Hsin Chu EMC/RF/Telecom Lab

Tel: 886-3-6668565

Fax: 886-3-6668323

Hwa Ya EMC/RF/Safety

Tel: 886-3-3183232

Fax: 886-3-3270892

Email: service.adt@tw.bureauveritas.com

Web Site: www.bureauveritas-adt.com

The address and road map of all our labs can be found in our web site also.

--- END ---