

FCC Test Report

Report No.: RF190226C07-2

FCC ID: UK7-DW10

Test Model: DW10M2

Series Model: DW10F1, DW10M1, DW10E1, DW10D1 (Refer to section 3.1 for more details)

Received Date: Feb. 26, 2019

Test Date: Mar. 13, 2019 ~ May 09, 2019

Issued Date: May 16, 2019

Applicant: Fossil Group, Inc.

Address: 901 S. Central Expressway, Richardson, TX 75080, USA

Issued By: Bureau Veritas Consumer Products Services (H.K.) Ltd., Taoyuan Branch

Lab Address: No. 47-2, 14th Ling, Chia Pau Vil., Lin Kou Dist., New Taipei City, Taiwan (R.O.C)

Test Location (1): No.19, Hwa Ya 2nd Rd., Wen Hwa Vil., Kwei Shan Dist., Taoyuan City 33383, Taiwan, R.O.C.

Test Location (2): B2F., No.215, Sec. 3, Beixin Rd., Xindian Dist., New Taipei City 231, Taiwan, R.O.C

**FCC Registration /
Designation Number:** 427177 / TW0011



This report is for your exclusive use. Any copying or replication of this report to or for any other person or entity, or use of our name or trademark, is permitted only with our prior written permission. This report sets forth our findings solely with respect to the test samples identified herein. The results set forth in this report are not indicative or representative of the quality or characteristics of the lot from which a test sample was taken or any similar or identical product unless specifically and expressly noted. Our report includes all of the tests requested by you and the results thereof based upon the information that you provided to us. You have 60 days from date of issuance of this report to notify us of any material error or omission caused by our negligence, provided, however, that such notice shall be in writing and shall specifically address the issue you wish to raise. A failure to raise such issue within the prescribed time shall constitute your unqualified acceptance of the completeness of this report, the tests conducted and the correctness of the report contents. Unless specific mention, the uncertainty of measurement has been explicitly taken into account to declare the compliance or non-compliance to the specification. The report must not be used by the client to claim product certification, approval, or endorsement by TAF or any government agencies.

Table of Contents

Release Control Record	5
1 Certificate of Conformity	6
2 Summary of Test Results	7
2.1 Measurement Uncertainty	8
2.2 Modification Record.....	8
3 General Information	9
3.1 General Description of EUT	9
3.2 Description of Test Modes	10
3.2.1 Test Mode Applicability and Tested Channel Detail	11
3.3 Duty Cycle of Test Signal	14
3.4 Description of Support Units.....	15
3.4.1 Configuration of System under Test.....	15
3.5 General Description of Applied Standards	15
4 Test Types and Results	16
<Bluetooth LE>	16
4.1 Radiated Emission and Bandedge Measurement	16
4.1.1 Limits of Radiated Emission and Bandedge Measurement	16
4.1.2 Test Instruments	17
4.1.3 Test Procedures.....	18
4.1.4 Deviation from Test Standard.....	18
4.1.5 Test Set Up	19
4.1.6 EUT Operating Conditions	20
4.1.7 Test Results	21
4.2 Conducted Emission Measurement	29
4.2.1 Limits of Conducted Emission Measurement	29
4.2.2 Test Instruments	29
4.2.3 Test Procedures.....	29
4.2.4 Deviation from Test Standard.....	30
4.2.5 Test Setup.....	30
4.2.6 EUT Operating Conditions	30
4.2.7 Test Results	31
4.3 6 dB Bandwidth Measurement	33
4.3.1 Limits of 6 dB Bandwidth Measurement.....	33
4.3.2 Test Setup.....	33
4.3.3 Test Instruments	33
4.3.4 Test Procedure	33
4.3.5 Deviation from Test Standard.....	33
4.3.6 EUT Operating Conditions	33
4.3.7 Test Results	34
4.4 Occupied Bandwidth Measurement	35
4.4.1 Test Setup.....	35
4.4.2 Test Instruments	35
4.4.3 Test Procedure	35
4.4.4 Deviation from Test Standard.....	35
4.4.5 EUT Operating Conditions	35
4.4.6 Test Results	36
4.5 Conducted Output Power Measurement	37
4.5.1 Limits of Conducted Output Power Measurement.....	37
4.5.2 Test Setup.....	37
4.5.3 Test Instruments	37
4.5.4 Test Procedures.....	37
4.5.5 Deviation from Test Standard.....	37
4.5.6 EUT Operating Conditions	37

4.5.7	Test Results	37
4.6	Power Spectral Density Measurement	38
4.6.1	Limits of Power Spectral Density Measurement	38
4.6.2	Test Setup	38
4.6.3	Test Instruments	38
4.6.4	Test Procedure	38
4.6.5	Deviation from Test Standard	38
4.6.6	EUT Operating Condition	38
4.6.7	Test Results	39
4.7	Conducted Out of Band Emission Measurement	40
4.7.1	Limits of Conducted Out of Band Emission Measurement	40
4.7.2	Test Setup	40
4.7.3	Test Instruments	40
4.7.4	Test Procedure	40
4.7.5	Deviation from Test Standard	40
4.7.6	EUT Operating Condition	40
4.7.7	Test Results	41
<WLAN>	43
4.8	Radiated Emission and Bandedge Measurement	43
4.8.1	Limits of Radiated Emission and Bandedge Measurement	43
4.8.2	Test Instruments	43
4.8.3	Test Procedures.....	44
4.8.4	Deviation from Test Standard	44
4.8.5	Test Set Up	45
4.8.6	EUT Operating Conditions	46
4.8.7	Test Results	47
4.9	Conducted Emission Measurement	79
4.9.1	Limits of Conducted Emission Measurement	79
4.9.2	Test Instruments	79
4.9.3	Test Procedures.....	80
4.9.4	Deviation from Test Standard	80
4.9.5	Test Setup	80
4.9.6	EUT Operating Conditions	80
4.9.7	Test Results	81
4.10	6 dB Bandwidth Measurement	83
4.10.1	Limits of 6 dB Bandwidth Measurement.....	83
4.10.2	Test Setup	83
4.10.3	Test Instruments	83
4.10.4	Test Procedure	83
4.10.5	Deviation from Test Standard.....	83
4.10.6	EUT Operating Conditions	83
4.10.7	Test Results	84
4.11	Occupied Bandwidth Measurement	86
4.11.1	Test Setup	86
4.11.2	Test Instruments	86
4.11.3	Test Procedure	86
4.11.4	Deviation from Test Standard.....	86
4.11.5	EUT Operating Conditions	86
4.11.6	Test Results	87
4.12	Conducted Output Power Measurement	89
4.12.1	Limits of Conducted Output Power Measurement.....	89
4.12.2	Test Setup	89
4.12.3	Test Instruments	89
4.12.4	Test Procedures.....	89
4.12.5	Deviation from Test Standard.....	89
4.12.6	EUT Operating Conditions	89
4.12.7	Test Results	90
4.13	Power Spectral Density Measurement	91

4.13.1 Limits of Power Spectral Density Measurement	91
4.13.2 Test Setup	91
4.13.3 Test Instruments	91
4.13.4 Test Procedure	91
4.13.5 Deviation from Test Standard	91
4.13.6 EUT Operating Condition	91
4.13.7 Test Results	92
4.14 Conducted Out of Band Emission Measurement	94
4.14.1 Limits of Conducted Out of Band Emission Measurement	94
4.14.2 Test Setup	94
4.14.3 Test Instruments	94
4.14.4 Test Procedure	94
4.14.5 Deviation from Test Standard	94
4.14.6 EUT Operating Condition	94
4.14.7 Test Results	95
5 Pictures of Test Arrangements	101
Annex A- Band-edge measurement.....	102
Appendix – Information of the Testing Laboratories	116

Release Control Record

Issue No.	Description	Date Issued
RF190226C07-2	Original Release	May 16, 2019

1 Certificate of Conformity

Product: Smart Watch

Test Model: DW10M2

Series Model: DW10F1, DW10M1, DW10E1, DW10D1 (Refer to section 3.1 for more details)

Sample Status: Identical Prototype

Applicant: Fossil Group, Inc.

Test Date: Mar. 13, 2019 ~ May 09, 2019

Standards: 47 CFR FCC Part 15, Subpart C (Section 15.247)
ANSI C63.10:2013

The above equipment has been tested by **Bureau Veritas Consumer Products Services (H.K.) Ltd., Taoyuan Branch**, and found compliance with the requirement of the above standards. The test record, data evaluation & Equipment Under Test (EUT) configurations represented herein are true and accurate accounts of the measurements of the sample's RF characteristics under the conditions specified in this report.

Prepared by : Rona Chen, **Date:** May 16, 2019
Rona Chen / Specialist

Approved by : Dylan Chiou, **Date:** May 16, 2019
Dylan Chiou / Project Engineer

2 Summary of Test Results

<Bluetooth LE>

47 CFR FCC Part 15, Subpart C (Section 15.247)			
FCC Clause	Test Item	Result	Remarks
15.207	AC Power Conducted Emission	Pass	Meet the requirement of limit. Minimum passing margin is -23.87 dB at 0.15000 MHz.
15.205 & 209	Radiated Emissions	Pass	Meet the requirement of limit. Minimum passing margin is -12.3 dB at 2483.88 MHz.
15.247(d)	Band Edge Measurement	Pass	Meet the requirement of limit.
15.247(d)	Antenna Port Emission	Pass	Meet the requirement of limit.
15.247(a)(2)	6 dB Bandwidth	Pass	Meet the requirement of limit.
---	Occupied Bandwidth Measurement	Pass	Reference only
15.247(b)	Conducted Power	Pass	Meet the requirement of limit.
15.247(e)	Power Spectral Density	Pass	Meet the requirement of limit.
15.203	Antenna Requirement	Pass	No antenna connector is used.

Note: Determining compliance based on the results of the compliance measurement, not taking into account measurement instrumentation uncertainty.

<WLAN>

47 CFR FCC Part 15, Subpart C (Section 15.247)			
FCC Clause	Test Item	Result	Remarks
15.207	AC Power Conducted Emission	Pass	Meet the requirement of limit. Minimum passing margin is -21.83 dB at 0.16190 MHz.
15.205 / 15.209 / 15.247(d)	Radiated Emissions and Band Edge Measurement	Pass	Meet the requirement of limit. Minimum passing margin is -1.33 dB at 2483.52 MHz.
15.247(d)	Antenna Port Emission	Pass	Meet the requirement of limit.
15.247(a)(2)	6 dB Bandwidth	Pass	Meet the requirement of limit.
---	Occupied Bandwidth Measurement	Pass	Reference only
15.247(b)	Conducted power	Pass	Meet the requirement of limit.
15.247(e)	Power Spectral Density	Pass	Meet the requirement of limit.
15.203	Antenna Requirement	Pass	No antenna connector is used.

Note: Determining compliance based on the results of the compliance measurement, not taking into account measurement instrumentation uncertainty.

2.1 Measurement Uncertainty

Where relevant, the following measurement uncertainty levels have been estimated for tests performed on the EUT as specified in CISPR 16-4-2:

Measurement	Frequency	Expanded Uncertainty (k=2) (±)
Conducted Emissions at mains ports	150 kHz ~ 30 MHz	2.44 dB
Radiated Emissions up to 1 GHz	9 kHz ~ 30 MHz	3.04 dB
	30 MHz ~ 200 MHz	2.0153 dB
	200 MHz ~ 1000 MHz	2.0224 dB
Radiated Emissions above 1 GHz	1 GHz ~ 18 GHz	1.0121 dB
	18 GHz ~ 40 GHz	1.1508 dB

2.2 Modification Record

There were no modifications required for compliance.

3 General Information

3.1 General Description of EUT

Product	Smart Watch	
Test Model	DW10M2	
Series Model	DW10F1, DW10M1, DW10E1, DW10D1	
Status of EUT	Identical Prototype	
Power Supply Rating	5.0 Vdc (Host equipment or Adapter) 3.85 Vdc (Battery)	
Modulation Type	Bluetooth LE	GFSK
	WLAN	CCK, DQPSK, DBPSK for DSSS 64QAM, 16QAM, QPSK, BPSK for OFDM
Transfer Rate	Bluetooth LE	1 Mbps
	WLAN	802.11b: 11.0 / 5.5 / 2.0 / 1.0 Mbps 802.11g: 54.0 / 48.0 / 36.0 / 24.0 / 18.0 / 12.0 / 9.0 / 6.0 Mbps 802.11n: up to 72.2 Mbps
Operating Frequency	Bluetooth LE	2402 ~ 2480 MHz
	WLAN	2412 ~ 2472 MHz
Number of Channel	Bluetooth LE	40
	WLAN	13 for 802.11b, 802.11g, 802.11n (HT20)
Output Power	Bluetooth LE	1.941 mW
	WLAN	86.896 mW
Antenna Type	Loop antenna	
Antenna Connector	N/A	
Accessory Device	Refer to Note as below	
Data Cable Supplied	Refer to Note as below	

Note:

1. All models are listed as below. Model: DW10M2 antenna gain is maximum as a representative for the final test.

Model	Antenna Gain (dBi)		Description
	2.4G / BT	GPS	
DW10F1	-7.45	-6.48	The samples are different in the appearance and antenna gain only.
DW10M1	-8.00	-6.36	
DW10M2	-6.21	-5.17	
DW10E1	-6.80	-5.47	
DW10D1	-7.15	-5.61	

2. The EUT provides one completed transmitter and one receiver.

Modulation Mode	Tx Function
802.11b	1TX
802.11g	1TX
802.11n (HT20)	1TX

3. The EUT's accessories list refers to user manual.
4. The above EUT information is declared by manufacturer and for more detailed features description, please refers to the manufacturer's specifications or User's Manual.

3.2 Description of Test Modes

<Bluetooth LE>

40 channels are provided to this EUT:

Channel	Freq. (MHz)	Channel	Freq. (MHz)	Channel	Freq. (MHz)	Channel	Freq. (MHz)
0	2402	10	2422	20	2442	30	2462
1	2404	11	2424	21	2444	31	2464
2	2406	12	2426	22	2446	32	2466
3	2408	13	2428	23	2448	33	2468
4	2410	14	2430	24	2450	34	2470
5	2412	15	2432	25	2452	35	2472
6	2414	16	2434	26	2454	36	2474
7	2416	17	2436	27	2456	37	2476
8	2418	18	2438	28	2458	38	2478
9	2420	19	2440	29	2460	39	2480

<WLAN>

13 channels are provided for 802.11b, 802.11g and 802.11n (HT20):

Channel	Frequency (MHz)	Channel	Frequency (MHz)
1	2412	8	2447
2	2417	9	2452
3	2422	10	2457
4	2427	11	2462
5	2432	12	2467
6	2437	13	2472
7	2442		

3.2.1 Test Mode Applicability and Tested Channel Detail

<Bluetooth LE>

EUT Configure Mode	Applicable To				Description
	RE \geq 1G	RE<1G	PLC	APCM	
-	√	√	√	√	-

Where **RE \geq 1G**: Radiated Emission above 1 GHz **RE<1G**: Radiated Emission below 1 GHz
PLC: Power Line Conducted Emission **APCM**: Antenna Port Conducted Measurement

Note:

1. The EUT had been pre-tested on the positioned of each 3 axis. The worst case was found when positioned on **Z-plane**.

Radiated Emission Test (Above 1 GHz):

- Pre-Scan has been conducted to determine the worst-case mode from all possible combinations between available modulations, data rates and antenna ports (if EUT with antenna diversity architecture).
- Following channel(s) was (were) selected for the final test as listed below.

EUT Configure Mode	Available Channel	Tested Channel	Modulation Type	Data Rate (Mbps)
-	0 to 39	0, 19, 39	GFSK	1

Radiated Emission Test (Below 1 GHz):

- Pre-Scan has been conducted to determine the worst-case mode from all possible combinations between available modulations, data rates and antenna ports (if EUT with antenna diversity architecture).
- Following channel(s) was (were) selected for the final test as listed below.

EUT Configure Mode	Available Channel	Tested Channel	Modulation Type	Data Rate (Mbps)
-	0 to 39	39	GFSK	1

Power Line Conducted Emission Test:

- Pre-Scan has been conducted to determine the worst-case mode from all possible combinations between available modulations, data rates and antenna ports (if EUT with antenna diversity architecture).
- Following channel(s) was (were) selected for the final test as listed below.

EUT Configure Mode	Available Channel	Tested Channel	Modulation Type	Data Rate (Mbps)
-	0 to 39	39	GFSK	1

Antenna Port Conducted Measurement:

- This item includes all test value of each mode, but only includes spectrum plot of worst value of each mode.
- Pre-Scan has been conducted to determine the worst-case mode from all possible combinations between available modulations, data rates and antenna ports (if EUT with antenna diversity architecture).
- Following channel(s) was (were) selected for the final test as listed below.

EUT Configure Mode	Available Channel	Tested Channel	Modulation Type	Data Rate (Mbps)
-	0 to 39	0, 19, 39	GFSK	1

<WLAN>

EUT Configure Mode	Applicable To				Description
	RE \geq 1G	RE<1G	PLC	APCM	
-	√	√	√	√	-

Where **RE \geq 1G**: Radiated Emission above 1 GHz **RE<1G**: Radiated Emission below 1 GHz
PLC: Power Line Conducted Emission **APCM**: Antenna Port Conducted Measurement

Note:

1. The EUT had been pre-tested on the positioned of each 3 axis. The worst case was found when positioned on **Z-plane**.

Radiated Emission Test (Above 1 GHz):

- Pre-Scan has been conducted to determine the worst-case mode from all possible combinations between available modulations, data rates and antenna ports (if EUT with antenna diversity architecture).
- Following channel(s) was (were) selected for the final test as listed below.

EUT Configure Mode	Mode	Available Channel	Tested Channel	Modulation Technology	Modulation Type	Data Rate (Mbps)
-	802.11b	1 to 13	1, 6, 11, 12, 13	DSSS	DBPSK	1.0
-	802.11g	1 to 13	1, 6, 11, 12, 13	OFDM	BPSK	6.0
-	802.11n (HT20)	1 to 13	1, 6, 11, 12, 13	OFDM	BPSK	6.5

Radiated Emission Test (Below 1 GHz):

- Pre-Scan has been conducted to determine the worst-case mode from all possible combinations between available modulations, data rates and antenna ports (if EUT with antenna diversity architecture).
- Following channel(s) was (were) selected for the final test as listed below.

EUT Configure Mode	Mode	Available Channel	Tested Channel	Modulation Technology	Modulation Type	Data Rate (Mbps)
-	802.11n (HT20)	1 to 13	13	OFDM	BPSK	6.5

Power Line Conducted Emission Test:

- Pre-Scan has been conducted to determine the worst-case mode from all possible combinations between available modulations, data rates and antenna ports (if EUT with antenna diversity architecture).
- Following channel(s) was (were) selected for the final test as listed below.

EUT Configure Mode	Mode	Available Channel	Tested Channel	Modulation Technology	Modulation Type	Data Rate (Mbps)
-	802.11n (HT20)	1 to 13	13	OFDM	BPSK	6.5

Bandedge Measurement:

- Pre-Scan has been conducted to determine the worst-case mode from all possible combinations between available modulations, data rates and antenna ports (if EUT with antenna diversity architecture).
- Following channel(s) was (were) selected for the final test as listed below.

EUT Configure Mode	Mode	Available Channel	Tested Channel	Modulation Technology	Modulation Type	Data Rate (Mbps)
-	802.11b	1 to 13	1, 11, 12, 13	DSSS	DBPSK	1.0
-	802.11g	1 to 13	1, 11, 12, 13	OFDM	BPSK	6.0
-	802.11n (HT20)	1 to 13	1, 11, 12, 13	OFDM	BPSK	6.5

Antenna Port Conducted Measurement:

- This item includes all test value of each mode, but only includes spectrum plot of worst value of each mode.
- Pre-Scan has been conducted to determine the worst-case mode from all possible combinations between available modulations, data rates and antenna ports (if EUT with antenna diversity architecture).
- Following channel(s) was (were) selected for the final test as listed below.

EUT Configure Mode	Mode	Available Channel	Tested Channel	Modulation Technology	Modulation Type	Data Rate (Mbps)
-	802.11b	1 to 13	1, 6, 11, 12, 13	DSSS	DBPSK	1.0
-	802.11g	1 to 13	1, 6, 11, 12, 13	OFDM	BPSK	6.0
-	802.11n (HT20)	1 to 13	1, 6, 11, 12, 13	OFDM	BPSK	6.5

Test Condition:

Applicable To	Environmental Conditions	Input Power	Tested by
RE \geq 1G	25 deg. C, 65 % RH	120 Vac, 60 Hz	Harry Hsueh, Karl Lee
RE $<$ 1G	25 deg. C, 65 % RH	120 Vac, 60 Hz	Harry Hsueh, Karl Lee
PLC	25 deg. C, 65 % RH	120 Vac, 60 Hz	Thomas Wei
APCM	25 deg. C, 65 % RH	3.8 Vdc	Gavin Wu

3.3 Duty Cycle of Test Signal

<Bluetooth LE>

Duty cycle = $0.387/0.634 = 0.610$, Duty factor = $10 * \log(1/0.610) = 2.15$

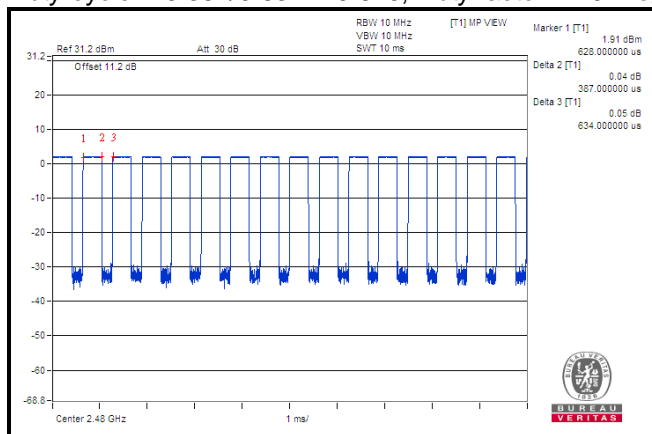

<WLAN>

802.11b: Duty cycle = $8.210/8.415 = 0.976$, Duty factor = $10 * \log(1/0.976) = 0.11$

802.11g: Duty cycle = $1.360/1.562 = 0.871$, Duty factor = $10 * \log(1/0.871) = 0.60$

802.11n (HT20): Duty cycle = $1.267/1.477 = 0.858$, Duty factor = $10 * \log(1/0.858) = 0.67$



3.4 Description of Support Units

The EUT has been tested as an independent unit together with other necessary accessories or support units. The following support units or accessories were used to form a representative test configuration during the tests.

No.	Product	Brand	Model No.	Serial No.	FCC ID
1.	Adapter	SALCOMP	TC U250	N/A	N/A
2.	Cradle	Simula Technology Inc.	CB846E-6040-102	N/A	N/A

No.	Signal Cable Description Of The Above Support Units
1.	1m shielded cable

3.4.1 Configuration of System under Test

<Bluetooth LE & WLAN>

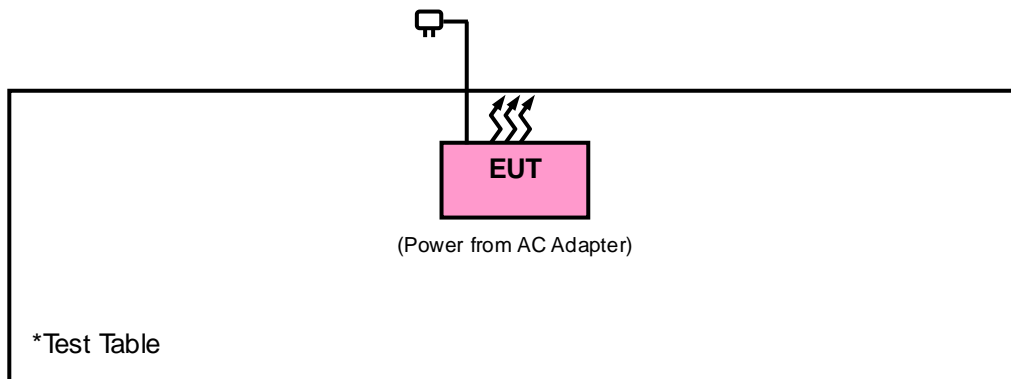

3.5 General Description of Applied Standards

The EUT is a RF Product. According to the specifications of the manufacturer, it must comply with the requirements of the following standards:

FCC Part 15, Subpart C (15.247)

KDB 558074 D01 15.247 Meas Guidance v05r02

ANSI C63.10-2013

All test items have been performed and recorded as per the above standards.

4 Test Types and Results

<BLUETOOTH LE>

4.1 Radiated Emission and Bandedge Measurement

4.1.1 Limits of Radiated Emission and Bandedge Measurement

Radiated emissions which fall in the restricted bands must comply with the radiated emission limits specified as below table. Other emissions shall be at least 20 dB below the highest level of the desired power:

Frequencies (MHz)	Field Strength (microvolts/meter)	Measurement Distance (meters)
0.009 ~ 0.490	2400/F (kHz)	300
0.490 ~ 1.705	24000/F (kHz)	30
1.705 ~ 30.0	30	30
30 ~ 88	100	3
88 ~ 216	150	3
216 ~ 960	200	3
Above 960	500	3

Note:

1. The lower limit shall apply at the transition frequencies.
2. Emission level (dBuV/m) = 20 log Emission level (uV/m).
3. For frequencies above 1000 MHz, the field strength limits are based on average detector, however, the peak field strength of any emission shall not exceed the maximum permitted average limits, specified above by more than 20 dB under any condition of modulation.

4.1.2 Test Instruments

Description & Manufacturer	Model No.	Serial No.	Date Of Calibration	Due Date Of Calibration
Test Receiver Agilent Technologies	N9038A	MY52260177	Aug. 20, 2018	Aug. 19, 2019
Spectrum Analyzer R&S	FSU43	100115	Jan. 21, 2019	Jan. 20, 2020
HORN Antenna ETS-Lindgren	3117	00143293	Nov. 25, 2018	Nov. 24, 2019
BILOG Antenna SCHWARZBECK	VULB 9168	9168-616	Nov. 27, 2018	Nov. 26, 2019
HORN Antenna SCHWARZBECK	BBHA 9170	9170-480	Nov. 25, 2018	Nov. 24, 2019
Fixed Attenuator Mini-Circuits	MDCS18N-10	MDCS18N-10-01	Apr. 16, 2018	Apr. 15, 2019
			Apr. 15, 2019	Apr. 14, 2020
Loop Antenna	EM-6879	269	Sep. 07, 2018	Sep. 06, 2019
Preamplifier Agilent	310N	187226	Jun. 19, 2018	Jun. 18, 2019
Preamplifier Agilent	83017A	MY39501357	Jun. 19, 2018	Jun. 18, 2019
Power Meter Anritsu	ML2495A	1232002	Dec. 17, 2018	Dec. 16, 2019
Power Sensor Anritsu	MA2411B	1207325	Dec. 17, 2018	Dec. 16, 2019
Preamplifier EMCI	EMC 184045	980116	Oct. 12, 2018	Oct. 11, 2019
RF signal cable ETS-LINDGREN	5D-FB	Cable-CH1-01(RFC -SMS-100-SMS-120 +RFC-SMS-100-SM S-400)	Jun. 19, 2018	Jun. 18, 2019
RF signal cable ETS-LINDGREN	8D-FB	Cable-CH1-02(RFC -SMS-100-SMS-24)	Jun. 19, 2018	Jun. 18, 2019
Boresight Antenna Fixture	FBA-01	FBA-SIP01	NA	NA
Software BV ADT	E3 8.130425b	NA	NA	NA
Antenna Tower MF	NA	NA	NA	NA
Turn Table MF	NA	NA	NA	NA
Antenna Tower & Turn Table Controller MF	MF-7802	NA	NA	NA

- Note: 1. The calibration interval of the above test instruments is 12 / 24 months and the calibrations are traceable to NML/ROC and NIST/USA.
2. The test was performed in HsinTien Chamber 1.
3. The horn antenna and preamplifier (model: 83017A) are used only for the measurement of emission frequency above 1 GHz if tested.

4.1.3 Test Procedures

For Radiated Emission below 30 MHz

- a. The EUT was placed on the top of a rotating table 0.8 meters above the ground at a 3 meter chamber room. The table was rotated 360 degrees to determine the position of the highest radiation.
- b. The EUT was set 3 meters away from the interference-receiving antenna, which was mounted on the top of a variable-height antenna tower.
- c. Parallel, perpendicular, and ground-parallel orientations of the antenna are set to make the measurement.
- d. For each suspected emission, the EUT was arranged to its worst case and the rotatable table was turned from 0 degrees to 360 degrees to find the maximum reading.
- e. The test-receiver system was set to Quasi-Peak Detect Function and Specified Bandwidth with Maximum Hold Mode.

Note:

1. The resolution bandwidth and video bandwidth of test receiver/spectrum analyzer is 9 kHz at frequency below 30 MHz.

For Radiated Emission above 30 MHz

- a. The EUT was placed on the top of a rotating table 0.8 meters (for 30 MHz ~ 1 GHz) / 1.5 meters (for above 1 GHz) above the ground at 3 meter chamber room for test. The table was rotated 360 degrees to determine the position of the highest radiation.
- b. The EUT was set 3 meters away from the interference-receiving antenna, which was mounted on the top of a variable-height antenna tower.
- c. The height of antenna is varied from one meter to four meters above the ground to determine the maximum value of the field strength. Both horizontal and vertical polarizations of the antenna are set to make the measurement.
- d. For each suspected emission, the EUT was arranged to its worst case and then the antenna was tuned to heights from 1 meter to 4 meters and the rotatable table was turned from 0 degrees to 360 degrees to find the maximum reading.
- e. The test-receiver system was set to quasi-peak detect function and specified bandwidth with maximum hold mode when the test frequency is below 1 GHz.
- f. The test-receiver system was set to peak and average detected function and specified bandwidth with maximum hold mode when the test frequency is above 1 GHz. If the peak reading value also meets average limit, measurement with the average detector is unnecessary.

Note:

1. The resolution bandwidth and video bandwidth of test receiver/spectrum analyzer is 120 kHz for Quasi-peak detection (QP) or Peak detection (PK) at frequency below 1 GHz.
2. The resolution bandwidth of test receiver/spectrum analyzer is 1 MHz and the video bandwidth is 3 MHz for Peak detection (PK) at frequency above 1 GHz.
3. The resolution bandwidth of test receiver/spectrum analyzer is 1 MHz and the video bandwidth is $\geq 1/T$ (Duty cycle < 98 %) or 10 Hz (Duty cycle ≥ 98 %) for Average detection (AV) at frequency above 1 GHz. (RBW = 1 MHz, VBW = 3 kHz)
4. All modes of operation were investigated and the worst-case emissions are reported.

4.1.4 Deviation from Test Standard

No deviation.

4.1.5 Test Set Up

<Radiated Emission below 30 MHz>

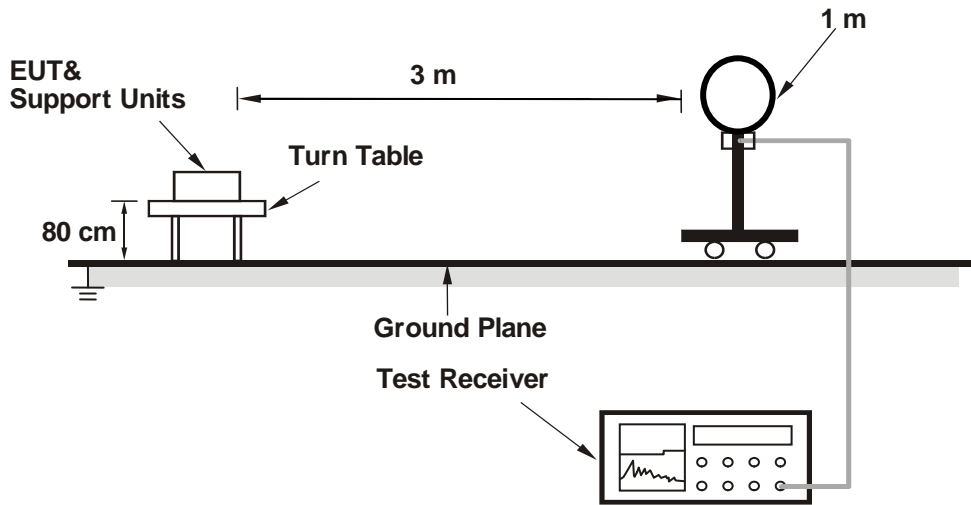

<Radiated Emission 30 MHz to 1 GHz>

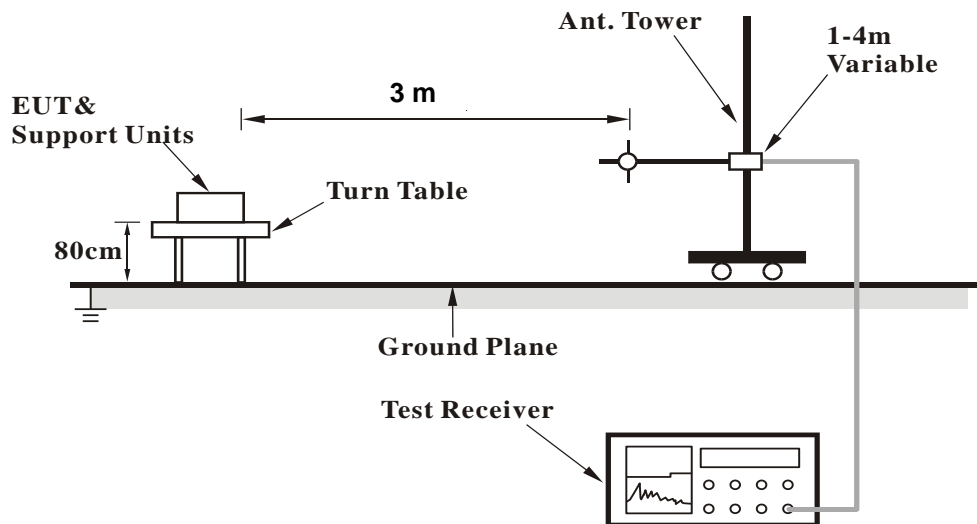

<Radiated Emission above 1 GHz>

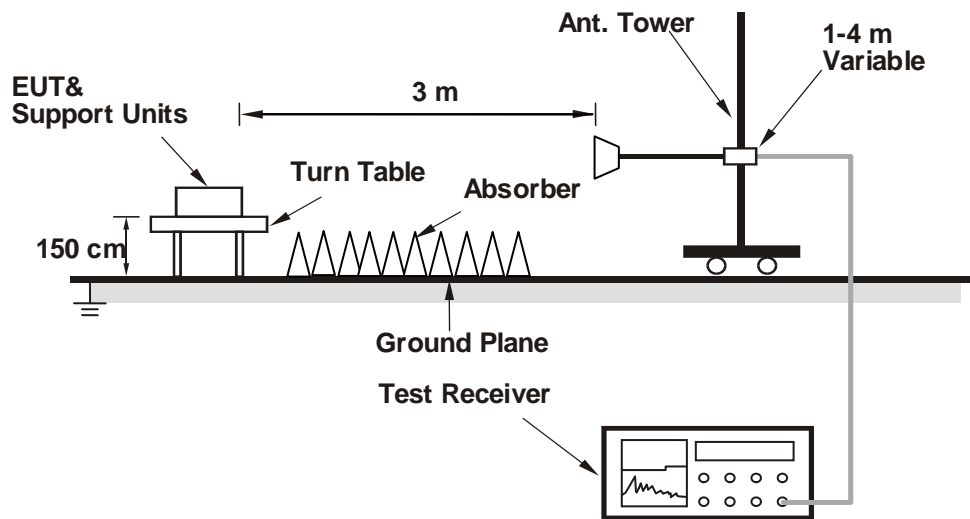

For the actual test configuration, please refer to the attached file (Test Setup Photo).

4.1.6 EUT Operating Conditions

- Placed the EUT on the testing table.
- Set the EUT under transmission condition continuously at specific channel frequency.

4.1.7 Test Results

Above 1 GHz Data:

EUT Test Condition		Measurement Detail	
Channel	Channel 0	Frequency Range	1 GHz ~ 25 GHz
Input Power	120 Vac, 60 Hz	Detector Function	Peak (PK) Average (AV)
Environmental Conditions	25 deg. C, 65 % RH	Tested By	Karl Lee

Horizontal

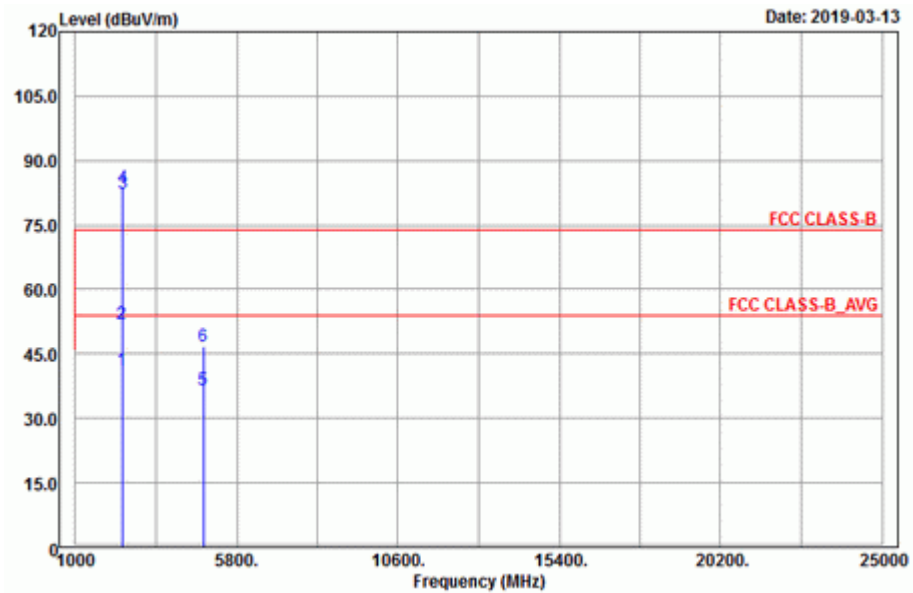

Vertical

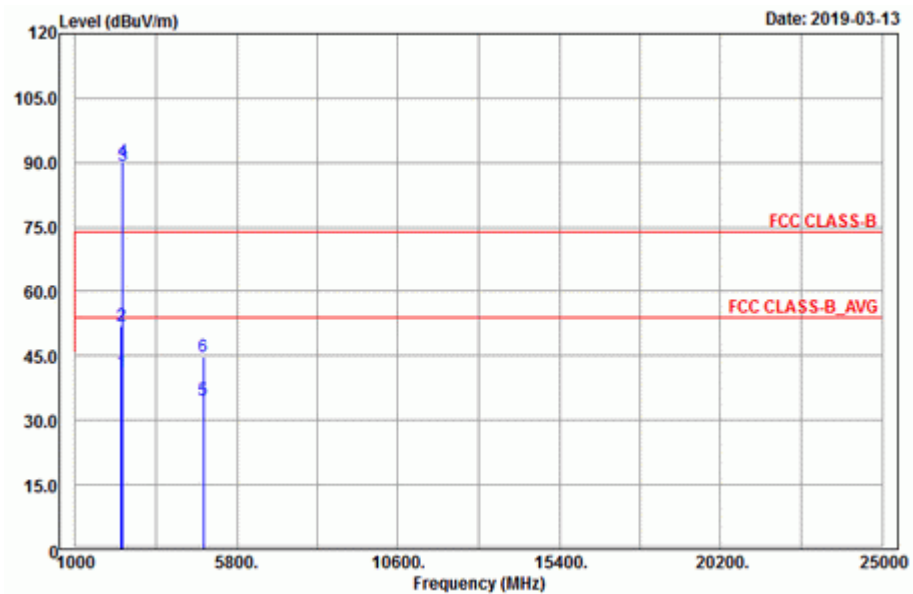

Antenna Polarity & Test Distance: Horizontal at 3 m

Frequency (MHz)	Emission Level (dBuV/m)	Read Level (dBuV)	Factor (dB/m)	Limit (dBuV/m)	Margin (dB)	Antenna Height (cm)	Table Angle (Degree)	Remark
2386.5	41.27	39.56	1.71	54	-12.73	278	268	Average
2386.5	51.85	50.14	1.71	74	-22.15	278	268	Peak
2402	82.52	80.79	1.73			278	268	Average
2402	83.61	81.88	1.73			278	268	Peak
4804	36.53	28.44	8.09	54	-17.47	150	165	Average
4804	46.7	38.61	8.09	74	-27.3	150	165	Peak

Antenna Polarity & Test Distance: Vertical at 3 m

Frequency (MHz)	Emission Level (dBuV/m)	Read Level (dBuV)	Factor (dB/m)	Limit (dBuV/m)	Margin (dB)	Antenna Height (cm)	Table Angle (Degree)	Remark
2374.62	41.08	39.42	1.66	54	-12.92	184	352	Average
2374.62	51.89	50.23	1.66	74	-22.11	184	352	Peak
2402	89.37	87.64	1.73			184	352	Average
2402	90.22	88.49	1.73			184	352	Peak
4804	34.76	26.67	8.09	54	-19.24	185	274	Average
4804	44.88	36.79	8.09	74	-29.12	185	274	Peak

Remarks:

- Emission Level = Read Level + Factor
Margin value = Emission level – Limit value
- 2402 MHz: Fundamental frequency.
- The emission levels of other frequencies were very low against the limit.

EUT Test Condition		Measurement Detail	
Channel	Channel 19	Frequency Range	1 GHz ~ 25 GHz
Input Power	120 Vac, 60 Hz	Detector Function	Peak (PK) Average (AV)
Environmental Conditions	25 deg. C, 65 % RH	Tested By	Karl Lee

Horizontal

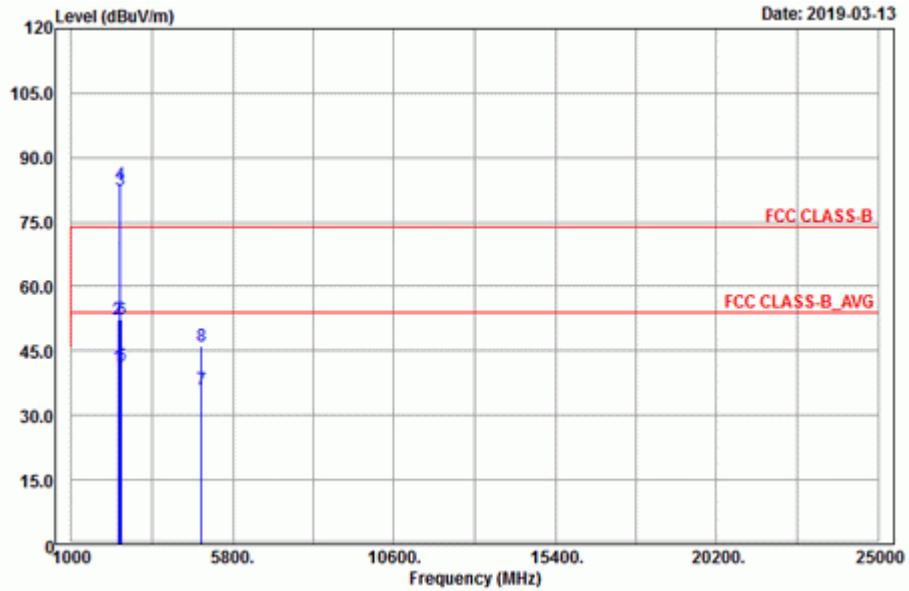

Vertical

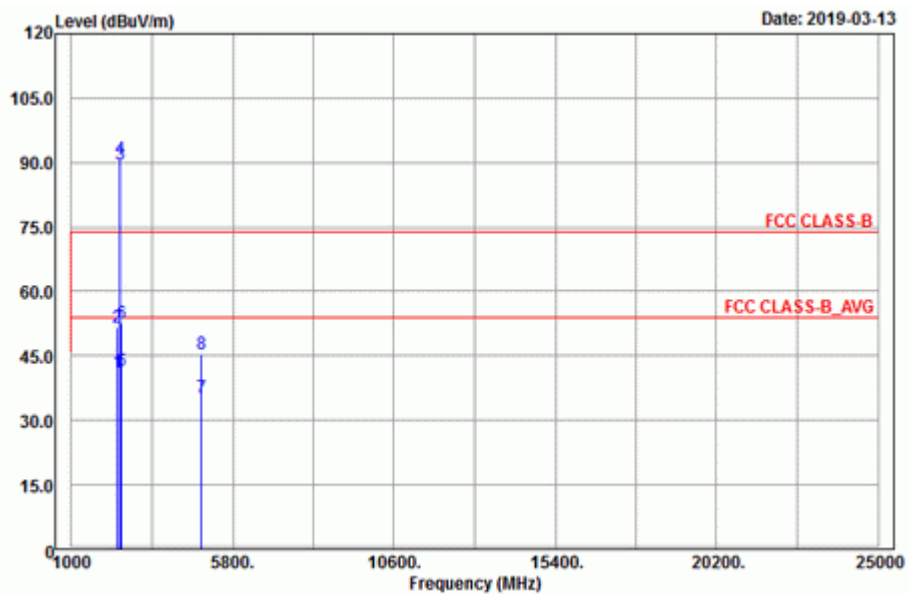

Antenna Polarity & Test Distance: Horizontal at 3 m

Frequency (MHz)	Emission Level (dBuV/m)	Read Level (dBuV)	Factor (dB/m)	Limit (dBuV/m)	Margin (dB)	Antenna Height (cm)	Table Angle (Degree)	Remark
2382.72	41.1	39.41	1.69	54	-12.9	278	268	Average
2382.72	52.24	50.55	1.69	74	-21.76	278	268	Peak
2440	82.46	80.61	1.85			278	268	Average
2440	83.63	81.78	1.85			278	268	Peak
2490.08	41.52	39.51	2.01	54	-12.48	278	268	Average
2490.08	52.29	50.28	2.01	74	-21.71	278	268	Peak
4880	36.12	27.93	8.19	54	-17.88	138	117	Average
4880	46.05	37.86	8.19	74	-27.95	138	117	Peak

Antenna Polarity & Test Distance: Vertical at 3 m

Frequency (MHz)	Emission Level (dBuV/m)	Read Level (dBuV)	Factor (dB/m)	Limit (dBuV/m)	Margin (dB)	Antenna Height (cm)	Table Angle (Degree)	Remark
2370.48	41.18	39.52	1.66	54	-12.82	184	352	Average
2370.48	51.77	50.11	1.66	74	-22.23	184	352	Peak
2440	89.75	87.9	1.85			184	352	Average
2440	90.78	88.93	1.85			184	352	Peak
2484.44	41.61	39.62	1.99	54	-12.39	184	352	Average
2484.44	52.54	50.55	1.99	74	-21.46	184	352	Peak
4880	35.24	27.05	8.19	54	-18.76	165	226	Average
4880	45.31	37.12	8.19	74	-28.69	165	226	Peak

Remarks:

- Emission Level = Read Level + Factor
Margin value = Emission level – Limit value
- 2440 MHz: Fundamental frequency.
- The emission levels of other frequencies were very low against the limit.

EUT Test Condition		Measurement Detail	
Channel	Channel 39	Frequency Range	1 GHz ~ 25 GHz
Input Power	120 Vac, 60 Hz	Detector Function	Peak (PK) Average (AV)
Environmental Conditions	25 deg. C, 65 % RH	Tested By	Karl Lee

Horizontal

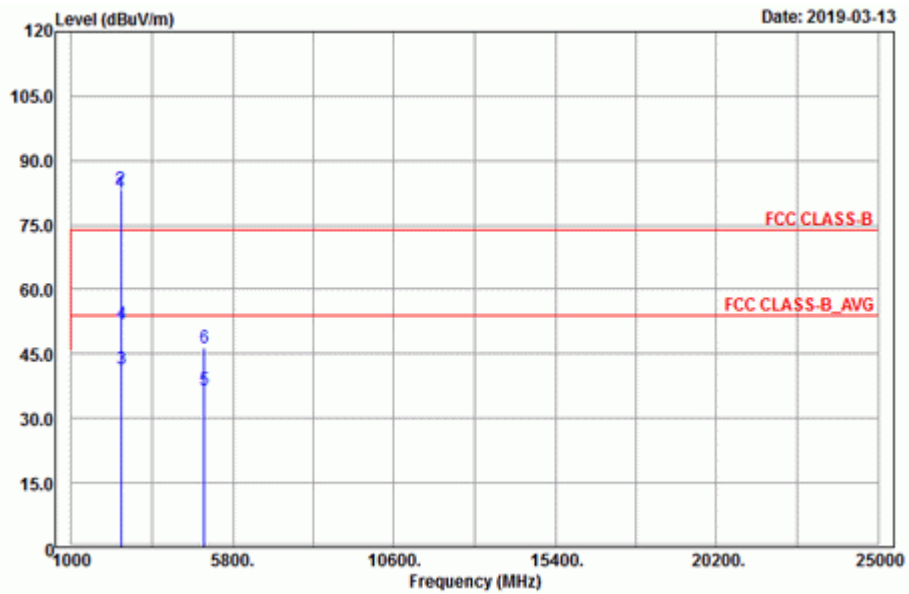

Vertical

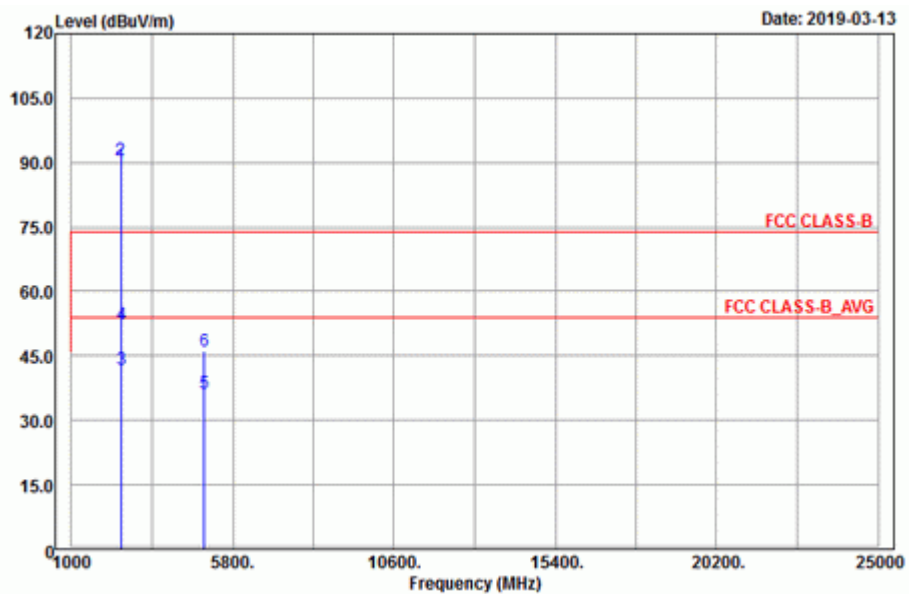

Antenna Polarity & Test Distance: Horizontal at 3 m								
Frequency (MHz)	Emission Level (dBuV/m)	Read Level (dBuV)	Factor (dB/m)	Limit (dBuV/m)	Margin (dB)	Antenna Height (cm)	Table Angle (Degree)	Remark
2480	82.37	80.41	1.96			270	224	Average
2480	83.27	81.31	1.96			270	224	Peak
2483.56	41.58	39.62	1.96	54	-12.42	270	224	Average
2483.56	52.04	50.08	1.96	74	-21.96	270	224	Peak
4960	36.47	28.2	8.27	54	-17.53	168	205	Average
4960	46.52	38.25	8.27	74	-27.48	168	205	Peak
Antenna Polarity & Test Distance: Vertical at 3 m								
Frequency (MHz)	Emission Level (dBuV/m)	Read Level (dBuV)	Factor (dB/m)	Limit (dBuV/m)	Margin (dB)	Antenna Height (cm)	Table Angle (Degree)	Remark
2480	89.24	87.28	1.96			184	352	Average
2480	90.6	88.64	1.96			184	352	Peak
2483.88	41.7	39.74	1.96	54	-12.3	184	352	Average
2483.88	52.33	50.37	1.96	74	-21.67	184	352	Peak
4960	36.15	27.88	8.27	54	-17.85	120	95	Average
4960	46.23	37.96	8.27	74	-27.77	120	95	Peak

Remarks:

1. Emission Level = Read Level + Factor
Margin value = Emission level – Limit value
2. 2480 MHz: Fundamental frequency.
3. The emission levels of other frequencies were very low against the limit.

9 kHz ~ 30 MHz Data:

The amplitude of spurious emissions attenuated more than 20 dB below the permissible value is not required to be report.

30 MHz ~ 1 GHz Worst-Case Data:

EUT Test Condition		Measurement Detail	
Channel	Channel 39	Frequency Range	30 MHz ~ 1 GHz
Input Power	120 Vac, 60 Hz	Detector Function	Peak (PK) Quasi-peak (QP)
Environmental Conditions	25 deg. C, 65 % RH	Tested By	Karl Lee

Horizontal

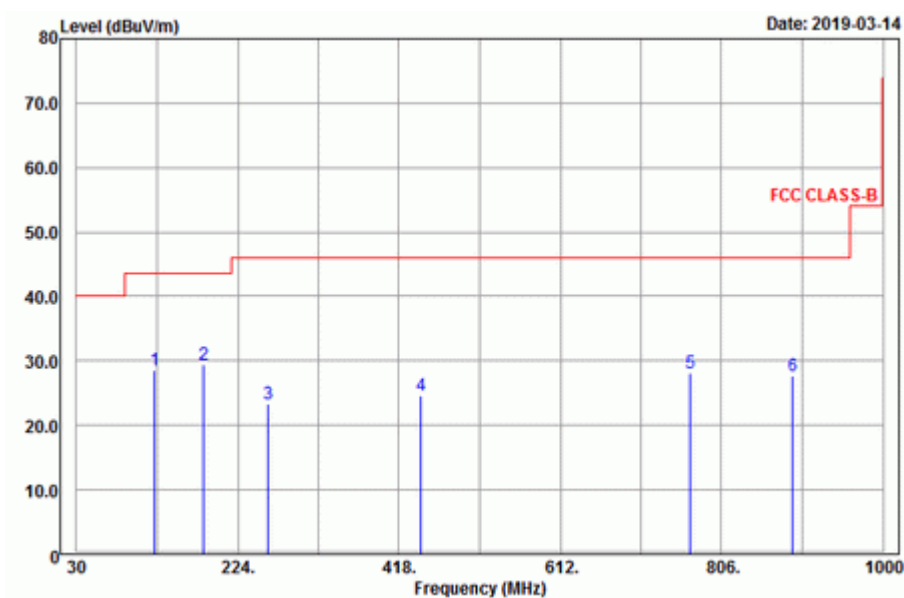

Vertical

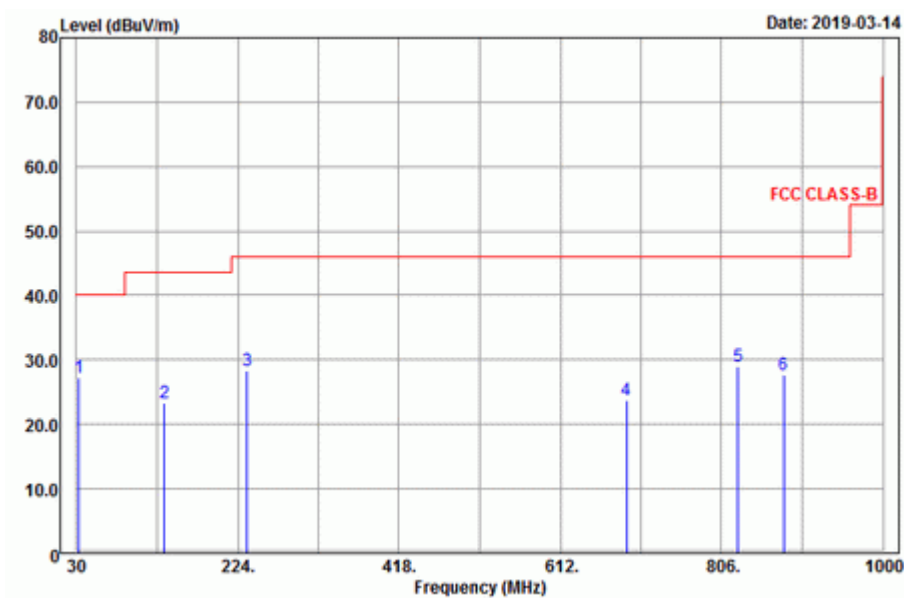

Antenna Polarity & Test Distance: Horizontal at 3 m

Frequency (MHz)	Emission Level (dBuV/m)	Read Level (dBuV)	Factor (dB/m)	Limit (dBuV/m)	Margin (dB)	Antenna Height (cm)	Table Angle (Degree)	Remark
123.69	28.54	49.73	-21.19	43.5	-14.96	149	65	Peak
183.09	29.5	50.11	-20.61	43.5	-14	110	114	Peak
260.58	23.29	40.95	-17.66	46	-22.71	124	255	Peak
444.9	24.6	38.77	-14.17	46	-21.4	157	77	Peak
768.3	28.04	36.93	-8.89	46	-17.96	136	200	Peak
891.5	27.59	34.24	-6.65	46	-18.41	195	5	Peak

Antenna Polarity & Test Distance: Vertical at 3 m

Frequency (MHz)	Emission Level (dBuV/m)	Read Level (dBuV)	Factor (dB/m)	Limit (dBuV/m)	Margin (dB)	Antenna Height (cm)	Table Angle (Degree)	Remark
32.97	27.32	47.09	-19.77	40	-12.68	145	222	Peak
136.11	23.38	45.6	-22.22	43.5	-20.12	124	326	Peak
235.47	28.35	46.7	-18.35	46	-17.65	119	59	Peak
691.3	23.75	33.69	-9.94	46	-22.25	124	174	Peak
825.7	29.1	36.93	-7.83	46	-16.9	154	199	Peak
881	27.69	34.46	-6.77	46	-18.31	187	77	Peak

Remarks:

- Emission Level = Read Level + Factor
Margin value = Emission level – Limit value
- The emission levels of other frequencies were very low against the limit.

4.2 Conducted Emission Measurement

4.2.1 Limits of Conducted Emission Measurement

Frequency (MHz)	Conducted Limit (dBuV)	
	Quasi-Peak	Average
0.15 - 0.5	66 - 56	56 - 46
0.50 - 5.0	56	46
5.0 - 30.0	60	50

- Note: 1. The lower limit shall apply at the transition frequencies.
 2. The limit decreases in line with the logarithm of the frequency in the range of 0.15 to 0.50 MHz.

4.2.2 Test Instruments

Description & Manufacturer	Model No.	Serial No.	Date of Calibration	Due Date of Calibration
Test Receiver ROHDE & SCHWARZ	ESCI	100613	Dec. 10, 2018	Dec. 09, 2019
RF signal cable Woken	5D-FB	Cable-cond1-01	Sep. 05, 2018	Sep. 04, 2019
LISN/AMN ROHDE & SCHWARZ (EUT)	ENV216	101826	Feb. 21, 2019	Feb. 20, 2020
LISN/AMN ROHDE & SCHWARZ (Peripheral)	ESH3-Z5	100311	Aug. 19, 2018	Aug. 18, 2019
Software ADT	BV ADT_Cond_ V7.3.7.4	NA	NA	NA

- Note: 1. The calibration interval of the above test instruments is 12 months and the calibrations are traceable to NML/ROC and NIST/USA.
 2. The test was performed in HwaYa Shielded Room 1.
 3. The VCCI Site Registration No. is C-12040.

4.2.3 Test Procedures

- The EUT was placed 0.4 meters from the conducting wall of the shielded room with EUT being connected to the power mains through a line impedance stabilization network (LISN). Other support units were connected to the power mains through another LISN. The two LISNs provide 50 ohm/50 uH of coupling impedance for the measuring instrument.
- Both lines of the power mains connected to the EUT were checked for maximum conducted interference.
- The frequency range from 150 kHz to 30 MHz was searched. Emission levels under (Limit – 20 dB) was not recorded.

Note: The resolution bandwidth and video bandwidth of test receiver is 9 kHz for quasi-peak detection (QP) and average detection (AV) at frequency 0.15 MHz - 30 MHz.

4.2.4 Deviation from Test Standard

No deviation.

4.2.5 Test Setup

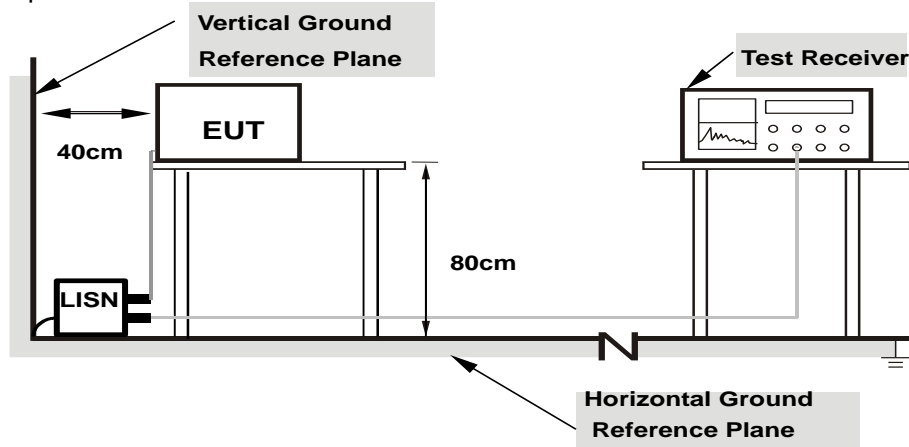

**Note: 1.Support units were connected to second LISN.
2.Both of LISNs (AMN) are 80 cm from EUT and at least 80 from other units and other metal planes**

4.2.6 EUT Operating Conditions

- Placed the EUT on the testing table.
- Set the EUT under transmission condition continuously at specific channel frequency.

4.2.7 Test Results

Frequency Range	150kHz ~ 30MHz	Detector Function & Resolution Bandwidth	Quasi-Peak (QP) / Average (AV), 9kHz
Input Power	120Vac, 60Hz	Environmental Conditions	25°C, 65%RH
Tested by	Thomas Wei	Test Date	2019/3/19

Phase Of Power : Line (L)										
No	Frequency (MHz)	Correction Factor (dB)	Reading Value (dBuV)		Emission Level (dBuV)		Limit (dBuV)		Margin (dB)	
			Q.P.	AV.	Q.P.	AV.	Q.P.	AV.	Q.P.	AV.
1	0.15000	9.69	32.44	15.66	42.13	25.35	66.00	56.00	-23.87	-30.65
2	0.17384	9.69	24.28	7.60	33.97	17.29	64.77	54.77	-30.80	-37.48
3	0.19780	9.68	23.09	5.24	32.77	14.92	63.70	53.70	-30.93	-38.78
4	0.22600	9.68	23.38	6.77	33.06	16.45	62.60	52.60	-29.54	-36.15
5	0.26921	9.68	19.01	3.38	28.69	13.06	61.14	51.14	-32.45	-38.08
6	0.32203	9.68	16.30	1.43	25.98	11.11	59.65	49.65	-33.67	-38.54

Remarks:

1. Q.P. and AV. are abbreviations of quasi-peak and average individually.
2. The emission levels of other frequencies were very low against the limit.
3. Margin value = Emission level – Limit value
4. Correction factor = Insertion loss + Cable loss
5. Emission Level = Correction Factor + Reading Value

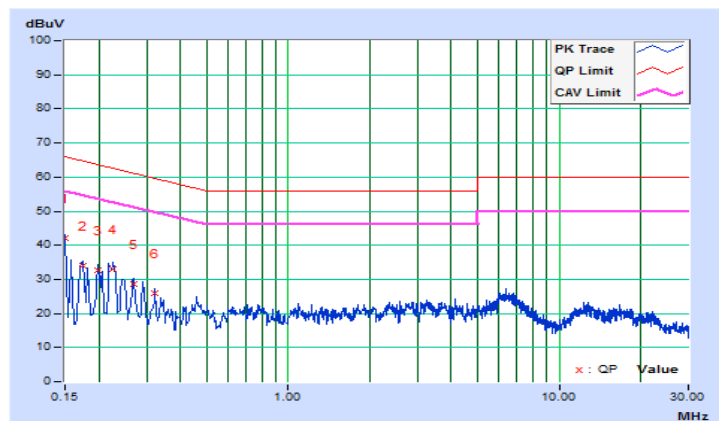

Frequency Range	150kHz ~ 30MHz	Detector Function & Resolution Bandwidth	Quasi-Peak (QP) / Average (AV), 9kHz
Input Power	120Vac, 60Hz	Environmental Conditions	25°C, 65%RH
Tested by	Thomas Wei	Test Date	2019/3/19

Phase Of Power : Neutral (N)										
No	Frequency (MHz)	Correction Factor (dB)	Reading Value (dBuV)		Emission Level (dBuV)		Limit (dBuV)		Margin (dB)	
			Q.P.	AV.	Q.P.	AV.	Q.P.	AV.	Q.P.	AV.
1	0.15800	9.66	30.34	14.16	40.00	23.82	65.57	55.57	-25.57	-31.75
2	0.18200	9.66	27.33	9.20	36.99	18.86	64.39	54.39	-27.40	-35.53
3	0.20600	9.66	23.61	8.46	33.27	18.12	63.37	53.37	-30.10	-35.25
4	0.23000	9.66	23.22	6.16	32.88	15.82	62.45	52.45	-29.57	-36.63
5	0.24614	9.66	22.59	5.73	32.25	15.39	61.89	51.89	-29.64	-36.50
6	0.45596	9.65	15.30	1.50	24.95	11.15	56.77	46.77	-31.82	-35.62

Remarks:

1. Q.P. and AV. are abbreviations of quasi-peak and average individually.
2. The emission levels of other frequencies were very low against the limit.
3. Margin value = Emission level – Limit value
4. Correction factor = Insertion loss + Cable loss
5. Emission Level = Correction Factor + Reading Value

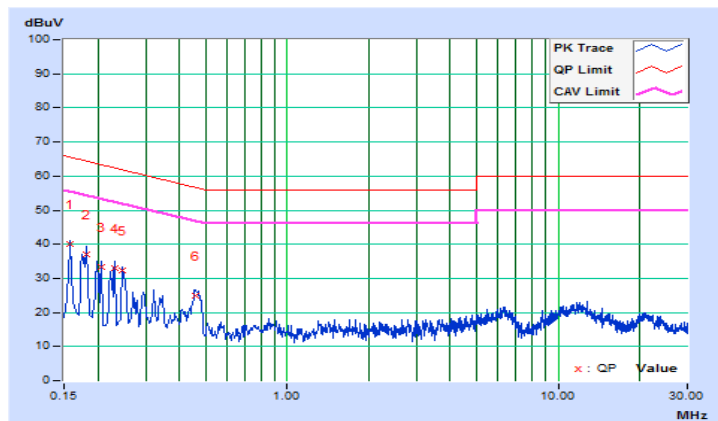

4.3 6 dB Bandwidth Measurement

4.3.1 Limits of 6 dB Bandwidth Measurement

The minimum of 6 dB Bandwidth Measurement is 0.5 MHz.

4.3.2 Test Setup

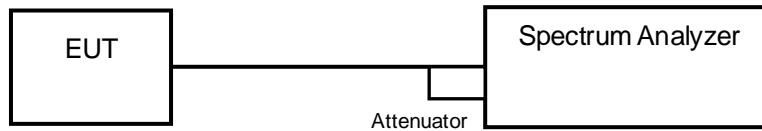

4.3.3 Test Instruments

Refer to section 4.1.2 to get information of above instrument.

4.3.4 Test Procedure

- Set resolution bandwidth (RBW) = 100 kHz
- Set the video bandwidth (VBW) $\geq 3 \times$ RBW, Detector = Peak.
- Trace mode = max hold.
- Sweep = auto couple.
- Measure the maximum width of the emission that is constrained by the frequencies associated with the two amplitude points (upper and lower) that are attenuated by 6 dB relative to the maximum level measured in the fundamental emission

4.3.5 Deviation from Test Standard

No deviation.

4.3.6 EUT Operating Conditions

The software provided by client to enable the EUT under transmission condition continuously at lowest, middle and highest channel frequencies individually.

4.3.7 Test Results

Channel	Frequency (MHz)	6 dB Bandwidth (MHz)	Minimum Limit (MHz)	Pass / Fail
0	2402	0.68	0.5	Pass
19	2440	0.70	0.5	Pass
39	2480	0.68	0.5	Pass

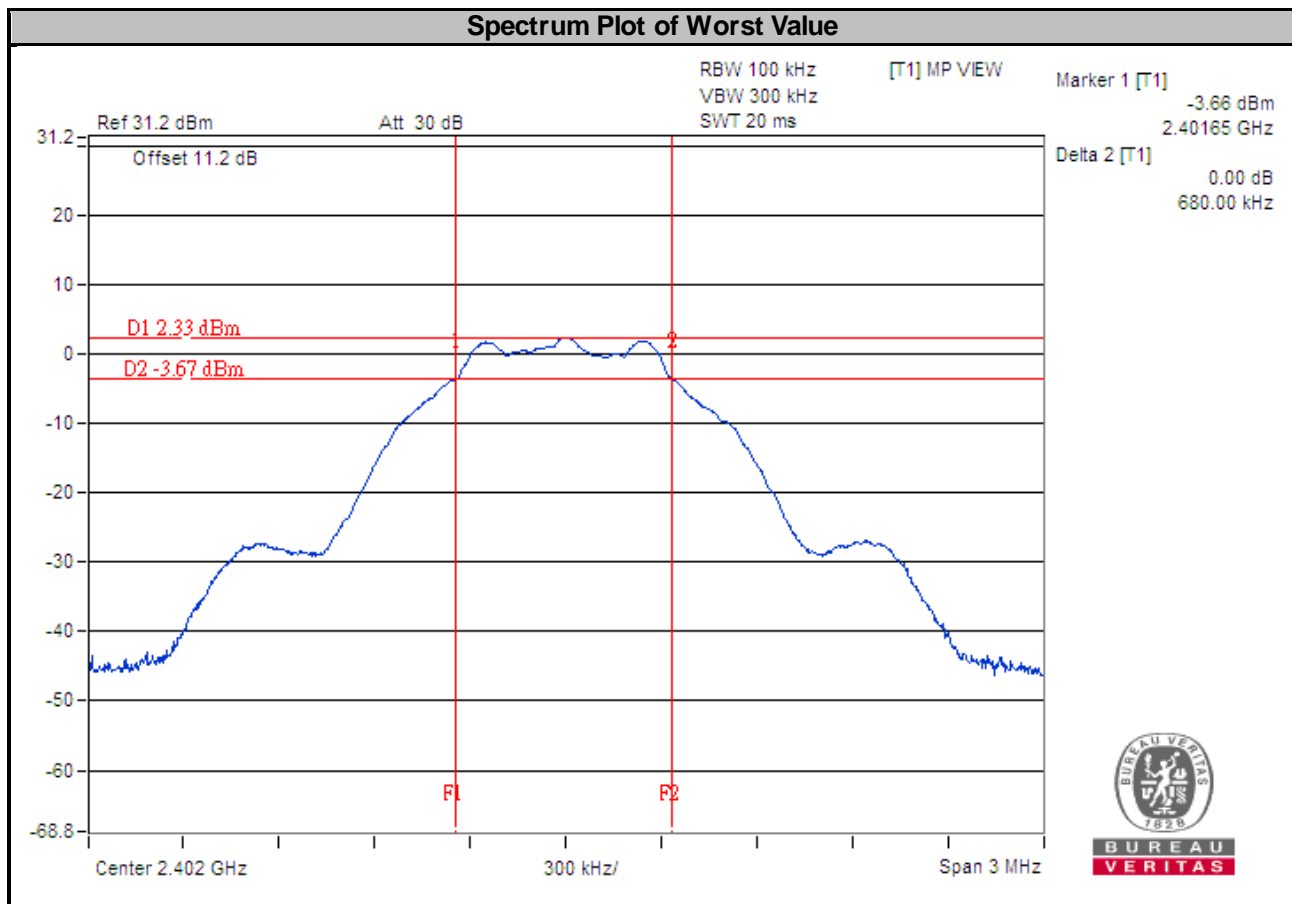

4.4 Occupied Bandwidth Measurement

4.4.1 Test Setup

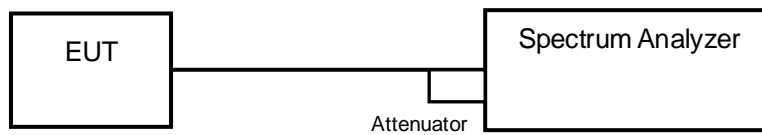

4.4.2 Test Instruments

Refer to section 4.1.2 to get information of above instrument.

4.4.3 Test Procedure

The transmitter output was connected to the spectrum analyzer through an attenuator. The bandwidth of the fundamental frequency was measured by spectrum analyzer with resolution bandwidth in the range of 1 % to 5 % of the anticipated emission bandwidth, and a video bandwidth at least 3x the resolution bandwidth and set the detector to PEAK. The width of a frequency band such that, below the lower and above the upper frequency limits, the mean powers emitted are each equal to a specified percentage 0.5 % of the total mean power of a given emission.

4.4.4 Deviation from Test Standard

No deviation.

4.4.5 EUT Operating Conditions

The software provided by client to enable the EUT under transmission condition continuously at lowest, middle and highest channel frequencies individually.

4.4.6 Test Results

Channel	Frequency (MHz)	Occupied Bandwidth (MHz)	Pass / Fail
0	2402	1.06	Pass
19	2440	1.06	Pass
39	2480	1.06	Pass

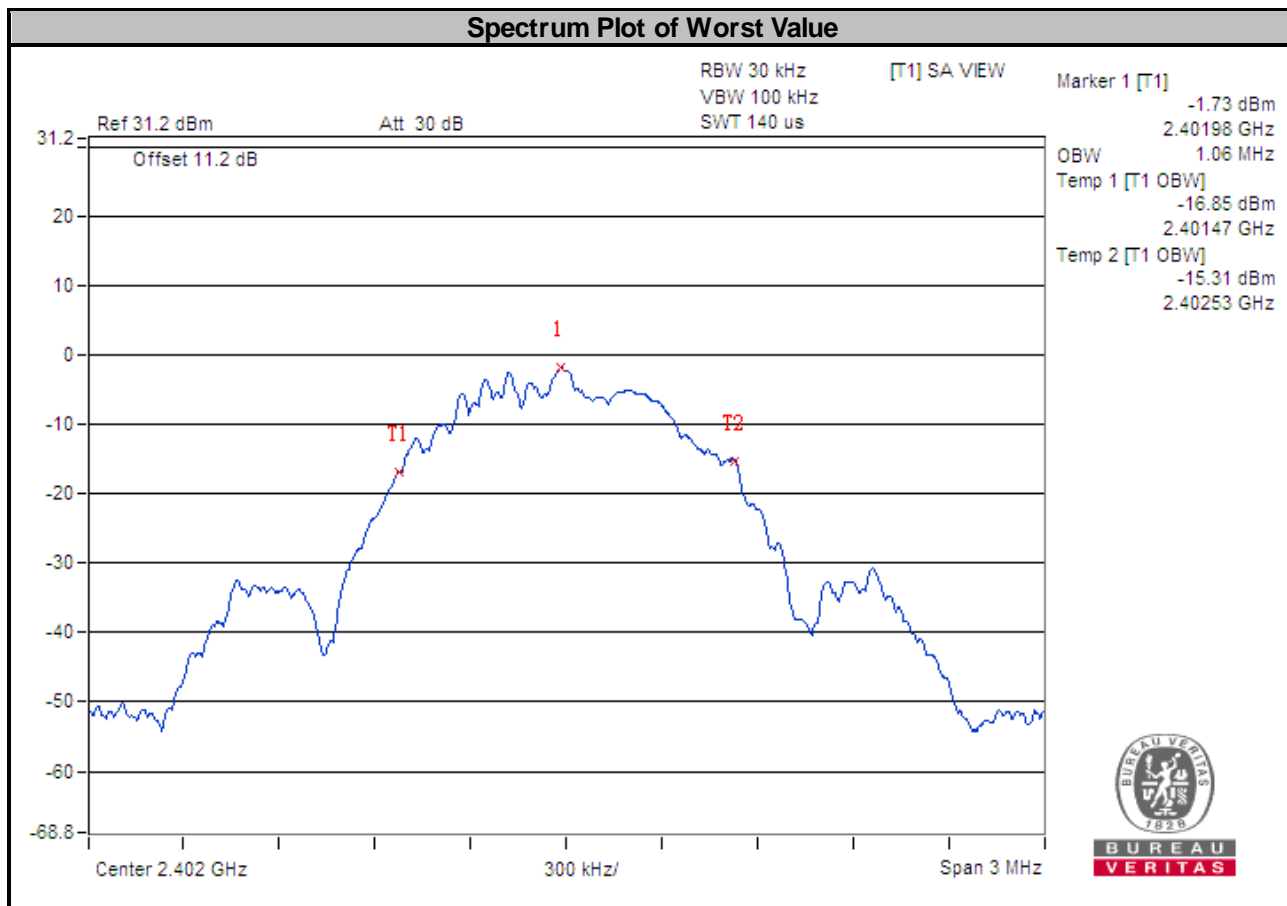

4.5 Conducted Output Power Measurement

4.5.1 Limits of Conducted Output Power Measurement

For systems using digital modulation in the 2400–2483.5 MHz bands: 1 Watt (30 dBm)

4.5.2 Test Setup

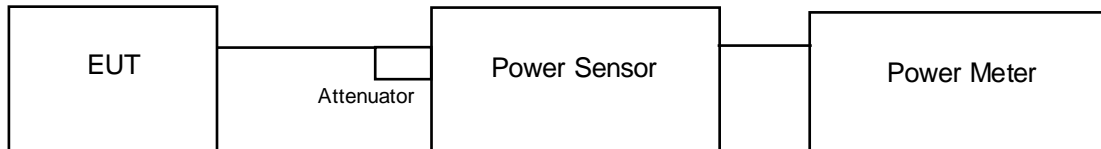

4.5.3 Test Instruments

Refer to section 4.1.2 to get information of above instrument.

4.5.4 Test Procedures

A peak power sensor was used on the output port of the EUT. A power meter was used to read the response of the peak power sensor. Record the power level.

4.5.5 Deviation from Test Standard

No deviation.

4.5.6 EUT Operating Conditions

The software provided by client to enable the EUT under transmission condition continuously at lowest, middle and highest channel frequencies individually.

4.5.7 Test Results

Channel	Frequency (MHz)	Peak Power (mW)	Peak Power (dBm)	Limit (dBm)	Pass / Fail
0	2402	1.941	2.88	30	Pass
19	2440	1.858	2.69	30	Pass
39	2480	1.75	2.43	30	Pass

4.6 Power Spectral Density Measurement

4.6.1 Limits of Power Spectral Density Measurement

The Maximum of Power Spectral Density Measurement is 8 dBm.

4.6.2 Test Setup

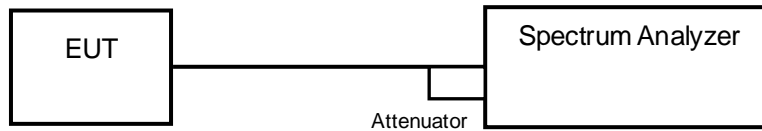

4.6.3 Test Instruments

Refer to section 4.1.2 to get information of above instrument.

4.6.4 Test Procedure

- a. Set analyzer center frequency to DTS channel center frequency.
- b. Set the span to 1.5 times the DTS bandwidth.
- c. Set the RBW to: $3 \text{ kHz} \leq \text{RBW} \leq 100 \text{ kHz}$.
- d. Set the VBW $\geq 3 \times \text{RBW}$.
- e. Detector = peak.
- f. Sweep time = auto couple.
- g. Trace mode = max hold.
- h. Allow trace to fully stabilize.
- i. Use the peak marker function to determine the maximum amplitude level within the RBW.

4.6.5 Deviation from Test Standard

No deviation.

4.6.6 EUT Operating Condition

The software provided by client to enable the EUT under transmission condition continuously at lowest, middle and highest channel frequencies individually.

4.6.7 Test Results

Channel	Frequency (MHz)	PSD (dBm/3 kHz)	Limit (dBm/3 kHz)	Pass / Fail
0	2402	-12.42	8	Pass
19	2440	-12.76	8	Pass
39	2480	-13.28	8	Pass

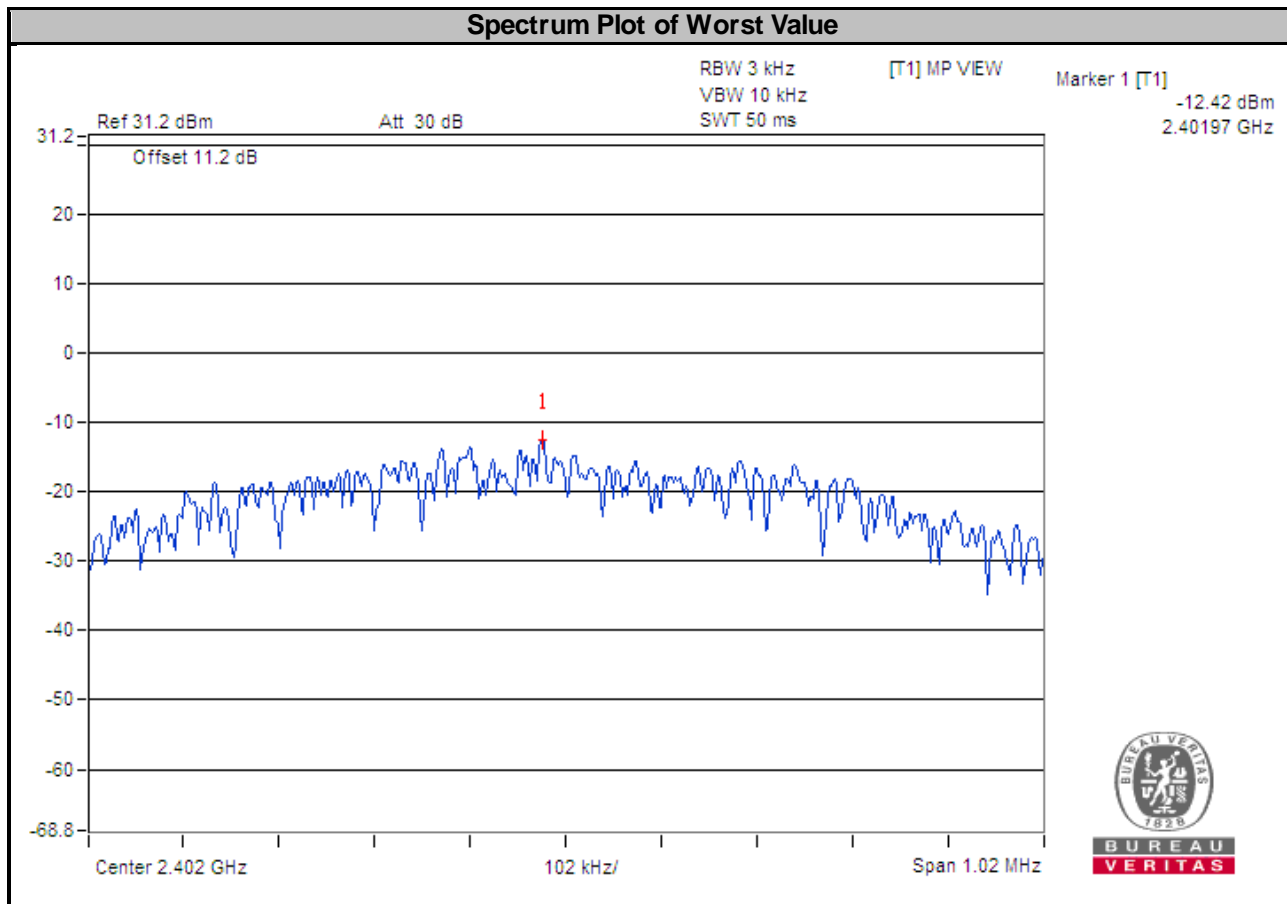

4.7 Conducted Out of Band Emission Measurement

4.7.1 Limits of Conducted Out of Band Emission Measurement

Below -20 dB of the highest emission level of operating band (in 100 kHz Resolution Bandwidth).

4.7.2 Test Setup

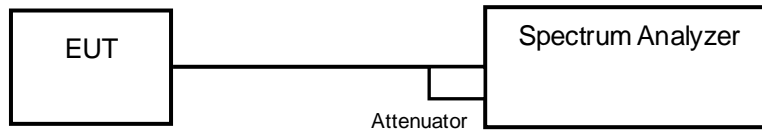

4.7.3 Test Instruments

Refer to section 4.1.2 to get information of above instrument.

4.7.4 Test Procedure

MEASUREMENT PROCEDURE REF

1. Set the RBW = 100 kHz.
2. Set the VBW \geq 300 kHz.
3. Detector = peak.
4. Sweep time = auto couple.
5. Trace mode = max hold.
6. Allow trace to fully stabilize.
7. Use the peak marker function to determine the maximum power level in any 100 kHz band segment within the fundamental EBW.

MEASUREMENT PROCEDURE OOB

1. Set RBW = 100 kHz.
2. Set VBW \geq 300 kHz.
3. Detector = peak.
4. Sweep = auto couple.
5. Trace Mode = max hold.
6. Allow trace to fully stabilize.
7. Use the peak marker function to determine the maximum amplitude level.

4.7.5 Deviation from Test Standard

No deviation.

4.7.6 EUT Operating Condition

The software provided by client to enable the EUT under transmission condition continuously at lowest, middle and highest channel frequencies individually.

4.7.7 Test Results

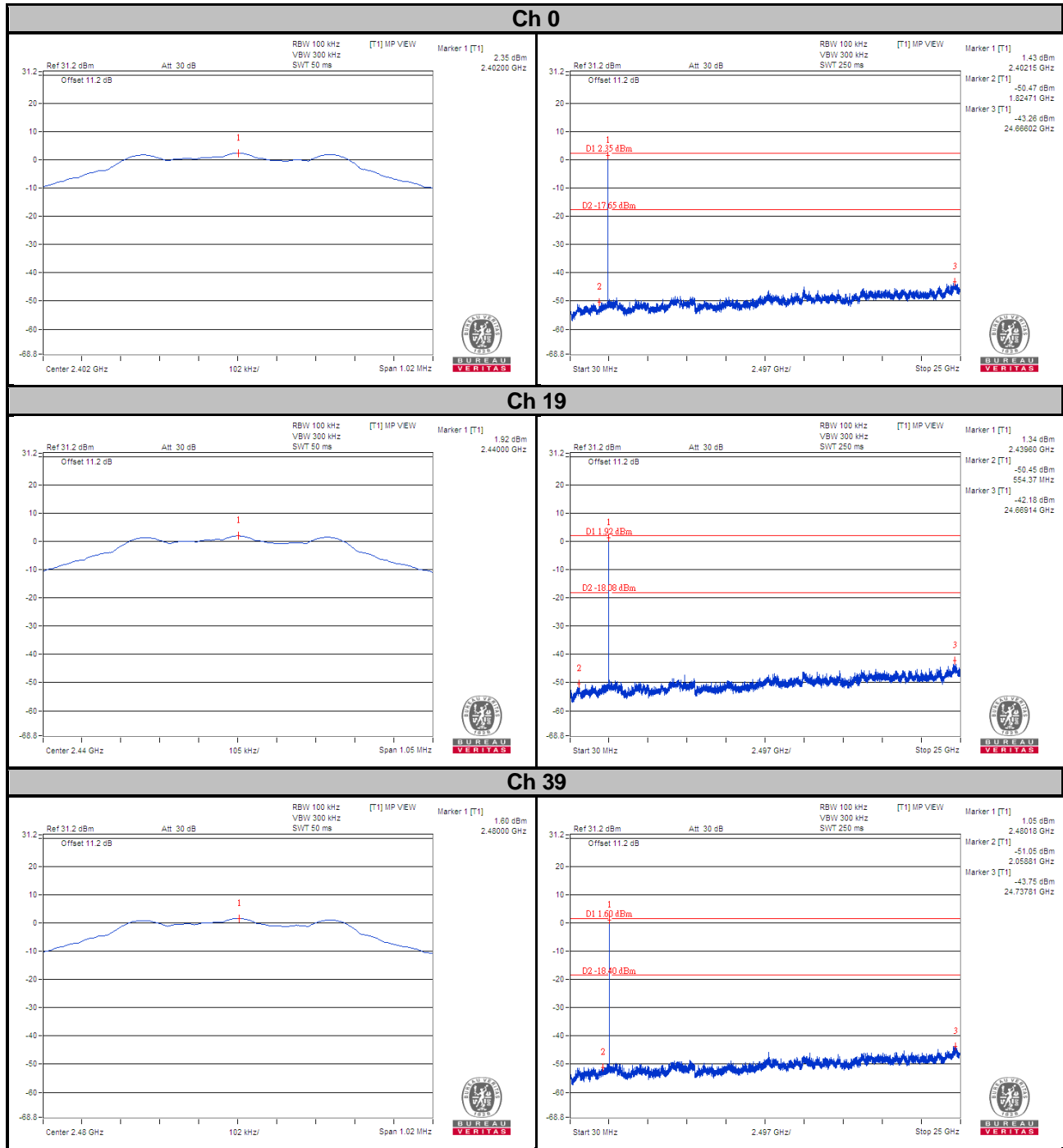

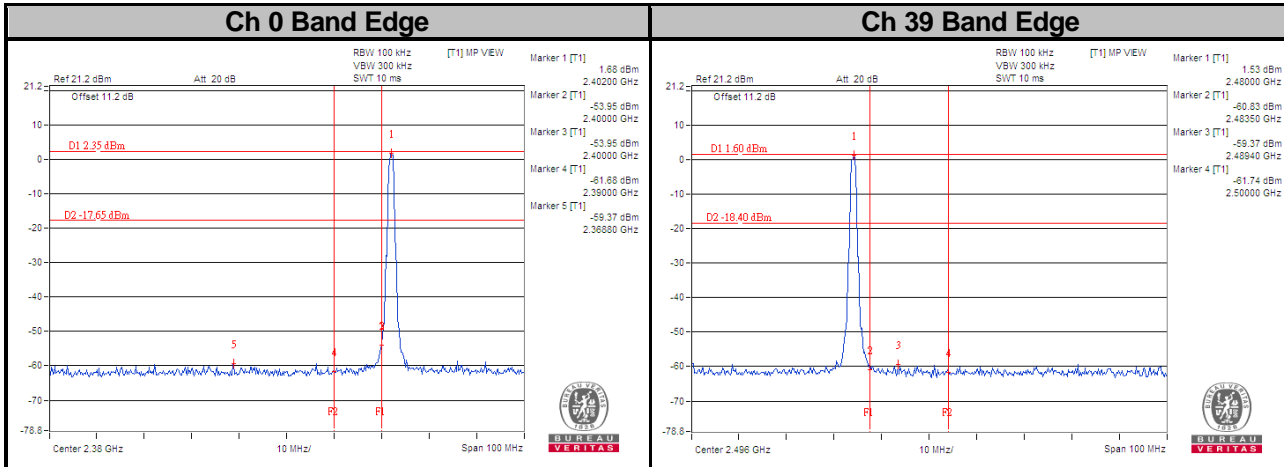

<WLAN>

4.8 Radiated Emission and Bandedge Measurement

4.8.1 Limits of Radiated Emission and Bandedge Measurement

Radiated emissions which fall in the restricted bands must comply with the radiated emission limits specified as below table. Other emissions shall be at least 20 dB below the highest level of the desired power:

Frequencies (MHz)	Field Strength (microvolts/meter)	Measurement Distance (meters)
0.009 ~ 0.490	2400/F (kHz)	300
0.490 ~ 1.705	24000/F (kHz)	30
1.705 ~ 30.0	30	30
30 ~ 88	100	3
88 ~ 216	150	3
216 ~ 960	200	3
Above 960	500	3

NOTE:

1. The lower limit shall apply at the transition frequencies.
2. Emission level (dBuV/m) = 20 log Emission level (uV/m).
3. For frequencies above 1000 MHz, the field strength limits are based on average detector, however, the peak field strength of any emission shall not exceed the maximum permitted average limits, specified above by more than 20 dB under any condition of modulation.

4.8.2 Test Instruments

Refer to section 4.1.2.

4.8.3 Test Procedures

For Radiated Emission below 30 MHz

- a. The EUT was placed on the top of a rotating table 0.8 meters above the ground at a 3 meter chamber room. The table was rotated 360 degrees to determine the position of the highest radiation.
- b. The EUT was set 3 meters away from the interference-receiving antenna, which was mounted on the top of a variable-height antenna tower.
- c. Parallel, perpendicular, and ground-parallel orientations of the antenna are set to make the measurement.
- d. For each suspected emission, the EUT was arranged to its worst case and the rotatable table was turned from 0 degrees to 360 degrees to find the maximum reading.
- e. The test-receiver system was set to Quasi-Peak Detect Function and Specified Bandwidth with Maximum Hold Mode.

Note:

1. The resolution bandwidth and video bandwidth of test receiver/spectrum analyzer is 9 kHz at frequency below 30 MHz.

For Radiated Emission above 30 MHz

- a. The EUT was placed on the top of a rotating table 0.8 meters (for 30 MHz ~ 1 GHz) / 1.5 meters (for above 1 GHz) above the ground at 3 meter chamber room for test. The table was rotated 360 degrees to determine the position of the highest radiation.
- b. The EUT was set 3 meters away from the interference-receiving antenna, which was mounted on the top of a variable-height antenna tower.
- c. The height of antenna is varied from one meter to four meters above the ground to determine the maximum value of the field strength. Both horizontal and vertical polarizations of the antenna are set to make the measurement.
- d. For each suspected emission, the EUT was arranged to its worst case and then the antenna was tuned to heights from 1 meter to 4 meters and the rotatable table was turned from 0 degrees to 360 degrees to find the maximum reading.
- e. The test-receiver system was set to quasi-peak detect function and specified bandwidth with maximum hold mode when the test frequency is below 1 GHz.
- f. The test-receiver system was set to peak and average detected function and specified bandwidth with maximum hold mode when the test frequency is above 1 GHz. If the peak reading value also meets average limit, measurement with the average detector is unnecessary.

Note:

1. The resolution bandwidth and video bandwidth of test receiver/spectrum analyzer is 120 kHz for Quasi-peak detection (QP) or Peak detection (PK) at frequency below 1 GHz.
2. The resolution bandwidth of test receiver/spectrum analyzer is 1 MHz and the video bandwidth is 3 MHz for Peak detection (PK) at frequency above 1 GHz.
3. The resolution bandwidth of test receiver/spectrum analyzer is 1 MHz and the video bandwidth is $\geq 1/T$ (Duty cycle < 98 %) or 10 Hz (Duty cycle ≥ 98 %) for Average detection (AV) at frequency above 1 GHz.
(11b: RBW = 1 MHz, VBW = 300 Hz ; 11g: RBW = 1 MHz, VBW = 1 kHz ;
11n (HT20): RBW = 1 MHz, VBW = 1 kHz)
4. All modes of operation were investigated and the worst-case emissions are reported.

4.8.4 Deviation from Test Standard

No deviation.

4.8.5 Test Set Up

<Radiated Emission below 30 MHz>

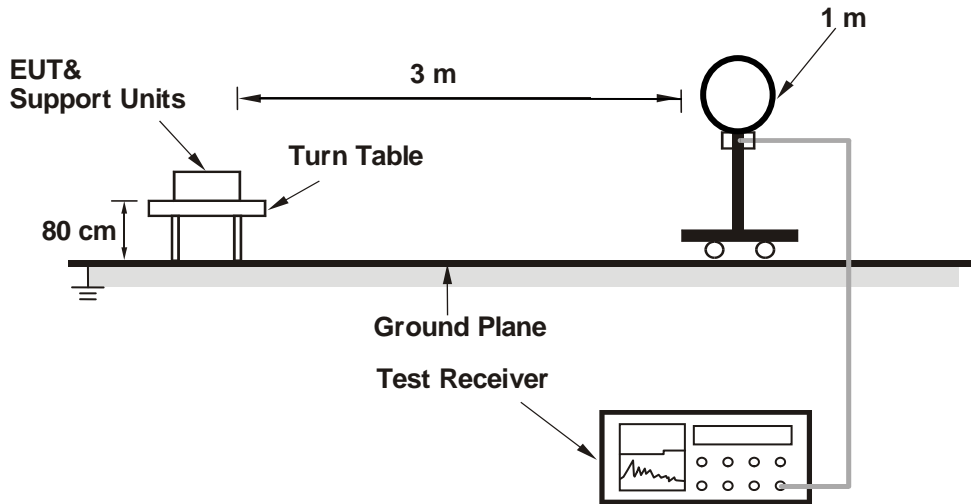

<Radiated Emission 30 MHz to 1 GHz>

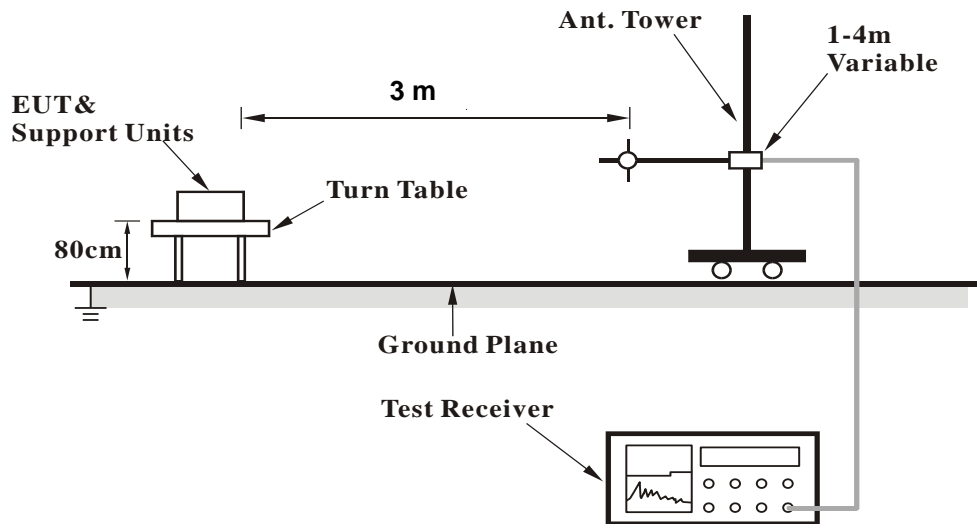

<Radiated Emission above 1 GHz>

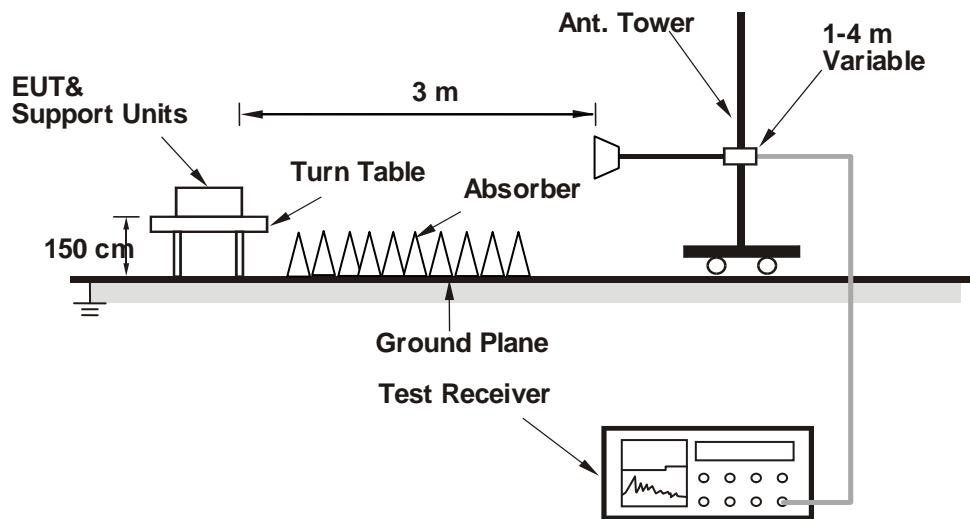

For the actual test configuration, please refer to the attached file (Test Setup Photo).

4.8.6 EUT Operating Conditions

- Placed the EUT on a testing table.
- Use the software to control the EUT under transmission condition continuously at specific channel frequency.

4.8.7 Test Results

Above 1 GHz Data :
802.11b

EUT Test Condition		Measurement Detail	
Channel	Channel 1	Frequency Range	1 GHz ~ 25 GHz
Input Power	120 Vac, 60 Hz	Detector Function	Peak (PK) Average (AV)
Environmental Conditions	25 deg. C, 65 % RH	Tested By	Harry Hsueh

Horizontal

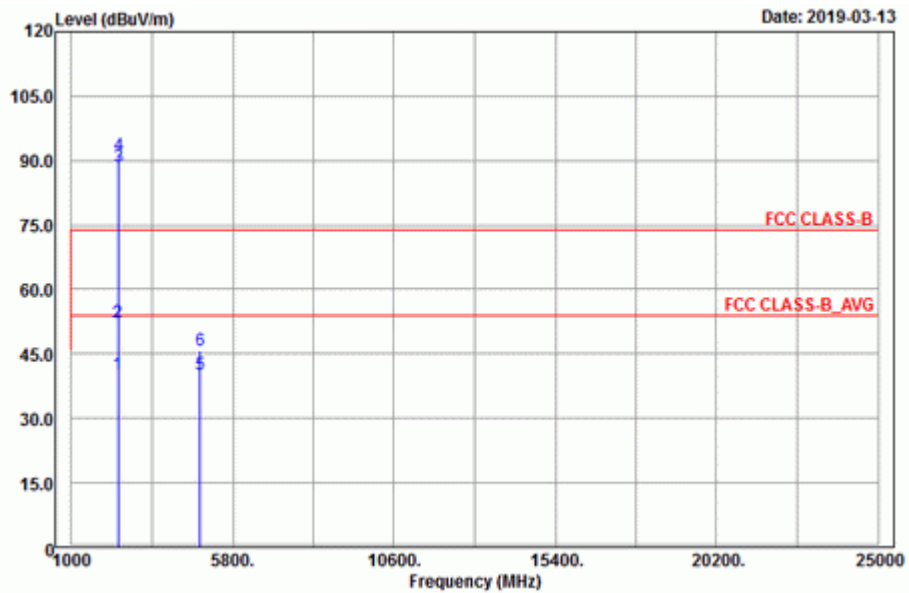

Vertical

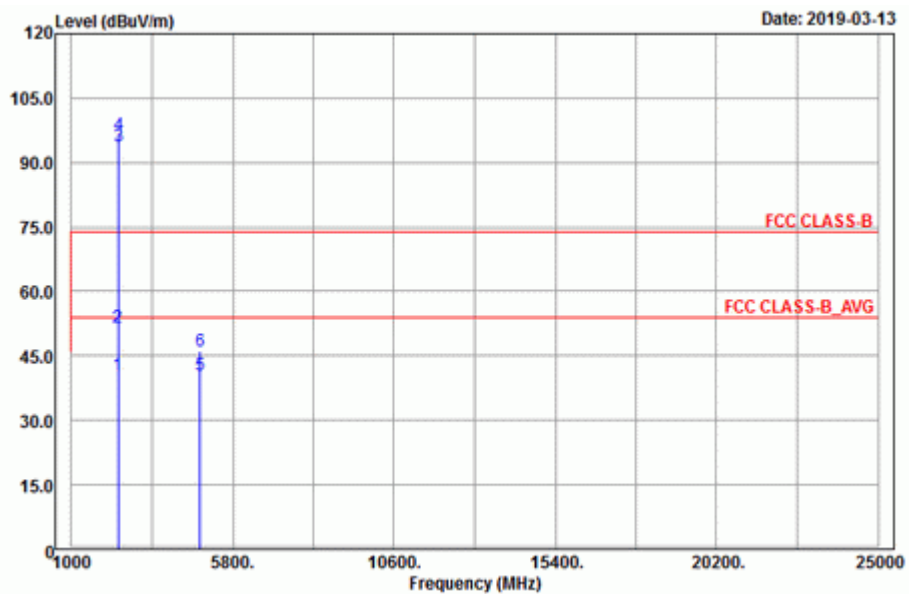

Antenna Polarity & Test Distance: Horizontal at 3 m

Frequency (MHz)	Emission Level (dBuV/m)	Read Level (dBuV)	Factor (dB/m)	Limit (dBuV/m)	Margin (dB)	Antenna Height (cm)	Table Angle (Degree)	Remark
2387.58	40.35	38.64	1.71	54	-13.65	129	237	Average
2387.58	52.17	50.46	1.71	74	-21.83	129	237	Peak
2412	88.46	86.69	1.77			129	237	Average
2412	91.11	89.34	1.77			129	237	Peak
4824	40.29	32.16	8.13	54	-13.71	153	26	Average
4824	45.75	37.62	8.13	74	-28.25	153	26	Peak

Antenna Polarity & Test Distance: Vertical at 3 m

Frequency (MHz)	Emission Level (dBuV/m)	Read Level (dBuV)	Factor (dB/m)	Limit (dBuV/m)	Margin (dB)	Antenna Height (cm)	Table Angle (Degree)	Remark
2386.95	40.51	38.8	1.71	54	-13.49	182	350	Average
2386.95	51.57	49.86	1.71	74	-22.43	182	350	Peak
2412	93.77	92	1.77			182	350	Average
2412	96.5	94.73	1.77			182	350	Peak
4824	40.55	32.42	8.13	54	-13.45	125	219	Average
4824	46.06	37.93	8.13	74	-27.94	125	219	Peak

Remarks:

- Emission Level = Read Level + Factor
Margin value = Emission level – Limit value
- 2412 MHz: Fundamental frequency.
- The emission levels of other frequencies were very low against the limit.

EUT Test Condition		Measurement Detail	
Channel	Channel 6	Frequency Range	1 GHz ~ 25 GHz
Input Power	120 Vac, 60 Hz	Detector Function	Peak (PK) Average (AV)
Environmental Conditions	25 deg. C, 65 % RH	Tested By	Harry Hsueh

Horizontal

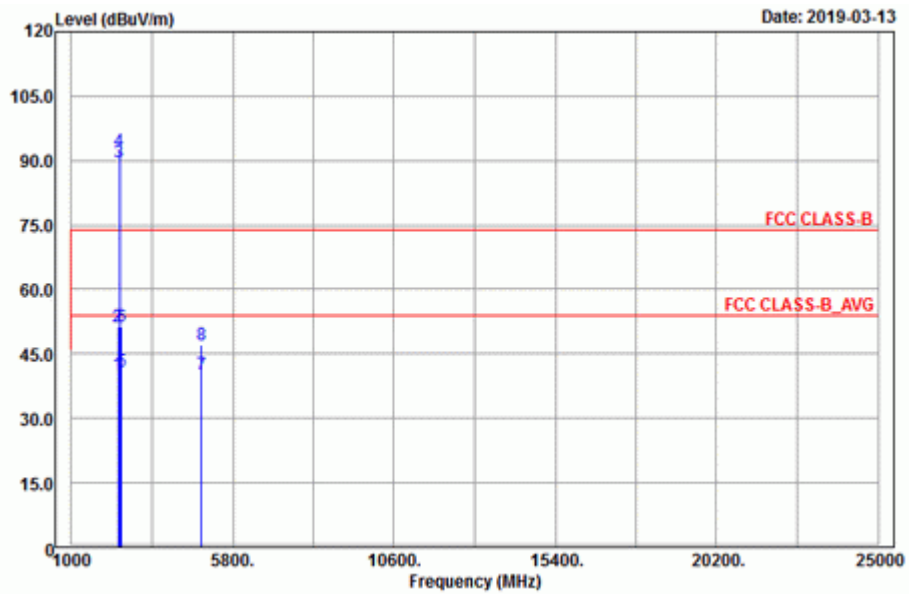

Vertical

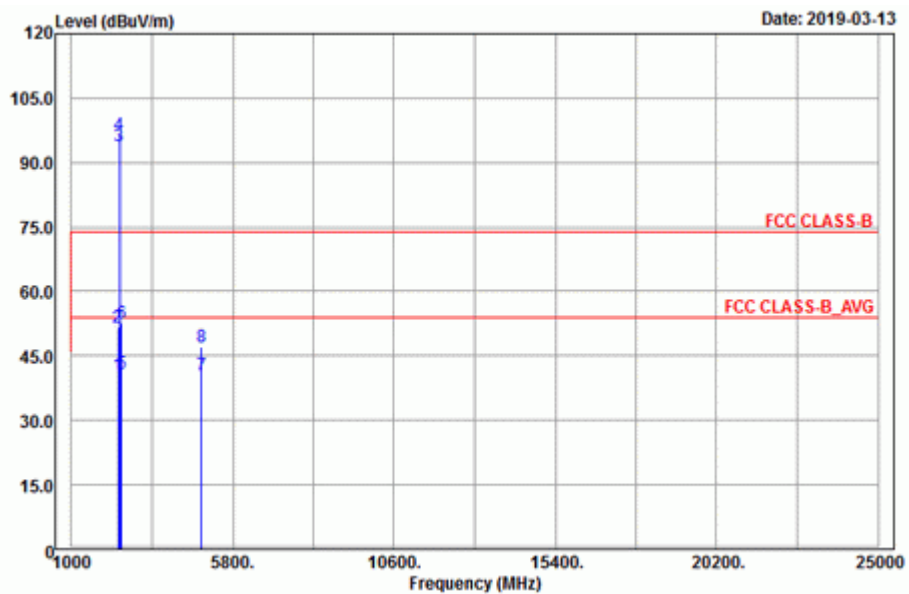

Antenna Polarity & Test Distance: Horizontal at 3 m

Frequency (MHz)	Emission Level (dBuV/m)	Read Level (dBuV)	Factor (dB/m)	Limit (dBuV/m)	Margin (dB)	Antenna Height (cm)	Table Angle (Degree)	Remark
2383.98	40.29	38.6	1.69	54	-13.71	129	237	Average
2383.98	51.37	49.68	1.69	74	-22.63	129	237	Peak
2437	89.57	87.72	1.85			129	237	Average
2437	92.18	90.33	1.85			129	237	Peak
2496.72	40.83	38.81	2.02	54	-13.17	129	237	Average
2496.72	51.44	49.42	2.02	74	-22.56	129	237	Peak
4874	40.33	32.14	8.19	54	-13.67	195	5	Average
4874	47	38.81	8.19	74	-27	195	5	Peak

Antenna Polarity & Test Distance: Vertical at 3 m

Frequency (MHz)	Emission Level (dBuV/m)	Read Level (dBuV)	Factor (dB/m)	Limit (dBuV/m)	Margin (dB)	Antenna Height (cm)	Table Angle (Degree)	Remark
2386.59	40.42	38.71	1.71	54	-13.58	182	350	Average
2386.59	51.56	49.85	1.71	74	-22.44	182	350	Peak
2437	93.84	91.99	1.85			182	350	Average
2437	96.56	94.71	1.85			182	350	Peak
2492.52	41.02	39	2.02	54	-12.98	182	350	Average
2492.52	52.71	50.69	2.02	74	-21.29	182	350	Peak
4874	40.52	32.33	8.19	54	-13.48	124	285	Average
4874	47.14	38.95	8.19	74	-26.86	124	285	Peak

Remarks:

- Emission Level = Read Level + Factor
Margin value = Emission level – Limit value
- 2437 MHz: Fundamental frequency.
- The emission levels of other frequencies were very low against the limit.

EUT Test Condition		Measurement Detail	
Channel	Channel 11	Frequency Range	1 GHz ~ 25 GHz
Input Power	120 Vac, 60 Hz	Detector Function	Peak (PK) Average (AV)
Environmental Conditions	25 deg. C, 65 % RH	Tested By	Harry Hsueh

Horizontal

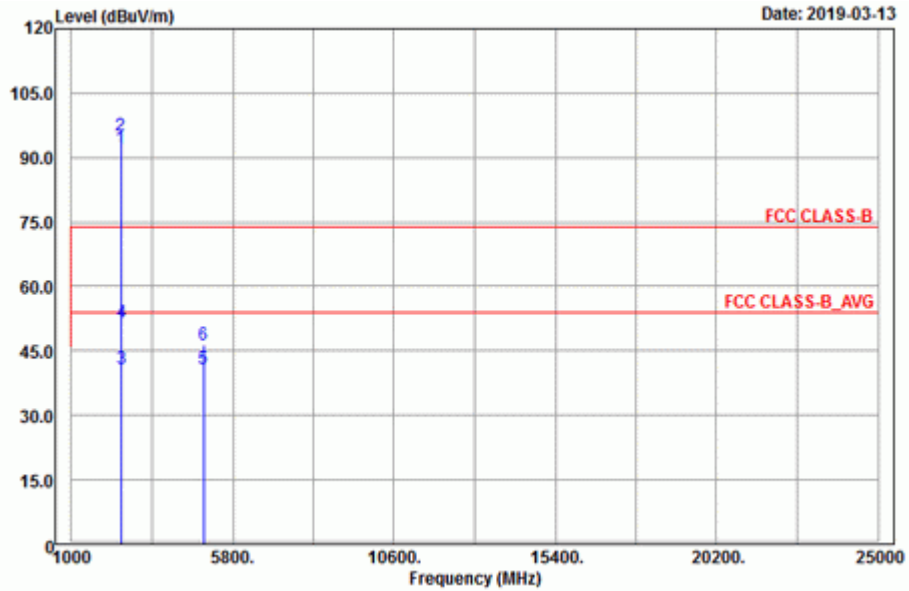

Vertical

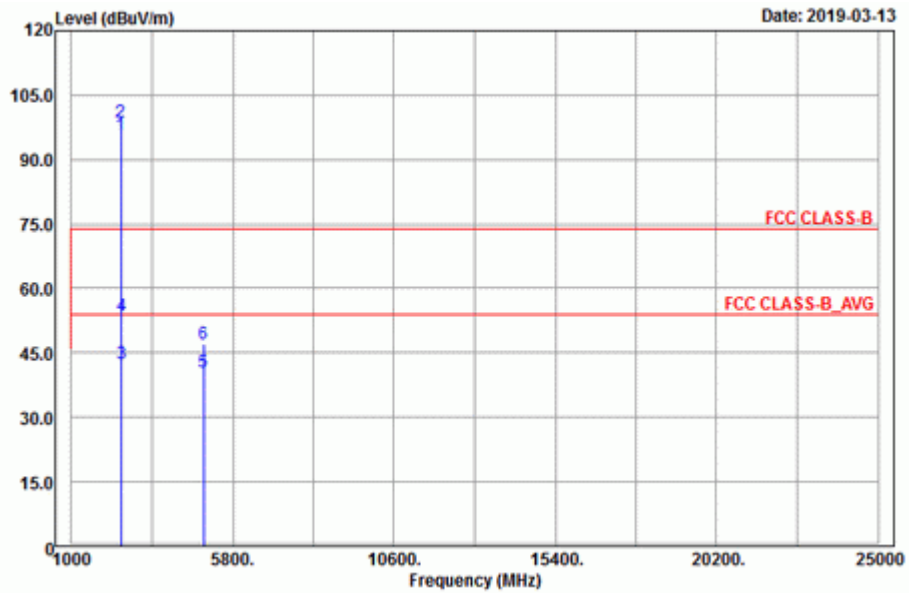

Antenna Polarity & Test Distance: Horizontal at 3 m

Frequency (MHz)	Emission Level (dBuV/m)	Read Level (dBuV)	Factor (dB/m)	Limit (dBuV/m)	Margin (dB)	Antenna Height (cm)	Table Angle (Degree)	Remark
2462	92.16	90.23	1.93			129	237	Average
2462	95.08	93.15	1.93			129	237	Peak
2489.88	40.86	38.85	2.01	54	-13.14	129	237	Average
2489.88	51.62	49.61	2.01	74	-22.38	129	237	Peak
4924	40.81	32.56	8.25	54	-13.19	159	9	Average
4924	46.52	38.27	8.25	74	-27.48	159	9	Peak

Antenna Polarity & Test Distance: Vertical at 3 m

Frequency (MHz)	Emission Level (dBuV/m)	Read Level (dBuV)	Factor (dB/m)	Limit (dBuV/m)	Margin (dB)	Antenna Height (cm)	Table Angle (Degree)	Remark
2462	95.9	93.97	1.93			215	360	Average
2462	98.87	96.94	1.93			215	360	Peak
2483.6	42.6	40.64	1.96	54	-11.4	215	360	Average
2483.6	53.48	51.52	1.96	74	-20.52	215	360	Peak
4924	40.46	32.21	8.25	54	-13.54	133	265	Average
4924	47.05	38.8	8.25	74	-26.95	133	265	Peak

Remarks:

- Emission Level = Read Level + Factor
Margin value = Emission level – Limit value
- 2462 MHz: Fundamental frequency.
- The emission levels of other frequencies were very low against the limit.

EUT Test Condition		Measurement Detail	
Channel	Channel 12	Frequency Range	1 GHz ~ 25 GHz
Input Power	120 Vac, 60 Hz	Detector Function	Peak (PK) Average (AV)
Environmental Conditions	25 deg. C, 65 % RH	Tested By	Harry Hsueh

Horizontal

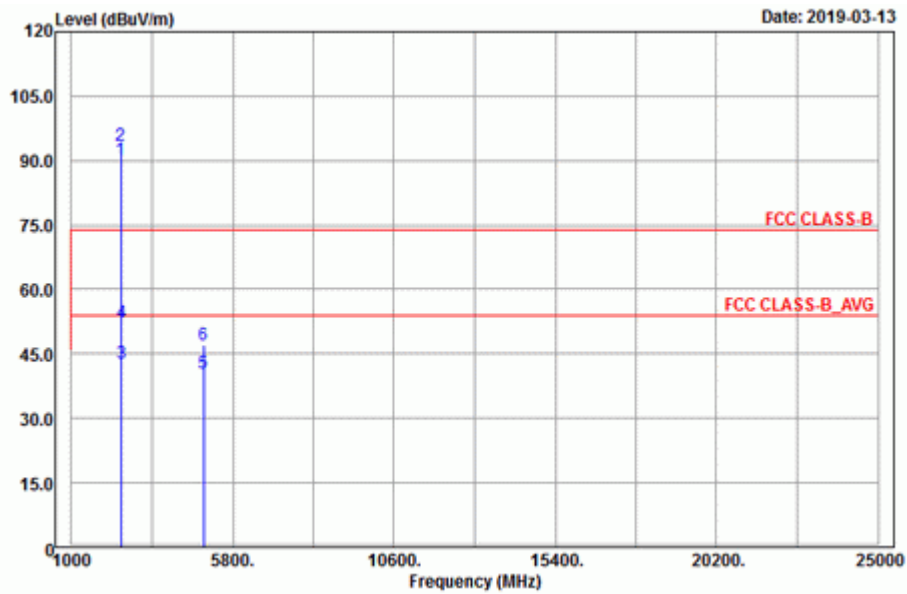

Vertical

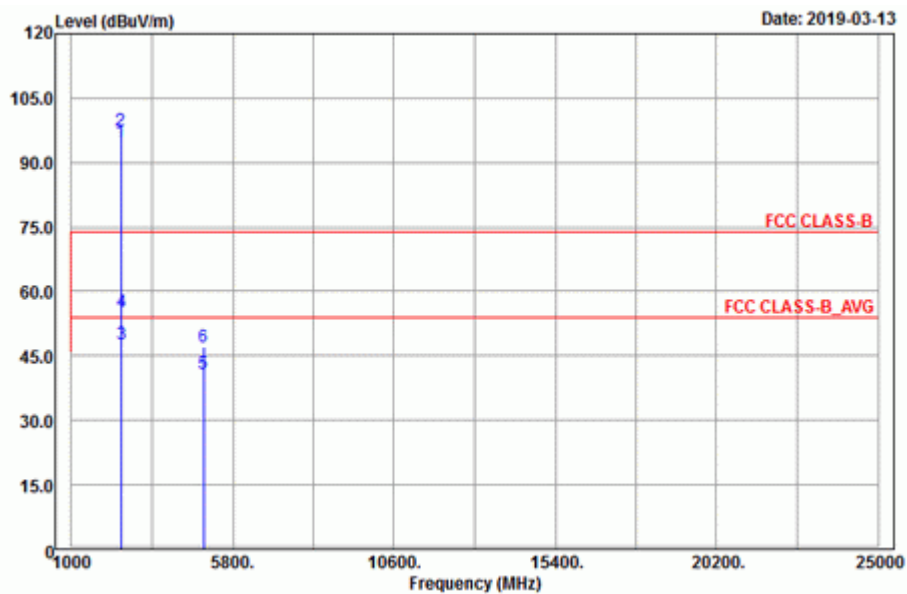

Antenna Polarity & Test Distance: Horizontal at 3 m								
Frequency (MHz)	Emission Level (dBuV/m)	Read Level (dBuV)	Factor (dB/m)	Limit (dBuV/m)	Margin (dB)	Antenna Height (cm)	Table Angle (Degree)	Remark
2467	90.21	88.26	1.95			215	41	Average
2467	93.37	91.42	1.95			215	41	Peak
2484.72	42.85	40.86	1.99	54	-11.15	215	41	Average
2484.72	52.42	50.43	1.99	74	-21.58	215	41	Peak
4934	40.49	32.23	8.26	54	-13.51	111	147	Average
4934	47.06	38.8	8.26	74	-26.94	111	147	Peak
Antenna Polarity & Test Distance: Vertical at 3 m								
Frequency (MHz)	Emission Level (dBuV/m)	Read Level (dBuV)	Factor (dB/m)	Limit (dBuV/m)	Margin (dB)	Antenna Height (cm)	Table Angle (Degree)	Remark
2467	94.9	92.95	1.95			101	350	Average
2467	97.47	95.52	1.95			101	350	Peak
2484.68	47.9	45.91	1.99	54	-6.1	101	350	Average
2484.68	55.22	53.23	1.99	74	-18.78	101	350	Peak
4934	40.77	32.51	8.26	54	-13.23	109	213	Average
4934	47.21	38.95	8.26	74	-26.79	109	213	Peak

Remarks:

1. Emission Level = Read Level + Factor
Margin value = Emission level – Limit value
2. 2467 MHz: Fundamental frequency.
3. The emission levels of other frequencies were very low against the limit.

EUT Test Condition		Measurement Detail	
Channel	Channel 13	Frequency Range	1 GHz ~ 25 GHz
Input Power	120 Vac, 60 Hz	Detector Function	Peak (PK) Average (AV)
Environmental Conditions	25 deg. C, 65 % RH	Tested By	Harry Hsueh

Horizontal

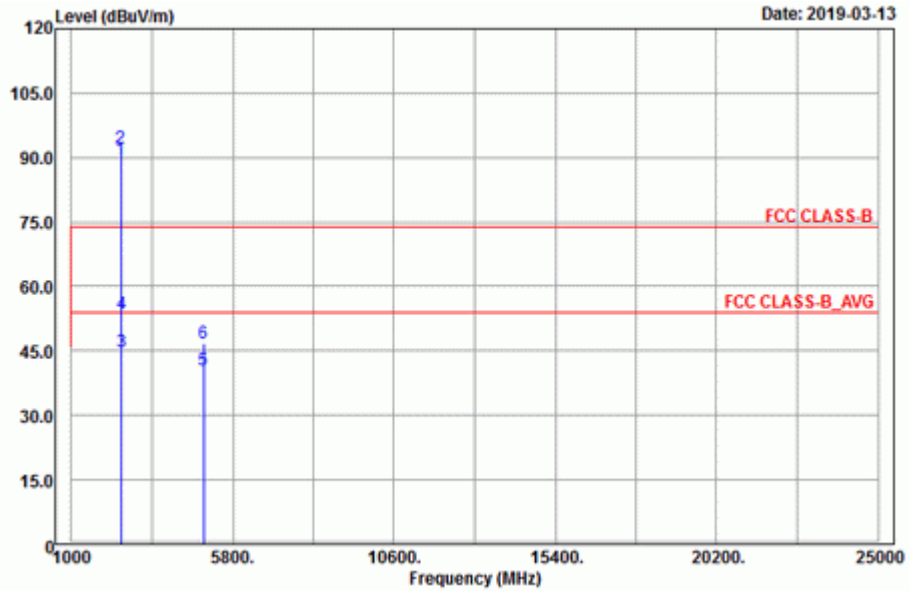

Vertical

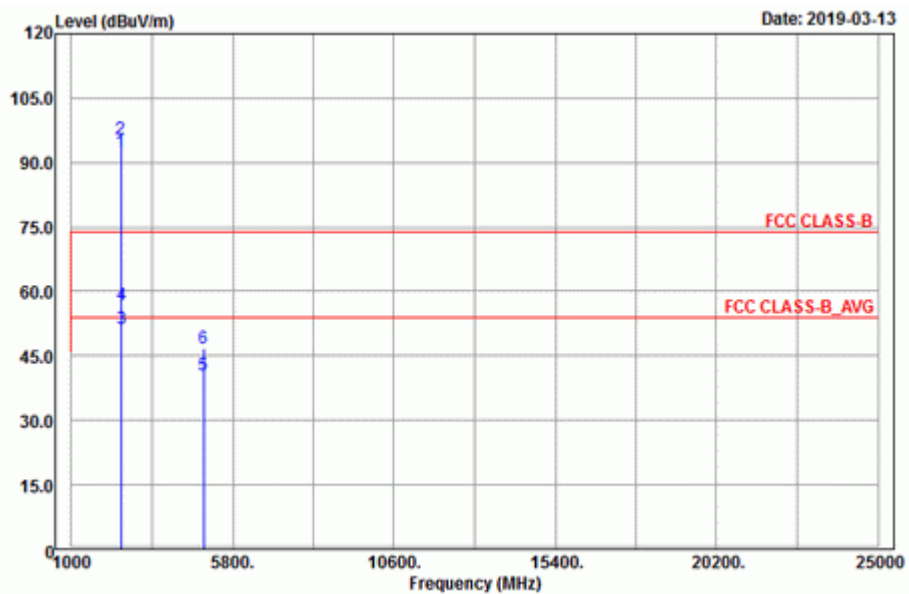

Antenna Polarity & Test Distance: Horizontal at 3 m

Frequency (MHz)	Emission Level (dBuV/m)	Read Level (dBuV)	Factor (dB/m)	Limit (dBuV/m)	Margin (dB)	Antenna Height (cm)	Table Angle (Degree)	Remark
2472	89.6	87.64	1.96			294	128	Average
2472	92.14	90.18	1.96			294	128	Peak
2486.6	44.83	42.84	1.99	54	-9.17	294	128	Average
2486.6	53.58	51.59	1.99	74	-20.42	294	128	Peak
4944	40.43	32.16	8.27	54	-13.57	132	3	Average
4944	46.83	38.56	8.27	74	-27.17	132	3	Peak

Antenna Polarity & Test Distance: Vertical at 3 m

Frequency (MHz)	Emission Level (dBuV/m)	Read Level (dBuV)	Factor (dB/m)	Limit (dBuV/m)	Margin (dB)	Antenna Height (cm)	Table Angle (Degree)	Remark
2472	92.67	90.71	1.96			182	350	Average
2472	95.46	93.5	1.96			182	350	Peak
2486.68	51.23	49.24	1.99	54	-2.77	182	350	Average
2486.68	57	55.01	1.99	74	-17	182	350	Peak
4944	40.64	32.37	8.27	54	-13.36	165	285	Average
4944	46.67	38.4	8.27	74	-27.33	165	285	Peak

Remarks:

- Emission Level = Read Level + Factor
Margin value = Emission level – Limit value
- 2472 MHz: Fundamental frequency.
- The emission levels of other frequencies were very low against the limit.

802.11g

EUT Test Condition		Measurement Detail	
Channel	Channel 1	Frequency Range	1 GHz ~ 25 GHz
Input Power	120 Vac, 60 Hz	Detector Function	Peak (PK) Average (AV)
Environmental Conditions	25 deg. C, 65 % RH	Tested By	Harry Hsueh

Horizontal

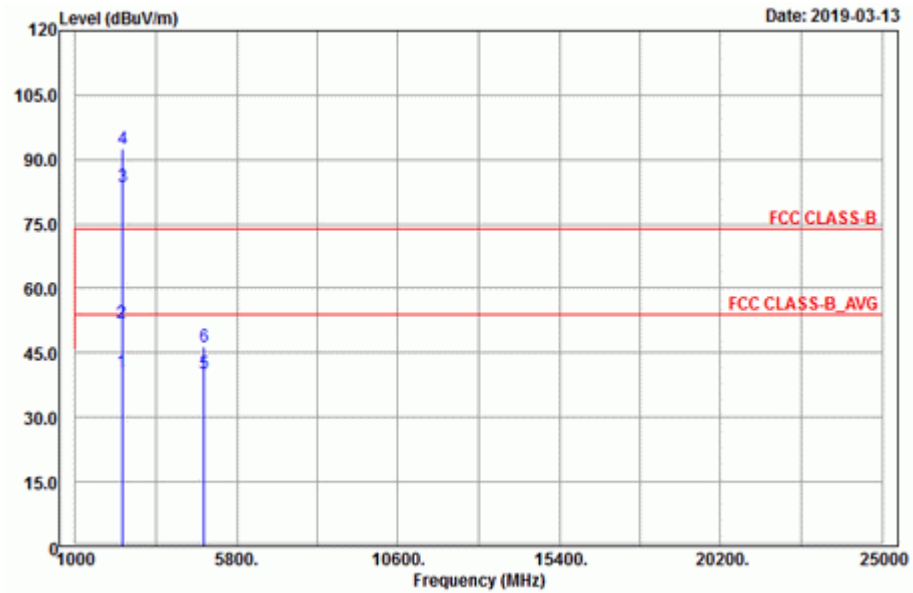

Vertical

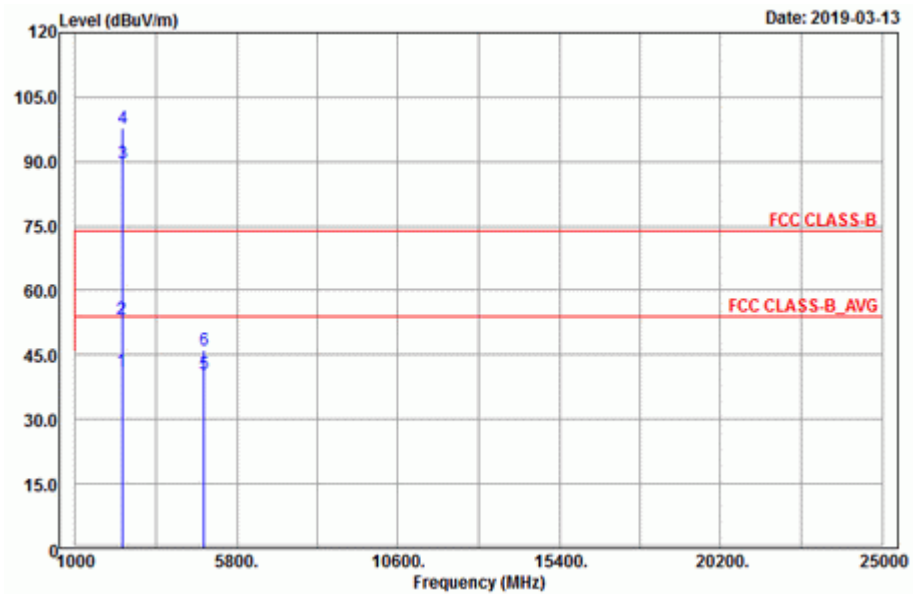

Antenna Polarity & Test Distance: Horizontal at 3 m

Frequency (MHz)	Emission Level (dBuV/m)	Read Level (dBuV)	Factor (dB/m)	Limit (dBuV/m)	Margin (dB)	Antenna Height (cm)	Table Angle (Degree)	Remark
2389.92	40.59	38.86	1.73	54	-13.41	129	237	Average
2389.92	51.89	50.16	1.73	74	-22.11	129	237	Peak
2412	83.86	82.09	1.77			129	237	Average
2412	92.39	90.62	1.77			129	237	Peak
4824	40.34	32.21	8.13	54	-13.66	154	340	Average
4824	46.49	38.36	8.13	74	-27.51	154	340	Peak

Antenna Polarity & Test Distance: Vertical at 3 m

Frequency (MHz)	Emission Level (dBuV/m)	Read Level (dBuV)	Factor (dB/m)	Limit (dBuV/m)	Margin (dB)	Antenna Height (cm)	Table Angle (Degree)	Remark
2389.92	41.12	39.39	1.73	54	-12.88	182	350	Average
2389.92	53.29	51.56	1.73	74	-20.71	182	350	Peak
2412	89.45	87.68	1.77			182	350	Average
2412	97.83	96.06	1.77			182	350	Peak
4824	40.39	32.26	8.13	54	-13.61	152	199	Average
4824	46.19	38.06	8.13	74	-27.81	152	199	Peak

Remarks:

- Emission Level = Read Level + Factor
Margin value = Emission level – Limit value
- 2412 MHz: Fundamental frequency.
- The emission levels of other frequencies were very low against the limit.

EUT Test Condition		Measurement Detail	
Channel	Channel 6	Frequency Range	1 GHz ~ 25 GHz
Input Power	120 Vac, 60 Hz	Detector Function	Peak (PK) Average (AV)
Environmental Conditions	25 deg. C, 65 % RH	Tested By	Harry Hsueh

Horizontal

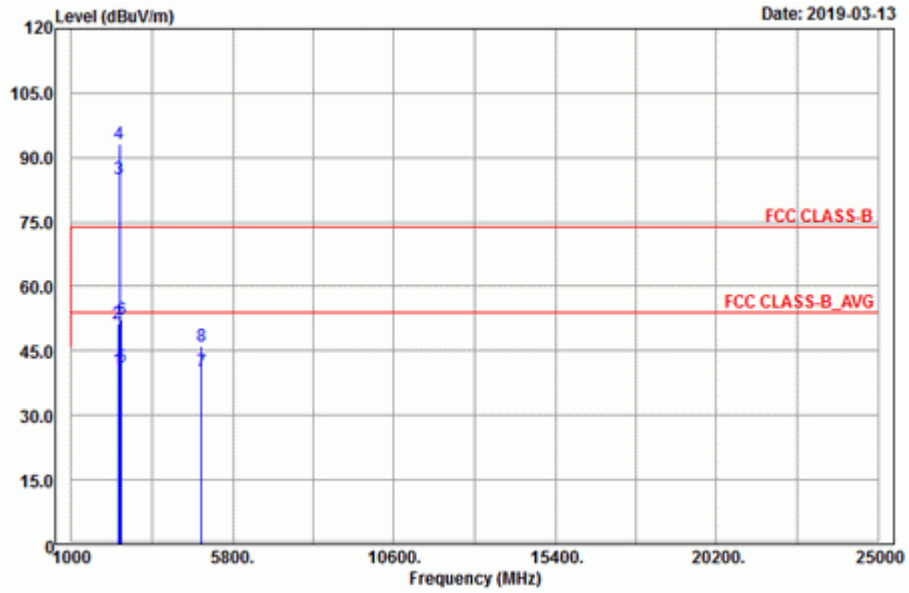

Vertical

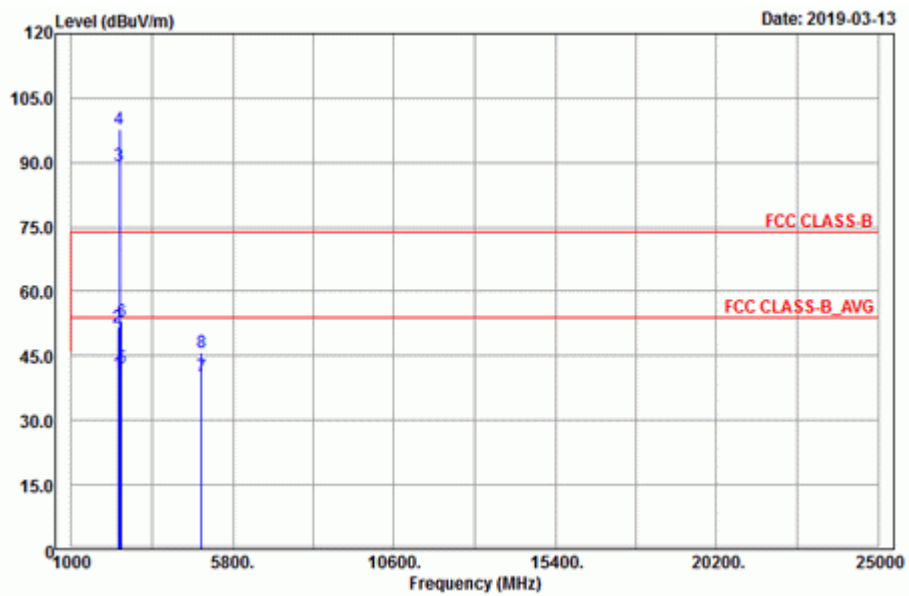

Antenna Polarity & Test Distance: Horizontal at 3 m

Frequency (MHz)	Emission Level (dBuV/m)	Read Level (dBuV)	Factor (dB/m)	Limit (dBuV/m)	Margin (dB)	Antenna Height (cm)	Table Angle (Degree)	Remark
2386.77	40.5	38.79	1.71	54	-13.5	129	237	Average
2386.77	51.41	49.7	1.71	74	-22.59	129	237	Peak
2437	85.09	83.24	1.85			129	237	Average
2437	93.14	91.29	1.85			129	237	Peak
2489.6	41.04	39.03	2.01	54	-12.96	129	237	Average
2489.6	52.24	50.23	2.01	74	-21.76	129	237	Peak
4874	40.31	32.12	8.19	54	-13.69	124	134	Average
4874	46.08	37.89	8.19	74	-27.92	124	134	Peak

Antenna Polarity & Test Distance: Vertical at 3 m

Frequency (MHz)	Emission Level (dBuV/m)	Read Level (dBuV)	Factor (dB/m)	Limit (dBuV/m)	Margin (dB)	Antenna Height (cm)	Table Angle (Degree)	Remark
2384.97	40.73	39.04	1.69	54	-13.27	182	350	Average
2384.97	51.55	49.86	1.69	74	-22.45	182	350	Peak
2437	89.38	87.53	1.85			182	350	Average
2437	97.81	95.96	1.85			182	350	Peak
2489.32	42.14	40.13	2.01	54	-11.86	182	350	Average
2489.32	52.88	50.87	2.01	74	-21.12	182	350	Peak
4874	40.38	32.19	8.19	54	-13.62	145	184	Average
4874	45.84	37.65	8.19	74	-28.16	145	184	Peak

Remarks:

- Emission Level = Read Level + Factor
Margin value = Emission level – Limit value
- 2437 MHz: Fundamental frequency.
- The emission levels of other frequencies were very low against the limit.

EUT Test Condition		Measurement Detail	
Channel	Channel 11	Frequency Range	1 GHz ~ 25 GHz
Input Power	120 Vac, 60 Hz	Detector Function	Peak (PK) Average (AV)
Environmental Conditions	25 deg. C, 65 % RH	Tested By	Harry Hsueh

Horizontal

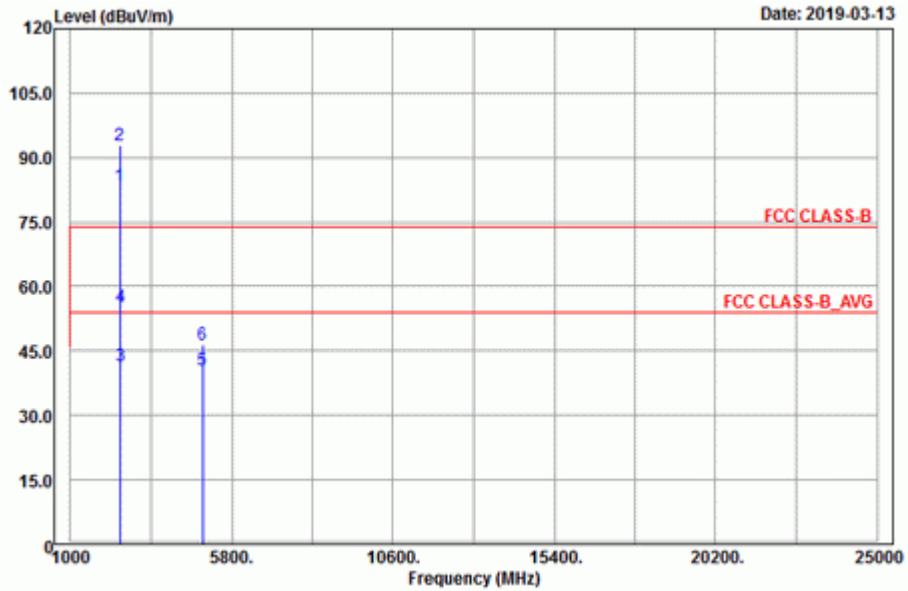

Vertical

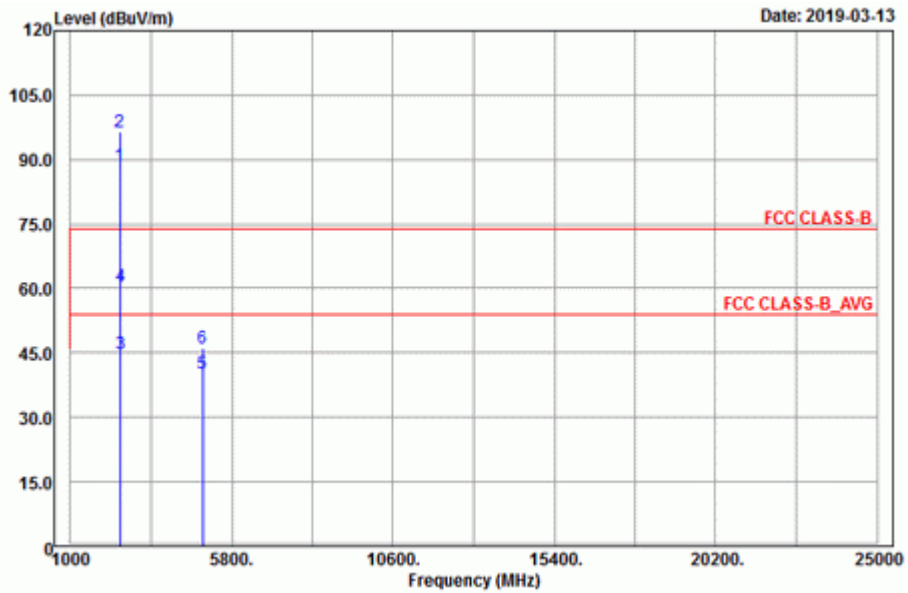

Antenna Polarity & Test Distance: Horizontal at 3 m

Frequency (MHz)	Emission Level (dBuV/m)	Read Level (dBuV)	Factor (dB/m)	Limit (dBuV/m)	Margin (dB)	Antenna Height (cm)	Table Angle (Degree)	Remark
2462	83.38	81.45	1.93			129	237	Average
2462	92.78	90.85	1.93			129	237	Peak
2483.52	41.4	39.44	1.96	54	-12.6	129	237	Average
2483.52	55.28	53.32	1.96	74	-18.72	129	237	Peak
4924	40.44	32.19	8.25	54	-13.56	182	255	Average
4924	46.39	38.14	8.25	74	-27.61	182	255	Peak

Antenna Polarity & Test Distance: Vertical at 3 m

Frequency (MHz)	Emission Level (dBuV/m)	Read Level (dBuV)	Factor (dB/m)	Limit (dBuV/m)	Margin (dB)	Antenna Height (cm)	Table Angle (Degree)	Remark
2462	88.53	86.6	1.93			215	360	Average
2462	96.61	94.68	1.93			215	360	Peak
2483.52	44.79	42.83	1.96	54	-9.21	215	360	Average
2483.52	60.38	58.42	1.96	74	-13.62	215	360	Peak
4924	40.38	32.13	8.25	54	-13.62	163	346	Average
4924	46.16	37.91	8.25	74	-27.84	163	346	Peak

Remarks:

- Emission Level = Read Level + Factor
Margin value = Emission level – Limit value
- 2462 MHz: Fundamental frequency.
- The emission levels of other frequencies were very low against the limit.

EUT Test Condition		Measurement Detail	
Channel	Channel 12	Frequency Range	1 GHz ~ 25 GHz
Input Power	120 Vac, 60 Hz	Detector Function	Peak (PK) Average (AV)
Environmental Conditions	25 deg. C, 65 % RH	Tested By	Harry Hsueh

Horizontal

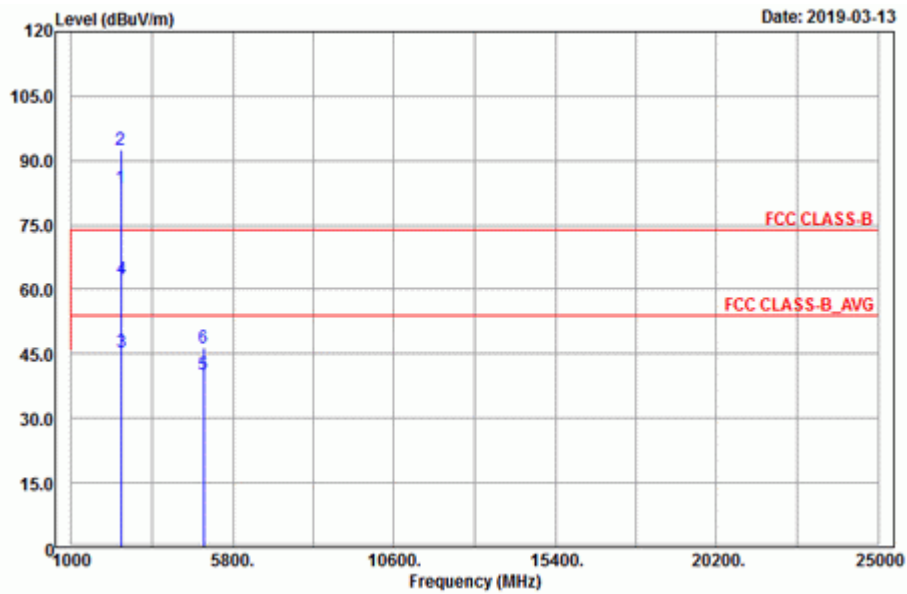

Vertical

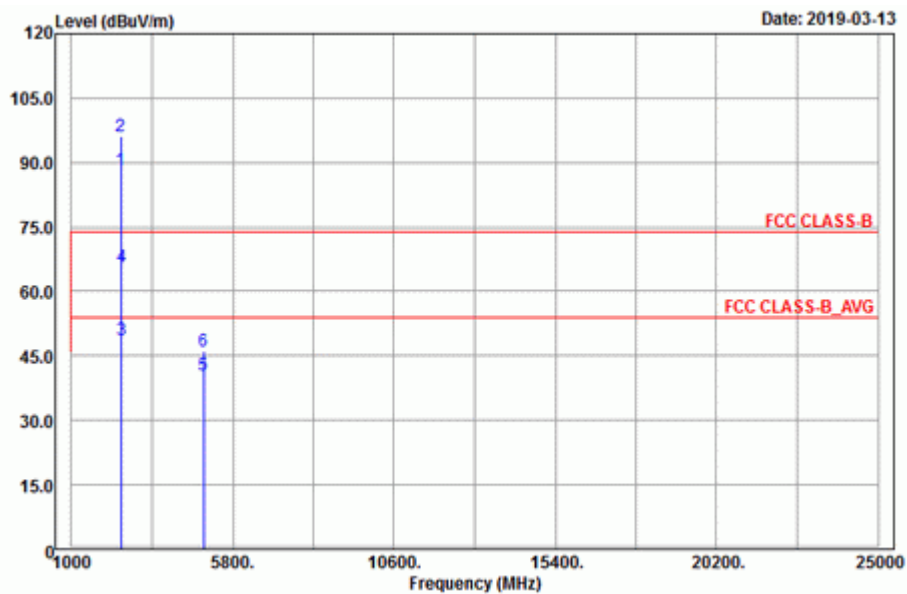

Antenna Polarity & Test Distance: Horizontal at 3 m

Frequency (MHz)	Emission Level (dBuV/m)	Read Level (dBuV)	Factor (dB/m)	Limit (dBuV/m)	Margin (dB)	Antenna Height (cm)	Table Angle (Degree)	Remark
2467	83.67	81.72	1.95			215	41	Average
2467	92.49	90.54	1.95			215	41	Peak
2483.52	45.49	43.53	1.96	54	-8.51	215	41	Average
2483.52	62.54	60.58	1.96	74	-11.46	215	41	Peak
4934	40.28	32.02	8.26	54	-13.72	124	222	Average
4934	46.48	38.22	8.26	74	-27.52	124	222	Peak

Antenna Polarity & Test Distance: Vertical at 3 m

Frequency (MHz)	Emission Level (dBuV/m)	Read Level (dBuV)	Factor (dB/m)	Limit (dBuV/m)	Margin (dB)	Antenna Height (cm)	Table Angle (Degree)	Remark
2467	88.18	86.23	1.95			164	358	Average
2467	96.21	94.26	1.95			164	358	Peak
2483.52	48.8	46.84	1.96	54	-5.2	164	358	Average
2483.52	65.76	63.8	1.96	74	-8.24	164	358	Peak
4934	40.42	32.16	8.26	54	-13.58	286	99	Average
4934	46.21	37.95	8.26	74	-27.79	286	99	Peak

Remarks:

- Emission Level = Read Level + Factor
Margin value = Emission level – Limit value
- 2467 MHz: Fundamental frequency.
- The emission levels of other frequencies were very low against the limit.

EUT Test Condition		Measurement Detail	
Channel	Channel 13	Frequency Range	1 GHz ~ 25 GHz
Input Power	120 Vac, 60 Hz	Detector Function	Peak (PK) Average (AV)
Environmental Conditions	25 deg. C, 65 % RH	Tested By	Harry Hsueh

Horizontal

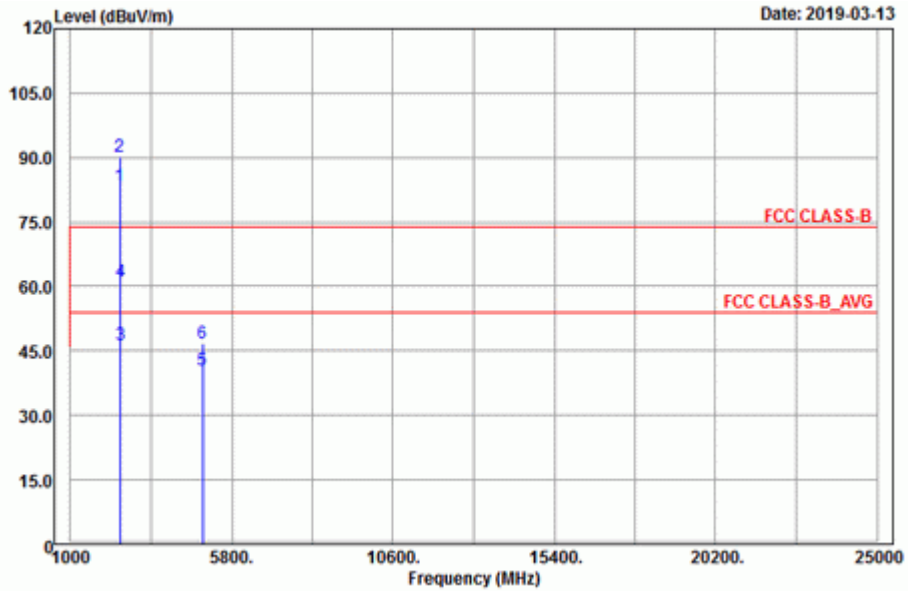

Vertical

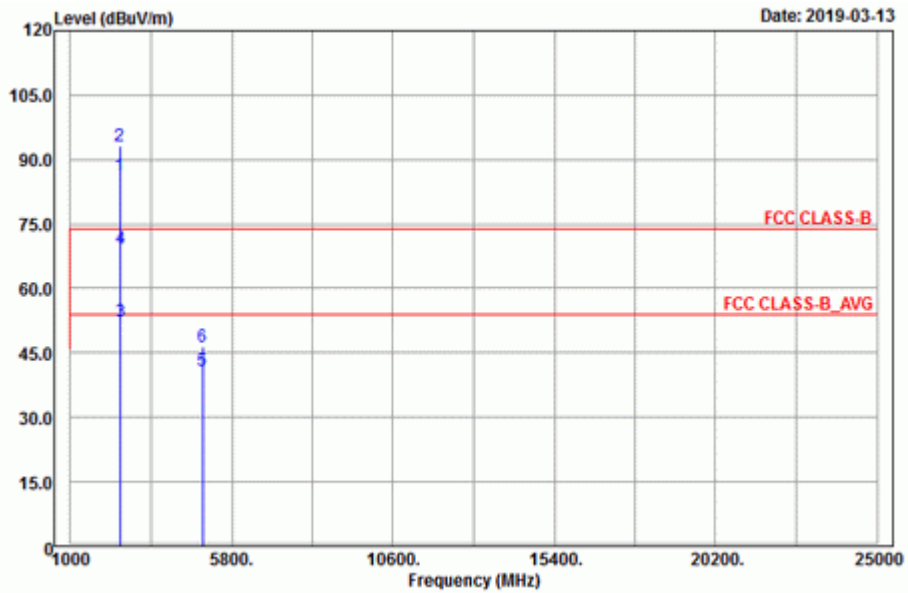

Antenna Polarity & Test Distance: Horizontal at 3 m

Frequency (MHz)	Emission Level (dBuV/m)	Read Level (dBuV)	Factor (dB/m)	Limit (dBuV/m)	Margin (dB)	Antenna Height (cm)	Table Angle (Degree)	Remark
2472	83.49	81.53	1.96			294	46	Average
2472	90.29	88.33	1.96			294	46	Peak
2483.52	46.46	44.5	1.96	54	-7.54	294	46	Average
2483.52	61.26	59.3	1.96	74	-12.74	294	46	Peak
4944	40.41	32.14	8.27	54	-13.59	154	216	Average
4944	46.73	38.46	8.27	74	-27.27	154	216	Peak

Antenna Polarity & Test Distance: Vertical at 3 m

Frequency (MHz)	Emission Level (dBuV/m)	Read Level (dBuV)	Factor (dB/m)	Limit (dBuV/m)	Margin (dB)	Antenna Height (cm)	Table Angle (Degree)	Remark
2472	86.37	84.41	1.96			182	350	Average
2472	93.34	91.38	1.96			182	350	Peak
2483.52	52.32	50.36	1.96	54	-1.68	182	350	Average
2483.52	69.28	67.32	1.96	74	-4.72	182	350	Peak
4944	40.77	32.5	8.27	54	-13.23	185	7	Average
4944	46.39	38.12	8.27	74	-27.61	185	7	Peak

Remarks:

- Emission Level = Read Level + Factor
Margin value = Emission level – Limit value
- 2472 MHz: Fundamental frequency.
- The emission levels of other frequencies were very low against the limit.

802.11n (HT20)

EUT Test Condition		Measurement Detail	
Channel	Channel 1	Frequency Range	1 GHz ~ 25 GHz
Input Power	120 Vac, 60 Hz	Detector Function	Peak (PK) Average (AV)
Environmental Conditions	25 deg. C, 65 % RH	Tested By	Harry Hsueh

Horizontal

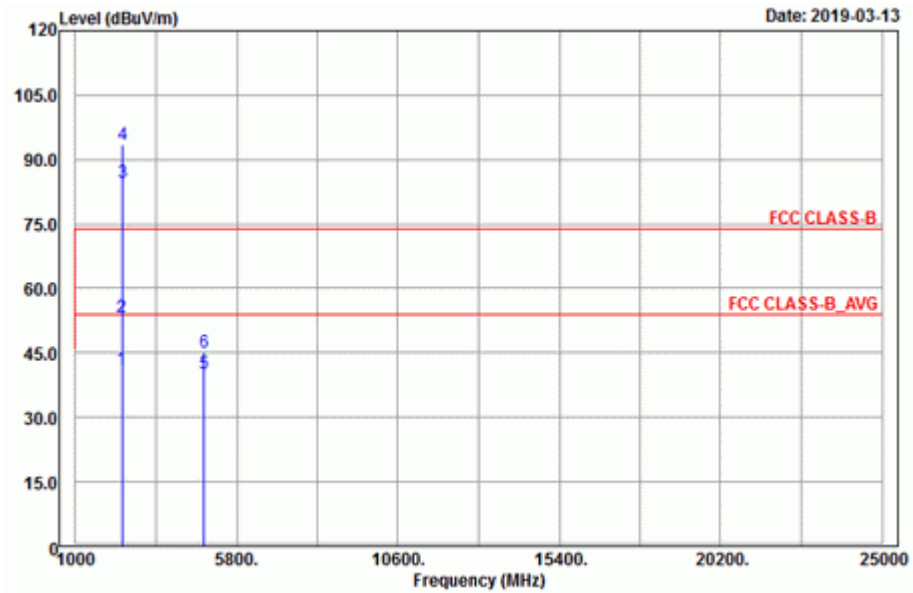

Vertical

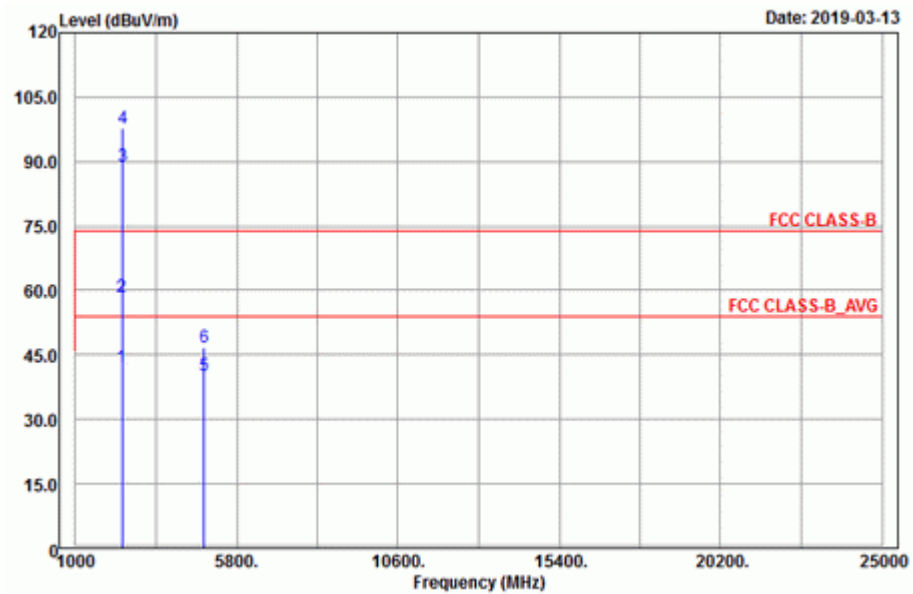

Antenna Polarity & Test Distance: Horizontal at 3 m

Frequency (MHz)	Emission Level (dBuV/m)	Read Level (dBuV)	Factor (dB/m)	Limit (dBuV/m)	Margin (dB)	Antenna Height (cm)	Table Angle (Degree)	Remark
2389.92	41.08	39.35	1.73	54	-12.92	129	237	Average
2389.92	53.41	51.68	1.73	74	-20.59	129	237	Peak
2412	84.75	82.98	1.77			129	237	Average
2412	93.55	91.78	1.77			129	237	Peak
4824	40.13	32	8.13	54	-13.87	145	5	Average
4824	45.01	36.88	8.13	74	-28.99	145	5	Peak

Antenna Polarity & Test Distance: Vertical at 3 m

Frequency (MHz)	Emission Level (dBuV/m)	Read Level (dBuV)	Factor (dB/m)	Limit (dBuV/m)	Margin (dB)	Antenna Height (cm)	Table Angle (Degree)	Remark
2389.92	42.05	40.32	1.73	54	-11.95	182	350	Average
2389.92	58.49	56.76	1.73	74	-15.51	182	350	Peak
2412	88.89	87.12	1.77			182	350	Average
2412	97.88	96.11	1.77			182	350	Peak
4824	40.15	32.02	8.13	54	-13.85	133	326	Average
4824	46.71	38.58	8.13	74	-27.29	133	326	Peak

Remarks:

- Emission Level = Read Level + Factor
Margin value = Emission level – Limit value
- 2412 MHz: Fundamental frequency.
- The emission levels of other frequencies were very low against the limit.

EUT Test Condition		Measurement Detail	
Channel	Channel 6	Frequency Range	1 GHz ~ 25 GHz
Input Power	120 Vac, 60 Hz	Detector Function	Peak (PK) Average (AV)
Environmental Conditions	25 deg. C, 65 % RH	Tested By	Harry Hsueh

Horizontal

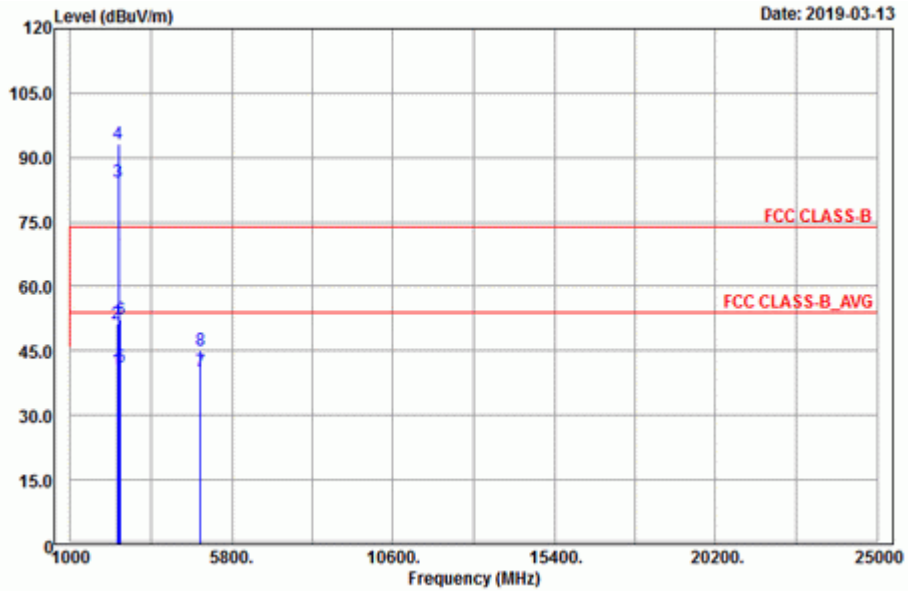

Vertical

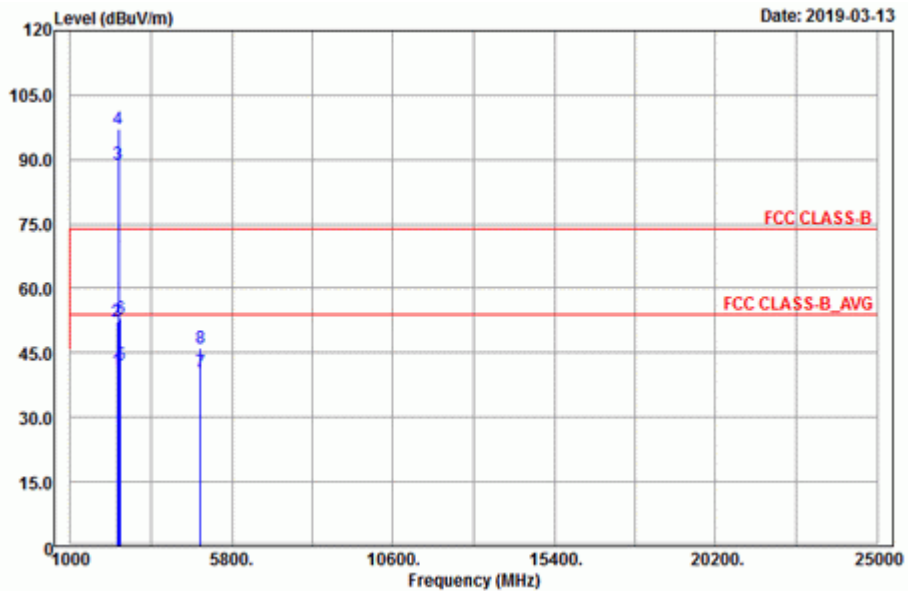

Antenna Polarity & Test Distance: Horizontal at 3 m

Frequency (MHz)	Emission Level (dBuV/m)	Read Level (dBuV)	Factor (dB/m)	Limit (dBuV/m)	Margin (dB)	Antenna Height (cm)	Table Angle (Degree)	Remark
2386.14	40.45	38.74	1.71	54	-13.55	129	237	Average
2386.14	51.21	49.5	1.71	74	-22.79	129	237	Peak
2437	84.33	82.48	1.85			129	237	Average
2437	93.03	91.18	1.85			129	237	Peak
2491.24	41.05	39.04	2.01	54	-12.95	129	237	Average
2491.24	52.34	50.33	2.01	74	-21.66	129	237	Peak
4874	40.33	32.14	8.19	54	-13.67	150	240	Average
4874	45.15	36.96	8.19	74	-28.85	150	240	Peak

Antenna Polarity & Test Distance: Vertical at 3 m

Frequency (MHz)	Emission Level (dBuV/m)	Read Level (dBuV)	Factor (dB/m)	Limit (dBuV/m)	Margin (dB)	Antenna Height (cm)	Table Angle (Degree)	Remark
2384.88	40.75	39.06	1.69	54	-13.25	182	350	Average
2384.88	52.37	50.68	1.69	74	-21.63	182	350	Peak
2437	88.89	87.04	1.85			182	350	Average
2437	97.06	95.21	1.85			182	350	Peak
2488.6	42.16	40.15	2.01	54	-11.84	182	350	Average
2488.6	52.97	50.96	2.01	74	-21.03	182	350	Peak
4874	40.48	32.29	8.19	54	-13.52	124	175	Average
4874	45.94	37.75	8.19	74	-28.06	124	175	Peak

Remarks:

- Emission Level = Read Level + Factor
Margin value = Emission level – Limit value
- 2437 MHz: Fundamental frequency.
- The emission levels of other frequencies were very low against the limit.

EUT Test Condition		Measurement Detail	
Channel	Channel 11	Frequency Range	1 GHz ~ 25 GHz
Input Power	120 Vac, 60 Hz	Detector Function	Peak (PK) Average (AV)
Environmental Conditions	25 deg. C, 65 % RH	Tested By	Harry Hsueh

Horizontal

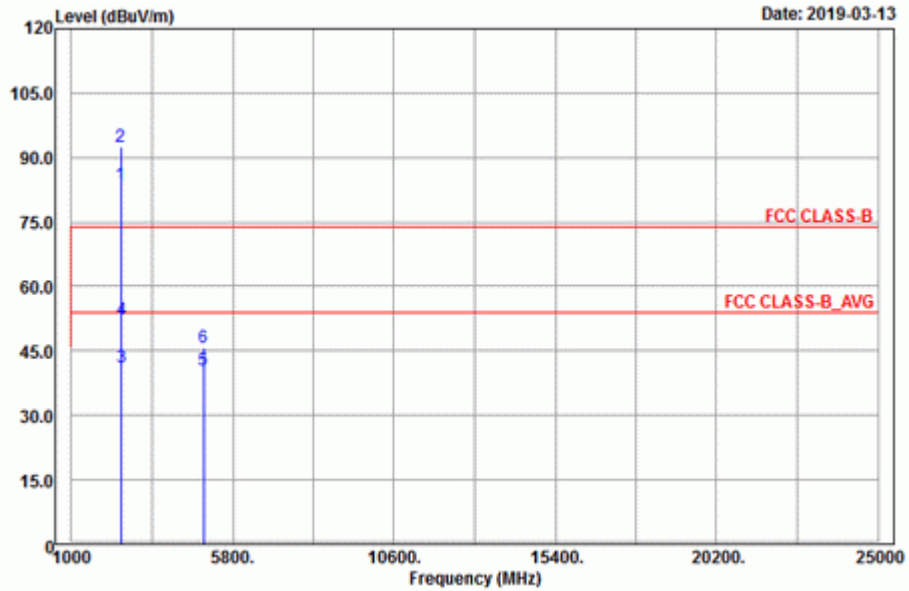

Vertical

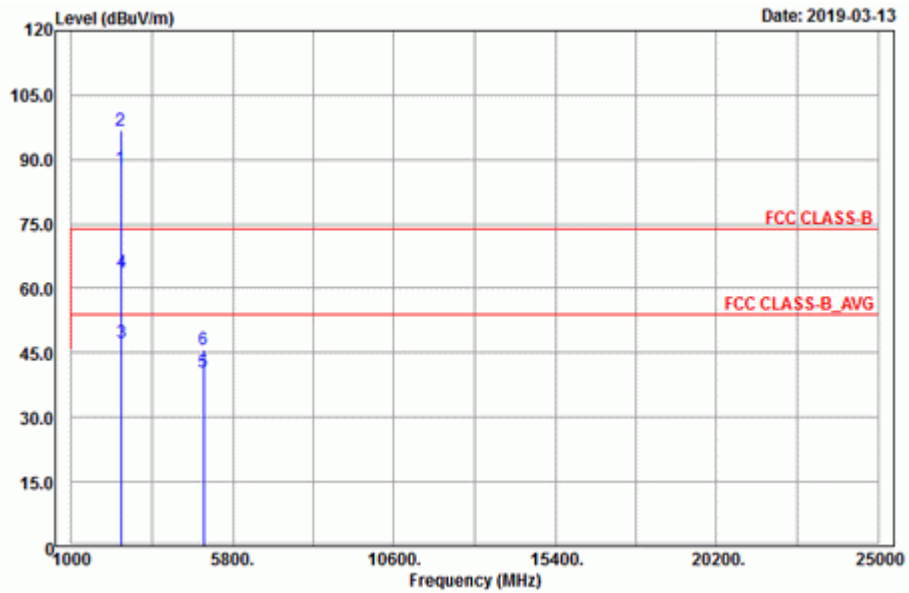

Antenna Polarity & Test Distance: Horizontal at 3 m

Frequency (MHz)	Emission Level (dBuV/m)	Read Level (dBuV)	Factor (dB/m)	Limit (dBuV/m)	Margin (dB)	Antenna Height (cm)	Table Angle (Degree)	Remark
2462	83.78	81.85	1.93			129	237	Average
2462	92.49	90.56	1.93			129	237	Peak
2494.52	41.04	39.02	2.02	54	-12.96	129	237	Average
2494.52	52.17	50.15	2.02	74	-21.83	129	237	Peak
4924	40.47	32.22	8.25	54	-13.53	145	55	Average
4924	45.7	37.45	8.25	74	-28.3	145	55	Peak

Antenna Polarity & Test Distance: Vertical at 3 m

Frequency (MHz)	Emission Level (dBuV/m)	Read Level (dBuV)	Factor (dB/m)	Limit (dBuV/m)	Margin (dB)	Antenna Height (cm)	Table Angle (Degree)	Remark
2462	88.05	86.12	1.93			215	360	Average
2462	96.68	94.75	1.93			215	360	Peak
2483.52	47.25	45.29	1.96	54	-6.75	215	360	Average
2483.52	63.65	61.69	1.96	74	-10.35	215	360	Peak
4924	40.58	32.33	8.25	54	-13.42	154	185	Average
4924	45.82	37.57	8.25	74	-28.18	154	185	Peak

Remarks:

- Emission Level = Read Level + Factor
Margin value = Emission level – Limit value
- 2462 MHz: Fundamental frequency.
- The emission levels of other frequencies were very low against the limit.

EUT Test Condition		Measurement Detail	
Channel	Channel 12	Frequency Range	1 GHz ~ 25 GHz
Input Power	120 Vac, 60 Hz	Detector Function	Peak (PK) Average (AV)
Environmental Conditions	25 deg. C, 65 % RH	Tested By	Harry Hsueh

Horizontal

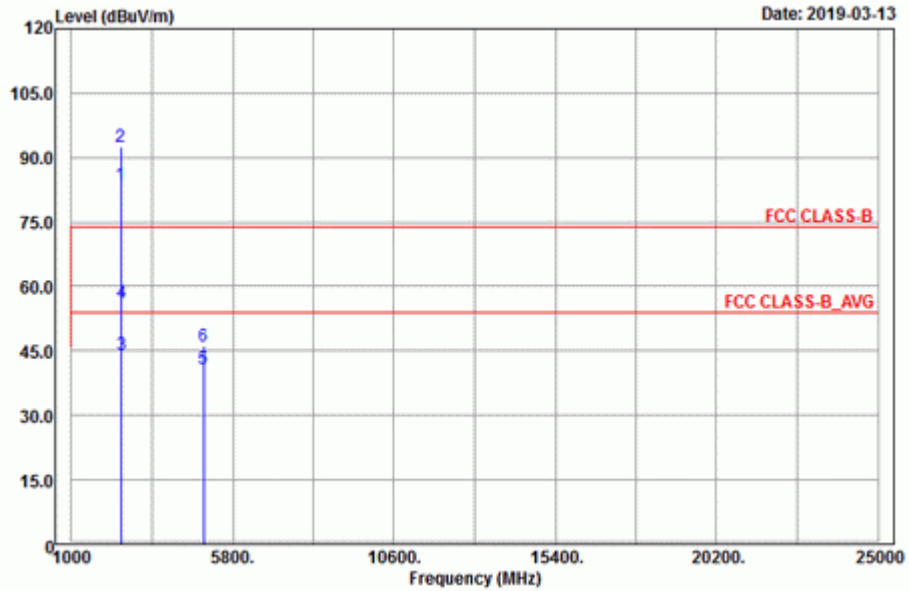

Vertical

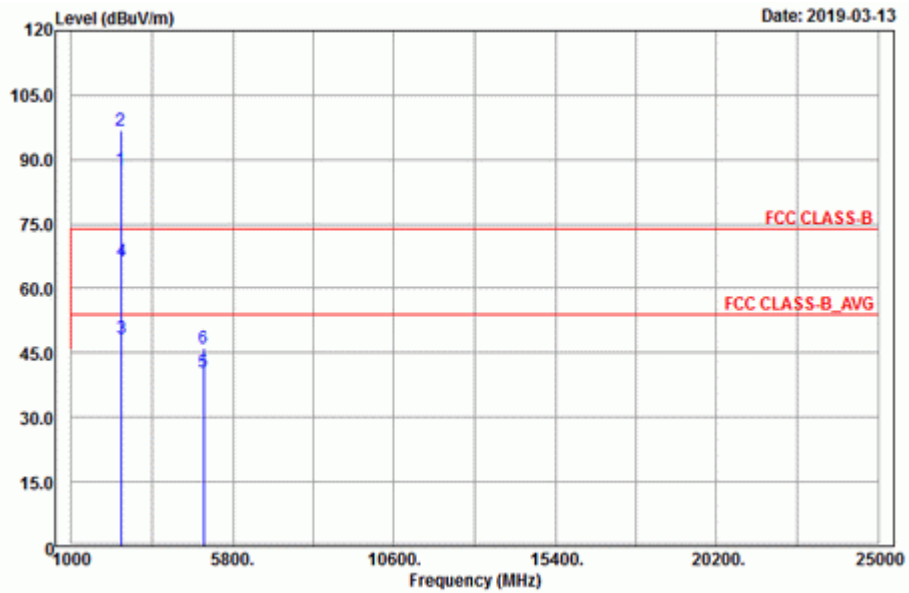

Antenna Polarity & Test Distance: Horizontal at 3 m								
Frequency (MHz)	Emission Level (dBuV/m)	Read Level (dBuV)	Factor (dB/m)	Limit (dBuV/m)	Margin (dB)	Antenna Height (cm)	Table Angle (Degree)	Remark
2467	83.81	81.86	1.95			215	41	Average
2467	92.59	90.64	1.95			215	41	Peak
2483.64	44.22	42.26	1.96	54	-9.78	215	41	Average
2483.64	56.35	54.39	1.96	74	-17.65	215	41	Peak
4934	40.82	32.56	8.26	54	-13.18	158	8	Average
4934	45.94	37.68	8.26	74	-28.06	158	8	Peak
Antenna Polarity & Test Distance: Vertical at 3 m								
Frequency (MHz)	Emission Level (dBuV/m)	Read Level (dBuV)	Factor (dB/m)	Limit (dBuV/m)	Margin (dB)	Antenna Height (cm)	Table Angle (Degree)	Remark
2467	87.71	85.76	1.95			101	350	Average
2467	96.68	94.73	1.95			101	350	Peak
2483.72	48.25	46.29	1.96	54	-5.75	101	350	Average
2483.72	66.48	64.52	1.96	74	-7.52	101	350	Peak
4934	40.51	32.25	8.26	54	-13.49	152	22	Average
4934	46	37.74	8.26	74	-28	152	22	Peak

Remarks:

1. Emission Level = Read Level + Factor
Margin value = Emission level – Limit value
2. 2467 MHz: Fundamental frequency.
3. The emission levels of other frequencies were very low against the limit.

EUT Test Condition		Measurement Detail	
Channel	Channel 13	Frequency Range	1 GHz ~ 25 GHz
Input Power	120 Vac, 60 Hz	Detector Function	Peak (PK) Average (AV)
Environmental Conditions	25 deg. C, 65 % RH	Tested By	Harry Hsueh

Horizontal

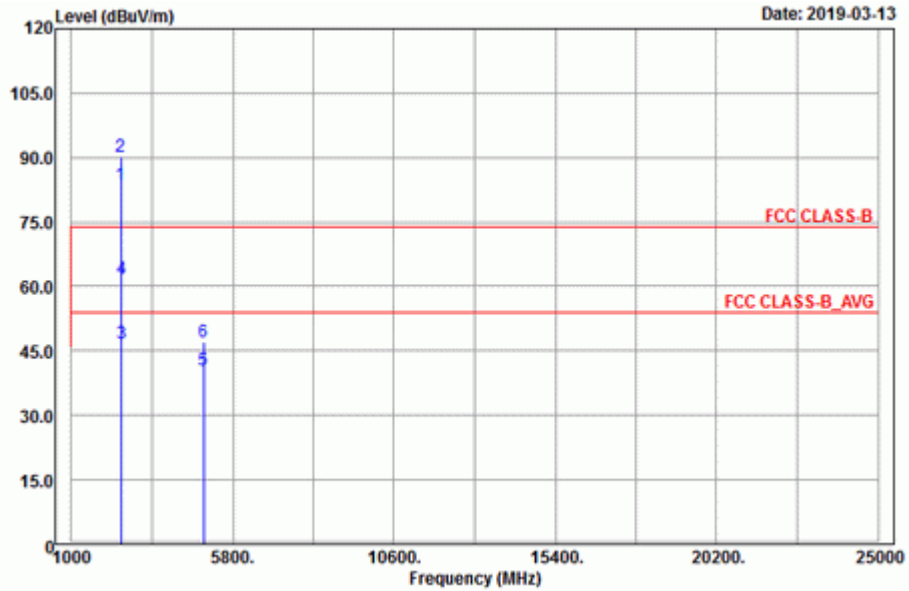

Vertical

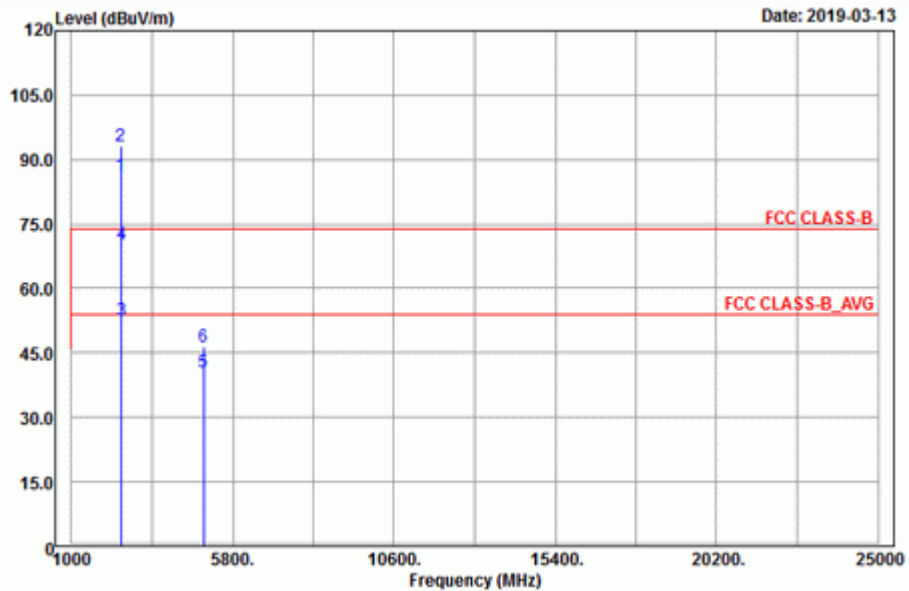

Antenna Polarity & Test Distance: Horizontal at 3 m

Frequency (MHz)	Emission Level (dBuV/m)	Read Level (dBuV)	Factor (dB/m)	Limit (dBuV/m)	Margin (dB)	Antenna Height (cm)	Table Angle (Degree)	Remark
2472	83.6	81.64	1.96			294	46	Average
2472	90.4	88.44	1.96			294	46	Peak
2483.52	46.61	44.65	1.96	54	-7.39	294	46	Average
2483.52	61.87	59.91	1.96	74	-12.13	294	46	Peak
4944	40.47	32.2	8.27	54	-13.53	190	9	Average
4944	46.94	38.67	8.27	74	-27.06	190	9	Peak

Antenna Polarity & Test Distance: Vertical at 3 m

Frequency (MHz)	Emission Level (dBuV/m)	Read Level (dBuV)	Factor (dB/m)	Limit (dBuV/m)	Margin (dB)	Antenna Height (cm)	Table Angle (Degree)	Remark
2472	86.44	84.48	1.96			182	350	Average
2472	93.3	91.34	1.96			182	350	Peak
2483.52	52.67	50.71	1.96	54	-1.33	182	350	Average
2483.52	70.2	68.24	1.96	74	-3.8	182	350	Peak
4944	40.42	32.15	8.27	54	-13.58	164	265	Average
4944	46.55	38.28	8.27	74	-27.45	164	265	Peak

Remarks:

- Emission Level = Read Level + Factor
Margin value = Emission level – Limit value
- 2472 MHz: Fundamental frequency.
- The emission levels of other frequencies were very low against the limit.

9 kHz ~ 30 MHz Data:

The amplitude of spurious emissions attenuated more than 20 dB below the permissible value is not required to be report.

30 MHz ~ 1 GHz Worst-Case Data:

802.11n (HT20)

EUT Test Condition		Measurement Detail	
Channel	Channel 13	Frequency Range	30 MHz ~ 1 GHz
Input Power	120 Vac, 60 Hz	Detector Function	Peak (PK) Quasi-peak (QP)
Environmental Conditions	25 deg. C, 65 % RH	Tested By	Harry Hsueh

Horizontal

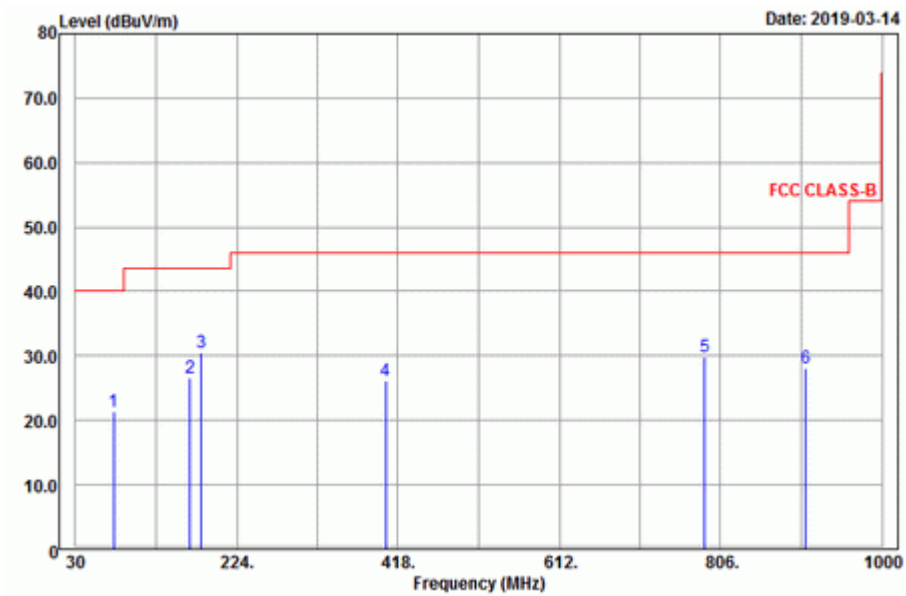

Vertical

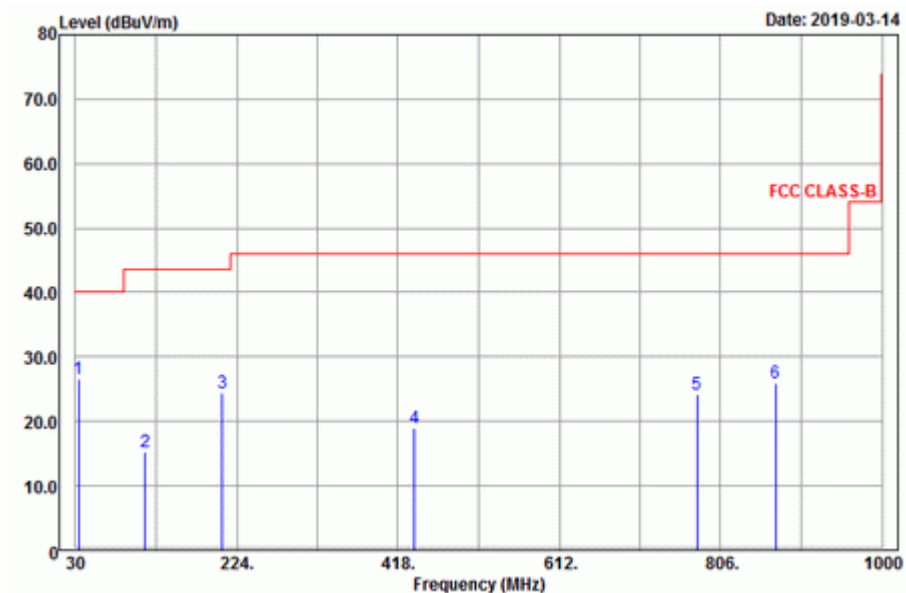

Antenna Polarity & Test Distance: Horizontal at 3 m

Frequency (MHz)	Emission Level (dBuV/m)	Read Level (dBuV)	Factor (dB/m)	Limit (dBuV/m)	Margin (dB)	Antenna Height (cm)	Table Angle (Degree)	Remark
76.17	21.33	44.07	-22.74	40	-18.67	159	33	Peak
167.7	26.58	48.29	-21.71	43.5	-16.92	105	32	Peak
181.2	30.45	51.25	-20.8	43.5	-13.05	157	161	Peak
402.9	26.11	40.97	-14.86	46	-19.89	154	240	Peak
787.2	29.95	38.55	-8.6	46	-16.05	189	255	Peak
908.3	28.03	34.42	-6.39	46	-17.97	105	326	Peak

Antenna Polarity & Test Distance: Vertical at 3 m

Frequency (MHz)	Emission Level (dBuV/m)	Read Level (dBuV)	Factor (dB/m)	Limit (dBuV/m)	Margin (dB)	Antenna Height (cm)	Table Angle (Degree)	Remark
33.51	26.64	46.31	-19.67	40	-13.36	105	183	Peak
114.24	15.18	34.73	-19.55	43.5	-28.32	189	114	Peak
206.58	24.47	43.96	-19.49	43.5	-19.03	124	244	Peak
437.9	18.89	33.16	-14.27	46	-27.11	145	191	Peak
778.1	24.2	32.92	-8.72	46	-21.8	144	7	Peak
872.6	25.99	32.93	-6.94	46	-20.01	109	95	Peak

Remarks:

- Emission Level = Read Level + Factor
Margin value = Emission level – Limit value.
- The emission levels of other frequencies were very low against the limit.

4.9 Conducted Emission Measurement

4.9.1 Limits of Conducted Emission Measurement

Frequency (MHz)	Conducted Limit (dBuV)	
	Quasi-Peak	Average
0.15 - 0.5	66 - 56	56 - 46
0.50 - 5.0	56	46
5.0 - 30.0	60	50

Note: 3. The lower limit shall apply at the transition frequencies.

4. The limit decreases in line with the logarithm of the frequency in the range of 0.15 to 0.50 MHz.

4.9.2 Test Instruments

Description & Manufacturer	Model No.	Serial No.	Date of Calibration	Due Date of Calibration
Test Receiver ROHDE & SCHWARZ	ESCI	100613	Dec. 10, 2018	Dec. 09, 2019
RF signal cable Woken	5D-FB	Cable-cond1-01	Sep. 05, 2018	Sep. 04, 2019
LISN/AMN ROHDE & SCHWARZ (EUT)	ENV216	101826	Feb. 21, 2019	Feb. 20, 2020
LISN/AMN ROHDE & SCHWARZ (Peripheral)	ESH3-Z5	100311	Aug. 19, 2018	Aug. 18, 2019
Software ADT	BV ADT_Cond_ V7.3.7.4	NA	NA	NA

Note: 1. The calibration interval of the above test instruments is 12 months and the calibrations are traceable to NML/ROC and NIST/USA.

2. The test was performed in HwaYa Shielded Room 1.
3. The VCCI Site Registration No. is C-12040.

4.9.3 Test Procedures

- The EUT was placed 0.4 meters from the conducting wall of the shielded room with EUT being connected to the power mains through a line impedance stabilization network (LISN). Other support units were connected to the power mains through another LISN. The two LISNs provide 50 ohm/50 uH of coupling impedance for the measuring instrument.
- Both lines of the power mains connected to the EUT were checked for maximum conducted interference.
- The frequency range from 150 kHz to 30 MHz was searched. Emission levels under (Limit – 20 dB) was not recorded.

Note: The resolution bandwidth and video bandwidth of test receiver is 9 kHz for quasi-peak detection (QP) and average detection (AV) at frequency 0.15 MHz – 30 MHz.

4.9.4 Deviation from Test Standard

No deviation.

4.9.5 Test Setup

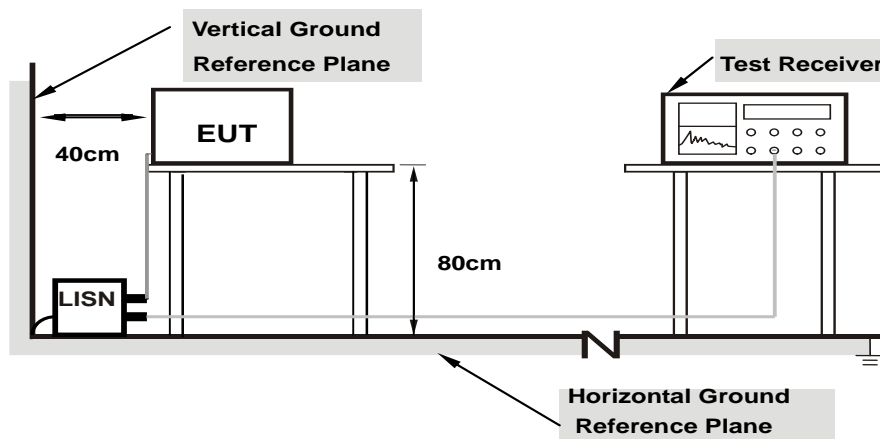

For the actual test configuration, please refer to the attached file (Test Setup Photo).

4.9.6 EUT Operating Conditions

- Placed the EUT on a testing table.
- Use the software to control the EUT under transmission condition continuously at specific channel frequency.

4.9.7 Test Results

Frequency Range	150kHz ~ 30MHz	Detector Function & Resolution Bandwidth	Quasi-Peak (QP) / Average (AV), 9kHz
Input Power	120Vac, 60Hz	Environmental Conditions	25°C, 65%RH
Tested by	Thomas Wei	Test Date	2019/3/19

Phase Of Power : Line (L)										
No	Frequency (MHz)	Correction Factor (dB)	Reading Value (dBuV)		Emission Level (dBuV)		Limit (dBuV)		Margin (dB)	
			Q.P.	AV.	Q.P.	AV.	Q.P.	AV.	Q.P.	AV.
1	0.16190	9.69	33.85	17.64	43.54	27.33	65.37	55.37	-21.83	-28.04
2	0.17801	9.68	32.01	15.38	41.69	25.06	64.58	54.58	-22.89	-29.52
3	0.22200	9.68	26.46	10.20	36.14	19.88	62.74	52.74	-26.60	-32.86
4	0.27000	9.68	22.32	7.21	32.00	16.89	61.12	51.12	-29.12	-34.23
5	0.46600	9.68	18.76	4.26	28.44	13.94	56.58	46.58	-28.14	-32.64
6	6.67400	9.80	17.24	3.56	27.04	13.36	60.00	50.00	-32.96	-36.64

Remarks:

1. Q.P. and AV. are abbreviations of quasi-peak and average individually.
2. The emission levels of other frequencies were very low against the limit.
3. Margin value = Emission level – Limit value
4. Correction factor = Insertion loss + Cable loss
5. Emission Level = Correction Factor + Reading Value

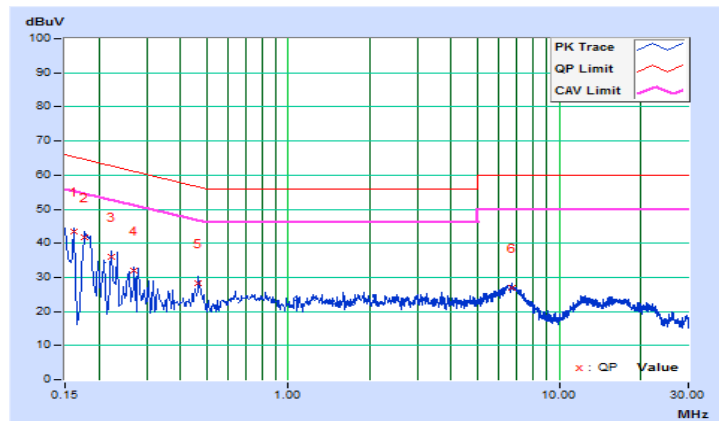

Frequency Range	150kHz ~ 30MHz	Detector Function & Resolution Bandwidth	Quasi-Peak (QP) / Average (AV), 9kHz
Input Power	120Vac, 60Hz	Environmental Conditions	25°C, 65%RH
Tested by	Thomas Wei	Test Date	2019/3/19

Phase Of Power : Neutral (N)										
No	Frequency (MHz)	Correction Factor (dB)	Reading Value (dBuV)		Emission Level (dBuV)		Limit (dBuV)		Margin (dB)	
			Q.P.	AV.	Q.P.	AV.	Q.P.	AV.	Q.P.	AV.
1	0.16200	9.66	30.32	15.05	39.98	24.71	65.36	55.36	-25.38	-30.65
2	0.21000	9.66	24.56	8.53	34.22	18.19	63.21	53.21	-28.99	-35.02
3	0.23000	9.66	18.66	4.15	28.32	13.81	62.45	52.45	-34.13	-38.64
4	0.25400	9.66	19.52	3.20	29.18	12.86	61.63	51.63	-32.45	-38.77
5	0.31000	9.65	18.43	4.30	28.08	13.95	59.97	49.97	-31.89	-36.02
6	0.45837	9.65	16.65	2.65	26.30	12.30	56.72	46.72	-30.42	-34.42

Remarks:

1. Q.P. and AV. are abbreviations of quasi-peak and average individually.
2. The emission levels of other frequencies were very low against the limit.
3. Margin value = Emission level – Limit value
4. Correction factor = Insertion loss + Cable loss
5. Emission Level = Correction Factor + Reading Value

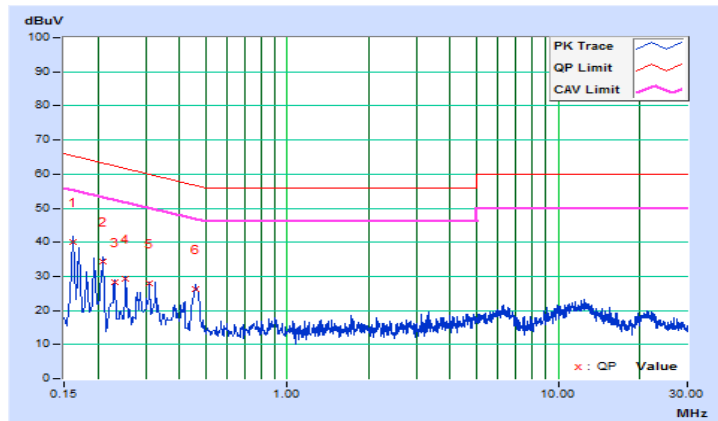

4.10 6 dB Bandwidth Measurement

4.10.1 Limits of 6 dB Bandwidth Measurement

The minimum of 6 dB Bandwidth Measurement is 0.5 MHz.

4.10.2 Test Setup

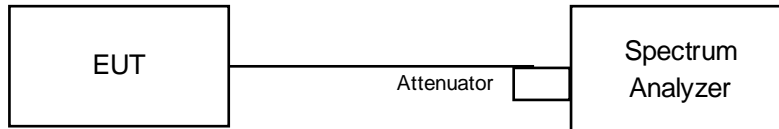

4.10.3 Test Instruments

Refer to section 4.1.2 to get information of above instrument.

4.10.4 Test Procedure

- f. Set resolution bandwidth (RBW) = 100 kHz
- g. Set the video bandwidth (VBW) $\geq 3 \times$ RBW, Detector = Peak.
- h. Trace mode = max hold.
- i. Sweep = auto couple.
- j. Measure the maximum width of the emission that is constrained by the frequencies associated with the two amplitude points (upper and lower) that are attenuated by 6 dB relative to the maximum level measured in the fundamental emission

4.10.5 Deviation from Test Standard

No deviation.

4.10.6 EUT Operating Conditions

The software provided by client to enable the EUT under transmission condition continuously at lowest, middle and highest channel frequencies individually.

4.10.7 Test Results

802.11b

Channel	Frequency (MHz)	6 dB Bandwidth (MHz)	Minimum Limit (MHz)	Pass / Fail
1	2412	8.09	0.5	Pass
6	2437	8.09	0.5	Pass
11	2462	8.56	0.5	Pass
12	2467	8.09	0.5	Pass
13	2472	8.09	0.5	Pass

802.11g

Channel	Frequency (MHz)	6 dB Bandwidth (MHz)	Minimum Limit (MHz)	Pass / Fail
1	2412	16.38	0.5	Pass
6	2437	16.37	0.5	Pass
11	2462	16.37	0.5	Pass
12	2467	16.38	0.5	Pass
13	2472	16.39	0.5	Pass

802.11n (HT20)

Channel	Frequency (MHz)	6 dB Bandwidth (MHz)	Minimum Limit (MHz)	Pass / Fail
1	2412	17.60	0.5	Pass
6	2437	17.59	0.5	Pass
11	2462	17.61	0.5	Pass
12	2467	17.61	0.5	Pass
13	2472	17.61	0.5	Pass

Spectrum Plot of Worst Value

802.11b

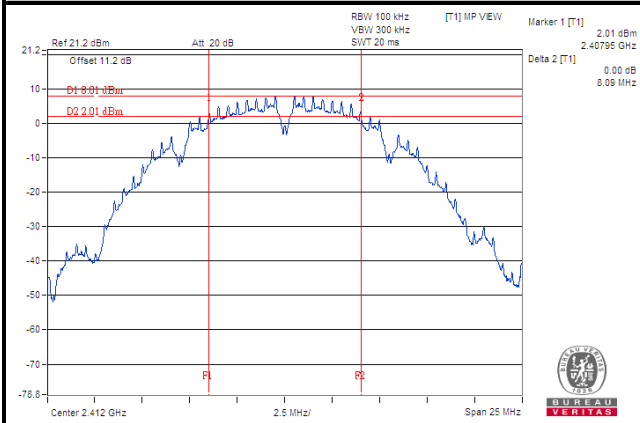

802.11g

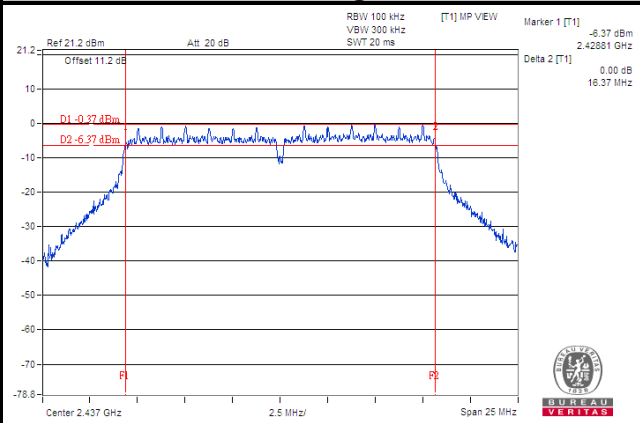

802.11n (HT20)

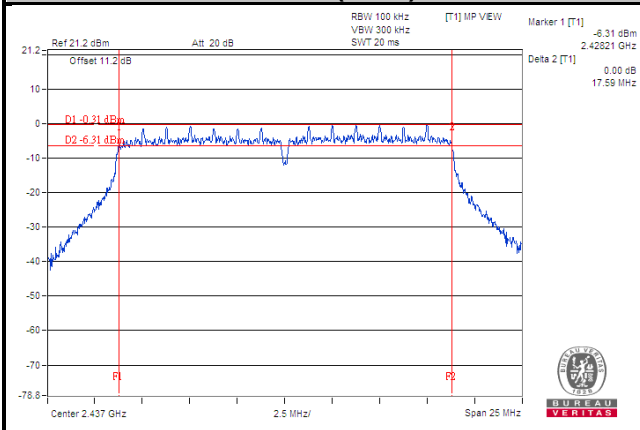

4.11 Occupied Bandwidth Measurement

4.11.1 Test Setup

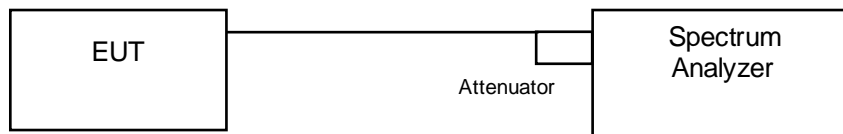

4.11.2 Test Instruments

Refer to section 4.1.2 to get information of above instrument.

4.11.3 Test Procedure

The transmitter output was connected to the spectrum analyzer through an attenuator. The bandwidth of the fundamental frequency was measured by spectrum analyzer with resolution bandwidth in the range of 1 % to 5 % of the anticipated emission bandwidth, and a video bandwidth at least 3x the resolution bandwidth and set the detector to PEAK. The width of a frequency band such that, below the lower and above the upper frequency limits, the mean powers emitted are each equal to a specified percentage 0.5 % of the total mean power of a given emission.

4.11.4 Deviation from Test Standard

No deviation.

4.11.5 EUT Operating Conditions

The software provided by client to enable the EUT under transmission condition continuously at lowest, middle and highest channel frequencies individually.

4.11.6 Test Results

802.11b

Channel	Frequency (MHz)	Occupied Bandwidth (MHz)	Pass / Fail
1	2412	13.20	Pass
6	2437	13.08	Pass
11	2462	13.14	Pass
12	2467	13.14	Pass
13	2472	13.14	Pass

802.11g

Channel	Frequency (MHz)	Occupied Bandwidth (MHz)	Pass / Fail
1	2412	16.92	Pass
6	2437	17.04	Pass
11	2462	17.04	Pass
12	2467	17.04	Pass
13	2472	17.04	Pass

802.11n (HT20)

Channel	Frequency (MHz)	Occupied Bandwidth (MHz)	Pass / Fail
1	2412	18.12	Pass
6	2437	18.06	Pass
11	2462	18.00	Pass
12	2467	18.00	Pass
13	2472	18.12	Pass

Spectrum Plot of Worst Value

802.11b

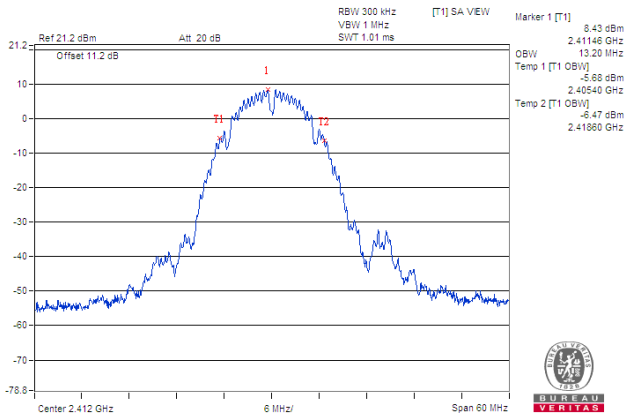

802.11g

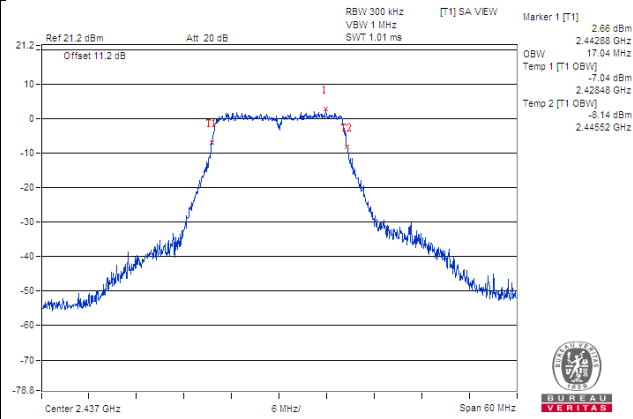

802.11n (HT20)

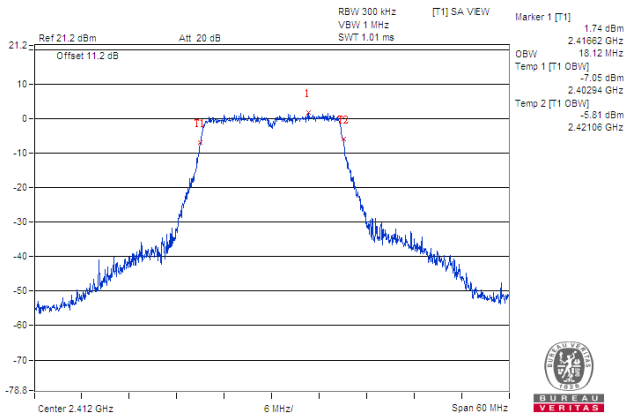

4.12 Conducted Output Power Measurement

4.12.1 Limits of Conducted Output Power Measurement

For systems using digital modulation in the 2400–2483.5 MHz bands: 1 Watt (30 dBm)

4.12.2 Test Setup

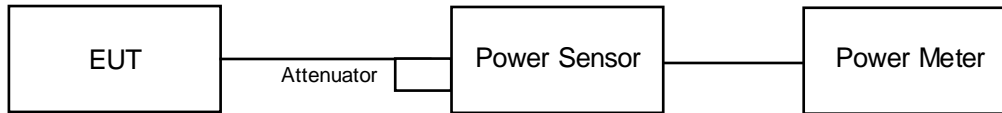

4.12.3 Test Instruments

Refer to section 4.1.2 to get information of above instrument.

4.12.4 Test Procedures

A peak power sensor was used on the output port of the EUT. A power meter was used to read the response of the peak power sensor. Record the power level.

4.12.5 Deviation from Test Standard

No deviation.

4.12.6 EUT Operating Conditions

The software provided by client to enable the EUT under transmission condition continuously at lowest, middle and highest channel frequencies individually.

4.12.7 Test Results

802.11b

Channel	Frequency (MHz)	Peak Power (mW)	Peak Power (dBm)	Limit (dBm)	Pass / Fail
1	2412	68.549	18.36	30	Pass
6	2437	67.608	18.30	30	Pass
11	2462	66.527	18.23	30	Pass
12	2467	67.143	18.27	30	Pass
13	2472	42.073	16.24	30	Pass

802.11g

Channel	Frequency (MHz)	Peak Power (mW)	Peak Power (dBm)	Limit (dBm)	Pass / Fail
1	2412	85.31	19.31	30	Pass
6	2437	84.333	19.26	30	Pass
11	2462	83.753	19.23	30	Pass
12	2467	86.896	19.39	30	Pass
13	2472	52.845	17.23	30	Pass

802.11n (HT20)

Channel	Frequency (MHz)	Peak Power (mW)	Peak Power (dBm)	Limit (dBm)	Pass / Fail
1	2412	81.096	19.09	30	Pass
6	2437	79.799	19.02	30	Pass
11	2462	82.035	19.14	30	Pass
12	2467	81.283	19.10	30	Pass
13	2472	56.885	17.55	30	Pass

4.13 Power Spectral Density Measurement

4.13.1 Limits of Power Spectral Density Measurement

The Maximum of Power Spectral Density Measurement is 8 dBm.

4.13.2 Test Setup

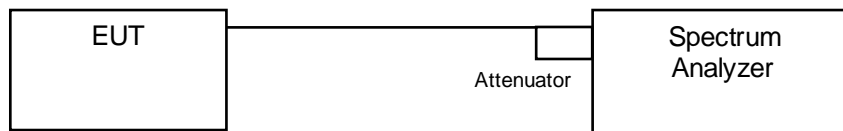

4.13.3 Test Instruments

Refer to section 4.1.2 to get information of above instrument.

4.13.4 Test Procedure

- a. Set analyzer center frequency to DTS channel center frequency.
- b. Set the span to 1.5 times the DTS bandwidth.
- c. Set the RBW to: $3 \text{ kHz} \leq \text{RBW} \leq 100 \text{ kHz}$.
- d. Set the VBW $\geq 3 \times \text{RBW}$.
- e. Detector = peak.
- f. Sweep time = auto couple.
- g. Trace mode = max hold.
- h. Allow trace to fully stabilize.
- i. Use the peak marker function to determine the maximum amplitude level within the RBW.

4.13.5 Deviation from Test Standard

No deviation.

4.13.6 EUT Operating Condition

The software provided by client to enable the EUT under transmission condition continuously at lowest, middle and highest channel frequencies individually.

4.13.7 Test Results

802.11b

Channel	Frequency (MHz)	PSD (dBm/3 kHz)	Limit (dBm/3 kHz)	Pass / Fail
1	2412	-4.43	8	Pass
6	2437	-5.21	8	Pass
11	2462	-4.23	8	Pass
12	2467	-5.14	8	Pass
13	2472	-7.27	8	Pass

802.11g

Channel	Frequency (MHz)	PSD (dBm/3 kHz)	Limit (dBm/3 kHz)	Pass / Fail
1	2412	-12.86	8	Pass
6	2437	-12.32	8	Pass
11	2462	-11.65	8	Pass
12	2467	-11.80	8	Pass
13	2472	-14.26	8	Pass

802.11n (HT20)

Channel	Frequency (MHz)	PSD (dBm/3 kHz)	Limit (dBm/3 kHz)	Pass / Fail
1	2412	-11.95	8	Pass
6	2437	-12.78	8	Pass
11	2462	-13.80	8	Pass
12	2467	-12.48	8	Pass
13	2472	-15.05	8	Pass

Spectrum Plot of Worst Value

802.11b

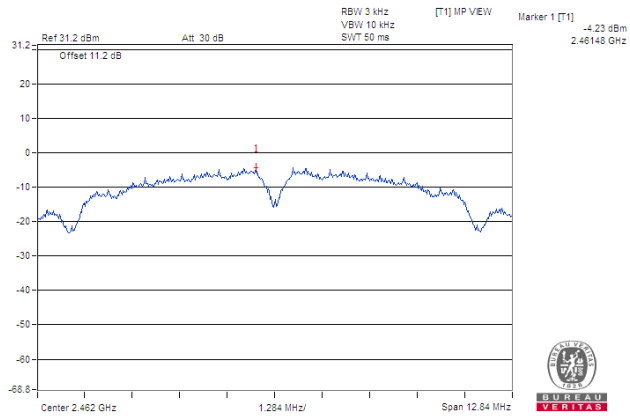

802.11g

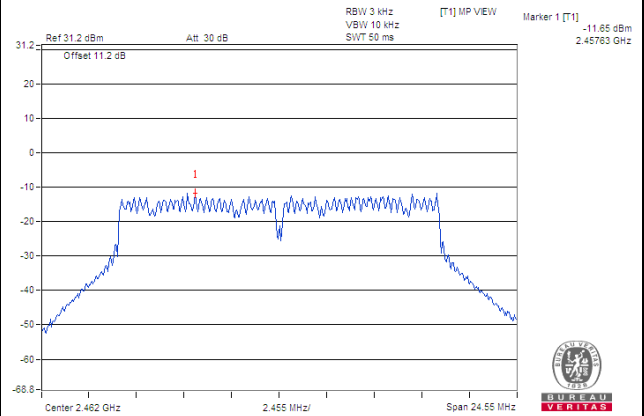

802.11n (HT20)

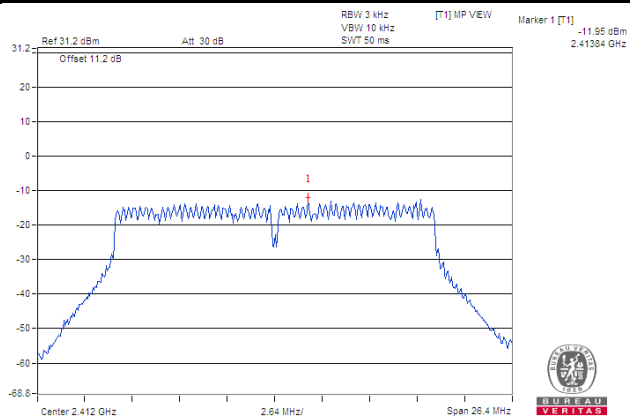

4.14 Conducted Out of Band Emission Measurement

4.14.1 Limits of Conducted Out of Band Emission Measurement

Below -20 dB of the highest emission level of operating band (in 100 kHz Resolution Bandwidth).

4.14.2 Test Setup

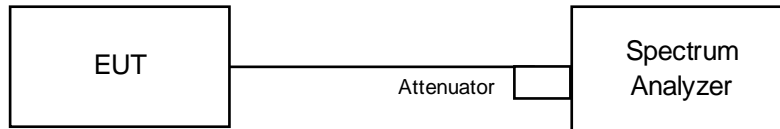

4.14.3 Test Instruments

Refer to section 4.1.2 to get information of above instrument.

4.14.4 Test Procedure

MEASUREMENT PROCEDURE REF

1. Set the RBW = 100 kHz.
2. Set the VBW \geq 300 kHz.
3. Detector = peak.
4. Sweep time = auto couple.
5. Trace mode = max hold.
6. Allow trace to fully stabilize.
7. Use the peak marker function to determine the maximum power level in any 100 kHz band segment within the fundamental EBW.

MEASUREMENT PROCEDURE OOB

1. Set RBW = 100 kHz.
2. Set VBW \geq 300 kHz.
3. Detector = peak.
4. Sweep = auto couple.
5. Trace Mode = max hold.
6. Allow trace to fully stabilize.
7. Use the peak marker function to determine the maximum amplitude level.

4.14.5 Deviation from Test Standard

No deviation.

4.14.6 EUT Operating Condition

The software provided by client to enable the EUT under transmission condition continuously at lowest, middle and highest channel frequencies individually.

4.14.7 Test Results

The spectrum plots are attached on the following images. D1 line indicates the highest level, and D2 line indicates the 20 dB offset below D1. It shows compliance with the requirement.

802.11b

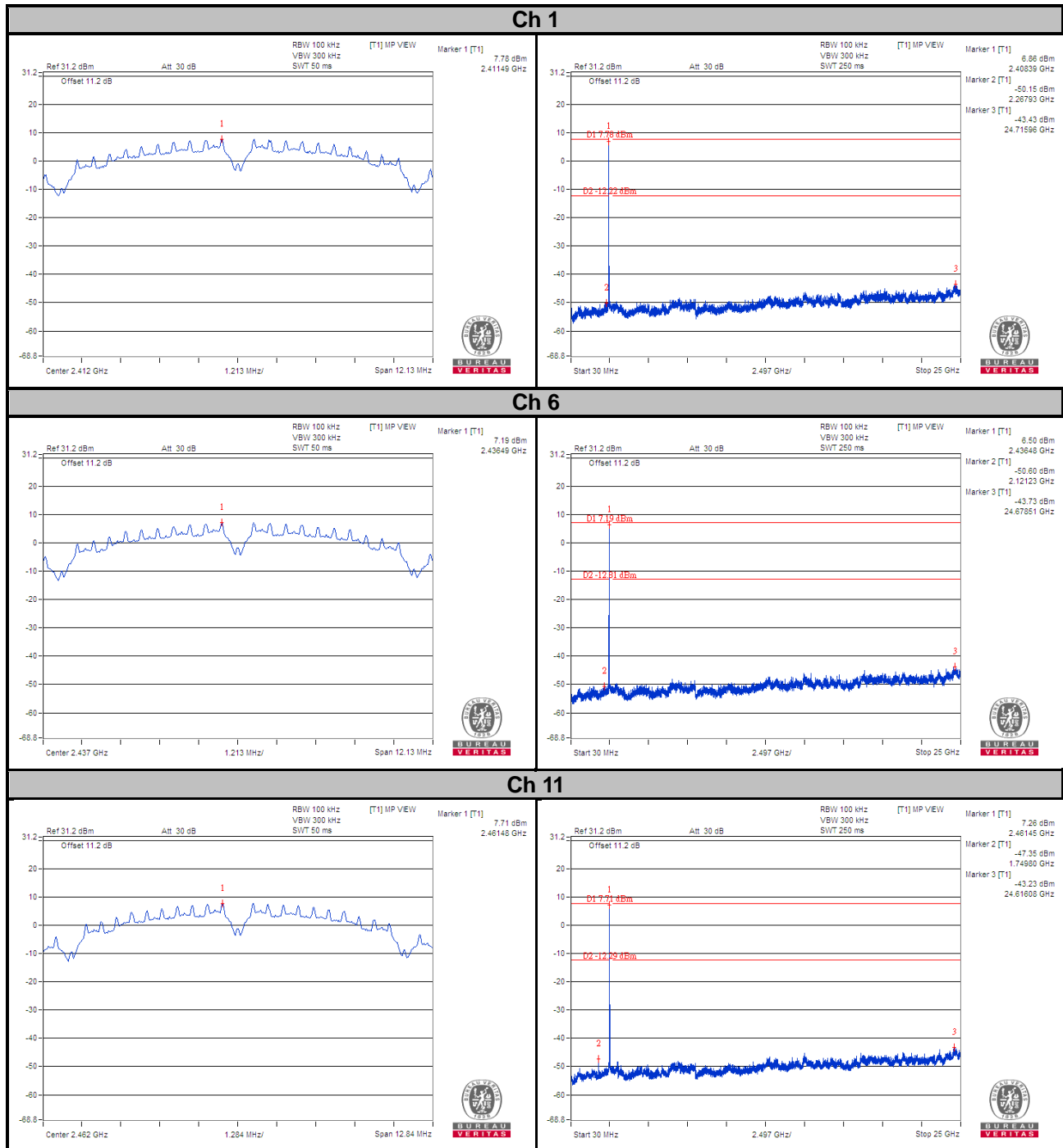

Ch 12

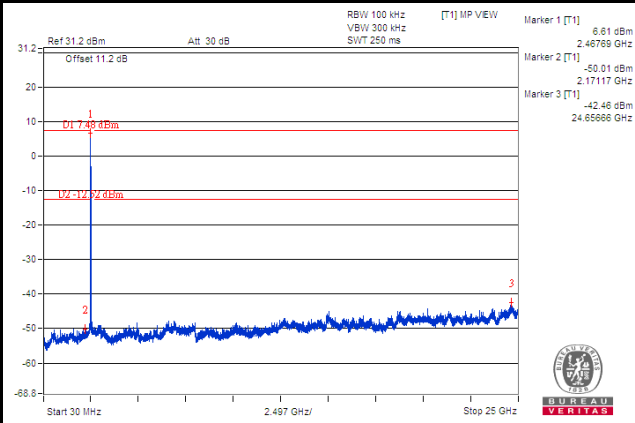
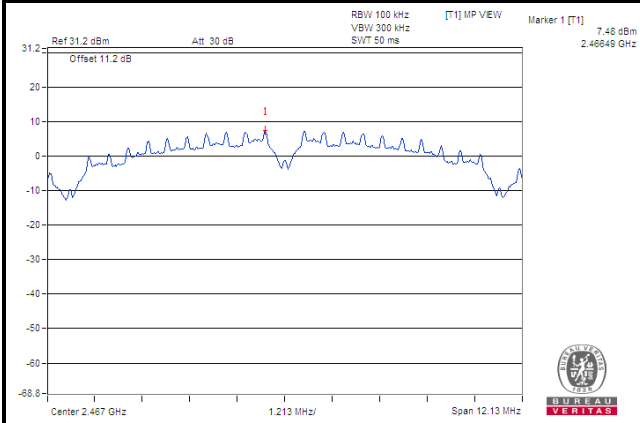

Ch 13

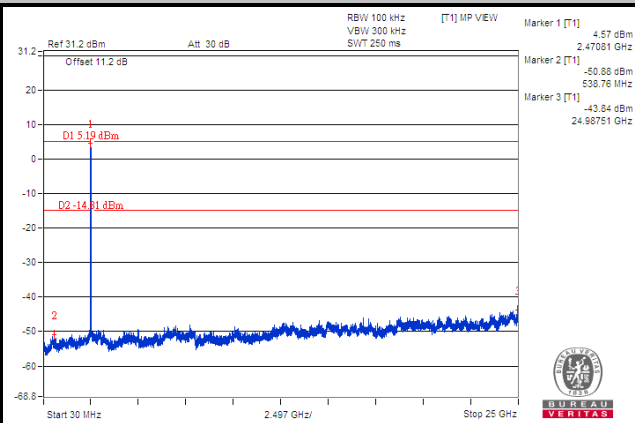
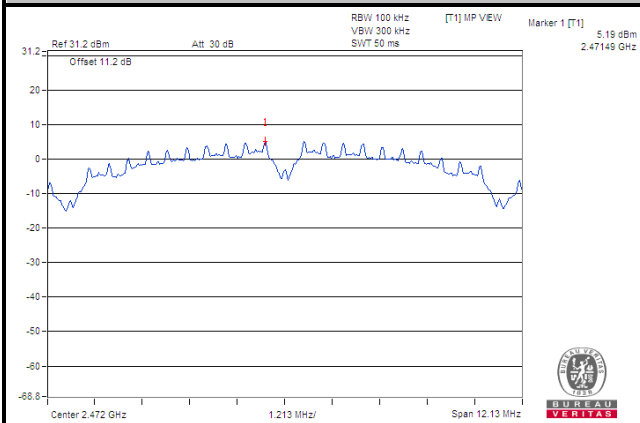

Ch 1 Band Edge

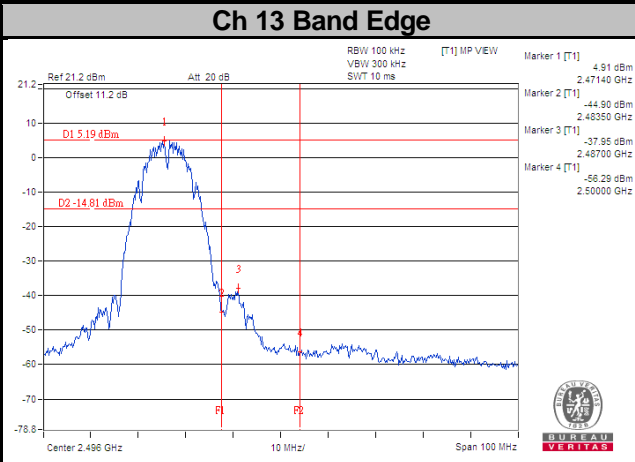
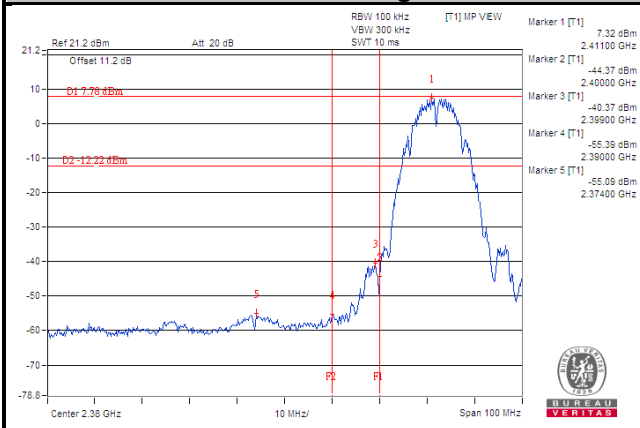

802.11g

Ch 1

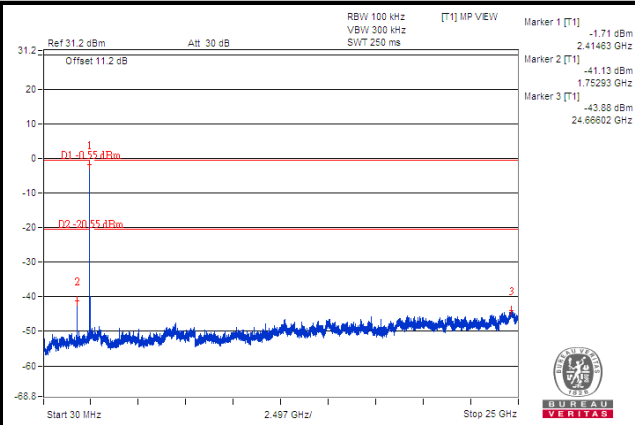
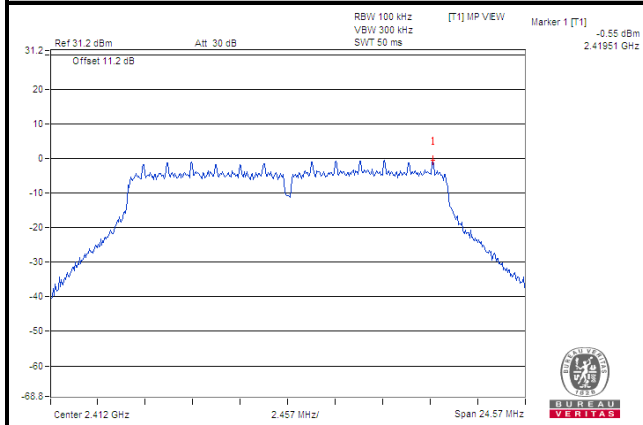

Ch 6

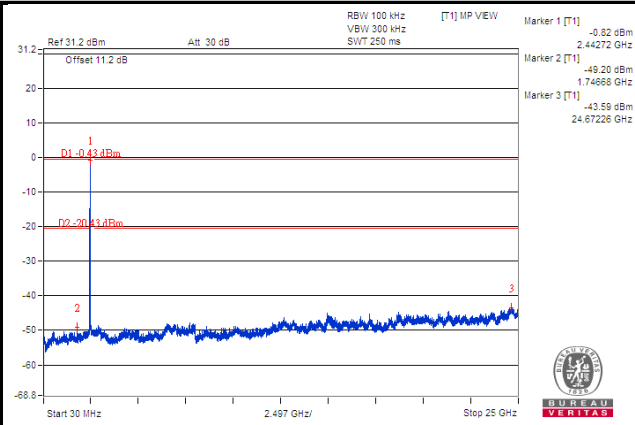
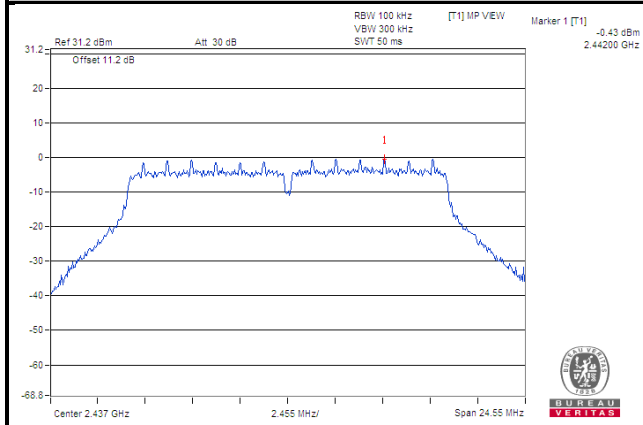

Ch 11

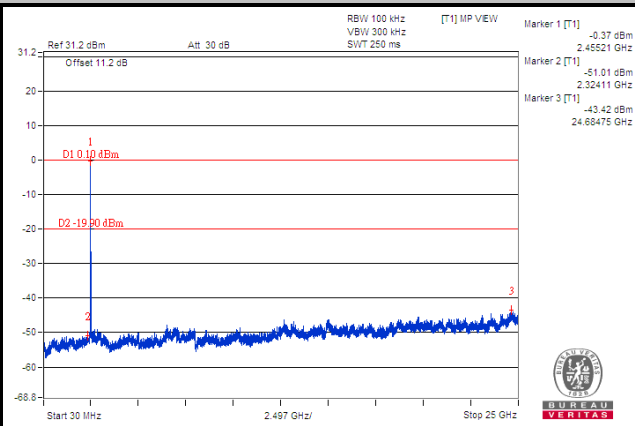
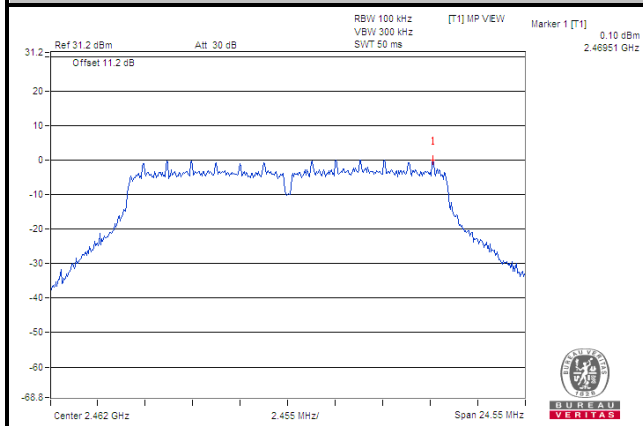

Ch 12

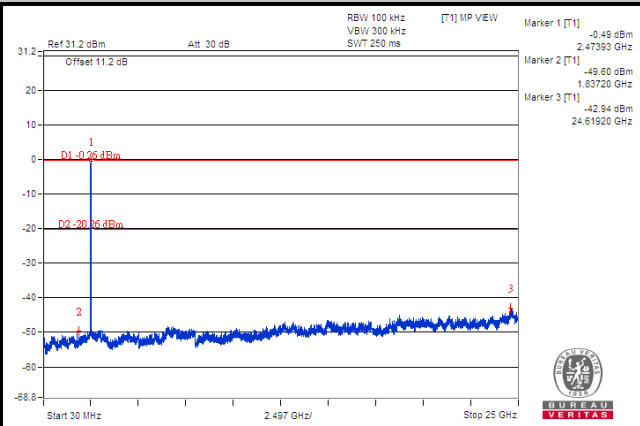
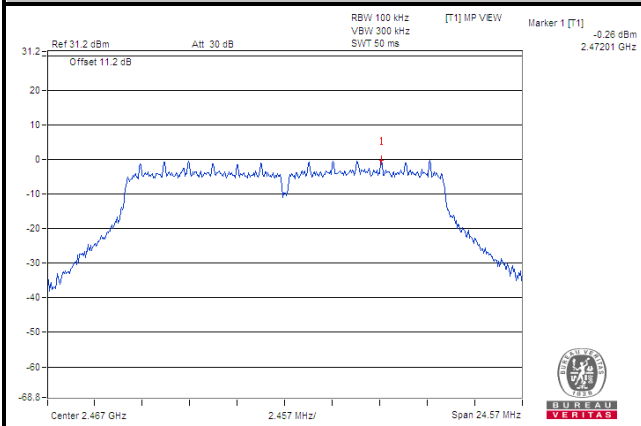

Ch 13

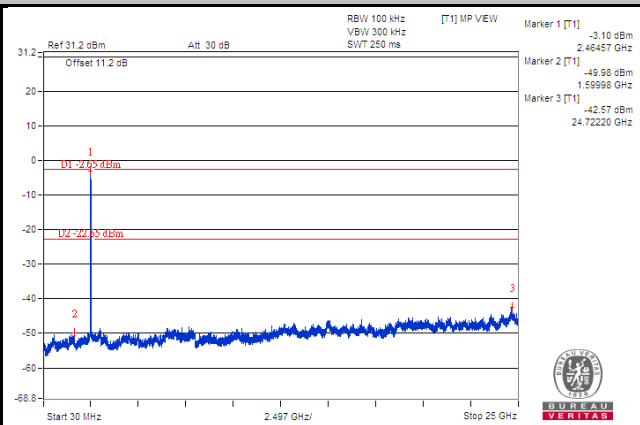
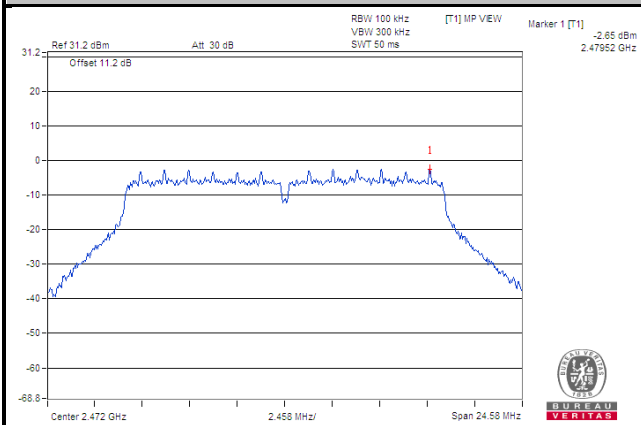

Ch 1 Band Edge

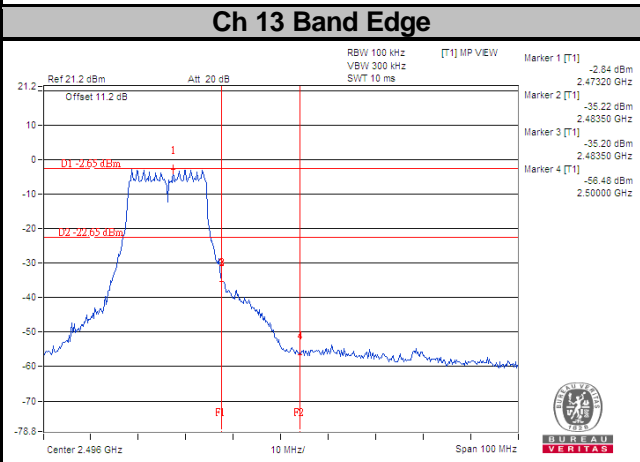
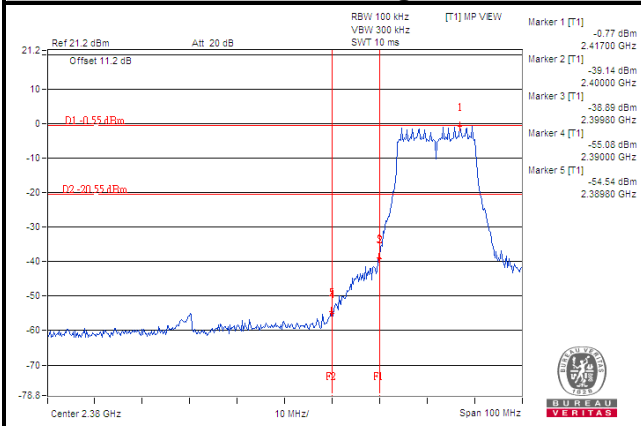

802.11n (HT20)

Ch 1

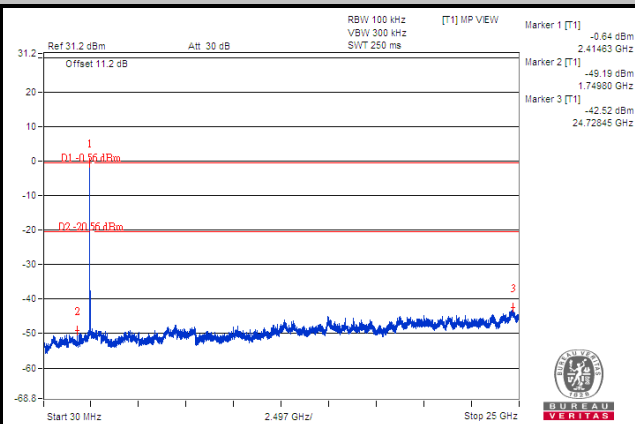
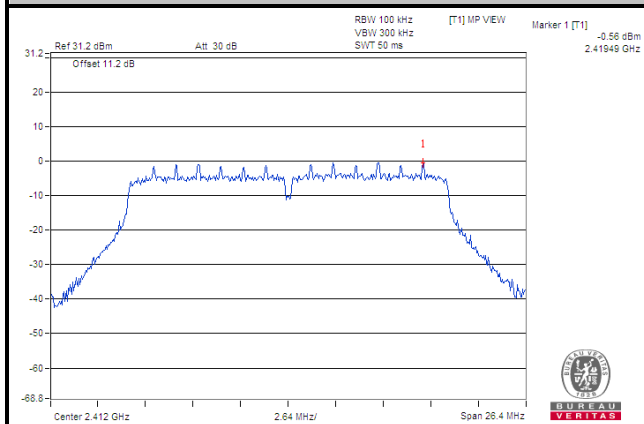

Ch 6

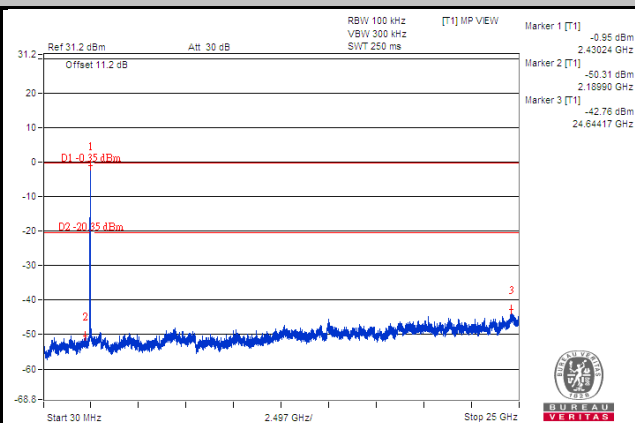
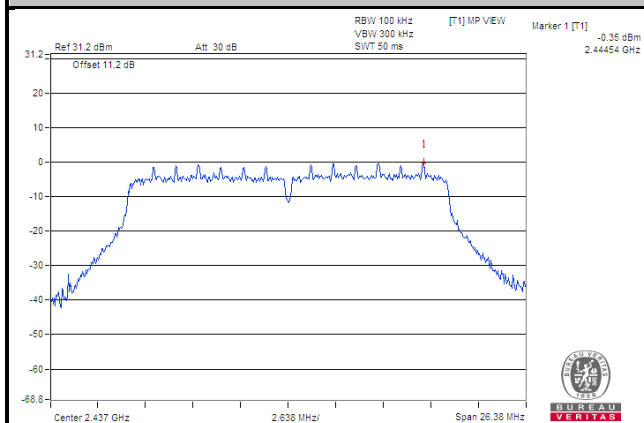

Ch 11

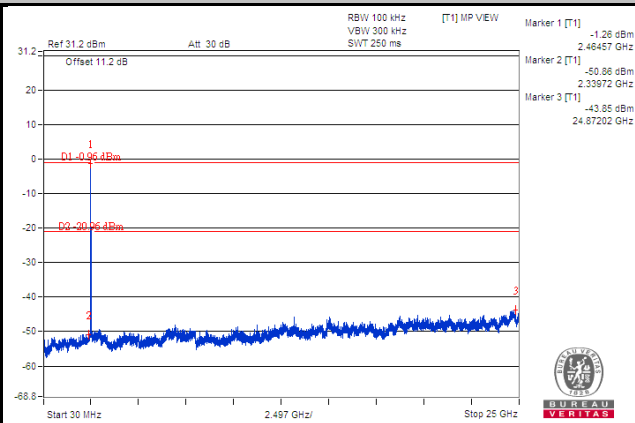
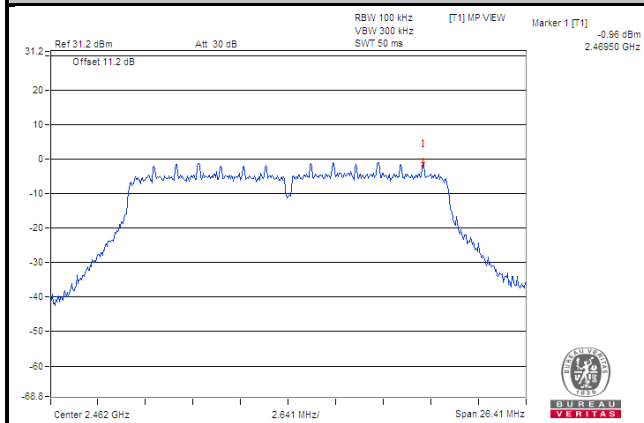

Ch 12

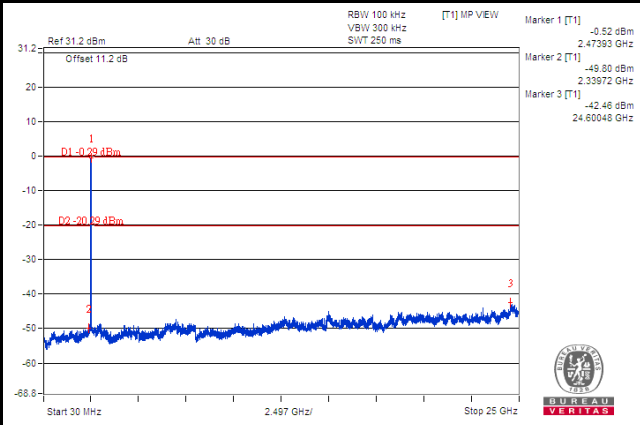
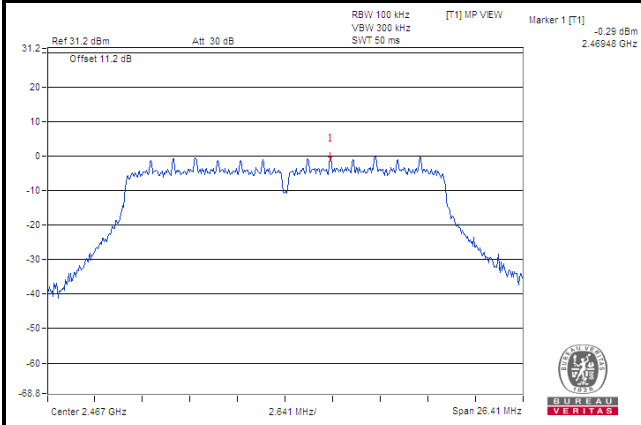

Ch 13

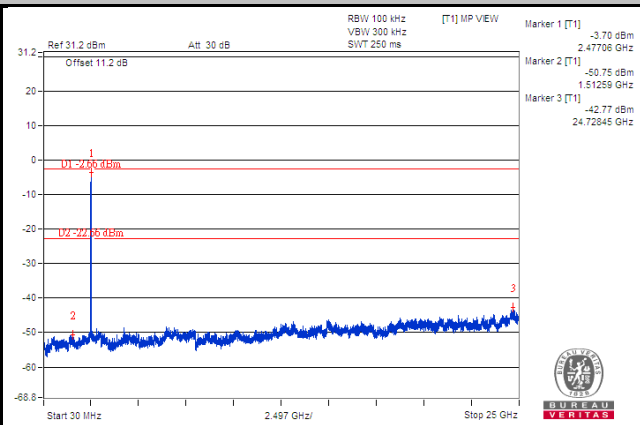
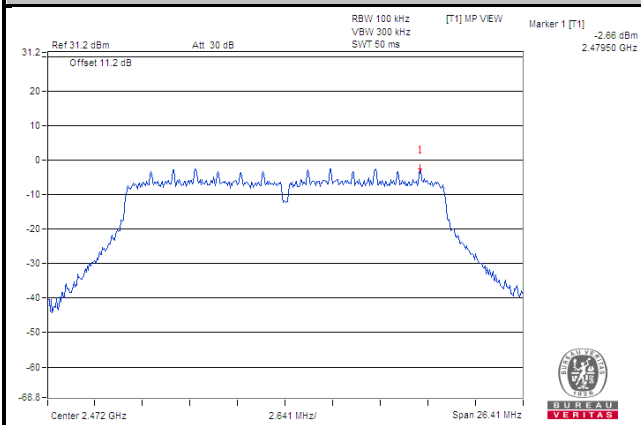

Ch 1 Band Edge

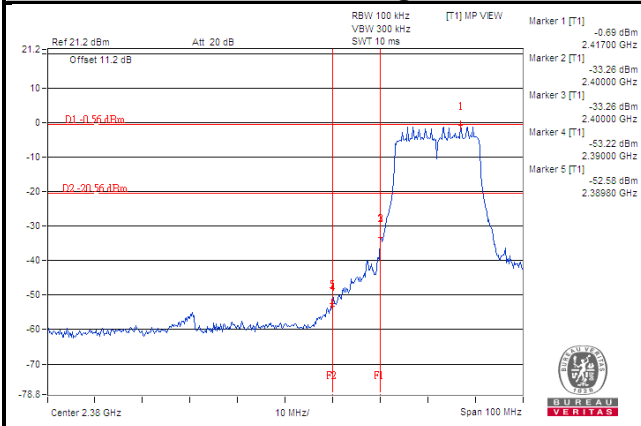

Ch 13 Band Edge

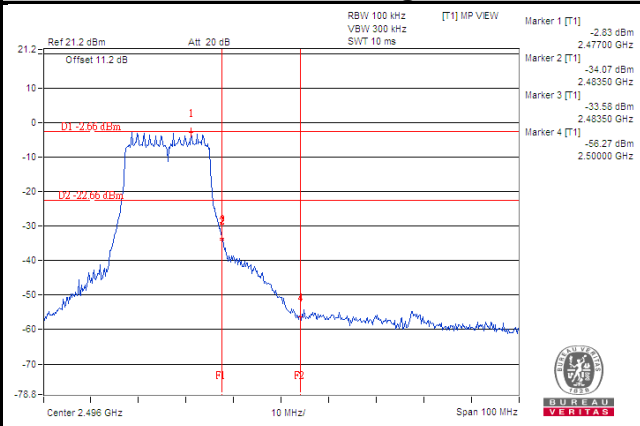

5 Pictures of Test Arrangements

Please refer to the attached file (Test Setup Photo).

Annex A- Band-edge measurement

<Bluetooth LE>

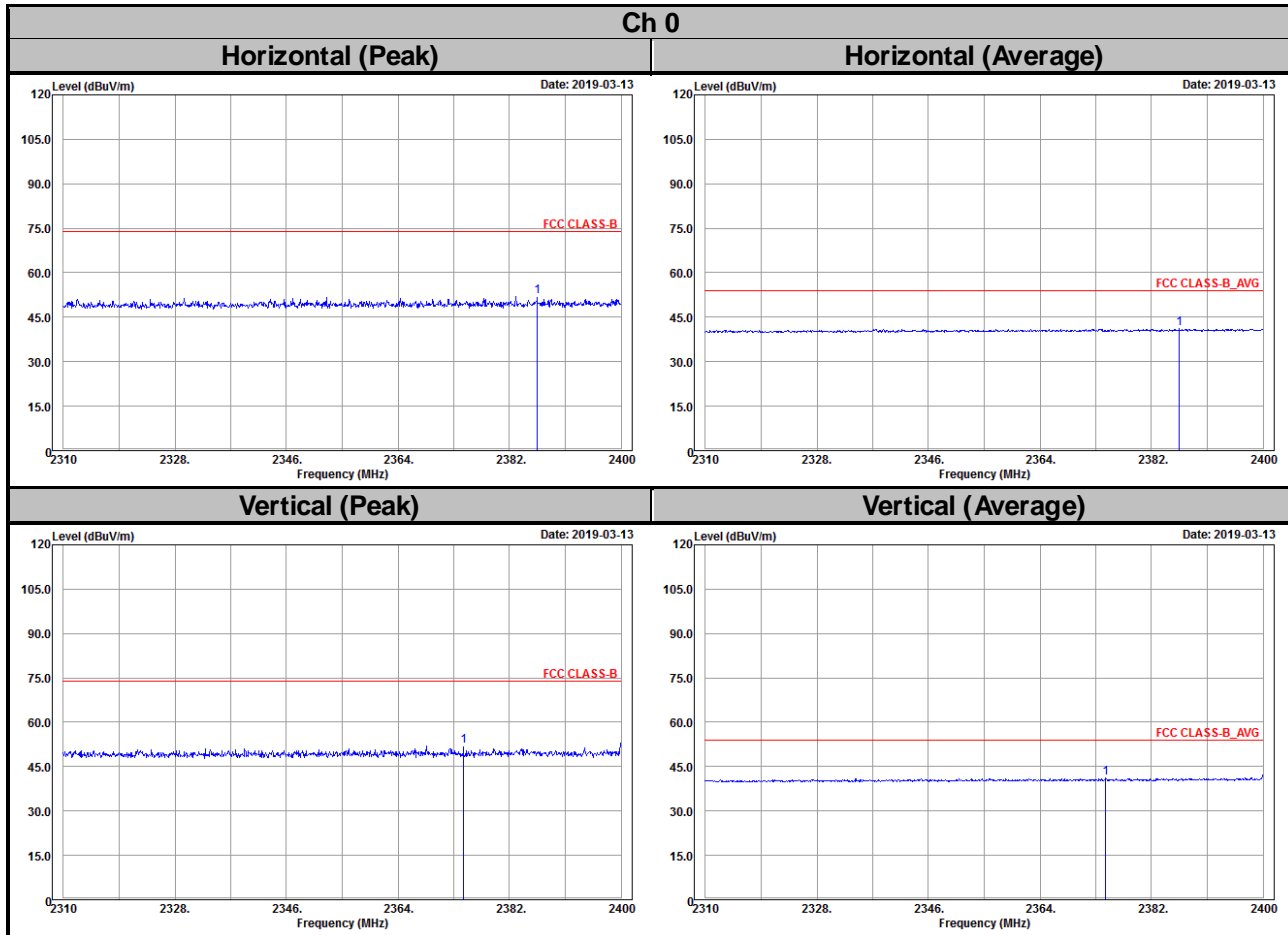

Ch 39

Horizontal (Peak)

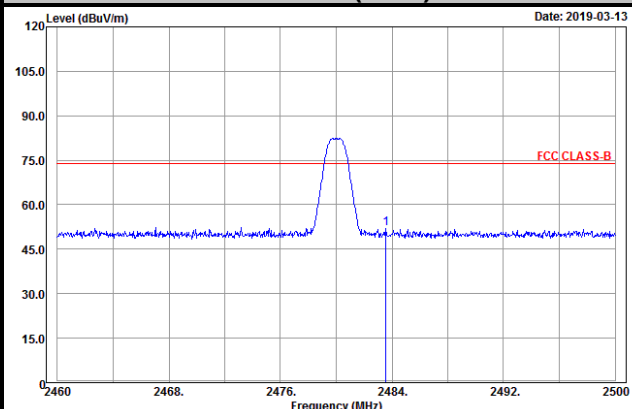

Horizontal (Average)

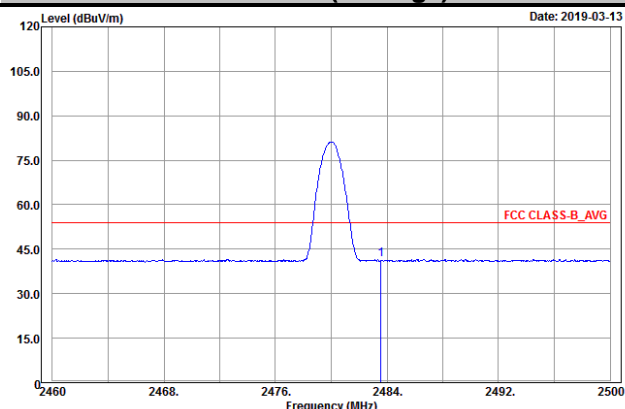

Vertical (Peak)

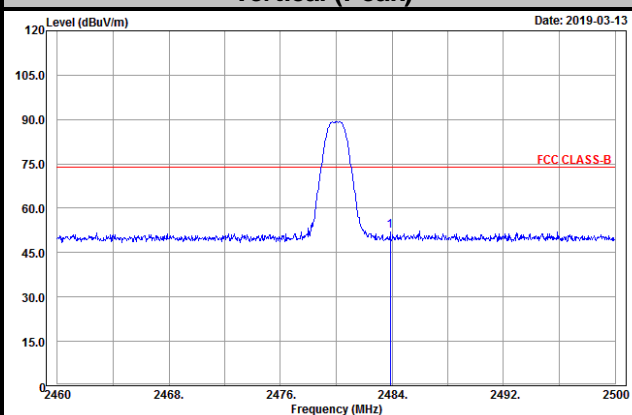

Vertical (Average)

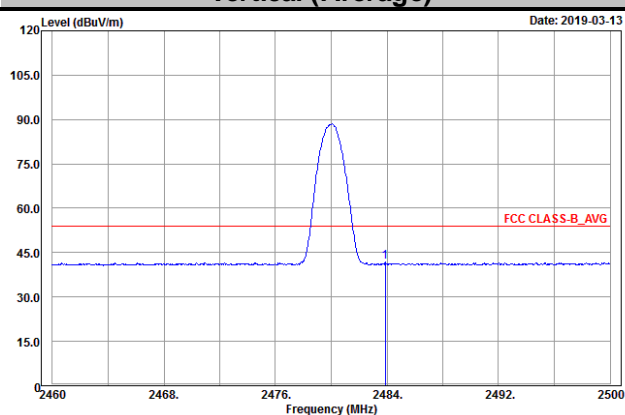

<WLAN>
802.11b

Ch 1

Horizontal (Peak)

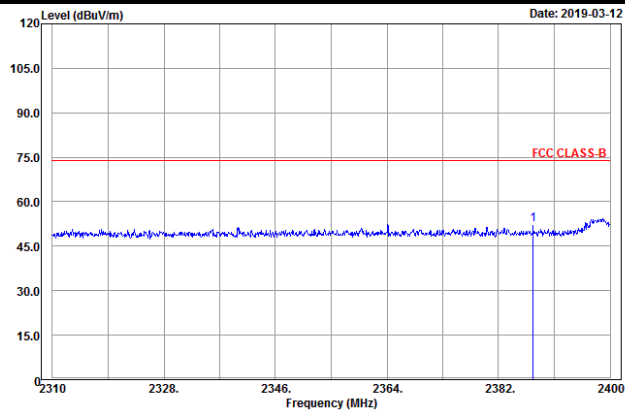

Horizontal (Average)

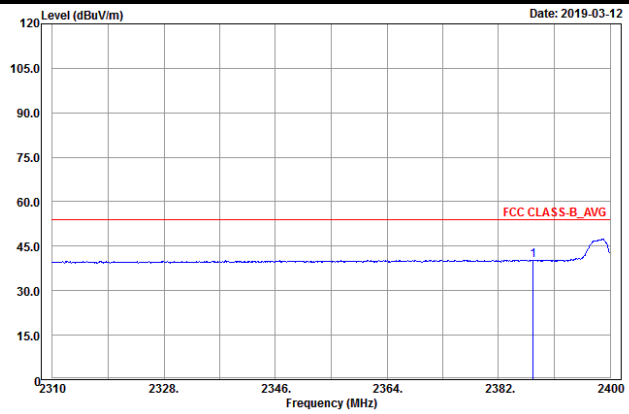

Vertical (Peak)

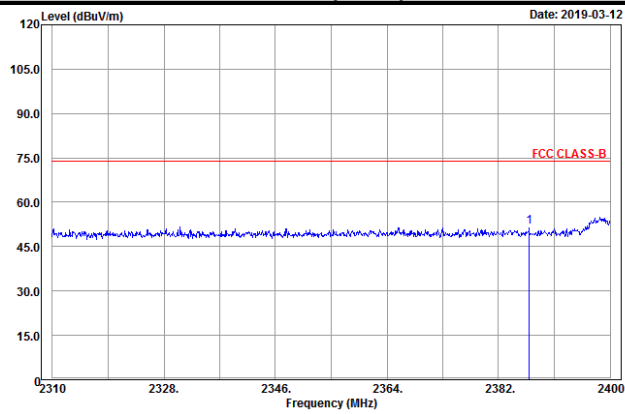

Vertical (Average)

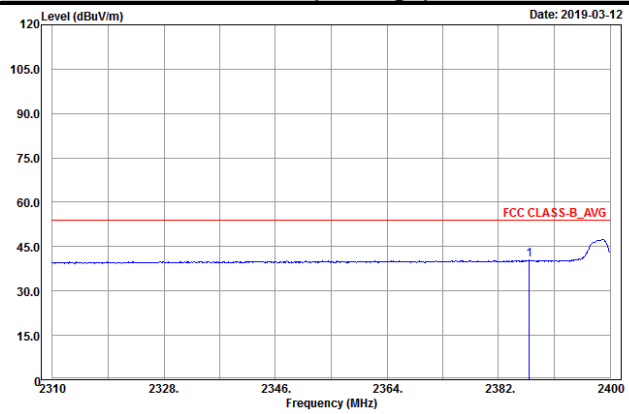

Ch 11

Horizontal (Peak)

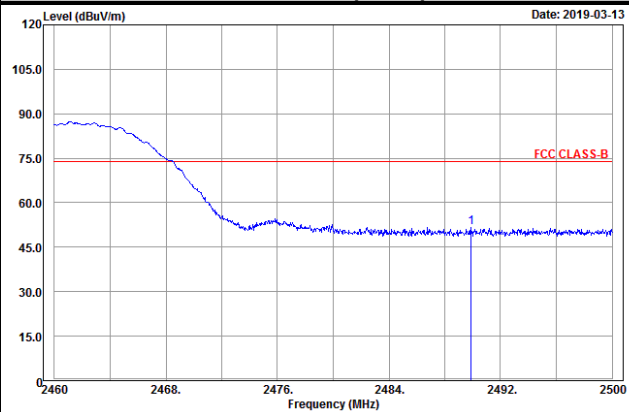

Horizontal (Average)

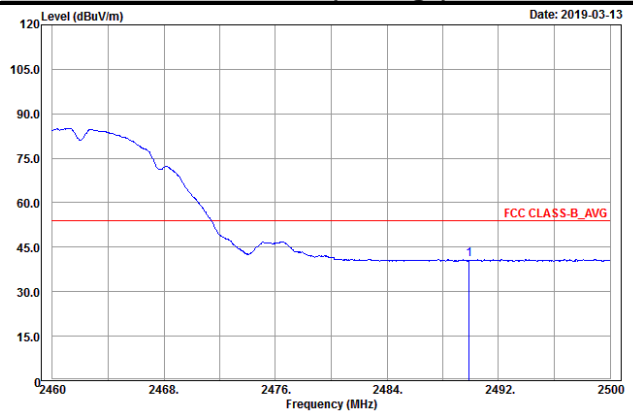

Vertical (Peak)

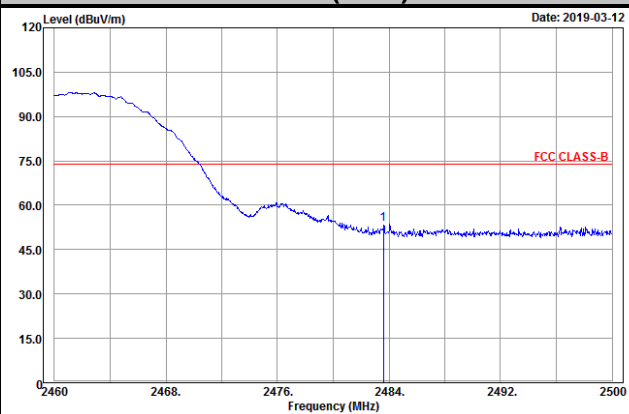

Vertical (Average)

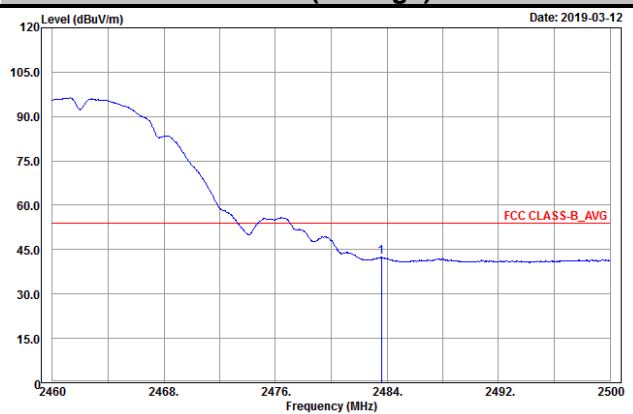

Ch 12

Horizontal (Peak)

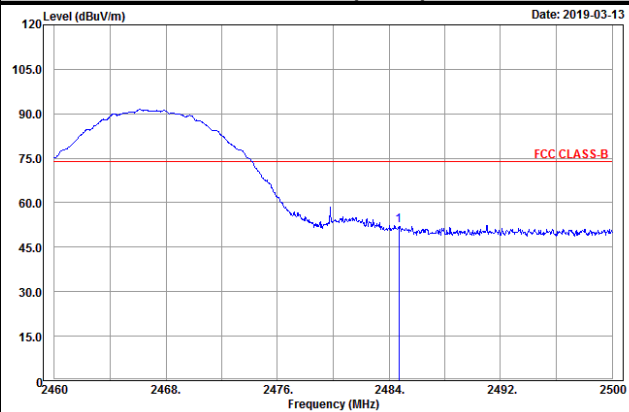

Horizontal (Average)

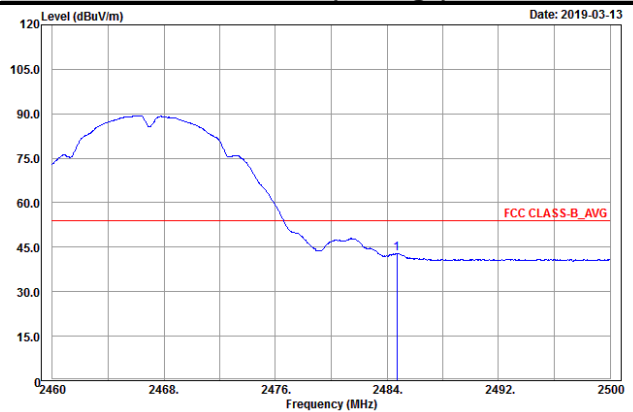

Vertical (Peak)

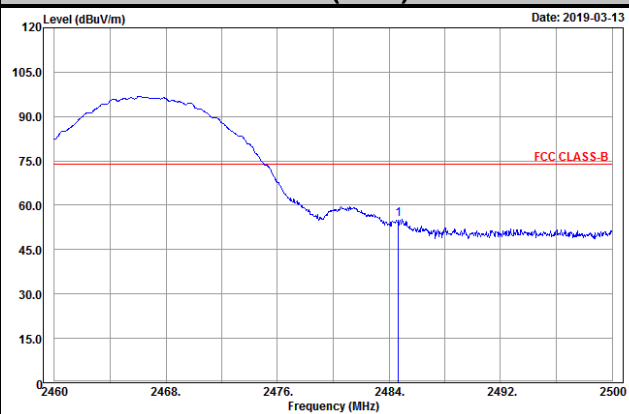

Vertical (Average)

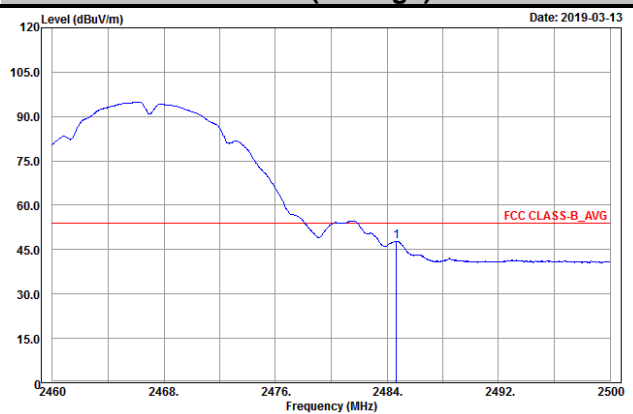

Ch 13

Horizontal (Peak)

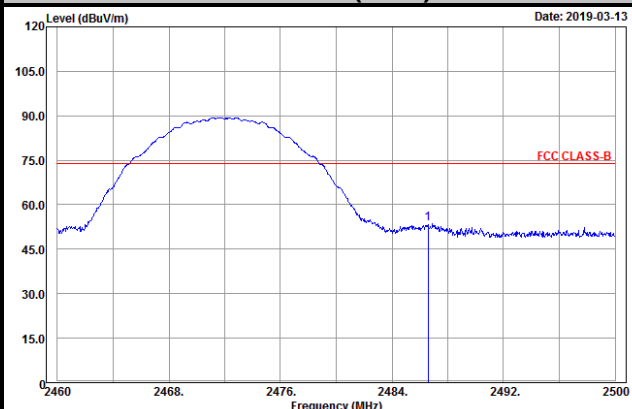

Horizontal (Average)

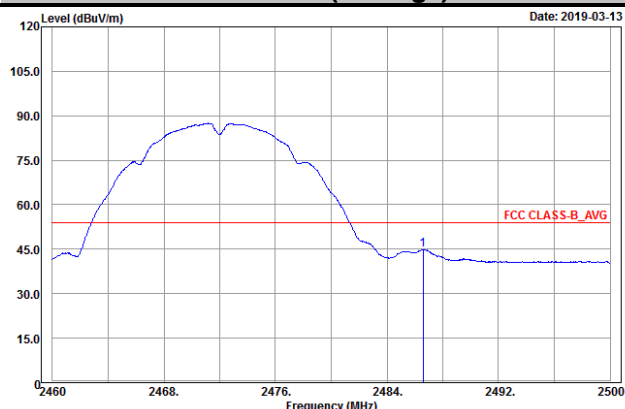

Vertical (Peak)

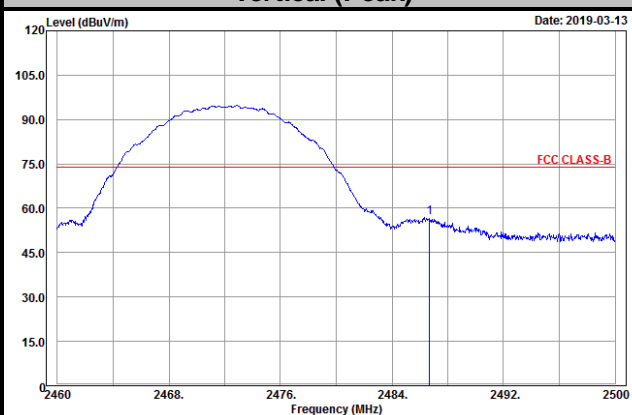

Vertical (Average)

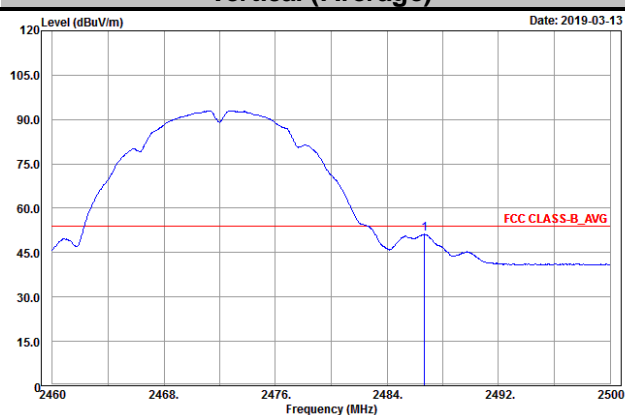

802.11g

Ch 1

Horizontal (Peak)

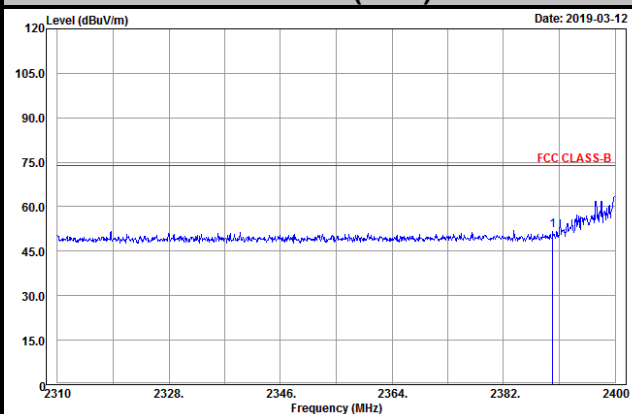

Horizontal (Average)

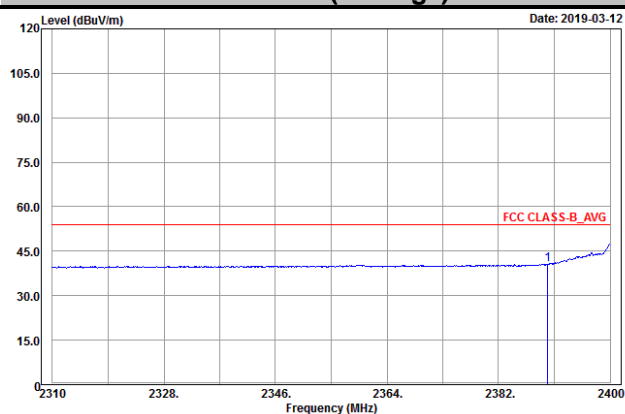

Vertical (Peak)

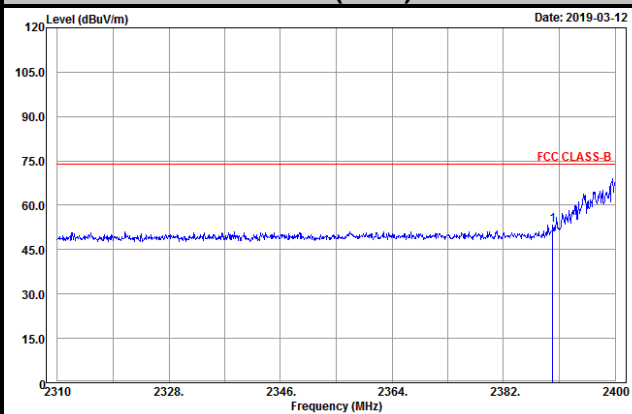

Vertical (Average)

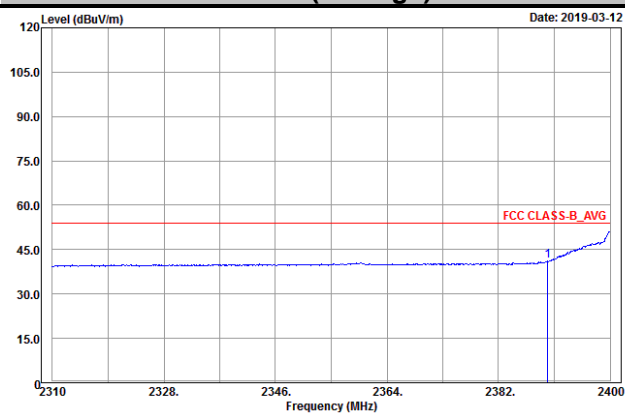

Ch 11

Horizontal (Peak)

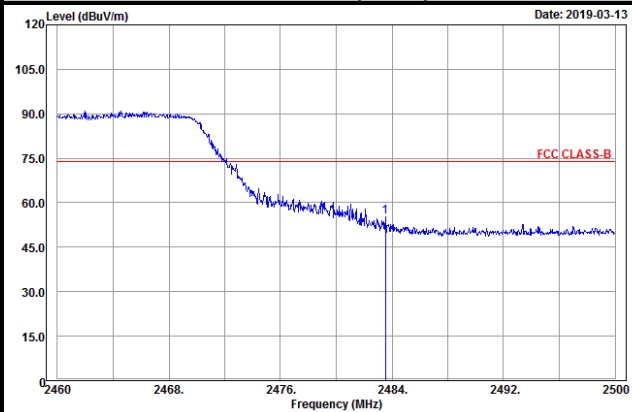

Horizontal (Average)

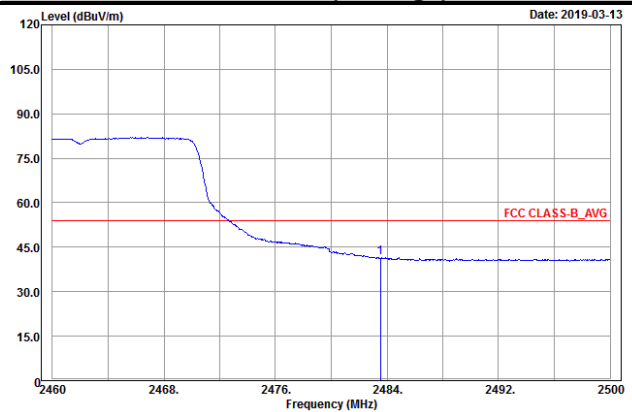

Vertical (Peak)

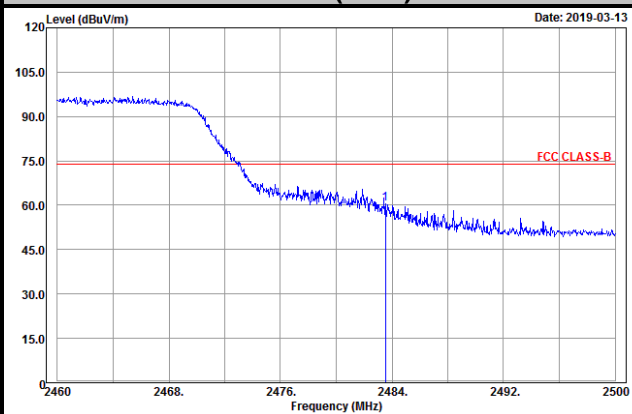

Vertical (Average)

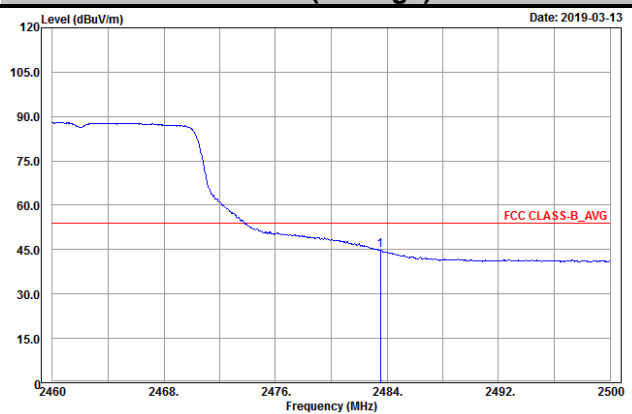

Ch 12

Horizontal (Peak)

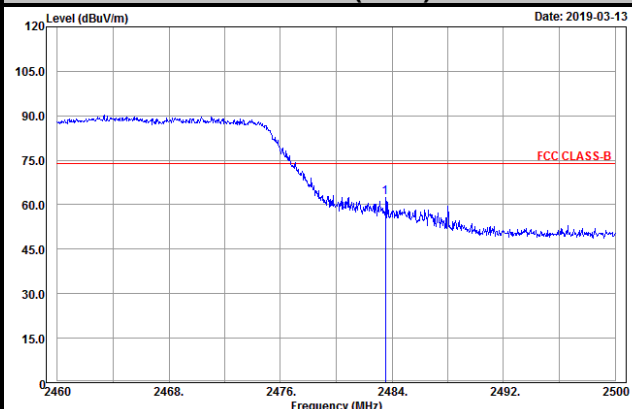

Horizontal (Average)

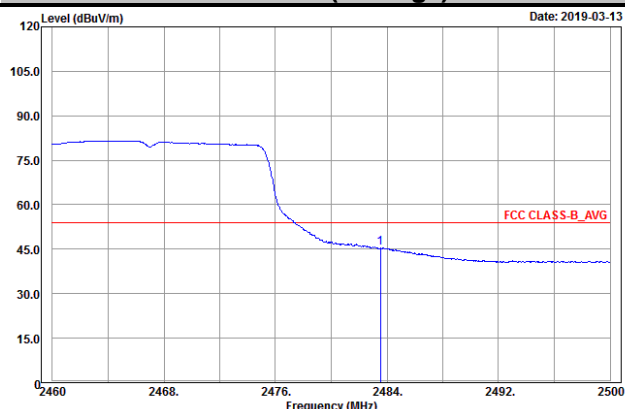

Vertical (Peak)

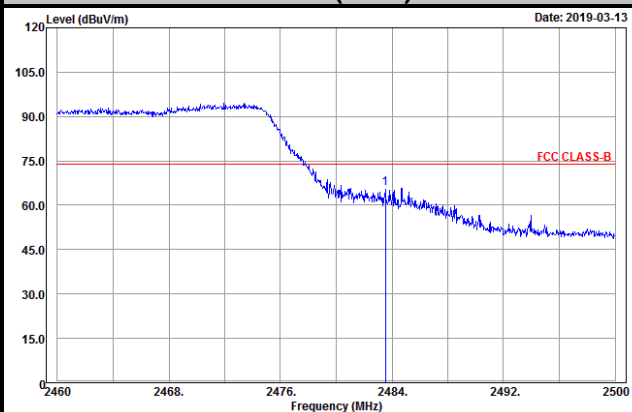

Vertical (Average)

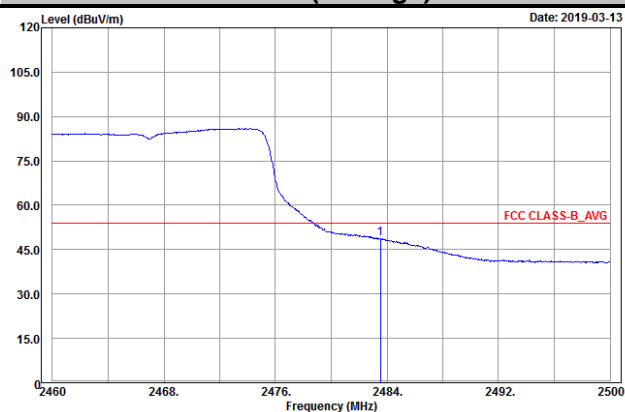

Ch 13

Horizontal (Peak)

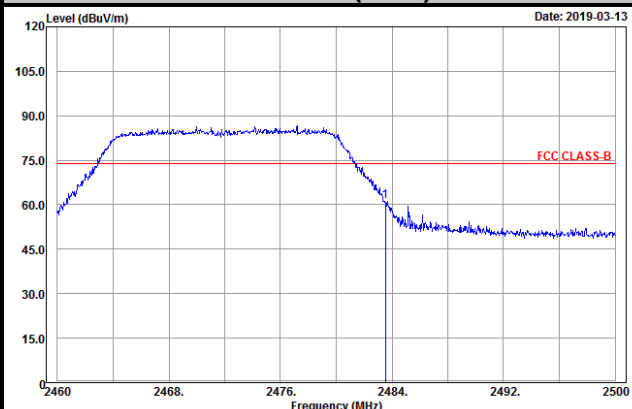

Horizontal (Average)

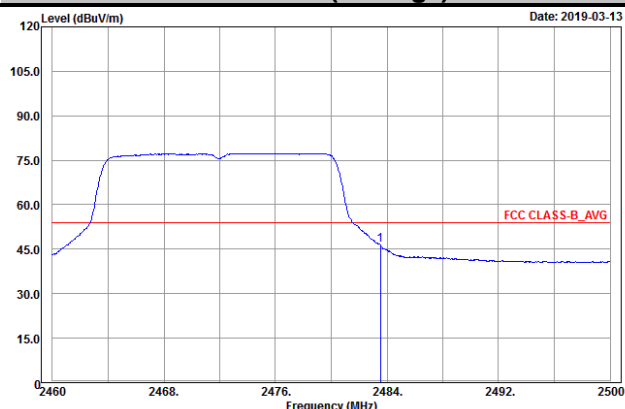

Vertical (Peak)

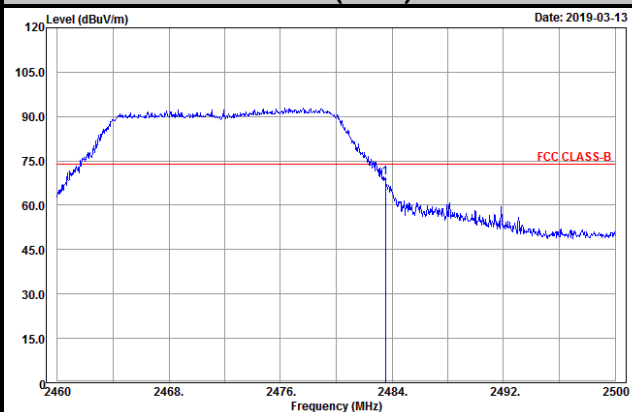

Vertical (Average)

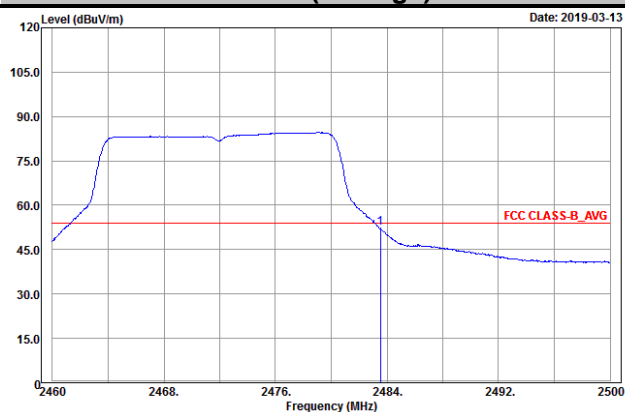

802.11n (HT20)

Ch 1

Horizontal (Peak)

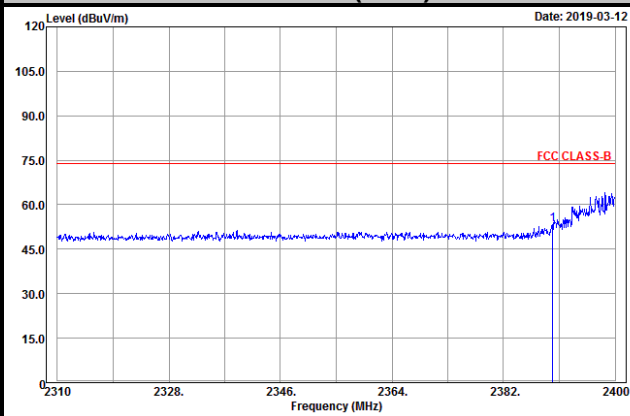

Horizontal (Average)

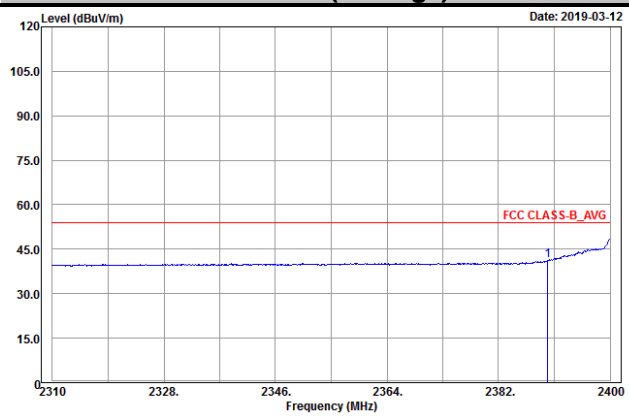

Vertical (Peak)

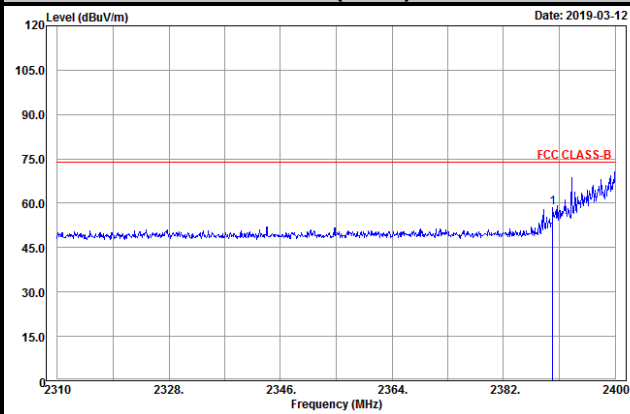

Vertical (Average)

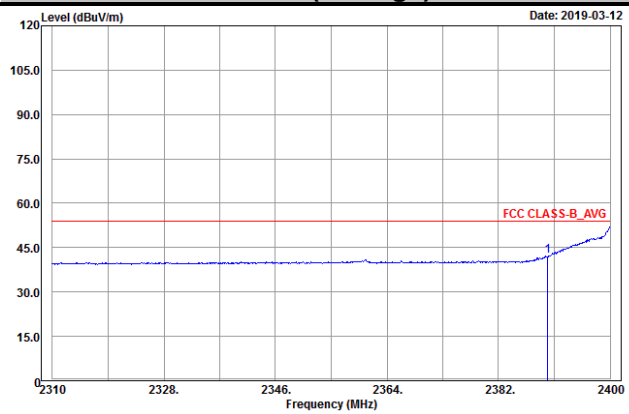

Ch 11

Horizontal (Peak)

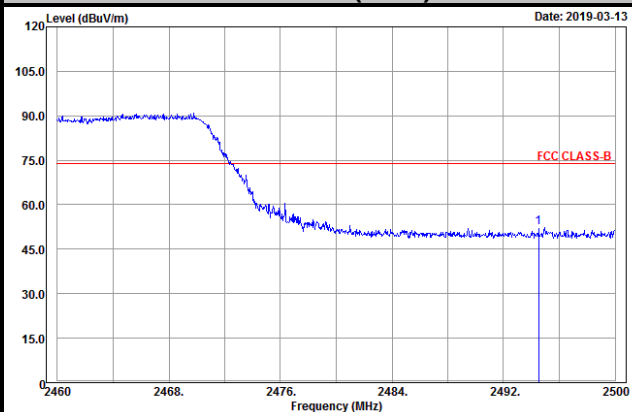

Horizontal (Average)

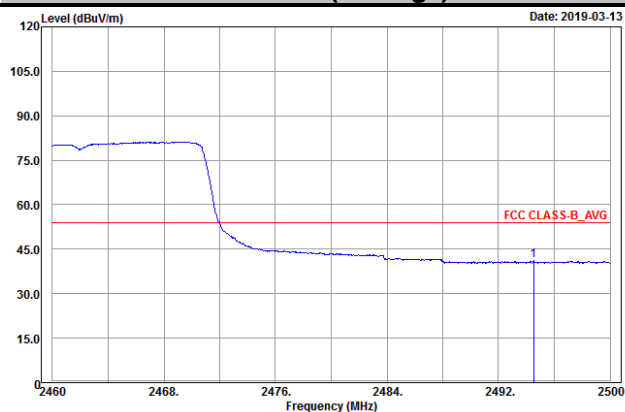

Vertical (Peak)

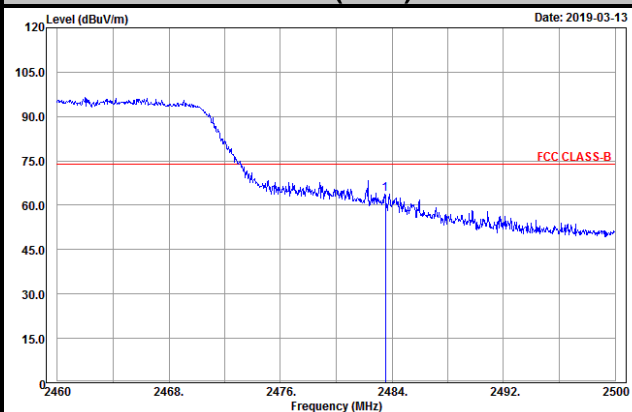

Vertical (Average)

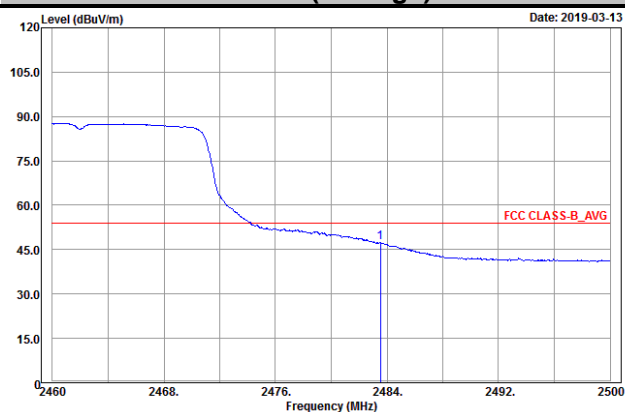

Ch 12

Horizontal (Peak)

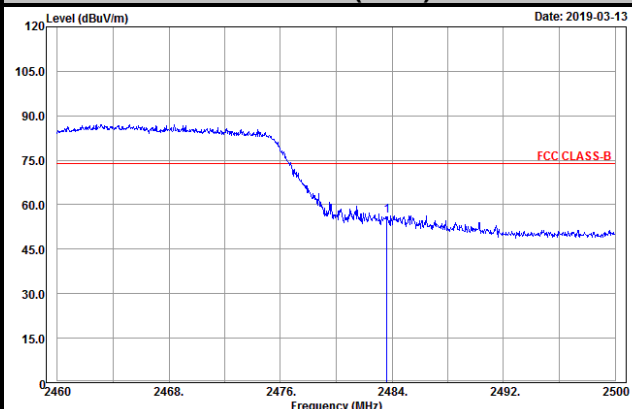

Horizontal (Average)

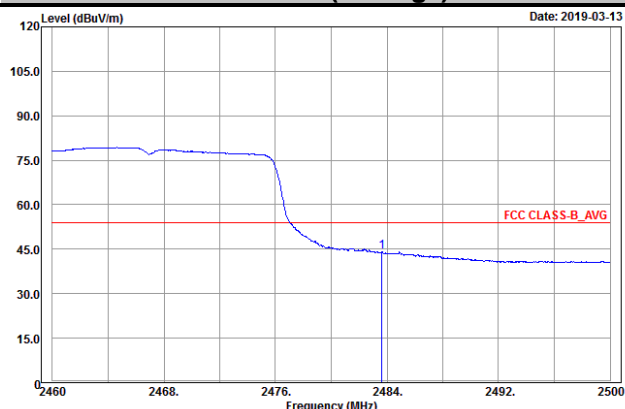

Vertical (Peak)

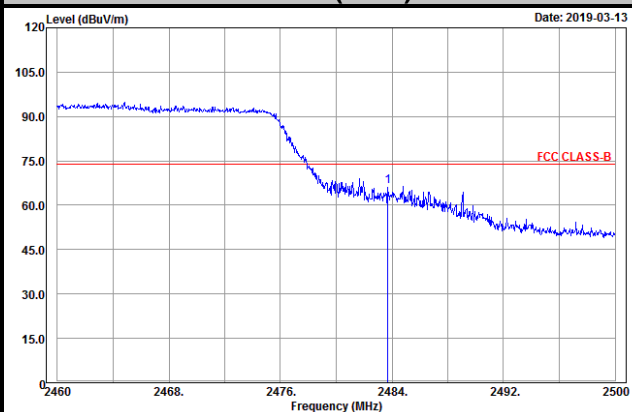

Vertical (Average)

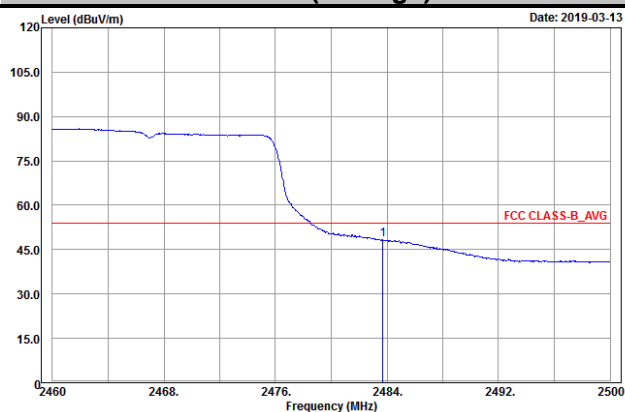

Ch 13

Horizontal (Peak)

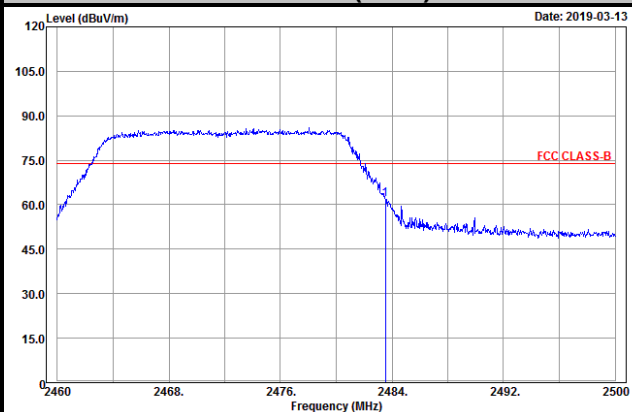

Horizontal (Average)

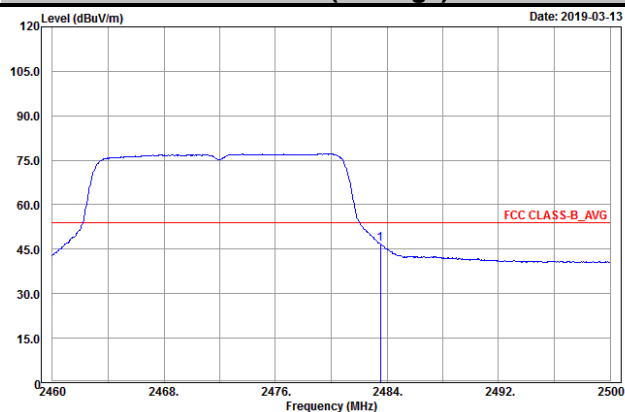

Vertical (Peak)

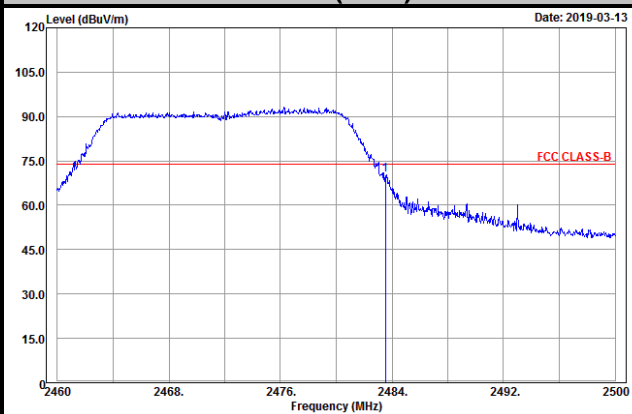

Vertical (Average)

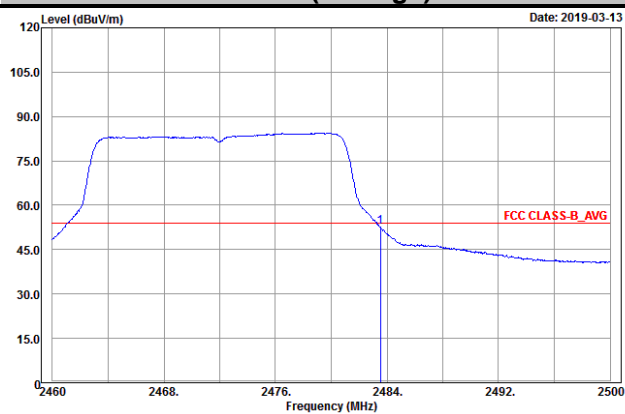

Appendix – Information of the Testing Laboratories

We, Bureau Veritas Consumer Products Services (H.K.) Ltd., Taoyuan Branch, were founded in 1988 to provide our best service in EMC, Radio, Telecom and Safety consultation. Our laboratories are FCC recognized accredited test firms and accredited according to ISO/IEC 17025.

If you have any comments, please feel free to contact us at the following:

Lin Kou EMC/RF Lab

Tel: 886-2-26052180

Fax: 886-2-26051924

Hsin Chu EMC/RF/Telecom Lab

Tel: 886-3-6668565

Fax: 886-3-6668323

Hwa Ya EMC/RF/Safety

Tel: 886-3-3183232

Fax: 886-3-3270892

Email: service.adt@tw.bureauveritas.com

Web Site: www.bureauveritas-adt.com

The address and road map of all our labs can be found in our web site also.

--- END ---