



**FCC CFR47 PART 15 SUBPART C  
INDUSTRY CANADA RSS-210 ISSUE 8  
INDUSTRY CANADA RSS-102 ISSUE 4**

**CERTIFICATION TEST REPORT**

**FOR**

**60GHz WIRELESSHD RECEIVER**

**MODEL NUMBER: SII-SK63101**

**FCC ID: UK2-SII-SK63101  
IC: 6705A-SIISK63101**

**REPORT NUMBER: 12U14407-2, Revision A**

**ISSUE DATE: MAY 21, 2012**

**Prepared for  
SILICON IMAGE  
1140 EAST ARQUES AVE  
SUNNYVALE, CA 94085, U.S.A.**

**Prepared by  
COMPLIANCE CERTIFICATION SERVICES (UL CCS)  
47173 BENICIA STREET  
FREMONT, CA 94538, U.S.A.  
TEL: (510) 771-1000  
FAX: (510) 661-0888**



**NVLAP LAB CODE 200065-0**

Revision History

<u>Rev.</u>	<u>Issue Date</u>	<u>Revisions</u>	<u>Revised By</u>
--	05/07/2012	As Issued	M. Heckrotte
A	05/21/12	Revised EUT description	A. Zaffar

## TABLE OF CONTENTS

<b>1. ATTESTATION OF TEST RESULTS</b>	<b>4</b>
<b>2. TEST METHODOLOGY</b>	<b>5</b>
<b>3. FACILITIES AND ACCREDITATION</b>	<b>5</b>
<b>4. CALIBRATION AND UNCERTAINTY</b>	<b>5</b>
4.1. MEASURING INSTRUMENT CALIBRATION	5
4.2. MEASUREMENT UNCERTAINTY	5
<b>5. EQUIPMENT UNDER TEST</b>	<b>6</b>
5.1. DESCRIPTION OF EUT	6
5.2. OUTPUT POWER	6
5.3. SOFTWARE AND FIRMWARE	6
5.4. WORST-CASE CONFIGURATION AND MODE	6
5.5. DESCRIPTION OF TEST SETUP	7
<b>6. TEST AND MEASUREMENT EQUIPMENT</b>	<b>9</b>
<b>7. APPLICABLE LIMITS AND TEST RESULTS</b>	<b>10</b>
7.1. 6 dB BANDWIDTH	10
7.1.1. Results for LRP Channels	10
7.2. 99% and 26 dB BANDWIDTH	13
7.2.1. Results for LRP Channels	13
7.3. POWER DENSITY	16
7.3.1. Results for LRP Channels	18
7.1. PEAK OUTPUT POWER	24
7.1.1. Results for LRP Channels	25
7.2. SPURIOUS EMISSIONS	26
7.3. AC MAINS LINE CONDUCTED EMISSIONS	33
7.4. FREQUENCY STABILITY	37
7.5. GROUP INSTALLATION	38
7.6. TRANSMITTER IDENTIFICATION	39
<b>8. RF EXPOSURE</b>	<b>40</b>
<b>9. SETUP PHOTOS</b>	<b>43</b>

# 1. ATTESTATION OF TEST RESULTS

**COMPANY NAME:** SILICON IMAGE  
1140 EAST ARQUES AVE  
SUNNYVALE, CA, 94085, U.S.A.

**EUT DESCRIPTION:** 60GHz WIRELESSHD RECEIVER

**MODEL:** SII-SK63101

**SERIAL NUMBER:** a2:ef:a1:8a:53:50

**DATE TESTED:** APRIL 18 TO MAY 1, 2012

APPLICABLE STANDARDS	
STANDARD	TEST RESULTS
CFR 47 Part 15 Subpart C	Pass
INDUSTRY CANADA RSS-210 Issue 8 Annex 13	Pass
INDUSTRY CANADA RSS-102 Issue 4	Pass

Compliance Certification Services (UL CCS) tested the above equipment in accordance with the requirements set forth in the above standards. All indications of Pass/Fail in this report are opinions expressed by UL CCS based on interpretations and/or observations of test results. Measurement Uncertainties were not taken into account and are published for informational purposes only. The test results show that the equipment tested is capable of demonstrating compliance with the requirements as documented in this report.

**Note:** The results documented in this report apply only to the tested sample, under the conditions and modes of operation as described herein. This document may not be altered or revised in any way unless done so by UL CCS and all revisions are duly noted in the revisions section. Any alteration of this document not carried out by UL CCS will constitute fraud and shall nullify the document. This report must not be used by the client to claim product certification, approval, or endorsement by NVLAP, NIST, any agency of the Federal Government, or any agency of any government.

Approved & Released For UL CCS By:

Tested By:

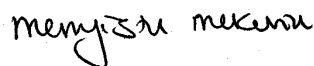

MICHAEL HECKROTTE  
DIRECTOR OF ENGINEERING  
UL CCS

MENGISTU MEKURIA  
EMC ENGINEER  
UL CCS

## 2. TEST METHODOLOGY

The tests documented in this report were performed in accordance with ANSI C63.10-2009, FCC CFR 47 Part 2, FCC CFR 47 Part 15, FCC KDB 200443 Millimeter Wave Test Procedure, FCC Bulletin OET 65, IEEE C95.3-2002, RSS-210 Issue 8, RSS-GEN Issue 3 and RSS-102 Issue 4.

## 3. FACILITIES AND ACCREDITATION

The test sites and measurement facilities used to collect data are located at 47173 Benicia Street, Fremont, California, USA.

UL CCS is accredited by NVLAP, Laboratory Code 200065-0. The full scope of accreditation can be viewed at <http://www.ccsemc.com>.

## 4. CALIBRATION AND UNCERTAINTY

### 4.1. MEASURING INSTRUMENT CALIBRATION

The measuring equipment utilized to perform the tests documented in this report has been calibrated in accordance with the manufacturer's recommendations, and is traceable to recognized national standards.

### 4.2. MEASUREMENT UNCERTAINTY

Where relevant, the following measurement uncertainty levels have been estimated for tests performed on the apparatus:

PARAMETER	UNCERTAINTY
Conducted Disturbance, 0.15 to 30 MHz	3.52 dB
Radiated Disturbance, 30 to 1000 MHz	4.94 dB

Uncertainty figures are valid to a confidence level of 95%.

## **5. EQUIPMENT UNDER TEST**

### **5.1. DESCRIPTION OF EUT**

The EUT is a WirelessHD Sink radio module. It is designed to operate as part of a Wireless Video Audio Network (WVAN) in the 57 to 64 GHz band. The EUT receives High Definition Audio/Video from a WirelessHD Source radio device.

The EUT receives High Definition Audio/Video data on a single Medium Rate (MRP) or High Rate (HRP) channel at either 60.48 GHz or 62.64 GHz. The integral MRP/HRP receive antenna is an adaptive beam-steering array with a maximum gain of 18 dBi.

The EUT transmits and receives control and management signals on one of five Low Rate (LRP) channels for each MRP/HRP channel. LRP channels range from 60.16275 to 60.79725 GHz (for MRP/HRP at 60.48 GHz) or from 62.32275 to 62.95725 GHz (for MRP/HRP at 62.64 GHz). The integral LRP transmit/receive antenna is a scanning beam-steering array with a maximum gain of 16 dBi.

The LRP modulation is BPSK.

### **5.2. OUTPUT POWER**

The antenna is integral thus radiated measurements are made. The EIRP was measured at the worst-case condition, thus the EIRP measurement conditions correspond to the maximum EUT antenna gain. Therefore the maximum antenna gain is used to calculate the Peak Output Power.

The highest peak output power for LRP is 19.2 dBm (83 mW).

### **5.3. SOFTWARE AND FIRMWARE**

The test software used during testing was SWAM3

The test firmware used during testing was 3.0 FS2 Alpha

### **5.4. WORST-CASE CONFIGURATION AND MODE**

The 1080p video mode was determined to be the worst case mode for emissions.

## 5.5. DESCRIPTION OF TEST SETUP

### SUPPORT EQUIPMENT

PERIPHERAL SUPPORT EQUIPMENT LIST			
Description	Manufacturer	Model	Serial Number
Test Jig	Silicon Image	N/A	N/A
Power Supply	Agilent	E3632A	MY40012979
Power Supply	Cincon	TR20B033X	20033-0000889
Video Generator	Quantum Data	882E	9040041
WiHD Source	Silicon Image	Prototype	Prototype
TV	Samsung	P23700HD	EM23HVLZ415106K

### I/O CABLES

I/O CABLE LIST						
Cable No.	Port	# of Identic Ports	Connector Type	Cable Type	Cable Length	Remarks
1	AC	1	AC	Un-Shielded	2.0 m	N/A
2	DC	1	DC	Un-Shielded	2.0m	N/A
3	I/O	1	HDMI	Shielded	9 m	Excess bundled inside shielded box
4	AC	1	AC	Un-Shielded	1.5 m	N/A

### TEST SETUP

The QD generator was placed inside a shielded box. High Definition Audio / Video was sent from the QD generator to the EUT via a conducted HDMI cable connection to the test jig, then sent from the EUT to the Television via an over-the-air link to the WiHD Sink.

The Television and WiHD Sink were placed behind the measuring antenna.

A laptop computer was utilized to adjust the EUT for testing purposes. This computer was not connected during measurements.

**SETUP DIAGRAM FOR TESTS**

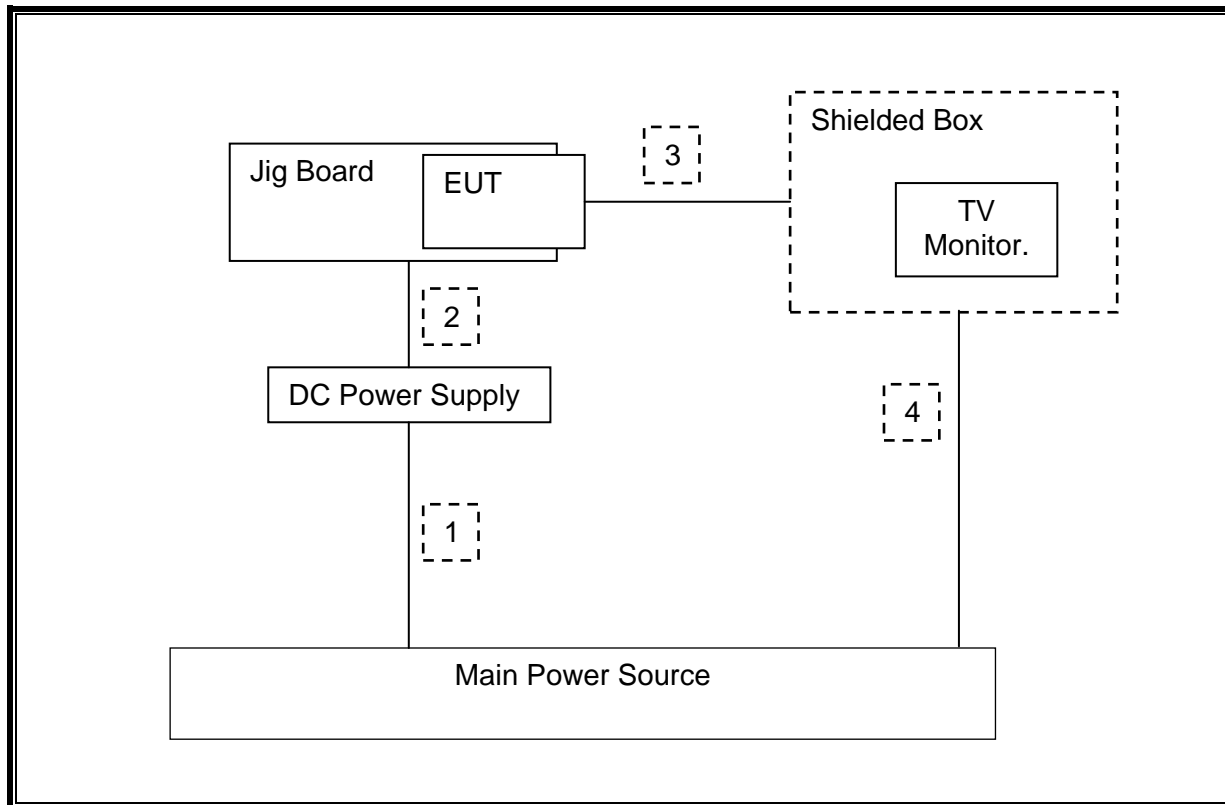



## 6. TEST AND MEASUREMENT EQUIPMENT

The following test and measurement equipment was utilized for the tests documented in this report:

TEST EQUIPMENT LIST				
Description	Manufacturer	Model	Asset	Cal Due
Spectrum Analyzer, 44 GHz	Agilent / HP	E4446A	C01012	9/2/2012
Spectrum Analyzer, 44 GHz	Agilent / HP	E4446A	C00996	5/4/2012
Spectrum Analyzer, 44 GHz	Agilent / HP	E4446A	C00986	3/22/2013
Spectrum Analyzer, 26.5 GHz	Agilent / HP	E4440A	C01176	8/4/2012
Antenna, Bilog, 30MHz-1 GHz	Sunol Sciences	JB1	C01171	1/26/2013
Preamplifier, 1300 MHz	Agilent / HP	8447D	C00558	11/11/2012
Antenna, Horn, 18 GHz	EMCO	3115	C00945	10/6/2012
Antenna, Horn, 18 GHz	EMCO	3115	C00783	6/29/2012
Preamplifier, 26.5 GHz	Agilent / HP	8449B	C01063	7/12/2012
Preamplifier, 26.5 GHz	Agilent / HP	8449B	C01052	7/12/2012
Antenna, Horn, 26.5 GHz	ARA	MWH-1826/B	C00589	7/28/2012
Antenna, Horn, 40 GHz	ARA	MWH-2640/B	C00981	6/14/2012
Preamplifier, 40 GHz	Miteq	NSP4000-SP2	C00990	8/2/2012
Downconverter, 67 GHz	Agilent	MT-463	12020	10/10/2012
Analog Signal Generator, 40 GHz	Agilent / HP	E8257D	C01177	8/18/2012
Harmonic Mixer, 50 GHz	Agilent / HP	11970Q	C00769	5/11/2013
Harmonic Mixer, 75 GHz	Agilent / HP	11970V	C00768	1/31/2014
Harmonic Mixer, 110 GHz	Agilent / HP	11970W	C00770	2/9/2014
Harmonic Mixer, 140 GHz	OML	M08HWA	C00868	CNR
Harmonic Mixer, 220 GHz	OML	M05HWA	C00867	CNR
Mixer Diplexer for HP	OML	DPL.313B	N02429	CNR
Temperature / Humidity Chamber	Thermotron	SE 600-10-10	C00930	10/20/2012
LISN, 30 MHz	FCC	50/250-25-2	C00626	12/13/2012
LISN, 30 MHz	FCC	LISN-50/250-25-2	N02625	12/13/2013

## 7. APPLICABLE LIMITS AND TEST RESULTS

### 7.1. 6 dB BANDWIDTH

#### APPLICABLE RULE

§15.255 (e) (1) For the purposes of this paragraph (e)(1), emission bandwidth is defined as the instantaneous frequency range occupied by a steady state radiated signal with modulation, outside which the radiated power spectral density never exceeds 6 dB below the maximum radiated power spectral density in the band, as measured with a 100 kHz resolution bandwidth spectrum analyzer. The center frequency must be stationary during the measurement interval, even if not stationary during normal operation (e.g. for frequency hopping devices).

#### LIMIT

None; for reporting purposes only.

#### TEST PROCEDURE

The spectrum analyzer and external mixer are set up to measure the radiated output of the transmitter.

#### 7.1.1. Results for LRP Channels

Channel	Frequency (GHz)	6 dB Bandwidth (MHz)
LOW	60.163	90.80
MID	60.797	93.20
HIGH	62.957	93.40

**6 dB BANDWIDTH**

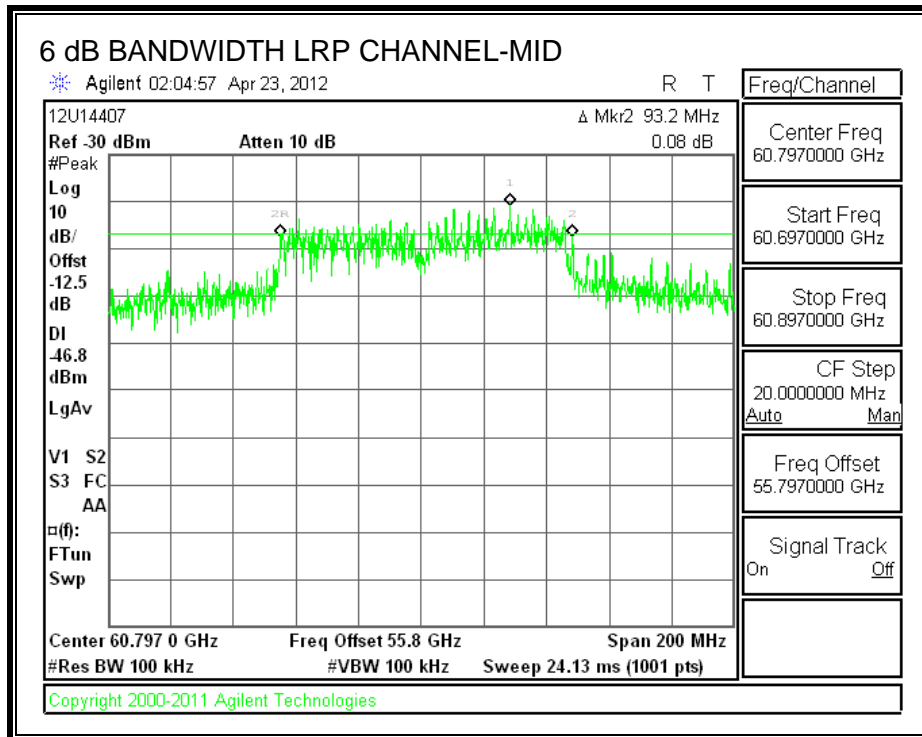
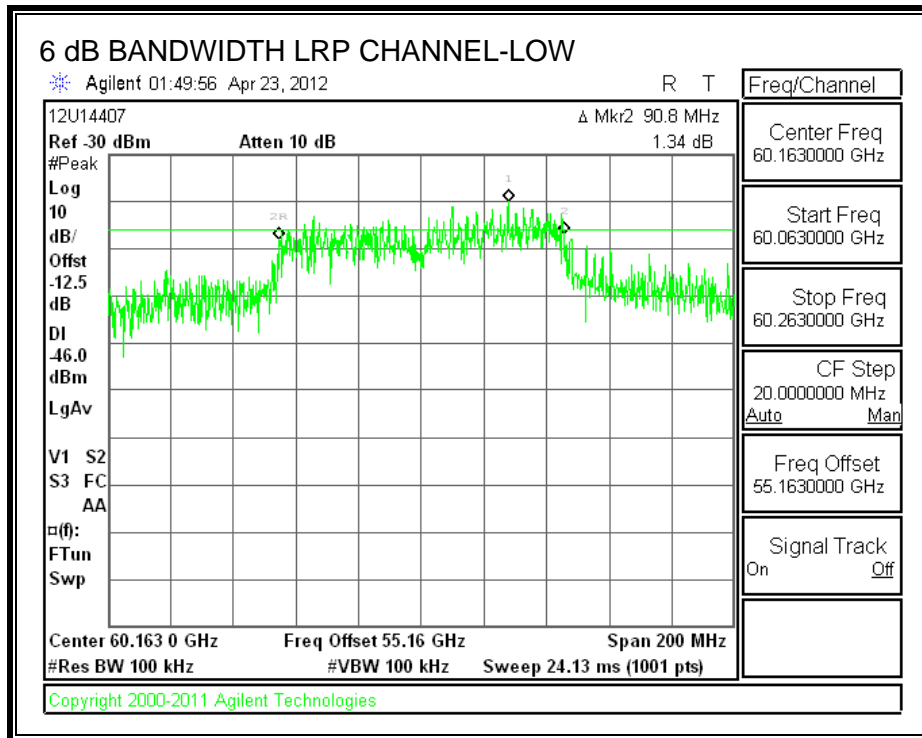

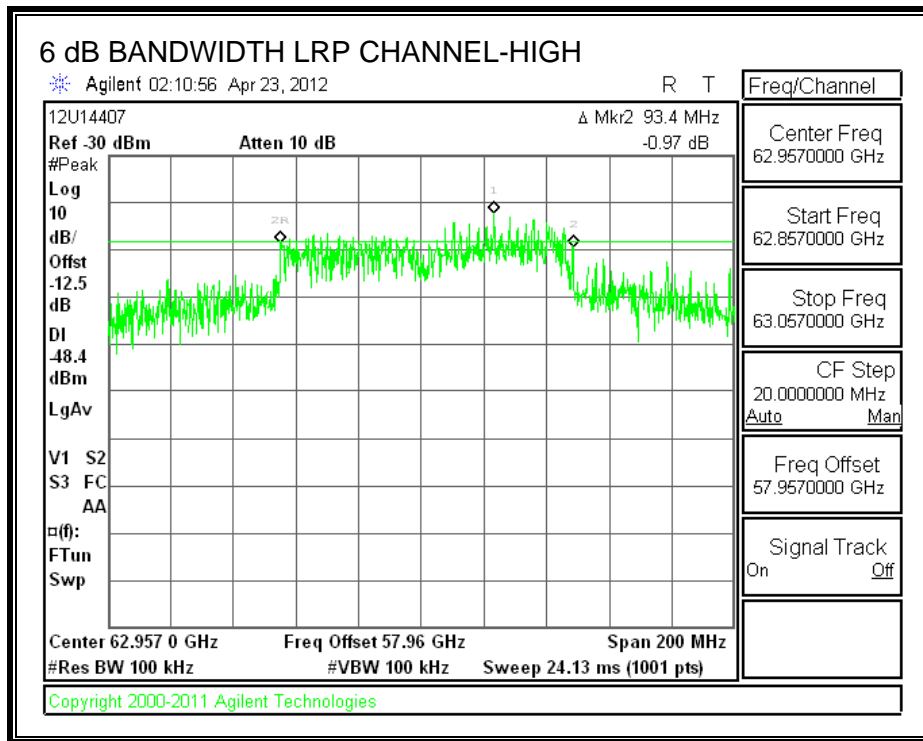

## 7.2. 99% and 26 dB BANDWIDTH

### APPLICABLE RULE

§ 15.403 (c) as referenced by FCC KDB Publication 200443, Millimeter Wave Test Procedures

### LIMIT

None; for reporting purposes only.

### TEST PROCEDURE

The spectrum analyzer and external mixer are set up to measure the radiated output of the transmitter.

#### 7.2.1. Results for LRP Channels

### LRP RESULTS

Channel	Frequency (GHz)	99% Bandwidth (MHz)	26 dB Bandwidth (MHz)
LOW	60.1630	317.9358	493.56
MID	60.7970	362.0891	506.40
HGIH	62.9570	385.3588	517.25

**99% and 26 dB BANDWIDTH**

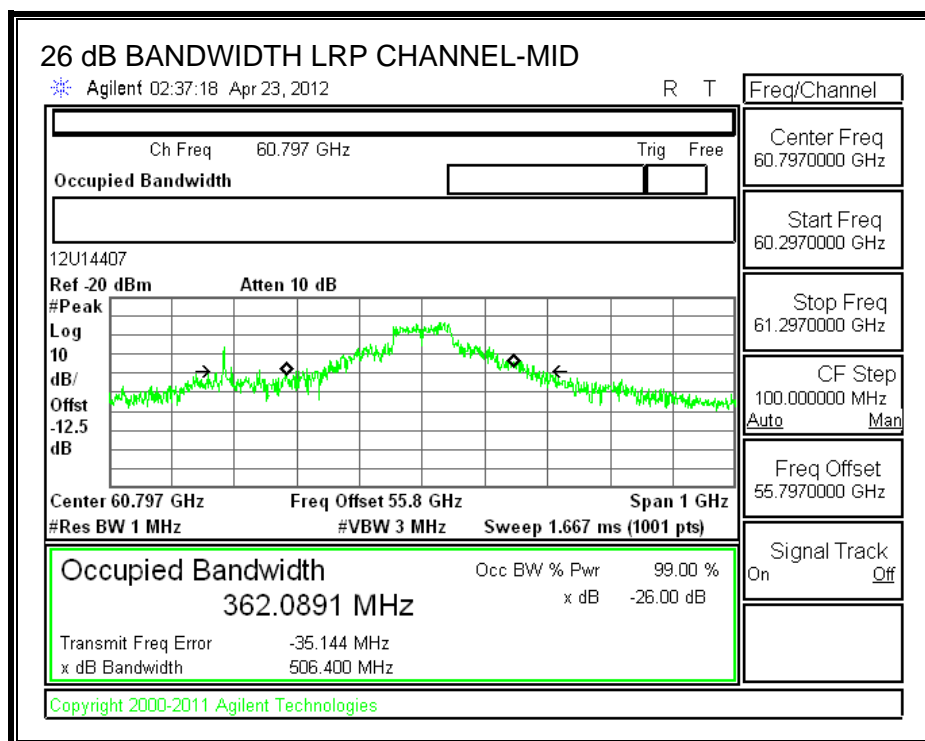
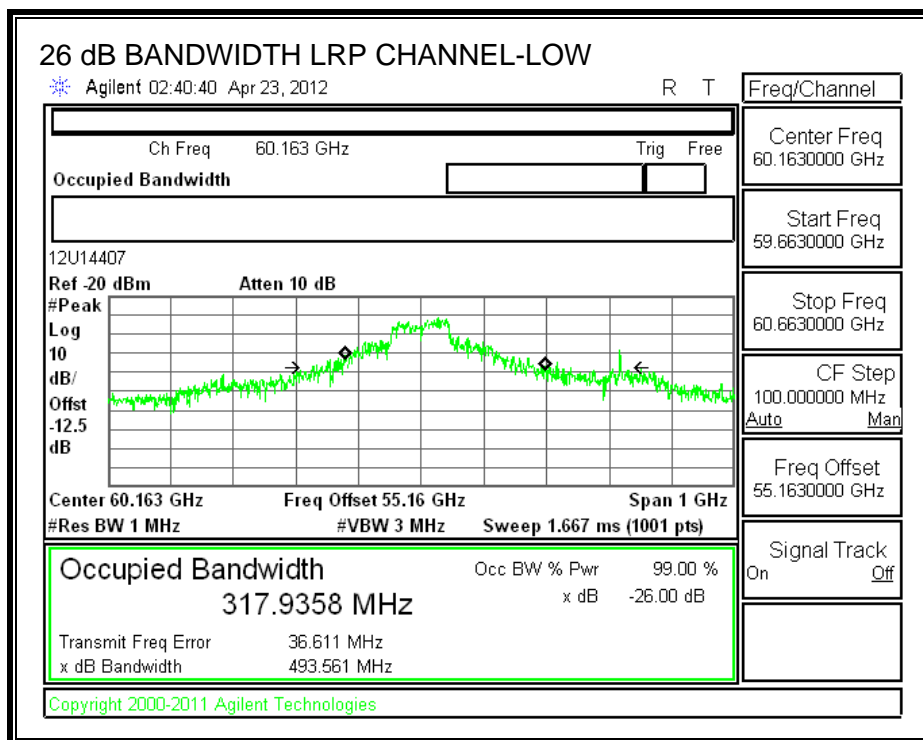

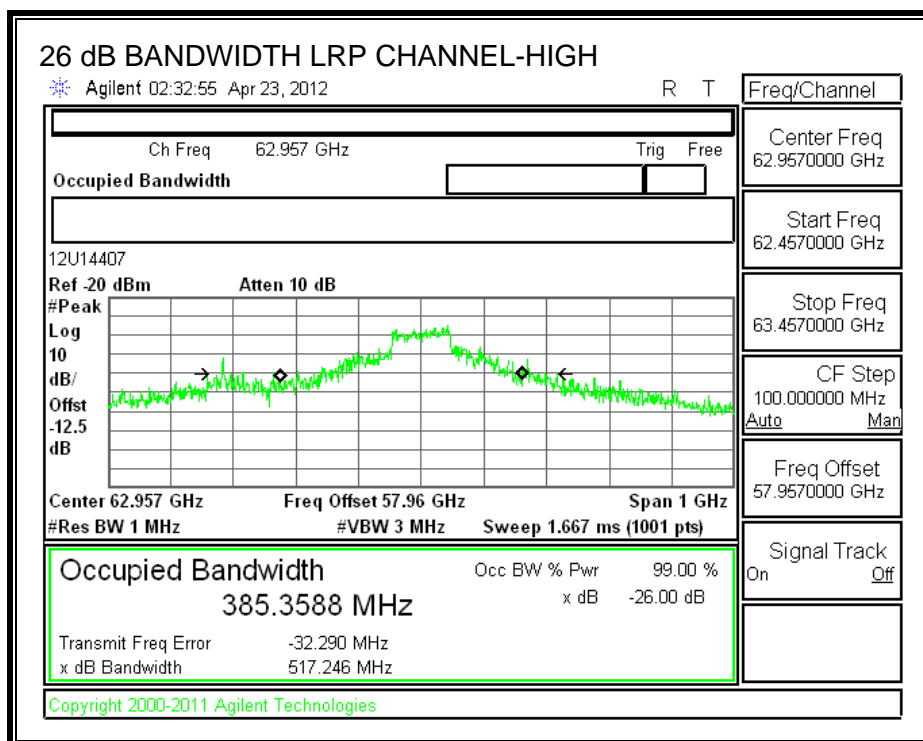

### 7.3. POWER DENSITY

#### LIMIT

§15.255 (b) Within the 57-64 GHz band, emission levels shall not exceed the following:

(1) For products other than fixed field disturbance sensors, the average power density of any emission, measured during the transmit interval, shall not exceed 9 uW/cm<sup>2</sup>, as measured 3 meters from the radiating structure, and the peak power density of any emission shall not exceed 18 uW/cm<sup>2</sup>, as measured 3 meters from the radiating structure.

(4) Peak power density shall be measured with an RF detector that has a detection bandwidth that encompasses the 57-64 GHz band and has a video bandwidth of at least 10 MHz, or using an equivalent measurement method.

(5) The average emission limits shall be calculated, based on the measured peak levels, over the actual time period during which transmission occurs.

Per FCC KDB Publication 200443, Millimeter Wave Test Procedures, If the emission under investigation is not pulsed, then the average levels may be measured by using a video filtering technique (i.e., VBW << RBW).

#### TEST PROCEDURE

Measurements are made at a distance greater than or equal to the far field boundary distance.

The peak power is measured by integrating the spectral envelope over the 26 dB EBW.

The measured power level is converted to EIRP using the Friis equation:

$$EIRP = P_T * G_T = (P_R / G_R) * (4 * \pi * D / \lambda)^2$$

where:

$G_R$  is the gain of the receive measurement antenna

$D$  is the measurement distance

$\lambda$  is the wavelength

The EIRP is converted to Power Density using the equation:

$$P_D = EIRP / (4 * \pi * D_S^2)$$

where:

$D_S$  is the specification distance



**FAR FIELD BOUNDARY CALCULATIONS**

The far-field boundary is given in FCC KDB Publication 200443 as:

$$R_{\text{far field}} = (2 * L^2) / \lambda$$

where:

L = Largest Antenna Dimension, including the reflector, in meters

$\lambda$  = wavelength in meters

Frequency (GHz)	L (m)	Lambda (m)	R (Far Field) (m)
60.48	0.015	0.0050	0.09
62.64	0.015	0.0048	0.09

### 7.3.1. Results for LRP Channels

#### LRP PEAK POWER DENSITY RESULTS

##### CHANNEL-LOW

Frequency (GHz)	Measurement Distance (m)	Measured Power (dBm)	Rx Antenna Gain (dBi)	EIRP (dBm)
60.163	1.50	-13.36	23.00	35.2
EIRP (W)	Specification Distance (m)	Power Density (W/m <sup>2</sup> )	Power Density (uW/cm <sup>2</sup> )	Peak Limit (uW/cm <sup>2</sup> )
3.301	3.0	0.0292	2.92	18

##### CHANNEL-MID

Frequency (GHz)	Measurement Distance (m)	Measured Power (dBm)	Rx Antenna Gain (dBi)	EIRP (dBm)
60.797	1.50	-14.99	23.00	33.6
EIRP (W)	Specification Distance (m)	Power Density 23	3 Density (uW/cm <sup>2</sup> )	Peak Limit (uW/cm <sup>2</sup> )
2.316	3.0	0.0205	2.05	18

##### CHANNEL-HIGH

Frequency (GHz)	Measurement Distance (m)	Measured Power (dBm)	Rx Antenna Gain (dBi)	EIRP (dBm)
62.957	1.50	-16.86	23.00	32.1
EIRP (W)	Specification Distance (m)	Power Density (W/m <sup>2</sup> )	Power Density (uW/cm <sup>2</sup> )	Peak Limit (uW/cm <sup>2</sup> )
1.614	3.0	0.0143	1.43	18

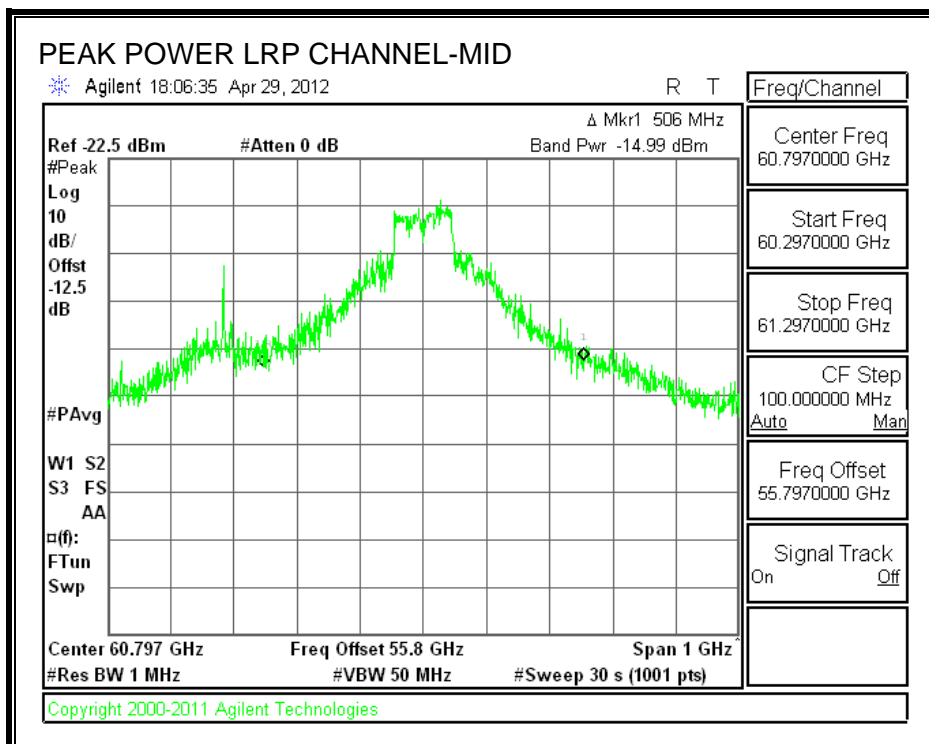
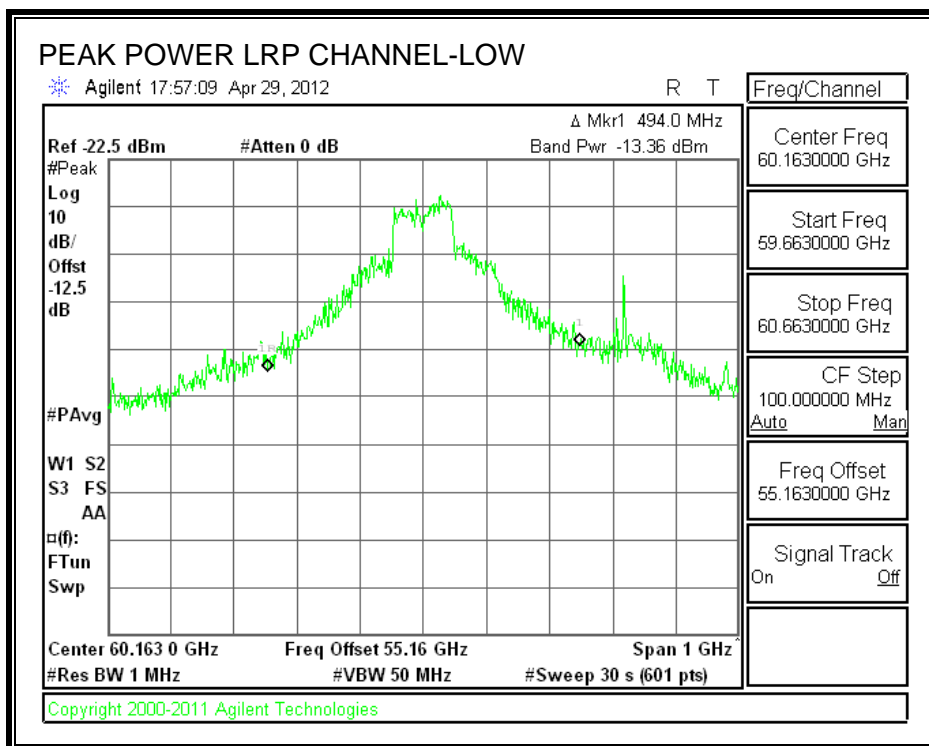

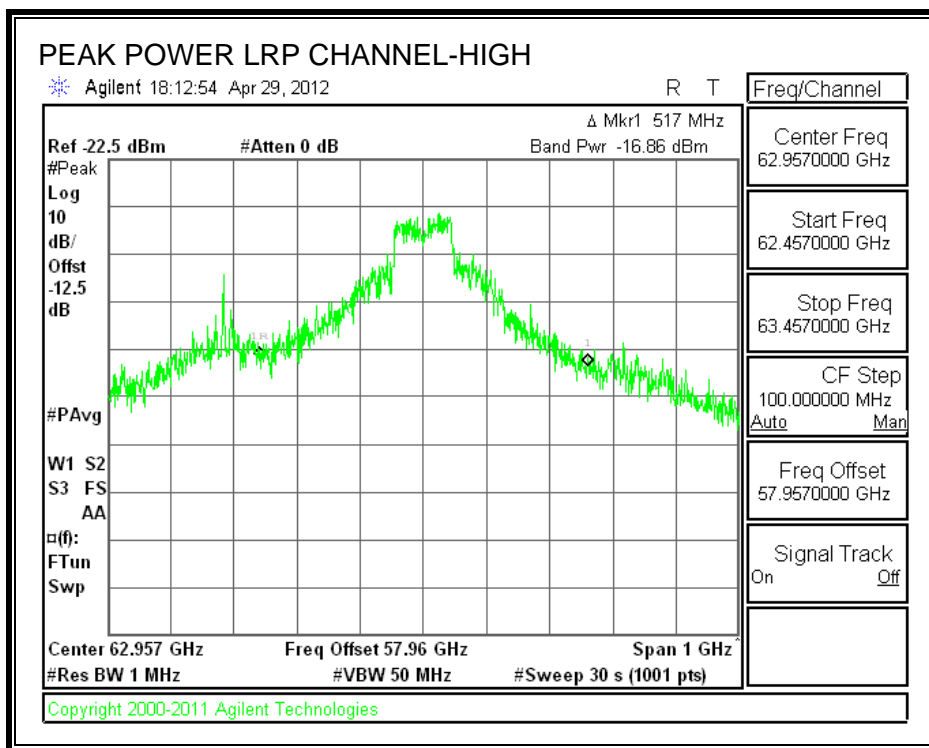

**LRP AVERAGE POWER DENSITY RESULTS**

**CHANNEL-LOW**

<b>Frequency (GHz)</b>	<b>Measurement Distance (m)</b>	<b>Measured Power (dBm)</b>	<b>Rx Antenna Gain (dBi)</b>	<b>EIRP (dBm)</b>
60.163	1.50	-36.95	23.00	11.6
<b>EIRP (W)</b>	<b>Specification Distance (m)</b>	<b>Power Density (W/m<sup>2</sup>)</b>	<b>Power Density (uW/cm<sup>2</sup>)</b>	<b>Average Limit (uW/cm<sup>2</sup>)</b>
0.014	3.0	0.0001	0.013	9

**CHANNEL-MID**

<b>Frequency (GHz)</b>	<b>Measurement Distance (m)</b>	<b>Measured Power (dBm)</b>	<b>Rx Antenna Gain (dBi)</b>	<b>EIRP (dBm)</b>
62.323	1.50	-38.27	23.00	10.6
<b>EIRP (W)</b>	<b>Specification Distance (m)</b>	<b>Power Density 23</b>	<b>3 Density (uW/cm<sup>2</sup>)</b>	<b>Average Limit (uW/cm<sup>2</sup>)</b>
0.011	3.0	0.0001	0.010	9

**CHANNEL-HIGH**

<b>Frequency (GHz)</b>	<b>Measurement Distance (m)</b>	<b>Measured Power (dBm)</b>	<b>Rx Antenna Gain (dBi)</b>	<b>EIRP (dBm)</b>
62.957	1.50	-40.39	23.00	8.6
<b>EIRP (W)</b>	<b>Specification Distance (m)</b>	<b>Power Density (W/m<sup>2</sup>)</b>	<b>Power Density (uW/cm<sup>2</sup>)</b>	<b>Average Limit (uW/cm<sup>2</sup>)</b>
0.007	3.0	0.0001	0.006	9

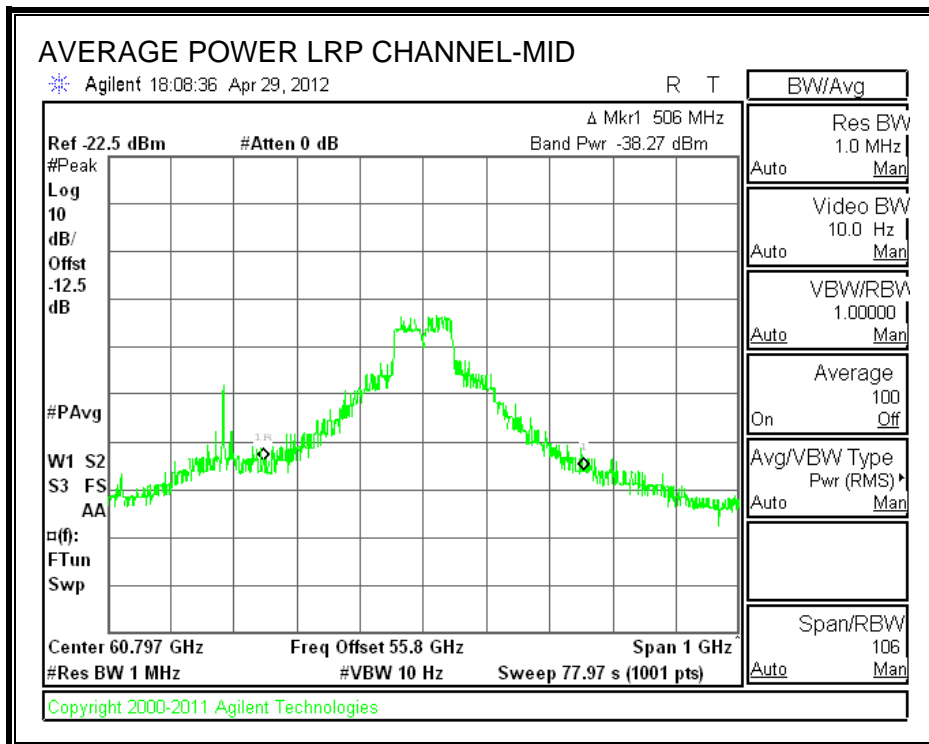
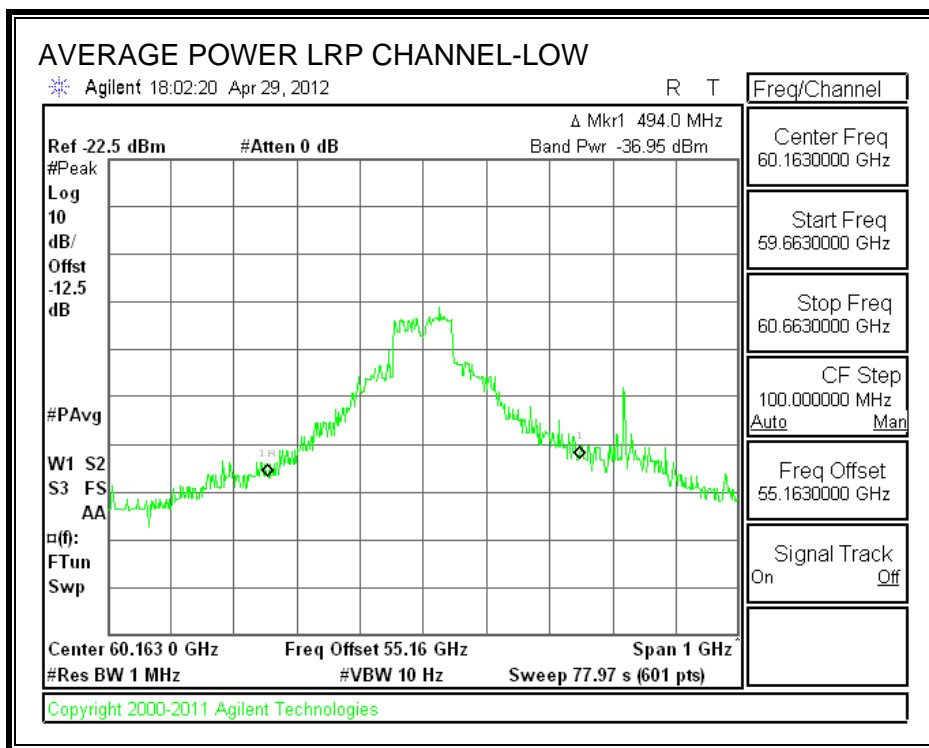

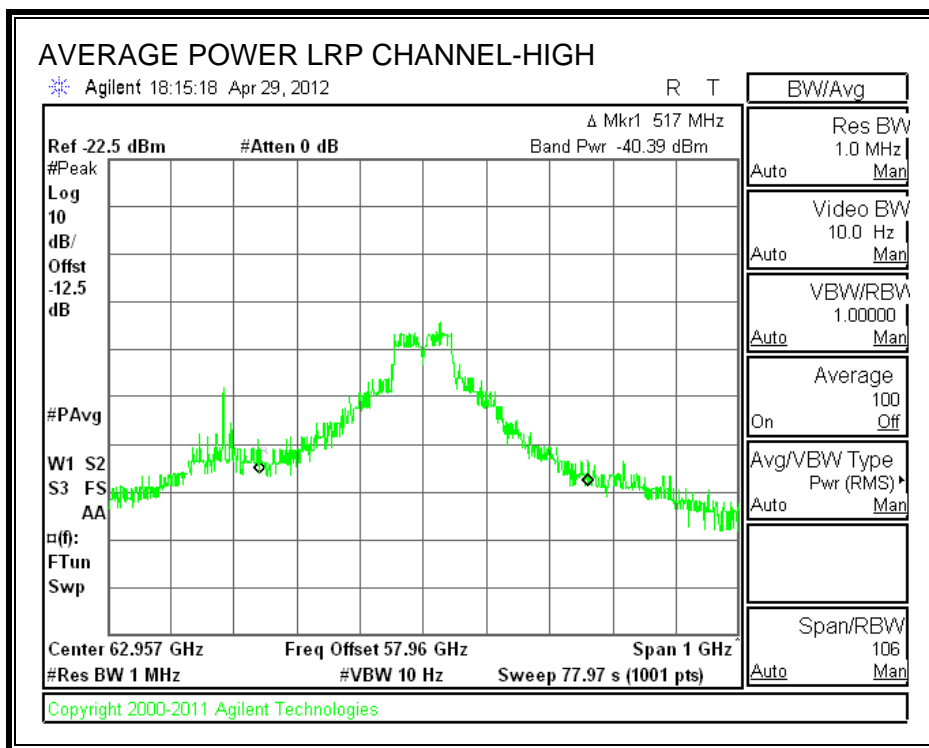

## 7.1. PEAK OUTPUT POWER

### LIMIT

§15.255 (e) Except as specified elsewhere in this paragraph (e), the total peak transmitter output power shall not exceed 500 mW.

§15.255 (e) (1) Transmitters with an emission bandwidth of less than 100 MHz must limit their peak transmitter output power to the product of 500 mW times their emission bandwidth divided by 100 MHz. For the purposes of this paragraph (e)(1), emission bandwidth is defined as the instantaneous frequency range occupied by a steady state radiated signal with modulation, outside which the radiated power spectral density never exceeds 6 dB below the maximum radiated power spectral density in the band, as measured with a 100 kHz resolution bandwidth spectrum analyzer. The center frequency must be stationary during the measurement interval, even if not stationary during normal operation (e.g. for frequency hopping devices).

§15.255 (e) (2) Peak transmitter output power shall be measured with an RF detector that has a detection bandwidth that encompasses the 57–64 GHz band and that has a video bandwidth of at least 10 MHz, or using an equivalent measurement method.

§15.255 (e) (2) For purposes of demonstrating compliance with this paragraph (e), corrections to the transmitter output power may be made due to the antenna and circuit loss.

### PROCEDURE

The maximum EUT antenna gain is subtracted from the Peak EIRP.



### 7.1.1. Results for LRP Channels

#### PEAK OUTPUT POWER

##### CHANNEL-LOW

Frequency (GHz)	EIRP (dBm)	EUT Antenna Gain (dBi)	Output Power (dBm)	Output Power (mW)	6 dB Bandwidth (MHz)	Output Power Limit (mW)
60.163	35.2	16.00	19.20	83.2	90.8	454

##### CHANNEL-MID

Frequency (GHz)	EIRP (dBm)	EUT Antenna Gain (dBi)	Output Power (dBm)	Output Power (mW)	6 dB Bandwidth (MHz)	Output Power Limit (mW)
60.797	33.6	16.00	17.60	57.5	93.2	466

##### CHANNEL-HIGH

Frequency (GHz)	EIRP (dBm)	EUT Antenna Gain (dBi)	Output Power (dBm)	Output Power (mW)	6 dB Bandwidth (MHz)	Output Power Limit (mW)
62.957	32.1	16.00	16.10	40.7	93.4	467

## 7.2. SPURIOUS EMISSIONS

### LIMITS

§15.255 (c) (1) The power density of any emissions outside the 57–64 GHz band shall consist solely of spurious emissions.

§15.255 (c) (2) Radiated emissions below 40 GHz shall not exceed the general limits in §15.209.

§15.255 (c) (3) Between 40 GHz and 200 GHz, the level of these emissions shall not exceed 90 pW/cm<sup>2</sup> at a distance of 3 meters.

§15.255 (c) (4) The levels of the spurious emissions shall not exceed the level of the fundamental emission.

§15.255 (d) Only spurious emissions and transmissions related to a publicly accessible coordination channel, whose purpose is to coordinate operation between diverse transmitters with a view towards reducing the probability of interference throughout the 57–64 GHz band, are permitted in the 57–57.05 GHz band.

Note to paragraph (d): The 57–57.05 GHz is reserved exclusively for a publicly-accessible coordination channel. The development of standards for this channel shall be performed pursuant to authorizations issued under part 5 of this chapter.

### PROCEDURE FOR 30 MHz TO 40 GHz

Measurements are made with the antenna feeding a spectrum analyzer via a preamplifier and cables.

### PROCEDURE FOR 40 TO 200 GHz

External harmonic mixers are utilized.

The antenna is scanned around the entire perimeter surface of the EUT, in both horizontal and vertical polarizations, at a maximum distance of 5 cm from the EUT.

A final test is made at any frequencies at which emissions are found. During this final scan, the antenna is kept no further from the EUT than the maximum distance calculated for each mixer band that yields a minimum system noise floor at least 6 dB below the spurious emissions limit.

The power is measured, the EIRP is calculated, then the extrapolated power density at a 3 meter distance is calculated.

**TX AND RX SPURIOUS EMISSION 30 TO 1000 MHz (HORIZONTAL PLOT)**

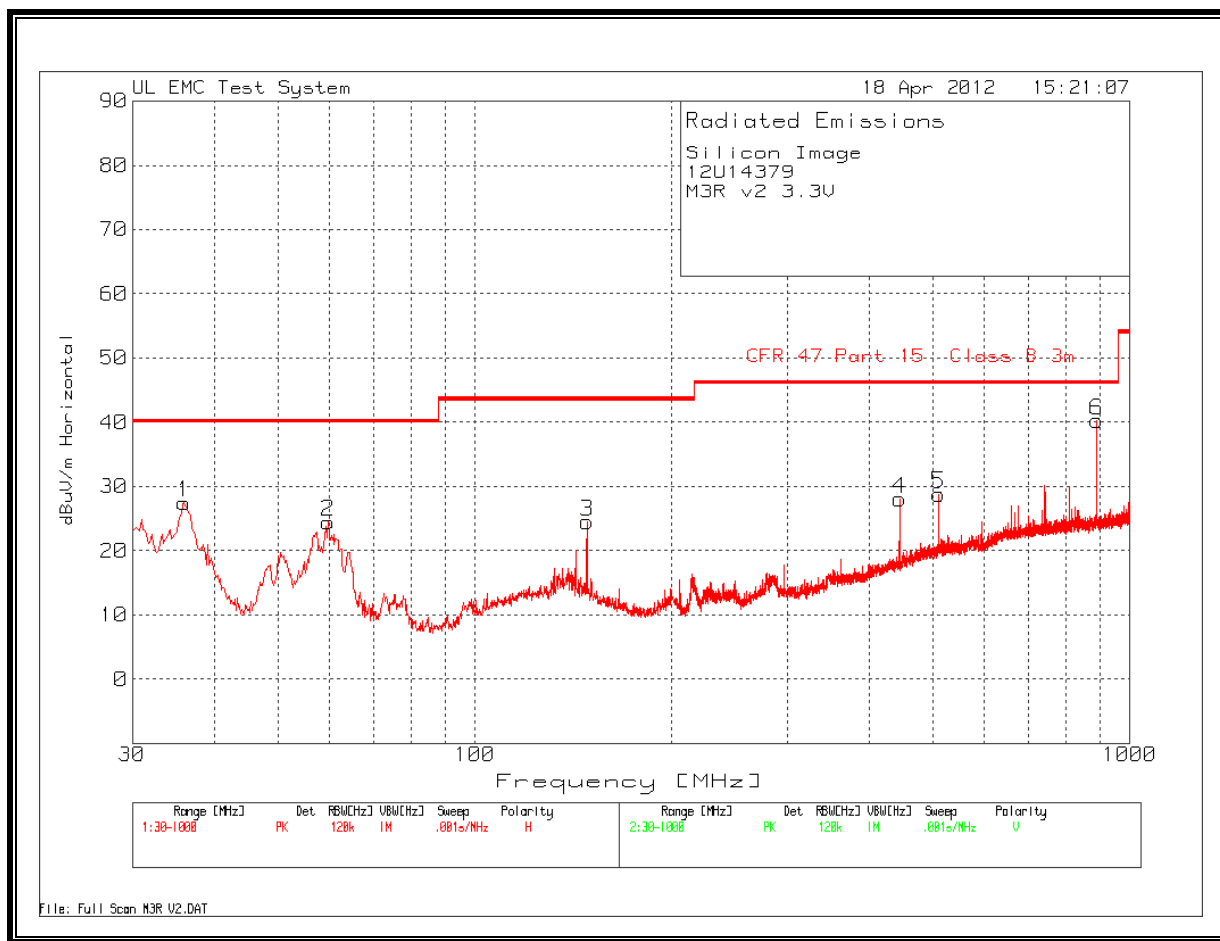

**TX AND RX SPURIOUS EMISSION 30 TO 1000 MHz (VERTICAL PLOT)**

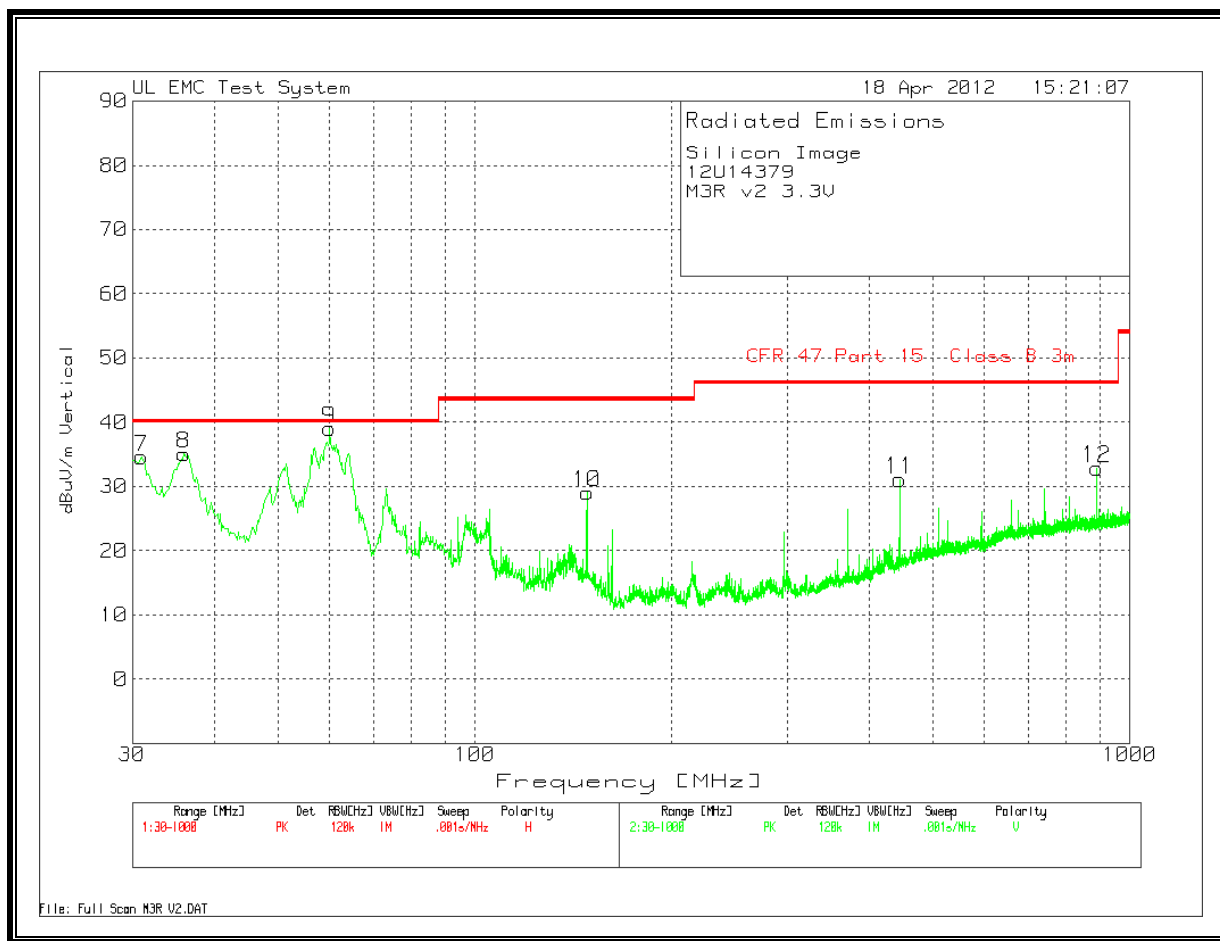

**TX AND RX SPURIOUS EMISSION 30 TO 1000 MHz VERTICAL AND HORIZONTAL DATA**

Silicon Image									
12U14379									
M3R v2 3.3V									
<b>Horizontal 30 - 1000MHz</b>									
Test	Meter	Detector	Amplifier	Antenna	EMI Value	CFR 47	Margin	Antenna	Polarity
Frequency	Reading		Factor	Factor	dBuV/m	Class B 3m		Height	
						Limit		[cm]	
36.0092	38.19	PK	-27.5	16.8	27.49	40	-12.51	201	Horz
59.6583	44.47	PK	-27.2	7.2	24.47	40	-15.53	400	Horz
148.4392	38.72	PK	-26.6	12.4	24.52	43.5	-18.98	201	Horz
445.6035	36.58	PK	-25.2	16.7	28.08	46	-17.92	201	Horz
511.5108	35.62	PK	-24.6	17.8	28.82	46	-17.18	201	Horz
891.0592	41.57	PK	-23.3	22	40.27	46	-5.73	100	Horz
<b>Vertical 30 - 1000MHz</b>									
Test	Meter	Detector	Amplifier	Antenna	EMI Value	CFR 47	Margin	Antenna	Polarity
Frequency	Reading		Factor	Factor	dBuV/m	Class B 3m		Height	
						Limit		[cm]	
30.9692	41.63	PK	-27.5	20.5	34.63	40	-5.37	101	Vert
36.0092	45.81	PK	-27.5	16.8	35.11	40	-4.89	101	Vert
59.996	52.77	QP	-27.2	7.2	32.77	40	-7.23	293	Vert
148.4392	43.25	PK	-26.6	12.4	29.05	43.5	-14.45	101	Vert
445.6035	39.63	PK	-25.2	16.7	31.13	46	-14.87	101	Vert
891.0592	34.19	PK	-23.3	22	32.89	46	-13.11	101	Vert

**TX AND RX SPURIOUS EMISSIONS 1 TO 40 GHz VERTICAL AND HORIZONTAL DATA**

**High Frequency Measurement**  
 Compliance Certification Services, Fremont 5m Chamber-B

Company: Silicon Image  
 Project #: 12U14379  
 Date: 4/5/2012  
 Test Engineer: S.Aguilar  
 Configuration: Default: Model M3R Receiver  
 Mode: Default

**Test Equipment:**

Horn 1-18GHz	Pre-amplifier 1-26GHz	Pre-amplifier 26-40GHz	Horn > 18GHz	Limit
T59; S/N: 3245 @3m	T145 Agilent 3008A0056			FCC 15.209

Hi Frequency Cables

3' cable 22807700	12' cable 22807600	20' cable 22807500	HPF	Reject Filter	Peak Measurements RBW=VBW=1MHz
3' cable 22807700	12' cable 22807600	20' cable 22807500			Average Measurements RBW=1MHz ; VBW=10Hz

f GHz	Dist (m)	Read Pk dBuV	Read Avg. dBuV	AF dB/m	CL dB	Amp dB	D Corr dB	Filtr dB	Peak dBuV/m	Avg dBuV/m	Pk Lim dBuV/m	Avg Lim dBuV/m	Pk Mar dB	Avg Mar dB	Notes (V/H)
1.483	3.0	53.21	48.21	25.8	3.2	-35.7	0.0	0.0	46.5	41.5	74	54	-27.5	-12.5	H
1.483	3.0	53.91	49.21	25.8	3.2	-35.7	0.0	0.0	47.2	42.5	74	54	-26.8	-11.5	V
2.670	3.0	54.53	49.61	29.3	4.5	-35.2	0.0	0.0	53.1	48.2	74	54	-20.9	-5.8	H
2.670	3.0	56.39	51.71	29.3	4.5	-35.2	0.0	0.0	55.0	50.3	74	54	-19.0	-3.7	V
2.818	3.0	44.43	32.56	29.7	4.7	-35.2	0.0	0.0	43.6	31.7	74	54	-30.4	-22.3	H
2.818	3.0	50.18	39.12	29.7	4.7	-35.2	0.0	0.0	49.3	38.3	74	54	-24.7	-15.7	V
2.967	3.0	47.93	41.77	30.1	4.8	-35.2	0.0	0.0	47.6	41.5	74	54	-26.4	-12.5	H
2.967	3.0	50.55	44.54	30.1	4.8	-35.2	0.0	0.0	50.3	44.3	74	54	-23.7	-9.7	V

Rev. 11.10.11

f	Measurement Frequency	Amp	Preamp Gain	Avg Lim	Average Field Strength Limit
Dist	Distance to Antenna	D Corr	Distance Correct to 3 meters	Pk Lim	Peak Field Strength Limit
Read	Analyzer Reading	Avg	Average Field Strength @ 3 m	Avg Mar	Margin vs. Average Limit
AF	Antenna Factor	Peak	Calculated Peak Field Strength	Pk Mar	Margin vs. Peak Limit
CL	Cable Loss	HPF	High Pass Filter		

**High Frequency Measurement**  
 Compliance Certification Services, Fremont 3m Chamber

**Company:** SILCON IMAGE  
**Project #:** 12U14407  
**Date:** 4/30/2012  
**Test Engineer:** MENGISTU MEKURIA  
**Configuration:** EUT AND SUPPORT EQUIPMENT (Sink)  
**Mode:** VIDEO AND AUDIO TX/RX

**Test Equipment:**

<b>Horn 1-18GHz</b>	<b>Pre-amplifer 1-26GHz</b>	<b>Pre-amplifer 26-40GHz</b>	<b>Horn &gt; 18GHz</b>	<b>Limit</b>
T73; S/N: 6717 @3m	T145 Agilent 3008A0056	T88 Miteq 26.40GHz	T89; ARA 18-26GHz; S/N:1049	FCC 15.209

Hi Frequency Cables

<b>3' cable 22807700</b>	<b>12' cable 22807600</b>	<b>20' cable 22807500</b>	<b>HPF</b>	<b>Reject Filter</b>	<b>Peak Measurements</b> RBW=VBW=1MHz
3' cable 22807700	12' cable 22807600	20' cable 22807500			<b>Average Measurements</b> RBW=1MHz ; VBW=10Hz

f GHz	Dist (m)	Read Pk dBuV	Read Avg. dBuV	AF dB/m	CL dB	Amp dB	D Corr dB	Filtr dB	Peak dBuV/m	Avg dBuV/m	Pk Lim dBuV/m	Avg Lim dBuV/m	Pk Mar dB	Avg Mar dB	Notes (V/H)
24.192	3.0	36.1	24.8	33.9	17.2	-32.1	0.0	0.0	55.1	43.8	74	54	-18.9	-10.2	V
25.056	3.0	37.9	27.1	33.9	18.6	-32.1	0.0	0.0	58.3	47.4	74	54	-15.7	-6.6	V
24.192	3.0	36.1	24.3	33.9	17.2	-32.1	0.0	0.0	55.1	43.3	74	54	-18.9	-10.7	H
25.056	3.0	37.6	26.0	33.9	18.6	-32.1	0.0	0.0	58.0	46.4	74	54	-16.0	-7.6	H

Rev. 07.08.11

f	Measurement Frequency	Amp	Preamp Gain	Avg Lim	Average Field Strength Limit
Dist	Distance to Antenna	D Corr	Distance Correct to 3 meters	Pk Lim	Peak Field Strength Limit
Read	Analyzer Reading	Avg	Average Field Strength @ 3 m	Avg Mar	Margin vs. Average Limit
AF	Antenna Factor	Peak	Calculated Peak Field Strength	Pk Mar	Margin vs. Peak Limit
CL	Cable Loss	HPF	High Pass Filter		

The emission at 24.192 GHz corresponds to all LRP channels associated with MRP/HRP Channel 2 and the emission at 25.056 GHz corresponds to all LRP channels associated with MRP/HRP Channel 3. The amplitude of the above spurious emissions are independent of the LRP channel.

**TX AND RX SPURIOUS EMISSIONS 40 TO 200 GHz**

**PEAK MEASUREMENT**

Note: The peak density is less than the average limit

Emission corresponding to all LRP Channels associated with MRP/HRP Channel 2

Frequency (GHz)	Measurement Distance (m)	Peak Power (dBm)	Rx Antenna Gain (dBi)	EIRP (dBm)
48.384	0.400	-73.94	20.00	-35.8
EIRP (W)	Specification Distance (m)	Power Density (W/m <sup>2</sup> )	Power Density (pW/cm <sup>2</sup> )	Limit (pW/cm <sup>2</sup> )
2.65E-07	3.0	2.34E-09	0.23	90

Emission corresponding to all LRP Channels associated with MRP/HRP Channel 3

Frequency (GHz)	Measurement Distance (m)	Peak Power (dBm)	Rx Antenna Gain (dBi)	EIRP (dBm)
50.112	0.400	-74.12	20.00	-35.6
EIRP (W)	Specification Distance (m)	Power Density (W/m <sup>2</sup> )	Power Density (pW/cm <sup>2</sup> )	Limit (pW/cm <sup>2</sup> )
2.73E-07	3.0	2.41E-09	0.24	90

The amplitude of the above spurious emissions are independent of the LRP channel.



### 7.3. AC MAINS LINE CONDUCTED EMISSIONS

#### LIMITS

§15.207  
IC RSS-GEN, Section 7.2.2

Frequency range (MHz)	Limits (dB $\mu$ V)	
	Quasi-peak	Average
0.15 to 0.50	66 to 56	56 to 46
0.50 to 5	56	46
5 to 30	60	50

Notes:  
1. The lower limit shall apply at the transition frequencies  
2. The limit decreases linearly with the logarithm of the frequency in the range 0.15 MHz to 0.50 MHz.

#### TEST PROCEDURE

ANSI C63.4

**6 WORST EMISSIONS**

Project No:12U14407									
Client Name:Silicon Image									
Model/Device:Wireless HD (Sink)									
Test Volt/Freq:115VAC/ 60Hz									
Test By:M. Mekuria									
Line-L1 .15 - 30MHz									
Test Frequency	Meter Reading	Detector	T24 IL L1.TXT [dB]	LC Cables 1&3.TXT [dB]	dB[uVolts]	CFR 47 Part 15 Class B QP	Margin	CFR 47 Part 15 Class B Avg	Margin
10.3515	34.45	PK	0.1	0.2	34.75	60	-25.25	-	-
10.3515	19.91	Av	0.1	0.2	20.21	-	-	50	-29.79
16.089	33.29	PK	0.2	0.2	33.69	60	-26.31	-	-
16.089	22.09	Av	0.2	0.2	22.49	-	-	50	-27.51
24	34.95	PK	0.4	0.2	35.55	60	-24.45	-	-
24	31.03	Av	0.4	0.2	31.63	-	-	50	-18.37
Line-L2 .15 - 30MHz									
Test Frequency	Meter Reading	Detector	T24 IL L1.TXT [dB]	LC Cables 1&3.TXT [dB]	dB[uVolts]	CFR 47 Part 15 Class B QP	Margin	CFR 47 Part 15 Class B Avg	Margin
10.6215	37.52	PK	0.1	0.2	37.82	60	-22.18	-	-
10.6215	26.01	Av	0.1	0.2	26.31	-	-	50	-23.69
16.224	33.83	PK	0.2	0.2	34.23	60	-25.77	-	-
16.224	20.3	Av	0.2	0.2	20.7	-	-	50	-29.3
24	37.57	PK	0.4	0.2	38.17	60	-21.83	-	-
24	31.72	Av	0.4	0.2	32.32	-	-	50	-17.68

**LINE 1 RESULTS**

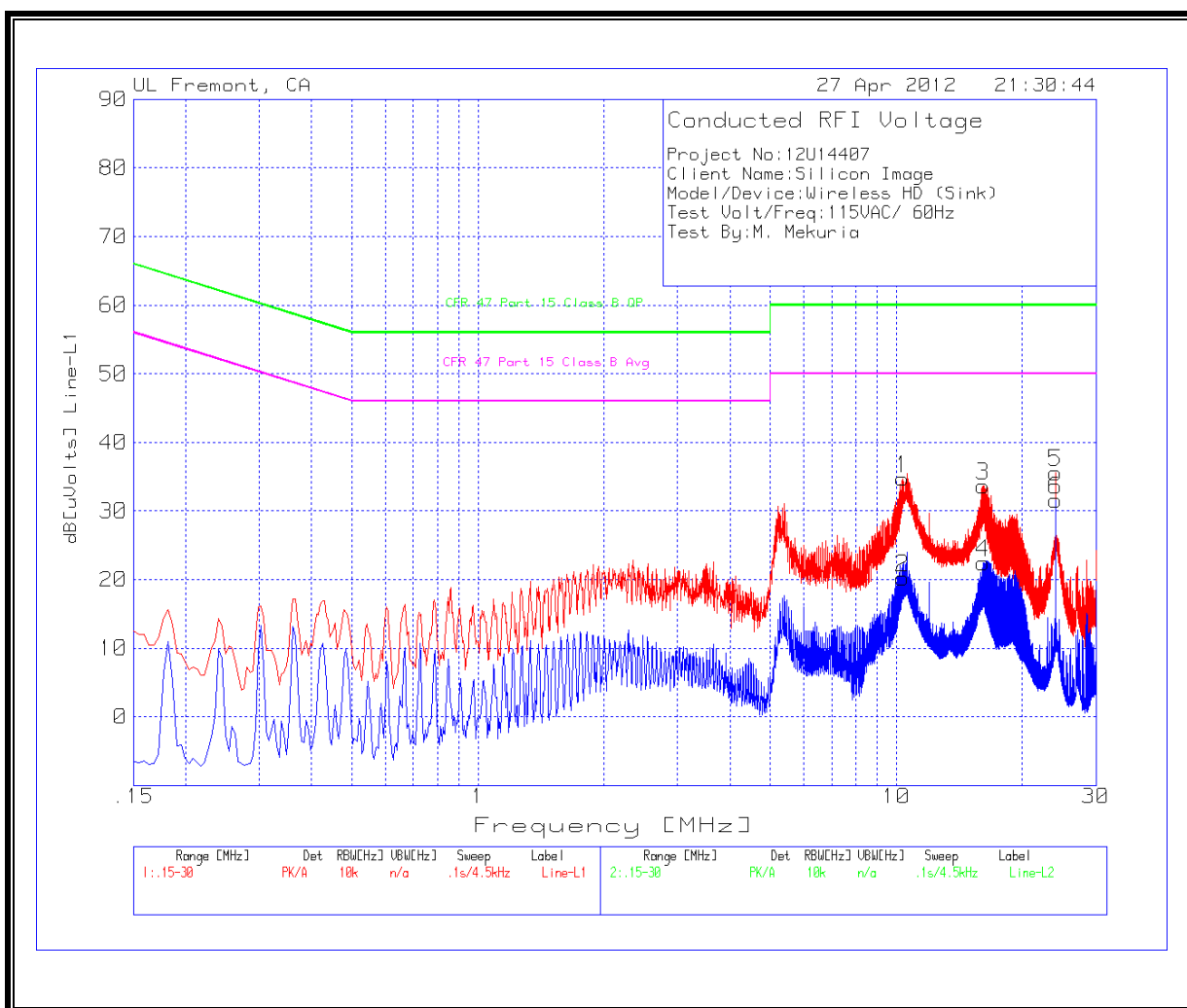

**LINE 2 RESULTS**

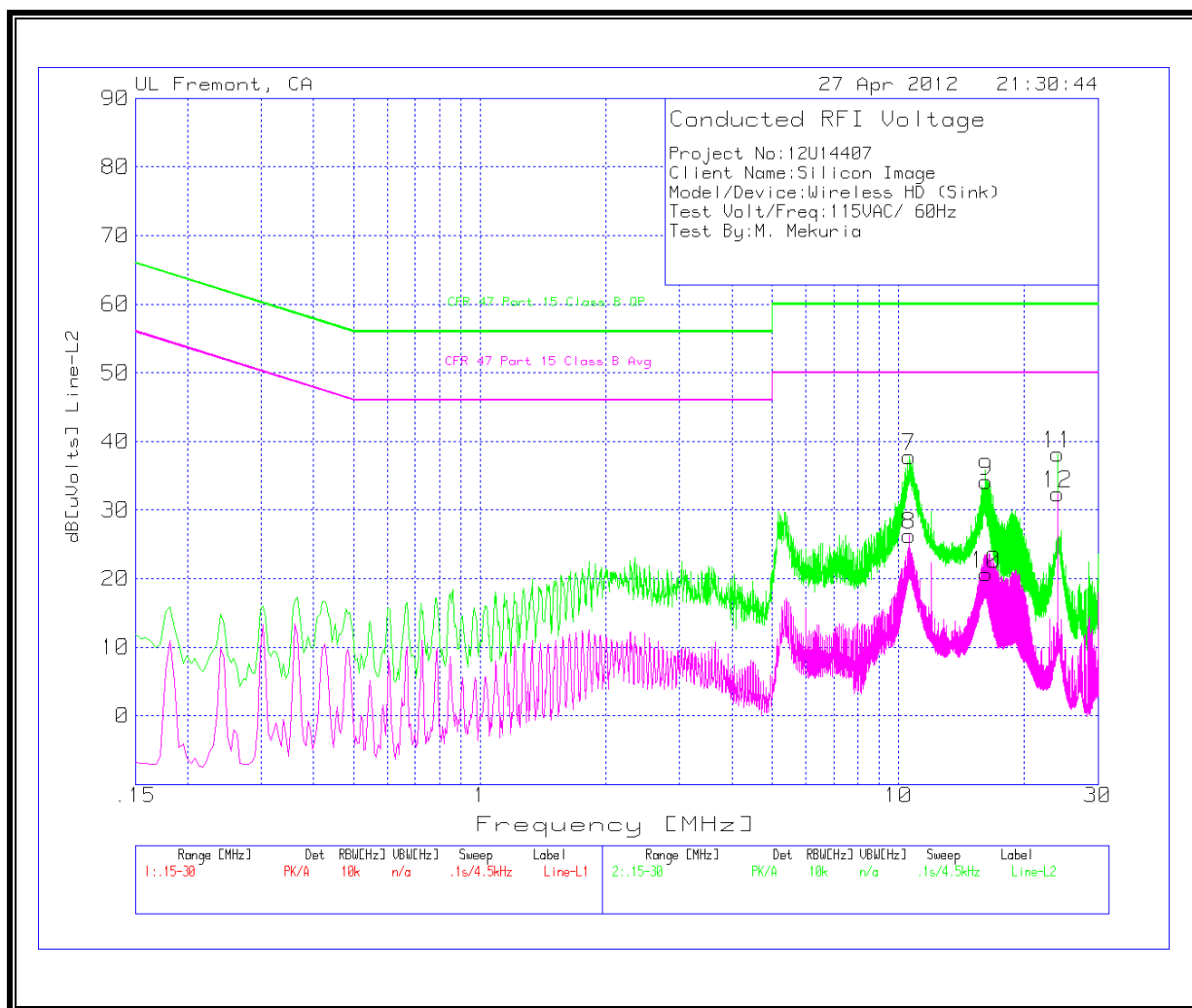

## 7.4. FREQUENCY STABILITY

### LIMIT

§15.255 (f) Fundamental emissions must be contained within the frequency bands specified in this section during all conditions of operation. Equipment is presumed to operate over the temperature range - 20 to +50 degrees celsius with an input voltage variation of 85% to 115% of rated input voltage, unless justification is presented to demonstrate otherwise.

### APPLIED LIMIT

The EUT is intended for indoor use only with a manufacturer's specified temperature range of 0 to 50 °C, and for installation in host devices that furnish DC supply voltage regulated to within +/- 10% of the rated input voltage.

### TEST PROCEDURE

The radio module is placed in an environmental chamber, with power furnished by an adjustable source. The carrier frequency is counted at each condition and compared with the reference condition.

### RESULTS

Reference Conditions: 3.3VDC @ 20°C			
Power Supply (VDC)	Environment Temperature (°C)	Frequency	Delta
		(MHz)	(kHz)
3.30	50	62640.0282490	-10.306
3.30	40	62640.0601830	21.628
3.30	30	62640.1302640	91.709
<b>3.30</b>	<b>20</b>	<b>62640.0385550</b>	<b>Reference</b>
3.30	10	62639.9999260	-38.629
3.30	0	62639.9842480	-54.307
3.63	20	62640.0175990	-20.956
2.97	20	62640.0692410	30.686

## **7.5. GROUP INSTALLATION**

### **LIMIT**

§15.255 (h) Any transmitter that has received the necessary FCC equipment authorization under the rules of this chapter may be mounted in a group installation for simultaneous operation with one or more other transmitter(s) that have received the necessary FCC equipment authorization, without any additional equipment authorization. However, no transmitter operating under the provisions of this section may be equipped with external phase-locking inputs that permit beam-forming arrays to be realized.

### **RESULTS**

The frequency, amplitude and phase of the transmit signal are set within the EUT. There are no external phase-locking inputs or any other means of combining two or more units together to realize a beam-forming array.

## 7.6. TRANSMITTER IDENTIFICATION

### LIMIT

§15.255 (i) For all transmissions that emanate from inside of a building, within any one second interval of signal transmission, each transmitter with a peak output power equal to or greater than 0.1 mW or a peak power density equal to or greater than 3 nW/cm<sup>2</sup>, as measured 3 meters from the radiating structure, must transmit a transmitter identification at least once. Each application for equipment authorization for equipment that will be used inside of a building must declare that the equipment contains the required transmitter identification feature and must specify a method whereby interested parties can obtain sufficient information, at no cost, to enable them to fully detect and decode this transmitter identification information. Upon the completion of decoding, the transmitter identification data block must provide the following fields:

- (1) FCC Identifier, which shall be programmed at the factory.
- (2) Manufacturer's serial number, which shall be programmed at the factory.
- (3) Provision for at least 24 bytes of data relevant to the specific device, which shall be field programmable. The grantee must implement a method that makes it possible for users to specify and update this data. The recommended content of this field is information to assist in contacting the operator.

### RESULTS

Not Applicable.

The EUT is part of a WVAN. All components of the WVAN are for indoor operation only. There are no outdoor units therefore no transmissions are directed outside the building.