



1190  
ILAC MRA

**Specific Absorption Rate (SAR) Test Report**  
for  
**GIGA-BYTE Communications Inc.**  
on the  
**GSM900/DCS1800/PCS1900/Bluetooth/WLAN Mobile Phone**

Report No. : FA681418-B-1-2-01  
Trade Name : GIGABYTE  
Model Name : Stealth  
Marketing Name : Xda Stealth  
FCC ID : UJU9QSTEAL000  
Date of Testing : Aug. 23, 2006  
Date of Report : Aug. 25, 2006  
Date of Review : Aug. 25, 2006

- The test results refer exclusively to the presented test model/sample only.
- Without written approval of SPORTON International Inc., the test report shall not be reproduced except in full.
- Report Version: Rev.01.

**SPORTON International Inc.**

6F, No.106, Sec. 1, Hsin Tai Wu Rd., Hsi Chih, Taipei Hsien, Taiwan, R.O.C.



Table of Contents

1. Statement of Compliance ----- 1
2. Administration Data ----- 2
2.1 Testing Laboratory ----- 2
2.2 Detail of Applicant ----- 2
2.3 Detail of Manufacturer ----- 2
2.4 Application Detail ----- 2
3. General Information ----- 3
3.1 Description of Device Under Test (DUT) ----- 3
3.2 Product Photo ----- 4
3.3 Applied Standards ----- 5
3.4 Device Category and SAR Limits ----- 6
3.5 Test Conditions ----- 6
3.5.1 Ambient Condition ----- 6
3.5.2 Test Configuration ----- 6
4. Specific Absorption Rate (SAR) ----- 7
4.1 Introduction ----- 7
4.2 SAR Definition ----- 7
5. SAR Measurement Setup ----- 8
5.1 DASY4 E-Field Probe System ----- 9
5.1.1 ET3DV6 E-Field Probe Specification ----- 10
5.1.2 ET3DV6 E-Field Probe Calibration ----- 10
5.2 DATA Acquisition Electronics (DAE) ----- 11
5.3 Robot ----- 12
5.4 Measurement Server ----- 12
5.5 SAM Twin Phantom ----- 12
5.6 Device Holder for SAM Twin Phantom ----- 14
5.7 Data Storage and Evaluation ----- 15
5.7.1 Data Storage ----- 15
5.7.2 Data Evaluation ----- 15
5.8 Test Equipment List ----- 18
6. Tissue Simulating Liquids ----- 19
7. Uncertainty Assessment ----- 21
8. SAR Measurement Evaluation ----- 23
8.1 Purpose of System Performance check ----- 23
8.2 System Setup ----- 23
8.3 Validation Results ----- 25
9. Description for DUT Testing Position ----- 26
10. Measurement Procedures ----- 33
11. SAR Test Results ----- 35
11.1 Right Cheek in Close Mode ----- 35
11.2 Right Tilted in Close Mode ----- 35
11.3 Left Cheek in Close Mode ----- 35
11.4 Left Tilted in Close Mode ----- 35
11.5 Right Cheek in Open Mode ----- 35
11.6 Right Tilted in Open Mode ----- 35
11.7 Left Cheek in Open Mode ----- 36
11.8 Left Tilted in Open Mode ----- 36
11.9 Keypad Up with 1.5cm Gap ----- 36
11.10 Keypad Down with 1.5cm Gap ----- 36
12. References ----- 37

- Appendix A - System Performance Check Data
Appendix B - SAR Measurement Data
Appendix C - Calibration Data



---

**1. Statement of Compliance**

The Specific Absorption Rate (SAR) maximum results found during testing for the **GIGA-BYTE Communications Inc. GSM900/DCS1800/PCS1900/Bluetooth/WLAN Mobile Phone GIGABYTE Stealth** are **0.224 W/kg for PCS head SAR and 0.786 W/kg for PCS body SAR** with expanded uncertainty 20.6%. They are in compliance with Specific Absorption Rate (SAR) for general population/uncontrolled exposure limits specified in FCC 47 CFR part 2 (2.1093) and ANSI/IEEE C95.1-1999 and had been tested in accordance with the measurement methods and procedures specified in OET Bulletin 65 Supplement C (Edition 01-01).

Approved by

A handwritten signature in blue ink that reads "Daniel Lee". The signature is written in a cursive style and is positioned above a horizontal line.

Dr. Daniel Lee  
EMC/SAR Director



---

## **2. Administration Data**

### **2.1 Testing Laboratory**

**Company Name :** Sporton International Inc.  
**Department :** Antenna Design/SAR  
**Address :** No.52, Hwa-Ya 1<sup>st</sup> RD., Hwa Ya Technology Park, Kwei-Shan Hsiang, TaoYuan Hsien, Taiwan, R.O.C.  
**Telephone Number :** 886-3-327-3456  
**Fax Number :** 886-3-327-0973

### **2.2 Detail of Applicant**

**Company Name :** GIGA-BYTE Communications Inc.  
**Address :** 8F, No.43, Fu-Hsin Road, Hsin-Tien, Taipei Hsien, Taiwan, R.O.C.

### **2.3 Detail of Manufacturer**

**Company Name :** GIGA-BYTE TECHNOLOGY CO., LTD.  
**Address :** No.215, Nan-Ping Road, Pin-Jan City, Taoyuan, Taiwan, R.O.C.

### **2.4 Application Detail**

**Date of reception of application:** Aug. 15, 2006  
**Start of test :** Aug. 23, 2006  
**End of test :** Aug. 23, 2006



### 3. General Information

#### 3.1 Description of Device Under Test (DUT)

DUT Type :	GSM900/DCS1800/PCS1900/Bluetooth/WLAN Mobile Phone
Trade Name :	GIGABYTE
Model Name :	Stealth
Marketing Name :	Xda Stealth
FCC ID :	UJU9QSTEAL000
Tx Frequency :	PCS1900 : 1850 ~ 1910 MHz Bluetooth : 2400 ~ 2483.5 MHz WLAN : 2400 ~ 2483.5 MHz
Rx Frequency :	PCS1900 : 1930 ~ 1990 MHz Bluetooth : 2400 ~ 2483.5 MHz WLAN : 2400 ~ 2483.5 MHz
Number of Channels :	Bluetooth : 79 WLAN : 11
Carrier Frequency of Each Channel :	Bluetooth : $2402+n*1$ MHz; n=0~78 WLAN : $2412+(n-1)*5$ MHz; n=1~11
Maximum Output Power to Antenna :	PCS1900 : 29.70 dBm Bluetooth : -0.6 dBm WLAN : 802.11b : 17.28 dBm / 802.11g : 19.30 dBm
Antenna Connector :	N/A
Antenna Type :	GSM/PCS : PIFA Antenna Bluetooth : Chip Antenna WLAN: Chip Antenna
Antenna Gain :	PCS : -2 dBi Bluetooth : -3 dBi WLAN : -3 dBi
HW Version :	Version 0.2
SW Version :	B02.003
Type of Modulation :	GSM/GPRS : GMSK Bluetooth : GFSK WLAN : DSSS / OFDM
DUT Stage :	Identical Prototype
Power Rating :	3.7V / 1300mA
Application Type :	Certification
Accessory :	Battery: Welldone, XP-04



**3.2 Product Photo**





**3.3 Applied Standards:**

The Specific Absorption Rate (SAR) testing specification, method and procedure for this GSM900/DCS1800/PCS1900/Bluetooth/WLAN Mobile Phone is in accordance with the following standards:

47 CFR Part 2 ( 2.1093),  
IEEE C95.1-1999,  
IEEE C95.3-2002,  
IEEE P1528-2003, and  
OET Bulletin 65 Supplement C (Edition 01-01)



**3.4 Device Category and SAR Limits**

This device belongs to portable device category because its radiating structure is allowed to be used within 20 centimeters of the body of the user.

Limit for General Population/Uncontrolled exposure should be applied for this device, it is 1.6 W/kg as averaged over any 1 gram of tissue.

**3.5 Test Conditions:**

**3.5.1 Ambient Condition**

Item	HSL 1900	MSL 1900
Ambient Temperature (°C)	20-24	
Tissue simulating liquid temperature (°C)	22.7	22.2
Humidity (%)	<60 %	

**3.5.2 Test Configuration**

The device was controlled by using a base station emulator R&S CMU200. Communication between the device and the emulator was established by air link. The distance between the DUT and the antenna of the emulator is larger than 50 cm and the output power radiated from the emulator antenna is at least 30 dB smaller than the output power of DUT.

Measurements were performed on the lowest, middle, and highest channel for each testing position for head SAR testing. Measurements were performed only on the middle channel if the SAR is below 3 dB of limit for body SAR testing.

The DUT was set from the emulator to radiate maximum output power during all testings.

For head SAR testing, EUT is in GSM link mode, and its crest factor is 8.3. For body SAR testing, EUT is in GPRS link mode, and its crest factor is 4 because EUT is GPRS class 10 device.





## **4. Specific Absorption Rate (SAR)**

### **4.1 Introduction**

SAR is related to the rate at which energy is absorbed per unit mass in an object exposed to a radio field. The SAR distribution in a biological body is complicated and is usually carried out by experimental techniques or numerical modeling. The standard recommends limits for two tiers of groups, occupational/controlled and general population/uncontrolled, based on a person's awareness and ability to exercise control over his or her exposure. In general, occupational/controlled exposure limits are higher than the limits for general population/uncontrolled.

### **4.2 SAR Definition**

The SAR definition is the time derivative (rate) of the incremental energy (dW) absorbed by (dissipated in) an incremental mass (dm) contained in a volume element (dv) of a given density.

). The equation description is as below:

$$\mathbf{SAR} = \frac{d}{dt} \left( \frac{dW}{dm} \right) = \frac{d}{dt} \left( \frac{dW}{\rho dv} \right)$$

*SAR is expressed in units of Watts per kilogram (W/kg)*

SAR measurement can be either related to the temperature elevation in tissue by

$$\mathbf{SAR} = C \frac{\delta T}{\delta t}$$

, where C is the specific heat capacity,  $\delta T$  is the temperature rise and  $\delta t$  the exposure duration,

or related to the electrical field in the tissue by

$$\mathbf{SAR} = \frac{\sigma |E|^2}{\rho}$$

, where  $\sigma$  is the conductivity of the tissue,  $\rho$  is the mass density of the tissue and  $E$  is the rms electrical field strength.

However for evaluating SAR of low power transmitter, electrical field measurement is typically applied.

**5. SAR Measurement Setup**

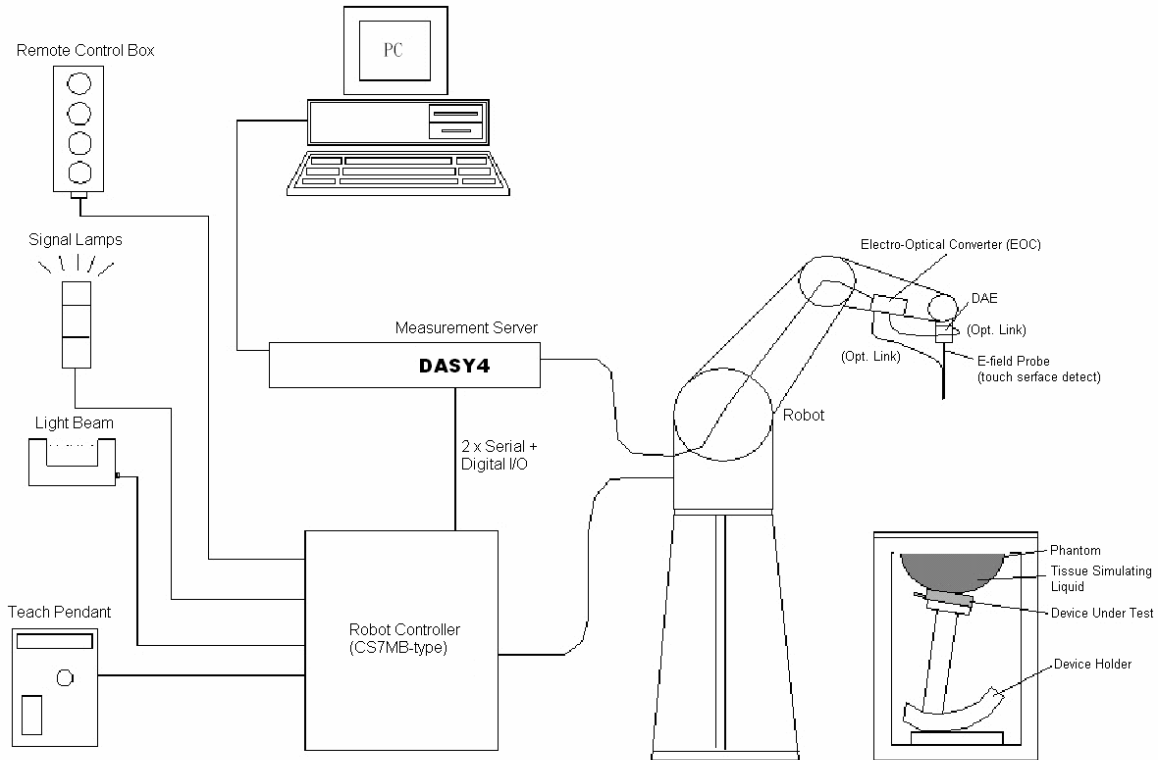

**Fig. 5.1 DASY4 system**



---

The DASY4 system for performance compliance tests is illustrated above graphically. This system consists of the following items:

- A standard high precision 6-axis robot with controller, a teach pendant and software
- A data acquisition electronic (DAE) attached to the robot arm extension
- A dosimetric probe equipped with an optical surface detector system
- The electro-optical converter (ECO) performs the conversion between optical and electrical signals
- A measurement server performs the time critical tasks such as signal filtering, control of the robot operation and fast movement interrupts.
- A probe alignment unit which improves the accuracy of the probe positioning
- A computer operating Windows XP
- DASY4 software
- Remote control with teach pendant and additional circuitry for robot safety such as warning lamps, etc.
- The SAM twin phantom
- A device holder
- Tissue simulating liquid
- Dipole for evaluating the proper functioning of the system

Some of the components are described in details in the following sub-sections.

### **5.1 DASY4 E-Field Probe System**

The SAR measurement is conducted with the dosimetric probe ET3DV6 (manufactured by SPEAG). The probe is specially designed and calibrated for use in liquid with high permittivity. The dosimetric probe has special calibration in liquid at different frequency. This probe has a built in optical surface detection system to prevent from collision with phantom.

**5.1.1 ET3DV6 E-Field Probe Specification**

<b>Construction</b>	Symmetrical design with triangular core Built-in optical fiber for surface detection system Built-in shielding against static charges PEEK enclosure material (resistant to organic solvents)
<b>Calibration</b>	Simulating tissue at frequencies of 900MHz, 1.8GHz and 2.45GHz for brain and muscle (accuracy $\pm 8\%$ )
<b>Frequency</b>	10 MHz to > 3 GHz
<b>Directivity</b>	$\pm 0.2$ dB in brain tissue (rotation around probe axis) $\pm 0.4$ dB in brain tissue (rotation perpendicular to probe axis)
<b>Dynamic Range</b>	5 $\mu$ W/g to > 100mW/g; Linearity: $\pm 0.2$ dB
<b>Surface Detection</b>	$\pm 0.2$ mm repeatability in air and clear liquids on reflecting surface
<b>Dimensions</b>	Overall length: 330mm Tip length: 16mm Body diameter: 12mm  Tip diameter: 6.8mm Distance from probe tip to dipole centers: 2.7mm
<b>Application</b>	General dosimetry up to 3GHz Compliance tests for mobile phones and Wireless LAN Fast automatic scanning in arbitrary phantoms



**Fig. 5.2 Probe setup on robot**

**5.1.2 ET3DV6 E-Field Probe Calibration**

Each probe needs to be calibrated according to a dosimetric assessment procedure with accuracy better than  $\pm 10\%$ . The spherical isotropy shall be evaluated and within  $\pm 0.25$ dB. The sensitivity parameters (NormX, NormY, and NormZ), the diode compression parameter (DCP) and the conversion factor (ConvF) of the probe are tested. The calibration data are as below:



<b>Sensitivity</b>	X axis : 1.57 $\mu$ V	Y axis : 1.71 $\mu$ V	Z axis : 2.09 $\mu$ V	
<b>Diode compression point</b>	X axis : 94 mV	Y axis : 94 mV	Z axis : 94 mV	
<b>Conversion factor (Head / Body)</b>	<b>Frequency (MHz)</b>	<b>X axis</b>	<b>Y axis</b>	<b>Z axis</b>
	800~1000	6.38 / 6.18	6.38 / 6.18	6.38 / 6.18
	1710~1910	5.26 / 4.66	5.26 / 4.66	5.26 / 4.66
<b>Boundary effect (Head / Body)</b>	<b>Frequency (MHz)</b>	<b>Alpha</b>	<b>Depth</b>	
	800~1000	0.50 / 0.44	1.85 / 2.10	
	1710~1910	0.59 / 0.62	2.46 / 2.44	

NOTE:

- The probe parameters have been calibrated by the SPEAG.

**5.2 DATA Acquisition Electronics (DAE)**

The data acquisition electronics (DAE) consists of a highly sensitive electrometer-grade preamplifier with auto-zeroing, a channel and gain-switching multiplexer, a fast 16 bit AD-converter and a command decoder and control logic unit. Transmission to the measurement server is accomplished through an optical downlink for data and status information as well as an optical uplink for commands and the clock.

The mechanical probe mounting device includes two different sensor systems for frontal and sideways probe contacts. They are used for mechanical surface detection and probe collision detection.

The input impedance of the DAE is 200M Ohm; the inputs are symmetrical and floating. Common mode rejection is above 80dB.



---

### **5.3 Robot**

The DASY4 system uses the high precision robots RX90BL type out of the newer series from Stäubli SA (France). For the 6-axis controller DASY5 system, the CS7MB robot controller version from Stäubli is used. The RX robot series have many features that are important for our application:

- High precision (repeatability 0.02 mm)
- High reliability (industrial design)
- Jerk-free straight movements
- Low ELF interference (the closed metallic construction shields against motor control fields)
- 6-axis controller

### **5.4 Measurement Server**

The DASY4 measurement server is based on a PC/104 CPU board with  
166 MHz CPU  
32 MB chipset and  
64 MB RAM.

Communication with  
the DAE4 electronic box  
the 16-bit AD-converter system for optical detection and digital I/O interface.

The measurement server performs all the real-time data evaluation for field measurements and surface detection, controls robot movements and handles safety operations.

### **5.5 SAM Twin Phantom**

The SAM twin phantom is a fiberglass shell phantom with 2mm shell thickness (except the ear region where shell thickness increases to 6mm). It has three measurement areas:

- Left head
- Right head
- Flat phantom

The bottom plate contains three pair of bolts for locking the device holder. The device holder positions are adjusted to the standard measurement positions in the three sections.

A white cover is provided to tap the phantom during off-periods to prevent water evaporation and changes in the liquid parameters.



On the phantom top, three reference markers are provided to identify the phantom position with respect to the robot.

The phantom can be used with the following tissue simulating liquids:

\*Water-sugar based liquid

\*Glycol based liquids

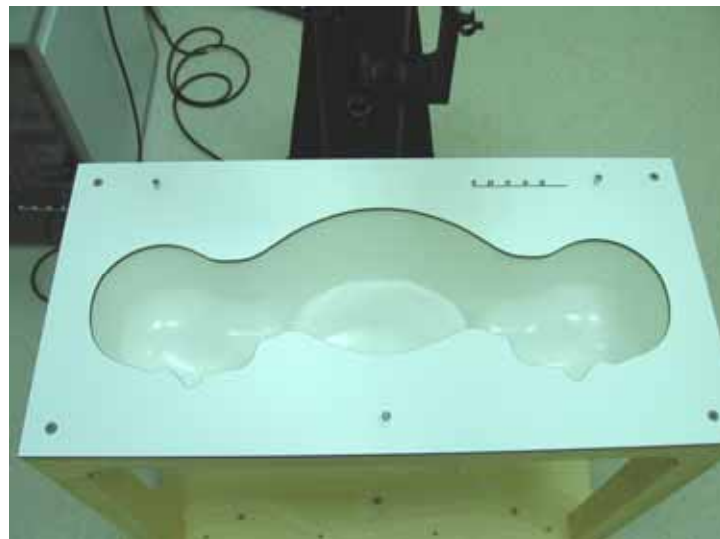

**Fig. 5.3 Top view of twin phantom**



**Fig. 5.4 Bottom view of twin phantom**

### **5.6 Device Holder for SAM Twin Phantom**

The SAR in the Phantom is approximately inversely proportional to the square of the distance between the source and the liquid surface. For a source in 5 mm distance, a positioning uncertainty of  $\pm 0.5\text{mm}$  would produce a SAR uncertainty of  $\pm 20\%$ . An accurate device position is therefore crucial for accurate and repeatable measurement. The position in which the devices must be measured, are defined by the standards.

The DASY device holder is designed to cope with different positions given in the standard. It has two scales for the device rotation (with respect to the body axis) and the device inclination (with respect to the line between the ear reference points). The rotation centers for both scales is the ear reference point (EPR). Thus the device needs no repositioning when changing the angles.

The DASY device holder has been made out of low-loss POM material having the following dielectric parameters: relative permittivity  $\epsilon_r=3$  and loss tangent  $\delta = 0.02$ . The amount of dielectric material has been reduced in the closest vicinity of the device, since measurements have suggested that the influence of the clamp on the test results could thus be lowered.



**Fig. 5.5 Device Holder**





## 5.7 Data Storage and Evaluation

### 5.7.1 Data Storage

The DASY4 software stores the assessed data from the data acquisition electronics as raw data (in microvolt readings from the probe sensors), together with all the necessary software parameters for the data evaluation (probe calibration data, liquid parameters and device frequency and modulation data) in measurement files with the extension .DA4. The postprocessing software evaluates the desired unit and format for output each time the data is visualized or exported. This allows verification of the complete software setup even after the measurement and allows correction of erroneous parameter settings. For example, if a measurement has been performed with an incorrect crest factor parameter in the device setup, the parameter can be corrected afterwards and the data can be reevaluated.

The measured data can be visualized or exported in different units or formats, depending on the selected probe type (e.g., [V/m], [A/m], [mW/g]). Some of these units are not available in certain situations or give meaningless results, e.g., a SAR-output in a loseless media, will always be zero. Raw data can also be exported to perform the evaluation with other software packages.

### 5.7.2 Data Evaluation

The DASY4 postprocessing software (SEMCAD) automatically executes the following procedures to calculate the field units from the microvolt readings at the probe connector. The parameters used in the evaluation are stored in the configuration modules of the software :

<b>Probe parameters :</b>	- Sensitivity	Norm <sub>i</sub> , a <sub>i0</sub> , a <sub>i1</sub> , a <sub>i2</sub>
	- Conversion factor	ConvF <sub>i</sub>
	- Diode compression point	dcp <sub>i</sub>
<b>Device parameters :</b>	- Frequency	f
	- Crest factor	cf
<b>Media parameters :</b>	- Conductivity	
	- Density	

These parameters must be set correctly in the software. They can be found in the component documents or they can be imported into the software from the configuration files issued for the DASY components. In the direct measuring mode of the multimeter option, the parameters of the actual system setup are used. In the scan visualization and export modes, the parameters stored in the corresponding document files are used.

The first step of the evaluation is a linearization of the filtered input signal to account for the compression characteristics of the detector diode. The compensation depends on the input signal, the diode type and the DC-transmission factor from the diode to the evaluation electronics. If the exciting field is pulsed, the crest factor of the signal must be known to correctly compensate for peak power. The formula for each channel



can be given as :

$$V_i = U_i + U_i^2 \cdot \frac{cf}{dcp_i}$$

with  $V_i$  = compensated signal of channel  $i$  ( $i = x, y, z$ )  
 $U_i$  = input signal of channel  $i$  ( $i = x, y, z$ )  
 $cf$  = crest factor of exciting field (DASY parameter)  
 $dcp_i$  = diode compression point (DASY parameter)

From the compensated input signals, the primary field data for each channel can be evaluated :

**E-field probes :**  $E_i = \sqrt{\frac{V_i}{Norm_i ConvF}}$

**H-field probes :**  $H_i = \sqrt{V_i \frac{a_{i0} + a_{i1}f + a_{i2}f^2}{f}}$

with  $V_i$  = compensated signal of channel  $i$  ( $i = x, y, z$ )  
 $Norm_i$  = sensor sensitivity of channel  $i$  ( $i = x, y, z$ )  
 $\mu V/(V/m)^2$  for E-field Probes  
 $ConvF$  = sensitivity enhancement in solution  
 $a_{ij}$  = sensor sensitivity factors for H-field probes  
 $f$  = carrier frequency [GHz]  
 $E_i$  = electric field strength of channel  $i$  in V/m  
 $H_i$  = magnetic field strength of channel  $i$  in A/m

The RSS value of the field components gives the total field strength (Hermitian magnitude) :

$$E_{tot} = \sqrt{E_x^2 + E_y^2 + E_z^2}$$

The primary field data are used to calculate the derived field units.

$$SAR = E_{tot}^2 \cdot \frac{\sigma}{\rho \cdot 1000}$$

with  $SAR$  = local specific absorption rate in mW/g  
 $E_{tot}$  = total field strength in V/m  
 $\sigma$  = conductivity in [mho/m] or [Siemens/m]  
 $\rho$  = equivalent tissue density in g/cm<sup>3</sup>



\* Note that the density is set to 1, to account for actual head tissue density rather than the density of the tissue simulating liquid.

The power flow density is calculated assuming the excitation field to be a free space field.

$$P_{pwe} = \frac{E_{tot}^2}{3770} \quad \text{or} \quad P_{pwe} = H_{tot}^2 \cdot 37.7$$

with  $P_{pwe}$  = equivalent power density of a plane wave in mW/cm<sup>2</sup>  
 $E_{tot}$  = total electric field strength in V/m  
 $H_{tot}$  = total magnetic field strength in A/m



**5.8 Test Equipment List**

Manufacture	Name of Equipment	Type/Model	Serial Number	Calibration	
				Last Cal.	Due Date
SPEAG	Dosimetric E-Filed Probe	ET3DV6	1787	May 31, 2006	May 31, 2007
SPEAG	835MHz System Validation Kit	D835V2	499	Mar. 15, 2006	Mar. 15, 2008
SPEAG	900MHz System Validation Kit	D900V2	190	Jul. 19, 2005	Jul. 19, 2007
SPEAG	1800MHz System Validation Kit	D1800V2	2d076	Jul. 20, 2005	Jul. 20, 2007
SPEAG	1900MHz System Validation Kit	D1900V2	5d041	Mar. 21, 2006	Mar. 21, 2008
SPEAG	2450MHz System Validation Kit	D2450V2	736	Jul. 12, 2005	Jul. 12, 2007
SPEAG	Data Acquisition Electronics	DAE3	577	Nov. 11, 2005	Nov. 11, 2006
SPEAG	Device Holder	N/A	N/A	NCR	NCR
SPEAG	Phantom	QD 000 P40 C	TP-1150	NCR	NCR
SPEAG	Robot	Staubli RX90BL	F03/5W15A1/A/01	NCR	NCR
SPEAG	Software	DASY4 V4.6 Build 23	N/A	NCR	NCR
SPEAG	Software	SEMCAD V1.8 Build 161	N/A	NCR	NCR
SPEAG	Measurement Server	SE UMS 001 BA	1021	NCR	NCR
Agilent	S-Parameter Network Analyzer (PNA)	E8358A	US40260131	Sep. 16, 2005	Sep. 16, 2006
Agilent	Dielectric Probe Kit	85070D	US01440205	NCR	NCR
Agilent	Dual Directional Coupler	778D	50422	NCR	NCR
Agilent	Power Amplifier	8449B	3008A01917	NCR	NCR
R&S	Radio Communication Tester	CMU200	105934	Aug. 23, 2005	Aug. 23, 2007
Agilent	Power Meter	E4416A	GB41292344	Jan. 23, 2006	Jan. 23, 2008
Agilent	Power Sensor	E9327A	US40441548	Feb. 6, 2006	Feb. 6, 2007
Agilent	Signal Generator	E8247C	MY43320596	Mar. 1, 2006	Mar. 1, 2008

**Table 5.1 Test Equipment List**



**6. Tissue Simulating Liquids**

For the measurement of the field distribution inside the SAM phantom with DASY4, the phantom must be filled with around 25 liters of homogeneous tissue simulating liquid. The liquid height from the ear reference point (ERP) of the phantom to the liquid top surface is (head SAR) or from the flat phantom to the liquid top surface (body SAR) is 15.2cm.

The following ingredients for tissue simulating liquid are used:

- **Water:** deionized water (pure H<sub>2</sub>O), resistivity 16M<sup>-1</sup> - as basis for the liquid
- **Sugar:** refined sugar in crystals, as available in food shops – to reduce relative permittivity
- **Salt:** pure NaCl – to increase conductivity
- **Cellulose:** Hydroxyethyl-cellulose, medium viscosity (75-125 mPa.s, 2% in water, 20°C), CAS#54290-to increase viscosity and to keep sugar in solution.
- **Preservative:** Preventol D-7 Bayer AG, D-51368 Leverkusen, CAS#55965-84-9- to prevent the spread of bacteria and molds.
- **DGMBE:** Deithlenglycol-monobuthyl ether (DGMBE), Fluka Chemie GmbH, CAS#112-34-5 – to reduce relative permittivity.

Table 6.1 gives the recipes for one liter of head and body tissue simulating liquid for frequency band 1900 MHz.

Ingredient	HSL-1900	MSL-1900
Water	552.42 g	716.56 g
Cellulose	0 g	0 g
Salt	3.06 g	4.0 g
Preventol D-7	0 g	0 g
Sugar	0 g	0 g
DGMBE	444.52 g	300.67 g
Total amount	1 liter (1.0 kg)	1 liter (1.0 kg)
Dielectric Parameters at 22°	f= 1900 MHz ε <sub>r</sub> = 40.0±5%, σ = 1.4±5% S/m	f= 1900 MHz ε <sub>r</sub> = 53.3±5 %, σ = 1.52±5% S/m

**Table 6.1**

The dielectric parameters of the liquids were verified prior to the SAR evaluation using an Agilent 85070D Dielectric Probe Kit and an Agilent E8358A Network Analyzer.



Table 6.2 shows the measuring results for head and muscle simulating liquid.

	<b>Bands</b>	<b>Frequency(MHz)</b>	<b>Permittivity ( <math>\epsilon_r</math> )</b>	<b>Conductivity ( <math>\sigma</math> )</b>	<b>Measurement Date</b>
Head	PCS band (1850 ~ 1910 MHz)	1850.2	41.6	1.43	Aug. 23, 2006
		1880.0	41.5	1.45	
		1909.8	41.1	1.47	
Body	PCS band (1850 ~ 1910 MHz)	1850.2	52.1	1.49	Aug. 23, 2006
		1880.0	52.0	1.52	
		1909.8	51.9	1.55	

**Table 6.2**

The measuring data are consistent with  $\epsilon_r = 40.0 \pm 5\%$  and  $\sigma = 1.4 \pm 5\%$  for head PCS 1900 band and  $\epsilon_r = 53.3 \pm 5\%$  and  $\sigma = 1.52 \pm 5\%$  for body PCS 1900 band.



**7. Uncertainty Assessment**

The component of uncertainty may generally be categorized according to the methods used to evaluate them. The evaluation of uncertainty by the statistical analysis of a series of observations is termed a Type A evaluation of uncertainty. The evaluation of uncertainty by means other than the statistical analysis of a series of observation is termed a Type B evaluation of uncertainty. Each component of uncertainty, however evaluated, is represented by an estimated standard deviation, termed standard uncertainty, which is determined by the positive square root of the estimated variance.

A Type A evaluation of standard uncertainty may be based on any valid statistical method for treating data. This includes calculating the standard deviation of the mean of a series of independent observations; using the method of least squares to fit a curve to the data in order to estimate the parameter of the curve and their standard deviations; or carrying out an analysis of variance in order to identify and quantify random effects in certain kinds of measurement.

A type B evaluation of standard uncertainty is typically based on scientific judgment using all of the relevant information available. These may include previous measurement data, experience and knowledge of the behavior and properties of relevant materials and instruments, manufacture’s specification, data provided in calibration reports and uncertainties assigned to reference data taken from handbooks. Broadly speaking, the uncertainty is either obtained from an outdoor source or obtained from an assumed distribution, such as the normal distribution, rectangular or triangular distributions indicated in Table 7.1

Uncertainty Distributions	Normal	Rectangular	Triangular	U-shape
Multiplying factor <sup>(a)</sup>	1/k (b)	1/ 3	1/ 6	1/ 2

(a) standard uncertainty is determined as the product of the multiplying factor and the estimated range of variations in the measured quantity

(b) is the coverage factor

**Table 7.1**

The combined standard uncertainty of the measurement result represents the estimated standard deviation of the result. It is obtained by combining the individual standard uncertainties of both Type A and Type B evaluation using the usual “root-sum-squares” (RSS) methods of combining standard deviations by taking the positive square root of the estimated variances.

Expanded uncertainty is a measure of uncertainty that defines an interval about the measurement result within which the measured value is confidently believed to lie. It is obtained by multiplying the combined standard uncertainty by a coverage factor. Typically, the coverage factor ranges from 2 to 3. Using a coverage factor allows the true value of a measured quantity to be specified with a defined probability within the specified uncertainty range. For purpose of this document, a coverage factor two is used, which corresponds to confidence interval of about 95 %. The DASY4 uncertainty Budget is showed in Table 7.2.



Error Description	Uncertainty Value $\pm$ %	Probability Distribution	Divisor	$C_i$ $I_g$	Standard Unc. (1-g)	$v_i$ or $V_{eff}$
<b>Measurement System</b>						
Probe Calibration	$\pm 4.8$	Normal	1	1	$\pm 4.8$	
Axial Isotropy	$\pm 4.7$	Rectangular	$\sqrt{3}$	$(1-C_p)^{1/2}$	$\pm 1.9$	
Hemispherical Isotropy	$\pm 9.6$	Rectangular	$\sqrt{3}$	$(C_p)^{1/2}$	$\pm 3.9$	
Boundary Effect	$\pm 1.0$	Rectangular	$\sqrt{3}$	1	$\pm 0.6$	
Linearity	$\pm 4.7$	Rectangular	$\sqrt{3}$	1	$\pm 2.7$	
System Detection Limit	$\pm 1.0$	Rectangular	$\sqrt{3}$	1	$\pm 0.6$	
Readout Electronics	$\pm 1.0$	Rectangular	1	1	$\pm 1.0$	
Response Time	$\pm 0.8$	Normal	$\sqrt{3}$	1	$\pm 0.5$	
Integration time	$\pm 2.6$	Rectangular	$\sqrt{3}$	1	$\pm 1.5$	
RF Ambient Conditions	$\pm 3.0$	Rectangular	$\sqrt{3}$	1	$\pm 1.7$	
Probe Positioner Mech. Tolerance	$\pm 0.4$	Rectangular	$\sqrt{3}$	1	$\pm 0.2$	
Probe Positioning with respect to Phantom Shell	$\pm 2.9$	Rectangular	$\sqrt{3}$	1	$\pm 1.7$	
Extrapolation and Interpolation Algorithms for Max. SAR Evaluation	$\pm 1.0$	Rectangular	$\sqrt{3}$	1	$\pm 0.6$	
<b>Test sample Related</b>						
Test sample Positioning	$\pm 2.9$	Normal	1	1	$\pm 2.9$	145
Device Holder Uncertainty	$\pm 3.6$	Normal	1	1	$\pm 3.6$	5
Output Power Variation-SAR drift measurement	$\pm 2.5$	Rectangular	$\sqrt{3}$	1	$\pm 1.4$	
<b>Phantom and Tissue parameters</b>						
Phantom uncertainty(Including shape and thickness tolerances)	$\pm 4.0$	Rectangular	$\sqrt{3}$	1	$\pm 2.3$	
Liquid Conductivity Target tolerance	$\pm 5.0$	Rectangular	$\sqrt{3}$	0.64	$\pm 1.8$	
Liquid Conductivity measurement uncertainty	$\pm 2.5$	Normal	1	0.64	$\pm 1.6$	
Liquid Permittivity Target tolerance	$\pm 5.0$	Rectangular	$\sqrt{3}$	0.6	$\pm 1.7$	
Liquid Permittivity measurement uncertainty	$\pm 2.0$	Normal	1	0.6	$\pm 1.2$	
Combined standard uncertainty					$\pm 10.3$	330
<b>Coverage Factor for 95 %</b>		<b>K=2</b>				
<b>Expanded uncertainty (Coverage factor = 2)</b>					<b><math>\pm 20.6</math></b>	

Table 7.2 Uncertainty Budget of DASY



## **8. SAR Measurement Evaluation**

Each DASY system is equipped with one or more system validation kits. These units, together with the predefined measurement procedures within the DASY software, enable the user to conduct the system performance check and system validation. System validation kit includes a dipole, tripod holder to fix it underneath the flat phantom and a corresponding distance holder.

### **8.1 Purpose of System Performance check**

The system performance check verifies that the system operates within its specifications. System and operator errors can be detected and corrected. It is recommended that the system performance check be performed prior to any usage of the system in order to guarantee reproducible results. The system performance check uses normal SAR measurements in a simplified setup with a well characterized source. This setup was selected to give a high sensitivity to all parameters that might fail or vary over time. The system check does not intend to replace the calibration of the components, but indicates situations where the system uncertainty is exceeded due to drift or failure.

### **8.2 System Setup**

In the simplified setup for system evaluation, the DUT is replaced by a calibrated dipole and the power source is replaced by a continuous wave which comes from a signal generator at frequency 1900 MHz. The calibrated dipole must be placed beneath the flat phantom section of the SAM twin phantom with the correct distance holder. The distance holder should touch the phantom surface with a light pressure at the reference marking and be oriented parallel to the long side of the phantom. The equipment setup is shown below:

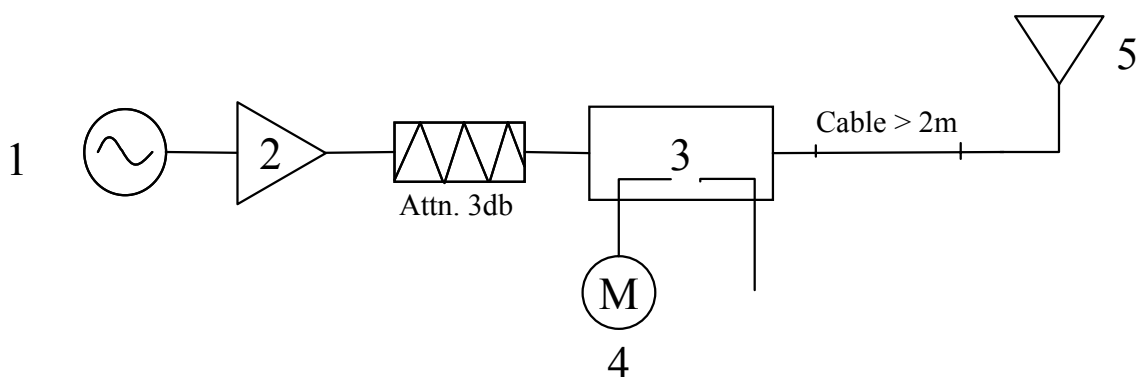

**Fig. 8.1**



1. Signal Generator
2. Amplifier
3. Directional Coupler
4. Power Meter
5. 1900 MHz Dipole

The output power on dipole port must be calibrated to 20dBm (100mW) before dipole is connected.



**Fig 8.2 Dipole Setup**



**8.3 Validation Results**

Comparing to the original SAR value provided by Speag, the validation data should be within its specification of 10 %. Table 8.1 shows the target SAR and measured SAR after normalized to 1W input power.

		<b>Target (W/kg)</b>	<b>Measurement data (W/kg)</b>	<b>Variation</b>	<b>Measurement Date</b>
PCS band (1900MHz) for head	SAR (1g)	38.4	39.5	2.9 %	Aug. 23, 2006
	SAR (10g)	20.5	21.2	3.4 %	
PCS band (1900MHz) for body	SAR (1g)	41.1	40.6	-1.2 %	Aug. 23, 2006
	SAR (10g)	21.8	21.5	-1.4 %	

**Table 8.1**

The table above indicates the system performance check can meet the variation criterion.



---

## **9. Description for DUT Testing Position**

This DUT was tested in 6 different positions. They are left cheek, left tilted, right cheek, right tilted, body worn with keypad up and body worn with keypad down as illustrated below:

- 1) “Cheek Position”
  - i) To position the device with the vertical center line of the body of the device and the horizontal line crossing the center piece in a plane parallel to the sagittal plane of the phantom. While maintaining the device in this plane, align the vertical center line with the reference plane containing the three ear and mouth reference point (M, RE and LE) and align the center of the ear piece with the line RE-LE.
  - ii) To move the device towards the phantom with the ear piece aligned with the line LE-RE until the phone touched the ear. While maintaining the device in the reference plane and maintaining the phone contact with the ear, move the bottom of the phone until any point on the front side is in contact with the cheek of the phantom or until contact with the ear is lost (see Fig. 9.1).
- 2) “Tilted Position”
  - i) To position the device in the “cheek” position described above.
  - ii) While maintaining the device the reference plane described above and pivoting against the ear, move it outward away from the mouth by an angle of 15 degrees or until contact with the ear is lost (see Fig. 9.2).
- 3) “Body Worn”
  - i) To position the device parallel to the phantom surface.
  - ii) To adjust the phone parallel to the flat phantom.
  - iii) To adjust the distance between the DUT surface and the flat phantom to 1.5 cm.

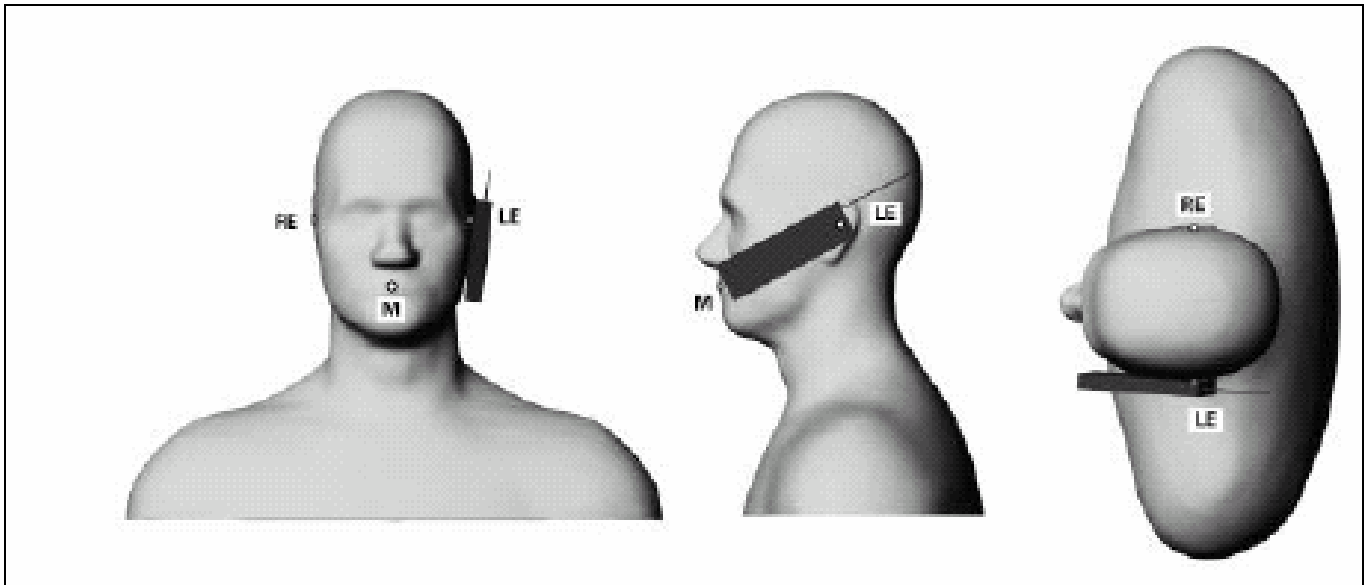

**Fig. 9.1 Phone Position 1, “Cheek” or “Touch” Position.** The reference points for the right ear (RE), left ear (LE) and mouth (M), which define the plane for phone positioning, are indicated.

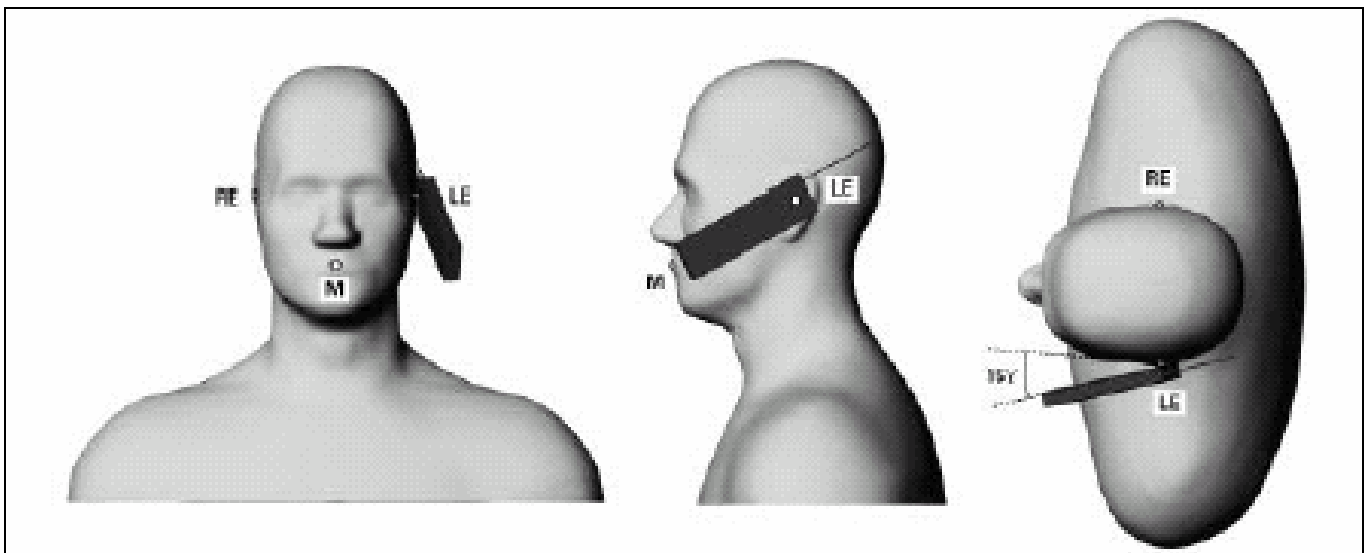

**Fig. 9.2 Phone Position 2, “Tilted Position”.** The reference point for the right ear (RE), left ear (LE) and mouth (M), which define the plane for phone positioning, are indicated.

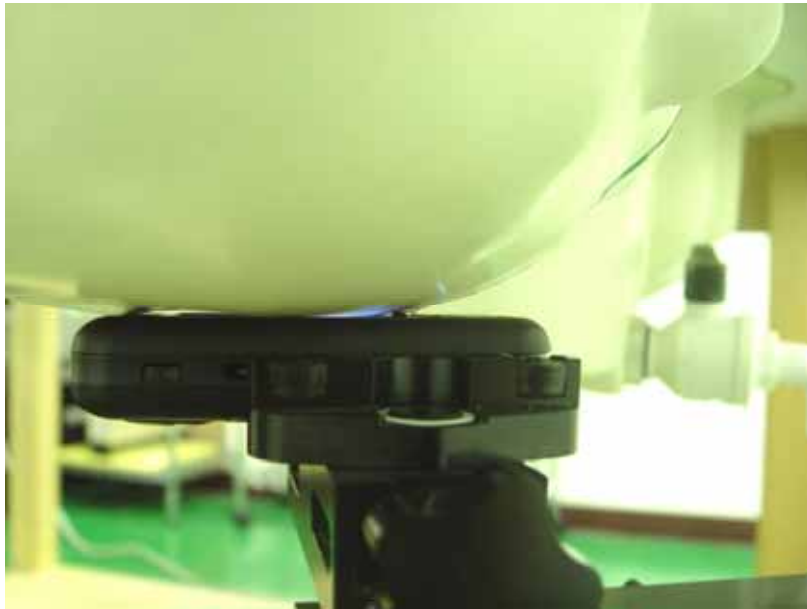

**Fig. 9.3 Right Cheek in Close Mode**

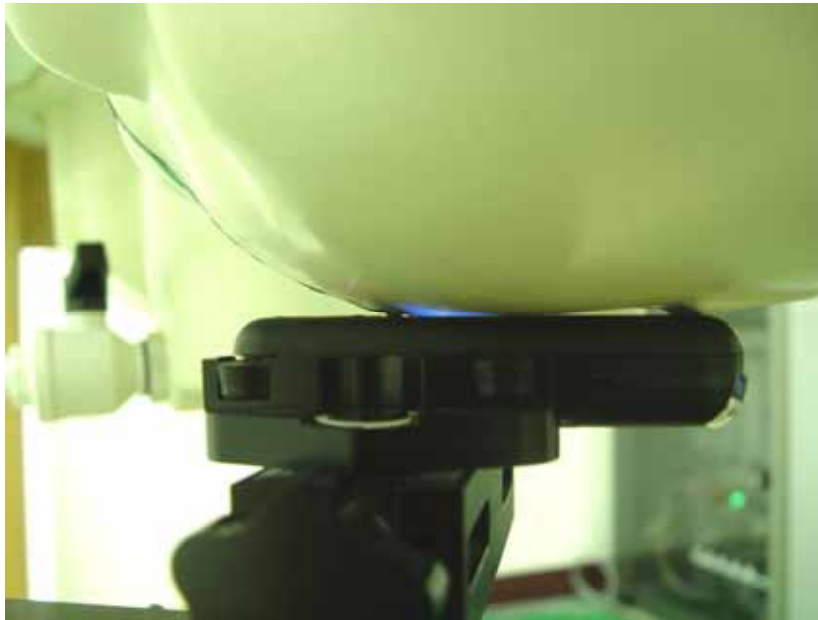

**Fig. 9.4 Right Tilted in Close Mode**

**Fig. 9.5 Left Cheek in Close Mode****Fig. 9.6 Left Tilted in Close Mode**

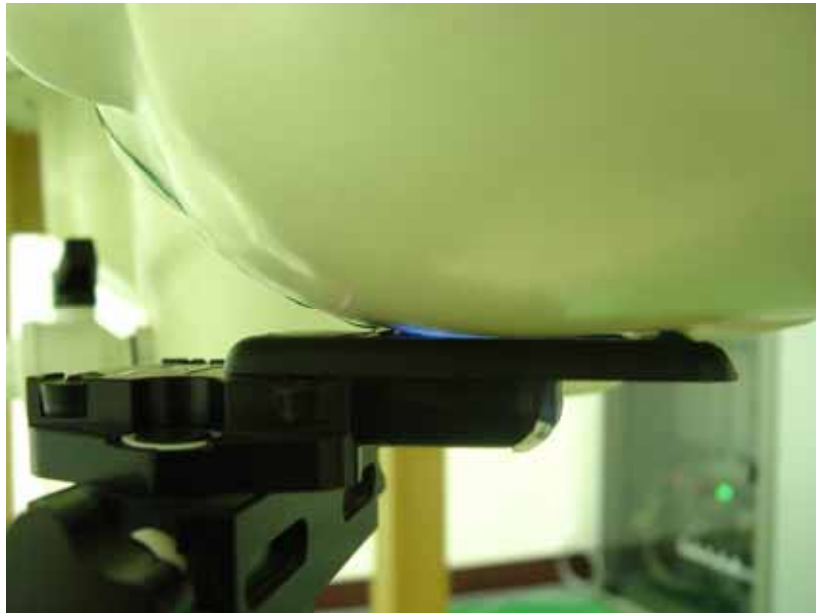

**Fig. 9.7 Right Cheek in Open Mode**



**Fig. 9.8 Right Tilted in Open Mode**





**Fig. 9.9 Left Cheek in Open Mode**



**Fig. 9.10 Left Tilted in Open Mode**



**Fig. 9.11 Keypad Up with 1.5cm Gap**



**Fig. 9.12 Keypad Down with 1.5cm Gap**



## **10. Measurement Procedures**

The measurement procedures are as follows:

- Linking DUT with base station emulator CMU200 in middle channel for PCS1900 band
- Setting PCL=0 for PCS on CMU200 to allow DUT to radiate maximum output power
- Measuring output power through RF cable and power meter
- Placing the DUT in the positions described in the last section
- Setting scan area, grid size and other setting on the DASY4 software
- Taking data for the lowest, middle, and highest channel on each testing position

According to the IEEE P1528 draft standard, the recommended procedure for assessing the peak spatial-average SAR value consists of the following steps:

- Power reference measurement
- Area scan
- Zoom scan
- Power reference measurement

### **10.1 Spatial Peak SAR Evaluation**

The procedure for spatial peak SAR evaluation has been implemented according to the IEEE1528-2003 standard. It can be conducted for 1g and 10g, as well as for user-specific masses. The DASY4 software includes all numerical procedures necessary to evaluate the spatial peak SAR value.

Base on the Draft: SCC-34, SC-2, WG-2-Computational Dosimetry, IEEE P1528/D1.2 (Recommended Practice for Determining the Peak Spatial-Average Specific Absorption Rate (SAR) in the Human Head from Wireless Communications Devices: Measurement Techniques), a new algorithm has been implemented. The spatial-peak SAR can be computed over any required mass.

The base for the evaluation is a "cube" measurement. The measured volume must include the 1g and 10g cubes with the highest averaged SAR values. For that purpose , the center of the measured volume is aligned to the interpolated peak SAR value of a previously performed area scan.

The entire evaluation of the spatial peak values is performed within the postprocessing engine (SEMCAD). The system always gives the maximum values for the 1g and 10g cubes. The algorithm to find the cube with highest averaged SAR is divided into the following stages:



- 
- extraction of the measured data (grid and values) from the Zoom Scan
  - calculation of the SAR value at every measurement point based on all stored data (A/D values and measurement parameters)
  - generation of a high-resolution mesh within the measured volume
  
  - interpolation of all measured values from the measurement grid to the high-resolution grid
  - extrapolation of the entire 3-D field distribution to the phantom surface over the distance from sensor to surface
  - calculation of the averaged SAR within masses of 1g and 10g

### ***10.2 Scan Procedures***

First **Area Scan** is used to locate the approximate location(s) of the local peak SAR value(s). The measurement grid within an **Area Scan** is defined by the grid extent, grid step size and grid offset. Next, in order to determine the EM field distribution in a three-dimensional spatial extension, **Zoom Scan** is required. The **Zoom Scan** measures 5x5x7 points with step size 8, 8 and 5 mm. The **Zoom Scan** is performed around the highest E-field value to determine the averaged SAR-distribution over 1 g.

### ***10.3 SAR Averaged Methods***

In DASy4, the interpolation and extrapolation are both based on the modified Quadratic Shepard's method. The interpolation scheme combines a least-square fitted function method and a weighted average method which are the two basic types of computational interpolation and approximation.

Extrapolation routines are used to obtain SAR values between the lowest measurement points and the inner phantom surface. The extrapolation distance is determined by the surface detection distance and the probe sensor offset. The uncertainty increases with the extrapolation distance. To keep the uncertainty within 1% for the 1 g and 10 g cubes, the extrapolation distance should not be larger than 5 mm.



## 11. SAR Test Results

### 11.1 Right Cheek in Close Mode

Bands	Chan.	Freq. (MHz)	Modulation type	Conducted Power (dBm)	Power Drift (dB)	Measured 1g SAR (W/kg)	Limits (W/Kg)	Results
PCS	512 (Low)	1710.2	GMSK	29.62	-0.041	0.224	1.6	Pass
	661 (Mid)	1747.6	GMSK	29.70	-0.113	0.19	1.6	Pass
	810 (High)	1784.8	GMSK	29.66	-0.042	0.131	1.6	Pass
PCS with BT On	512(Low)	1710.2	GMSK	29.62	0.015	0.216	1.6	Pass

### 11.2 Right Tilted in Close Mode

Bands	Chan.	Freq. (MHz)	Modulation type	Conducted Power (dBm)	Power Drift (dB)	Measured 1g SAR (W/kg)	Limits (W/Kg)	Results
PCS	512 (Low)	1710.2	GMSK	29.62	-	-	-	-
	661 (Mid)	1747.6	GMSK	29.70	0.004	0.181	1.6	Pass
	810 (High)	1784.8	GMSK	29.66	-	-	-	-

### 11.3 Left Cheek in Close Mode

Bands	Chan.	Freq. (MHz)	Modulation type	Conducted Power (dBm)	Power Drift (dB)	Measured 1g SAR (W/kg)	Limits (W/Kg)	Results
PCS	512 (Low)	1710.2	GMSK	29.62	-	-	-	-
	611(Mid)	1747.6	GMSK	29.70	-0.052	0.124	1.6	Pass
	810 (High)	1784.8	GMSK	29.66	-	-	-	-

### 11.4 Left Titled in Close Mode

Bands	Chan.	Freq. (MHz)	Modulation type	Conducted Power (dBm)	Power Drift (dB)	Measured 1g SAR (W/kg)	Limits (W/Kg)	Results
PCS	512 (Low)	1710.2	GMSK	29.62	-	-	-	-
	611(Mid)	1747.6	GMSK	29.70	-0.124	0.151	2.0	Pass
	810 (High)	1784.8	GMSK	29.66	-	-	-	-

### 11.5 Right Cheek in Open Mode

Bands	Chan.	Freq. (MHz)	Modulation type	Conducted Power (dBm)	Power Drift (dB)	Measured 1g SAR (W/kg)	Limits (W/Kg)	Results
PCS	512 (Low)	1710.2	GMSK	29.62	-	-	-	-
	611(Mid)	1747.6	GMSK	29.70	-0.096	0.093	1.6	Pass
	810 (High)	1784.8	GMSK	29.66	-	-	-	-

### 11.6 Right Tilted in Open Mode

Bands	Chan.	Freq. (MHz)	Modulation type	Conducted Power (dBm)	Power Drift (dB)	Measured 1g SAR (W/kg)	Limits (W/Kg)	Results
PCS	512 (Low)	1710.2	GMSK	29.62	-	-	-	-
	611(Mid)	1747.6	GMSK	29.70	-0.061	0.066	1.6	Pass
	810 (High)	1784.8	GMSK	29.66	-	-	-	-



**11.7 Left Cheek in Open Mode**

Bands	Chan.	Freq. (MHz)	Modulation type	Conducted Power (dBm)	Power Drift (dB)	Measured 1g SAR (W/kg)	Limits (W/Kg)	Results
PCS	512 (Low)	1710.2	GMSK	29.62	-	-	-	-
	611(Mid)	1747.6	GMSK	29.70	-0.09	0.057	1.6	Pass
	810 (High)	1784.8	GMSK	29.66	-	-	-	-

**11.8 Left Tilted in Open Mode**

Bands	Chan.	Freq. (MHz)	Modulation type	Conducted Power (dBm)	Power Drift (dB)	Measured 1g SAR (W/kg)	Limits (W/Kg)	Results
PCS	512 (Low)	1710.2	GMSK	29.62	-	-	-	-
	611(Mid)	1747.6	GMSK	29.70	-0.076	0.073	1.6	Pass
	810 (High)	1784.8	GMSK	29.66	-	-	-	-

**11.9 Keypad Up with 1.5cm Gap**

Bands	Chan.	Freq. (MHz)	Modulation type	Conducted Power (dBm)	Power Drift (dB)	Measured 1g SAR (W/kg)	Limits (W/Kg)	Results
PCS	512 (Low)	1710.2	GMSK	29.62	-	-	-	-
	611(Mid)	1747.6	GMSK	29.70	-0.134	0.082	1.6	Pass
	810 (High)	1784.8	GMSK	29.66	-	-	-	-

**11.10 Keypad Down with 1.5cm Gap**

Bands	Chan.	Freq. (MHz)	Modulation type	Conducted Power (dBm)	Power Drift (dB)	Measured 1g SAR (W/kg)	Limits (W/Kg)	Results
PCS	<b>512 (Low)</b>	<b>1710.2</b>	<b>GMSK</b>	<b>29.62</b>	<b>-0.081</b>	<b>0.786</b>	<b>1.6</b>	<b>Pass</b>
	611(Mid)	1747.6	GMSK	29.70	-0.052	0.584	1.6	Pass
	810 (High)	1784.8	GMSK	29.66	-0.096	0.457	1.6	Pass
PCS with BT On	512 (Low)	1710.2	GMSK	29.62	-0.054	0.761	1.6	Pass

Remark : Software ensures that GSM and WLAN can not transmit simultaneously.

Test Engineer : John Tsai and Gordon Lin



---

## **12. References**

- [1] FCC 47 CFR Part 2 “Frequency Allocations and Radio Treaty Matters; General Rules and Regulations”
- [2] IEEE Std. P1528-2003, “Recommended Practice for Determining the Peak Spatial-Average Specific Absorption Rate (SAR) in the Human Head from Wireless Communications Devices: Measurement Techniques”, April 21, 2003
- [3] Supplement C (Edition 01-01) to OET Bulletin 65 (Edition 97-01), “Additional Information for Evaluating Compliance of Mobile and Portable Devices with FCC Limits for Human Exposure to RF Emissions”, June 2001
- [4] IEEE Std. C95.3-2002, “IEEE Recommended Practice for the Measurement of Potentially Hazardous Electromagnetic Fields-RF and Microwave”, 2002
- [5] IEEE Std. C95.1-1999, “IEEE Standard for Safety Levels with Respect to Human Exposure to Radio Frequency Electromagnetic Fields, 3 kHz to 300 GHz”, 1999
- [6] Robert J. Renka, “Multivariate Interpolation Of Large Sets Of Scattered Data”, University of Noth Texas ACM Transactions on Mathematical Software, vol. 14, no. 2, June 1988, pp. 139-148
- [7] DAYS4 System Handbook



### Appendix A - System Performance Check Data

Test Laboratory: Sporton International Inc. SAR Testing Lab

Date/Time: 8/23/2006 3:32:24 PM

#### System Check\_Head\_1900MHz\_20060823

**DUT: Dipole 1900 MHz; Type: D1900V2; Serial: D1900V2 - SN:5d041**

Communication System: CW; Frequency: 1900 MHz; Duty Cycle: 1:1

Medium: HSL\_1900 Medium parameters used:  $f = 1900$  MHz;  $\sigma = 1.46$  mho/m;  $\epsilon_r = 41.2$ ;  $\rho = 1000$  kg/m<sup>3</sup>

Ambient Temperature : 23.8 °C; Liquid Temperature : 22.7 °C

DASY4 Configuration:

- Probe: ET3DV6 - SN1787; ConvF(5.26, 5.26, 5.26); Calibrated: 5/31/2006
- Sensor-Surface: 4mm (Mechanical And Optical Surface Detection) Sensor-Surface: 4mm (Mechanical Surface Detection)
- Electronics: DAE3 Sn577; Calibrated: 11/11/2005
- Phantom: SAM-B; Type: QD 000 P40 C; Serial: TP-1383
- Measurement SW: DASY4, V4.6 Build 23; Postprocessing SW: SEMCAD, V1.8 Build 161

**Pin=100mW/Area Scan (91x91x1):** Measurement grid: dx=10mm, dy=10mm

Maximum value of SAR (interpolated) = 4.56 mW/g

**Pin=100mW/Zoom Scan (7x7x7)/Cube 0:** Measurement grid: dx=5mm, dy=5mm, dz=5mm

Reference Value = 59.0 V/m; Power Drift = 0.018 dB

Peak SAR (extrapolated) = 6.58 W/kg

**SAR(1 g) = 3.95 mW/g; SAR(10 g) = 2.12 mW/g**

Maximum value of SAR (measured) = 4.49 mW/g

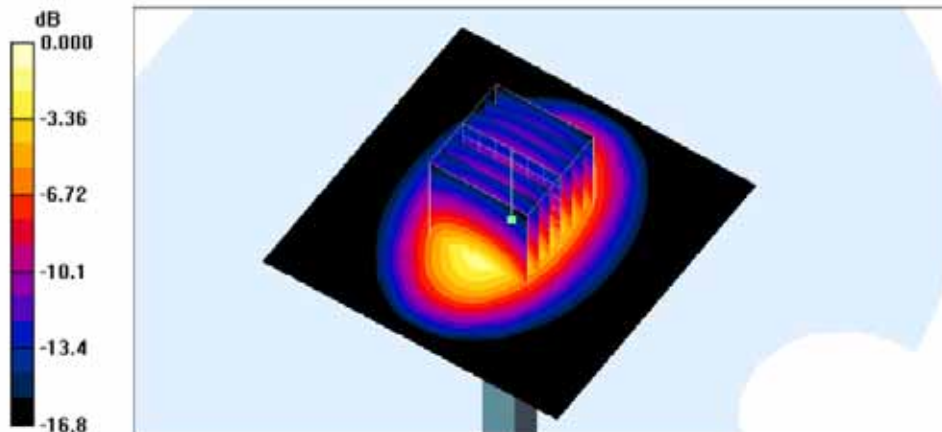





Test Laboratory: Sporton International Inc. SAR Testing Lab

Date/Time: 8/23/2006 8:38:56 PM

**System Check\_Body\_1900MHz\_20060823**

**DUT: Dipole 1900 MHz; Type: D1900V2; Serial: D1900V2 - SN:5d041**

Communication System: CW; Frequency: 1900 MHz; Duty Cycle: 1:1

Medium: MSL\_1900 Medium parameters used:  $f = 1900$  MHz;  $\sigma = 1.54$  mho/m;  $\epsilon_r = 51.9$ ;  $\rho = 1000$  kg/m<sup>3</sup>

Ambient Temperature : 23.9 °C; Liquid Temperature : 22.2 °C

**DASY4 Configuration:**

- Probe: ET3DV6 - SN1787; ConvF(4.66, 4.66, 4.66); Calibrated: 5/31/2006
- Sensor-Surface: 4mm (Mechanical And Optical Surface Detection) Sensor-Surface: 4mm (Mechanical Surface Detection)
- Electronics: DAE3 Sn577; Calibrated: 11/11/2005
- Phantom: SAM-B; Type: QD 000 P40 C; Serial: TP-1383
- Measurement SW: DASY4, V4.6 Build 23; Postprocessing SW: SEMCAD, V1.8 Build 161

**Pin=100mW/Area Scan (91x91x1):** Measurement grid: dx=10mm, dy=10mm

Maximum value of SAR (interpolated) = 4.75 mW/g

**Pin=100mW/Zoom Scan (7x7x7)/Cube 0:** Measurement grid: dx=5mm, dy=5mm, dz=5mm

Reference Value = 52.2 V/m; Power Drift = -0.010 dB

Peak SAR (extrapolated) = 6.92 W/kg

SAR(1 g) = 4.06 mW/g; SAR(10 g) = 2.15 mW/g

Maximum value of SAR (measured) = 4.62 mW/g

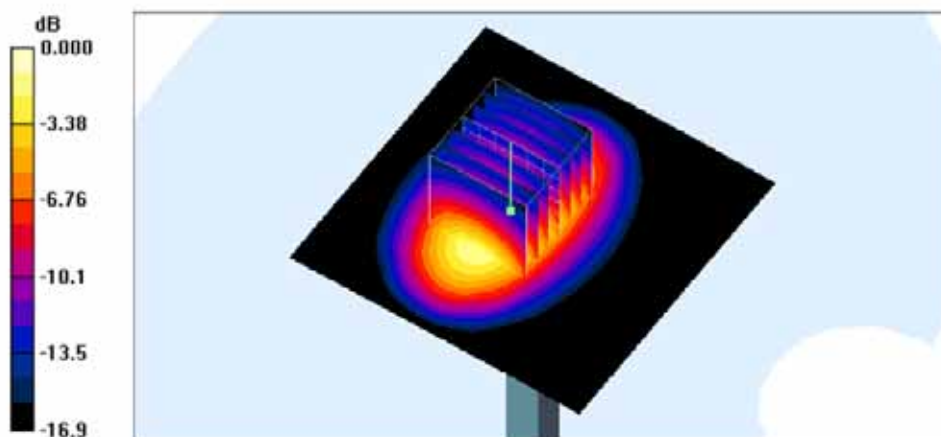



### Appendix B - SAR Measurement Data

Test Laboratory: Sporton International Inc. SAR Testing Lab

Date/Time: 8/23/2006 7:28:46 PM

#### Right Cheek\_PCS Ch512\_20060823\_Close Mode

DUT: 681418; Type: Smart Phone

Communication System: PCS; Frequency: 1850.2 MHz; Duty Cycle: 1:8.3

Medium: HSL\_1900 Medium parameters used :  $f = 1850.2$  MHz;  $\sigma = 1.43$  mho/m;  $\epsilon_r = 41.6$ ;  $\rho = 1000$  kg/m<sup>3</sup>

Ambient Temperature : 23.4 °C; Liquid Temperature : 22.7 °C

DASY4 Configuration:

- Probe: ET3DV6 - SN1787; ConvF(5.26, 5.26, 5.26); Calibrated: 5/31/2006
- Sensor-Surface: 4mm (Mechanical And Optical Surface Detection)
- Electronics: DAE3 Sn577; Calibrated: 11/11/2005
- Phantom: SAM-B; Type: QD 000 P40 C; Serial: TP-1383
- Measurement SW: DASY4, V4.6 Build 23; Postprocessing SW: SEMCAD, V1.8 Build 161

Ch512/Area Scan (51x91x1): Measurement grid: dx=15mm, dy=15mm

Maximum value of SAR (interpolated) = 0.265 mW/g

Ch512/Zoom Scan (5x5x7)/Cube 0: Measurement grid: dx=8mm, dy=8mm, dz=5mm

Reference Value = 9.76 V/m; Power Drift = -0.041 dB

Peak SAR (extrapolated) = 0.366 W/kg

SAR(1 g) = 0.224 mW/g; SAR(10 g) = 0.128 mW/g

Maximum value of SAR (measured) = 0.246 mW/g

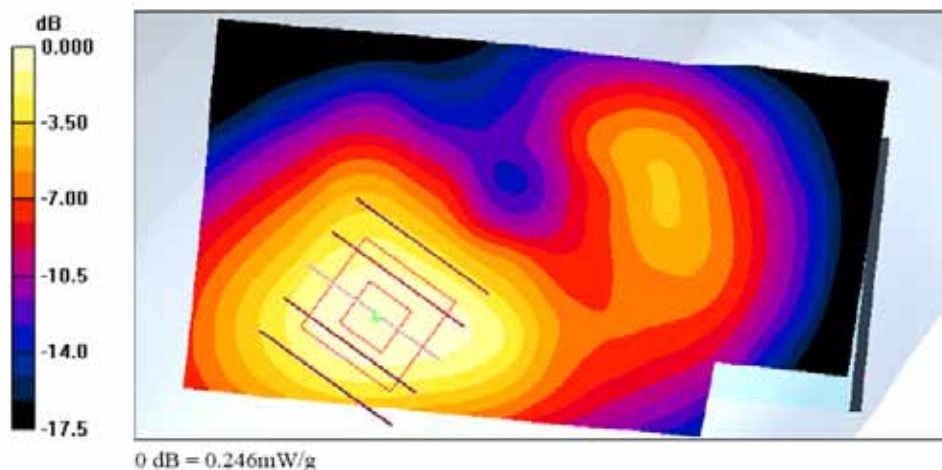



Test Laboratory: Sporton International Inc. SAR Testing Lab

Date/Time: 8/23/2006 8:05:36 PM

**Right Cheek\_PCS Ch512\_20060823\_Close Mode\_Bluetooth On**

**DUT: 681418; Type: Smart Phone**

Communication System: PCS; Frequency: 1850.2 MHz; Duty Cycle: 1:8.3

Medium: HSL\_1900 Medium parameters used :  $f = 1850.2$  MHz;  $\sigma = 1.43$  mho/m;  $\epsilon_r = 41.6$ ;  $\rho = 1000$  kg/m<sup>3</sup>

Ambient Temperature : 23.5 °C; Liquid Temperature : 22.7 °C

DASY4 Configuration:

- Probe: ET3DV6 - SN1787; ConvF(5.26, 5.26, 5.26); Calibrated: 5/31/2006
- Sensor-Surface: 4mm (Mechanical And Optical Surface Detection)
- Electronics: DAE3 Sn577; Calibrated: 11/11/2005
- Phantom: SAM-B; Type: QD 000 P40 C; Serial: TP-1383
- Measurement SW: DASY4, V4.6 Build 23; Postprocessing SW: SEMCAD, V1.8 Build 161

**Ch512/Area Scan (51x91x1):** Measurement grid: dx=15mm, dy=15mm

Maximum value of SAR (interpolated) = 0.249 mW/g

**Ch512/Zoom Scan (5x5x7)/Cube 0:** Measurement grid: dx=8mm, dy=8mm, dz=5mm

Reference Value = 9.21 V/m; Power Drift = 0.015 dB

Peak SAR (extrapolated) = 0.362 W/kg

SAR(1 g) = 0.216 mW/g; SAR(10 g) = 0.121 mW/g

Maximum value of SAR (measured) = 0.236 mW/g

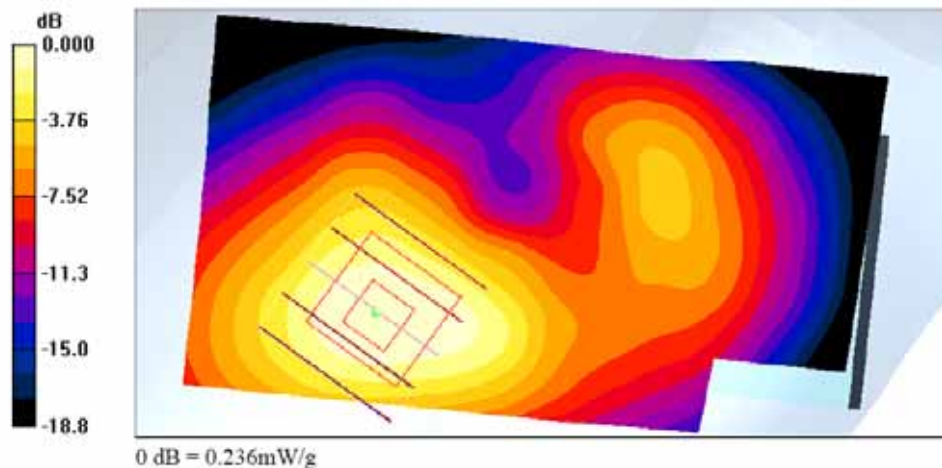



Test Laboratory: Sporton International Inc. SAR Testing Lab

Date/Time: 8/23/2006 4:20:11 PM

**Right Tilted\_PCS Ch661\_20060823\_Close Mode**

**DUT: 681418; Type: Smart Phone**

Communication System: PCS; Frequency: 1880 MHz; Duty Cycle: 1:8.3

Medium: HSL\_1900 Medium parameters used:  $f = 1880$  MHz;  $\sigma = 1.45$  mho/m;  $\epsilon_r = 41.5$ ;  $\rho = 1000$  kg/m<sup>3</sup>

Ambient Temperature : 23.8 °C; Liquid Temperature : 22.7 °C

DASY4 Configuration:

- Probe: ET3DV6 - SN1787; ConvF(5.26, 5.26, 5.26); Calibrated: 5/31/2006
- Sensor-Surface: 4mm (Mechanical And Optical Surface Detection)
- Electronics: DAE3 Sn577; Calibrated: 11/11/2005
- Phantom: SAM-B; Type: QD 000 P40 C; Serial: TP-1383
- Measurement SW: DASY4, V4.6 Build 23; Postprocessing SW: SEMCAD, V1.8 Build 161

**Ch661/Area Scan (51x91x1):** Measurement grid: dx=15mm, dy=15mm

Maximum value of SAR (interpolated) = 0.209 mW/g

**Ch661/Zoom Scan (5x5x7)/Cube 0:** Measurement grid: dx=8mm, dy=8mm, dz=5mm

Reference Value = 10.7 V/m; Power Drift = 0.004 dB

Peak SAR (extrapolated) = 0.278 W/kg

**SAR(1 g) = 0.181 mW/g; SAR(10 g) = 0.107 mW/g**

Maximum value of SAR (measured) = 0.197 mW/g

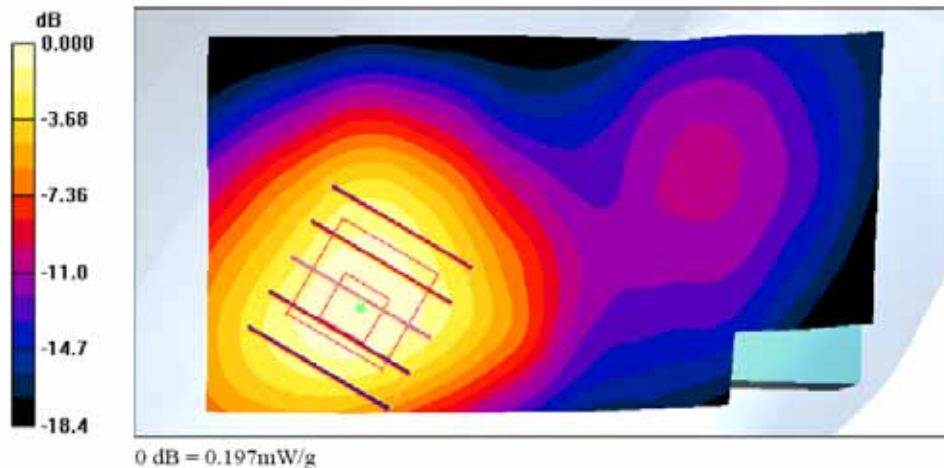



Test Laboratory: Sporton International Inc. SAR Testing Lab

Date/Time: 8/23/2006 4:40:36 PM

**Left Cheek\_PCS Ch661\_20060823\_Close Mode**

**DUT: 681418; Type: Smart Phone**

Communication System: PCS; Frequency: 1880 MHz; Duty Cycle: 1:8.3

Medium: HSL\_1900 Medium parameters used:  $f = 1880$  MHz;  $\sigma = 1.45$  mho/m;  $\epsilon_r = 41.5$ ;  $\rho = 1000$  kg/m<sup>3</sup>

Ambient Temperature : 23.8 °C; Liquid Temperature : 22.7 °C

DASY4 Configuration:

- Probe: ET3DV6 - SN1787; ConvF(5.26, 5.26, 5.26); Calibrated: 5/31/2006
- Sensor-Surface: 4mm (Mechanical And Optical Surface Detection)
- Electronics: DAE3 Sn577; Calibrated: 11/11/2005
- Phantom: SAM-B; Type: QD 000 P40 C; Serial: TP-1383
- Measurement SW: DASY4, V4.6 Build 23; Postprocessing SW: SEMCAD, V1.8 Build 161

**Ch661/Area Scan (51x91x1):** Measurement grid: dx=15mm, dy=15mm

Maximum value of SAR (interpolated) = 0.136 mW/g

**Ch661/Zoom Scan (5x5x7)/Cube 0:** Measurement grid: dx=8mm, dy=8mm, dz=5mm

Reference Value = 8.94 V/m; Power Drift = -0.052 dB

Peak SAR (extrapolated) = 0.183 W/kg

SAR(1 g) = 0.124 mW/g; SAR(10 g) = 0.076 mW/g

Maximum value of SAR (measured) = 0.136 mW/g

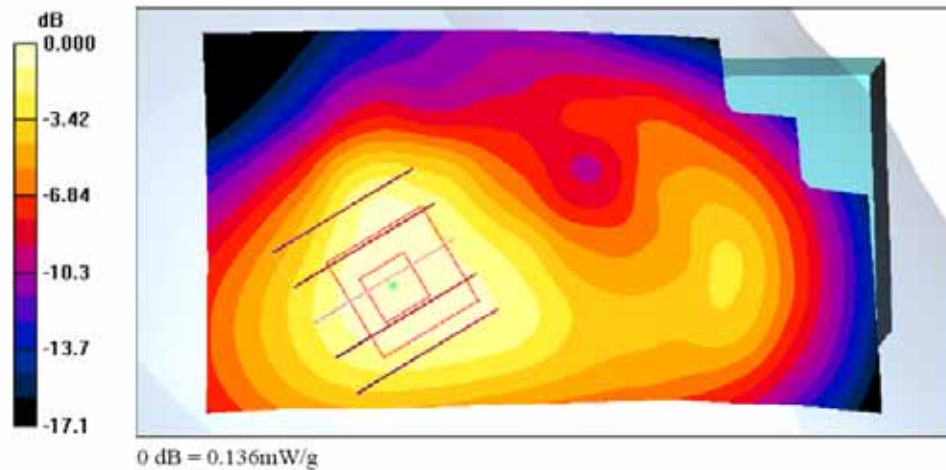



Test Laboratory: Sporton International Inc. SAR Testing Lab

Date/Time: 8/23/2006 4:54:44 PM

**Left Tilted\_PCS Ch661\_20060823\_Close Mode**

**DUT: 681418; Type: Smart Phone**

Communication System: PCS; Frequency: 1880 MHz; Duty Cycle: 1:8.3

Medium: HSL\_1900 Medium parameters used:  $f = 1880$  MHz;  $\sigma = 1.45$  mho/m;  $\epsilon_r = 41.5$ ;  $\rho = 1000$  kg/m<sup>3</sup>

Ambient Temperature : 23.9 °C; Liquid Temperature : 22.7 °C

DASY4 Configuration:

- Probe: ET3DV6 - SN1787; ConvF(5.26, 5.26, 5.26); Calibrated: 5/31/2006
- Sensor-Surface: 4mm (Mechanical And Optical Surface Detection)
- Electronics: DAE3 Sn577; Calibrated: 11/11/2005
- Phantom: SAM-B; Type: QD 000 P40 C; Serial: TP-1383
- Measurement SW: DASY4, V4.6 Build 23; Postprocessing SW: SEMCAD, V1.8 Build 161

**Ch661/Area Scan (51x91x1):** Measurement grid: dx=15mm, dy=15mm

Maximum value of SAR (interpolated) = 0.170 mW/g

**Ch661/Zoom Scan (5x5x7)/Cube 0:** Measurement grid: dx=8mm, dy=8mm, dz=5mm

Reference Value = 10.8 V/m; Power Drift = -0.124 dB

Peak SAR (extrapolated) = 0.213 W/kg

**SAR(1 g) = 0.151 mW/g; SAR(10 g) = 0.093 mW/g**

Maximum value of SAR (measured) = 0.165 mW/g

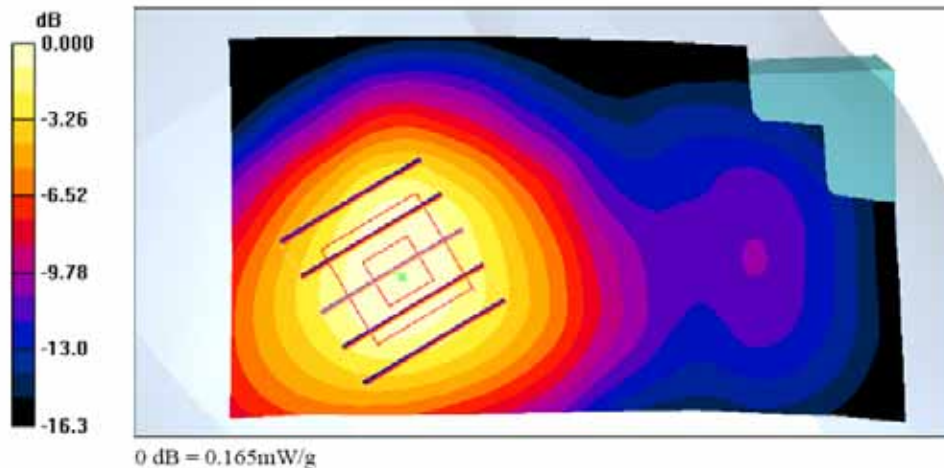



Test Laboratory: Sporton International Inc. SAR Testing Lab

Date/Time: 8/23/2006 6:49:09 PM

**Right Cheek\_PCS Ch661\_20060823\_Open Mode**

**DUT: 681418; Type: Smart Phone**

Communication System: PCS; Frequency: 1880 MHz; Duty Cycle: 1:8.3

Medium: HSL\_1900 Medium parameters used:  $f = 1880$  MHz;  $\sigma = 1.45$  mho/m;  $\epsilon_r = 41.5$ ;  $\rho = 1000$  kg/m<sup>3</sup>

Ambient Temperature : 23.3 °C; Liquid Temperature : 22.7 °C

DASY4 Configuration:

- Probe: ET3DV6 - SN1787; ConvF(5.26, 5.26, 5.26); Calibrated: 5/31/2006
- Sensor-Surface: 4mm (Mechanical And Optical Surface Detection)
- Electronics: DAE3 Sn577; Calibrated: 11/11/2005
- Phantom: SAM-B; Type: QD 000 P40 C; Serial: TP-1383
- Measurement SW: DASY4, V4.6 Build 23; Postprocessing SW: SEMCAD, V1.8 Build 161

**Ch661/Area Scan (61x111x1):** Measurement grid: dx=15mm, dy=15mm

Maximum value of SAR (interpolated) = 0.105 mW/g

**Ch661/Zoom Scan (5x5x7)/Cube 0:** Measurement grid: dx=8mm, dy=8mm, dz=5mm

Reference Value = 5.05 V/m; Power Drift = -0.096 dB

Peak SAR (extrapolated) = 0.162 W/kg

**SAR(1 g) = 0.093 mW/g; SAR(10 g) = 0.051 mW/g**

Maximum value of SAR (measured) = 0.103 mW/g

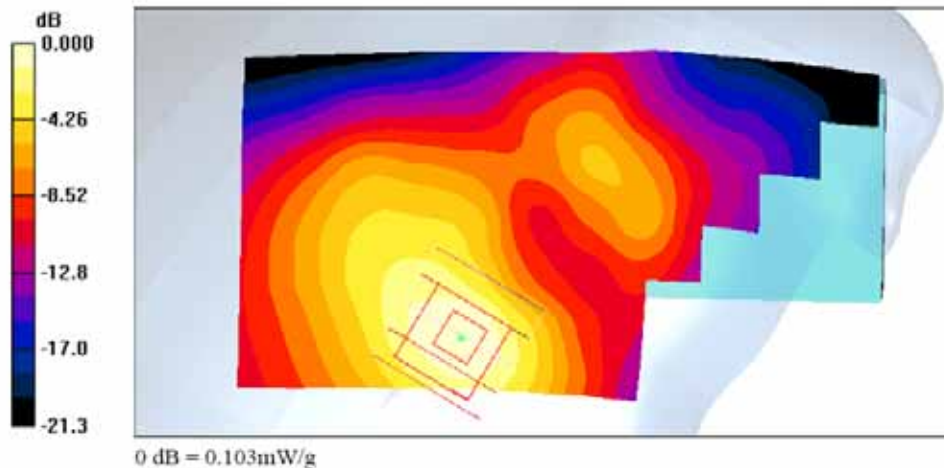



Test Laboratory: Sporton International Inc. SAR Testing Lab

Date/Time: 8/23/2006 7:06:50 PM

**Right Tilted\_PCS Ch661\_20060823\_Open Mode**

**DUT: 681418; Type: Smart Phone**

Communication System: PCS; Frequency: 1880 MHz; Duty Cycle: 1:8.3

Medium: HSL\_1900 Medium parameters used:  $f = 1880$  MHz;  $\sigma = 1.45$  mho/m;  $\epsilon_r = 41.5$ ;  $\rho = 1000$  kg/m<sup>3</sup>

Ambient Temperature : 23.4 °C; Liquid Temperature : 22.7 °C

DASY4 Configuration:

- Probe: ET3DV6 - SN1787; ConvF(5.26, 5.26, 5.26); Calibrated: 5/31/2006
- Sensor-Surface: 4mm (Mechanical And Optical Surface Detection)
- Electronics: DAE3 Sn577; Calibrated: 11/11/2005
- Phantom: SAM-B; Type: QD 000 P40 C; Serial: TP-1383
- Measurement SW: DASY4, V4.6 Build 23; Postprocessing SW: SEMCAD, V1.8 Build 161

**Ch661/Area Scan (61x111x1):** Measurement grid: dx=15mm, dy=15mm

Maximum value of SAR (interpolated) = 0.075 mW/g

**Ch661/Zoom Scan (5x5x7)/Cube 0:** Measurement grid: dx=8mm, dy=8mm, dz=5mm

Reference Value = 7.24 V/m; Power Drift = -0.061 dB

Peak SAR (extrapolated) = 0.099 W/kg

**SAR(1 g) = 0.066 mW/g; SAR(10 g) = 0.040 mW/g**

Maximum value of SAR (measured) = 0.071 mW/g

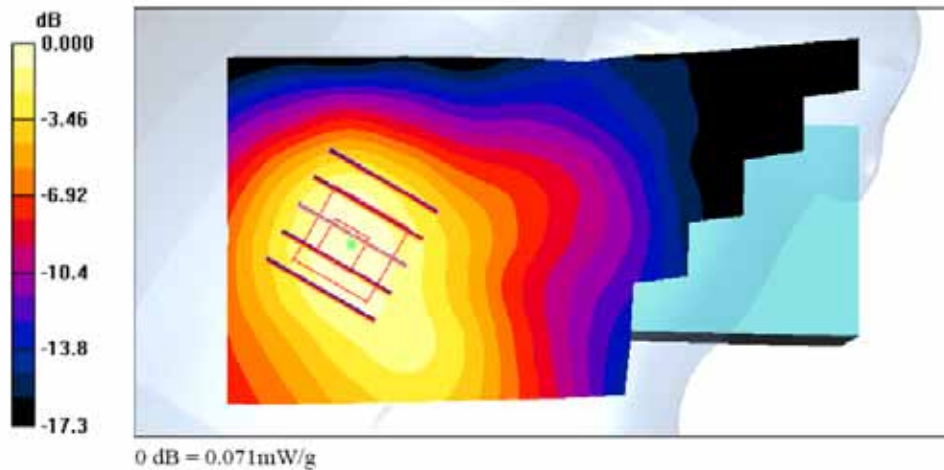





Test Laboratory: Sporton International Inc. SAR Testing Lab

Date/Time: 8/23/2006 5:44:53 PM

**Left Cheek\_PCS Ch661\_20060823\_Open Mode**

**DUT: 681418; Type: Smart Phone**

Communication System: PCS; Frequency: 1880 MHz; Duty Cycle: 1:8.3

Medium: HSL\_1900 Medium parameters used:  $f = 1880$  MHz;  $\sigma = 1.45$  mho/m;  $\epsilon_r = 41.5$ ;  $\rho = 1000$  kg/m<sup>3</sup>

Ambient Temperature : 23.4 °C; Liquid Temperature : 22.7 °C

DASY4 Configuration:

- Probe: ET3DV6 - SN1787; ConvF(5.26, 5.26, 5.26); Calibrated: 5/31/2006
- Sensor-Surface: 4mm (Mechanical And Optical Surface Detection)
- Electronics: DAE3 Sn577; Calibrated: 11/11/2005
- Phantom: SAM-B; Type: QD 000 P40 C; Serial: TP-1383
- Measurement SW: DASY4, V4.6 Build 23; Postprocessing SW: SEMCAD, V1.8 Build 161

**Ch661/Area Scan (61x111x1):** Measurement grid: dx=15mm, dy=15mm

Maximum value of SAR (interpolated) = 0.070 mW/g

**Ch661/Zoom Scan (5x5x7)/Cube 0:** Measurement grid: dx=8mm, dy=8mm, dz=5mm

Reference Value = 6.50 V/m; Power Drift = -0.090 dB

Peak SAR (extrapolated) = 0.083 W/kg

**SAR(1 g) = 0.057 mW/g; SAR(10 g) = 0.037 mW/g**

Maximum value of SAR (measured) = 0.061 mW/g

**Ch661/Zoom Scan (5x5x7)/Cube 1:** Measurement grid: dx=8mm, dy=8mm, dz=5mm

Reference Value = 6.50 V/m; Power Drift = -0.090 dB

Peak SAR (extrapolated) = 0.091 W/kg

**SAR(1 g) = 0.051 mW/g; SAR(10 g) = 0.028 mW/g**

Maximum value of SAR (measured) = 0.055 mW/g

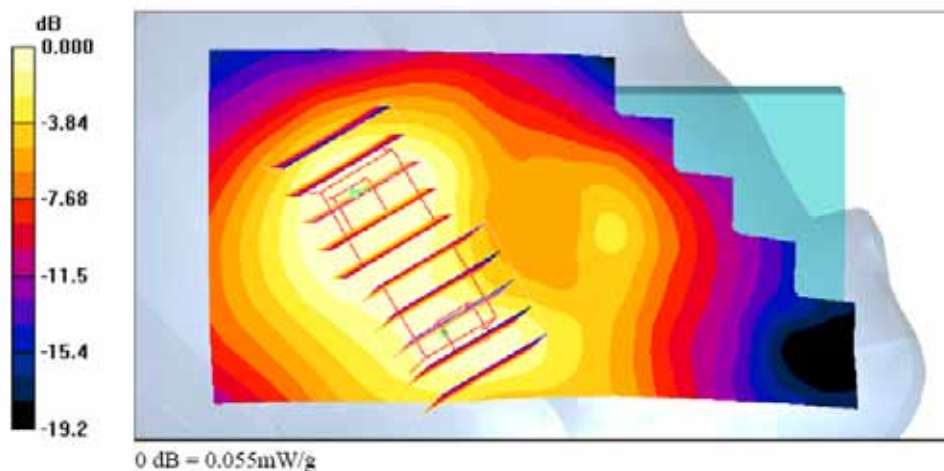



Test Laboratory: Sporton International Inc. SAR Testing Lab

Date/Time: 8/23/2006 6:07:33 PM

**Left Tilted\_PCS Ch661\_20060823\_Open Mode**

**DUT: 681418; Type: Smart Phone**

Communication System: PCS; Frequency: 1880 MHz; Duty Cycle: 1:8.3

Medium: HSL\_1900 Medium parameters used:  $f = 1880$  MHz;  $\sigma = 1.45$  mho/m;  $\epsilon_r = 41.5$ ;  $\rho = 1000$  kg/m<sup>3</sup>

Ambient Temperature : 23.6 °C; Liquid Temperature : 22.7 °C

DASY4 Configuration:

- Probe: ET3DV6 - SN1787; ConvF(5.26, 5.26, 5.26); Calibrated: 5/31/2006
- Sensor-Surface: 4mm (Mechanical And Optical Surface Detection)
- Electronics: DAE3 Sn577; Calibrated: 11/11/2005
- Phantom: SAM-B; Type: QD 000 P40 C; Serial: TP-1383
- Measurement SW: DASY4, V4.6 Build 23; Postprocessing SW: SEMCAD, V1.8 Build 161

**Ch661/Area Scan (61x111x1):** Measurement grid: dx=15mm, dy=15mm

Maximum value of SAR (interpolated) = 0.082 mW/g

**Ch661/Zoom Scan (5x5x7)/Cube 0:** Measurement grid: dx=8mm, dy=8mm, dz=5mm

Reference Value = 7.80 V/m; Power Drift = -0.076 dB

Peak SAR (extrapolated) = 0.108 W/kg

**SAR(1 g) = 0.073 mW/g; SAR(10 g) = 0.044 mW/g**

Maximum value of SAR (measured) = 0.080 mW/g

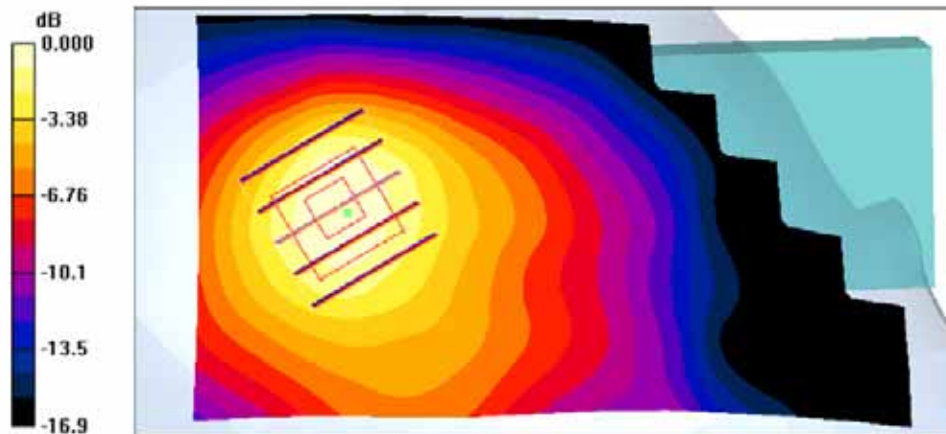

0 dB = 0.080mW/g



Test Laboratory: Sporton International Inc. SAR Testing Lab

Date/Time: 8/23/2006 9:55:13 PM

**Body\_PCS Ch661\_Keypad Up with 1.5cm Gap\_20060823**

**DUT: 681418; Type: Smart Phone**

Communication System: PCS; Frequency: 1880 MHz; Duty Cycle: 1:4

Medium: MSL\_1900 Medium parameters used:  $f = 1880$  MHz;  $\sigma = 1.52$  mho/m;  $\epsilon_r = 52$ ;  $\rho = 1000$  kg/m<sup>3</sup>

Ambient Temperature : 23.1 °C; Liquid Temperature : 22.2 °C

DASY4 Configuration:

- Probe: ET3DV6 - SN1787; ConvF(4.66, 4.66, 4.66); Calibrated: 5/31/2006
- Sensor-Surface: 4mm (Mechanical And Optical Surface Detection)
- Electronics: DAE3 Sn577; Calibrated: 11/11/2005
- Phantom: SAM-B; Type: QD 000 P40 C; Serial: TP-1383
- Measurement SW: DASY4, V4.6 Build 23; Postprocessing SW: SEMCAD, V1.8 Build 161

**Ch661/Area Scan (61x91x1):** Measurement grid: dx=15mm, dy=15mm

Maximum value of SAR (interpolated) = 0.092 mW/g

**Ch661/Zoom Scan (5x5x7)/Cube 0:** Measurement grid: dx=8mm, dy=8mm, dz=5mm

Reference Value = 7.23 V/m; Power Drift = -0.134 dB

Peak SAR (extrapolated) = 0.119 W/kg

**SAR(1 g) = 0.082 mW/g; SAR(10 g) = 0.053 mW/g**

Maximum value of SAR (measured) = 0.088 mW/g

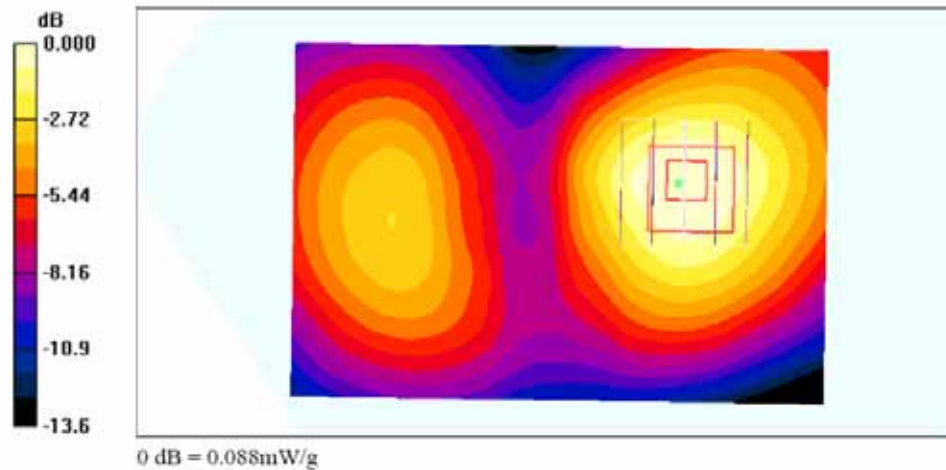



Test Laboratory: Sporton International Inc. SAR Testing Lab

Date/Time: 8/23/2006 10:28:19 PM

**Body\_PCS Ch512\_Keypad Down with 1.5cm Gap\_20060823**

**DUT: 681418; Type: Smart Phone**

Communication System: PCS; Frequency: 1850.2 MHz; Duty Cycle: 1:4

Medium: MSL\_1900 Medium parameters used :  $f = 1850.2$  MHz;  $\sigma = 1.49$  mho/m;  $\epsilon_r = 52.1$ ;  $\rho = 1000$  kg/m<sup>3</sup>

Ambient Temperature : 23.9 °C; Liquid Temperature : 22.2 °C

DASY4 Configuration:

- Probe: ET3DV6 - SN1787; ConvF(4.66, 4.66, 4.66); Calibrated: 5/31/2006
- Sensor-Surface: 4mm (Mechanical And Optical Surface Detection)
- Electronics: DAE3 Sn577; Calibrated: 11/11/2005
- Phantom: SAM-B; Type: QD 000 P40 C; Serial: TP-1383
- Measurement SW: DASY4, V4.6 Build 23; Postprocessing SW: SEMCAD, V1.8 Build 161

**Ch512/Area Scan (61x91x1):** Measurement grid: dx=15mm, dy=15mm

Maximum value of SAR (interpolated) = 0.919 mW/g

**Ch512/Zoom Scan (5x5x7)/Cube 0:** Measurement grid: dx=8mm, dy=8mm, dz=5mm

Reference Value = 24.3 V/m; Power Drift = -0.081 dB

Peak SAR (extrapolated) = 1.23 W/kg

SAR(1 g) = 0.786 mW/g; SAR(10 g) = 0.467 mW/g

Maximum value of SAR (measured) = 0.860 mW/g

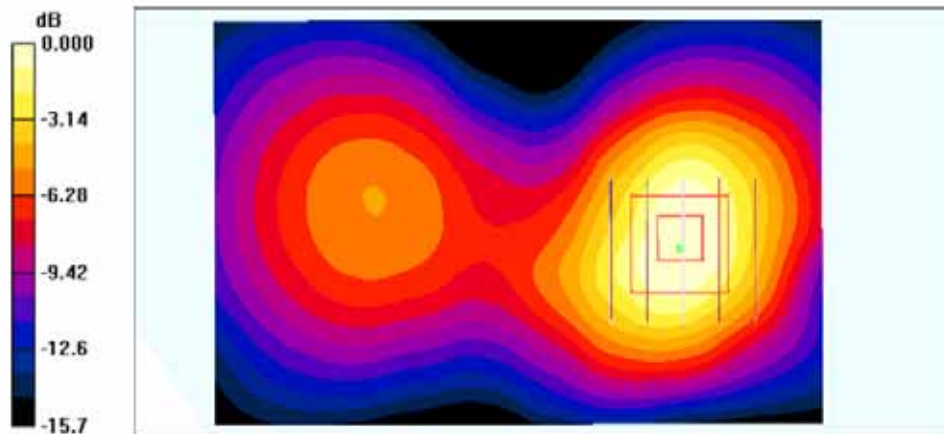

0 dB = 0.860mW/g



Test Laboratory: Sporton International Inc. SAR Testing Lab

Date/Time: 8/23/2006 11:09:35 PM

**Body\_PCS Ch512\_Keypad Down with 1.5cm Gap\_20060823\_Bluetooth On**

**DUT: 681418; Type: Smart Phone**

Communication System: PCS; Frequency: 1850.2 MHz; Duty Cycle: 1:4

Medium: MSL\_1900 Medium parameters used :  $f = 1850.2 \text{ MHz}$ ;  $\sigma = 1.49 \text{ mho/m}$ ;  $\epsilon_r = 52.1$ ;  $\rho = 1000 \text{ kg/m}^3$

Ambient Temperature : 23.6 °C; Liquid Temperature : 22.2 °C

DASY4 Configuration:

- Probe: ET3DV6 - SN1787; ConvF(4.66, 4.66, 4.66); Calibrated: 5/31/2006
- Sensor-Surface: 4mm (Mechanical And Optical Surface Detection)
- Electronics: DAE3 Sn577; Calibrated: 11/11/2005
- Phantom: SAM-B; Type: QD 000 P40 C; Serial: TP-1383
- Measurement SW: DASY4, V4.6 Build 23; Postprocessing SW: SEMCAD, V1.8 Build 161

**Ch512/Area Scan (61x91x1):** Measurement grid: dx=15mm, dy=15mm

Maximum value of SAR (interpolated) = 0.913 mW/g

**Ch512/Zoom Scan (5x5x7)/Cube 0:** Measurement grid: dx=8mm, dy=8mm, dz=5mm

Reference Value = 23.6 V/m; Power Drift = -0.054 dB

Peak SAR (extrapolated) = 1.21 W/kg

**SAR(1 g) = 0.761 mW/g; SAR(10 g) = 0.450 mW/g**

Maximum value of SAR (measured) = 0.824 mW/g

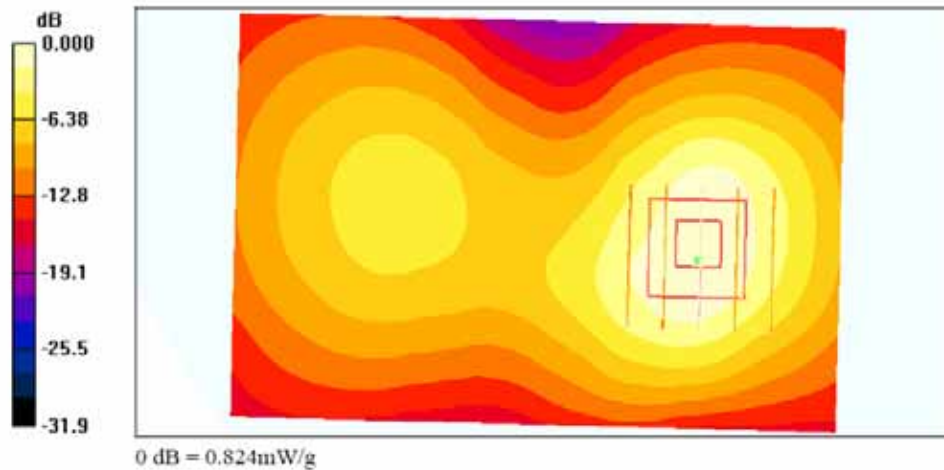



Test Laboratory: Sporton International Inc. SAR Testing Lab

Date/Time: 8/23/2006 7:28:46 PM

**Right Cheek\_PCS Ch512\_20060823\_Close Mode\_2D**

**DUT: 681418; Type: Smart Phone**

Communication System: PCS; Frequency: 1850.2 MHz; Duty Cycle: 1:8.3

Medium: HSL\_1900 Medium parameters used :  $f = 1850.2$  MHz;  $\sigma = 1.43$  mho/m;  $\epsilon_r = 41.6$ ;  $\rho = 1000$  kg/m<sup>3</sup>

Ambient Temperature : 23.4 °C; Liquid Temperature : 22.7 °C

DASY4 Configuration:

- Probe: ET3DV6 - SN1787; ConvF(5.26, 5.26, 5.26); Calibrated: 5/31/2006
- Sensor-Surface: 4mm (Mechanical And Optical Surface Detection)
- Electronics: DAE3 Su577; Calibrated: 11/11/2005
- Phantom: SAM-B; Type: QD 000 P40 C; Serial: TP-1383
- Measurement SW: DASY4, V4.6 Build 23; Postprocessing SW: SEMCAD, V1.8 Build 161

**Ch512/Area Scan (51x91x1):** Measurement grid: dx=15mm, dy=15mm

Maximum value of SAR (interpolated) = 0.265 mW/g

**Ch512/Zoom Scan (5x5x7)/Cube 0:** Measurement grid: dx=8mm, dy=8mm, dz=5mm

Reference Value = 9.76 V/m; Power Drift = -0.041 dB

Peak SAR (extrapolated) = 0.366 W/kg

**SAR(1 g) = 0.224 mW/g; SAR(10 g) = 0.128 mW/g**

Maximum value of SAR (measured) = 0.246 mW/g

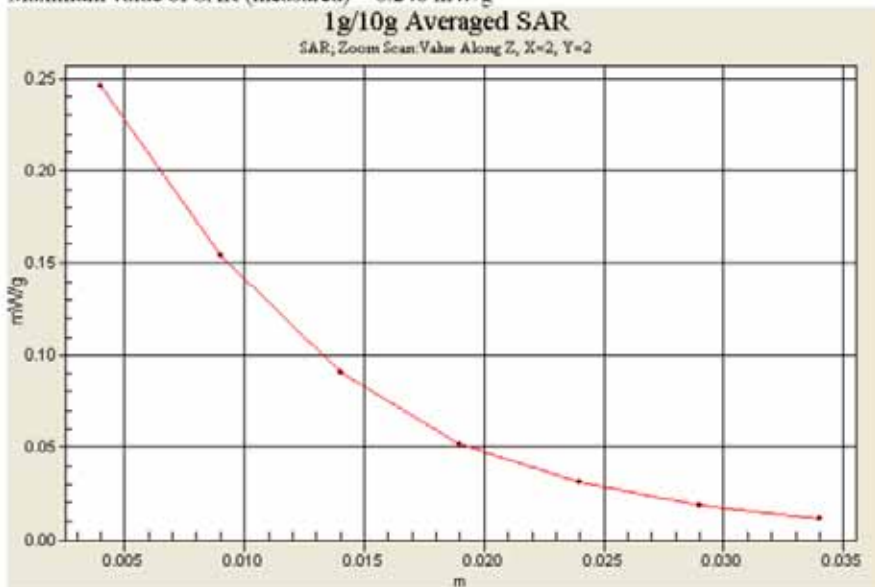



Test Laboratory: Sporton International Inc. SAR Testing Lab

Date/Time: 8/23/2006 10:28:19 PM

**Body\_PCS Ch512\_Keypad Down with 1.5cm Gap\_20060823\_2D**

**DUT: 681418; Type: Smart Phone**

Communication System: PCS; Frequency: 1850.2 MHz; Duty Cycle: 1:4

Medium: MSL\_1900 Medium parameters used :  $f = 1850.2$  MHz;  $\sigma = 1.49$  mho/m;  $\epsilon_r = 52.1$ ;  $\rho = 1000$  kg/m<sup>3</sup>

Ambient Temperature : 23.9 °C; Liquid Temperature : 22.2 °C

DASY4 Configuration:

- Probe: ET3DV6 - SN1787; ConvF(4.66, 4.66, 4.66); Calibrated: 5/31/2006
- Sensor-Surface: 4mm (Mechanical And Optical Surface Detection)
- Electronics: DAE3 Sn577; Calibrated: 11/11/2005
- Phantom: SAM-B; Type: QD 000 P40 C; Serial: TP-1383
- Measurement SW: DASY4, V4.6 Build 23; Postprocessing SW: SEMCAD, V1.8 Build 161

**Ch512/Area Scan (61x91x1):** Measurement grid: dx=15mm, dy=15mm

Maximum value of SAR (interpolated) = 0.919 mW/g

**Ch512/Zoom Scan (5x5x7)/Cube 0:** Measurement grid: dx=8mm, dy=8mm, dz=5mm

Reference Value = 24.3 V/m; Power Drift = -0.081 dB

Peak SAR (extrapolated) = 1.23 W/kg

**SAR(1 g) = 0.786 mW/g; SAR(10 g) = 0.467 mW/g**

Maximum value of SAR (measured) = 0.860 mW/g





Appendix C – Calibration Data

Calibration Laboratory of Schmid & Partner Engineering AG



S Schweizerischer Kalibrierdienst
C Service suisse d'etalonnage
S Servizio svizzero di taratura
S Swiss Calibration Service

Accredited by the Swiss Federal Office of Metrology and Accreditation
The Swiss Accreditation Service is one of the signatories to the EA Multilateral Agreement for the recognition of calibration certificates

Accreditation No.: SCS 108

Client Sporton (Auden)

Certificate No: D1900V2-5d041\_Mar06

CALIBRATION CERTIFICATE

Object D1900V2 - SN: 5d041
Calibration procedure(s) QA CAL-05.v6
Calibration procedure for dipole validation kits
Calibration date: March 21, 2006
Condition of the calibrated item In Tolerance

This calibration certificate documents the traceability to national standards, which realize the physical units of measurements (SI). The measurements and the uncertainties with confidence probability are given on the following pages and are part of the certificate.

All calibrations have been conducted in the closed laboratory facility: environment temperature (22 ± 3)°C and humidity < 70%.

Calibration Equipment used (M&TE critical for calibration)

Table with 4 columns: Primary Standards, ID #, Cal Date (Calibrated by, Certificate No.), Scheduled Calibration. Lists various power meters, sensors, and attenuators with their respective calibration dates and standards.

Calibrated by: Judith Müller, Laboratory Technician
Approved by: Katja Pokovic, Technical Manager
Includes handwritten signatures for both.

Issued: March 22, 2006

This calibration certificate shall not be reproduced except in full without written approval of the laboratory.





Calibration Laboratory of  
Schmid & Partner  
Engineering AG  
Zeughausstrasse 43, 8004 Zurich, Switzerland



S Schweizerischer Kalibrierdienst  
C Service suisse d'étalonnage  
S Servizio svizzero di taratura  
S Swiss Calibration Service

Accredited by the Swiss Federal Office of Metrology and Accreditation  
The Swiss Accreditation Service is one of the signatories to the EA  
Multilateral Agreement for the recognition of calibration certificates

Accreditation No.: SCS 108

**Glossary:**

TSL tissue simulating liquid  
ConvF sensitivity in TSL / NORM x,y,z  
N/A not applicable or not measured

**Calibration is Performed According to the Following Standards:**

- a) IEEE Std 1528-2003, "IEEE Recommended Practice for Determining the Peak Spatial-Averaged Specific Absorption Rate (SAR) in the Human Head from Wireless Communications Devices: Measurement Techniques", December 2003
- b) CENELEC EN 50361, "Basic standard for the measurement of Specific Absorption Rate related to human exposure to electromagnetic fields from mobile phones (300 MHz - 3 GHz), July 2001
- c) Federal Communications Commission Office of Engineering & Technology (FCC OET), "Evaluating Compliance with FCC Guidelines for Human Exposure to Radiofrequency Electromagnetic Fields; Additional Information for Evaluating Compliance of Mobile and Portable Devices with FCC Limits for Human Exposure to Radiofrequency Emissions", Supplement C (Edition 01-01) to Bulletin 65

**Additional Documentation:**

- d) DASY4 System Handbook

**Methods Applied and Interpretation of Parameters:**

- *Measurement Conditions:* Further details are available from the Validation Report at the end of the certificate. All figures stated in the certificate are valid at the frequency indicated.
- *Antenna Parameters with TSL:* The dipole is mounted with the spacer to position its feed point exactly below the center marking of the flat phantom section, with the arms oriented parallel to the body axis.
- *Feed Point Impedance and Return Loss:* These parameters are measured with the dipole positioned under the liquid filled phantom. The impedance stated is transformed from the measurement at the SMA connector to the feed point. The Return Loss ensures low reflected power. No uncertainty required.
- *Electrical Delay:* One-way delay between the SMA connector and the antenna feed point. No uncertainty required.
- *SAR measured:* SAR measured at the stated antenna input power.
- *SAR normalized:* SAR as measured, normalized to an input power of 1 W at the antenna connector.
- *SAR for nominal TSL parameters:* The measured TSL parameters are used to calculate the nominal SAR result.



**Measurement Conditions**

DASY system configuration, as far as not given on page 1.

DASY Version	DASY4	V4.7
Extrapolation	Advanced Extrapolation	
Phantom	Modular Flat Phantom V5.0	
Distance Dipole Center - TSL	10 mm	with Spacer
Area Scan resolution	dx, dy = 15 mm	
Zoom Scan Resolution	dx, dy, dz = 5 mm	
Frequency	1900 MHz ± 1 MHz	

**Head TSL parameters**

The following parameters and calculations were applied.

	Temperature	Permittivity	Conductivity
Nominal Head TSL parameters	22.0 °C	40.0	1.40 mho/m
Measured Head TSL parameters	(22.0 ± 0.2) °C	39.4 ± 6 %	1.42 mho/m ± 6 %
Head TSL temperature during test	(21.5 ± 0.2) °C	---	---

**SAR result with Head TSL**

SAR averaged over 1 cm <sup>3</sup> (1 g) of Head TSL	condition	
SAR measured	250 mW input power	9.75 mW / g
SAR normalized	normalized to 1W	39.0 mW / g
SAR for nominal Head TSL parameters <sup>1</sup>	normalized to 1W	<b>38.4 mW / g ± 17.0 % (k=2)</b>

SAR averaged over 10 cm <sup>3</sup> (10 g) of Head TSL	Condition	
SAR measured	250 mW input power	5.17 mW / g
SAR normalized	normalized to 1W	20.7 mW / g
SAR for nominal Head TSL parameters <sup>1</sup>	normalized to 1W	<b>20.5 mW / g ± 16.5 % (k=2)</b>

<sup>1</sup> Correction to nominal TSL parameters according to d), chapter "SAR Sensitivities"



**Body TSL parameters**

The following parameters and calculations were applied.

	Temperature	Permittivity	Conductivity
Nominal Body TSL parameters	22.0 °C	53.3	1.52 mho/m
Measured Body TSL parameters	(22.0 ± 0.2) °C	54.7 ± 6 %	1.54 mho/m ± 6 %
Body TSL temperature during test	(21.6 ± 0.2) °C	----	----

**SAR result with Body TSL**

SAR averaged over 1 cm <sup>3</sup> (1 g) of Body TSL	Condition	
SAR measured	250 mW input power	10.2 mW / g
SAR normalized	normalized to 1W	40.8 mW / g
SAR for nominal Body TSL parameters <sup>2</sup>	normalized to 1W	<b>41.1 mW / g ± 17.0 % (k=2)</b>

SAR averaged over 10 cm <sup>3</sup> (10 g) of Body TSL	condition	
SAR measured	250 mW Input power	5.40 mW / g
SAR normalized	normalized to 1W	21.6 mW / g
SAR for nominal Body TSL parameters <sup>2</sup>	normalized to 1W	<b>21.8 mW / g ± 16.5 % (k=2)</b>

<sup>2</sup> Correction to nominal TSL parameters according to d), chapter "SAR Sensitivities"



**Appendix**

**Antenna Parameters with Head TSL**

Impedance, transformed to feed point	53.5 $\Omega$ + 5.1 j $\Omega$
Return Loss	- 24.8 dB

**Antenna Parameters with Body TSL**

Impedance, transformed to feed point	47.9 $\Omega$ + 6.3 j $\Omega$
Return Loss	- 23.4 dB

**General Antenna Parameters and Design**

Electrical Delay (one direction)	1.200 ns
----------------------------------	----------

After long term use with 100W radiated power, only a slight warming of the dipole near the feedpoint can be measured.

The dipole is made of standard semirigid coaxial cable. The center conductor of the feeding line is directly connected to the second arm of the dipole. The antenna is therefore short-circuited for DC-signals.

No excessive force must be applied to the dipole arms, because they might bend or the soldered connections near the feedpoint may be damaged.

**Additional EUT Data**

Manufactured by	SPEAG
Manufactured on	July 4, 2003

**DASY4 Validation Report for Head TSL**

Date/Time: 14.03.2006 16:18:53

Test Laboratory: SPEAG, Zurich, Switzerland

**DUT: Dipole 1900 MHz; Type: D1900V2; Serial: D1900V2 - SN:5d041**

Communication System: CW; Frequency: 1900 MHz; Duty Cycle: 1:1

Medium: HSL U10 BB;

Medium parameters used:  $f = 1900 \text{ MHz}$ ;  $\sigma = 1.42 \text{ mho/m}$ ;  $\epsilon_r = 39.4$ ;  $\rho = 1000 \text{ kg/m}^3$

Phantom section: Flat Section

Measurement Standard: DASY4 (High Precision Assessment)

DASY4 Configuration:

- Probe: ET3DV6 - SN1507 (HF); ConvF(4.74, 4.74, 4.74); Calibrated: 28.10.2005
- Sensor-Surface: 4mm (Mechanical Surface Detection)
- Electronics: DAE4 Sn601; Calibrated: 15.12.2005
- Phantom: Flat Phantom 5.0 (front); Type: QD000P50AA; ;
- Measurement SW: DASY4, V4.7 Build 14; Postprocessing SW: SEMCAD, V1.8 Build 165

**Pin = 250 mW; d = 10 mm/Area Scan (71x71x1):** Measurement grid:  $dx=15\text{mm}$ ,  $dy=15\text{mm}$

Maximum value of SAR (interpolated) = 11.7 mW/g

**Pin = 250 mW; d = 10 mm/Zoom Scan (7x7x7)/Cube 0:** Measurement grid:  $dx=5\text{mm}$ ,  $dy=5\text{mm}$ ,  $dz=5\text{mm}$

Reference Value = 90.9 V/m; Power Drift = -0.093 dB

Peak SAR (extrapolated) = 16.6 W/kg

**SAR(1 g) = 9.75 mW/g; SAR(10 g) = 5.17 mW/g**

Maximum value of SAR (measured) = 11.1 mW/g

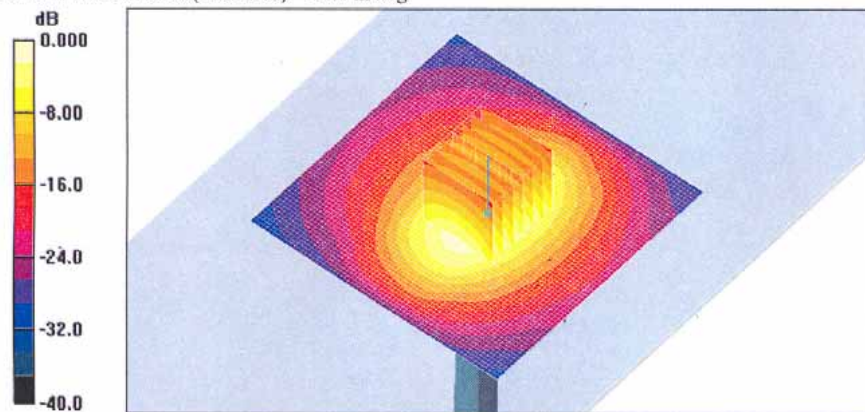

0 dB = 11.1 mW/g



Impedance Measurement Plot for Head TSL

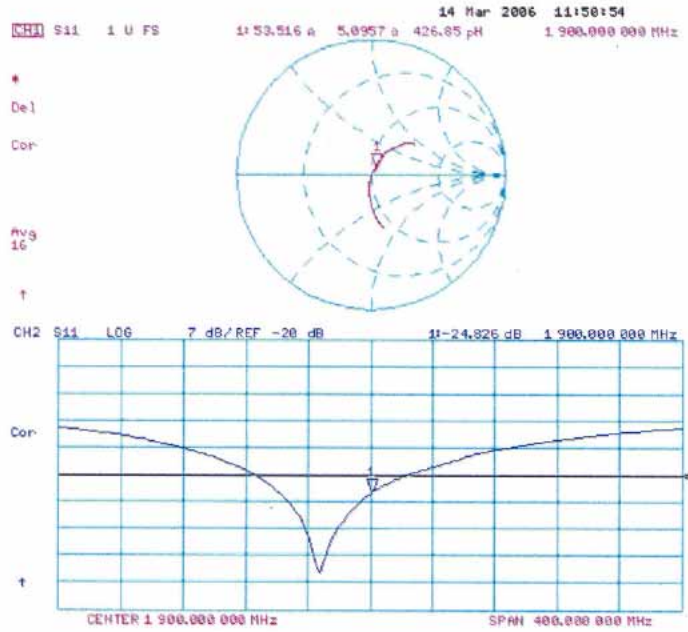

**DASY4 Validation Report for Body TSL**

Date/Time: 21.03.2006 13:59:55

Test Laboratory: SPEAG, Zurich, Switzerland

**DUT: Dipole 1900 MHz; Type: D1900V2; Serial: D1900V2 - SN:5d041**

Communication System: CW; Frequency: 1900 MHz; Duty Cycle: 1:1

Medium: MSL U10;

Medium parameters used:  $f = 1900$  MHz;  $\sigma = 1.54$  mho/m;  $\epsilon_r = 54.7$ ;  $\rho = 1000$  kg/m<sup>3</sup>

Phantom section: Flat Section

Measurement Standard: DASY4 (High Precision Assessment)

**DASY4 Configuration:**

- Probe: ET3DV6 - SN1507 (HF); ConvF(4.3, 4.3, 4.3); Calibrated: 28.10.2005
- Sensor-Surface: 4mm (Mechanical Surface Detection)
- Electronics: DAE4 Sn601; Calibrated: 15.12.2005
- Phantom: Flat Phantom 5.0 (front); Type: QD000P50AA; ;
- Measurement SW: DASY4, V4.6 Build 23; Postprocessing SW: SEMCAD, V1.8 Build 161

**Pin = 250 mW; d = 10 mm/Area Scan (71x71x1):** Measurement grid: dx=15mm, dy=15mm  
 Maximum value of SAR (interpolated) = 11.8 mW/g

**Pin = 250 mW; d = 10 mm/Zoom Scan (7x7x7)/Cube 0:** Measurement grid: dx=5mm, dy=5mm, dz=5mm  
 Reference Value = 89.3 V/m; Power Drift = 0.045 dB  
 Peak SAR (extrapolated) = 17.4 W/kg  
**SAR(1 g) = 10.2 mW/g; SAR(10 g) = 5.4 mW/g**  
 Maximum value of SAR (measured) = 11.6 mW/g

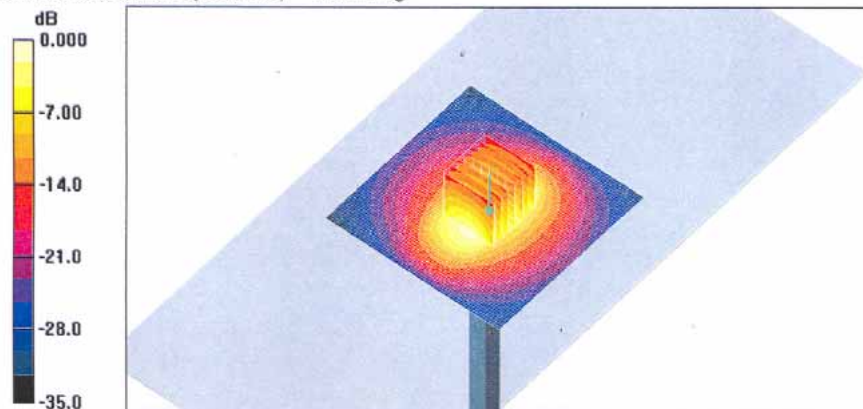

0 dB = 11.6mW/g



Impedance Measurement Plot for Body TSL

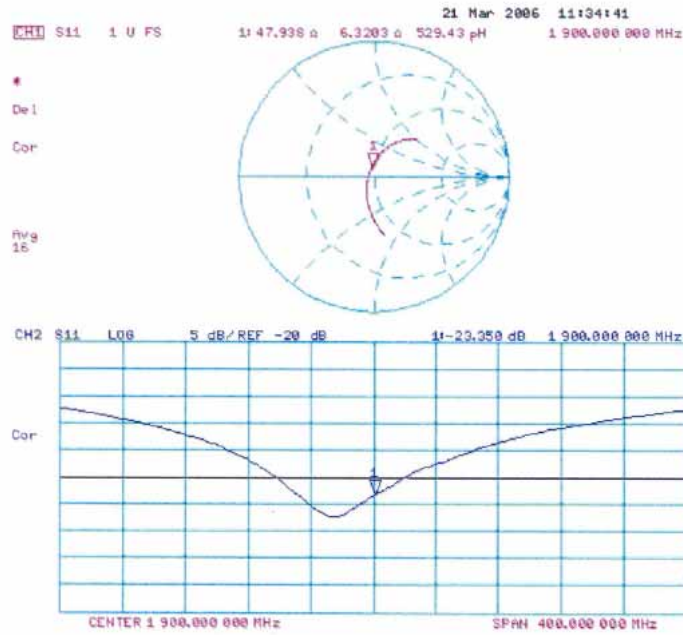





Calibration Laboratory of Schmid & Partner Engineering AG  
Zeughausstrasse 43, 8004 Zurich, Switzerland



S Schweizerischer Kalibrierdienst  
C Service suisse d'étalonnage  
S Servizio svizzero di taratura  
S Swiss Calibration Service

Accredited by the Swiss Federal Office of Metrology and Accreditation  
The Swiss Accreditation Service is one of the signatories to the EA  
Multilateral Agreement for the recognition of calibration certificates

Accreditation No.: SCS 108

Client Sporton (Auden)

Certificate No: ET3-1787\_May06

CALIBRATION CERTIFICATE			
Object	ET3DV6 - SN: 1767		
Calibration procedure(s)	QA CAL-01.v5 Calibration procedure for dosimetric E-field probes		
Calibration date	May 31, 2006		
Condition of the calibrated item	In Tolerance		
This calibration certificate documents the traceability to national standards, which realize the physical units of measurements (SI). The measurements and the uncertainties with confidence probability are given on the following pages and are part of the certificate.			
All calibrations have been conducted in the closed laboratory facility: environment temperature (22 ± 3)°C and humidity < 70%.			
Calibration Equipment used (M&PE critical for calibration)			
Primary Standards	ID #	Cal Date (Calibrated by: Certificate No.)	Scheduled Calibration
Power meter E4419B	GB41293874	5-Apr-06 (METAS, No. 251-00557)	Apr-07
Power sensor E4412A	MY41495277	5-Apr-06 (METAS, No. 251-00557)	Apr-07
Power sensor E4412A	MY41498067	5-Apr-06 (METAS, No. 251-00557)	Apr-07
Reference 3 dB Attenuator	SN: S5054 (3c)	11-Aug-05 (METAS, No. 251-00499)	Aug-06
Reference 20 dB Attenuator	SN: S5086 (20b)	4-Apr-06 (METAS, No. 251-00558)	Apr-07
Reference 30 dB Attenuator	SN: S5129 (30b)	11-Aug-05 (METAS, No. 251-00500)	Aug-06
Reference Probe ES3DV2	SN: 3013	2-Jan-06 (SPEAG, No. ES3-3013_Jan06)	Jan-07
DAE4	SN: 654	2-Feb-06 (SPEAG, No. DAE4-654_Feb06)	Feb-07
Secondary Standards	ID #	Check Date (in house)	Scheduled Check
RF generator HP 8645C	US3542U01700	4-Aug-99 (SPEAG, in house check Nov-05)	In house check: Nov-07
Network Analyzer HP 8750E	US37390585	15-Oct-01 (SPEAG, in house check Nov-05)	In house check: Nov-08
Calibrated by:	Name Kata Prikovic	Function Technical Manager	Signature 
Approved by:	Name Niels Kuster	Function Quality Manager	Signature 
			Issued: May 31, 2006
This calibration certificate shall not be reproduced except in full without written approval of the laboratory.			



Calibration Laboratory of  
Schmid & Partner  
Engineering AG  
Zeughausstrasse 43, 8004 Zurich, Switzerland



S Schweizerischer Kalibrierdienst  
C Service suisse d'étalonnage  
S Servizio svizzero di taratura  
S Swiss Calibration Service

Accredited by the Swiss Federal Office of Metrology and Accreditation  
The Swiss Accreditation Service is one of the signatories to the EA  
Multilateral Agreement for the recognition of calibration certificates

Accreditation No.: SCS 108

**Glossary:**

TSL	tissue simulating liquid
NORM <sub>x,y,z</sub>	sensitivity in free space
ConvF	sensitivity in TSL / NORM <sub>x,y,z</sub>
DCP	diode compression point
Polarization $\varphi$	$\varphi$ rotation around probe axis
Polarization $\theta$	$\theta$ rotation around an axis that is in the plane normal to probe axis (at measurement center), i.e., $\theta = 0$ is normal to probe axis

**Calibration is Performed According to the Following Standards:**

- a) IEEE Std 1528-2003, "IEEE Recommended Practice for Determining the Peak Spatial-Averaged Specific Absorption Rate (SAR) in the Human Head from Wireless Communications Devices: Measurement Techniques", December 2003
- b) CENELEC EN 50361, "Basic standard for the measurement of Specific Absorption Rate related to human exposure to electromagnetic fields from mobile phones (300 MHz - 3 GHz), July 2001

**Methods Applied and Interpretation of Parameters:**

- NORM<sub>x,y,z</sub>: Assessed for E-field polarization  $\theta = 0$  ( $f \leq 900$  MHz in TEM-cell;  $f > 1800$  MHz: R22 waveguide). NORM<sub>x,y,z</sub> are only intermediate values, i.e., the uncertainties of NORM<sub>x,y,z</sub> does not effect the E<sup>2</sup>-field uncertainty inside TSL (see below ConvF).
- NORM(f)<sub>x,y,z</sub> = NORM<sub>x,y,z</sub> \* frequency\_response (see Frequency Response Chart). This linearization is implemented in DASY4 software versions later than 4.2. The uncertainty of the frequency response is included in the stated uncertainty of ConvF.
- DCP<sub>x,y,z</sub>: DCP are numerical linearization parameters assessed based on the data of power sweep (no uncertainty required). DCP does not depend on frequency nor media.
- ConvF and Boundary Effect Parameters: Assessed in flat phantom using E-field (or Temperature Transfer Standard for  $f \leq 800$  MHz) and inside waveguide using analytical field distributions based on power measurements for  $f > 800$  MHz. The same setups are used for assessment of the parameters applied for boundary compensation (alpha, depth) of which typical uncertainty values are given. These parameters are used in DASY4 software to improve probe accuracy close to the boundary. The sensitivity in TSL corresponds to NORM<sub>x,y,z</sub> \* ConvF whereby the uncertainty corresponds to that given for ConvF. A frequency dependent ConvF is used in DASY version 4.4 and higher which allows extending the validity from  $\pm 50$  MHz to  $\pm 100$  MHz.
- Spherical Isotropy (3D deviation from isotropy): in a field of low gradients realized using a flat phantom exposed by a patch antenna.
- Sensor Offset: The sensor offset corresponds to the offset of virtual measurement center from the probe tip (on probe axis). No tolerance required.



ET3DV6 SN:1787

May 31, 2006

# Probe ET3DV6

## SN:1787

Manufactured:	May 28, 2003
Last calibrated:	August 29, 2003
Recalibrated:	May 31, 2006

Calibrated for DASY Systems

(Note: non-compatible with DASY2 system!)



ET3DV6 SN:1787

May 31, 2006

**DASY - Parameters of Probe: ET3DV6 SN:1787**

Sensitivity in Free Space<sup>A</sup>

Diode Compression<sup>B</sup>

NormX	1.57 ± 10.1%	$\mu\text{V}/(\text{V}/\text{m})^2$	DCP X	94 mV
NormY	1.71 ± 10.1%	$\mu\text{V}/(\text{V}/\text{m})^2$	DCP Y	94 mV
NormZ	2.09 ± 10.1%	$\mu\text{V}/(\text{V}/\text{m})^2$	DCP Z	94 mV

Sensitivity in Tissue Simulating Liquid (Conversion Factors)

Please see Page 8.

Boundary Effect

TSL                    900 MHz      Typical SAR gradient: 5 % per mm

Sensor Center to Phantom Surface Distance		3.7 mm	4.7 mm
SAR <sub>90</sub> [%]	Without Correction Algorithm	7.2	3.8
SAR <sub>90</sub> [%]	With Correction Algorithm	0.0	0.2

TSL                    1810 MHz      Typical SAR gradient: 10 % per mm

Sensor Center to Phantom Surface Distance		3.7 mm	4.7 mm
SAR <sub>90</sub> [%]	Without Correction Algorithm	6.3	3.6
SAR <sub>90</sub> [%]	With Correction Algorithm	0.1	0.3

Sensor Offset

Probe Tip to Sensor Center                    2.7 mm

The reported uncertainty of measurement is stated as the standard uncertainty of measurement multiplied by the coverage factor k=2, which for a normal distribution corresponds to a coverage probability of approximately 95%.

<sup>A</sup> The uncertainties of NormX,Y,Z do not affect the E<sup>2</sup>-field uncertainty inside TSL (see Page 6).

<sup>B</sup> Numerical linearization parameter: uncertainty not required.



ET3DV6 SN:1787

May 31, 2006

### Frequency Response of E-Field

(TEM-Cell:ifi110 EXX, Waveguide: R22)

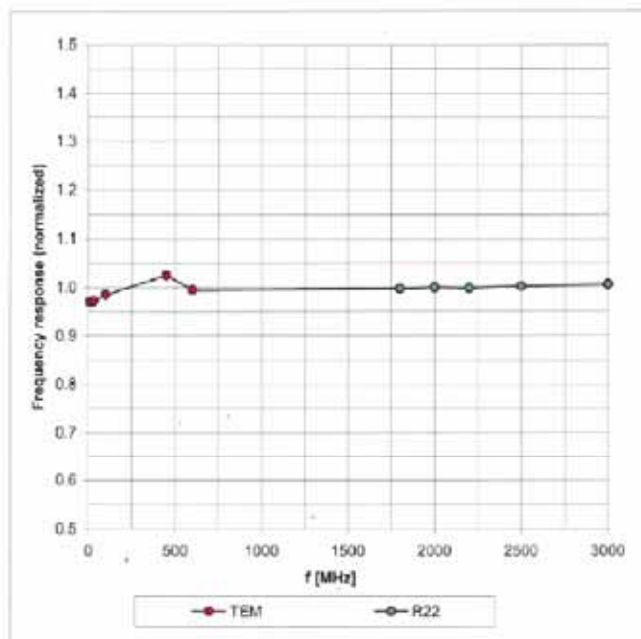

Uncertainty of Frequency Response of E-field:  $\pm 6.3\%$  (k=2)



ET3DV6 SN:1787

May 31, 2006

Receiving Pattern ( $\phi$ ),  $\theta = 0^\circ$

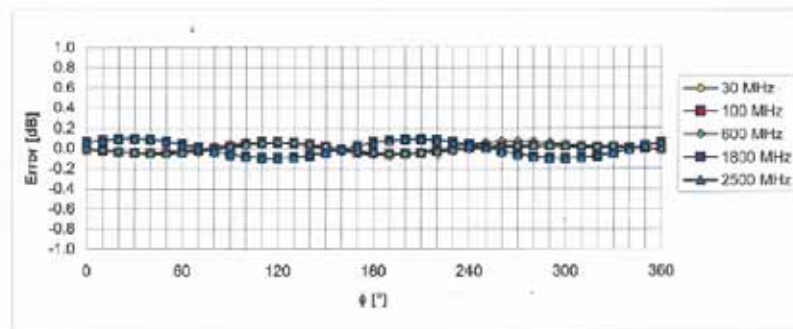
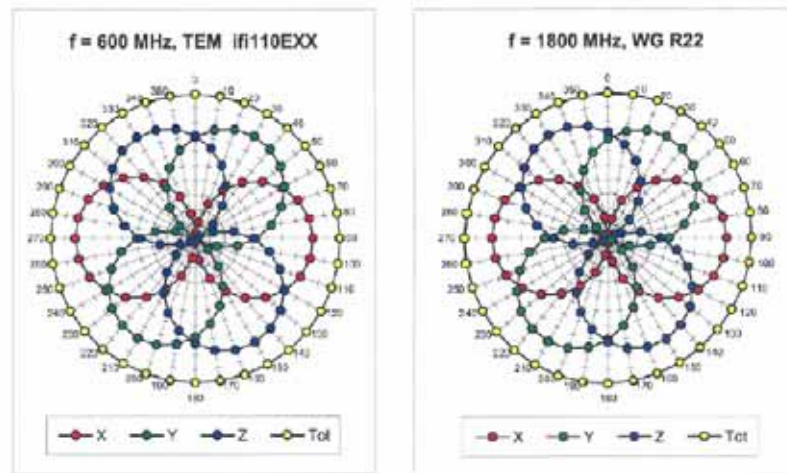

Uncertainty of Axial Isotropy Assessment:  $\pm 0.5\%$  (k=2)



ET3DV6 SN:1787

May 31, 2006

### Dynamic Range $f(SAR_{head})$ (Waveguide R22, $f = 1800$ MHz)

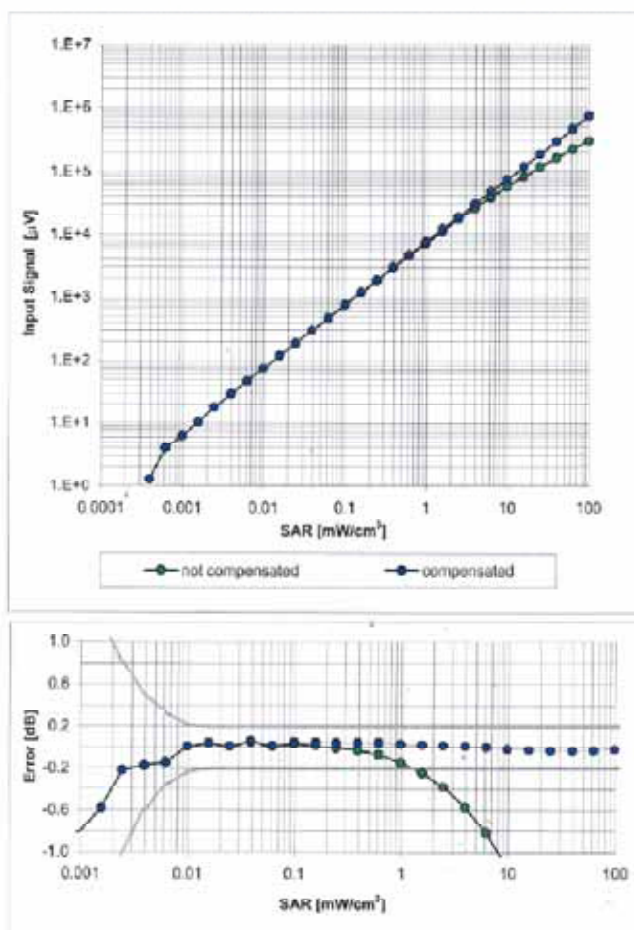

Uncertainty of Linearity Assessment:  $\pm 0.6\%$  ( $k=2$ )



ET3DV6 SN:1787

May 31, 2006

### Conversion Factor Assessment

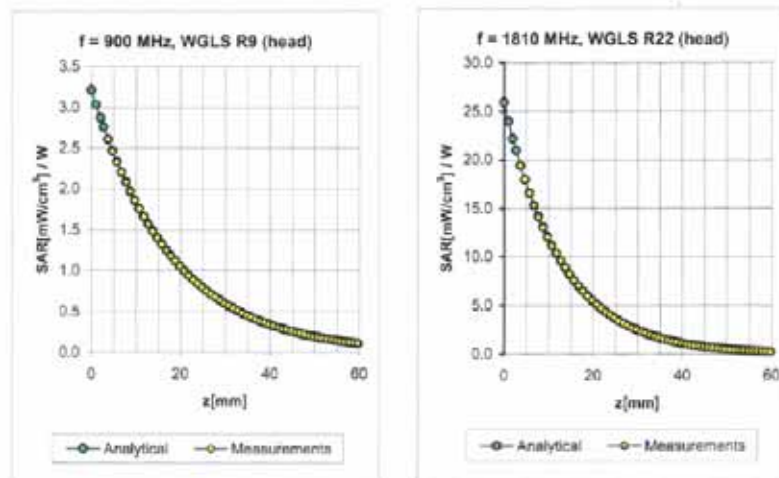

f [MHz]	Validity [MHz] <sup>c</sup>	TSL	Permittivity	Conductivity	Alpha	Depth	ConvF Uncertainty
900	± 50 / ± 100	Head	41.5 ± 5%	0.97 ± 5%	0.50	1.85	6.38 ± 11.0% (k=2)
1810	± 50 / ± 100	Head	40.0 ± 5%	1.40 ± 5%	0.59	2.46	5.25 ± 11.0% (k=2)
900	± 50 / ± 100	Body	55.0 ± 5%	1.05 ± 5%	0.44	2.10	6.18 ± 11.0% (k=2)
1810	± 50 / ± 100	Body	53.3 ± 5%	1.52 ± 5%	0.62	2.44	4.86 ± 11.0% (k=2)
2450	± 50 / ± 100	Body	52.7 ± 5%	1.95 ± 5%	0.62	2.13	4.13 ± 11.8% (k=2)

<sup>c</sup> The validity of ± 100 MHz only applies for DASY v6.4 and higher (see Page 2). The uncertainty is the RSS of the ConvF uncertainty at calibration frequency and the uncertainty for the indicated frequency band.





ET3DV6 SN:1787

May 31, 2006

Deviation from Isotropy in HSL  
Error ( $\phi$ ,  $\theta$ ),  $f = 900$  MHz

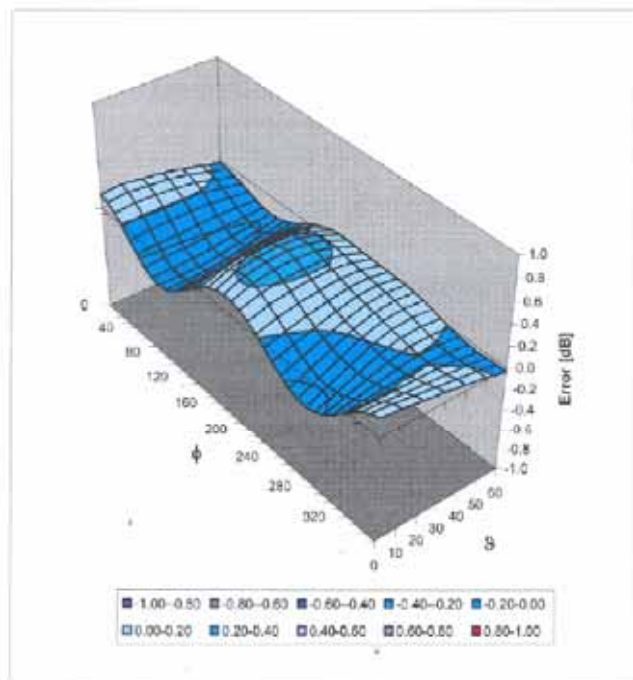

Uncertainty of Spherical Isotropy Assessment:  $\pm 2.6\%$  ( $k=2$ )



Calibration Laboratory of Schmid & Partner Engineering AG  
Zeughausstrasse 43, 8004 Zurich, Switzerland



S Schweizerischer Kalibrierdienst  
C Service suisse d'étalonnage  
S Servizio svizzero di taratura  
S Swiss Calibration Service

Accredited by the Swiss Federal Office of Metrology and Accreditation  
The Swiss Accreditation Service is one of the signatories to the EA  
Multilateral Agreement for the recognition of calibration certificates

Accreditation No.: SCS 108

Client Sporton (Auden)

Certificate No: DAE3-577\_Nov05

CALIBRATION CERTIFICATE

Object DAE3 - SD 000 D03 AA - SN: 577  
Calibration procedure(s) QA CAL-06.v12  
Calibration procedure for the data acquisition electronics (DAE)  
Calibration date: November 11, 2005  
Condition of the calibrated item In Tolerance

This calibration certificate documents the traceability to national standards, which realize the physical units of measurements (SI).  
The measurements and the uncertainties with confidence probability are given on the following pages and are part of the certificate.

All calibrations have been conducted in the closed laboratory facility: environment temperature (22 ± 3)°C and humidity < 70%.

Calibration Equipment used (M&TE critical for calibration)

Primary Standards	ID #	Cal Date (Calibrated by, Certificate No.)	Scheduled Calibration
Fluke Process Calibrator Type 702	SN: 6295803	7-Oct-05 (Sintrel, No.E-050073)	Oct-06
Secondary Standards	ID #	Check Date (in house)	Scheduled Check
Calibrator Box V1.1	SE UMS 006 AB 1002	29-Jun-05 (SPEAG, in house check)	In house check Jun-06

Calibrated by: Daniel Steinacher, Technician, [Signature]  
Approved by: Fin Bornholt, R&D Director, [Signature]

Issued: November 11, 2005

This calibration certificate shall not be reproduced except in full without written approval of the laboratory.



**Calibration Laboratory of**  
Schmid & Partner  
Engineering AG  
Zeughausstrasse 43, 8004 Zurich, Switzerland



S Schweizerischer Kalibrierdienst  
C Service suisse d'étalonnage  
S Servizio svizzero di taratura  
S Swiss Calibration Service

Accredited by the Swiss Federal Office of Metrology and Accreditation  
The Swiss Accreditation Service is one of the signatories to the EA  
Multilateral Agreement for the recognition of calibration certificates

Accreditation No.: **SCS 108**

## Glossary

DAE data acquisition electronics  
Connector angle information used in DASY system to align probe sensor X to the robot coordinate system.

## Methods Applied and Interpretation of Parameters

- *DC Voltage Measurement*: Calibration Factor assessed for use in DASY system by comparison with a calibrated instrument traceable to national standards. The figure given corresponds to the full scale range of the voltmeter in the respective range.
- *Connector angle*: The angle of the connector is assessed measuring the angle mechanically by a tool inserted. Uncertainty is not required.
- The following parameters contain technical information as a result from the performance test and require no uncertainty.
- *DC Voltage Measurement Linearity*: Verification of the Linearity at +10% and -10% of the nominal calibration voltage. Influence of offset voltage is included in this measurement.
- *Common mode sensitivity*: Influence of a positive or negative common mode voltage on the differential measurement.
- *Channel separation*: Influence of a voltage on the neighbor channels not subject to an input voltage.
- *AD Converter Values with inputs shorted*: Values on the internal AD converter corresponding to zero input voltage
- *Input Offset Measurement*: Output voltage and statistical results over a large number of zero voltage measurements.
- *Input Offset Current*: Typical value for information; Maximum channel input offset current, not considering the input resistance.
- *Input resistance*: DAE input resistance at the connector, during internal auto-zeroing and during measurement.
- *Low Battery Alarm Voltage*: Typical value for information. Below this voltage, a battery alarm signal is generated.
- *Power consumption*: Typical value for information. Supply currents in various operating modes.



**DC Voltage Measurement**

A/D - Converter Resolution nominal

High Range: 1LSB = 6.1µV , full range = -100...+300 mV

Low Range: 1LSB = 61nV , full range = -1.....+3mV

DASY measurement parameters: Auto Zero Time: 3 sec; Measuring time: 3 sec

Calibration Factors	X	Y	Z
High Range	404.445 ± 0.1% (k=2)	403.896 ± 0.1% (k=2)	404.369 ± 0.1% (k=2)
Low Range	3.94241 ± 0.7% (k=2)	3.89919 ± 0.7% (k=2)	3.95427 ± 0.7% (k=2)

**Connector Angle**

Connector Angle to be used in DASY system	130 ° ± 1 °
---	-------------



Appendix

1. DC Voltage Linearity

High Range	Input ( $\mu\text{V}$ )	Reading ( $\mu\text{V}$ )	Error (%)
Channel X + Input	200000	199999.3	0.00
Channel X + Input	20000	20006.75	0.03
Channel X - Input	20000	-19997.90	-0.01
Channel Y + Input	200000	200000.3	0.00
Channel Y + Input	20000	20004.58	0.02
Channel Y - Input	20000	-20000.75	0.00
Channel Z + Input	200000	199999.6	0.00
Channel Z + Input	20000	20001.43	0.01
Channel Z - Input	20000	-20003.93	0.02

Low Range	Input ( $\mu\text{V}$ )	Reading ( $\mu\text{V}$ )	Error (%)
Channel X + Input	2000	2000.1	0.00
Channel X + Input	200	200.42	0.21
Channel X - Input	200	-200.30	0.15
Channel Y + Input	2000	2000.1	0.00
Channel Y + Input	200	199.35	-0.32
Channel Y - Input	200	-200.96	0.48
Channel Z + Input	2000	1999.9	0.00
Channel Z + Input	200	199.37	-0.31
Channel Z - Input	200	-200.62	0.31

2. Common mode sensitivity

DASY measurement parameters: Auto Zero Time: 3 sec; Measuring time: 3 sec

	Common mode Input Voltage (mV)	High Range Average Reading ( $\mu\text{V}$ )	Low Range Average Reading ( $\mu\text{V}$ )
Channel X	200	13.40	12.55
	- 200	-12.29	-13.06
Channel Y	200	-6.93	-7.43
	- 200	6.72	6.47
Channel Z	200	0.71	0.36
	- 200	-1.67	-1.93

3. Channel separation

DASY measurement parameters: Auto Zero Time: 3 sec; Measuring time: 3 sec

	Input Voltage (mV)	Channel X ( $\mu\text{V}$ )	Channel Y ( $\mu\text{V}$ )	Channel Z ( $\mu\text{V}$ )
Channel X	200	-	1.59	0.08
Channel Y	200	1.69	-	3.62
Channel Z	200	-0.73	-1.49	-



**4. AD-Converter Values with inputs shorted**

DASY measurement parameters: Auto Zero Time: 3 sec; Measuring time: 3 sec

	High Range (LSB)	Low Range (LSB)
Channel X	15946	15679
Channel Y	15960	16151
Channel Z	16233	15968

**5. Input Offset Measurement**

DASY measurement parameters: Auto Zero Time: 3 sec; Measuring time: 3 sec

Input 10MΩ

	Average (μV)	min. Offset (μV)	max. Offset (μV)	Std. Deviation (μV)
Channel X	0.08	-1.13	2.31	0.51
Channel Y	-0.35	-2.00	0.81	0.43
Channel Z	-0.38	-2.76	1.68	0.40

**6. Input Offset Current**

Nominal Input circuitry offset current on all channels: <25fA

**7. Input Resistance**

	Zeroing (MOhm)	Measuring (MOhm)
Channel X	0.2000	200.8
Channel Y	0.2000	201.4
Channel Z	0.2001	200.3

**8. Low Battery Alarm Voltage** (verified during pre test)

Typical values	Alarm Level (VDC)
Supply (+ Vcc)	+7.9
Supply (- Vcc)	-7.6

**9. Power Consumption** (verified during pre test)

Typical values	Switched off (mA)	Stand by (mA)	Transmitting (mA)
Supply (+ Vcc)	+0.0	+6	+14
Supply (- Vcc)	-0.01	-8	-9