



# FCC TEST REPORT

for  
47 CFR Part 24E

Equipment : 3.5G HSDPA/UMTS/GSM900/DCS1800/PCS1900  
PDA Phone  
Trade Name : O<sub>2</sub>  
Model No. : Xda Denim  
FCC ID : UJU9QDENIM000  
Tx Frequency Range : 1850~1910 MHz  
Max. ERP/EIRP Power : PCS (GSM) : 1.40 W  
PCS (EDGE) : 0.58 W  
Emission Designator : GSM : 300KGXW  
EDGE : 300KG7W  
Applicant : GIGA-BYTE Communications Inc.  
8F., No.43, Fu-Hsin Road, Hsin-Tien, Taipei Hsien, Taiwan,  
R.O.C.

- The test result refers exclusively to the test presented test model / sample.
- Without written approval of SPORTON International Inc., the test report shall not be reproduced except in full.
- **Certificate or Test Report must not be used by the applicant to claim the product in this test report endorsement by NVLAP or any agency of U.S. government.**
- The data shown in this test report were carried out on Jun. 21, 2007 at **Sporton International Inc. LAB.**
- Report No.: FG760116-01B, Report Version: Rev. 02.

Roy Wu  
Deputy Manager

**SPORTON International Inc.**

6F, No.106, Sec. 1, Hsin Tai Wu Rd., Hsi Chih, Taipei Hsien, Taiwan, R.O.C.



Table of Contents

History of this test report.....ii

**1. General Information ..... 1**

    1.1. Applicant .....1

    1.2. Manufacturer .....1

    1.3. Basic Description of Equipment under Test.....1

    1.4. Feature of Equipment under Test .....2

    1.5. Report Date.....2

**2 Test Configuration of Equipment under Test .....3**

    2.1 Test Manner .....3

    2.2 Test Mode .....3

    2.3 Connection Diagram of Test System .....3

    2.4 Ancillary Equipment List.....3

**3. General Information of Test Site .....4**

    3.1 Test Voltage .....4

    3.2 Test in Compliance with .....4

    3.3 Frequency Range Investigated .....4

    3.4 Test Distance .....4

**4. Test Data and Test Result.....5**

    4.1 List of Measurements and Examinations .....5

    4.2 RF Output Power .....6

    4.3 ERP / EIRP Measurement .....7

    4.4 Occupied Bandwidth and Band Edge Measurement .....10

    4.5 Conducted Emission .....31

    4.6 Field Strength of Spurious Radiation .....37

    4.7 Frequency Stability (Temperature Variation) .....49

    4.8 Frequency Stability (Voltage Variation).....51

**5 List of Measurement Equipments .....53**

**6 Uncertainty Evaluation.....54**

- Appendix A – External Photographs
- Appendix B – Internal Photographs
- Appendix C – Setup Photographs





## **1. General Information**

### **1.1. Applicant**

**GIGA-BYTE Communications Inc.**

8F., No.43, Fu-Hsin Road, Hsin-Tien, Taipei Hsien, Taiwan, R.O.C.

### **1.2 Manufacturer**

**GIGA-BYTE TECHNOLOGY CO., LTD.**

No.18, Gongye 1st Rd., Pingjhen City, Taoyuan County 324, Taiwan (R.O.C.)

### **1.3 Basic Description of Equipment under Test**

Equipment : 3.5G HSDPA/UMTS/GSM900/DCS1800/PCS1900 PDA Phone  
Trade Name : O<sub>2</sub>  
Model No. : Xda Denim  
FCC ID : UJU9QDENIM000  
Power Supply Type : Switching  
AC Power Cord : AC120V, Wall-mount, 1.6 meter, 2 pin  
Adapter : PHIHONG, PSC05R-050 PH  
Battery : Simplo, XP-13  
Earphone : Xu Sheng, EE-624P-8EN  
USB cable : L&K, 12CBL-037-0011



#### 1.4 Feature of Equipment under Test

<b>DUT Type :</b>	3.5G HSDPA/UMTS/GSM900/DCS1800/PCS1900 PDA Phone
<b>Trade Name :</b>	O <sub>2</sub>
<b>Model Name :</b>	Xda Denim
<b>FCC ID :</b>	UJU9QDENIM000
<b>Tx Frequency :</b>	PCS1900 : 1850 ~1910 MHz Bluetooth : 2400~2483.5 MHz WLAN : 2400 ~ 2483.5 MHz
<b>Rx Frequency :</b>	PCS1900 : 1930 ~ 1990 MHz Bluetooth : 2400~2483.5 MHz WLAN : 2400 ~ 2483.5 MHz
<b>Number of Channels :</b>	Bluetooth : 79 WLAN : 11
<b>Carrier Frequency of Each Channel :</b>	Bluetooth : 2402+n*1 MHz; n=0~78 WLAN : 2412+(n-1)*5 MHz; n=1~11
<b>Antenna Type :</b>	GSM : Fixed Internal Bluetooth / WLAN : Chip Antenna
<b>Antenna Gain :</b>	802.11b/g : -8 dBi Bluetooth : -7 dBi
<b>Maximum Output Power to Antenna :</b>	PCS (GSM) : 29.13 dBm PCS (EDGE) :25.25 dBm 802.11b : 15.02 dBm / 802.11g: 18.74 dBm Bluetooth: 1.16 dBm
<b>Maximum ERP/EIRP :</b>	PCS (GSM) : 1.40 W (31.46 dBm) PCS (EDGE): 0.58 W (27.60 dBm)
<b>HW Version :</b>	V0.5
<b>SW Version :</b>	WWE_B01.010
<b>Power Rating (DC/AC , Voltage and Current of RF element or PA) :</b>	DC4V / 1A
<b>Digital Modulation Emission :</b>	GSM/GPRS : GMSK EDGE : 8PSK Bluetooth : GFSK WLAN : DSSS / OFDM
<b>Type of Emission :</b>	GSM : 300KGXW EDGE : 300KG7W
<b>Device Power Class :</b>	1
<b>DUT Stage :</b>	Production Unit

#### 1.5 Report Date

EUT Received : Jun. 21, 2007

Report Date : Jul. 10, 2007

## 2 Test Configuration of Equipment under Test

### 2.1 Test Manner

- a. The spurious emission measurements were carried out in semi-anechoic chamber with 3-meter test range.
- b. During all testings, EUT is in link mode with base station emulator at maximum power level.
- c. Frequency range investigated: radiated emission 30MHz to 19000 MHz for PCS.

### 2.2 Test Mode

Application	PCS 1900
Radiated Emission	<input checked="" type="checkbox"/> Mode 1: PCS (GSM) Link Mode <input checked="" type="checkbox"/> Mode 2: PCS (EDGE) Link Mode <input checked="" type="checkbox"/> Mode 3: PCS (GSM) Link Mode + WLAN Link
Conducted Measurement	<input checked="" type="checkbox"/> Mode 1: PCS (GSM) Link Mode <input checked="" type="checkbox"/> Mode 2: PCS (EDGE) Link Mode

### 2.3 Connection Diagram of Test System

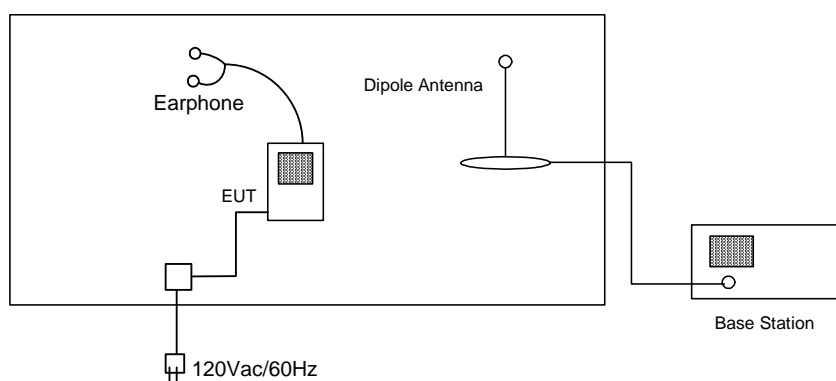

### 2.4 Ancillary Equipment List

Item	Equipment	Model No.	Serial No.
1.	Base Station(R&S)	CMU200	106656
2.	BT Base Station (Anritus)	8852A	N/A



### **3. General Information of Test Site**

Test Site Location : No. 52, Hwa Ya 1st Rd., Hwa Ya Technology Park,  
Kwei-Shan Hsiang, Tao Yuan Hsien, Taiwan, R.O.C.  
TEL : 886-3-327-3456  
FAX : 886-3-318-0055

Test Site No : 03CH06-HY

The chamber meets the characteristics of ANSI C63.4-2003. This site is on file with the FCC.

#### **3.1 Test Voltage**

120V / 60Hz

#### **3.2 Test in Compliance with**

47 CFR Part 24E

#### **3.3 Frequency Range Investigated**

a. Radiation: from 30 MHz to 19000 MHz for PCS

#### **3.4 Test Distance**

The test distance of radiated emission from antenna to EUT is 3 m.



## 4. Test Data and Test Result

### 4.1 List of Measurements and Examinations

FCC Rule	DESCRIPTION OF TEST	Result	Section
§2.1046	RF Output Power	Passed	4.2
§ 22.913 §24.232	ERP / EIRP	Passed	4.3
§2.1049, § 22.917, § 24.238(b)	Occupied Bandwidth & Band Edge Measurement	Passed	4.4
§2.1051	Conducted Emission	Passed	4.5
§2.1053	Field Strength of Spurious Radiation	Passed	4.6
§2.1055, § 22.355, §24.235	Frequency Stability vs. Temperature	Passed	4.7
§2.1055, §22.355, §24.235	Frequency Stability vs. Voltage	Passed	4.8



## 4.2 RF Output Power

### 4.2.1 Measurement Instruments :

As described in chapter 5 of this test report.

### 4.2.2 Test Procedure :

1. The transmitter output was connected to power meter and base station through power divider.
2. Set EUT at PCL=0 for PCS maximum power through base station.
3. Select lowest, middle, and highest channels for each band.

### 4.2.3 Test Setup Layout :

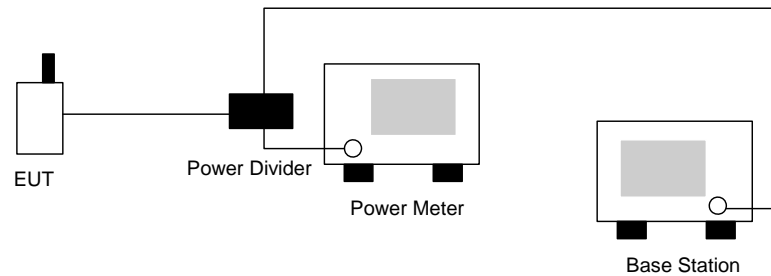

### 4.2.4 Test Result :

Bands	Channel	Frequency (MHz)	Conducted Power (dBm)	Conducted Power (Watts)
PCS (GSM)	512	1850.2 (Low)	29.04	0.80
	661	1880.0 (Mid)	29.13	0.82
	810	1909.8 (High)	29.07	0.81
PCS (EDGE)	512	1850.2 (Low)	25.20	0.33
	661	1880.0 (Mid)	25.25	0.33
	810	1909.8 (High)	25.00	0.32



### 4.3 ERP / EIRP Measurement

Equivalent isotropic radiated power measurements by substitution method according to ANSI/TIA/EIA-603-C.

#### 4.3.1 Measurement Instruments

As described in chapter 5 of this test report.

#### 4.3.2 Test Procedure

1. The EUT was placed on a rotatable table with 1.0 meter height in an fully anechoic chamber.
2. The EUT was set 1.2 meters from the receiving antenna which was mounted on the antenna tower.
3. The table was rotated 360 degrees to determine the position of the highest radiated power.
4. The height of the receiving antenna is also kept at 1.0M height.
5. Taking the record of maximum ERP/EIRP.
6. A dipole antenna was substituted in place of the EUT and was driven by a signal generator.
7. The conducted power at the terminal of the dipole antenna is measured.
8. Repeat step 3 to step 5 to get the maximum ERP/EIRP of the substitution antenna.
9.  $ERP/EIRP = P_s + E_t - E_s + G_s = P_s + R_t - R_s + G_s$

$P_s$  (dBm) : Input power to substitution antenna.

$G_s$  (dBi or dBd) : Substitution antenna Gain.

$E_t = R_t + AF$

$E_s = R_s + AF$

$AF$  (dB/m) : Receive antenna factor

$R_t$  : The highest received signal in Spectrum Analyzer for EUT.

$R_s$  : The highest received signal in spectrum analyzer for substitution antenna.

4.3.3 Test Setup Layout of ERP/EIRP

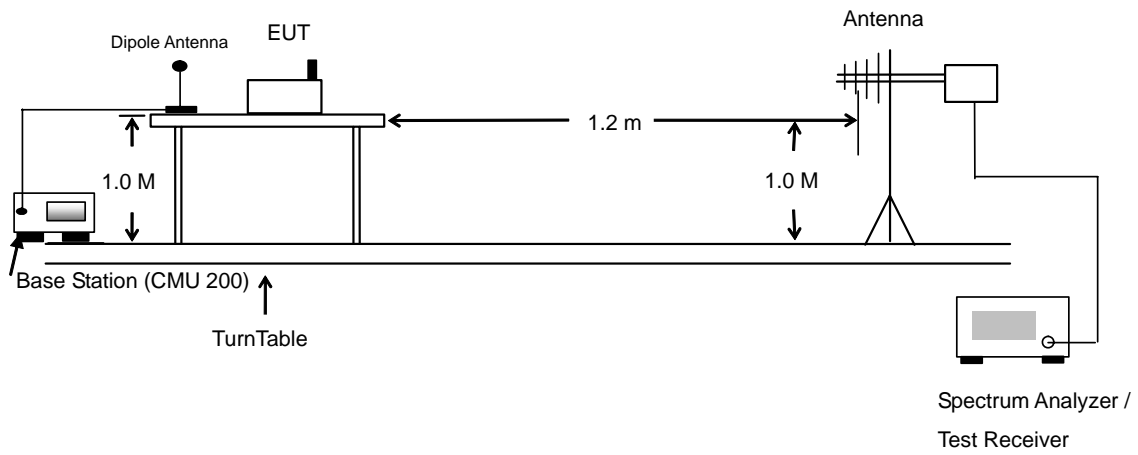



4.3.4 Test Result

<b>PCS (GSM) Radiated Power EIRP</b>						
Horizontal Polarization						
Frequency (MHz)	Rt (dBm)	Rs (dBm)	Ps (dBm)	Gs (dBi)	EIRP (dBm)	EIRP (W)
1850.20	-24.45	-51.88	0.00	1.96	29.39	0.87
1880.00	-25.81	-52.99	0.00	2.00	29.18	0.83
1909.80	-27.35	-54.28	0.00	1.98	28.91	0.78
Vertical Polarization						
Frequency (MHz)	Rt (dBm)	Rs (dBm)	Ps (dBm)	Gs (dBi)	EIRP (dBm)	EIRP (W)
<b>1850.20</b>	<b>-22.63</b>	<b>-52.13</b>	<b>0.00</b>	<b>1.96</b>	<b>31.46</b>	<b>1.40</b>
1880.00	-24.16	-53.17	0.00	2.00	31.01	1.26
1909.80	-25.23	-54.13	0.00	1.98	30.88	1.22

<b>PCS (EDGE) Radiated Power EIRP</b>						
Horizontal Polarization						
Frequency (MHz)	Rt (dBm)	Rs (dBm)	Ps (dBm)	Gs (dBi)	EIRP (dBm)	EIRP (W)
1850.20	-28.19	-51.88	0.00	1.96	25.65	0.37
1880.00	-29.25	-52.99	0.00	2.00	25.74	0.37
1909.80	-31.86	-54.28	0.00	1.98	24.40	0.28
Vertical Polarization						
Frequency (MHz)	Rt (dBm)	Rs (dBm)	Ps (dBm)	Gs (dBi)	EIRP (dBm)	EIRP (W)
<b>1850.20</b>	<b>-26.49</b>	<b>-52.13</b>	<b>0.00</b>	<b>1.96</b>	<b>27.60</b>	<b>0.58</b>
1880.00	-28.31	-53.17	0.00	2.00	26.86	0.49
1909.80	-29.75	-54.13	0.00	1.98	26.36	0.43

## 4.4 Occupied Bandwidth and Band Edge Measurement

### 4.4.1 Measurement Instruments

As described in chapter 5 of this test report.

### 4.4.2 Test Procedure

1. The EUT was connected to Spectrum Analyzer and Base Station via power divider.
2. The 99% occupied bandwidth of middle channel for the highest and lowest RF powers were measured.
3. The bandedge of low and high channels for the highest RF powers within the transmitting frequency band were measured. Setting RBW as roughly  $BW/100$ .

### 4.4.3 Test Setup Layout

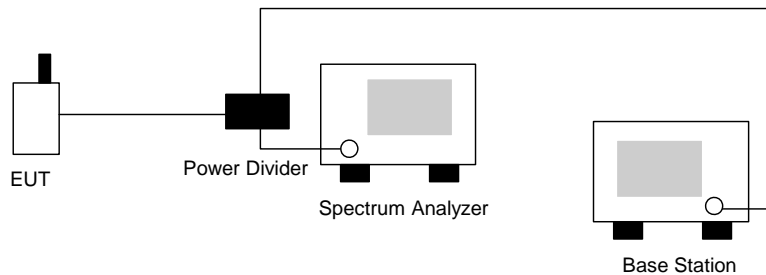



4.4.4 Test Result

- Mode 1
- Test Mode : PCS (GSM) CH512 Lower Band Edge
- Power State : High

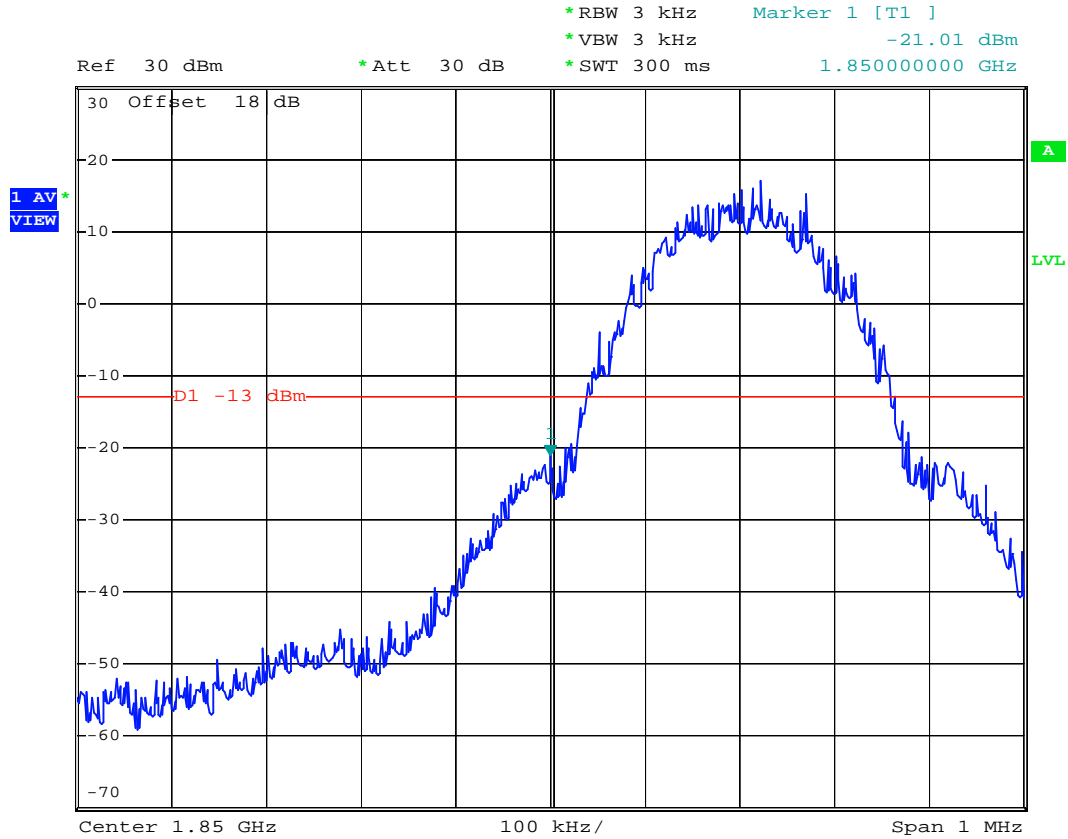

Date: 9.JUN.2007 16:50:10

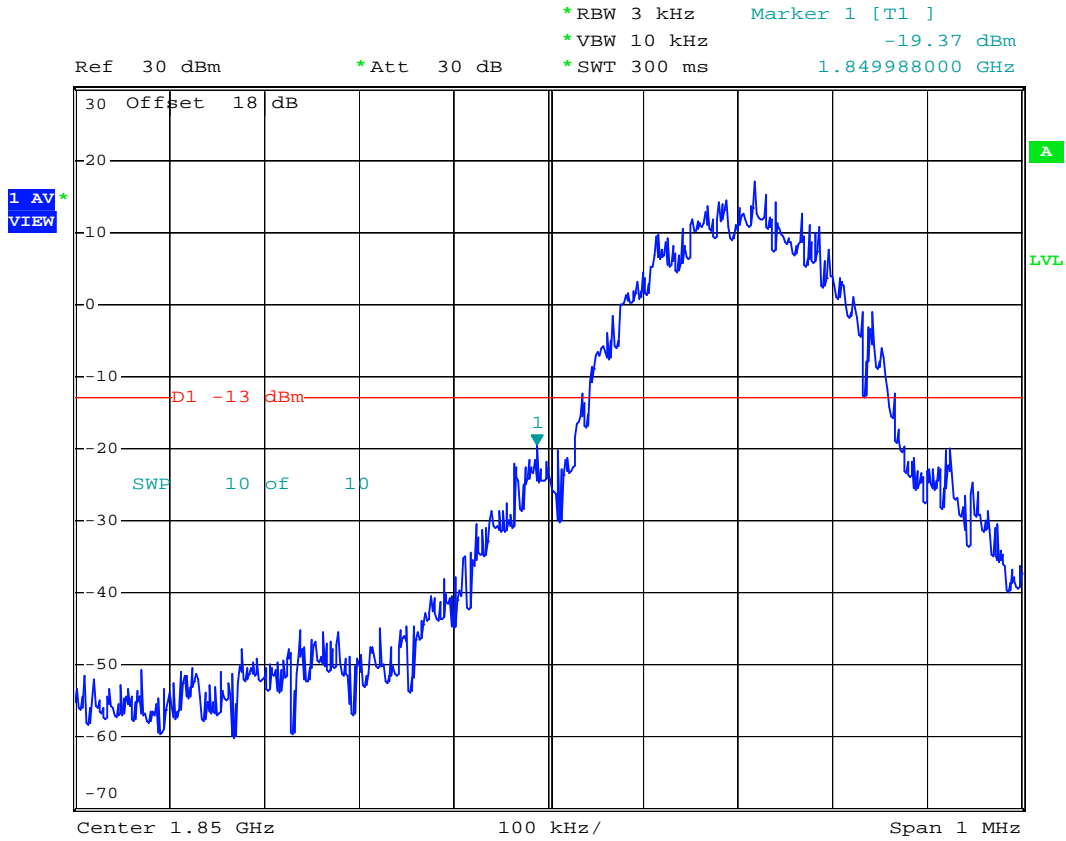

Date: 9.JUN.2007 16:49:39







- Test Mode : PCS (GSM) CH661 99% Occupied Bandwidth
- Power State : High

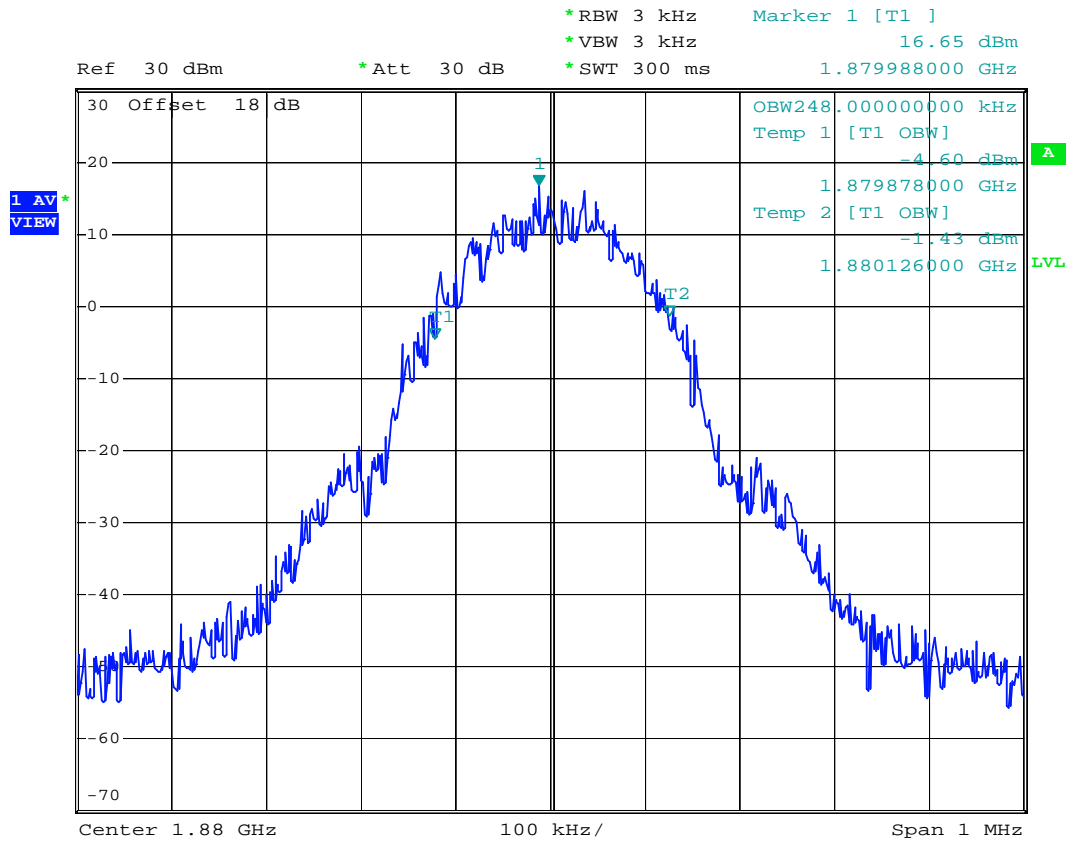

Date: 9.JUN.2007 16:52:28

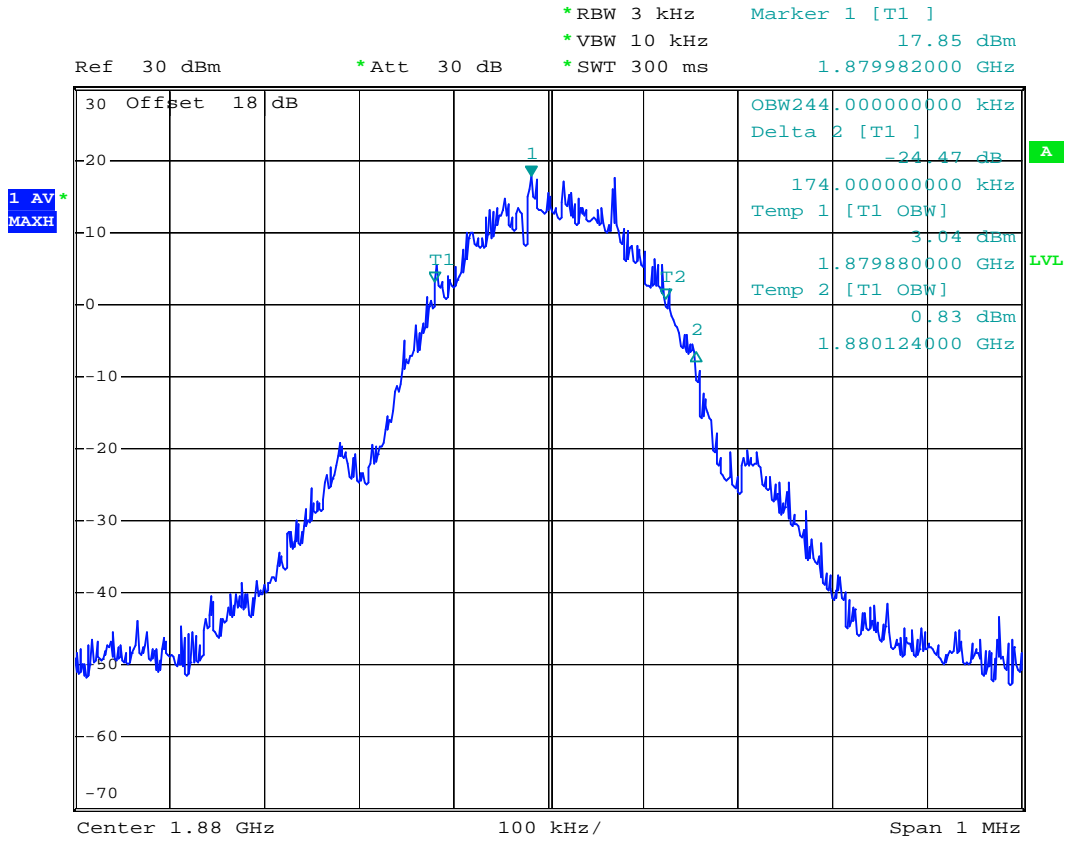

Date: 20.JUN.2007 20:38:58



- Test Mode : PCS (GSM) CH512 26dB Bandwidth
- Power State : High

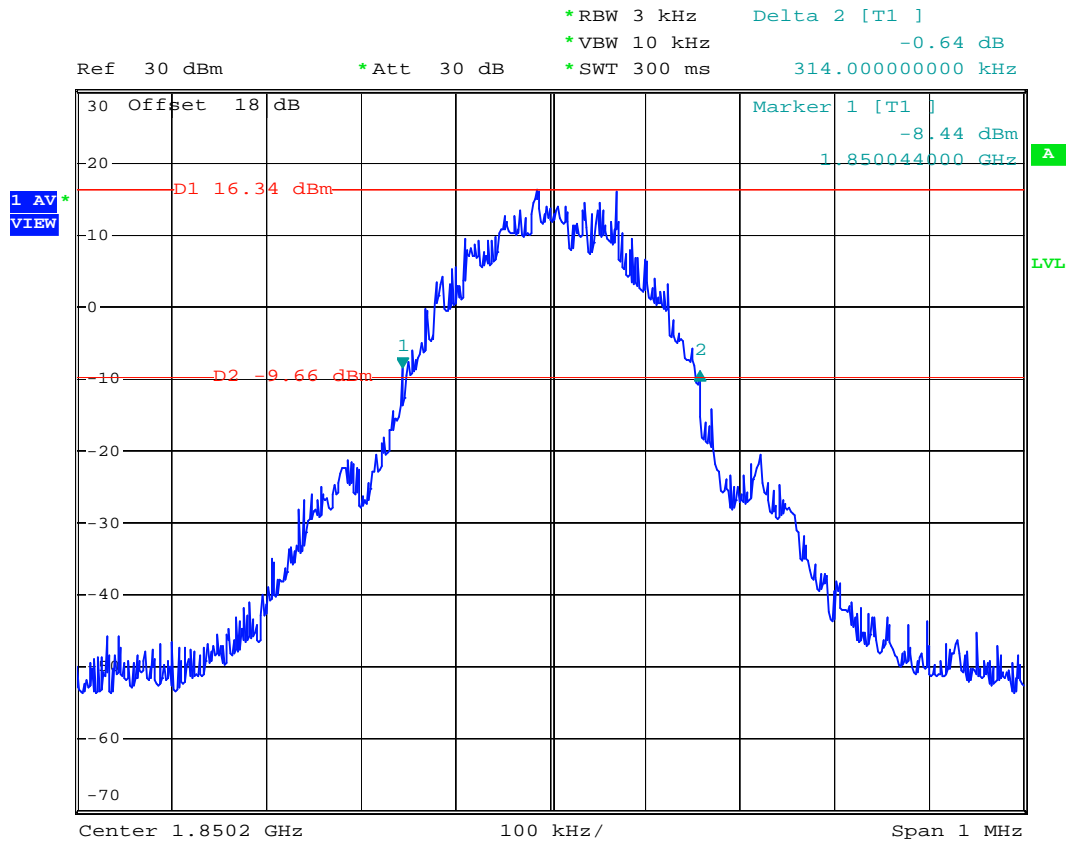

Date: 20.JUN.2007 20:47:27



- Test Mode : PCS (GSM) CH661 26dB Bandwidth
- Power State : High

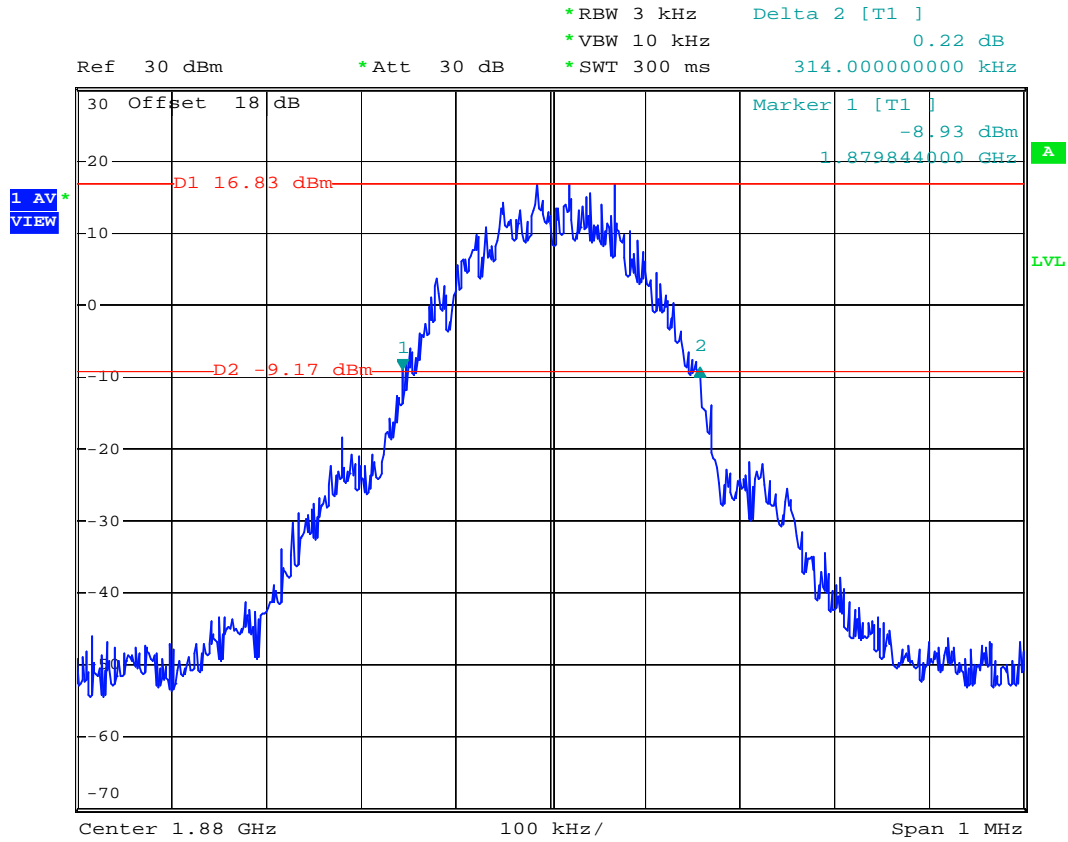

Date: 20.JUN.2007 20:48:14



- Test Mode : PCS (GSM) CH810 26dB Bandwidth
- Power State : High

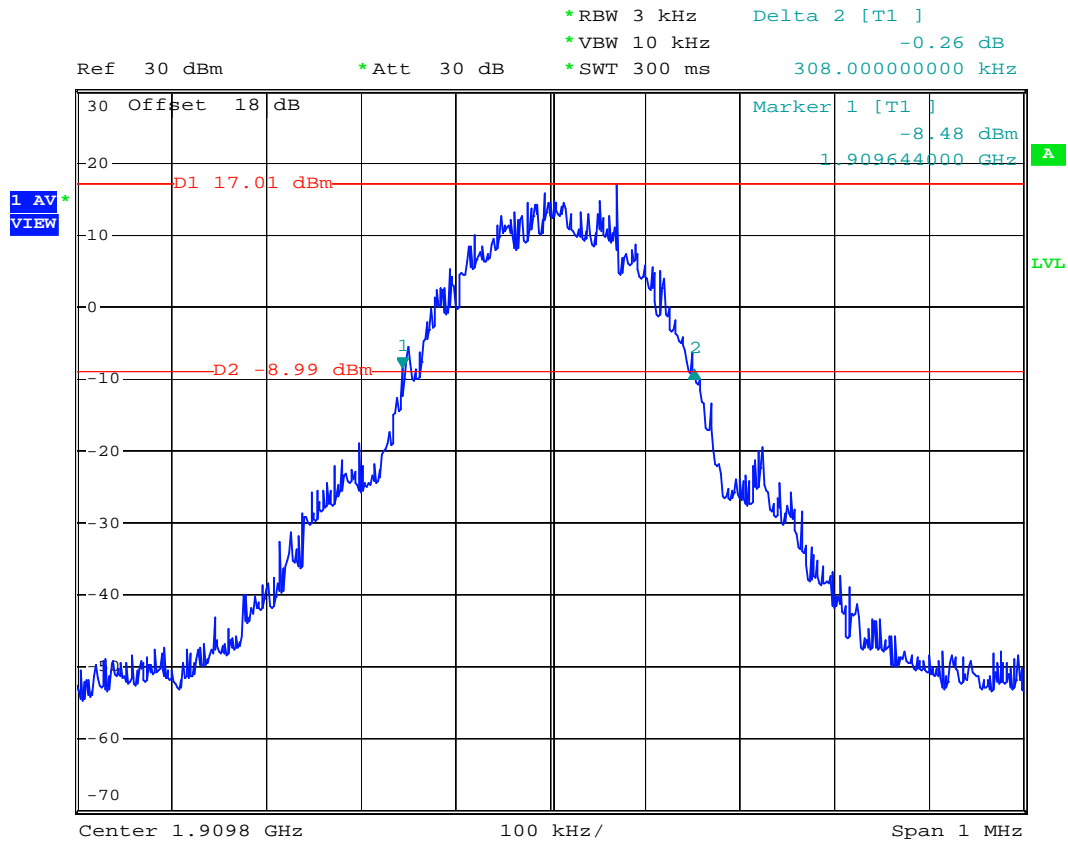

Date: 20.JUN.2007 20:49:10



- Test Mode : PCS (GSM) CH810 Higher Band Edge
- Power State : High

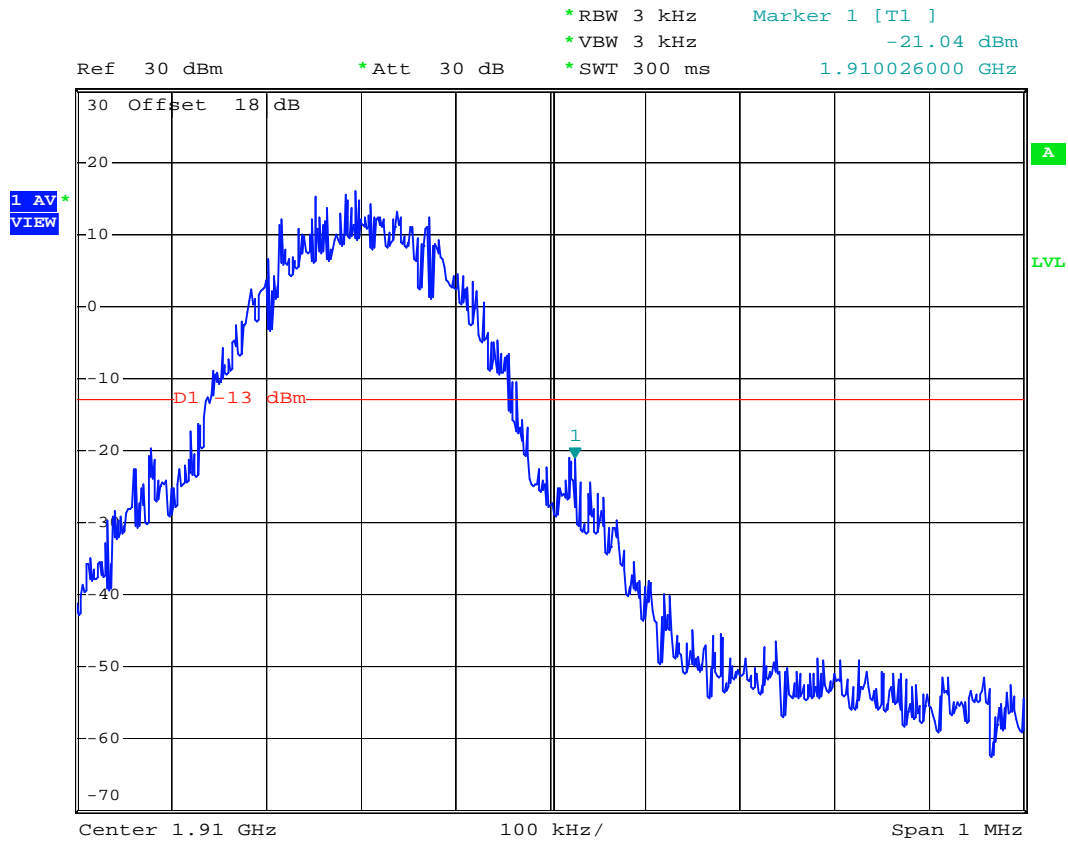

Date: 9.JUN.2007 16:50:55

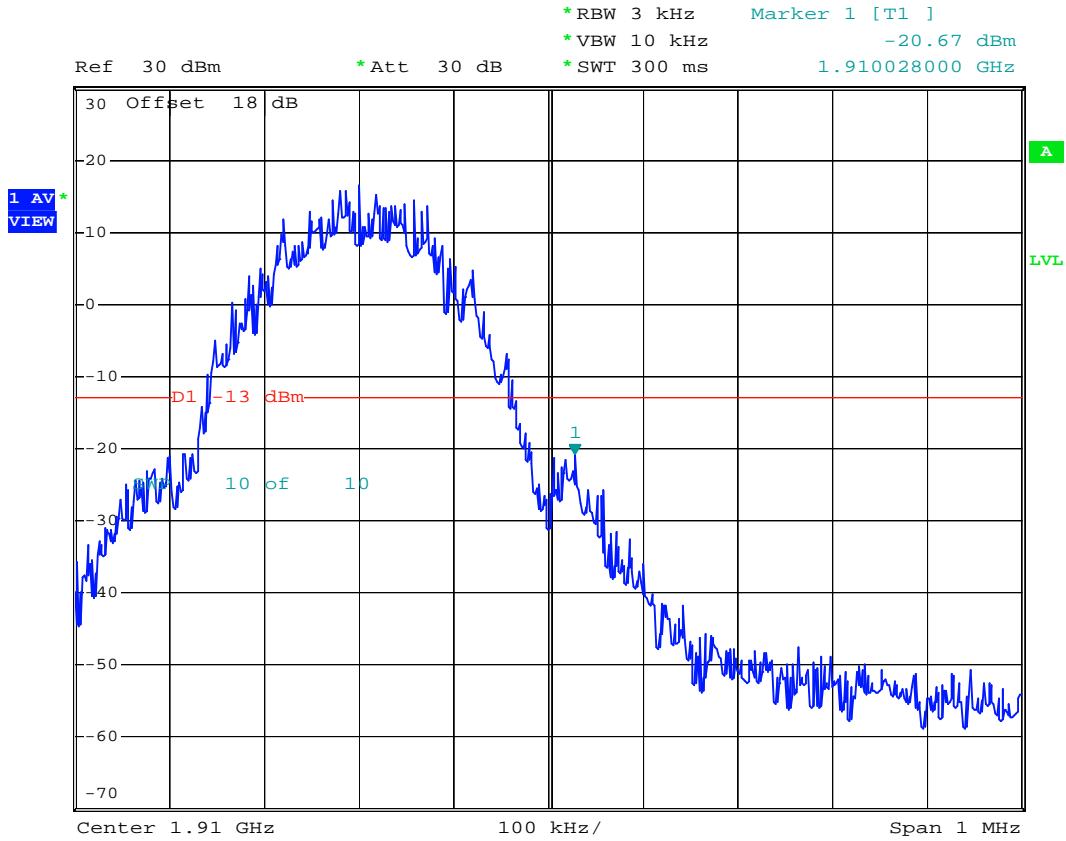

Date: 9.JUN.2007 16:51:21



- Mode 2
- Test Mode : PCS (EDGE) CH512 Lower Band Edge
- Power State : High

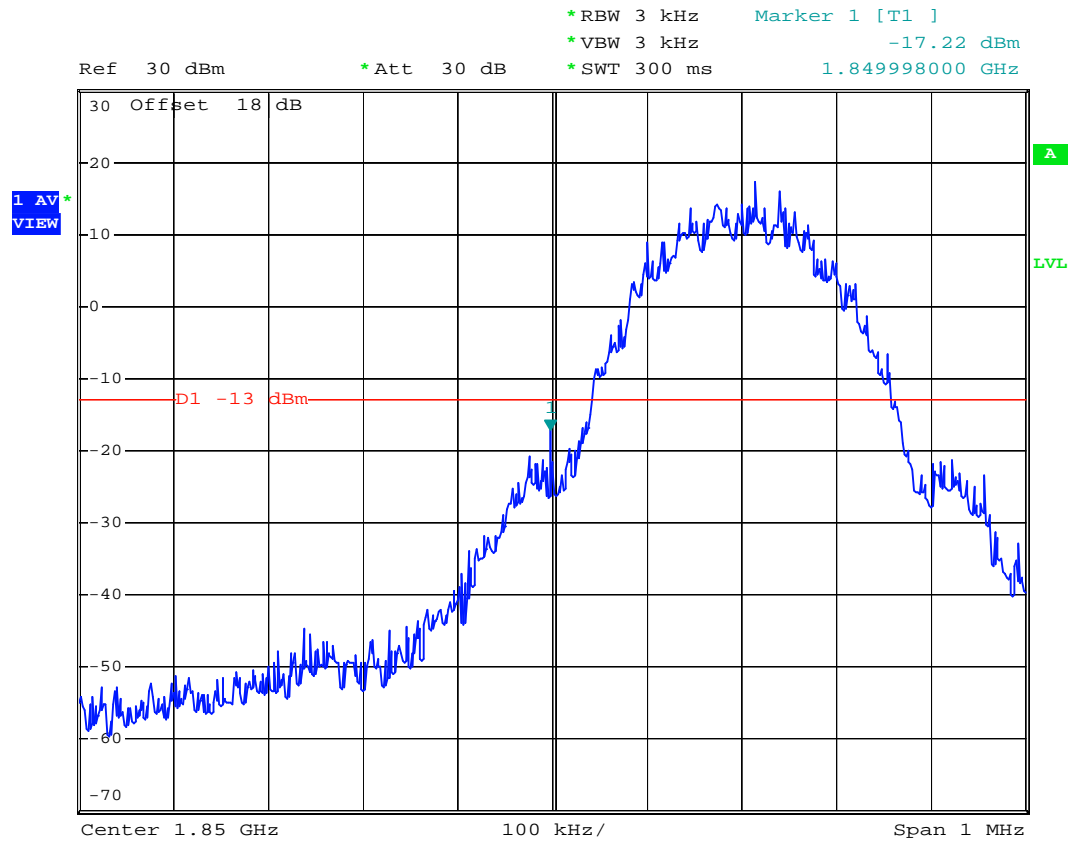

Date: 9.JUN.2007 17:08:46



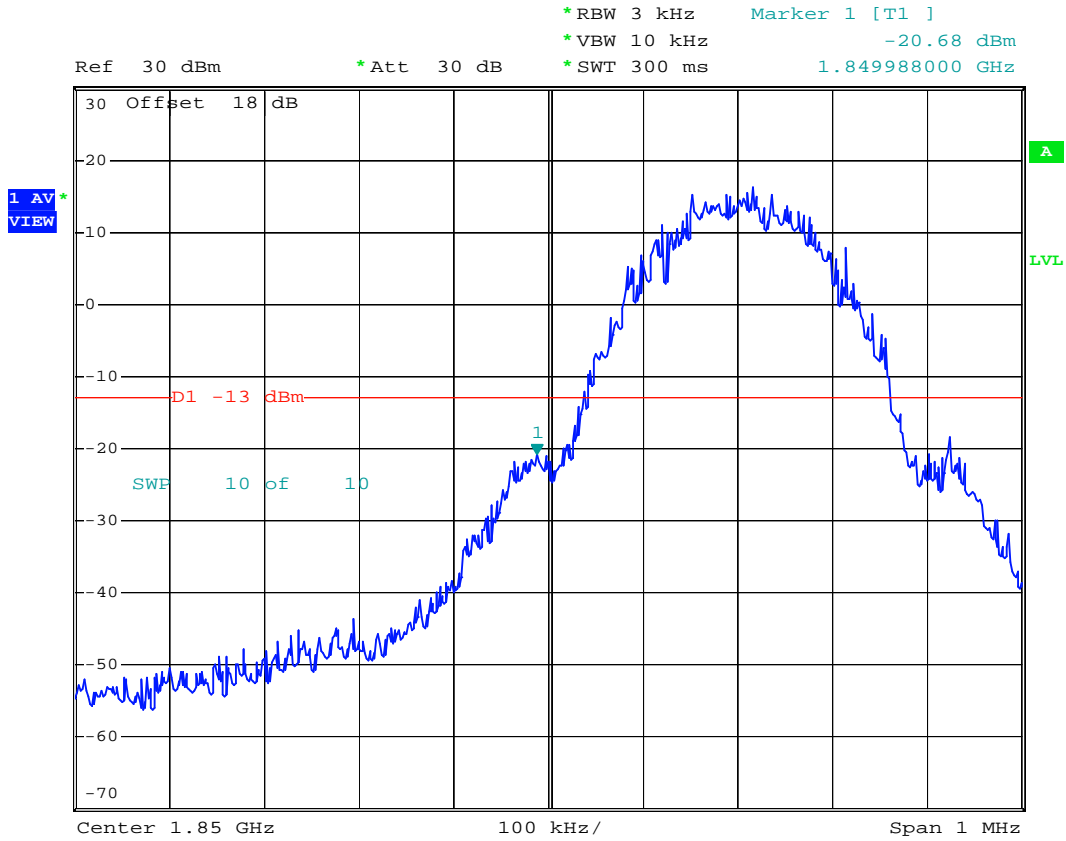

Date: 9.JUN.2007 17:09:48





- Test Mode : PCS (EDGE) CH661 99% Occupied Bandwidth
- Power State : High

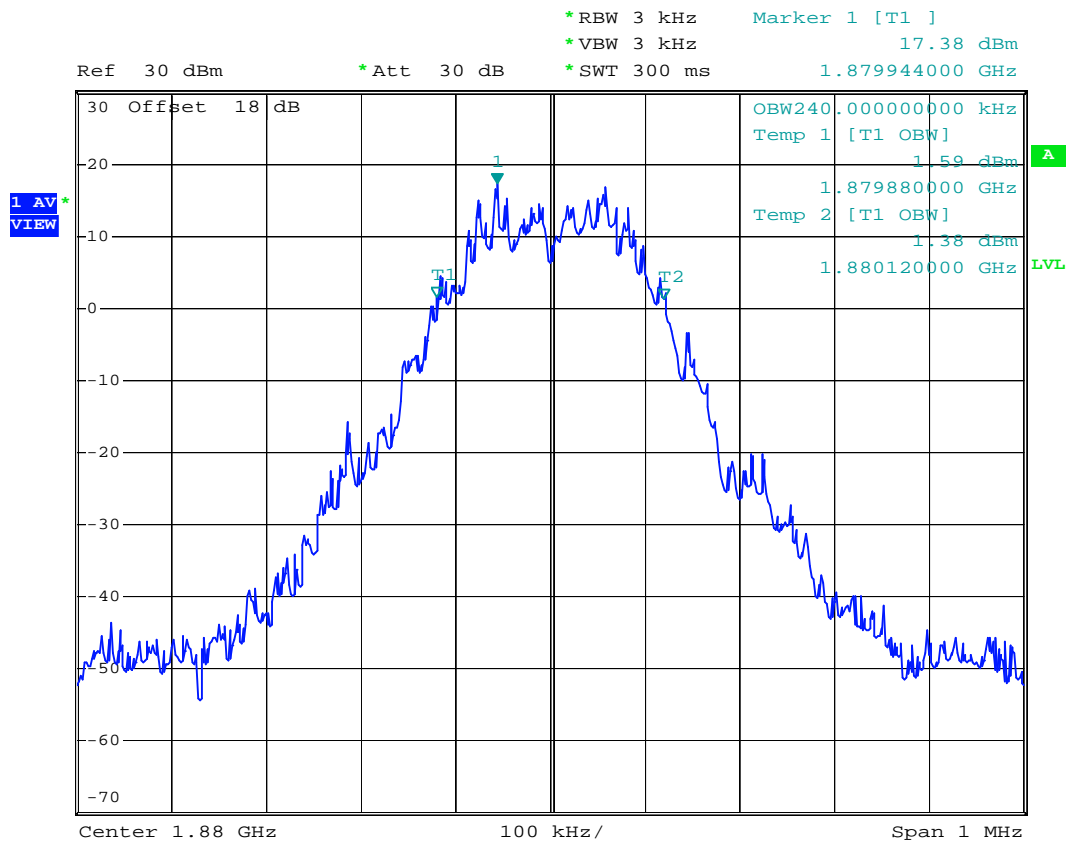

Date: 11.JUN.2007 10:23:46

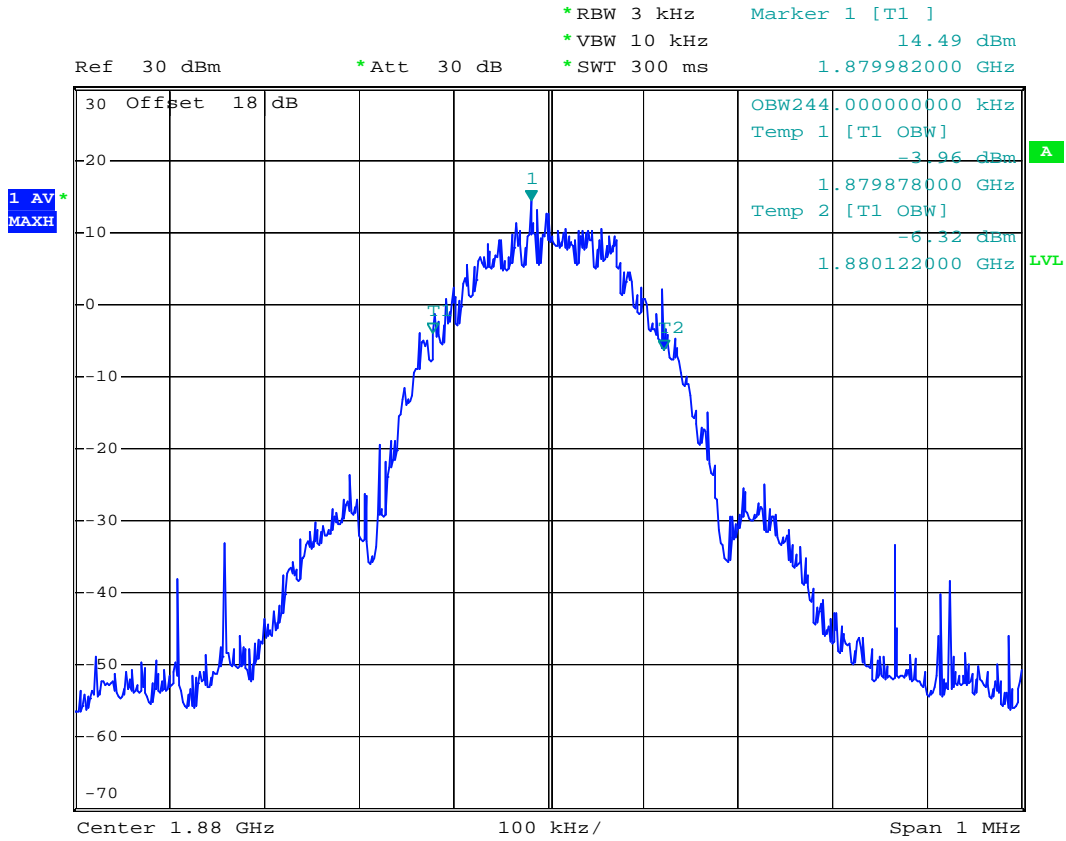

Date: 20.JUN.2007 20:33:39



- Test Mode : PCS (EDGE) CH512 26dB Bandwidth
- Power State : High

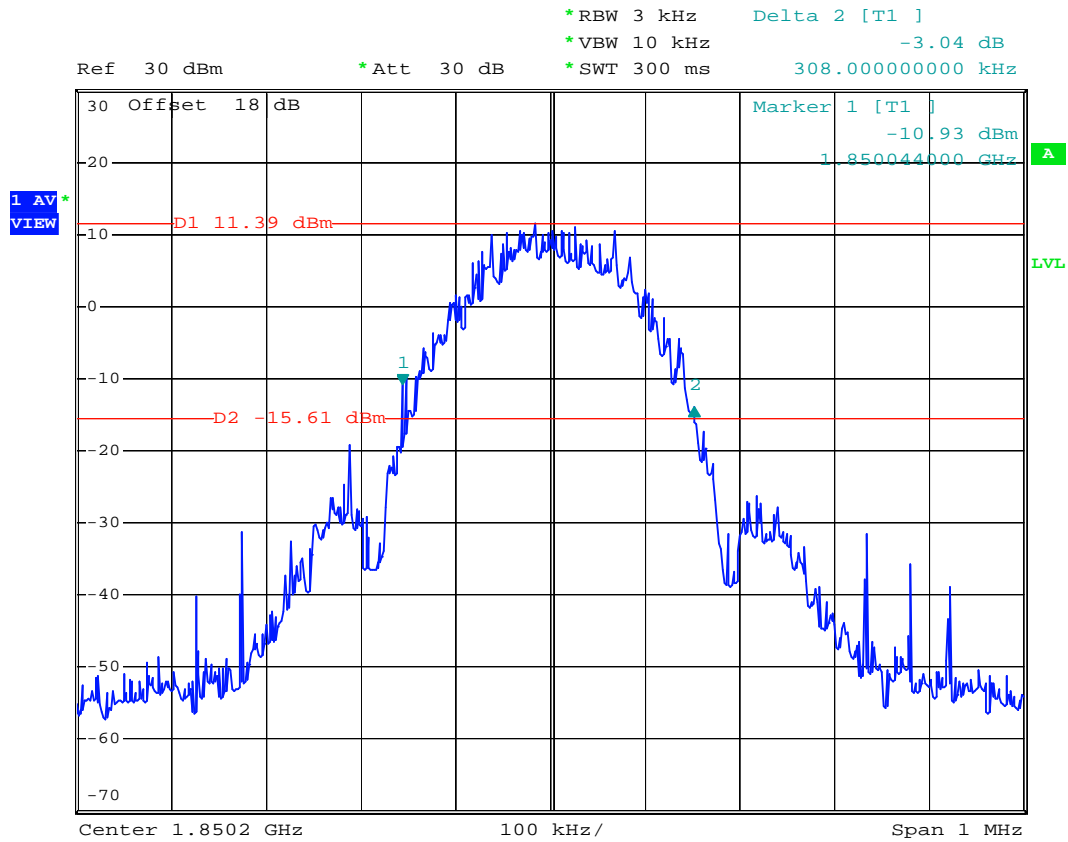

Date: 20.JUN.2007 20:50:42



- Test Mode : PCS (EDGE) CH661 26dB Bandwidth
- Power State : High

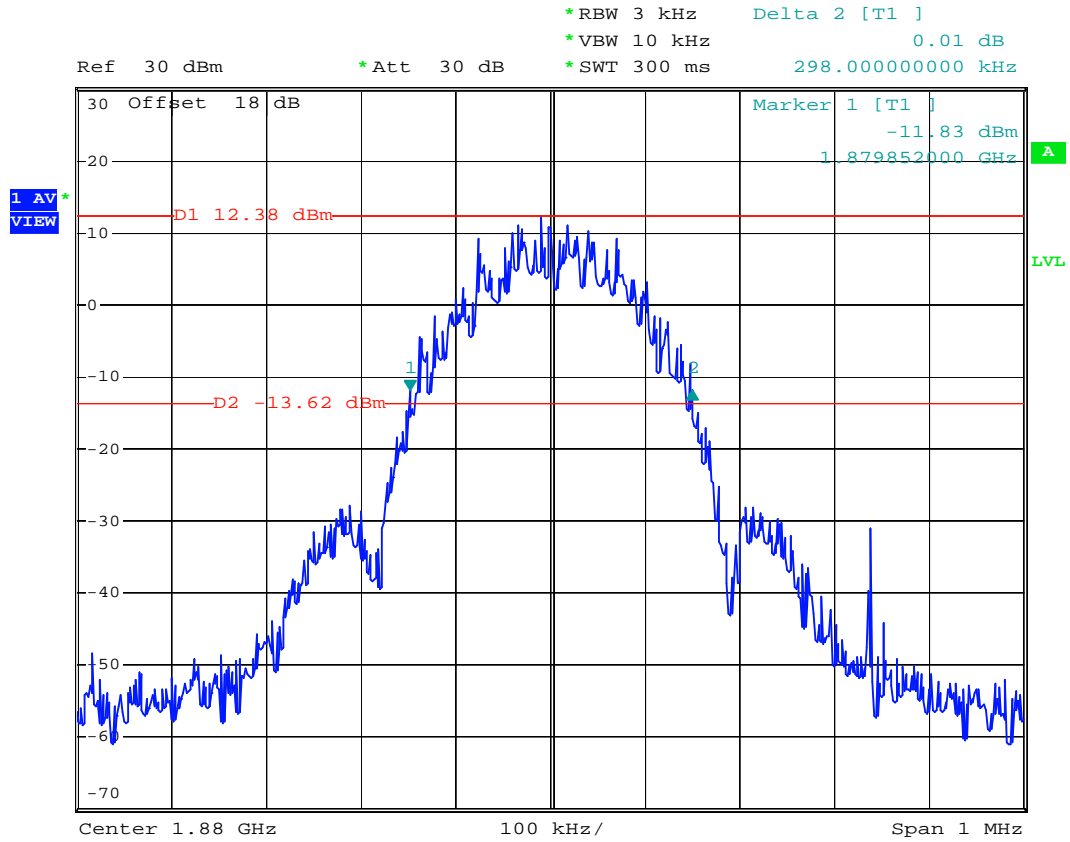

Date: 20.JUN.2007 20:52:25



- Test Mode : PCS (EDGE) CH810 26dB Bandwidth
- Power State : High

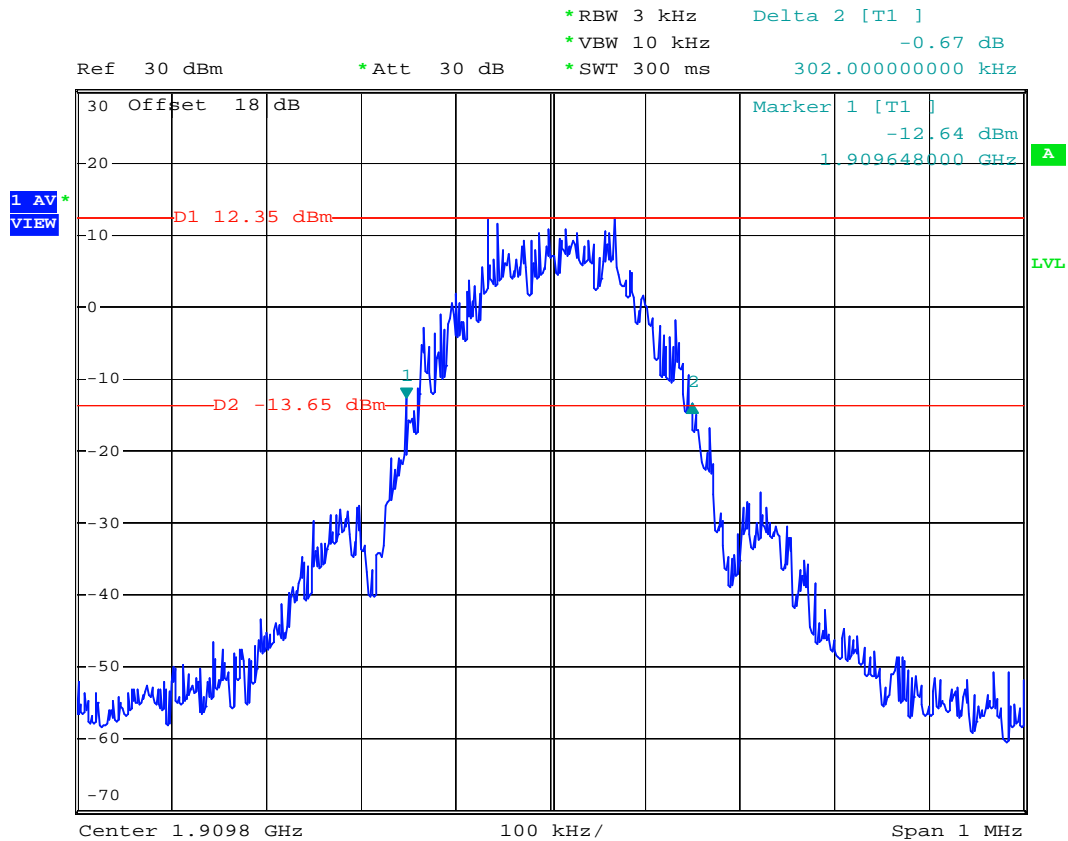

Date: 20.JUN.2007 20:53:12



- Test Mode : PCS (EDGE) CH810 Higher Band Edge
- Power State : High

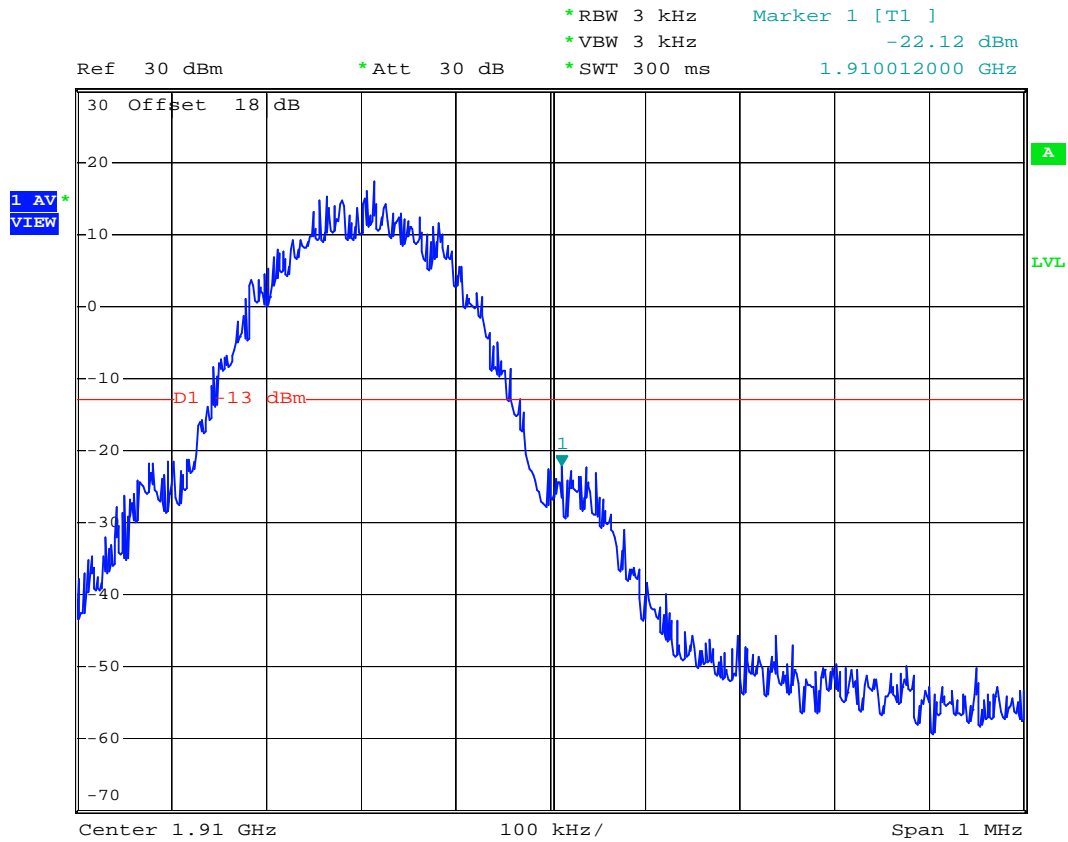

Date: 9.JUN.2007 17:11:06



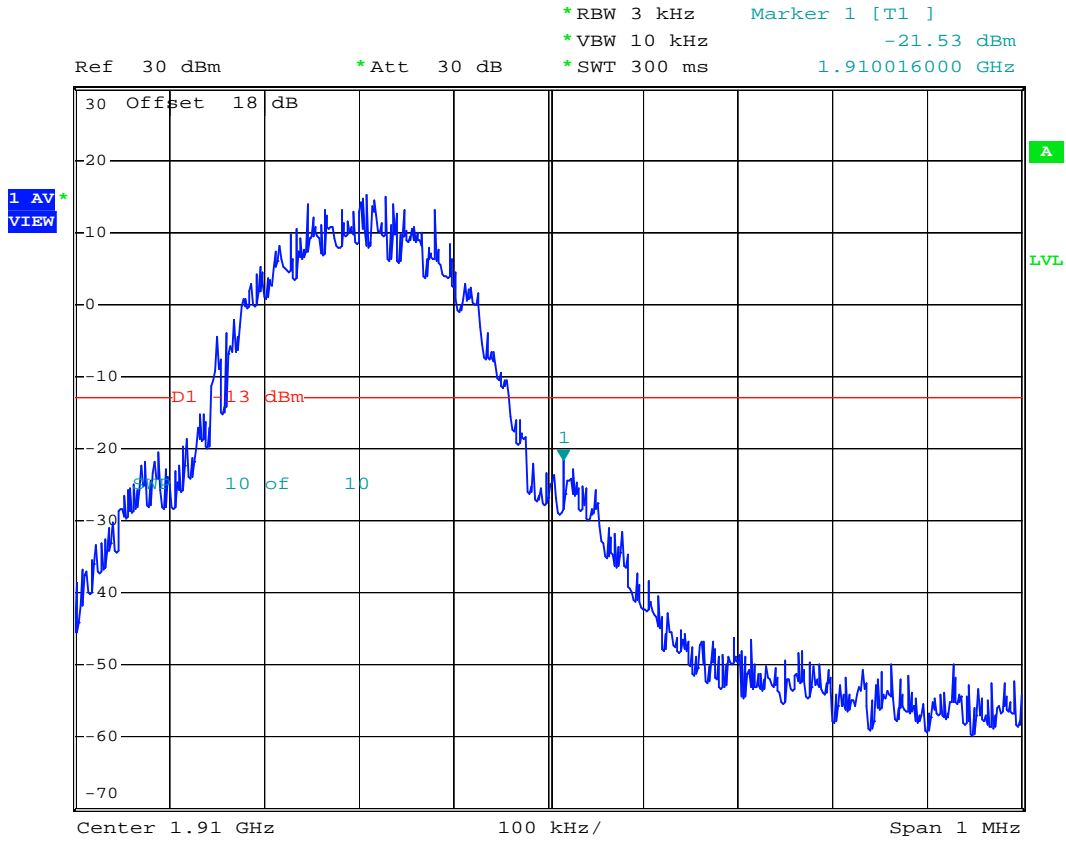

Date: 9.JUN.2007 17:10:19

## 4.5 Conducted Emission

### 4.5.1 Measurement Instruments

As described in chapter 5 of this test report.

### 4.5.2 Test Procedure

1. The EUT was connected to Spectrum Analyzer and Base Station via power divider.
2. The middle channel for the highest RF power within the transmitting frequency was measured.
3. The conducted spurious emission for the whole frequency range was taken.

### 4.5.3 Test Setup Layout

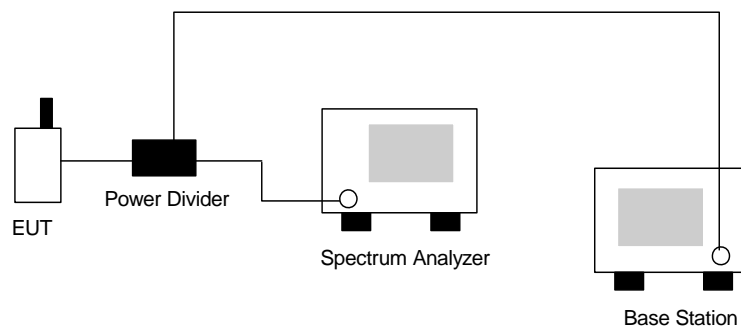



4.5.4 Test Result

- Mode 1
- Test Mode : PCS (GSM) CH661
- Frequency Range : 30M-1G

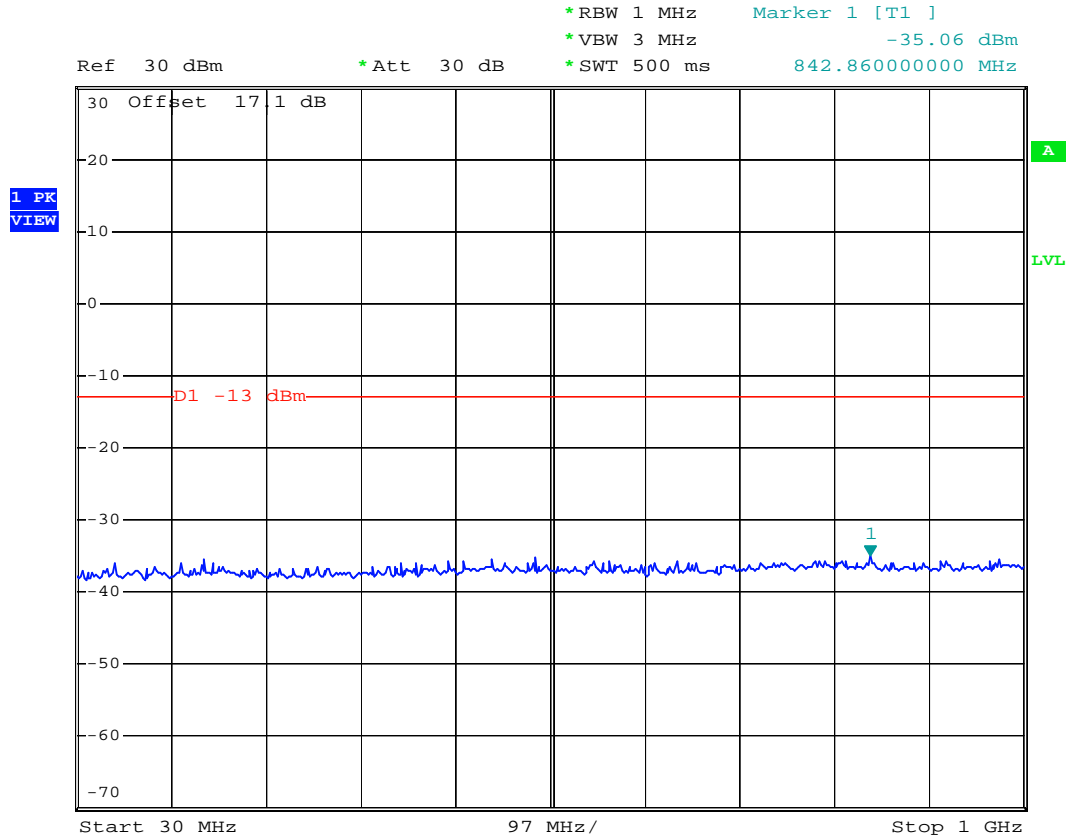

Date: 9.JUN.2007 17:01:04



- Test Mode : PCS (GSM) CH661
- Frequency Range : 1G-3G

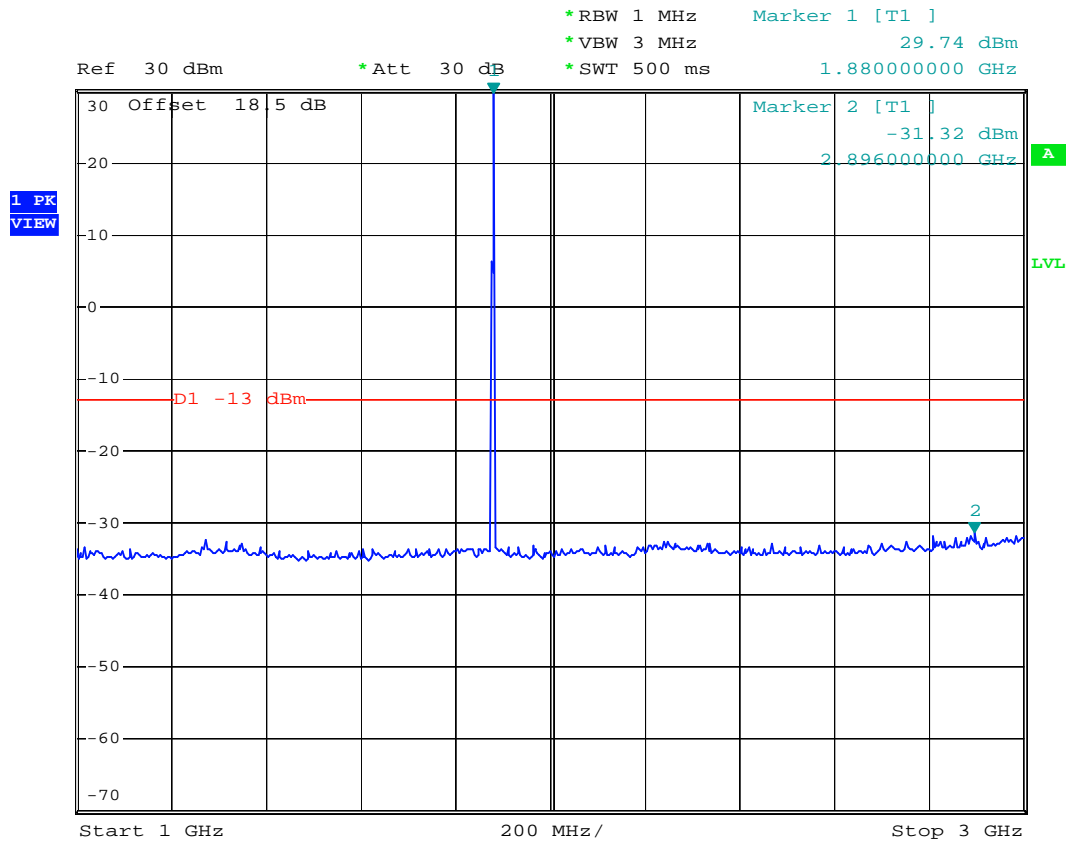

Date: 9.JUN.2007 16:59:29



- Test Mode : PCS (GSM) CH661
- Frequency Range : 3G-7G

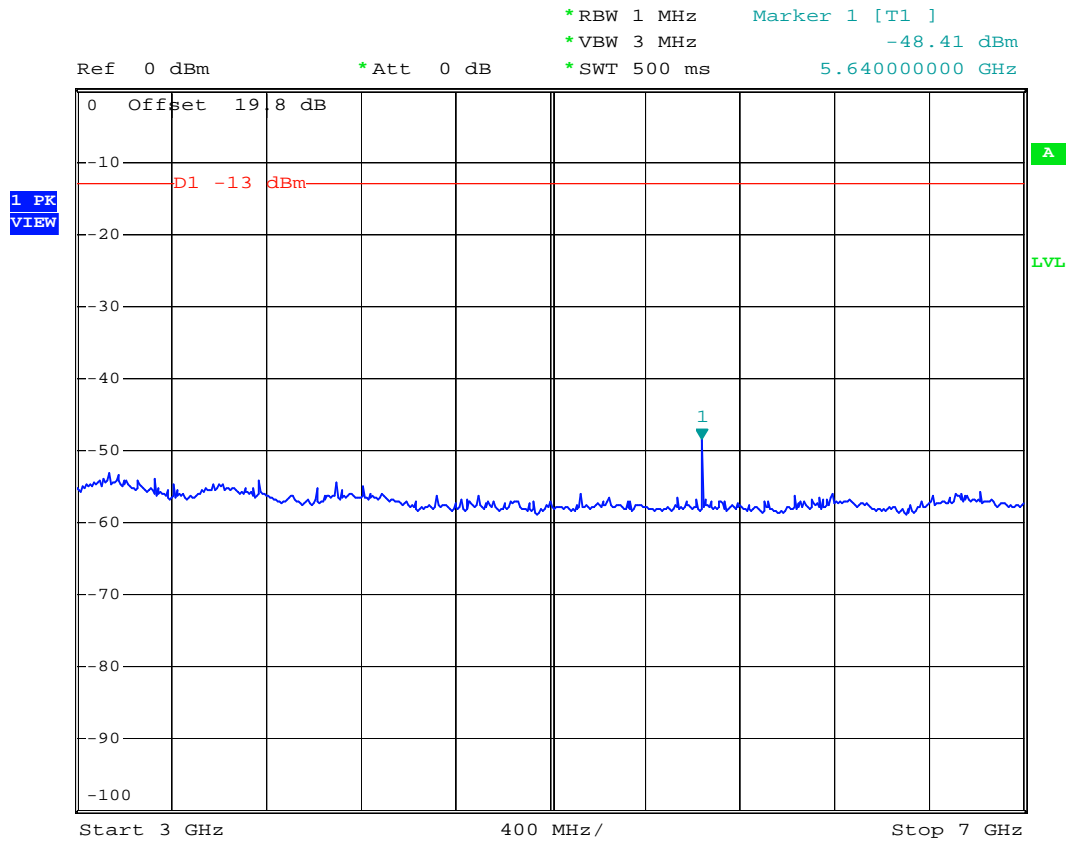

Date: 9.JUN.2007 17:03:24



- Test Mode : PCS (GSM) CH661
- Frequency Range : 7G-13.6G

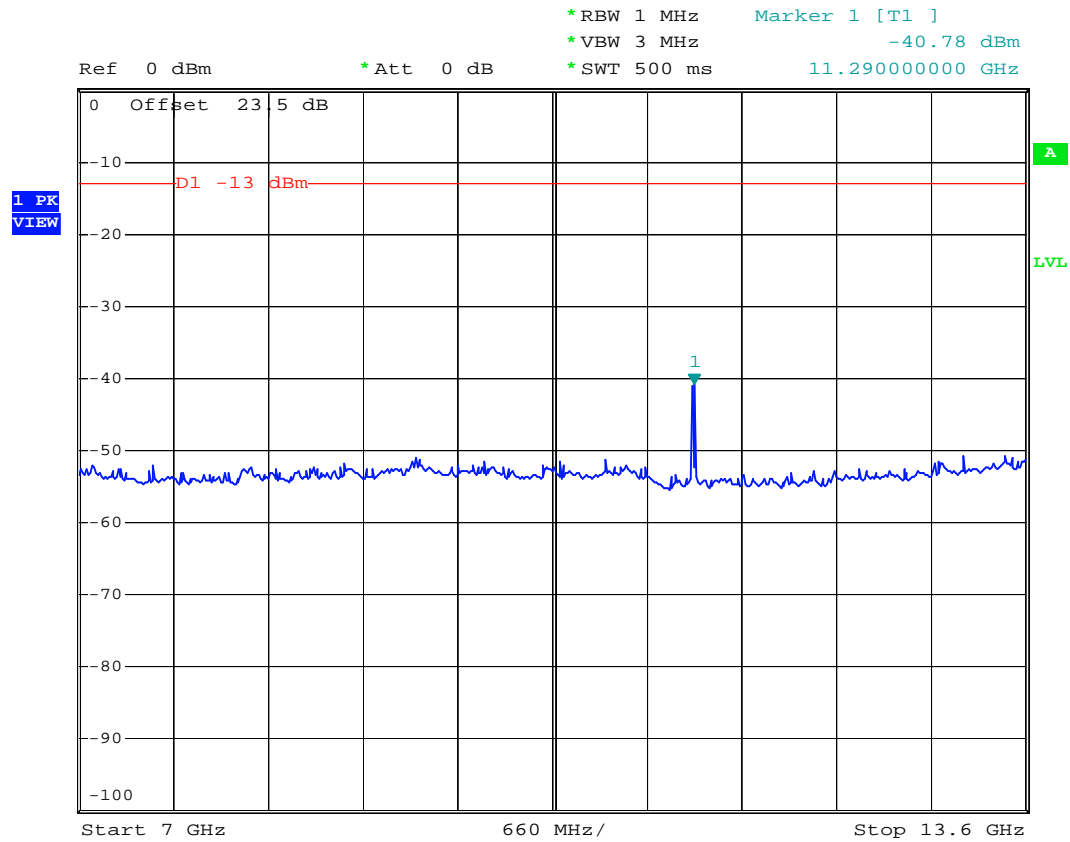

Date: 9.JUN.2007 17:04:36



- Test Mode : PCS (GSM) CH661
- Frequency Range : 13.6G-19.1G

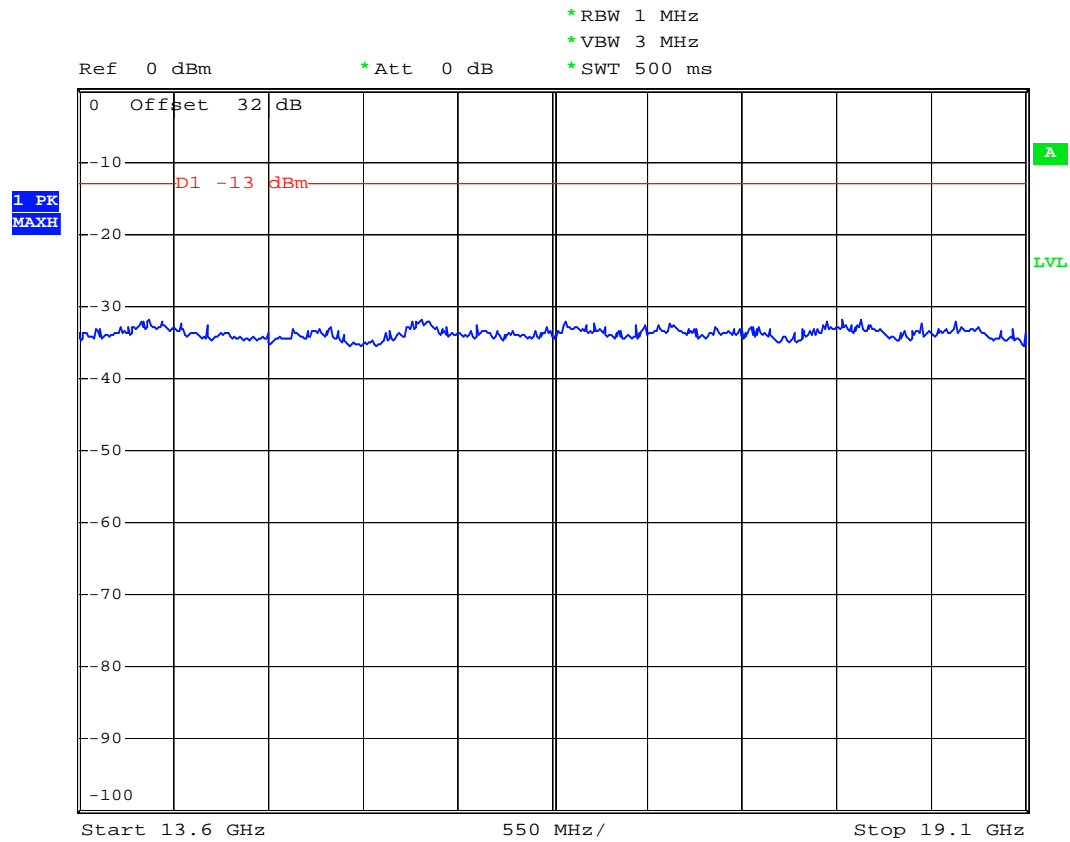

Date: 9.JUN.2007 17:05:28

## 4.6 Field Strength of Spurious Radiation

Equivalent isotropic radiated Power Measurements by substitution method according to ANSI/TIA/EIA-603-C.

### 4.6.1 Measurement Instruments

As described in chapter 5 of this test report.

### 4.6.2 Test Procedure

1. The EUT was placed on a rotatable wooden table with 0.8 meter about ground.
2. The EUT was set 3 meters from the receiving antenna which was mounted on the antenna tower.
3. The table was rotated 360 degrees to determine the position of the highest spurious emission.
4. The height of the receiving antenna is varied between one meter and four meters to reach the maximum spurious emission for both horizontal and vertical polarizations.
5. Taking the record of maximum spurious emission.
6. A Horn antenna was substituted in place of the EUT and was driven by a signal generator.
7. Tune the output power of signal generator to the same emission level with EUT maximum spurious emission.
8. Taking the record of output power at antenna port.
9. Repeat step 7 to step 8 for another polarization.
10. Emission level (dBm) = output power + substitution Gain.

### 4.6.3 Test Setup Layout

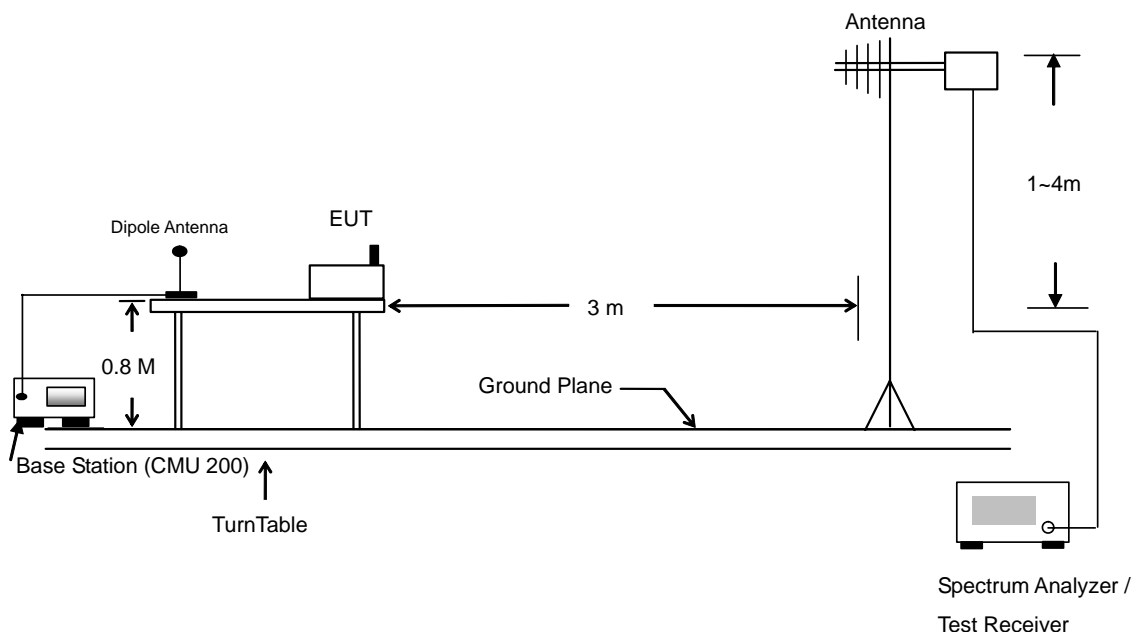





## 4.6.4 Test Result

- Test Mode : Mode 1

<b>PCS1900 (GSM) Radiated Spurious EIRP</b>							
H Polarization				V Polarization			
Frequency (MHz)	EIRP (dBm)	Limit (dBm)	Margin (dB)	Frequency (MHz)	EIRP (dBm)	Limit (dBm)	Margin (dB)
58.080	-50.170	-13	-37.17	58.080	-53.900	-13	-40.90
71.580	-49.090	-13	-36.09	168.240	-41.840	-13	-28.84
150.690	-49.290	-13	-36.29	196.590	-51.280	-13	-38.28
311.900	-60.370	-13	-47.37	322.400	-60.600	-13	-47.60
330.800	-62.080	-13	-49.08	423.900	-61.880	-13	-48.88
358.800	-63.900	-13	-50.90	971.300	-61.580	-13	-48.58
3758.000	-52.050	-13	-39.05	3758.000	-47.150	-13	-34.15
9398.000	-37.300	-13	-24.30	7528.000	-48.210	-13	-35.21
11278.000	-41.770	-13	-28.77	11278.000	-38.630	-13	-25.63
13158.000	-44.120	-13	-31.12	13158.000	-43.840	-13	-30.84
				16917.000	-42.330	-13	-29.33

- Test Mode : Mode 2

<b>PCS1900 (EDGE) Radiated Spurious EIRP</b>							
H Polarization				V Polarization			
Frequency (MHz)	EIRP (dBm)	Limit (dBm)	Margin (dB)	Frequency (MHz)	EIRP (dBm)	Limit (dBm)	Margin (dB)
128.280	-55.400	-13	-42.40	61.590	-53.560	-13	-40.56
150.690	-56.940	-13	-43.94	71.580	-54.260	-13	-41.26
216.840	-57.040	-13	-44.04	160.680	-51.490	-13	-38.49
365.800	-60.090	-13	-47.09	306.300	-64.550	-13	-51.55
493.900	-62.180	-13	-49.18	325.900	-65.150	-13	-52.15
782.300	-61.940	-13	-48.94	995.800	-61.420	-13	-48.42
7518.000	-44.810	-13	-31.81	3758.000	-48.540	-13	-35.54
9398.000	-39.640	-13	-26.64	5638.000	-53.170	-13	-40.17
11278.000	-39.260	-13	-26.26	7518.000	-42.650	-13	-29.65
				9398.000	-38.210	-13	-25.21
				11278.000	-31.860	-13	-18.86
				13158.000	-45.030	-13	-32.03



- Test Mode : Mode 3

PCS1900 (GSM) with Bluetooth Radiated Spurious EIRP							
H Polarization				V Polarization			
Frequency (MHz)	EIRP (dBm)	Limit (dBm)	Margin (dB)	Frequency (MHz)	EIRP (dBm)	Limit (dBm)	Margin (dB)
31.080	-54.740	-13	-41.74	88.590	-50.070	-13	-37.07
156.090	-62.810	-13	-49.81	142.590	-54.650	-13	-41.65
294.330	-58.710	-13	-45.71	153.930	-56.530	-13	-43.53
330.800	-60.310	-13	-47.31	332.900	-60.950	-13	-47.95
378.400	-63.870	-13	-50.87	700.400	-61.330	-13	-48.33
799.800	-62.930	-13	-49.93	1000.000	-61.310	-13	-48.31
1278.000	-54.590	-13	-41.59	1498.000	-52.640	-13	-39.64
1384.000	-54.190	-13	-41.19	1638.000	-53.410	-13	-40.41
1508.000	-56.080	-13	-43.08	3758.000	-19.860	-13	-6.86
3758.000	-26.300	-13	-13.30	5638.000	-51.350	-13	-38.35
5638.000	-52.070	-13	-39.07	7518.000	-42.490	-13	-29.49
7518.000	-45.310	-13	-32.31	9398.000	-40.690	-13	-27.69
9398.000	-37.820	-13	-24.82	11278.000	-40.830	-13	-27.83
11278.000	-38.740	-13	-25.74				



- Test Mode : Mode 4

<b>PCS1900 (GSM) with WLAN Radiated Spurious EIRP</b>							
<b>H Polarization</b>				<b>V Polarization</b>			
<b>Frequency (MHz)</b>	<b>EIRP (dBm)</b>	<b>Limit (dBm)</b>	<b>Margin (dB)</b>	<b>Frequency (MHz)</b>	<b>EIRP (dBm)</b>	<b>Limit (dBm)</b>	<b>Margin (dB)</b>
35.130	-58.420	-13	-45.42	49.980	-54.430	-13	-41.43
61.590	-59.600	-13	-46.60	91.290	-58.680	-13	-45.68
211.980	-55.640	-13	-42.64	237.630	-56.560	-13	-43.56
322.400	-63.610	-13	-50.61	336.400	-61.710	-13	-48.71
526.800	-58.950	-13	-45.95	525.400	-59.060	-13	-46.06
831.300	-62.700	-13	-49.70	987.400	-61.300	-13	-48.30
1344.000	-44.050	-13	-31.05	1348.000	-54.550	-13	-41.55
1658.000	-50.620	-13	-37.62	1658.000	-57.500	-13	-44.50
2864.000	-53.080	-13	-40.08	2944.000	-50.270	-13	-37.27
2944.000	-53.870	-13	-40.87	3758.000	-22.820	-13	-9.82
3758.000	-30.340	-13	-17.34	5638.000	-51.930	-13	-38.93
5638.000	-50.800	-13	-37.80	7518.000	-43.330	-13	-30.33
9398.000	-42.600	-13	-29.60	9398.000	-37.450	-13	-24.45
11278.000	-34.280	-13	-21.28	11278.000	-33.150	-13	-20.15



4.6.5 Test Data

4.6.5.1 Mode 1

Horizontal Polarization

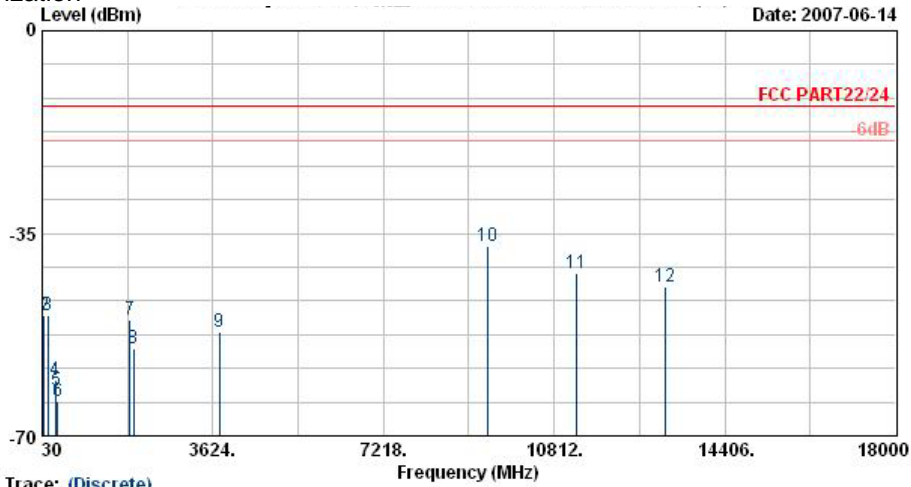

Trace: (Discrete)

Site : 03CH06-HY  
 Condition : HP-SPURIOUS HORIZONTAL  
 EUT : PDA Phone  
 Power : 120Vac 60Hz  
 Model : FG760116-01  
 Memo : PCS 1900 Link Mode ; CH661+Adaptor  
 Plane : E2  
 Memo :

	Freq	Level	Over Limit	Limit Line	ReadAntenna Level	Antenna Factor	Cable Loss	Preamp Factor	Ant Pos	Table Pos	Remark
	MHz	dBm	dB	dBm	dBm	dB	dB	dB	cm	deg	
1	58.08	-50.17	-37.17	-13.00	-37.77	-12.40	0.00	0.00	---	---	Peak
2	71.58	-49.09	-36.09	-13.00	-36.74	-12.35	0.00	0.00	---	---	Peak
3	150.69	-49.29	-36.29	-13.00	-36.47	-12.82	0.00	0.00	---	---	Peak
4	311.90	-60.37	-47.37	-13.00	-50.86	-9.51	0.00	0.00	---	---	Peak
5	330.80	-62.08	-49.08	-13.00	-53.20	-8.87	0.00	0.00	---	---	Peak
6	358.80	-63.90	-50.90	-13.00	-56.00	-7.90	0.00	0.00	---	---	Peak
7	1878.00	-50.08	-37.08			-0.51	0.00	0.00	---	---	Peak
8	1958.00	-54.92	-41.92			-1.11	0.00	0.00	---	---	Peak
9	3758.00	-52.05	-39.05	-13.00	-59.97	7.92	0.00	0.00	---	---	Peak
10 @	9398.00	-37.30	-24.30	-13.00	-55.52	18.22	0.00	0.00	---	---	Peak
11	11278.00	-41.77	-28.77	-13.00	-62.07	20.30	0.00	0.00	---	---	Peak
12	13158.00	-44.12	-31.12	-13.00	-62.83	18.71	0.00	0.00	---	---	Peak

Remark:

- #7: MS TCH Signal
- #8: BS TCH Signal



Vertical Polarization

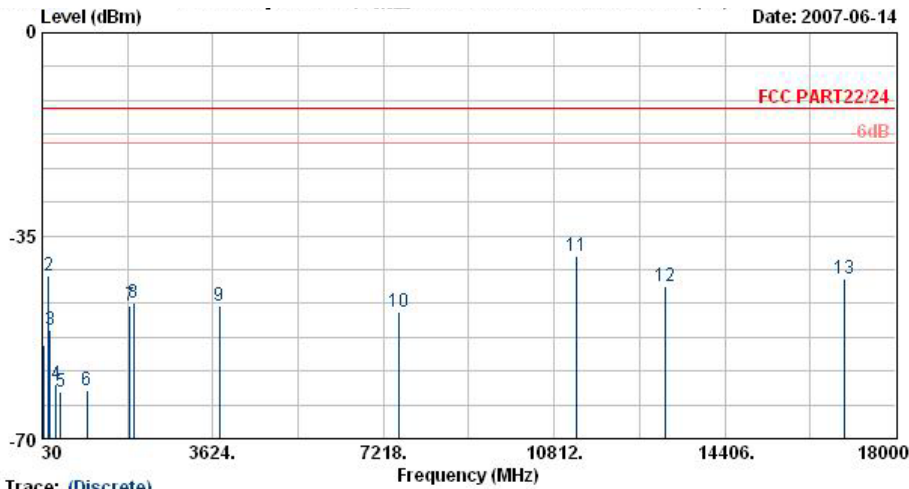

Trace: (Discrete)

Site : 03CH06-HY  
 Condition : HF-SPORTIOUS VERTICAL  
 EUT : PDA Phone  
 Power : 120Vac 60Hz  
 Model : FG760116-01  
 Memo : PCS 1900 Link Mode ; CH661+Adaptor  
 Plane : E2  
 Memo :

	Freq	Level	Over	Limit	Read	Antenna	Cable	Preamp	Ant	Table	Remark
	MHz	dBm	Limit	Line	Level	Factor	Loss	Factor	Pos	Pos	
			dB	dBm	dBm	dB	dB	dB	cm	deg	
1	58.08	-53.90	-40.90	-13.00	-40.20	-13.70	0.00	0.00	---	---	Peak
2	168.24	-41.84	-28.84	-13.00	-33.53	-8.31	0.00	0.00	---	---	Peak
3	196.59	-51.28	-38.28	-13.00	-42.72	-8.56	0.00	0.00	---	---	Peak
4	322.40	-60.60	-47.60	-13.00	-54.62	-5.98	0.00	0.00	---	---	Peak
5	423.90	-61.88	-48.88	-13.00	-57.84	-4.04	0.00	0.00	---	---	Peak
6	971.30	-61.58	-48.58	-13.00	-64.01	2.43	0.00	0.00	---	---	Peak
7	1884.00	-47.21			-46.70	-0.50	0.00	0.00	---	---	Peak
8	1958.00	-46.69			-46.09	-0.60	0.00	0.00	---	---	Peak
9	3758.00	-47.15	-34.15	-13.00	-53.78	6.64	0.00	0.00	---	---	Peak
10	7528.00	-48.21	-35.21	-13.00	-61.57	13.37	0.00	0.00	---	---	Peak
11 @	11278.00	-38.63	-25.63	-13.00	-57.51	18.87	0.00	0.00	---	---	Peak
12	13158.00	-43.84	-30.84	-13.00	-59.63	15.79	0.00	0.00	---	---	Peak
13	16917.00	-42.33	-29.33	-13.00	-61.03	18.70	0.00	0.00	---	---	Peak

Remark:

- #7: MS TCH Signal
- #8: BS TCH Signal

Remark : There is no more obvious emission except the listings above.



4.6.5.2 Mode 2  
Horizontal Polarization

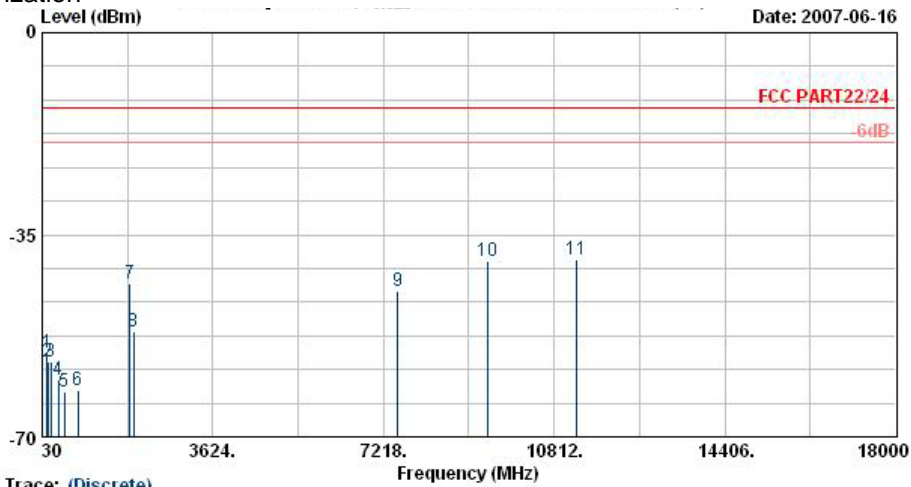

Trace: (Discrete)  
 Site : 03CH06-HY  
 Condition : HF-SPURIOUS HORIZONTAL  
 EUT : PDA Phone  
 Power : 120Vac 60Hz  
 Model : FG760116-01  
 Memo : EDGE Link Mode ; CH661+Adaptor  
 Plane : E2  
 Memo :

	Freq	Level	Over	Limit	Read	Factor	Remark
	MHz	dBm	Limit	Line	Level	dB	
			dB	dBm	dBm		
1	128.28	-55.40	-42.40	-13.00	-42.83	-12.56	Peak
2	150.69	-56.94	-43.94	-13.00	-44.12	-12.82	Peak
3	216.84	-57.04	-44.04	-13.00	-44.26	-12.79	Peak
4	365.80	-60.09	-47.09	-13.00	-52.42	-7.67	Peak
5	493.90	-62.18	-49.18	-13.00	-56.97	-5.21	Peak
6	782.30	-61.94	-48.94	-13.00	-60.07	-1.87	Peak
7	1884.00	-43.58			-42.90	-0.68	Peak
8	1958.00	-51.74			-50.63	-1.11	Peak
9	7518.00	-44.81	-31.81	-13.00	-60.61	15.80	Peak
10	9398.00	-39.64	-26.64	-13.00	-57.87	18.22	Peak
11	11278.00	-39.26	-26.26	-13.00	-59.56	20.30	Peak

Remark:

1. #7: MS TCH Signal
2. #8: BS TCH Signal



Vertical Polarization

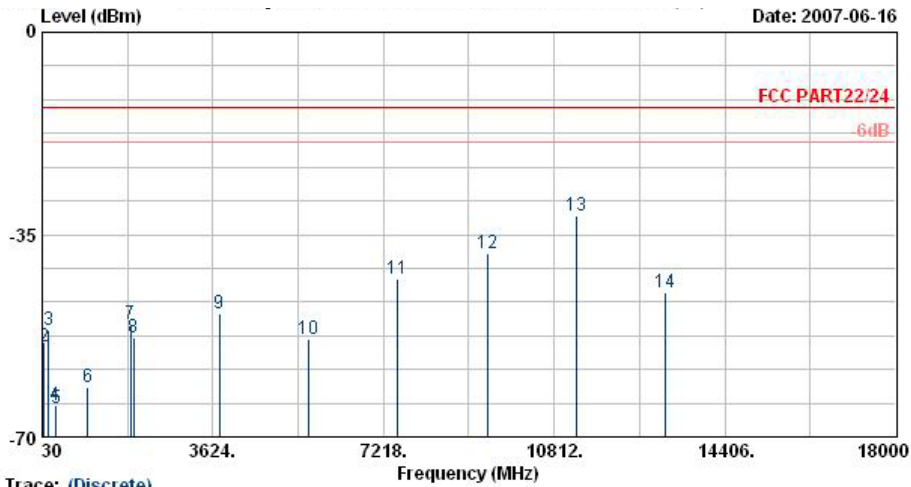

Trace: (Discrete)

Site : D3CH06-HY  
 Condition : HF-SPORTON VERTICAL  
 EUT : PDA Phone  
 Power : 120Vac 60Hz  
 Model : FG760116-01  
 Memo : EDGE Link Mode ; CH661+Adaptor  
 Plane : E2  
 Memo :

	Freq	Level	Over	Limit	Read	Factor	Remark
	MHz	dBm	Limit	Line	Level	dB	
			dB	dBm	dBm		
1	61.59	-53.56	-40.56	-13.00	-40.42	-13.14	Peak
2	71.58	-54.26	-41.26	-13.00	-42.52	-11.74	Peak
3	160.68	-51.49	-38.49	-13.00	-43.25	-8.24	Peak
4	306.30	-64.55	-51.55	-13.00	-58.24	-6.32	Peak
5	325.90	-65.15	-52.15	-13.00	-59.25	-5.90	Peak
6	995.80	-61.42	-48.42	-13.00	-64.05	2.63	Peak
7	1888.00	-50.42			-49.92	-0.50	Peak
8	1958.00	-52.90			-52.30	-0.60	Peak
9	3758.00	-48.54	-35.54	-13.00	-55.17	6.64	Peak
10	5638.00	-53.17	-40.17	-13.00	-61.83	8.65	Peak
11	7518.00	-42.65	-29.65	-13.00	-56.01	13.37	Peak
12	9398.00	-38.21	-25.21	-13.00	-55.41	17.20	Peak
13 @	11278.00	-31.86	-18.86	-13.00	-50.73	18.87	Peak
14	13158.00	-45.03	-32.03	-13.00	-60.82	15.79	Peak

Remark:

1. #7: MS TCH Signal
2. #8: BS TCH Signal

Remark : There is no more obvious emission except the listings above.



4.6.5.3 Mode 3  
Horizontal Polarization

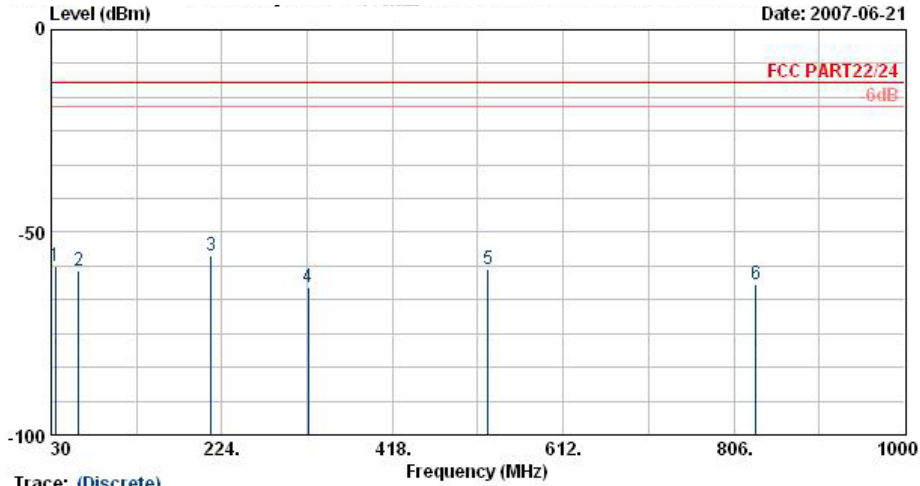

Trace: (Discrete)  
 Site : 03CH06-HY  
 Condition : LR-SPORTOUS HORIZONTAL  
 EUT : PDA Phone  
 Power : 120Vac 60Hz  
 Model : FG 760116-01  
 Memo : PCS 1900 Link; CH661+Adaptor+Earphone  
 Memo : + WLAN Tx\_Ch01;2412MHz  
 Plane : E2

	Freq	Level	Over	Limit	Read	Factor	Remark
	MHz	dBm	Limit	Line	Level	dB	
			dB	dBm	dBm		
1	35.13	-58.42	-45.42	-13.00	-55.74	-2.69	Peak
2	61.59	-59.60	-46.60	-13.00	-47.21	-12.39	Peak
3	211.98	-55.64	-42.64	-13.00	-42.69	-12.96	Peak
4	322.40	-63.61	-50.61	-13.00	-54.43	-9.18	Peak
5	526.80	-58.95	-45.95	-13.00	-54.20	-4.75	Peak
6	831.30	-62.70	-49.70	-13.00	-61.31	-1.39	Peak



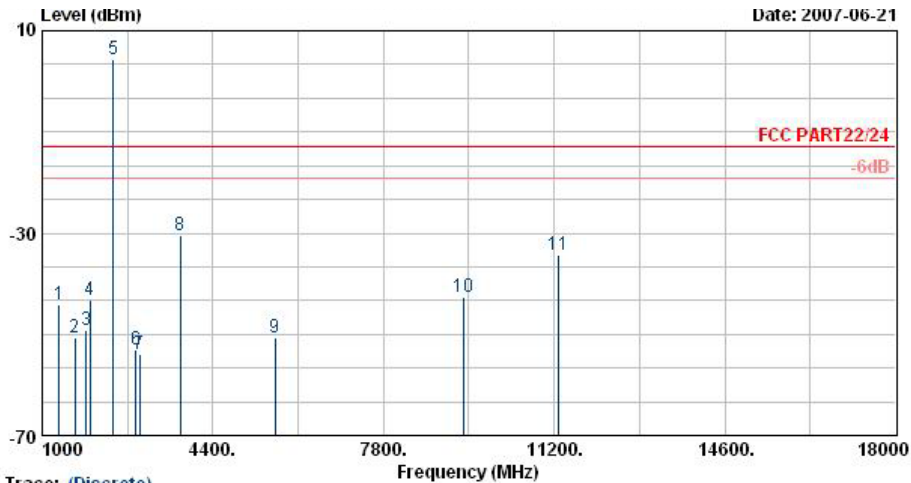

Trace: (Discrete)

Site : 03CH06-HY  
 Condition : HF-SPORTOUS HORIZONTAL  
 EUT : PDA Phone  
 Power : 120Vac 60Hz  
 Model : FG 760116-01  
 Memo : PCS 1900 Link; CH661+Adaptor+Earphone  
 Plane : +WLAN Tx\_Ch01; 2412MHz  
 E2

	Freq	Level	Over	Limit	Read		Remark
	MHz	dBm	Limit	Line	Level	Factor	
			dB	dBm	dBm	dB	
1	1344.00	-44.05	-31.05	-13.00	-45.00	0.96	Peak
2	1658.00	-50.62	-37.62	-13.00	-50.84	0.22	Peak
3	1884.00	-49.08			-48.40	-0.68	Peak
4	1958.00	-43.11			-42.00	-1.11	Peak
5 @	2414.00	4.42			3.53	0.89	Peak
6	2864.00	-53.08	-40.08	-13.00	-56.79	3.71	Peak
7	2944.00	-53.87	-40.87	-13.00	-57.88	4.02	Peak
8	3758.00	-30.34	-17.34	-13.00	-38.27	7.92	Peak
9	5638.00	-50.80	-37.80	-13.00	-60.77	9.97	Peak
10	9398.00	-42.60	-29.60	-13.00	-60.83	18.22	Peak
11	11278.00	-34.28	-21.28	-13.00	-54.58	20.30	Peak

Remark:

- #3: MS TCH Signal
- #4: BS TCH Signal
- #5: WLAN Signal



Vertical Polarization

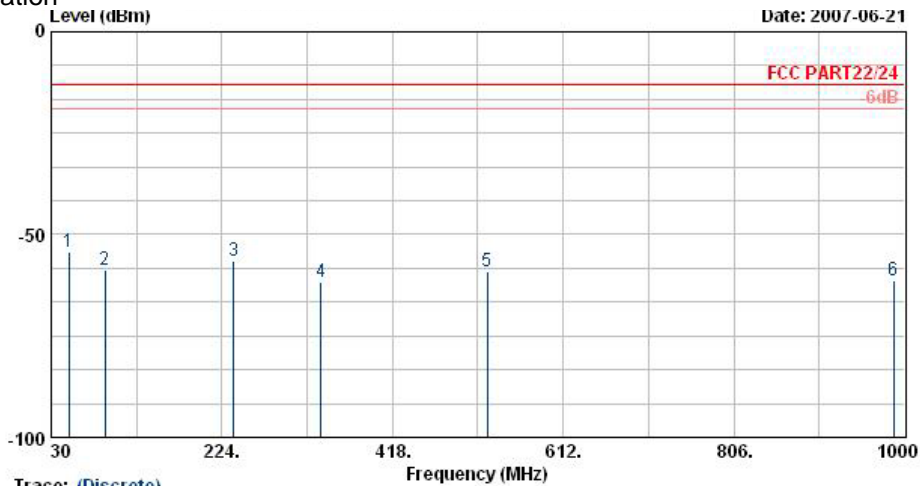

Trace: (Discrete)  
 Site : 03CH06-HY  
 Condition : LF-SPORTONS VERTICAL  
 EUT : PDA Phone  
 Power : 120Vac 60Hz  
 Model : FG 760116-01  
 Memo : PCS 1900 Link; CH661+Adaptor+Earphone  
 Memo : +WLAN Tx\_Ch01; 2412MHz  
 Plane : E2

	Freq	Level	Over	Limit	Read	Factor	Remark
	MHz	dBm	Limit	Line	Level	dB	
			dB	dBm	dBm		
1	49.98	-54.43	-41.43	-13.00	-39.61	-14.82	Peak
2	91.29	-58.68	-45.68	-13.00	-49.73	-8.95	Peak
3	237.63	-56.56	-43.56	-13.00	-48.78	-7.78	Peak
4	336.40	-61.71	-48.71	-13.00	-56.04	-5.67	Peak
5	525.40	-59.06	-46.06	-13.00	-56.23	-2.82	Peak
6	987.40	-61.30	-48.30	-13.00	-63.86	2.56	Peak

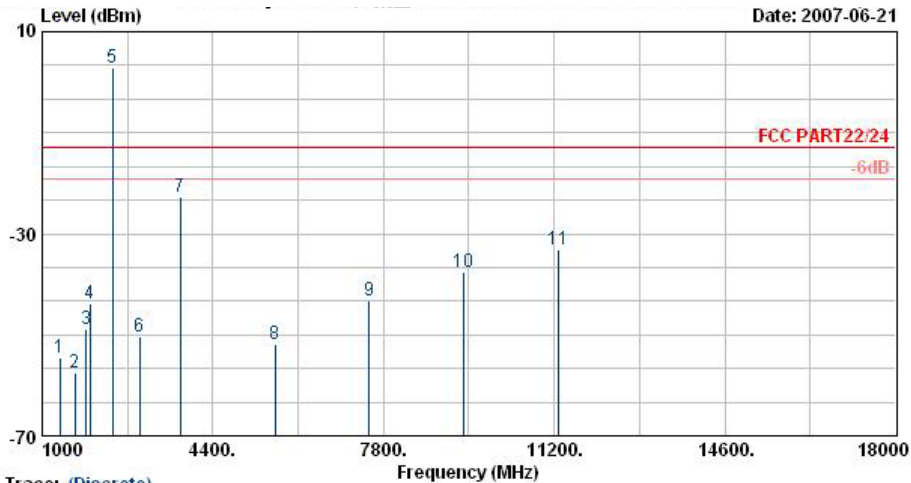

Trace: (Discrete)

Site : 03CH06-HY  
 Condition : HP-SPURIOUS VERTICAL  
 EUT : PDA Phone  
 Power : 120Vac 60Hz  
 Model : FG 760116-01  
 Memo : PCS 1800 Link; CH661+Adaptor+Earphone  
 Memo : +WLAN Tx\_Ch01; 2412MHz  
 Plane : E2

	Freq	Level	Over	Limit	Read	Factor	Remark
	MHz	dBm	Limit	Line	Level	dB	
1	1348.00	-54.55	-41.55	-13.00	-53.69	-0.86	Peak
2	1658.00	-57.50	-44.50	-13.00	-57.02	-0.48	Peak
3	1878.00	-48.79			-48.39	-0.40	Peak
4	1958.00	-43.93			-43.34	-0.60	Peak
5 @	2408.00	2.92			1.05	1.87	Peak
6	2944.00	-50.27	-37.27	-13.00	-53.61	3.35	Peak
7	3758.00	-22.82	-9.82	-13.00	-29.46	6.64	Peak
8	5638.00	-51.93	-38.93	-13.00	-60.59	8.65	Peak
9	7518.00	-43.33	-30.33	-13.00	-56.70	13.37	Peak
10	9398.00	-37.45	-24.45	-13.00	-54.65	17.20	Peak
11	11278.00	-33.15	-20.15	-13.00	-52.02	18.87	Peak

Remark:

1. #3: MS TCH Signal
2. #4: BS TCH Signal
3. #5: WLAN Signal

## 4.7 Frequency Stability (Temperature Variation)

### 4.7.1 Measurement Instrument

As described in chapter 5 of this test report.

### 4.7.2 Test Procedure

1. The EUT and test equipment were set up as shown on the following section.
2. With all power removed, the temperature was decreased to  $-30^{\circ}\text{C}$  and permitted to stabilize for three hours. Power was applied and the maximum change in frequency was noted within one minute.
3. With power OFF, the temperature was raised in  $10^{\circ}\text{C}$  steps. The sample was permitted to stabilize at each step for at least one-half hour. Power was applied and the maximum frequency change was noted within one minute.
4. The temperature tests were performed for the worst case.
5. Test data was recorded.

### 4.7.3 Test Setup Layout

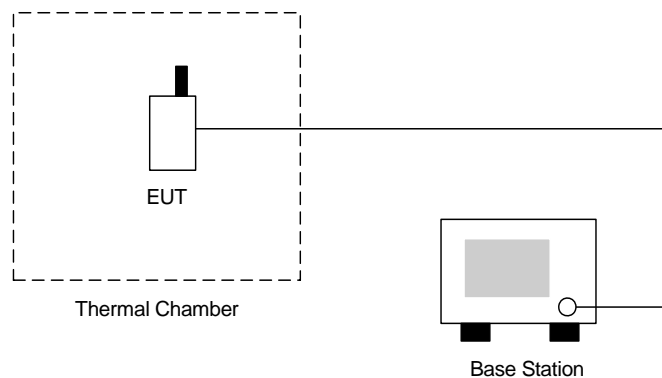



4.7.4 Test Result

- Test Mode : PCS1900 (GSM) CH661

Temperature(°C)	Change (Hz)	Change (ppm)	Limit (ppm)	Result
-30	n/a	n/a	2.5	Passed
-20	-134	-0.07		
-10	-129	-0.07		
0	-124	-0.07		
10	-91	-0.05		
20	-89	-0.05		
30	-75	-0.04		
40	-84	-0.04		
50	-86	-0.05		

Remark : The EUT can not be turn on at -30 .

- Test Mode : PCS1900 (EDGE) CH661

Temperature(°C)	Change (Hz)	Change (ppm)	Limit (ppm)	Result
-30	n/a	n/a	2.5	Passed
-20	-115	-0.06		
-10	-122	-0.06		
0	-107	-0.06		
10	-79	-0.04		
20	-94	-0.05		
30	-58	-0.03		
40	-66	-0.03		
50	-13	-0.01		

Remark : The EUT can not be turn on at -30 .

## 4.8 Frequency Stability (Voltage Variation)

### 4.8.1 Measurement Instrument

As described in chapter 5 of this test report.

### 4.8.2 Test Procedure

1. The EUT was placed in a temperature chamber at  $25\pm 5^{\circ}\text{C}$  and connected as the following section.
2. The power supply voltage to the EUT was varied from BEP to 115% of the nominal value measured at the input to the EUT.
3. The variation in frequency was measured for the worst case.

### 4.8.3 Test Setup Layout

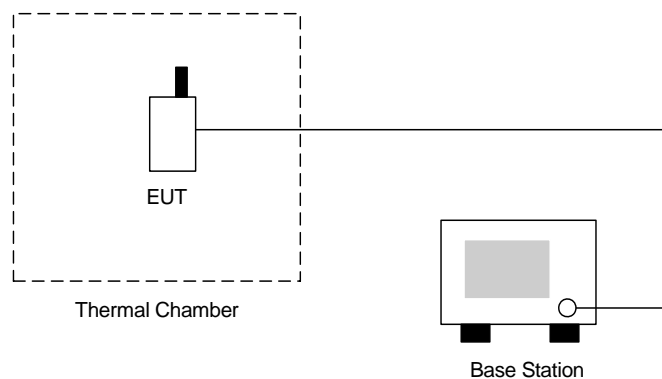



4.8.4 Test Result

- Test Mode : PCS1900 (GSM) CH661

Voltage(Volt)	Change (Hz)	Change (ppm)	Limit (ppm)	Result
3.7	-96.0	-0.05	2.5	Passed
BEP	-87.0	-0.05		
4.2	-81.0	-0.04		

- Test Mode : PCS1900 (EDGE) CH661

Voltage(Volt)	Change (Hz)	Change (ppm)	Limit (ppm)	Result
3.7	-75.0	-0.04	2.5	Passed
BEP	-79.0	-0.04		
4.2	-68.0	-0.04		

Remark:

- Normal Voltage=3.7V.
- Battery End Point (BEP)=3.4 V.



## 5 List of Measurement Equipments

Instrument	Manufacturer	Model No.	Serial No.	Characteristics	Calibration Date	Due Date	Remark
Spectrum analyzer	Agilent	E4408B	MY44211030	9KHz-26.5GHz	Oct. 05, 2006	Oct. 05, 2007	Radiation (03CH06-HY)
Receiver	R&S	ESCS30	100356	9KHz-2.75GHz	Jul. 13, 2006	Jul. 13, 2007	Radiation (03CH06-HY)
Controller	CT	SC100	N/A	N/A	N/A	N/A	Radiation (03CH06-HY)
Bilog Antenna	SCHAFFNER	CBL6112B	2885	30MHz - 2GHz	Nov. 20, 2006	Nov. 20, 2007	Radiation (03CH06-HY)
Horn Antenna	Com-Power	AH118	071025	1G - 18GHz	Jun. 04, 2007	Jun. 04, 2008	Radiation (03CH06-HY)
SHF-EHF Horn	SCHWARZBECK	BBHA 9170	9170-249	14G - 40GHz	Nov. 20, 2006	Nov. 20, 2007	Radiation (03CH06-HY)
PreAmplifier	Agilent	8449B	3008A01917	1G - 26.5GMHz	Nov. 15, 2006	Nov. 15, 2007	Radiation (03CH06-HY)
PreAmplifier	Mini Circuits	ZKL-2	D092004-1	10 - 2500MHz	Nov. 15, 2006	Nov. 15, 2007	Radiation (03CH06-HY)
Turn Table	HD	DS 420	420/650/00	0 - 360 degree	N/A	N/A	Radiation (03CH06-HY)
Antenna Mast	HD	MA 240	240/560/00	1 m - 4 m	N/A	N/A	Radiation (03CH06-HY)
Thermal Chamber	Ten Billion	TTH-D35P	TBN-930701	N/A	Jul. 24, 2006	Jul. 24, 2007	Conducted (TH02-HY)
Spectrum	R&S	FSP40	100055	9KHz - 40GHz	Jun. 25, 2007	Jun. 25, 2008	Conducted (TH02-HY)
Power Divider	ARRA	5200-1	3871	N/A	Oct. 07, 2006	Oct. 07, 2007	Conducted (TH02-HY)
DC Power Supply	TOPWARD	3303D	740889	N/A	May 25, 2007	May 25, 2008	Conducted (TH02-HY)
Power Meter	Agilent	E4416A	GB41292344	N/A	Feb. 08, 2007	Feb. 08, 2008	Conducted (TH02-HY)
Power Sensor	Agilent	E9327A	US40441548	N/A	Feb. 08, 2007	Feb. 08, 2008	Conducted (TH02-HY)





## 6 Uncertainty Evaluation

### Uncertainty of Radiated Emission Measurement (30MHz ~ 1000MHz)

Contribution	Uncertainty of $x_i$		$u(x_i)$
	dB	Probability Distribution	
Receiver reading	0.41	Normal(k=2)	0.21
Antenna factor calibration	0.83	Normal(k=2)	0.42
Cable loss calibration	0.25	Normal(k=2)	0.13
Pre Amplifier Gain calibration	0.27	Normal(k=2)	0.14
RCV/SPA specification	2.50	Rectangular	0.72
Antenna Factor Interpolation for Frequency	1.00	Rectangular	0.29
Site imperfection	1.43	Rectangular	0.83
Mismatch	+0.39/-0.41	U-shaped	0.28
<b>combined standard uncertainty Uc(y)</b>	<b>1.27</b>		
<b>Measuring uncertainty for a level of confidence of 95% U=2Uc(y)</b>	<b>2.54</b>		

### Uncertainty of Radiated Emission Measurement (1GHz ~ 40GHz)

Contribution	Uncertainty of $x_i$		$u(x_i)$	$C_i$	$C_i * u(x_i)$
	dB	Probability Distribution			
Receiver reading	±0.10	Normal(k=1)	0.10	1	0.10
Antenna factor calibration	±1.70	Normal(k=2)	0.85	1	0.85
Cable loss calibration	±0.50	Normal(k=2)	0.25	1	0.25
Receiver Correction	±2.00	Rectangular	1.15	1	1.15
Antenna Factor Directional	±1.50	Rectangular	0.87	1	0.87
Site imperfection	±2.80	Triangular	1.14	1	1.14
Mismatch Receiver VSWR $\Gamma_1 = 0.197$ Antenna VSWR $\Gamma_2 = 0.194$ Uncertainty = $20 \log(1 - \Gamma_1 * \Gamma_2 * \Gamma_3)$	+0.34/-0.35	U-shaped	0.244	1	0.244
<b>Combined standard uncertainty Uc(y)</b>	<b>2.36</b>				
<b>Measuring uncertainty for a level of confidence of 95% U=2Ue(y)</b>	<b>4.72</b>				

END OF TEST REPORT