

FCC Test Report

Report No.: RF200106C21-1 R2

FCC ID: UJH-R1LOW-SB

Test Model: R1LOW (refer to item 3.1 for more details)

Received Date: Jan. 06, 2020

Test Date: Jan. 08 ~ Mar. 17, 2020

Issued Date: Apr. 09, 2020

Applicant: Mitsubishi Electric Corporation Sanda Works

Address: 2-3-33 Miwa, Sanda-City, Hyogo 669-1513, Japan

Issued By: Bureau Veritas Consumer Products Services (H.K.) Ltd., Taoyuan Branch
Lin Kou Laboratories

Lab Address: No. 47-2, 14th Ling, Chia Pau Vil., Lin Kou Dist., New Taipei City, Taiwan

Test Location: No. 19, Hwa Ya 2nd Rd., Wen Hwa Vil., Kwei Shan Dist., Taoyuan City
33383, Taiwan

**FCC Registration /
Designation Number:** 788550 / TW0003



This report is for your exclusive use. Any copying or replication of this report to or for any other person or entity, or use of our name or trademark, is permitted only with our prior written permission. This report sets forth our findings solely with respect to the test samples identified herein. The results set forth in this report are not indicative or representative of the quality or characteristics of the lot from which a test sample was taken or any similar or identical product specifically and expressly noted. Our report includes all of the tests requested by you and the results thereof based upon the information that you provided to us. You have 60 days from date of issuance of this report to notify us of any material error or omission caused by our negligence, provided, however, that such notice shall be in writing and shall specifically address the issue you wish to raise. A failure to raise such issue within the prescribed time shall constitute your unqualified acceptance of the completeness of this report, the tests conducted and the correctness of the report contents. Unless specific mention, the uncertainty of measurement has been explicitly taken into account to declare the compliance or non-compliance to the specification. This report should not be used by the client to claim product certification, approval, or endorsement by TAF or any government agencies.

Table of Contents

Release Control Record	4
1 Certificate of Conformity	5
2 Summary of Test Results	6
2.1 Measurement Uncertainty.....	6
2.2 Modification Record.....	6
3 General Information	7
3.1 General Description of EUT.....	7
3.2 Description of Test Modes.....	9
3.2.1 Test Mode Applicability and Tested Channel Detail.....	11
3.3 Duty Cycle of Test Signal.....	13
3.4 Description of Support Units.....	14
3.4.1 Configuration of System under Test.....	14
3.5 General Description of Applied Standards and References.....	14
4 Test Types and Results	15
4.1 Radiated Emission and Bandedge Measurement.....	15
4.1.1 Limits of Radiated Emission and Bandedge Measurement.....	15
4.1.2 Test Instruments.....	16
4.1.3 Test Procedures.....	17
4.1.4 Deviation from Test Standard.....	17
4.1.5 Test Setup.....	18
4.1.6 EUT Operating Conditions.....	19
4.1.7 Test Results.....	20
4.2 Transmit Power Measurement.....	62
4.2.1 Limits of Transmit Power Measurement.....	62
4.2.2 Test Setup.....	62
4.2.3 Test Instruments.....	62
4.2.4 Test Procedure.....	63
4.2.5 Deviation from Test Standard.....	63
4.2.6 EUT Operating Conditions.....	63
4.2.7 Test Result.....	64
4.3 Occupied Bandwidth Measurement.....	73
4.3.1 Test Setup.....	73
4.3.2 Test Instruments.....	73
4.3.3 Test Procedure.....	73
4.3.4 Test Result.....	74
4.4 Peak Power Spectral Density Measurement.....	77
4.4.1 Limits of Peak Power Spectral Density Measurement.....	77
4.4.2 Test Setup.....	77
4.4.3 Test Instruments.....	77
4.4.4 Test Procedures.....	78
4.4.5 Deviation from Test Standard.....	78
4.4.6 EUT Operating Conditions.....	78
4.4.7 Test Results.....	79
4.5 Frequency Stability.....	90
4.5.1 Limits of Frequency Stability Measurement.....	90
4.5.2 Test Setup.....	90
4.5.3 Test Instruments.....	90
4.5.4 Test Procedure.....	90
4.5.5 Deviation from Test Standard.....	91
4.5.6 EUT Operating Condition.....	91
4.5.7 Test Results.....	91
4.6 6dB Bandwidth Measurement.....	92
4.6.1 Limits of 6dB Bandwidth Measurement.....	92

4.6.2 Test Setup.....	92
4.6.3 Test Instruments	92
4.6.4 Test Procedure	92
4.6.5 Deviation from Test Standard	92
4.6.6 EUT Operating Condition	92
4.6.7 Test Results	93
5 Pictures of Test Arrangements.....	95
Annex A- Radiated Out of Band Emission (OOBE) Measurement (For U-NII-3 band).....	96
Appendix – Information of the Testing Laboratories	99

Release Control Record

Issue No.	Description	Date Issued
RF200106C21-1	Original release	Mar. 18, 2020
RF200106C21-1 R1	Revised brand	Mar. 31, 2020
RF200106C21-1 R2	Revised Power Supply Rating	Apr. 09, 2020

1 Certificate of Conformity

Product: Display Audio

Brand: Mitsubishi Electric

Test Model: R1LOW (refer to item 3.1 for more details)

Sample Status: DV

Applicant: Mitsubishi Electric Corporation Sanda Works

Test Date: Jan. 08 ~ Mar. 17, 2020

Standards: 47 CFR FCC Part 15, Subpart E (Section 15.407)
ANSI C63.10:2013

The above equipment has been tested by **Bureau Veritas Consumer Products Services (H.K.) Ltd., Taoyuan Branch**, and found compliance with the requirement of the above standards. The test record, data evaluation & Equipment Under Test (EUT) configurations represented herein are true and accurate accounts of the measurements of the sample's RF characteristics under the conditions specified in this report.

Prepared by : Pettie Chen , **Date:** Apr. 09, 2020
Pettie Chen / Senior Specialist

Approved by : Bruce Chen , **Date:** Apr. 09, 2020
Bruce Chen / Senior Project Engineer

2 Summary of Test Results

47 CFR FCC Part 15, Subpart E (Section 15.407)			
FCC Clause	Test Item	Result	Remarks
15.407(b)(6)	AC Power Conducted Emissions	NA	EUT is powered from DC
15.407(b) (1/2/3/4(i/ii)/6)	Radiated Emissions & Band Edge Measurement	Pass	Meet the requirement of limit. Minimum passing margin is -3.9dB at 45.52MHz.
15.407(a)(1/2/3)	Max Average Transmit Power	Pass	Meet the requirement of limit.
---	Occupied Bandwidth Measurement	Pass	Meet the requirement of limit.
15.407(a)(1/2/3)	Peak Power Spectral Density	Pass	Meet the requirement of limit. (U-NII-3 Band only)
15.407(e)	6dB bandwidth	Pass	Meet the requirement of limit.
15.407(g)	Frequency Stability	Pass	Meet the requirement of limit.
15.203	Antenna Requirement	Pass	Antenna connector is FAKRA not a standard connector.

Note:

- Determining compliance based on the results of the compliance measurement, not taking into account measurement instrumentation uncertainty.
- For U-NII-3 band compliance with rule part 15.407(b)(4)(i), the OBE test plots were recorded in Annex A.

2.1 Measurement Uncertainty

Where relevant, the following measurement uncertainty levels have been estimated for tests performed on the EUT as specified in CISPR 16-4-2:

Measurement	Frequency	Expanded Uncertainty (k=2) (\pm)
Radiated Emissions up to 1 GHz	9kHz ~ 30MHz	3.04 dB
	30MHz ~ 200MHz	3.59 dB
	200MHz ~ 1000MHz	3.60 dB
Radiated Emissions above 1 GHz	1GHz ~ 18GHz	2.29 dB
	18GHz ~ 40GHz	2.29 dB

2.2 Modification Record

There were no modifications required for compliance.

3 General Information

3.1 General Description of EUT

Product	Display Audio
Brand	Mitsubishi Electric
Model	R1LOW (refer to note for more details)
Sample Status	DV
Power Supply Rating	12Vdc
Modulation Type	256QAM, 64QAM, 16QAM, QPSK, BPSK
Modulation Technology	OFDM
Transfer Rate	802.11a: 54/48/36/24/18/12/9/6Mbps 802.11n: up to 300Mbps 802.11ac: up to 867Mbps
Operating Frequency	5180~5240MHz, 5260~5320MHz, 5500~5700MHz, 5745~5825MHz
Number of Channel	5180~5240MHz: 802.11a, 802.11n (HT20), 802.11ac (VHT20): 4 802.11n (HT40), 802.11ac (VHT40): 2 802.11ac (VHT80): 1 5260~5320MHz: 802.11a, 802.11n (HT20), 802.11ac (VHT20): 4 802.11n (HT40), 802.11ac (VHT40): 2 802.11ac (VHT80): 1 5500~5700MHz: 802.11a, 802.11n (HT20), 802.11ac (VHT20): 11 802.11n (HT40), 802.11ac (VHT40): 5 802.11ac (VHT80): 2 5745~5825MHz: 802.11a, 802.11n (HT20), 802.11ac (VHT20): 5 802.11n (HT40), 802.11ac (VHT40): 2 802.11ac (VHT80): 1
Output Power	5180~5240MHz: For Outdoor Access Point Mode: 3.635mW For Mobile and Portable client device Mode: 3.635mW 5260~5320MHz: 3.557mW 5500~5700MHz: 3.055mW 5745~5825MHz: 1.976mW
Antenna Type	Refer to Note
Antenna Connector	Refer to Note
Accessory Device	Antenna, 2.0m non-shielded DC power cable without core
Cable Supplied	NA

Note:

1. The following models are provided to this EUT.

Brand	Model	Description
Mitsubishi Electric	R1LOW	No. 28: SB, SXM
		No. 29: SB, DAB, FM2
		No. 39: SB, DAB, FM2, CAN-termination

2. The EUT incorporates a MIMO function. Physically, the EUT provides 2 completed transmitters and 2 receivers.

Modulation Mode	TX Function
802.11a	2TX
802.11n (HT20)	2TX
802.11n (HT40)	2TX
802.11ac (VHT20)	2TX
802.11ac (VHT40)	2TX
802.11ac (VHT80)	2TX

* The modulation and bandwidth are similar for HT20/HT40 on 802.11n mode and VHT20/VHT40 on 802.11ac mode, therefore investigated worst case to representative mode in test report. (Final test mode refer section 3.2.1)

3. There two modules are collocated in the EUT.

Module No.	Function
1	WLAN 2.4GHz, 5GHz, BT EDR, BT LE (1M)
2	BT LE (1M, 2M)

4. The EUT uses following antennas.

Type	PCB									
Connector	FAKRA									
Frequency (MHz)	2400	2450	2500	5150	5250	5350	5470	5725	5850	
Ant. No.	0									
Gain (dBi)	Horizontal	1.19	1.85	0.49	-0.36	-0.51	0.02	-0.26	-1.40	-2.90
	Vertical	-8.98	-10.93	-13.69	-3.86	-3.10	-2.09	-2.07	0.15	-2.23
Max Gain (dBi)	1.85			0.15						
Ant. No.	1									
Gain (dBi)	Horizontal	1.50	1.64	0.12	0.87	1.61	0.51	0.89	0.84	0.14
	Vertical	-8.68	-13.32	-12.30	-0.86	-0.47	-0.70	-0.78	1.31	0.58
Max Gain (dBi)	1.64			1.61						

3.2 Description of Test Modes

5180~5240MHz:

4 channels are provided for 802.11a, 802.11n (HT20), 802.11ac (VHT20):

Channel	Frequency	Channel	Frequency
36	5180 MHz	44	5220 MHz
40	5200 MHz	48	5240 MHz

2 channels are provided for 802.11n (HT40), 802.11ac (VHT40):

Channel	Frequency	Channel	Frequency
38	5190 MHz	46	5230 MHz

1 channel is provided for 802.11ac (VHT80):

Channel	Frequency
42	5210 MHz

5260~5320MHz:

4 channels are provided for 802.11a, 802.11n (HT20), 802.11ac (VHT20):

Channel	Frequency	Channel	Frequency
52	5260 MHz	60	5300 MHz
56	5280 MHz	64	5320 MHz

2 channels are provided for 802.11n (HT40), 802.11ac (VHT40):

Channel	Frequency	Channel	Frequency
54	5270 MHz	62	5310 MHz

1 channel is provided for 802.11ac (VHT80):

Channel	Frequency
58	5290 MHz

5500~5700MHz:

11 channels are provided for 802.11a, 802.11n (HT20), 802.11ac (VHT20):

Channel	Frequency	Channel	Frequency
100	5500 MHz	124	5620 MHz
104	5520 MHz	128	5640 MHz
108	5540 MHz	132	5660 MHz
112	5560 MHz	136	5680 MHz
116	5580 MHz	140	5700 MHz
120	5600 MHz		

5 channels are provided for 802.11n (HT40), 802.11ac (VHT40):

Channel	Frequency	Channel	Frequency
102	5510 MHz	126	5630 MHz
110	5550 MHz	134	5670 MHz
118	5590 MHz		

2 channels are provided for 802.11ac (VHT80):

Channel	Frequency	Channel	Frequency
106	5530 MHz	122	5610 MHz

5745~5825MHz:

5 channels are provided for 802.11a, 802.11n (HT20), 802.11ac (VHT20):

Channel	Frequency	Channel	Frequency
149	5745 MHz	161	5805 MHz
153	5765 MHz	165	5825 MHz
157	5785 MHz		

2 channels are provided for 802.11n (HT40), 802.11ac (VHT40):

Channel	Frequency	Channel	Frequency
151	5755 MHz	159	5795 MHz

1 channel is provided for 802.11ac (VHT80):

Channel	Frequency
155	5775 MHz

3.2.1 Test Mode Applicability and Tested Channel Detail

EUT Configure Mode	Applicable to				Description
	RE \geq 1G	RE<1G	PLC	APCM	
A	√	√	Note 2	√	EUT: No. 28
B	-	√	Note 2	-	EUT: No. 39

Where RE \geq 1G: Radiated Emission above 1GHz & Bandedge Measurement
 RE<1G: Radiated Emission below 1GHz
 PLC: Power Line Conducted Emission
 APCM: Antenna Port Conducted Measurement

Note:

1. The EUT had been pre-tested on the positioned of each 3 axis. The worst case was found when positioned on X-plane.
2. No need to concern of PLC due to the EUT is powered from DC.
3. For radiated emission (below 1GHz) test item, the worst maximum power was selected.
4. "-": Means no effect.

Radiated Emission Test (Above 1GHz):

- Pre-Scan has been conducted to determine the worst-case mode from all possible combinations between available modulations, data rates and antenna ports (if EUT with antenna diversity architecture).
- Following channel(s) was (were) selected for the final test as listed below.

EUT Configure Mode	Mode	Frequency Band (MHz)	Available Channel	Tested Channel	Modulation Technology	Data Rate (Mbps)
A	802.11a	5180-5240	36 to 48	36, 40, 48	OFDM	6.0
	802.11n (HT20)		36 to 48	36, 40, 48	OFDM	6.5
	802.11n (HT40)		38 to 46	38, 46	OFDM	13.5
	802.11ac (VHT80)		42	42	OFDM	29.3
	802.11a	5260-5320	52 to 64	52, 60, 64	OFDM	6.0
	802.11n (HT20)		52 to 64	52, 60, 64	OFDM	6.5
	802.11n (HT40)		54 to 62	54, 62	OFDM	13.5
	802.11ac (VHT80)		58	58	OFDM	29.3
	802.11a	5500-5700	100 to 140	100, 116, 140	OFDM	6.0
	802.11n (HT20)		100 to 140	100, 116, 140	OFDM	6.5
	802.11n (HT40)		102 to 134	102, 110, 134	OFDM	13.5
	802.11ac (VHT80)		106 to 122	106, 122	OFDM	29.3
	802.11a	5745-5825	149 to 165	149, 157, 165	OFDM	6.0
	802.11n (HT20)		149 to 165	149, 157, 165	OFDM	6.5
	802.11n (HT40)		151 to 159	151, 159	OFDM	13.5
	802.11ac (VHT80)		155	155	OFDM	29.3

Radiated Emission Test (Below 1GHz):

- Pre-Scan has been conducted to determine the worst-case mode from all possible combinations between available modulations, data rates and antenna ports (if EUT with antenna diversity architecture).
- Following channel(s) was (were) selected for the final test as listed below.

EUT Configure Mode	Mode	Frequency Band (MHz)	Available Channel	Tested Channel	Modulation Technology	Data Rate (Mbps)
A, B	802.11a	5180-5240	36 to 48	36	OFDM	6.0
		5260-5320	52 to 64		OFDM	6.0
		5500-5700	100 to 140		OFDM	6.0
		5745-5825	149 to 165		OFDM	6.0

Antenna Port Conducted Measurement:

- This item includes all test value of each mode, but only includes spectrum plot of worst value of each mode.
- Pre-Scan has been conducted to determine the worst-case mode from all possible combinations between available modulations, data rates and antenna ports (if EUT with antenna diversity architecture).
- Following channel(s) was (were) selected for the final test as listed below.

EUT Configure Mode	Mode	Frequency Band (MHz)	Available Channel	Tested Channel	Modulation Technology	Data Rate (Mbps)
A	802.11a	5180-5240	36 to 48	36, 40, 48	OFDM	6.0
	802.11n (HT20)		36 to 48	36, 40, 48	OFDM	6.5
	802.11n (HT40)		38 to 46	38, 46	OFDM	13.5
	802.11ac (VHT80)		42	42	OFDM	29.3
	802.11a	5260-5320	52 to 64	52, 60, 64	OFDM	6.0
	802.11n (HT20)		52 to 64	52, 60, 64	OFDM	6.5
	802.11n (HT40)		54 to 62	54, 62	OFDM	13.5
	802.11ac (VHT80)		58	58	OFDM	29.3
	802.11a	5500-5700	100 to 140	100, 116, 140	OFDM	6.0
	802.11n (HT20)		100 to 140	100, 116, 140	OFDM	6.5
	802.11n (HT40)		102 to 134	102, 110, 134	OFDM	13.5
	802.11ac (VHT80)		106 to 122	106, 122	OFDM	29.3
	802.11a	5745-5825	149 to 165	149, 157, 165	OFDM	6.0
	802.11n (HT20)		149 to 165	149, 157, 165	OFDM	6.5
	802.11n (HT40)		151 to 159	151, 159	OFDM	13.5
	802.11ac (VHT80)		155	155	OFDM	29.3

Test Condition:

Applicable to	Environmental Conditions	Input Power (system)	Tested by
RE \geq 1G	22 deg. C, 66% RH	12Vdc	Han Wu
RE<1G	22 deg. C, 66% RH	12Vdc	Han Wu
APCM	25 deg. C, 60% RH	12Vdc	Jisyong Wang

3.3 Duty Cycle of Test Signal

Duty cycle of test signal is $\geq 98\%$, duty factor is not required.
 Duty cycle of test signal is $< 98\%$, duty factor shall be considered.

- 802.11a: Duty cycle = $2.042/2.227 = 0.917$, Duty factor = $10 * \log(1/0.917) = 0.38$
- 802.11n (HT20): Duty cycle = $0.98/1.162 = 0.843$, Duty factor = $10 * \log(1/0.843) = 0.74$
- 802.11n (HT40): Duty cycle = $0.492/0.657 = 0.749$, Duty factor = $10 * \log(1/0.749) = 1.26$
- 802.11ac (VHT80): Duty cycle = $0.254/0.378 = 0.672$, Duty factor = $10 * \log(1/0.672) = 1.73$



3.4 Description of Support Units

The EUT has been tested as an independent unit together with other necessary accessories or support units. The following support units or accessories were used to form a representative test configuration during the tests.

ID	Product	Brand	Model No.	Serial No.	FCC ID	Remarks
A.	Battery	YUASA	75D23R-CMF II	NA	NA	-
B.	Fixture Board	NA	NA	NA	NA	Provided by client
C.	Display	NA	NA	NA	NA	Provided by client
D.	Antenna	Molex	68306857AA	60021	NA	Accessory
E.	Adapter	NA	FJ-SW1203000D	NA	NA	Provided by client

Note:

1. All power cords of the above support units are non-shielded (1.8m).

ID	Descriptions	Qty.	Length (m)	Shielding (Yes/No)	Cores (Qty.)	Remarks
1.	DC power cable	1	2	N	0	Accessory
2.	USB cable	1	0.5	Y	2	Provided by client
3.	Harness cable	1	2	N	0	Provided by client

3.4.1 Configuration of System under Test

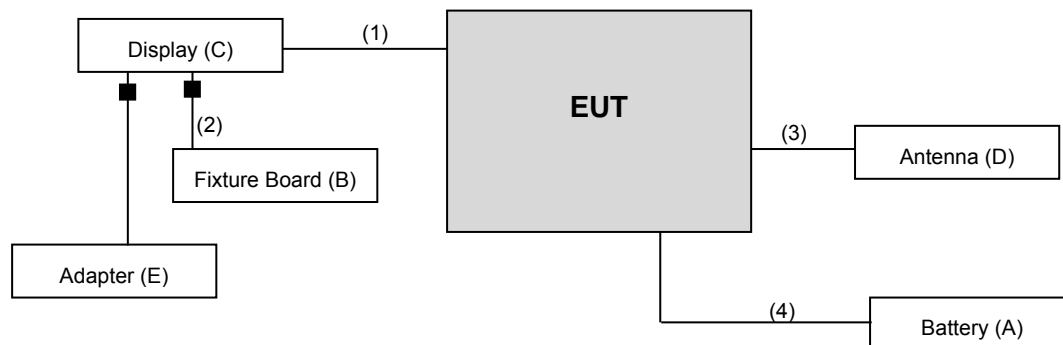

3.5 General Description of Applied Standards and References

The EUT is a RF Product. According to the specifications of the manufacturer, it must comply with the requirements of the following standards and References:

Test Standard:

FCC Part 15, Subpart E (15.407)

ANSI C63.10:2013

All test items have been performed and recorded as per the above standards.

References Test Guidance:

KDB 789033 D02 General UNII Test Procedure New Rules v02r01

KDB 662911 D01 Multiple Transmitter Output v02r01

All test items have been performed as a reference to the above KDB test guidance.

4 Test Types and Results

4.1 Radiated Emission and Bandedge Measurement

4.1.1 Limits of Radiated Emission and Bandedge Measurement

Radiated emissions which fall in the restricted bands must comply with the radiated emission limits specified as below table.

Frequencies (MHz)	Field Strength (microvolts/meter)	Measurement Distance (meters)
0.009 ~ 0.490	2400/F(kHz)	300
0.490 ~ 1.705	24000/F(kHz)	30
1.705 ~ 30.0	30	30
30 ~ 88	100	3
88 ~ 216	150	3
216 ~ 960	200	3
Above 960	500	3

Note:

1. The lower limit shall apply at the transition frequencies.
2. Emission level (dBuV/m) = 20 log Emission level (uV/m).
3. For frequencies above 1000MHz, the field strength limits are based on average detector, however, the peak field strength of any emission shall not exceed the maximum permitted average limits, specified above by more than 20dB under any condition of modulation.

Limits of unwanted emission out of the restricted bands

Applicable To		Limit	
789033 D02 General UNII Test Procedure New Rules v02r01		Field Strength at 3m	
		PK: 74 (dBµV/m)	AV: 54 (dBµV/m)
Frequency Band	Applicable To	EIRP Limit	Equivalent Field Strength at 3m
5150~5250 MHz	15.407(b)(1)	PK: -27 (dBm/MHz)	PK: 68.2(dBµV/m)
5250~5350 MHz	15.407(b)(2)		
5470~5725 MHz	15.407(b)(3)		
5725~5850 MHz	<input checked="" type="checkbox"/> 15.407(b)(4)(i)	PK: -27 (dBm/MHz) ^{*1} PK: 10 (dBm/MHz) ^{*2} PK: 15.6 (dBm/MHz) ^{*3} PK: 27 (dBm/MHz) ^{*4}	PK: 68.2(dBµV/m) ^{*1} PK: 105.2 (dBµV/m) ^{*2} PK: 110.8(dBµV/m) ^{*3} PK: 122.2 (dBµV/m) ^{*4}
	<input type="checkbox"/> 15.407(b)(4)(ii)	Emission limits in section 15.247(d)	
^{*1} beyond 75 MHz or more above of the band edge. ^{*3} below the band edge increasing linearly to a level of 15.6 dBm/MHz at 5 MHz above.		^{*2} below the band edge increasing linearly to 10 dBm/MHz at 25 MHz above. ^{*4} from 5 MHz above or below the band edge increasing linearly to a level of 27 dBm/MHz at the band edge.	

Note: The following formula is used to convert the equipment isotropic radiated power (eirp) to field strength:

$$E = \frac{1000000 \sqrt{30P}}{3} \mu\text{V/m, where P is the eirp (Watts).}$$

4.1.2 Test Instruments

Description & Manufacturer	Model No.	Serial No.	Date Of Calibration	Due Date Of Calibration
Test Receiver KEYSIGHT	N9038A	MY55420137	Apr. 15, 2019	Apr. 14, 2020
Spectrum Analyzer ROHDE & SCHWARZ	FSP40	100039	Jun. 12, 2019	Jun. 11, 2020
Spectrum Analyzer ROHDE & SCHWARZ	FSV40	100979	Apr. 18, 2019	Apr. 17, 2020
BILOG Antenna SCHWARZBECK	VULB9168	9168-160	Nov. 07, 2019	Nov. 06, 2020
HORN Antenna SCHWARZBECK	BBHA 9120 D	9120D-1169	Nov. 24, 2019	Nov. 23, 2020
HORN Antenna SCHWARZBECK	BBHA 9170	BBHA9170241	Nov. 24, 2019	Nov. 23, 2020
Preamplifier EMC	EMC184045B	980175	Sep. 05, 2019	Sep. 04, 2020
Preamplifier Agilent (Below 1GHz)	8447D	2944A10638	Jul. 11, 2019	Jul. 10, 2020
Preamplifier Agilent (Above 1GHz)	8449B	3008A02367	Feb. 19, 2019	Feb. 18, 2020
			Feb. 18, 2020	Feb. 17, 2021
RF signal cable HUBER+SUHNER&EMCI	SUCOFLEX 104 & EMC104-SM-SM80 00	CABLE-CH9-02 (248780+171006)	Jan. 19, 2019	Jan. 18, 2020
			Jan. 18, 2020	Jan. 17, 2021
RF signal cable HUBER+SUHNER	SUCOFLEX 104	CABLE-CH9-(25079 5/4)	Jul. 11, 2019	Jul. 10, 2020
RF signal cable Woken	8D-FB	Cable-CH9-01	Jul. 30, 2019	Jul. 29, 2020
Software BV ADT	ADT_Radiated_ V7.6.15.9.5	NA	NA	NA
Antenna Tower EMCO	2070/2080	512.835.4684	NA	NA
Turn Table EMCO	2087-2.03	NA	NA	NA
Antenna Tower & Turn BV ADT	AT100	AT93021705	NA	NA
Turn Table BV ADT	TT100	TT93021705	NA	NA
Turn Table Controller BV ADT	SC100	SC93021705	NA	NA
Boresight Antenna Fixture	FBA-01	FBA-SIP01	NA	NA
Peak Power Analyzer KEYSIGHT (Support 8TX and 160MHz Bandwidth)	8990B	MY51000485	Jan. 14, 2019	Jan. 13, 2020
			Jan. 14, 2020	Jan. 13, 2021
USB Wideband Power Sensor KEYSIGHT	U2021XA	MY55050005/MY55 190004/MY5519000 7/MY55210005	Jul. 15, 2019	Jul. 14, 2020

Note: 1. The calibration interval of the above test instruments is 12 months and the calibrations are traceable to NML/ROC and NIST/USA.

2. The test was performed in HwaYa Chamber 9.

4.1.3 Test Procedures

For Radiated emission below 30MHz

- a. The EUT was placed on the top of a rotating table 0.8 meters above the ground at a 3 meter chamber room. The table was rotated 360 degrees to determine the position of the highest radiation.
- b. The EUT was set 3 meters away from the interference-receiving antenna, which was mounted on the top of a variable-height antenna tower.
- c. Parallel, perpendicular, and ground-parallel orientations of the antenna are set to make the measurement.
- d. For each suspected emission, the EUT was arranged to its worst case and the rotatable table was turned from 0 degrees to 360 degrees to find the maximum reading.
- e. The test-receiver system was set to Quasi-Peak Detect Function and Specified Bandwidth with Maximum Hold Mode.

Note:

1. The resolution bandwidth and video bandwidth of test receiver/spectrum analyzer is 9kHz at frequency below 30MHz.

For Radiated emission above 30MHz

- a. The EUT was placed on the top of a rotating table 0.8 meters (for 30MHz ~ 1GHz) / 1.5 meters (for above 1GHz) above the ground at 3 meter chamber room for test. The table was rotated 360 degrees to determine the position of the highest radiation.
- b. The EUT was set 3 meters away from the interference-receiving antenna, which was mounted on the top of a variable-height antenna tower.
- c. The height of antenna is varied from one meter to four meters above the ground to determine the maximum value of the field strength. Both horizontal and vertical polarizations of the antenna are set to make the measurement.
- d. For each suspected emission, the EUT was arranged to its worst case and then the antenna was tuned to heights from 1 meter to 4 meters and the rotatable table was turned from 0 degrees to 360 degrees to find the maximum reading.
- e. The test-receiver system was set to quasi-peak detect function and specified bandwidth with maximum hold mode when the test frequency is below 1 GHz.
- f. The test-receiver system was set to peak and average detect function and specified bandwidth with maximum hold mode when the test frequency is above 1 GHz. If the peak reading value also meets average limit, measurement with the average detector is unnecessary.

Note:

1. The resolution bandwidth and video bandwidth of test receiver/spectrum analyzer is 120kHz for Quasi-peak detection (QP) at frequency below 1GHz.
2. The resolution bandwidth of test receiver/spectrum analyzer is 1 MHz and the video bandwidth is 3 MHz for Peak detection (PK) at frequency above 1GHz.
3. The resolution bandwidth of test receiver/spectrum analyzer is 1MHz and the video bandwidth is $\geq 1/T$ (Duty cycle < 98%) or 10Hz (Duty cycle $\geq 98\%$) for Average detection (AV) at frequency above 1GHz. (802.11a: RBW = 1 MHz, VBW = 1 kHz; 802.11n (HT20): RBW = 1 MHz, VBW = 3 kHz; 802.11n (HT40): RBW = 1 MHz, VBW = 3 kHz; 802.11ac (VHT80): RBW = 1 MHz, VBW = 10 kHz)
4. All modes of operation were investigated and the worst-case emissions are reported.

4.1.4 Deviation from Test Standard

No deviation.

4.1.5 Test Setup

For Radiated emission below 30MHz

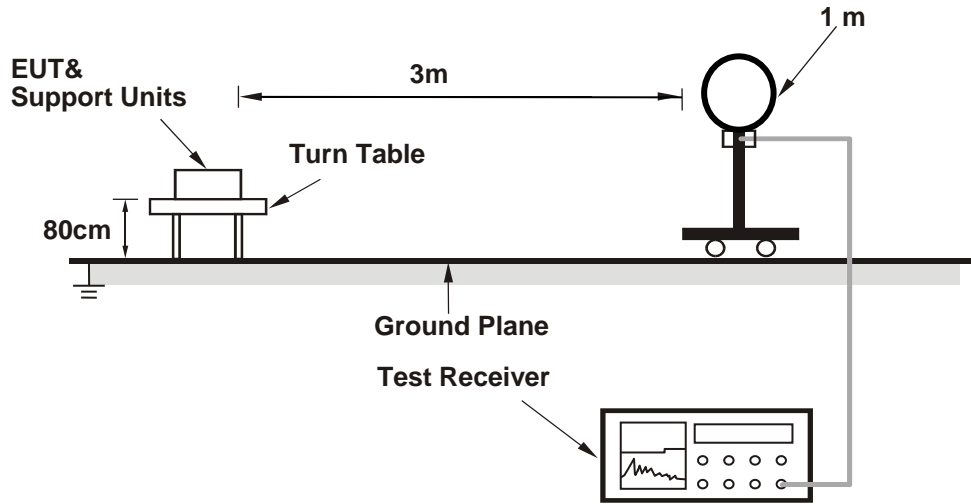

For Radiated emission 30MHz to 1GHz

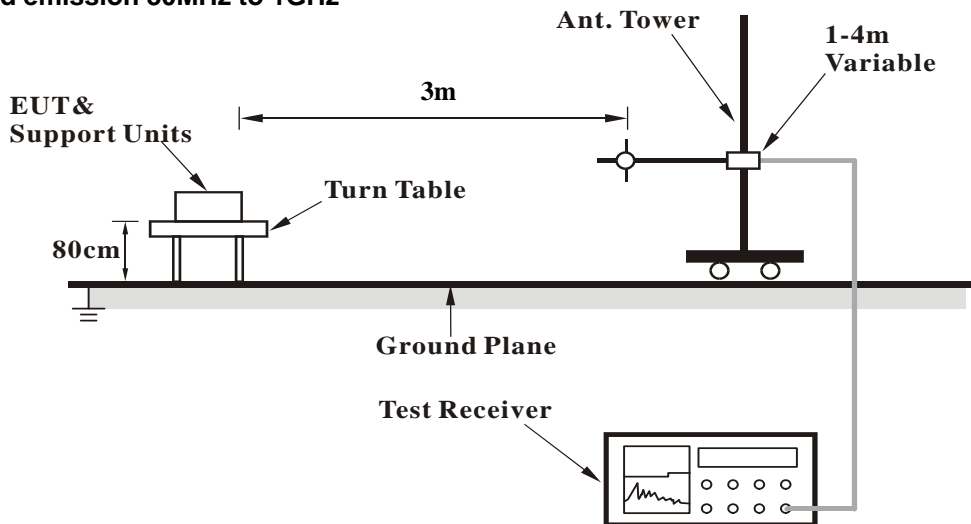

For Radiated emission above 1GHz

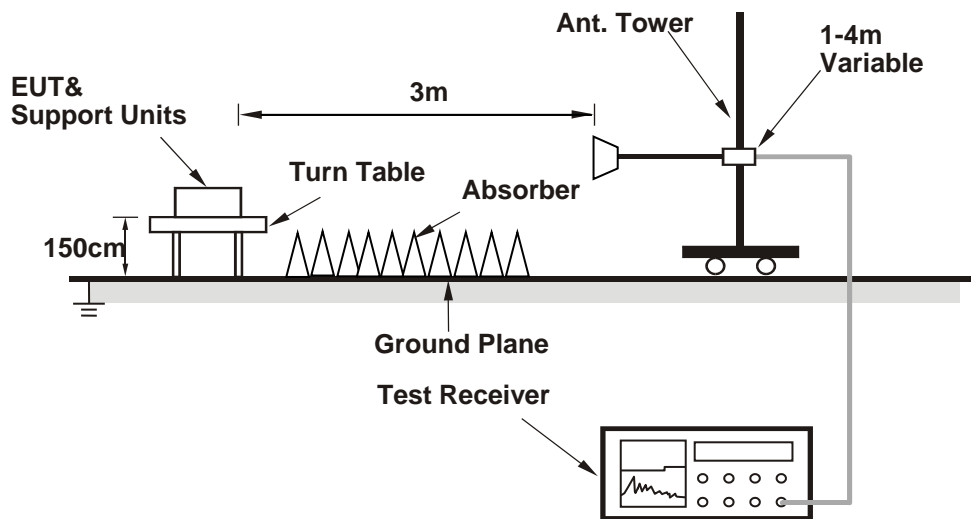

For the actual test configuration, please refer to the attached file (Test Setup Photo).

4.1.6 EUT Operating Conditions

- a. Set the EUT under transmission condition continuously at specific channel frequency.

4.1.7 Test Results

Above 1GHz data:
802.11a

CHANNEL	TX Channel 36	DETECTOR FUNCTION	Peak (PK) Average (AV)
FREQUENCY RANGE	1GHz ~ 40GHz		

ANTENNA POLARITY & TEST DISTANCE: HORIZONTAL AT 3 M								
NO.	FREQ. (MHz)	EMISSION LEVEL (dBuV/m)	LIMIT (dBuV/m)	MARGIN (dB)	ANTENNA HEIGHT (m)	TABLE ANGLE (Degree)	RAW VALUE (dBuV)	CORRECTION FACTOR (dB/m)
1	5150.00	53.6 PK	74.0	-20.4	2.66 H	2	49.7	3.9
2	5150.00	40.0 AV	54.0	-14.0	2.66 H	2	36.1	3.9
3	*5180.00	95.6 PK			2.68 H	2	57.3	38.3
4	*5180.00	86.1 AV			2.68 H	2	47.8	38.3
5	#10360.00	58.0 PK	68.2	-10.2	3.24 H	325	41.4	16.6
ANTENNA POLARITY & TEST DISTANCE: VERTICAL AT 3 M								
NO.	FREQ. (MHz)	EMISSION LEVEL (dBuV/m)	LIMIT (dBuV/m)	MARGIN (dB)	ANTENNA HEIGHT (m)	TABLE ANGLE (Degree)	RAW VALUE (dBuV)	CORRECTION FACTOR (dB/m)
1	5150.00	53.5 PK	74.0	-20.5	1.27 V	263	49.6	3.9
2	5150.00	41.0 AV	54.0	-13.0	1.27 V	263	37.1	3.9
3	*5180.00	96.2 PK			1.28 V	264	57.9	38.3
4	*5180.00	87.2 AV			1.28 V	264	48.9	38.3
5	#10360.00	57.7 PK	68.2	-10.5	3.45 V	247	41.1	16.6

Remarks:

1. Emission Level(dBuV/m) = Raw Value(dBuV) + Correction Factor(dB/m)
2. Correction Factor(dB/m) = Antenna Factor(dB/m) + Cable Factor(dB) – Pre-Amplifier Factor(dB)
3. The other emission levels were very low against the limit.
4. Margin value = Emission Level – Limit value
5. " * ": Fundamental frequency.
6. " # ": The radiated frequency is out of the restricted band.

CHANNEL	TX Channel 40	DETECTOR FUNCTION	Peak (PK)
FREQUENCY RANGE	1GHz ~ 40GHz		Average (AV)

ANTENNA POLARITY & TEST DISTANCE: HORIZONTAL AT 3 M								
NO.	FREQ. (MHz)	EMISSION LEVEL (dBuV/m)	LIMIT (dBuV/m)	MARGIN (dB)	ANTENNA HEIGHT (m)	TABLE ANGLE (Degree)	RAW VALUE (dBuV)	CORRECTION FACTOR (dB/m)
1	*5200.00	95.1 PK			2.61 H	7	57.0	38.1
2	*5200.00	85.4 AV			2.61 H	7	47.3	38.1
3	#10400.00	58.2 PK	68.2	-10.0	3.47 H	261	41.5	16.7
ANTENNA POLARITY & TEST DISTANCE: VERTICAL AT 3 M								
NO.	FREQ. (MHz)	EMISSION LEVEL (dBuV/m)	LIMIT (dBuV/m)	MARGIN (dB)	ANTENNA HEIGHT (m)	TABLE ANGLE (Degree)	RAW VALUE (dBuV)	CORRECTION FACTOR (dB/m)
1	*5200.00	96.4 PK			1.15 V	262	58.3	38.1
2	*5200.00	86.6 AV			1.15 V	262	48.5	38.1
3	#10400.00	57.3 PK	68.2	-10.9	3.10 V	334	40.6	16.7

Remarks:

1. Emission Level(dBuV/m) = Raw Value(dBuV) + Correction Factor(dB/m)
2. Correction Factor(dB/m) = Antenna Factor(dB/m) + Cable Factor(dB) – Pre-Amplifier Factor(dB)
3. The other emission levels were very low against the limit.
4. Margin value = Emission Level – Limit value
5. " * ": Fundamental frequency.
6. " # ": The radiated frequency is out of the restricted band.

CHANNEL	TX Channel 48	DETECTOR FUNCTION	Peak (PK)
FREQUENCY RANGE	1GHz ~ 40GHz		Average (AV)

ANTENNA POLARITY & TEST DISTANCE: HORIZONTAL AT 3 M								
NO.	FREQ. (MHz)	EMISSION LEVEL (dBuV/m)	LIMIT (dBuV/m)	MARGIN (dB)	ANTENNA HEIGHT (m)	TABLE ANGLE (Degree)	RAW VALUE (dBuV)	CORRECTION FACTOR (dB/m)
1	*5240.00	95.3 PK			2.73 H	1	57.2	38.1
2	*5240.00	85.9 AV			2.73 H	1	47.8	38.1
3	5350.00	54.0 PK	74.0	-20.0	2.56 H	6	50.2	3.8
4	5350.00	40.4 AV	54.0	-13.6	2.56 H	6	36.6	3.8
5	#10480.00	57.4 PK	68.2	-10.8	3.36 H	244	40.9	16.5

ANTENNA POLARITY & TEST DISTANCE: VERTICAL AT 3 M								
NO.	FREQ. (MHz)	EMISSION LEVEL (dBuV/m)	LIMIT (dBuV/m)	MARGIN (dB)	ANTENNA HEIGHT (m)	TABLE ANGLE (Degree)	RAW VALUE (dBuV)	CORRECTION FACTOR (dB/m)
1	*5240.00	96.2 PK			1.00 V	269	58.1	38.1
2	*5240.00	86.9 AV			1.00 V	269	48.8	38.1
3	5350.00	54.0 PK	74.0	-20.0	1.08 V	266	50.2	3.8
4	5350.00	40.4 AV	54.0	-13.6	1.08 V	266	36.6	3.8
5	#10480.00	57.9 PK	68.2	-10.3	3.11 V	321	41.4	16.5

Remarks:

1. Emission Level(dBuV/m) = Raw Value(dBuV) + Correction Factor(dB/m)
2. Correction Factor(dB/m) = Antenna Factor(dB/m) + Cable Factor(dB) – Pre-Amplifier Factor(dB)
3. The other emission levels were very low against the limit.
4. Margin value = Emission Level – Limit value
5. " * ": Fundamental frequency.
6. " # ": The radiated frequency is out of the restricted band.

CHANNEL	TX Channel 52	DETECTOR FUNCTION	Peak (PK)
FREQUENCY RANGE	1GHz ~ 40GHz		Average (AV)

ANTENNA POLARITY & TEST DISTANCE: HORIZONTAL AT 3 M								
NO.	FREQ. (MHz)	EMISSION LEVEL (dBuV/m)	LIMIT (dBuV/m)	MARGIN (dB)	ANTENNA HEIGHT (m)	TABLE ANGLE (Degree)	RAW VALUE (dBuV)	CORRECTION FACTOR (dB/m)
1	5150.00	54.4 PK	74.0	-19.6	2.58 H	5	50.5	3.9
2	5150.00	40.5 AV	54.0	-13.5	2.58 H	5	36.6	3.9
3	*5260.00	95.9 PK			2.65 H	2	57.8	38.1
4	*5260.00	86.3 AV			2.65 H	2	48.2	38.1
5	#10520.00	57.6 PK	68.2	-10.6	3.41 H	254	41.0	16.6

ANTENNA POLARITY & TEST DISTANCE: VERTICAL AT 3 M								
NO.	FREQ. (MHz)	EMISSION LEVEL (dBuV/m)	LIMIT (dBuV/m)	MARGIN (dB)	ANTENNA HEIGHT (m)	TABLE ANGLE (Degree)	RAW VALUE (dBuV)	CORRECTION FACTOR (dB/m)
1	5150.00	54.2 PK	74.0	-19.8	1.15 V	277	50.3	3.9
2	5150.00	40.7 AV	54.0	-13.3	1.15 V	277	36.8	3.9
3	*5260.00	96.8 PK			1.12 V	274	58.7	38.1
4	*5260.00	87.3 AV			1.12 V	274	49.2	38.1
5	#10520.00	57.9 PK	68.2	-10.3	3.22 V	329	41.3	16.6

Remarks:

1. Emission Level(dBuV/m) = Raw Value(dBuV) + Correction Factor(dB/m)
2. Correction Factor(dB/m) = Antenna Factor(dB/m) + Cable Factor(dB) – Pre-Amplifier Factor(dB)
3. The other emission levels were very low against the limit.
4. Margin value = Emission Level – Limit value
5. " * ": Fundamental frequency.
6. " # ": The radiated frequency is out of the restricted band.

CHANNEL	TX Channel 60	DETECTOR FUNCTION	Peak (PK)
FREQUENCY RANGE	1GHz ~ 40GHz		Average (AV)

ANTENNA POLARITY & TEST DISTANCE: HORIZONTAL AT 3 M								
NO.	FREQ. (MHz)	EMISSION LEVEL (dBuV/m)	LIMIT (dBuV/m)	MARGIN (dB)	ANTENNA HEIGHT (m)	TABLE ANGLE (Degree)	RAW VALUE (dBuV)	CORRECTION FACTOR (dB/m)
1	*5300.00	96.4 PK			2.61 H	6	58.3	38.1
2	*5300.00	86.5 AV			2.61 H	6	48.4	38.1
3	10600.00	58.1 PK	74.0	-15.9	3.45 H	255	41.3	16.8
4	10600.00	44.6 AV	54.0	-9.4	3.45 H	255	27.8	16.8
ANTENNA POLARITY & TEST DISTANCE: VERTICAL AT 3 M								
NO.	FREQ. (MHz)	EMISSION LEVEL (dBuV/m)	LIMIT (dBuV/m)	MARGIN (dB)	ANTENNA HEIGHT (m)	TABLE ANGLE (Degree)	RAW VALUE (dBuV)	CORRECTION FACTOR (dB/m)
1	*5300.00	97.5 PK			1.04 V	276	59.4	38.1
2	*5300.00	87.6 AV			1.04 V	276	49.5	38.1
3	10600.00	57.5 PK	74.0	-16.5	3.17 V	331	40.7	16.8
4	10600.00	44.5 AV	54.0	-9.5	3.17 V	331	27.7	16.8

Remarks:

1. Emission Level(dBuV/m) = Raw Value(dBuV) + Correction Factor(dB/m)
2. Correction Factor(dB/m) = Antenna Factor(dB/m) + Cable Factor(dB) – Pre-Amplifier Factor(dB)
3. The other emission levels were very low against the limit.
4. Margin value = Emission Level – Limit value
5. " * ": Fundamental frequency.
6. " # ": The radiated frequency is out of the restricted band.

CHANNEL	TX Channel 64	DETECTOR FUNCTION	Peak (PK)
FREQUENCY RANGE	1GHz ~ 40GHz		Average (AV)

ANTENNA POLARITY & TEST DISTANCE: HORIZONTAL AT 3 M								
NO.	FREQ. (MHz)	EMISSION LEVEL (dBuV/m)	LIMIT (dBuV/m)	MARGIN (dB)	ANTENNA HEIGHT (m)	TABLE ANGLE (Degree)	RAW VALUE (dBuV)	CORRECTION FACTOR (dB/m)
1	*5320.00	94.9 PK			2.82 H	5	56.8	38.1
2	*5320.00	85.0 AV			2.82 H	5	46.9	38.1
3	5350.00	53.9 PK	74.0	-20.1	2.68 H	5	50.1	3.8
4	5350.00	40.4 AV	54.0	-13.6	2.68 H	5	36.6	3.8
5	10640.00	58.2 PK	74.0	-15.8	3.40 H	257	41.2	17.0
6	10640.00	44.4 AV	54.0	-9.6	3.40 H	257	27.4	17.0

ANTENNA POLARITY & TEST DISTANCE: VERTICAL AT 3 M								
NO.	FREQ. (MHz)	EMISSION LEVEL (dBuV/m)	LIMIT (dBuV/m)	MARGIN (dB)	ANTENNA HEIGHT (m)	TABLE ANGLE (Degree)	RAW VALUE (dBuV)	CORRECTION FACTOR (dB/m)
1	*5320.00	96.2 PK			1.09 V	276	58.1	38.1
2	*5320.00	86.2 AV			1.09 V	276	48.1	38.1
3	5350.00	54.2 PK	74.0	-19.8	1.00 V	277	50.4	3.8
4	5350.00	40.6 AV	54.0	-13.4	1.00 V	277	36.8	3.8
5	10640.00	58.0 PK	74.0	-16.0	3.20 V	324	41.0	17.0
6	10640.00	44.5 AV	54.0	-9.5	3.20 V	324	27.5	17.0

Remarks:

1. Emission Level(dBuV/m) = Raw Value(dBuV) + Correction Factor(dB/m)
2. Correction Factor(dB/m) = Antenna Factor(dB/m) + Cable Factor(dB) – Pre-Amplifier Factor(dB)
3. The other emission levels were very low against the limit.
4. Margin value = Emission Level – Limit value
5. " * ": Fundamental frequency.
6. " # ": The radiated frequency is out of the restricted band.

CHANNEL	TX Channel 100	DETECTOR FUNCTION	Peak (PK)
FREQUENCY RANGE	1GHz ~ 40GHz		Average (AV)

ANTENNA POLARITY & TEST DISTANCE: HORIZONTAL AT 3 M								
NO.	FREQ. (MHz)	EMISSION LEVEL (dBuV/m)	LIMIT (dBuV/m)	MARGIN (dB)	ANTENNA HEIGHT (m)	TABLE ANGLE (Degree)	RAW VALUE (dBuV)	CORRECTION FACTOR (dB/m)
1	5460.00	53.8 PK	74.0	-20.2	2.71 H	1	49.6	4.2
2	5460.00	41.8 AV	54.0	-12.2	2.71 H	1	37.6	4.2
3	#5470.00	54.7 PK	68.2	-13.5	2.75 H	5	50.4	4.3
4	*5500.00	94.7 PK			2.58 H	3	56.0	38.7
5	*5500.00	85.5 AV			2.58 H	3	46.8	38.7
6	11000.00	59.9 PK	74.0	-14.1	3.44 H	259	41.5	18.4
7	11000.00	46.1 AV	54.0	-7.9	3.44 H	259	27.7	18.4
ANTENNA POLARITY & TEST DISTANCE: VERTICAL AT 3 M								
NO.	FREQ. (MHz)	EMISSION LEVEL (dBuV/m)	LIMIT (dBuV/m)	MARGIN (dB)	ANTENNA HEIGHT (m)	TABLE ANGLE (Degree)	RAW VALUE (dBuV)	CORRECTION FACTOR (dB/m)
1	5460.00	53.9 PK	74.0	-20.1	2.49 V	107	49.7	4.2
2	5460.00	42.7 AV	54.0	-11.3	2.49 V	107	38.5	4.2
3	#5470.00	54.2 PK	68.2	-14.0	2.50 V	105	49.9	4.3
4	*5500.00	95.6 PK			2.51 V	108	56.9	38.7
5	*5500.00	86.5 AV			2.51 V	108	47.8	38.7
6	11000.00	59.3 PK	74.0	-14.7	3.07 V	325	40.9	18.4
7	11000.00	45.8 AV	54.0	-8.2	3.07 V	325	27.4	18.4

Remarks:

1. Emission Level(dBuV/m) = Raw Value(dBuV) + Correction Factor(dB/m)
2. Correction Factor(dB/m) = Antenna Factor(dB/m) + Cable Factor(dB) – Pre-Amplifier Factor(dB)
3. The other emission levels were very low against the limit.
4. Margin value = Emission Level – Limit value
5. " * ": Fundamental frequency.
6. " # ": The radiated frequency is out of the restricted band.

CHANNEL	TX Channel 116	DETECTOR FUNCTION	Peak (PK)
FREQUENCY RANGE	1GHz ~ 40GHz		Average (AV)

ANTENNA POLARITY & TEST DISTANCE: HORIZONTAL AT 3 M								
NO.	FREQ. (MHz)	EMISSION LEVEL (dBuV/m)	LIMIT (dBuV/m)	MARGIN (dB)	ANTENNA HEIGHT (m)	TABLE ANGLE (Degree)	RAW VALUE (dBuV)	CORRECTION FACTOR (dB/m)
1	*5580.00	94.2 PK			2.63 H	7	55.6	38.6
2	*5580.00	84.8 AV			2.63 H	7	46.2	38.6
3	11160.00	58.5 PK	74.0	-15.5	3.49 H	246	41.3	17.2
4	11160.00	44.6 AV	54.0	-9.4	3.49 H	246	27.4	17.2
ANTENNA POLARITY & TEST DISTANCE: VERTICAL AT 3 M								
NO.	FREQ. (MHz)	EMISSION LEVEL (dBuV/m)	LIMIT (dBuV/m)	MARGIN (dB)	ANTENNA HEIGHT (m)	TABLE ANGLE (Degree)	RAW VALUE (dBuV)	CORRECTION FACTOR (dB/m)
1	*5580.00	95.3 PK			2.45 V	115	56.7	38.6
2	*5580.00	85.9 AV			2.45 V	115	47.3	38.6
3	11160.00	58.2 PK	74.0	-15.8	3.12 V	328	41.0	17.2
4	11160.00	44.7 AV	54.0	-9.3	3.12 V	328	27.5	17.2

Remarks:

1. Emission Level(dBuV/m) = Raw Value(dBuV) + Correction Factor(dB/m)
2. Correction Factor(dB/m) = Antenna Factor(dB/m) + Cable Factor(dB) – Pre-Amplifier Factor(dB)
3. The other emission levels were very low against the limit.
4. Margin value = Emission Level – Limit value
5. " * ": Fundamental frequency.
6. " # ": The radiated frequency is out of the restricted band.

CHANNEL	TX Channel 140	DETECTOR FUNCTION	Peak (PK)
FREQUENCY RANGE	1GHz ~ 40GHz		Average (AV)

ANTENNA POLARITY & TEST DISTANCE: HORIZONTAL AT 3 M								
NO.	FREQ. (MHz)	EMISSION LEVEL (dBuV/m)	LIMIT (dBuV/m)	MARGIN (dB)	ANTENNA HEIGHT (m)	TABLE ANGLE (Degree)	RAW VALUE (dBuV)	CORRECTION FACTOR (dB/m)
1	*5700.00	93.4 PK			2.61 H	2	54.6	38.8
2	*5700.00	83.9 AV			2.61 H	2	45.1	38.8
3	#5725.00	54.4 PK	68.2	-13.8	2.71 H	4	50.0	4.4
4	11400.00	59.0 PK	74.0	-15.0	3.49 H	257	41.5	17.5
5	11400.00	44.9 AV	54.0	-9.1	3.49 H	257	27.4	17.5

ANTENNA POLARITY & TEST DISTANCE: VERTICAL AT 3 M								
NO.	FREQ. (MHz)	EMISSION LEVEL (dBuV/m)	LIMIT (dBuV/m)	MARGIN (dB)	ANTENNA HEIGHT (m)	TABLE ANGLE (Degree)	RAW VALUE (dBuV)	CORRECTION FACTOR (dB/m)
1	*5700.00	94.5 PK			2.46 V	108	55.7	38.8
2	*5700.00	85.0 AV			2.46 V	108	46.2	38.8
3	#5725.00	54.6 PK	68.2	-13.6	2.45 V	107	50.2	4.4
4	11400.00	58.7 PK	74.0	-15.3	3.07 V	324	41.2	17.5
5	11400.00	45.0 AV	54.0	-9.0	3.07 V	324	27.5	17.5

Remarks:

1. Emission Level(dBuV/m) = Raw Value(dBuV) + Correction Factor(dB/m)
2. Correction Factor(dB/m) = Antenna Factor(dB/m) + Cable Factor(dB) – Pre-Amplifier Factor(dB)
3. The other emission levels were very low against the limit.
4. Margin value = Emission Level – Limit value
5. " * ": Fundamental frequency.
6. " # ": The radiated frequency is out of the restricted band.

CHANNEL	TX Channel 149	DETECTOR FUNCTION	Peak (PK)
FREQUENCY RANGE	1GHz ~ 40GHz		Average (AV)

ANTENNA POLARITY & TEST DISTANCE: HORIZONTAL AT 3 M								
NO.	FREQ. (MHz)	EMISSION LEVEL (dBuV/m)	LIMIT (dBuV/m)	MARGIN (dB)	ANTENNA HEIGHT (m)	TABLE ANGLE (Degree)	RAW VALUE (dBuV)	CORRECTION FACTOR (dB/m)
1	#5640.00	56.2 PK	68.2	-12.0	3.92 H	358	51.9	4.3
2	*5745.00	94.9 PK			3.92 H	358	56.0	38.9
3	*5745.00	85.3 AV			3.92 H	358	46.4	38.9
4	#5962.40	56.6 PK	68.2	-11.6	3.92 H	358	51.6	5.0
5	11490.00	58.2 PK	74.0	-15.8	3.37 H	259	41.3	16.9
6	11490.00	44.7 AV	54.0	-9.3	3.37 H	259	27.8	16.9
ANTENNA POLARITY & TEST DISTANCE: VERTICAL AT 3 M								
NO.	FREQ. (MHz)	EMISSION LEVEL (dBuV/m)	LIMIT (dBuV/m)	MARGIN (dB)	ANTENNA HEIGHT (m)	TABLE ANGLE (Degree)	RAW VALUE (dBuV)	CORRECTION FACTOR (dB/m)
1	#5612.00	55.3 PK	68.2	-12.9	2.52 V	78	51.1	4.2
2	*5745.00	96.0 PK			2.52 V	78	57.1	38.9
3	*5745.00	87.1 AV			2.52 V	78	48.2	38.9
4	#5940.80	55.9 PK	68.2	-12.3	2.52 V	78	50.9	5.0
5	11490.00	58.4 PK	74.0	-15.6	3.08 V	336	41.5	16.9
6	11490.00	44.7 AV	54.0	-9.3	3.08 V	336	27.8	16.9

Remarks:

1. Emission Level(dBuV/m) = Raw Value(dBuV) + Correction Factor(dB/m)
2. Correction Factor(dB/m) = Antenna Factor(dB/m) + Cable Factor(dB) – Pre-Amplifier Factor(dB)
3. The other emission levels were very low against the limit.
4. Margin value = Emission Level – Limit value
5. " * ": Fundamental frequency.
6. " # ": The radiated frequency is out of the restricted band.

CHANNEL	TX Channel 157	DETECTOR FUNCTION	Peak (PK)
FREQUENCY RANGE	1GHz ~ 40GHz		Average (AV)

ANTENNA POLARITY & TEST DISTANCE: HORIZONTAL AT 3 M								
NO.	FREQ. (MHz)	EMISSION LEVEL (dBuV/m)	LIMIT (dBuV/m)	MARGIN (dB)	ANTENNA HEIGHT (m)	TABLE ANGLE (Degree)	RAW VALUE (dBuV)	CORRECTION FACTOR (dB/m)
1	#5640.00	55.1 PK	68.2	-13.1	3.95 H	358	50.8	4.3
2	*5785.00	92.0 PK			3.95 H	358	53.0	39.0
3	*5785.00	83.0 AV			3.95 H	358	44.0	39.0
4	#5975.20	56.0 PK	68.2	-12.2	3.95 H	358	51.0	5.0
5	11570.00	57.9 PK	74.0	-16.1	3.48 H	243	41.2	16.7
6	11570.00	44.1 AV	54.0	-9.9	3.48 H	243	27.4	16.7
ANTENNA POLARITY & TEST DISTANCE: VERTICAL AT 3 M								
NO.	FREQ. (MHz)	EMISSION LEVEL (dBuV/m)	LIMIT (dBuV/m)	MARGIN (dB)	ANTENNA HEIGHT (m)	TABLE ANGLE (Degree)	RAW VALUE (dBuV)	CORRECTION FACTOR (dB/m)
1	#5632.00	55.4 PK	68.2	-12.8	2.63 V	77	51.1	4.3
2	*5785.00	94.0 PK			2.63 V	77	55.0	39.0
3	*5785.00	84.9 AV			2.63 V	77	45.9	39.0
4	#5987.20	56.5 PK	68.2	-11.7	2.63 V	77	51.5	5.0
5	11570.00	57.8 PK	74.0	-16.2	3.09 V	324	41.1	16.7
6	11570.00	44.5 AV	54.0	-9.5	3.09 V	324	27.8	16.7

Remarks:

1. Emission Level(dBuV/m) = Raw Value(dBuV) + Correction Factor(dB/m)
2. Correction Factor(dB/m) = Antenna Factor(dB/m) + Cable Factor(dB) – Pre-Amplifier Factor(dB)
3. The other emission levels were very low against the limit.
4. Margin value = Emission Level – Limit value
5. " * ": Fundamental frequency.
6. " # ": The radiated frequency is out of the restricted band.

CHANNEL	TX Channel 165	DETECTOR FUNCTION	Peak (PK)
FREQUENCY RANGE	1GHz ~ 40GHz		Average (AV)

ANTENNA POLARITY & TEST DISTANCE: HORIZONTAL AT 3 M								
NO.	FREQ. (MHz)	EMISSION LEVEL (dBuV/m)	LIMIT (dBuV/m)	MARGIN (dB)	ANTENNA HEIGHT (m)	TABLE ANGLE (Degree)	RAW VALUE (dBuV)	CORRECTION FACTOR (dB/m)
1	#5605.60	54.9 PK	68.2	-13.3	3.82 H	357	50.7	4.2
2	*5825.00	90.9 PK			3.82 H	357	51.8	39.1
3	*5825.00	81.1 AV			3.82 H	357	42.0	39.1
4	#5944.00	55.4 PK	68.2	-12.8	3.82 H	357	50.4	5.0
5	11650.00	57.3 PK	74.0	-16.7	3.40 H	250	40.8	16.5
6	11650.00	44.1 AV	54.0	-9.9	3.40 H	250	27.6	16.5
ANTENNA POLARITY & TEST DISTANCE: VERTICAL AT 3 M								
NO.	FREQ. (MHz)	EMISSION LEVEL (dBuV/m)	LIMIT (dBuV/m)	MARGIN (dB)	ANTENNA HEIGHT (m)	TABLE ANGLE (Degree)	RAW VALUE (dBuV)	CORRECTION FACTOR (dB/m)
1	#5608.00	54.7 PK	68.2	-13.5	2.62 V	71	50.5	4.2
2	*5825.00	92.3 PK			2.62 V	71	53.2	39.1
3	*5825.00	82.7 AV			2.62 V	71	43.6	39.1
4	#5965.60	56.8 PK	68.2	-11.4	2.62 V	71	51.8	5.0
5	11650.00	57.9 PK	74.0	-16.1	3.17 V	338	41.4	16.5
6	11650.00	43.9 AV	54.0	-10.1	3.17 V	338	27.4	16.5

Remarks:

1. Emission Level(dBuV/m) = Raw Value(dBuV) + Correction Factor(dB/m)
2. Correction Factor(dB/m) = Antenna Factor(dB/m) + Cable Factor(dB) – Pre-Amplifier Factor(dB)
3. The other emission levels were very low against the limit.
4. Margin value = Emission Level – Limit value
5. " * ": Fundamental frequency.
6. " # ": The radiated frequency is out of the restricted band.

802.11n (HT20)

CHANNEL	TX Channel 36	DETECTOR FUNCTION	Peak (PK) Average (AV)
FREQUENCY RANGE	1GHz ~ 40GHz		

ANTENNA POLARITY & TEST DISTANCE: HORIZONTAL AT 3 M								
NO.	FREQ. (MHz)	EMISSION LEVEL (dBuV/m)	LIMIT (dBuV/m)	MARGIN (dB)	ANTENNA HEIGHT (m)	TABLE ANGLE (Degree)	RAW VALUE (dBuV)	CORRECTION FACTOR (dB/m)
1	5150.00	53.8 PK	74.0	-20.2	2.65 H	5	49.9	3.9
2	5150.00	40.6 AV	54.0	-13.4	2.65 H	5	36.7	3.9
3	*5180.00	94.3 PK			2.71 H	5	56.0	38.3
4	*5180.00	83.2 AV			2.71 H	5	44.9	38.3
5	#10360.00	57.6 PK	68.2	-10.6	3.35 H	258	41.0	16.6
ANTENNA POLARITY & TEST DISTANCE: VERTICAL AT 3 M								
NO.	FREQ. (MHz)	EMISSION LEVEL (dBuV/m)	LIMIT (dBuV/m)	MARGIN (dB)	ANTENNA HEIGHT (m)	TABLE ANGLE (Degree)	RAW VALUE (dBuV)	CORRECTION FACTOR (dB/m)
1	5150.00	53.7 PK	74.0	-20.3	1.15 V	265	49.8	3.9
2	5150.00	40.4 AV	54.0	-13.6	1.15 V	265	36.5	3.9
3	*5180.00	95.6 PK			1.19 V	261	57.3	38.3
4	*5180.00	84.4 AV			1.19 V	261	46.1	38.3
5	#10360.00	57.8 PK	68.2	-10.4	3.19 V	333	41.2	16.6

Remarks:

1. Emission Level(dBuV/m) = Raw Value(dBuV) + Correction Factor(dB/m)
2. Correction Factor(dB/m) = Antenna Factor(dB/m) + Cable Factor(dB) – Pre-Amplifier Factor(dB)
3. The other emission levels were very low against the limit.
4. Margin value = Emission Level – Limit value
5. " * ": Fundamental frequency.
6. " # ": The radiated frequency is out of the restricted band.

CHANNEL	TX Channel 40	DETECTOR FUNCTION	Peak (PK)
FREQUENCY RANGE	1GHz ~ 40GHz		Average (AV)

ANTENNA POLARITY & TEST DISTANCE: HORIZONTAL AT 3 M								
NO.	FREQ. (MHz)	EMISSION LEVEL (dBuV/m)	LIMIT (dBuV/m)	MARGIN (dB)	ANTENNA HEIGHT (m)	TABLE ANGLE (Degree)	RAW VALUE (dBuV)	CORRECTION FACTOR (dB/m)
1	*5200.00	93.5 PK			2.64 H	2	55.4	38.1
2	*5200.00	82.2 AV			2.64 H	2	44.1	38.1
3	#10400.00	57.2 PK	68.2	-11.0	3.39 H	252	40.5	16.7
ANTENNA POLARITY & TEST DISTANCE: VERTICAL AT 3 M								
NO.	FREQ. (MHz)	EMISSION LEVEL (dBuV/m)	LIMIT (dBuV/m)	MARGIN (dB)	ANTENNA HEIGHT (m)	TABLE ANGLE (Degree)	RAW VALUE (dBuV)	CORRECTION FACTOR (dB/m)
1	*5200.00	94.8 PK			1.05 V	261	56.7	38.1
2	*5200.00	83.4 AV			1.05 V	261	45.3	38.1
3	#10400.00	57.2 PK	68.2	-11.0	3.07 V	339	40.5	16.7

Remarks:

1. Emission Level(dBuV/m) = Raw Value(dBuV) + Correction Factor(dB/m)
2. Correction Factor(dB/m) = Antenna Factor(dB/m) + Cable Factor(dB) – Pre-Amplifier Factor(dB)
3. The other emission levels were very low against the limit.
4. Margin value = Emission Level – Limit value
5. " * ": Fundamental frequency.
6. " # ": The radiated frequency is out of the restricted band.

CHANNEL	TX Channel 48	DETECTOR FUNCTION	Peak (PK)
FREQUENCY RANGE	1GHz ~ 40GHz		Average (AV)

ANTENNA POLARITY & TEST DISTANCE: HORIZONTAL AT 3 M								
NO.	FREQ. (MHz)	EMISSION LEVEL (dBuV/m)	LIMIT (dBuV/m)	MARGIN (dB)	ANTENNA HEIGHT (m)	TABLE ANGLE (Degree)	RAW VALUE (dBuV)	CORRECTION FACTOR (dB/m)
1	*5240.00	93.7 PK			2.63 H	1	55.6	38.1
2	*5240.00	82.3 AV			2.63 H	1	44.2	38.1
3	5350.00	54.3 PK	74.0	-19.7	2.66 H	1	50.5	3.8
4	5350.00	40.6 AV	54.0	-13.4	2.66 H	1	36.8	3.8
5	#10480.00	58.0 PK	68.2	-10.2	3.48 H	252	41.5	16.5

ANTENNA POLARITY & TEST DISTANCE: VERTICAL AT 3 M								
NO.	FREQ. (MHz)	EMISSION LEVEL (dBuV/m)	LIMIT (dBuV/m)	MARGIN (dB)	ANTENNA HEIGHT (m)	TABLE ANGLE (Degree)	RAW VALUE (dBuV)	CORRECTION FACTOR (dB/m)
1	*5240.00	95.2 PK			1.00 V	272	57.1	38.1
2	*5240.00	83.6 AV			1.00 V	272	45.5	38.1
3	5350.00	54.2 PK	74.0	-19.8	1.00 V	268	50.4	3.8
4	5350.00	40.4 AV	54.0	-13.6	1.00 V	268	36.6	3.8
5	#10480.00	57.3 PK	68.2	-10.9	3.18 V	323	40.8	16.5

Remarks:

1. Emission Level(dBuV/m) = Raw Value(dBuV) + Correction Factor(dB/m)
2. Correction Factor(dB/m) = Antenna Factor(dB/m) + Cable Factor(dB) – Pre-Amplifier Factor(dB)
3. The other emission levels were very low against the limit.
4. Margin value = Emission Level – Limit value
5. " * ": Fundamental frequency.
6. " # ": The radiated frequency is out of the restricted band.

CHANNEL	TX Channel 52	DETECTOR FUNCTION	Peak (PK)
FREQUENCY RANGE	1GHz ~ 40GHz		Average (AV)

ANTENNA POLARITY & TEST DISTANCE: HORIZONTAL AT 3 M								
NO.	FREQ. (MHz)	EMISSION LEVEL (dBuV/m)	LIMIT (dBuV/m)	MARGIN (dB)	ANTENNA HEIGHT (m)	TABLE ANGLE (Degree)	RAW VALUE (dBuV)	CORRECTION FACTOR (dB/m)
1	5150.00	54.3 PK	74.0	-19.7	2.60 H	6	50.4	3.9
2	5150.00	40.3 AV	54.0	-13.7	2.60 H	6	36.4	3.9
3	*5260.00	93.9 PK			2.60 H	2	55.8	38.1
4	*5260.00	82.4 AV			2.60 H	2	44.3	38.1
5	#10520.00	58.0 PK	68.2	-10.2	3.49 H	251	41.4	16.6

ANTENNA POLARITY & TEST DISTANCE: VERTICAL AT 3 M								
NO.	FREQ. (MHz)	EMISSION LEVEL (dBuV/m)	LIMIT (dBuV/m)	MARGIN (dB)	ANTENNA HEIGHT (m)	TABLE ANGLE (Degree)	RAW VALUE (dBuV)	CORRECTION FACTOR (dB/m)
1	5150.00	53.8 PK	74.0	-20.2	1.00 V	269	49.9	3.9
2	5150.00	40.7 AV	54.0	-13.3	1.00 V	269	36.8	3.9
3	*5260.00	95.4 PK			1.00 V	274	57.3	38.1
4	*5260.00	83.7 AV			1.00 V	274	45.6	38.1
5	#10520.00	57.4 PK	68.2	-10.8	3.21 V	329	40.8	16.6

Remarks:

1. Emission Level(dBuV/m) = Raw Value(dBuV) + Correction Factor(dB/m)
2. Correction Factor(dB/m) = Antenna Factor(dB/m) + Cable Factor(dB) – Pre-Amplifier Factor(dB)
3. The other emission levels were very low against the limit.
4. Margin value = Emission Level – Limit value
5. " * ": Fundamental frequency.
6. " # ": The radiated frequency is out of the restricted band.

CHANNEL	TX Channel 60	DETECTOR FUNCTION	Peak (PK)
FREQUENCY RANGE	1GHz ~ 40GHz		Average (AV)

ANTENNA POLARITY & TEST DISTANCE: HORIZONTAL AT 3 M								
NO.	FREQ. (MHz)	EMISSION LEVEL (dBuV/m)	LIMIT (dBuV/m)	MARGIN (dB)	ANTENNA HEIGHT (m)	TABLE ANGLE (Degree)	RAW VALUE (dBuV)	CORRECTION FACTOR (dB/m)
1	*5300.00	95.0 PK			2.74 H	3	56.9	38.1
2	*5300.00	83.4 AV			2.74 H	3	45.3	38.1
3	10600.00	57.3 PK	74.0	-16.7	3.48 H	249	40.5	16.8
4	10600.00	44.3 AV	54.0	-9.7	3.48 H	249	27.5	16.8
ANTENNA POLARITY & TEST DISTANCE: VERTICAL AT 3 M								
NO.	FREQ. (MHz)	EMISSION LEVEL (dBuV/m)	LIMIT (dBuV/m)	MARGIN (dB)	ANTENNA HEIGHT (m)	TABLE ANGLE (Degree)	RAW VALUE (dBuV)	CORRECTION FACTOR (dB/m)
1	*5300.00	95.9 PK			1.00 V	277	57.8	38.1
2	*5300.00	84.4 AV			1.00 V	277	46.3	38.1
3	10600.00	57.7 PK	74.0	-16.3	3.19 V	335	40.9	16.8
4	10600.00	44.2 AV	54.0	-9.8	3.19 V	335	27.4	16.8

Remarks:

1. Emission Level(dBuV/m) = Raw Value(dBuV) + Correction Factor(dB/m)
2. Correction Factor(dB/m) = Antenna Factor(dB/m) + Cable Factor(dB) – Pre-Amplifier Factor(dB)
3. The other emission levels were very low against the limit.
4. Margin value = Emission Level – Limit value
5. " * ": Fundamental frequency.
6. " # ": The radiated frequency is out of the restricted band.

CHANNEL	TX Channel 64	DETECTOR FUNCTION	Peak (PK)
FREQUENCY RANGE	1GHz ~ 40GHz		Average (AV)

ANTENNA POLARITY & TEST DISTANCE: HORIZONTAL AT 3 M								
NO.	FREQ. (MHz)	EMISSION LEVEL (dBuV/m)	LIMIT (dBuV/m)	MARGIN (dB)	ANTENNA HEIGHT (m)	TABLE ANGLE (Degree)	RAW VALUE (dBuV)	CORRECTION FACTOR (dB/m)
1	*5320.00	93.9 PK			2.57 H	5	55.8	38.1
2	*5320.00	82.1 AV			2.57 H	5	44.0	38.1
3	5350.00	53.8 PK	74.0	-20.2	2.70 H	2	50.0	3.8
4	5350.00	40.2 AV	54.0	-13.8	2.70 H	2	36.4	3.8
5	10640.00	58.3 PK	74.0	-15.7	3.32 H	260	41.3	17.0
6	10640.00	44.7 AV	54.0	-9.3	3.32 H	260	27.7	17.0
ANTENNA POLARITY & TEST DISTANCE: VERTICAL AT 3 M								
NO.	FREQ. (MHz)	EMISSION LEVEL (dBuV/m)	LIMIT (dBuV/m)	MARGIN (dB)	ANTENNA HEIGHT (m)	TABLE ANGLE (Degree)	RAW VALUE (dBuV)	CORRECTION FACTOR (dB/m)
1	*5320.00	95.4 PK			1.11 V	276	57.3	38.1
2	*5320.00	83.4 AV			1.11 V	276	45.3	38.1
3	5350.00	53.3 PK	74.0	-20.7	1.16 V	278	49.5	3.8
4	5350.00	40.3 AV	54.0	-13.7	1.16 V	278	36.5	3.8
5	10640.00	58.4 PK	74.0	-15.6	3.22 V	324	41.4	17.0
6	10640.00	44.7 AV	54.0	-9.3	3.22 V	324	27.7	17.0

Remarks:

1. Emission Level(dBuV/m) = Raw Value(dBuV) + Correction Factor(dB/m)
2. Correction Factor(dB/m) = Antenna Factor(dB/m) + Cable Factor(dB) – Pre-Amplifier Factor(dB)
3. The other emission levels were very low against the limit.
4. Margin value = Emission Level – Limit value
5. " * ": Fundamental frequency.
6. " # ": The radiated frequency is out of the restricted band.

CHANNEL	TX Channel 100	DETECTOR FUNCTION	Peak (PK)
FREQUENCY RANGE	1GHz ~ 40GHz		Average (AV)

ANTENNA POLARITY & TEST DISTANCE: HORIZONTAL AT 3 M								
NO.	FREQ. (MHz)	EMISSION LEVEL (dBuV/m)	LIMIT (dBuV/m)	MARGIN (dB)	ANTENNA HEIGHT (m)	TABLE ANGLE (Degree)	RAW VALUE (dBuV)	CORRECTION FACTOR (dB/m)
1	5460.00	54.0 PK	74.0	-20.0	2.66 H	5	49.8	4.2
2	5460.00	41.7 AV	54.0	-12.3	2.66 H	5	37.5	4.2
3	#5470.00	54.4 PK	68.2	-13.8	2.68 H	6	50.1	4.3
4	*5500.00	94.0 PK			2.67 H	5	55.3	38.7
5	*5500.00	82.9 AV			2.67 H	5	44.2	38.7
6	11000.00	59.3 PK	74.0	-14.7	3.48 H	244	40.9	18.4
7	11000.00	45.9 AV	54.0	-8.1	3.48 H	244	27.5	18.4
ANTENNA POLARITY & TEST DISTANCE: VERTICAL AT 3 M								
NO.	FREQ. (MHz)	EMISSION LEVEL (dBuV/m)	LIMIT (dBuV/m)	MARGIN (dB)	ANTENNA HEIGHT (m)	TABLE ANGLE (Degree)	RAW VALUE (dBuV)	CORRECTION FACTOR (dB/m)
1	5460.00	53.7 PK	74.0	-20.3	2.52 V	103	49.5	4.2
2	5460.00	41.7 AV	54.0	-12.3	2.52 V	103	37.5	4.2
3	#5470.00	54.6 PK	68.2	-13.6	2.50 V	105	50.3	4.3
4	*5500.00	95.1 PK			2.52 V	104	56.4	38.7
5	*5500.00	84.0 AV			2.52 V	104	45.3	38.7
6	11000.00	59.4 PK	74.0	-14.6	3.09 V	321	41.0	18.4
7	11000.00	45.9 AV	54.0	-8.1	3.09 V	321	27.5	18.4

Remarks:

1. Emission Level(dBuV/m) = Raw Value(dBuV) + Correction Factor(dB/m)
2. Correction Factor(dB/m) = Antenna Factor(dB/m) + Cable Factor(dB) – Pre-Amplifier Factor(dB)
3. The other emission levels were very low against the limit.
4. Margin value = Emission Level – Limit value
5. " * ": Fundamental frequency.
6. " # ": The radiated frequency is out of the restricted band.

CHANNEL	TX Channel 116	DETECTOR FUNCTION	Peak (PK)
FREQUENCY RANGE	1GHz ~ 40GHz		Average (AV)

ANTENNA POLARITY & TEST DISTANCE: HORIZONTAL AT 3 M								
NO.	FREQ. (MHz)	EMISSION LEVEL (dBuV/m)	LIMIT (dBuV/m)	MARGIN (dB)	ANTENNA HEIGHT (m)	TABLE ANGLE (Degree)	RAW VALUE (dBuV)	CORRECTION FACTOR (dB/m)
1	*5580.00	92.4 PK			2.74 H	6	53.8	38.6
2	*5580.00	83.6 AV			2.74 H	6	45.0	38.6
3	11160.00	58.5 PK	74.0	-15.5	3.41 H	245	41.3	17.2
4	11160.00	44.7 AV	54.0	-9.3	3.41 H	245	27.5	17.2
ANTENNA POLARITY & TEST DISTANCE: VERTICAL AT 3 M								
NO.	FREQ. (MHz)	EMISSION LEVEL (dBuV/m)	LIMIT (dBuV/m)	MARGIN (dB)	ANTENNA HEIGHT (m)	TABLE ANGLE (Degree)	RAW VALUE (dBuV)	CORRECTION FACTOR (dB/m)
1	*5580.00	93.7 PK			2.45 V	115	55.1	38.6
2	*5580.00	84.7 AV			2.45 V	115	46.1	38.6
3	11160.00	58.4 PK	74.0	-15.6	3.22 V	322	41.2	17.2
4	11160.00	44.6 AV	54.0	-9.4	3.22 V	322	27.4	17.2

Remarks:

1. Emission Level(dBuV/m) = Raw Value(dBuV) + Correction Factor(dB/m)
2. Correction Factor(dB/m) = Antenna Factor(dB/m) + Cable Factor(dB) – Pre-Amplifier Factor(dB)
3. The other emission levels were very low against the limit.
4. Margin value = Emission Level – Limit value
5. " * ": Fundamental frequency.
6. " # ": The radiated frequency is out of the restricted band.

CHANNEL	TX Channel 140	DETECTOR FUNCTION	Peak (PK)
FREQUENCY RANGE	1GHz ~ 40GHz		Average (AV)

ANTENNA POLARITY & TEST DISTANCE: HORIZONTAL AT 3 M								
NO.	FREQ. (MHz)	EMISSION LEVEL (dBuV/m)	LIMIT (dBuV/m)	MARGIN (dB)	ANTENNA HEIGHT (m)	TABLE ANGLE (Degree)	RAW VALUE (dBuV)	CORRECTION FACTOR (dB/m)
1	*5700.00	91.5 PK			2.75 H	1	52.7	38.8
2	*5700.00	81.1 AV			2.75 H	1	42.3	38.8
3	#5725.00	54.8 PK	68.2	-13.4	2.76 H	4	50.4	4.4
4	11400.00	58.1 PK	74.0	-15.9	3.39 H	251	40.6	17.5
5	11400.00	45.1 AV	54.0	-8.9	3.39 H	251	27.6	17.5

ANTENNA POLARITY & TEST DISTANCE: VERTICAL AT 3 M								
NO.	FREQ. (MHz)	EMISSION LEVEL (dBuV/m)	LIMIT (dBuV/m)	MARGIN (dB)	ANTENNA HEIGHT (m)	TABLE ANGLE (Degree)	RAW VALUE (dBuV)	CORRECTION FACTOR (dB/m)
1	*5700.00	93.0 PK			2.47 V	93	54.2	38.8
2	*5700.00	82.4 AV			2.47 V	93	43.6	38.8
3	#5725.00	55.2 PK	68.2	-13.0	2.42 V	100	50.8	4.4
4	11400.00	58.2 PK	74.0	-15.8	3.20 V	326	40.7	17.5
5	11400.00	45.1 AV	54.0	-8.9	3.20 V	326	27.6	17.5

Remarks:

1. Emission Level(dBuV/m) = Raw Value(dBuV) + Correction Factor(dB/m)
2. Correction Factor(dB/m) = Antenna Factor(dB/m) + Cable Factor(dB) – Pre-Amplifier Factor(dB)
3. The other emission levels were very low against the limit.
4. Margin value = Emission Level – Limit value
5. " * ": Fundamental frequency.
6. " # ": The radiated frequency is out of the restricted band.

CHANNEL	TX Channel 149	DETECTOR FUNCTION	Peak (PK)
FREQUENCY RANGE	1GHz ~ 40GHz		Average (AV)

ANTENNA POLARITY & TEST DISTANCE: HORIZONTAL AT 3 M								
NO.	FREQ. (MHz)	EMISSION LEVEL (dBuV/m)	LIMIT (dBuV/m)	MARGIN (dB)	ANTENNA HEIGHT (m)	TABLE ANGLE (Degree)	RAW VALUE (dBuV)	CORRECTION FACTOR (dB/m)
1	#5629.60	55.1 PK	68.2	-13.1	3.87 H	356	50.8	4.3
2	*5745.00	93.3 PK			3.87 H	356	54.4	38.9
3	*5745.00	83.2 AV			3.87 H	356	44.3	38.9
4	#5936.80	55.4 PK	68.2	-12.8	3.87 H	356	50.4	5.0
5	11490.00	58.0 PK	74.0	-16.0	3.39 H	244	41.1	16.9
6	11490.00	44.6 AV	54.0	-9.4	3.39 H	244	27.7	16.9
ANTENNA POLARITY & TEST DISTANCE: VERTICAL AT 3 M								
NO.	FREQ. (MHz)	EMISSION LEVEL (dBuV/m)	LIMIT (dBuV/m)	MARGIN (dB)	ANTENNA HEIGHT (m)	TABLE ANGLE (Degree)	RAW VALUE (dBuV)	CORRECTION FACTOR (dB/m)
1	#5618.40	55.4 PK	68.2	-12.8	2.54 V	76	51.1	4.3
2	*5745.00	95.3 PK			2.54 V	76	56.4	38.9
3	*5745.00	85.1 AV			2.54 V	76	46.2	38.9
4	#5991.20	56.2 PK	68.2	-12.0	2.54 V	76	51.2	5.0
5	11490.00	57.4 PK	74.0	-16.6	3.22 V	330	40.5	16.9
6	11490.00	44.7 AV	54.0	-9.3	3.22 V	330	27.8	16.9

Remarks:

1. Emission Level(dBuV/m) = Raw Value(dBuV) + Correction Factor(dB/m)
2. Correction Factor(dB/m) = Antenna Factor(dB/m) + Cable Factor(dB) – Pre-Amplifier Factor(dB)
3. The other emission levels were very low against the limit.
4. Margin value = Emission Level – Limit value
5. " * ": Fundamental frequency.
6. " # ": The radiated frequency is out of the restricted band.

CHANNEL	TX Channel 157	DETECTOR FUNCTION	Peak (PK)
FREQUENCY RANGE	1GHz ~ 40GHz		Average (AV)

ANTENNA POLARITY & TEST DISTANCE: HORIZONTAL AT 3 M								
NO.	FREQ. (MHz)	EMISSION LEVEL (dBuV/m)	LIMIT (dBuV/m)	MARGIN (dB)	ANTENNA HEIGHT (m)	TABLE ANGLE (Degree)	RAW VALUE (dBuV)	CORRECTION FACTOR (dB/m)
1	#5640.80	55.0 PK	68.2	-13.2	3.83 H	356	50.7	4.3
2	*5785.00	90.2 PK			3.83 H	356	51.2	39.0
3	*5785.00	80.3 AV			3.83 H	356	41.3	39.0
4	#5990.40	56.0 PK	68.2	-12.2	3.83 H	356	51.0	5.0
5	11570.00	57.2 PK	74.0	-16.8	3.50 H	251	40.5	16.7
6	11570.00	44.1 AV	54.0	-9.9	3.50 H	251	27.4	16.7
ANTENNA POLARITY & TEST DISTANCE: VERTICAL AT 3 M								
NO.	FREQ. (MHz)	EMISSION LEVEL (dBuV/m)	LIMIT (dBuV/m)	MARGIN (dB)	ANTENNA HEIGHT (m)	TABLE ANGLE (Degree)	RAW VALUE (dBuV)	CORRECTION FACTOR (dB/m)
1	#5628.80	55.6 PK	68.2	-12.6	2.56 V	74	51.3	4.3
2	*5785.00	92.2 PK			2.56 V	74	53.2	39.0
3	*5785.00	82.2 AV			2.56 V	74	43.2	39.0
4	#5981.60	56.2 PK	68.2	-12.0	2.56 V	74	51.2	5.0
5	11570.00	57.4 PK	74.0	-16.6	3.06 V	338	40.7	16.7
6	11570.00	44.3 AV	54.0	-9.7	3.06 V	338	27.6	16.7

Remarks:

1. Emission Level(dBuV/m) = Raw Value(dBuV) + Correction Factor(dB/m)
2. Correction Factor(dB/m) = Antenna Factor(dB/m) + Cable Factor(dB) – Pre-Amplifier Factor(dB)
3. The other emission levels were very low against the limit.
4. Margin value = Emission Level – Limit value
5. " * ": Fundamental frequency.
6. " # ": The radiated frequency is out of the restricted band.

CHANNEL	TX Channel 165	DETECTOR FUNCTION	Peak (PK)
FREQUENCY RANGE	1GHz ~ 40GHz		Average (AV)

ANTENNA POLARITY & TEST DISTANCE: HORIZONTAL AT 3 M								
NO.	FREQ. (MHz)	EMISSION LEVEL (dBuV/m)	LIMIT (dBuV/m)	MARGIN (dB)	ANTENNA HEIGHT (m)	TABLE ANGLE (Degree)	RAW VALUE (dBuV)	CORRECTION FACTOR (dB/m)
1	#5615.20	55.1 PK	68.2	-13.1	3.87 H	358	50.8	4.3
2	*5825.00	88.2 PK			3.87 H	358	49.1	39.1
3	*5825.00	78.5 AV			3.87 H	358	39.4	39.1
4	#5964.00	56.1 PK	68.2	-12.1	3.87 H	358	51.1	5.0
5	11650.00	57.9 PK	74.0	-16.1	3.49 H	250	41.4	16.5
6	11650.00	44.1 AV	54.0	-9.9	3.49 H	250	27.6	16.5

ANTENNA POLARITY & TEST DISTANCE: VERTICAL AT 3 M								
NO.	FREQ. (MHz)	EMISSION LEVEL (dBuV/m)	LIMIT (dBuV/m)	MARGIN (dB)	ANTENNA HEIGHT (m)	TABLE ANGLE (Degree)	RAW VALUE (dBuV)	CORRECTION FACTOR (dB/m)
1	#5611.20	55.6 PK	68.2	-12.6	2.47 V	71	51.4	4.2
2	*5825.00	90.0 PK			2.47 V	71	50.9	39.1
3	*5825.00	80.3 AV			2.47 V	71	41.2	39.1
4	#5967.20	56.7 PK	68.2	-11.5	2.47 V	71	51.7	5.0
5	11650.00	57.0 PK	74.0	-17.0	3.15 V	328	40.5	16.5
6	11650.00	44.1 AV	54.0	-9.9	3.15 V	328	27.6	16.5

Remarks:

1. Emission Level(dBuV/m) = Raw Value(dBuV) + Correction Factor(dB/m)
2. Correction Factor(dB/m) = Antenna Factor(dB/m) + Cable Factor(dB) – Pre-Amplifier Factor(dB)
3. The other emission levels were very low against the limit.
4. Margin value = Emission Level – Limit value
5. " * ": Fundamental frequency.
6. " # ": The radiated frequency is out of the restricted band.

802.11n (HT40)

CHANNEL	TX Channel 38	DETECTOR FUNCTION	Peak (PK) Average (AV)
FREQUENCY RANGE	1GHz ~ 40GHz		

ANTENNA POLARITY & TEST DISTANCE: HORIZONTAL AT 3 M

NO.	FREQ. (MHz)	EMISSION LEVEL (dBuV/m)	LIMIT (dBuV/m)	MARGIN (dB)	ANTENNA HEIGHT (m)	TABLE ANGLE (Degree)	RAW VALUE (dBuV)	CORRECTION FACTOR (dB/m)
1	5150.00	54.4 PK	74.0	-19.6	2.70 H	5	50.5	3.9
2	5150.00	40.4 AV	54.0	-13.6	2.70 H	5	36.5	3.9
3	*5190.00	89.9 PK			2.76 H	6	51.7	38.2
4	*5190.00	80.5 AV			2.76 H	6	42.3	38.2
5	#10380.00	58.1 PK	68.2	-10.1	3.43 H	246	41.4	16.7

ANTENNA POLARITY & TEST DISTANCE: VERTICAL AT 3 M

NO.	FREQ. (MHz)	EMISSION LEVEL (dBuV/m)	LIMIT (dBuV/m)	MARGIN (dB)	ANTENNA HEIGHT (m)	TABLE ANGLE (Degree)	RAW VALUE (dBuV)	CORRECTION FACTOR (dB/m)
1	5150.00	53.7 PK	74.0	-20.3	1.15 V	263	49.8	3.9
2	5150.00	40.5 AV	54.0	-13.5	1.15 V	263	36.6	3.9
3	*5190.00	91.4 PK			1.18 V	258	53.2	38.2
4	*5190.00	81.8 AV			1.18 V	258	43.6	38.2
5	#10380.00	57.7 PK	68.2	-10.5	3.08 V	331	41.0	16.7

Remarks:

1. Emission Level(dBuV/m) = Raw Value(dBuV) + Correction Factor(dB/m)
2. Correction Factor(dB/m) = Antenna Factor(dB/m) + Cable Factor(dB) – Pre-Amplifier Factor(dB)
3. The other emission levels were very low against the limit.
4. Margin value = Emission Level – Limit value
5. " * ": Fundamental frequency.
6. " # ": The radiated frequency is out of the restricted band.

CHANNEL	TX Channel 46	DETECTOR FUNCTION	Peak (PK)
FREQUENCY RANGE	1GHz ~ 40GHz		Average (AV)

ANTENNA POLARITY & TEST DISTANCE: HORIZONTAL AT 3 M								
NO.	FREQ. (MHz)	EMISSION LEVEL (dBuV/m)	LIMIT (dBuV/m)	MARGIN (dB)	ANTENNA HEIGHT (m)	TABLE ANGLE (Degree)	RAW VALUE (dBuV)	CORRECTION FACTOR (dB/m)
1	*5230.00	89.5 PK			2.73 H	6	51.4	38.1
2	*5230.00	79.7 AV			2.73 H	6	41.6	38.1
3	5350.00	53.6 PK	74.0	-20.4	2.66 H	2	49.8	3.8
4	5350.00	40.4 AV	54.0	-13.6	2.66 H	2	36.6	3.8
5	#10460.00	57.7 PK	68.2	-10.5	3.45 H	260	41.2	16.5

ANTENNA POLARITY & TEST DISTANCE: VERTICAL AT 3 M								
NO.	FREQ. (MHz)	EMISSION LEVEL (dBuV/m)	LIMIT (dBuV/m)	MARGIN (dB)	ANTENNA HEIGHT (m)	TABLE ANGLE (Degree)	RAW VALUE (dBuV)	CORRECTION FACTOR (dB/m)
1	*5230.00	90.8 PK			1.00 V	271	52.7	38.1
2	*5230.00	80.9 AV			1.00 V	271	42.8	38.1
3	5350.00	53.3 PK	74.0	-20.7	1.00 V	276	49.5	3.8
4	5350.00	40.2 AV	54.0	-13.8	1.00 V	276	36.4	3.8
5	#10460.00	57.4 PK	68.2	-10.8	3.22 V	335	40.9	16.5

Remarks:

1. Emission Level(dBuV/m) = Raw Value(dBuV) + Correction Factor(dB/m)
2. Correction Factor(dB/m) = Antenna Factor(dB/m) + Cable Factor(dB) – Pre-Amplifier Factor(dB)
3. The other emission levels were very low against the limit.
4. Margin value = Emission Level – Limit value
5. " * ": Fundamental frequency.
6. " # ": The radiated frequency is out of the restricted band.

CHANNEL	TX Channel 54	DETECTOR FUNCTION	Peak (PK)
FREQUENCY RANGE	1GHz ~ 40GHz		Average (AV)

ANTENNA POLARITY & TEST DISTANCE: HORIZONTAL AT 3 M								
NO.	FREQ. (MHz)	EMISSION LEVEL (dBuV/m)	LIMIT (dBuV/m)	MARGIN (dB)	ANTENNA HEIGHT (m)	TABLE ANGLE (Degree)	RAW VALUE (dBuV)	CORRECTION FACTOR (dB/m)
1	5150.00	54.0 PK	74.0	-20.0	2.70 H	4	50.1	3.9
2	5150.00	40.5 AV	54.0	-13.5	2.70 H	4	36.6	3.9
3	*5270.00	90.3 PK			2.68 H	4	52.2	38.1
4	*5270.00	80.4 AV			2.68 H	4	42.3	38.1
5	#10540.00	57.6 PK	68.2	-10.6	3.39 H	250	40.9	16.7

ANTENNA POLARITY & TEST DISTANCE: VERTICAL AT 3 M								
NO.	FREQ. (MHz)	EMISSION LEVEL (dBuV/m)	LIMIT (dBuV/m)	MARGIN (dB)	ANTENNA HEIGHT (m)	TABLE ANGLE (Degree)	RAW VALUE (dBuV)	CORRECTION FACTOR (dB/m)
1	5150.00	53.6 PK	74.0	-20.4	1.14 V	270	49.7	3.9
2	5150.00	40.6 AV	54.0	-13.4	1.14 V	270	36.7	3.9
3	*5270.00	91.8 PK			1.10 V	274	53.7	38.1
4	*5270.00	81.7 AV			1.10 V	274	43.6	38.1
5	#10540.00	57.6 PK	68.2	-10.6	3.06 V	339	40.9	16.7

Remarks:

1. Emission Level(dBuV/m) = Raw Value(dBuV) + Correction Factor(dB/m)
2. Correction Factor(dB/m) = Antenna Factor(dB/m) + Cable Factor(dB) – Pre-Amplifier Factor(dB)
3. The other emission levels were very low against the limit.
4. Margin value = Emission Level – Limit value
5. " * ": Fundamental frequency.
6. " # ": The radiated frequency is out of the restricted band.

CHANNEL	TX Channel 62	DETECTOR FUNCTION	Peak (PK)
FREQUENCY RANGE	1GHz ~ 40GHz		Average (AV)

ANTENNA POLARITY & TEST DISTANCE: HORIZONTAL AT 3 M								
NO.	FREQ. (MHz)	EMISSION LEVEL (dBuV/m)	LIMIT (dBuV/m)	MARGIN (dB)	ANTENNA HEIGHT (m)	TABLE ANGLE (Degree)	RAW VALUE (dBuV)	CORRECTION FACTOR (dB/m)
1	*5310.00	90.3 PK			2.68 H	4	52.2	38.1
2	*5310.00	80.4 AV			2.68 H	4	42.3	38.1
3	5350.00	53.9 PK	74.0	-20.1	2.70 H	4	50.1	3.8
4	5350.00	40.4 AV	54.0	-13.6	2.70 H	4	36.6	3.8
5	10620.00	57.8 PK	74.0	-16.2	3.39 H	250	40.9	16.9
6	10620.00	44.7 AV	54.0	-9.3	3.39 H	250	27.8	16.9
ANTENNA POLARITY & TEST DISTANCE: VERTICAL AT 3 M								
NO.	FREQ. (MHz)	EMISSION LEVEL (dBuV/m)	LIMIT (dBuV/m)	MARGIN (dB)	ANTENNA HEIGHT (m)	TABLE ANGLE (Degree)	RAW VALUE (dBuV)	CORRECTION FACTOR (dB/m)
1	*5310.00	91.7 PK			1.09 V	275	53.6	38.1
2	*5310.00	81.7 AV			1.09 V	275	43.6	38.1
3	5350.00	53.5 PK	74.0	-20.5	1.02 V	274	49.7	3.8
4	5350.00	40.5 AV	54.0	-13.5	1.02 V	274	36.7	3.8
5	10620.00	57.8 PK	74.0	-16.2	3.06 V	339	40.9	16.9
6	10620.00	44.3 AV	54.0	-9.7	3.06 V	339	27.4	16.9

Remarks:

1. Emission Level(dBuV/m) = Raw Value(dBuV) + Correction Factor(dB/m)
2. Correction Factor(dB/m) = Antenna Factor(dB/m) + Cable Factor(dB) – Pre-Amplifier Factor(dB)
3. The other emission levels were very low against the limit.
4. Margin value = Emission Level – Limit value
5. " * ": Fundamental frequency.
6. " # ": The radiated frequency is out of the restricted band.

CHANNEL	TX Channel 102	DETECTOR FUNCTION	Peak (PK)
FREQUENCY RANGE	1GHz ~ 40GHz		Average (AV)

ANTENNA POLARITY & TEST DISTANCE: HORIZONTAL AT 3 M								
NO.	FREQ. (MHz)	EMISSION LEVEL (dBuV/m)	LIMIT (dBuV/m)	MARGIN (dB)	ANTENNA HEIGHT (m)	TABLE ANGLE (Degree)	RAW VALUE (dBuV)	CORRECTION FACTOR (dB/m)
1	5460.00	54.2 PK	74.0	-19.8	2.75 H	2	50.0	4.2
2	5460.00	42.0 AV	54.0	-12.0	2.75 H	2	37.8	4.2
3	#5470.00	54.7 PK	68.2	-13.5	2.57 H	7	50.4	4.3
4	*5510.00	89.6 PK			2.66 H	7	51.0	38.6
5	*5510.00	80.2 AV			2.66 H	7	41.6	38.6
6	11020.00	59.6 PK	74.0	-14.4	3.34 H	252	41.5	18.1
7	11020.00	45.7 AV	54.0	-8.3	3.34 H	252	27.6	18.1
ANTENNA POLARITY & TEST DISTANCE: VERTICAL AT 3 M								
NO.	FREQ. (MHz)	EMISSION LEVEL (dBuV/m)	LIMIT (dBuV/m)	MARGIN (dB)	ANTENNA HEIGHT (m)	TABLE ANGLE (Degree)	RAW VALUE (dBuV)	CORRECTION FACTOR (dB/m)
1	5460.00	54.5 PK	74.0	-19.5	2.51 V	104	50.3	4.2
2	5460.00	41.9 AV	54.0	-12.1	2.51 V	104	37.7	4.2
3	#5470.00	54.9 PK	68.2	-13.3	2.52 V	105	50.6	4.3
4	*5510.00	90.9 PK			2.51 V	105	52.3	38.6
5	*5510.00	81.4 AV			2.51 V	105	42.8	38.6
6	11020.00	58.7 PK	74.0	-15.3	3.24 V	337	40.6	18.1
7	11020.00	45.6 AV	54.0	-8.4	3.24 V	337	27.5	18.1

Remarks:

1. Emission Level(dBuV/m) = Raw Value(dBuV) + Correction Factor(dB/m)
2. Correction Factor(dB/m) = Antenna Factor(dB/m) + Cable Factor(dB) – Pre-Amplifier Factor(dB)
3. The other emission levels were very low against the limit.
4. Margin value = Emission Level – Limit value
5. " * ": Fundamental frequency.
6. " # ": The radiated frequency is out of the restricted band.

CHANNEL	TX Channel 110	DETECTOR FUNCTION	Peak (PK)
FREQUENCY RANGE	1GHz ~ 40GHz		Average (AV)

ANTENNA POLARITY & TEST DISTANCE: HORIZONTAL AT 3 M								
NO.	FREQ. (MHz)	EMISSION LEVEL (dBuV/m)	LIMIT (dBuV/m)	MARGIN (dB)	ANTENNA HEIGHT (m)	TABLE ANGLE (Degree)	RAW VALUE (dBuV)	CORRECTION FACTOR (dB/m)
1	*5550.00	89.5 PK			2.63 H	5	50.9	38.6
2	*5550.00	79.7 AV			2.63 H	5	41.1	38.6
3	11100.00	58.3 PK	74.0	-15.7	3.43 H	260	41.0	17.3
4	11100.00	45.0 AV	54.0	-9.0	3.43 H	260	27.7	17.3
ANTENNA POLARITY & TEST DISTANCE: VERTICAL AT 3 M								
NO.	FREQ. (MHz)	EMISSION LEVEL (dBuV/m)	LIMIT (dBuV/m)	MARGIN (dB)	ANTENNA HEIGHT (m)	TABLE ANGLE (Degree)	RAW VALUE (dBuV)	CORRECTION FACTOR (dB/m)
1	*5550.00	90.6 PK			2.49 V	117	52.0	38.6
2	*5550.00	80.8 AV			2.49 V	117	42.2	38.6
3	11100.00	58.7 PK	74.0	-15.3	3.15 V	336	41.4	17.3
4	11100.00	44.7 AV	54.0	-9.3	3.15 V	336	27.4	17.3

Remarks:

1. Emission Level(dBuV/m) = Raw Value(dBuV) + Correction Factor(dB/m)
2. Correction Factor(dB/m) = Antenna Factor(dB/m) + Cable Factor(dB) – Pre-Amplifier Factor(dB)
3. The other emission levels were very low against the limit.
4. Margin value = Emission Level – Limit value
5. " * ": Fundamental frequency.
6. " # ": The radiated frequency is out of the restricted band.

CHANNEL	TX Channel 134	DETECTOR FUNCTION	Peak (PK)
FREQUENCY RANGE	1GHz ~ 40GHz		Average (AV)

ANTENNA POLARITY & TEST DISTANCE: HORIZONTAL AT 3 M								
NO.	FREQ. (MHz)	EMISSION LEVEL (dBuV/m)	LIMIT (dBuV/m)	MARGIN (dB)	ANTENNA HEIGHT (m)	TABLE ANGLE (Degree)	RAW VALUE (dBuV)	CORRECTION FACTOR (dB/m)
1	*5670.00	88.8 PK			2.66 H	6	50.1	38.7
2	*5670.00	79.4 AV			2.66 H	6	40.7	38.7
3	#5725.00	54.7 PK	68.2	-13.5	2.58 H	5	50.3	4.4
4	11340.00	58.5 PK	74.0	-15.5	3.49 H	246	40.8	17.7
5	11340.00	45.3 AV	54.0	-8.7	3.49 H	246	27.6	17.7

ANTENNA POLARITY & TEST DISTANCE: VERTICAL AT 3 M								
NO.	FREQ. (MHz)	EMISSION LEVEL (dBuV/m)	LIMIT (dBuV/m)	MARGIN (dB)	ANTENNA HEIGHT (m)	TABLE ANGLE (Degree)	RAW VALUE (dBuV)	CORRECTION FACTOR (dB/m)
1	*5670.00	90.1 PK			2.59 V	96	51.4	38.7
2	*5670.00	80.6 AV			2.59 V	96	41.9	38.7
3	#5725.00	54.3 PK	68.2	-13.9	2.60 V	95	49.9	4.4
4	11340.00	58.5 PK	74.0	-15.5	3.06 V	326	40.8	17.7
5	11340.00	45.2 AV	54.0	-8.8	3.06 V	326	27.5	17.7

Remarks:

1. Emission Level(dBuV/m) = Raw Value(dBuV) + Correction Factor(dB/m)
2. Correction Factor(dB/m) = Antenna Factor(dB/m) + Cable Factor(dB) – Pre-Amplifier Factor(dB)
3. The other emission levels were very low against the limit.
4. Margin value = Emission Level – Limit value
5. " * ": Fundamental frequency.
6. " # ": The radiated frequency is out of the restricted band.

CHANNEL	TX Channel 151	DETECTOR FUNCTION	Peak (PK)
FREQUENCY RANGE	1GHz ~ 40GHz		Average (AV)

ANTENNA POLARITY & TEST DISTANCE: HORIZONTAL AT 3 M								
NO.	FREQ. (MHz)	EMISSION LEVEL (dBuV/m)	LIMIT (dBuV/m)	MARGIN (dB)	ANTENNA HEIGHT (m)	TABLE ANGLE (Degree)	RAW VALUE (dBuV)	CORRECTION FACTOR (dB/m)
1	#5635.20	54.6 PK	68.2	-13.6	3.84 H	356	50.3	4.3
2	*5755.00	89.2 PK			3.84 H	356	50.3	38.9
3	*5755.00	79.8 AV			3.84 H	356	40.9	38.9
4	#5967.20	56.4 PK	68.2	-11.8	3.84 H	356	51.4	5.0
5	11510.00	57.4 PK	74.0	-16.6	3.47 H	248	40.5	16.9
6	11510.00	44.6 AV	54.0	-9.4	3.47 H	248	27.7	16.9
ANTENNA POLARITY & TEST DISTANCE: VERTICAL AT 3 M								
NO.	FREQ. (MHz)	EMISSION LEVEL (dBuV/m)	LIMIT (dBuV/m)	MARGIN (dB)	ANTENNA HEIGHT (m)	TABLE ANGLE (Degree)	RAW VALUE (dBuV)	CORRECTION FACTOR (dB/m)
1	#5626.40	55.2 PK	68.2	-13.0	2.52 V	77	50.9	4.3
2	*5755.00	90.8 PK			2.52 V	77	51.9	38.9
3	*5755.00	81.5 AV			2.52 V	77	42.6	38.9
4	#5955.20	57.1 PK	68.2	-11.1	2.52 V	77	52.1	5.0
5	11510.00	57.7 PK	74.0	-16.3	3.09 V	338	40.8	16.9
6	11510.00	44.6 AV	54.0	-9.4	3.09 V	338	27.7	16.9

Remarks:

1. Emission Level(dBuV/m) = Raw Value(dBuV) + Correction Factor(dB/m)
2. Correction Factor(dB/m) = Antenna Factor(dB/m) + Cable Factor(dB) – Pre-Amplifier Factor(dB)
3. The other emission levels were very low against the limit.
4. Margin value = Emission Level – Limit value
5. " * ": Fundamental frequency.
6. " # ": The radiated frequency is out of the restricted band.

CHANNEL	TX Channel 159	DETECTOR FUNCTION	Peak (PK)
FREQUENCY RANGE	1GHz ~ 40GHz		Average (AV)

ANTENNA POLARITY & TEST DISTANCE: HORIZONTAL AT 3 M								
NO.	FREQ. (MHz)	EMISSION LEVEL (dBuV/m)	LIMIT (dBuV/m)	MARGIN (dB)	ANTENNA HEIGHT (m)	TABLE ANGLE (Degree)	RAW VALUE (dBuV)	CORRECTION FACTOR (dB/m)
1	#5605.60	55.0 PK	68.2	-13.2	3.86 H	358	50.8	4.2
2	*5795.00	88.1 PK			3.86 H	358	49.1	39.0
3	*5795.00	78.3 AV			3.86 H	358	39.3	39.0
4	#5988.80	55.9 PK	68.2	-12.3	3.86 H	358	50.9	5.0
5	11590.00	57.1 PK	74.0	-16.9	3.50 H	245	40.6	16.5
6	11590.00	43.9 AV	54.0	-10.1	3.50 H	245	27.4	16.5
ANTENNA POLARITY & TEST DISTANCE: VERTICAL AT 3 M								
NO.	FREQ. (MHz)	EMISSION LEVEL (dBuV/m)	LIMIT (dBuV/m)	MARGIN (dB)	ANTENNA HEIGHT (m)	TABLE ANGLE (Degree)	RAW VALUE (dBuV)	CORRECTION FACTOR (dB/m)
1	#5640.80	55.3 PK	68.2	-12.9	2.60 V	74	51.0	4.3
2	*5795.00	90.3 PK			2.60 V	74	51.3	39.0
3	*5795.00	80.3 AV			2.60 V	74	41.3	39.0
4	#5983.20	55.8 PK	68.2	-12.4	2.60 V	74	50.8	5.0
5	11590.00	57.3 PK	74.0	-16.7	3.12 V	333	40.8	16.5
6	11590.00	44.0 AV	54.0	-10.0	3.12 V	333	27.5	16.5

Remarks:

1. Emission Level(dBuV/m) = Raw Value(dBuV) + Correction Factor(dB/m)
2. Correction Factor(dB/m) = Antenna Factor(dB/m) + Cable Factor(dB) – Pre-Amplifier Factor(dB)
3. The other emission levels were very low against the limit.
4. Margin value = Emission Level – Limit value
5. " * ": Fundamental frequency.
6. " # ": The radiated frequency is out of the restricted band.

802.11ac (VHT80)

CHANNEL	TX Channel 42	DETECTOR FUNCTION	Peak (PK) Average (AV)
FREQUENCY RANGE	1GHz ~ 40GHz		

ANTENNA POLARITY & TEST DISTANCE: HORIZONTAL AT 3 M								
NO.	FREQ. (MHz)	EMISSION LEVEL (dBuV/m)	LIMIT (dBuV/m)	MARGIN (dB)	ANTENNA HEIGHT (m)	TABLE ANGLE (Degree)	RAW VALUE (dBuV)	CORRECTION FACTOR (dB/m)
1	5150.00	53.6 PK	74.0	-20.4	2.74 H	5	49.7	3.9
2	5150.00	41.7 AV	54.0	-12.3	2.74 H	5	37.8	3.9
3	*5210.00	89.8 PK			2.69 H	3	51.7	38.1
4	*5210.00	79.7 AV			2.69 H	3	41.6	38.1
5	5350.00	53.4 PK	74.0	-20.6	2.68 H	3	49.6	3.8
6	5350.00	41.4 AV	54.0	-12.6	2.68 H	3	37.6	3.8
7	#10420.00	57.6 PK	68.2	-10.6	3.50 H	244	41.0	16.6
ANTENNA POLARITY & TEST DISTANCE: VERTICAL AT 3 M								
NO.	FREQ. (MHz)	EMISSION LEVEL (dBuV/m)	LIMIT (dBuV/m)	MARGIN (dB)	ANTENNA HEIGHT (m)	TABLE ANGLE (Degree)	RAW VALUE (dBuV)	CORRECTION FACTOR (dB/m)
1	5150.00	56.3 PK	74.0	-17.7	2.54 V	108	52.4	3.9
2	5150.00	42.8 AV	54.0	-11.2	2.54 V	108	38.9	3.9
3	*5210.00	91.0 PK			2.57 V	105	52.9	38.1
4	*5210.00	80.9 AV			2.57 V	105	42.8	38.1
5	5350.00	54.4 PK	74.0	-19.6	2.57 V	104	50.6	3.8
6	5350.00	41.5 AV	54.0	-12.5	2.57 V	104	37.7	3.8
7	#10420.00	57.5 PK	68.2	-10.7	3.12 V	324	40.9	16.6

Remarks:

1. Emission Level(dBuV/m) = Raw Value(dBuV) + Correction Factor(dB/m)
2. Correction Factor(dB/m) = Antenna Factor(dB/m) + Cable Factor(dB) – Pre-Amplifier Factor(dB)
3. The other emission levels were very low against the limit.
4. Margin value = Emission Level – Limit value
5. " * ": Fundamental frequency.
6. " # ": The radiated frequency is out of the restricted band.

CHANNEL	TX Channel 58	DETECTOR FUNCTION	Peak (PK)
FREQUENCY RANGE	1GHz ~ 40GHz		Average (AV)

ANTENNA POLARITY & TEST DISTANCE: HORIZONTAL AT 3 M								
NO.	FREQ. (MHz)	EMISSION LEVEL (dBuV/m)	LIMIT (dBuV/m)	MARGIN (dB)	ANTENNA HEIGHT (m)	TABLE ANGLE (Degree)	RAW VALUE (dBuV)	CORRECTION FACTOR (dB/m)
1	5150.00	53.8 PK	74.0	-20.2	2.61 H	5	49.9	3.9
2	5150.00	41.4 AV	54.0	-12.6	2.61 H	5	37.5	3.9
3	*5290.00	89.0 PK			2.66 H	4	50.9	38.1
4	*5290.00	78.6 AV			2.66 H	4	40.5	38.1
5	5350.00	54.0 PK	74.0	-20.0	2.57 H	2	50.2	3.8
6	5350.00	41.6 AV	54.0	-12.4	2.57 H	2	37.8	3.8
7	#10580.00	57.7 PK	68.2	-10.5	3.39 H	250	40.9	16.8
ANTENNA POLARITY & TEST DISTANCE: VERTICAL AT 3 M								
NO.	FREQ. (MHz)	EMISSION LEVEL (dBuV/m)	LIMIT (dBuV/m)	MARGIN (dB)	ANTENNA HEIGHT (m)	TABLE ANGLE (Degree)	RAW VALUE (dBuV)	CORRECTION FACTOR (dB/m)
1	5150.00	53.8 PK	74.0	-20.2	2.53 V	111	49.9	3.9
2	5150.00	41.4 AV	54.0	-12.6	2.53 V	111	37.5	3.9
3	*5290.00	90.5 PK			2.54 V	114	52.4	38.1
4	*5290.00	79.9 AV			2.54 V	114	41.8	38.1
5	5350.00	54.7 PK	74.0	-19.3	2.54 V	114	50.9	3.8
6	5350.00	42.4 AV	54.0	-11.6	2.54 V	114	38.6	3.8
7	#10580.00	58.0 PK	68.2	-10.2	3.21 V	329	41.2	16.8

Remarks:

1. Emission Level(dBuV/m) = Raw Value(dBuV) + Correction Factor(dB/m)
2. Correction Factor(dB/m) = Antenna Factor(dB/m) + Cable Factor(dB) – Pre-Amplifier Factor(dB)
3. The other emission levels were very low against the limit.
4. Margin value = Emission Level – Limit value
5. " * ": Fundamental frequency.
6. " # ": The radiated frequency is out of the restricted band.

CHANNEL	TX Channel 106	DETECTOR FUNCTION	Peak (PK)
FREQUENCY RANGE	1GHz ~ 40GHz		Average (AV)

ANTENNA POLARITY & TEST DISTANCE: HORIZONTAL AT 3 M								
NO.	FREQ. (MHz)	EMISSION LEVEL (dBuV/m)	LIMIT (dBuV/m)	MARGIN (dB)	ANTENNA HEIGHT (m)	TABLE ANGLE (Degree)	RAW VALUE (dBuV)	CORRECTION FACTOR (dB/m)
1	5460.00	54.7 PK	74.0	-19.3	2.61 H	4	50.5	4.2
2	5460.00	41.8 AV	54.0	-12.2	2.61 H	4	37.6	4.2
3	#5470.00	55.1 PK	68.2	-13.1	2.65 H	1	50.8	4.3
4	*5530.00	84.3 PK			2.74 H	4	45.7	38.6
5	*5530.00	74.9 AV			2.74 H	4	36.3	38.6
6	#5725.00	55.5 PK	68.2	-12.7	2.60 H	1	51.1	4.4
7	11060.00	58.5 PK	74.0	-15.5	3.46 H	254	40.7	17.8
8	11060.00	45.6 AV	54.0	-8.4	3.46 H	254	27.8	17.8
ANTENNA POLARITY & TEST DISTANCE: VERTICAL AT 3 M								
NO.	FREQ. (MHz)	EMISSION LEVEL (dBuV/m)	LIMIT (dBuV/m)	MARGIN (dB)	ANTENNA HEIGHT (m)	TABLE ANGLE (Degree)	RAW VALUE (dBuV)	CORRECTION FACTOR (dB/m)
1	5460.00	54.7 PK	74.0	-19.3	2.49 V	118	50.5	4.2
2	5460.00	41.6 AV	54.0	-12.4	2.49 V	118	37.4	4.2
3	#5470.00	55.7 PK	68.2	-12.5	2.50 V	116	51.4	4.3
4	*5530.00	85.8 PK			2.01 V	117	47.2	38.6
5	*5530.00	76.2 AV			2.01 V	117	37.6	38.6
6	#5725.00	54.3 PK	68.2	-13.9	2.50 V	116	49.9	4.4
7	11060.00	59.0 PK	74.0	-15.0	3.09 V	335	41.2	17.8
8	11060.00	45.4 AV	54.0	-8.6	3.09 V	335	27.6	17.8

Remarks:

1. Emission Level(dBuV/m) = Raw Value(dBuV) + Correction Factor(dB/m)
2. Correction Factor(dB/m) = Antenna Factor(dB/m) + Cable Factor(dB) – Pre-Amplifier Factor(dB)
3. The other emission levels were very low against the limit.
4. Margin value = Emission Level – Limit value
5. " * ": Fundamental frequency.
6. " # ": The radiated frequency is out of the restricted band.

CHANNEL	TX Channel 122	DETECTOR FUNCTION	Peak (PK)
FREQUENCY RANGE	1GHz ~ 40GHz		Average (AV)

ANTENNA POLARITY & TEST DISTANCE: HORIZONTAL AT 3 M								
NO.	FREQ. (MHz)	EMISSION LEVEL (dBuV/m)	LIMIT (dBuV/m)	MARGIN (dB)	ANTENNA HEIGHT (m)	TABLE ANGLE (Degree)	RAW VALUE (dBuV)	CORRECTION FACTOR (dB/m)
1	5460.00	53.7 PK	74.0	-20.3	2.62 H	4	49.5	4.2
2	5460.00	42.0 AV	54.0	-12.0	2.62 H	4	37.8	4.2
3	#5470.00	54.8 PK	68.2	-13.4	2.76 H	7	50.5	4.3
4	*5610.00	85.2 PK			2.63 H	3	46.5	38.7
5	*5610.00	75.1 AV			2.63 H	3	36.4	38.7
6	#5725.00	55.6 PK	68.2	-12.6	2.57 H	6	51.2	4.4
7	11220.00	58.3 PK	74.0	-15.7	3.43 H	243	41.2	17.1
8	11220.00	44.9 AV	54.0	-9.1	3.43 H	243	27.8	17.1
ANTENNA POLARITY & TEST DISTANCE: VERTICAL AT 3 M								
NO.	FREQ. (MHz)	EMISSION LEVEL (dBuV/m)	LIMIT (dBuV/m)	MARGIN (dB)	ANTENNA HEIGHT (m)	TABLE ANGLE (Degree)	RAW VALUE (dBuV)	CORRECTION FACTOR (dB/m)
1	5460.00	54.3 PK	74.0	-19.7	2.48 V	116	50.1	4.2
2	5460.00	42.0 AV	54.0	-12.0	2.48 V	116	37.8	4.2
3	#5470.00	55.0 PK	68.2	-13.2	2.44 V	114	50.7	4.3
4	*5610.00	86.7 PK			2.45 V	115	48.0	38.7
5	*5610.00	76.4 AV			2.45 V	115	37.7	38.7
6	#5725.00	54.4 PK	68.2	-13.8	2.48 V	116	50.0	4.4
7	11220.00	58.6 PK	74.0	-15.4	3.09 V	331	41.5	17.1
8	11220.00	44.5 AV	54.0	-9.5	3.09 V	331	27.4	17.1

Remarks:

1. Emission Level(dBuV/m) = Raw Value(dBuV) + Correction Factor(dB/m)
2. Correction Factor(dB/m) = Antenna Factor(dB/m) + Cable Factor(dB) – Pre-Amplifier Factor(dB)
3. The other emission levels were very low against the limit.
4. Margin value = Emission Level – Limit value
5. " * ": Fundamental frequency.
6. " # ": The radiated frequency is out of the restricted band.

CHANNEL	TX Channel 155	DETECTOR FUNCTION	Peak (PK)
FREQUENCY RANGE	1GHz ~ 40GHz		Average (AV)

ANTENNA POLARITY & TEST DISTANCE: HORIZONTAL AT 3 M								
NO.	FREQ. (MHz)	EMISSION LEVEL (dBuV/m)	LIMIT (dBuV/m)	MARGIN (dB)	ANTENNA HEIGHT (m)	TABLE ANGLE (Degree)	RAW VALUE (dBuV)	CORRECTION FACTOR (dB/m)
1	#5608.00	55.3 PK	68.2	-12.9	3.99 H	354	51.1	4.2
2	*5775.00	86.1 PK			3.99 H	354	47.1	39.0
3	*5775.00	75.2 AV			3.99 H	354	36.2	39.0
4	#5943.20	56.3 PK	68.2	-11.9	3.99 H	354	51.3	5.0
5	11550.00	57.6 PK	74.0	-16.4	3.49 H	258	40.9	16.7
6	11550.00	44.4 AV	54.0	-9.6	3.49 H	258	27.7	16.7
ANTENNA POLARITY & TEST DISTANCE: VERTICAL AT 3 M								
NO.	FREQ. (MHz)	EMISSION LEVEL (dBuV/m)	LIMIT (dBuV/m)	MARGIN (dB)	ANTENNA HEIGHT (m)	TABLE ANGLE (Degree)	RAW VALUE (dBuV)	CORRECTION FACTOR (dB/m)
1	#5632.00	55.5 PK	68.2	-12.7	2.57 V	75	51.2	4.3
2	*5775.00	88.1 PK			2.57 V	75	49.1	39.0
3	*5775.00	77.1 AV			2.57 V	75	38.1	39.0
4	#5993.60	56.3 PK	68.2	-11.9	2.57 V	75	51.3	5.0
5	11550.00	57.9 PK	74.0	-16.1	3.17 V	334	41.2	16.7
6	11550.00	44.2 AV	54.0	-9.8	3.17 V	334	27.5	16.7

Remarks:

1. Emission Level(dBuV/m) = Raw Value(dBuV) + Correction Factor(dB/m)
2. Correction Factor(dB/m) = Antenna Factor(dB/m) + Cable Factor(dB) – Pre-Amplifier Factor(dB)
3. The other emission levels were very low against the limit.
4. Margin value = Emission Level – Limit value
5. " * ": Fundamental frequency.
6. " # ": The radiated frequency is out of the restricted band.

Below 1GHz worst-case data:

802.11a

CHANNEL	TX Channel 36	DETECTOR FUNCTION	Quasi-Peak (QP)
FREQUENCY RANGE	9kHz ~ 1GHz	TEST MODE	A

ANTENNA POLARITY & TEST DISTANCE: HORIZONTAL AT 3 M								
NO.	FREQ. (MHz)	EMISSION LEVEL (dBuV/m)	LIMIT (dBuV/m)	MARGIN (dB)	ANTENNA HEIGHT (m)	TABLE ANGLE (Degree)	RAW VALUE (dBuV)	CORRECTION FACTOR (dB/m)
1	58.13	26.2 QP	40.0	-13.8	1.00 H	320	36.3	-10.1
2	70.74	28.3 QP	40.0	-11.7	1.00 H	79	39.9	-11.6
3	89.17	29.5 QP	43.5	-14.0	1.00 H	156	44.4	-14.9
4	199.75	27.9 QP	43.5	-15.6	1.00 H	264	40.0	-12.1
5	320.03	34.6 QP	46.0	-11.4	1.00 H	228	42.1	-7.5
6	480.08	30.0 QP	46.0	-16.0	1.00 H	230	34.1	-4.1

Remarks:

1. Emission Level(dBuV/m) = Raw Value(dBuV) + Correction Factor(dB/m)
2. Correction Factor(dB/m) = Antenna Factor(dB/m) + Cable Factor(dB) – Pre-Amplifier Factor(dB)
3. The other emission levels were very low against the limit of frequency range 30MHz~1000MHz.
4. Margin value = Emission Level – Limit value
5. The emission levels were very low against the limit of frequency range 9kHz~30MHz: the amplitude of spurious emissions attenuated more than 20dB below the permissible value to be report.

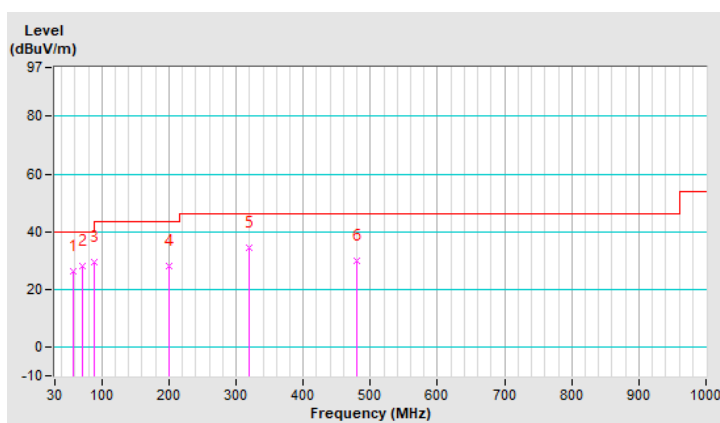

CHANNEL	TX Channel 36	DETECTOR FUNCTION	Quasi-Peak (QP)
FREQUENCY RANGE	9kHz ~ 1GHz	TEST MODE	A

ANTENNA POLARITY & TEST DISTANCE: VERTICAL AT 3 M								
NO.	FREQ. (MHz)	EMISSION LEVEL (dBuV/m)	LIMIT (dBuV/m)	MARGIN (dB)	ANTENNA HEIGHT (m)	TABLE ANGLE (Degree)	RAW VALUE (dBuV)	CORRECTION FACTOR (dB/m)
1	30.00	35.4 QP	40.0	-4.6	1.00 V	215	46.7	-11.3
2	45.52	36.1 QP	40.0	-3.9	1.00 V	229	46.0	-9.9
3	80.44	29.1 QP	40.0	-10.9	1.00 V	304	43.0	-13.9
4	134.76	28.6 QP	43.5	-14.9	1.00 V	196	38.9	-10.3
5	165.80	26.2 QP	43.5	-17.3	1.00 V	82	35.4	-9.2
6	320.03	28.3 QP	46.0	-17.7	1.00 V	239	35.8	-7.5

Remarks:

1. Emission Level(dBuV/m) = Raw Value(dBuV) + Correction Factor(dB/m)
2. Correction Factor(dB/m) = Antenna Factor(dB/m) + Cable Factor(dB) – Pre-Amplifier Factor(dB)
3. The other emission levels were very low against the limit of frequency range 30MHz~1000MHz.
4. Margin value = Emission Level – Limit value
5. The emission levels were very low against the limit of frequency range 9kHz~30MHz: the amplitude of spurious emissions attenuated more than 20dB below the permissible value to be report.

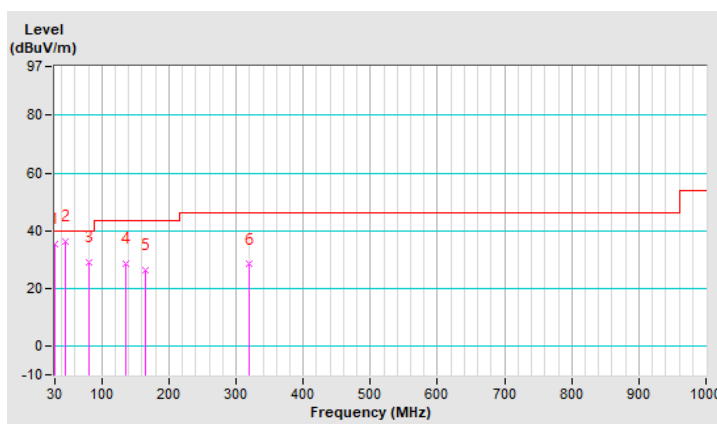

CHANNEL	TX Channel 36	DETECTOR FUNCTION	Quasi-Peak (QP)
FREQUENCY RANGE	9kHz ~ 1GHz	TEST MODE	B

ANTENNA POLARITY & TEST DISTANCE: HORIZONTAL AT 3 M								
NO.	FREQ. (MHz)	EMISSION LEVEL (dBuV/m)	LIMIT (dBuV/m)	MARGIN (dB)	ANTENNA HEIGHT (m)	TABLE ANGLE (Degree)	RAW VALUE (dBuV)	CORRECTION FACTOR (dB/m)
1	141.55	19.1 QP	43.5	-24.4	1.00 H	15	28.8	-9.7
2	295.78	23.6 QP	46.0	-22.4	1.00 H	166	31.7	-8.1
3	452.92	24.3 QP	46.0	-21.7	1.00 H	108	28.6	-4.3
4	588.72	27.0 QP	46.0	-19.0	1.00 H	315	29.1	-2.1
5	773.99	30.4 QP	46.0	-15.6	1.00 H	19	29.1	1.3
6	806.00	31.1 QP	46.0	-14.9	1.00 H	15	29.4	1.7

Remarks:

1. Emission Level(dBuV/m) = Raw Value(dBuV) + Correction Factor(dB/m)
2. Correction Factor(dB/m) = Antenna Factor(dB/m) + Cable Factor(dB) – Pre-Amplifier Factor(dB)
3. The other emission levels were very low against the limit of frequency range 30MHz~1000MHz.
4. Margin value = Emission Level – Limit value
5. The emission levels were very low against the limit of frequency range 9kHz~30MHz: the amplitude of spurious emissions attenuated more than 20dB below the permissible value to be report.

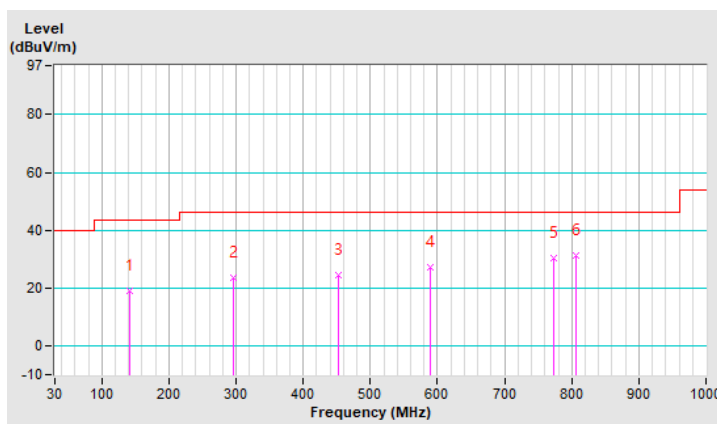

CHANNEL	TX Channel 36	DETECTOR FUNCTION	Quasi-Peak (QP)
FREQUENCY RANGE	9kHz ~ 1GHz	TEST MODE	B

ANTENNA POLARITY & TEST DISTANCE: VERTICAL AT 3 M								
NO.	FREQ. (MHz)	EMISSION LEVEL (dBuV/m)	LIMIT (dBuV/m)	MARGIN (dB)	ANTENNA HEIGHT (m)	TABLE ANGLE (Degree)	RAW VALUE (dBuV)	CORRECTION FACTOR (dB/m)
1	81.41	19.7 QP	40.0	-20.3	1.00 V	76	33.9	-14.2
2	223.03	18.0 QP	46.0	-28.0	1.00 V	219	30.0	-12.0
3	311.30	22.4 QP	46.0	-23.6	1.00 V	6	30.1	-7.7
4	425.76	24.2 QP	46.0	-21.8	1.00 V	172	29.3	-5.1
5	563.50	27.7 QP	46.0	-18.3	1.00 V	189	30.4	-2.7
6	623.64	27.4 QP	46.0	-18.6	1.00 V	217	29.0	-1.6

Remarks:

1. Emission Level(dBuV/m) = Raw Value(dBuV) + Correction Factor(dB/m)
2. Correction Factor(dB/m) = Antenna Factor(dB/m) + Cable Factor(dB) – Pre-Amplifier Factor(dB)
3. The other emission levels were very low against the limit of frequency range 30MHz~1000MHz.
4. Margin value = Emission Level – Limit value
5. The emission levels were very low against the limit of frequency range 9kHz~30MHz: the amplitude of spurious emissions attenuated more than 20dB below the permissible value to be report.

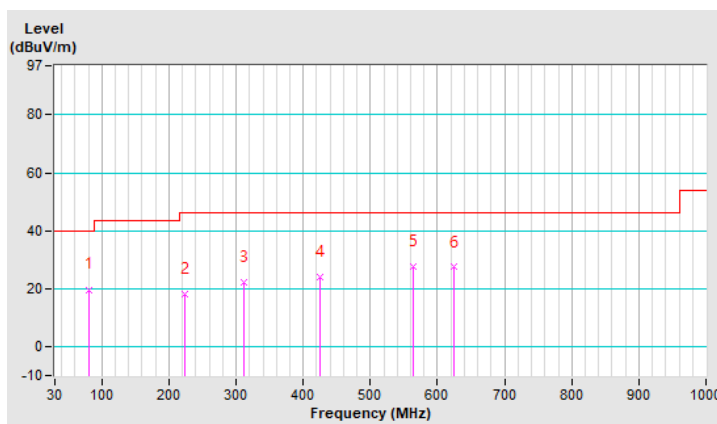

4.2 Transmit Power Measurement

4.2.1 Limits of Transmit Power Measurement

Operation Band	EUT Category		LIMIT
U-NII-1	√	Outdoor Access Point	1 Watt (30 dBm) (Max. e.i.r.p ≤ 125mW(21 dBm) at any elevation angle above 30 degrees as measured from the horizon)
		Fixed point-to-point Access Point	1 Watt (30 dBm)
		Indoor Access Point	1 Watt (30 dBm)
	√	Mobile and Portable client device	250mW (24 dBm)
U-NII-2A		√	250mW (24 dBm) or 11 dBm+10 log B*
U-NII-2C		√	250mW (24 dBm) or 11 dBm+10 log B*
U-NII-3		√	1 Watt (30 dBm)

*B is the 26 dB emission bandwidth in megahertz

Per KDB 662911 Method of conducted output power measurement on IEEE 802.11 devices,

Array Gain = 0 dB (i.e., no array gain) for $N_{ANT} \leq 4$;

Array Gain = 0 dB (i.e., no array gain) for channel widths ≥ 40 MHz for any N_{ANT} ;

Array Gain = $5 \log(N_{ANT}/N_{SS})$ dB or 3 dB, whichever is less for 20-MHz channel widths with $N_{ANT} \geq 5$.

For power measurements on all other devices: Array Gain = $10 \log(N_{ANT}/N_{SS})$ dB.

4.2.2 Test Setup

For Power Output

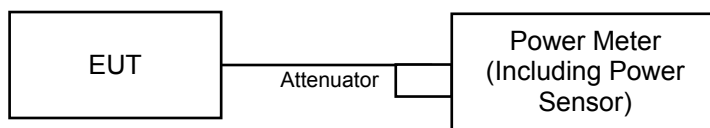

For Bandwidth

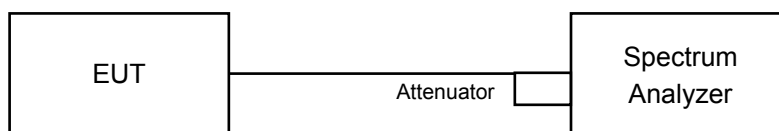

4.2.3 Test Instruments

Refer to section 4.1.2 to get information of above instrument.

4.2.4 Test Procedure

For Average Power Measurement

Method PM is used to perform output power measurement, trigger and gating function of wide band power meter is enabled to measure max output power of TX on burst. Duty factor is not added to measured value.

For 26dB Bandwidth

- a. Set RBW = approximately 1% of the emission bandwidth.
- b. Set the VBW > RBW.
- c. Detector = Peak.
- d. Trace mode = max hold.
- e. Measure the maximum width of the emission that is 26 dB down from the peak of the emission. Compare this with the RBW setting of the analyzer. Readjust RBW and repeat measurement as needed until the RBW/EBW ratio is approximately 1%.

4.2.5 Deviation from Test Standard

No deviation.

4.2.6 EUT Operating Conditions

The software provided by client to enable the EUT under transmission condition continuously at lowest, middle and highest channel frequencies individually.

4.2.7 Test Result

Power Output:

For U-NII-1 (Outdoor Access Point Mode):

802.11a

Chan.	Freq. (MHz)	Conducted Power (dBm)		Total Power (mW)	Total Power (dBm)	Power Limit (dBm)	Gain (dBi)	EIRP (dBm)	EIRP limit (dBm)	Pass / Fail
		Chain 0	Chain 1							
36	5180	3.43	1.56	3.635	5.61	30.00	1.61	7.22	21.00	Pass
40	5200	3.26	1.34	3.479	5.41	30.00	1.61	7.02	21.00	Pass
48	5240	3.27	1.35	3.488	5.43	30.00	1.61	7.04	21.00	Pass

Note: Max. Gain = 1.61dBi < 6dBi, so the power limit no need to be reduce.

802.11n (HT20)

Chan.	Freq. (MHz)	Conducted Power (dBm)		Total Power (mW)	Total Power (dBm)	Power Limit (dBm)	Gain (dBi)	EIRP (dBm)	EIRP limit (dBm)	Pass / Fail
		Chain 0	Chain 1							
36	5180	2.96	0.82	3.185	5.03	30.00	1.61	6.64	21.00	Pass
40	5200	2.87	0.73	3.119	4.94	30.00	1.61	6.55	21.00	Pass
48	5240	2.77	0.64	3.051	4.84	30.00	1.61	6.45	21.00	Pass

Note: Max. Gain = 1.61dBi < 6dBi, so the power limit no need to be reduce.

802.11n (HT40)

Chan.	Freq. (MHz)	Conducted Power (dBm)		Total Power (mW)	Total Power (dBm)	Power Limit (dBm)	Gain (dBi)	EIRP (dBm)	EIRP limit (dBm)	Pass / Fail
		Chain 0	Chain 1							
38	5190	3.12	0.63	3.207	5.06	30.00	1.61	6.67	21.00	Pass
46	5230	3.11	0.54	3.178	5.02	30.00	1.61	6.63	21.00	Pass

Note: Max. Gain = 1.61dBi < 6dBi, so the power limit no need to be reduce.

802.11ac (VHT80)

Chan.	Freq. (MHz)	Conducted Power (dBm)		Total Power (mW)	Total Power (dBm)	Power Limit (dBm)	Gain (dBi)	EIRP (dBm)	EIRP limit (dBm)	Pass / Fail
		Chain 0	Chain 1							
42	5210	1.86	-0.17	2.496	3.97	30.00	1.61	5.58	21.00	Pass

Note: Max. Gain = 1.61dBi < 6dBi, so the power limit no need to be reduce.

For U-NII-1 (Mobile and Portable client device Mode):

802.11a

Chan.	Freq. (MHz)	Maximum Conducted Power (dBm)		Total Power (mW)	Total Power (dBm)	Power Limit (dBm)	Pass / Fail
		Chain 0	Chain 1				
36	5180	3.43	1.56	3.635	5.61	24.00	Pass
40	5200	3.26	1.34	3.479	5.41	24.00	Pass
48	5240	3.27	1.35	3.488	5.43	24.00	Pass

Note: Max. Gain = 1.61dBi < 6dBi, so the power limit no need to be reduce.

802.11n (HT20)

Chan.	Freq. (MHz)	Maximum Conducted Power (dBm)		Total Power (mW)	Total Power (dBm)	Power Limit (dBm)	Pass / Fail
		Chain 0	Chain 1				
36	5180	2.96	0.82	3.185	5.03	24.00	Pass
40	5200	2.87	0.73	3.119	4.94	24.00	Pass
48	5240	2.77	0.64	3.051	4.84	24.00	Pass

Note: Max. Gain = 1.61dBi < 6dBi, so the power limit no need to be reduce.

802.11n (HT40)

Chan.	Freq. (MHz)	Maximum Conducted Power (dBm)		Total Power (mW)	Total Power (dBm)	Power Limit (dBm)	Pass / Fail
		Chain 0	Chain 1				
38	5190	3.12	0.63	3.207	5.06	24.00	Pass
46	5230	3.11	0.54	3.178	5.02	24.00	Pass

Note: Max. Gain = 1.61dBi < 6dBi, so the power limit no need to be reduce.

802.11ac (VHT80)

Chan.	Freq. (MHz)	Maximum Conducted Power (dBm)		Total Power (mW)	Total Power (dBm)	Power Limit (dBm)	Pass / Fail
		Chain 0	Chain 1				
42	5210	1.86	-0.17	2.496	3.97	24.00	Pass

Note: Max. Gain = 1.61dBi < 6dBi, so the power limit no need to be reduce.

For U-NII-2A, U-NII-2C, U-NII-3:

802.11a

Chan.	Freq. (MHz)	Maximum Conducted Power (dBm)		Total Power (mW)	Total Power (dBm)	Power Limit (dBm)	Pass / Fail
		Chain 0	Chain 1				
52	5260	3.37	1.41	3.557	5.51	23.94	Pass
60	5300	3.13	1.19	3.371	5.28	23.94	Pass
64	5320	2.74	1.06	3.155	4.99	23.93	Pass
100	5500	2.62	0.89	3.055	4.85	23.94	Pass
116	5580	1.63	0.07	2.471	3.93	23.89	Pass
140	5700	-0.03	-0.77	1.831	2.63	23.94	Pass
149	5745	0.07	-0.18	1.976	2.96	30.00	Pass
157	5785	-0.79	-0.93	1.641	2.15	30.00	Pass
165	5825	-0.85	-1.26	1.570	1.96	30.00	Pass

Note: Max. Gain = 1.61dBi < 6dBi, so the limit no need to be reduced.

For 5260~5320MHz, 5500~5700MHz

Chain 0

1. $11\text{dBm} + 10\log(20.20) = 24.05 > 24\text{dBm}$
2. $11\text{dBm} + 10\log(20.13) = 24.03 > 24\text{dBm}$
3. $11\text{dBm} + 10\log(20.44) = 24.10 > 24\text{dBm}$
4. $11\text{dBm} + 10\log(19.92) = 23.99 < 24\text{dBm}$
5. $11\text{dBm} + 10\log(19.76) = 23.95 < 24\text{dBm}$
6. $11\text{dBm} + 10\log(20.27) = 24.06 > 24\text{dBm}$

Chain 1

1. $11\text{dBm} + 10\log(19.71) = 23.94 < 24\text{dBm}$
2. $11\text{dBm} + 10\log(19.71) = 23.94 < 24\text{dBm}$
3. $11\text{dBm} + 10\log(19.65) = 23.93 < 24\text{dBm}$
4. $11\text{dBm} + 10\log(19.72) = 23.94 < 24\text{dBm}$
5. $11\text{dBm} + 10\log(19.46) = 23.89 < 24\text{dBm}$
6. $11\text{dBm} + 10\log(19.69) = 23.94 < 24\text{dBm}$

802.11n (HT20)

Chan.	Freq. (MHz)	Maximum Conducted Power (dBm)		Total Power (mW)	Total Power (dBm)	Power Limit (dBm)	Pass / Fail
		Chain 0	Chain 1				
52	5260	2.63	0.76	3.023	4.80	24.00	Pass
60	5300	2.61	0.78	3.021	4.80	24.00	Pass
64	5320	2.53	0.67	2.958	4.71	24.00	Pass
100	5500	0.93	0.17	2.279	3.58	24.00	Pass
116	5580	0.61	-0.61	2.020	3.05	24.00	Pass
140	5700	-0.52	-0.76	1.727	2.37	24.00	Pass
149	5745	-0.81	-1.04	1.617	2.09	30.00	Pass
157	5785	-1.18	-1.53	1.465	1.66	30.00	Pass
165	5825	-1.95	-0.46	1.538	1.87	30.00	Pass

Note: Max. Gain = 1.61dBi < 6dBi, so the limit no need to be reduced.

For 5260~5320MHz, 5500~5700MHz

Chain 0

1. 11dBm + 10log (21.49) = 24.32 > 24dBm
2. 11dBm + 10log (21.32) = 24.28 > 24dBm
3. 11dBm + 10log (21.40) = 24.30 > 24dBm
4. 11dBm + 10log (21.18) = 24.25 > 24dBm
5. 11dBm + 10log (21.17) = 24.25 > 24dBm
6. 11dBm + 10log (21.23) = 24.26 > 24dBm

Chain 1

1. 11dBm + 10log (20.94) = 24.20 > 24dBm
2. 11dBm + 10log (20.85) = 24.19 > 24dBm
3. 11dBm + 10log (21.09) = 24.24 > 24dBm
4. 11dBm + 10log (20.58) = 24.13 > 24dBm
5. 11dBm + 10log (20.87) = 24.19 > 24dBm
6. 11dBm + 10log (21.02) = 24.22 > 24dBm

802.11n (HT40)

Chan.	Freq. (MHz)	Maximum Conducted Power (dBm)		Total Power (mW)	Total Power (dBm)	Power Limit (dBm)	Pass / Fail
		Chain 0	Chain 1				
54	5270	3.06	0.33	3.102	4.92	24.00	Pass
62	5310	2.57	0.30	2.879	4.59	24.00	Pass
102	5510	1.19	0.13	2.345	3.70	24.00	Pass
110	5550	1.05	-0.05	2.262	3.55	24.00	Pass
134	5670	-0.55	-0.79	1.715	2.34	24.00	Pass
151	5755	-1.32	-1.18	1.500	1.76	30.00	Pass
159	5795	-0.16	-0.69	1.817	2.59	30.00	Pass

Note: Max. Gain = 1.61dBi < 6dBi, so the limit no need to be reduced.

For 5260~5320MHz, 5500~5700MHz

Chain 0

1. 11dBm + 10log (43.68) = 27.40 > 24dBm
2. 11dBm + 10log (44.61) = 27.49 > 24dBm
3. 11dBm + 10log (43.57) = 27.39 > 24dBm
4. 11dBm + 10log (43.99) = 27.43 > 24dBm
5. 11dBm + 10log (44.61) = 27.49 > 24dBm

Chain 1

1. 11dBm + 10log (42.95) = 27.32 > 24dBm
2. 11dBm + 10log (43.75) = 27.40 > 24dBm
3. 11dBm + 10log (42.60) = 27.29 > 24dBm
4. 11dBm + 10log (43.49) = 27.38 > 24dBm
5. 11dBm + 10log (42.53) = 27.28 > 24dBm

802.11ac (VHT80)

Chan.	Freq. (MHz)	Maximum Conducted Power (dBm)		Total Power (mW)	Total Power (dBm)	Power Limit (dBm)	Pass / Fail
		Chain 0	Chain 1				
58	5290	1.73	-0.62	2.356	3.72	24.00	Pass
106	5530	0.11	-1.42	1.747	2.42	24.00	Pass
122	5610	-1.26	-1.82	1.406	1.48	24.00	Pass
155	5775	-2.84	-0.25	1.464	1.66	30.00	Pass

Note: Max. Gain = 1.61dBi < 6dBi, so the limit no need to be reduced.

For 5260~5320MHz, 5500~5700MHz

Chain 0

1. 11dBm + 10log (81.80) = 30.12 > 24dBm
2. 11dBm + 10log (83.87) = 30.23 > 24dBm

Chain 1

1. 11dBm + 10log (82.90) = 30.18 > 24dBm
2. 11dBm + 10log (81.24) = 30.09 > 24dBm

26dB Bandwidth:

802.11a

Channel	Frequency (MHz)	26dBc Bandwidth (MHz)	
		Chain 0	Chain 1
36	5180	19.96	19.60
40	5200	20.02	19.77
48	5240	20.16	19.78
52	5260	20.20	19.71
60	5300	20.13	19.71
64	5320	20.44	19.65
100	5500	19.92	19.72
116	5580	19.76	19.46
140	5700	20.27	19.69

802.11n (HT20)

Channel	Frequency (MHz)	26dBc Bandwidth (MHz)	
		Chain 0	Chain 1
36	5180	21.49	20.62
40	5200	21.43	21.24
48	5240	21.45	20.61
52	5260	21.49	20.94
60	5300	21.32	20.85
64	5320	21.40	21.09
100	5500	21.18	20.58
116	5580	21.17	20.87
140	5700	21.23	21.02

802.11n (HT40)

Channel	Frequency (MHz)	26dBc Bandwidth (MHz)	
		Chain 0	Chain 1
38	5190	44.23	43.09
46	5230	43.66	43.70
54	5270	43.68	42.95
62	5310	44.61	43.75
102	5510	43.57	42.60
110	5550	43.99	43.49
134	5670	44.61	42.53

802.11ac (VHT80)

Channel	Frequency (MHz)	26dBc Bandwidth (MHz)	
		Chain 0	Chain 1
42	5210	82.12	81.26
58	5290	81.80	82.90
106	5530	83.87	81.24
122	5610	82.03	83.90

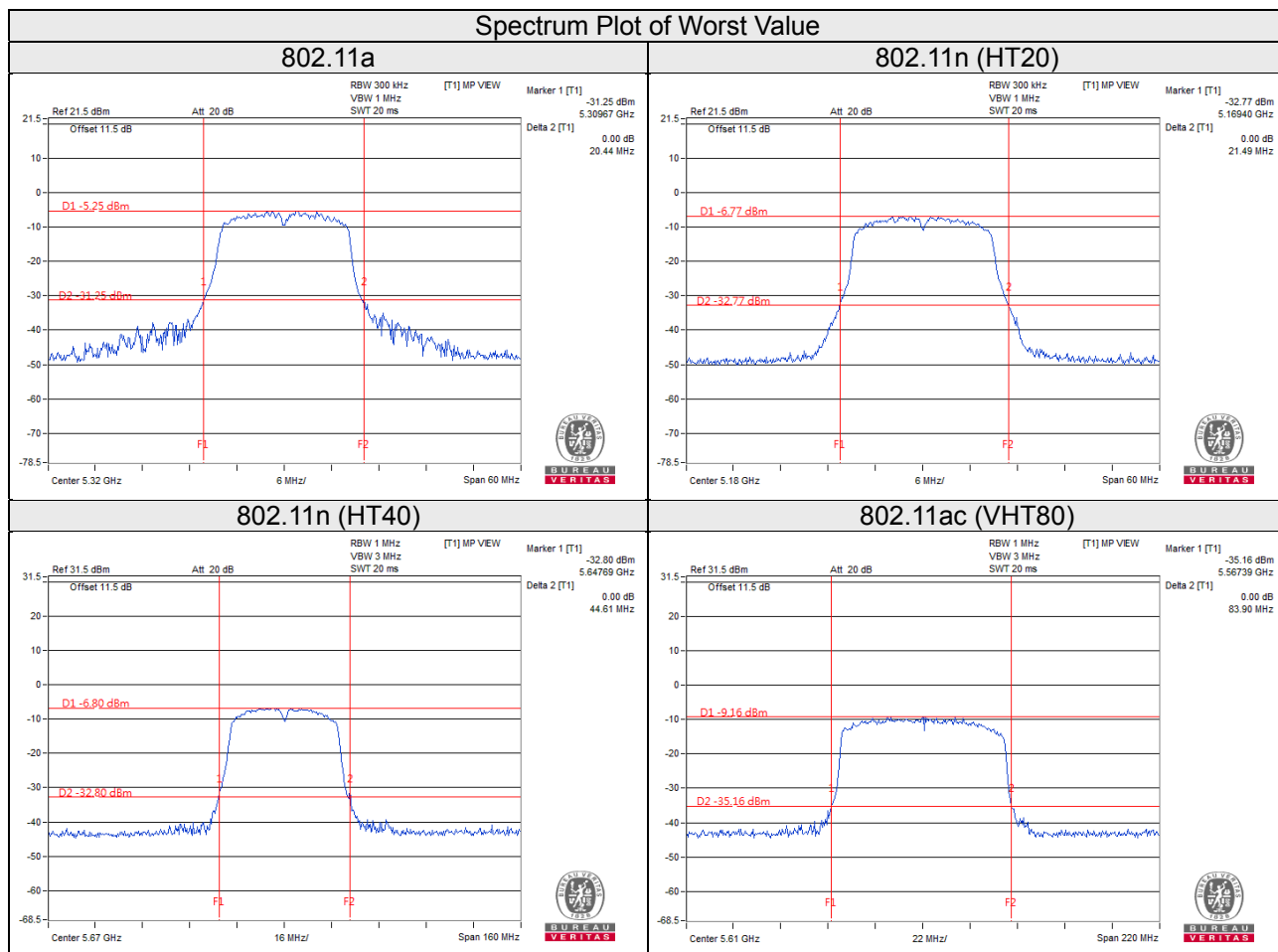

EUT Maximum Conducted Power

802.11a

Frequency Band (MHz)	Max. Power	
	Output Power (mW)	Output Power (dBm)
5250~5350	3.557	5.51
5470~5725	3.055	4.85

Note: The UUT can adjust a transmitter's output power based on the signal level present at the receiver. TPC is auto controlled by software.

802.11n (HT20)

Frequency Band (MHz)	Max. Power	
	Output Power (mW)	Output Power (dBm)
5250~5350	3.023	4.80
5470~5725	2.279	3.58

Note: The UUT can adjust a transmitter's output power based on the signal level present at the receiver. TPC is auto controlled by software.

802.11n (HT40)

Frequency Band (MHz)	Max. Power	
	Output Power (mW)	Output Power (dBm)
5250~5350	3.102	4.92
5470~5725	2.345	3.70

Note: The UUT can adjust a transmitter's output power based on the signal level present at the receiver. TPC is auto controlled by software.

802.11ac (VHT80)

Frequency Band (MHz)	Max. Power	
	Output Power (mW)	Output Power (dBm)
5250~5350	2.356	3.72
5470~5725	1.747	2.42

Note: The UUT can adjust a transmitter's output power based on the signal level present at the receiver. TPC is auto controlled by software.

4.3 Occupied Bandwidth Measurement

4.3.1 Test Setup

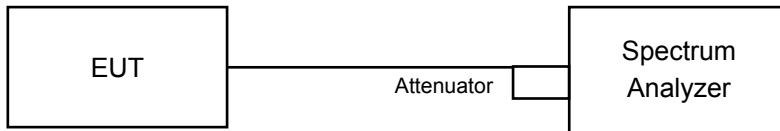

4.3.2 Test Instruments

Refer to section 4.1.2 to get information of above instrument.

4.3.3 Test Procedure

The transmitter output was connected to the spectrum analyzer through an attenuator. The bandwidth of the fundamental frequency was measured by spectrum analyzer with resolution bandwidth in the range of 1% to 5% of the anticipated emission bandwidth, and a video bandwidth at least 3x the resolution bandwidth and set the detector to sampling. The width of a frequency band such that, below the lower and above the upper frequency limits, the mean powers emitted are each equal to a specified percentage 0.5 %of the total mean power of a given emission.

4.3.4 Test Result

802.11a

Channel	Frequency (MHz)	Occupied Bandwidth (MHz)	
		Chain 0	Chain 1
36	5180	16.44	16.32
40	5200	16.44	16.32
48	5240	16.44	16.32
52	5260	16.44	16.32
60	5300	16.44	16.32
64	5320	16.44	16.32
100	5500	16.44	16.44
116	5580	16.44	16.44
140	5700	16.56	16.32
149	5745	16.44	16.44
157	5785	16.44	16.32
165	5825	16.32	16.32

802.11n (HT20)

Channel	Frequency (MHz)	Occupied Bandwidth (MHz)	
		Chain 0	Chain 1
36	5180	17.52	17.52
40	5200	17.52	17.52
48	5240	17.52	17.52
52	5260	17.52	17.52
60	5300	17.52	17.52
64	5320	17.52	17.52
100	5500	17.52	17.52
116	5580	17.52	17.52
140	5700	17.52	17.52
149	5745	17.52	17.52
157	5785	17.52	17.52
165	5825	17.52	17.52

802.11n (HT40)

Channel	Frequency (MHz)	Occupied Bandwidth (MHz)	
		Chain 0	Chain 1
38	5190	36.12	36.12
46	5230	36.24	36.12
54	5270	36.24	36.12
62	5310	36.24	36.12
102	5510	36.24	36.12
110	5550	36.24	36.12
134	5670	36.24	36.24
151	5755	36.24	36.12
159	5795	36.24	36.12

802.11ac (VHT80)

Channel	Frequency (MHz)	Occupied Bandwidth (MHz)	
		Chain 0	Chain 1
42	5210	75.12	75.12
58	5290	75.12	75.12
106	5530	75.36	75.12
122	5610	75.12	75.12
155	5775	75.36	75.12

Spectrum Plot of Worst Value

802.11a

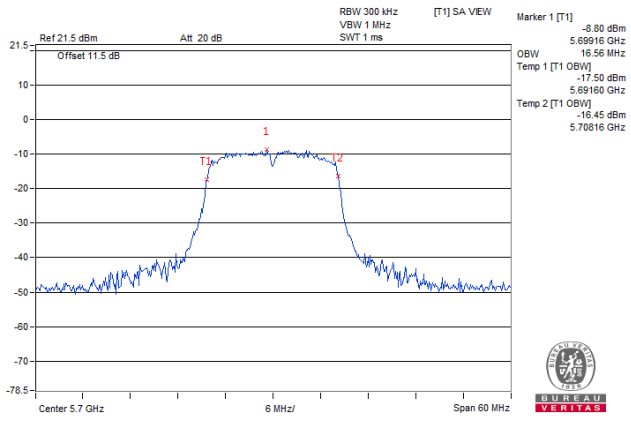

802.11n (HT20)

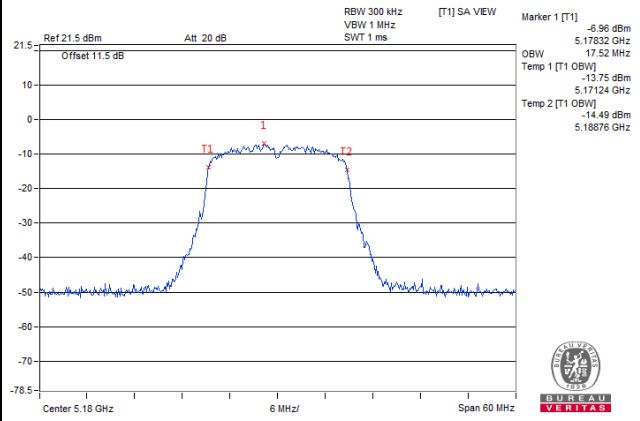

802.11n (HT40)

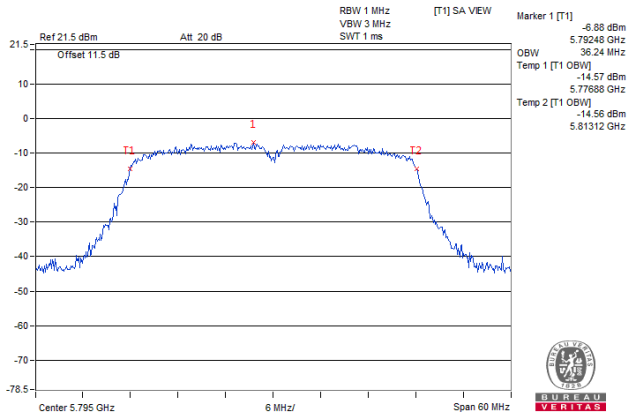

802.11ac (VHT80)

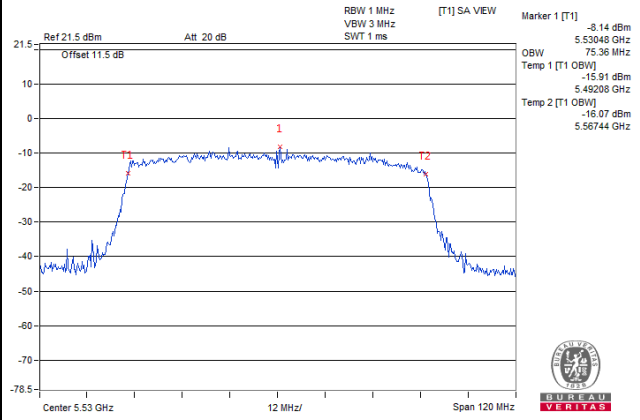

4.4 Peak Power Spectral Density Measurement

4.4.1 Limits of Peak Power Spectral Density Measurement

Operation Band	EUT Category		LIMIT
U-NII-1	√	Outdoor Access Point	17dBm/ MHz
		Fixed point-to-point Access Point	
		Indoor Access Point	
	√	Mobile and Portable client device	11dBm/ MHz
U-NII-2A	√		11dBm/ MHz
U-NII-2C	√		11dBm/ MHz
U-NII-3	√		30dBm/ 500kHz

4.4.2 Test Setup

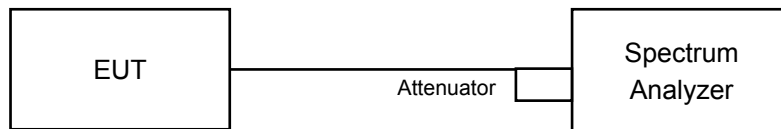

4.4.3 Test Instruments

Refer to section 4.1.2 to get information of above instrument.

4.4.4 Test Procedures

For U-NII-1, U-NII-2A, U-NII-2C band

Duty cycle of test signal is $\geq 98\%$

Using method SA-1

- 1) Set span to encompass the entire emission bandwidth (EBW) of the signal.
- 2) Set RBW = 1MHz, Set VBW ≥ 3 MHz, Detector = RMS.
- 3) Set Channel power measure = 1MHz.
- 4) Sweep time = auto, trigger set to "free run".
- 5) Trace average at least 100 traces in power averaging mode.
- 6) Record the max value.

Duty cycle of test signal is $< 98\%$

Using method SA-2

- 1) Set span to encompass the entire emission bandwidth (EBW) of the signal.
- 2) Set RBW = 1MHz, Set VBW ≥ 3 MHz, Detector = RMS.
- 3) Set Channel power measure = 1MHz.
- 4) Sweep time = auto, trigger set to "free run".
- 5) Trace average at least 100 traces in power averaging mode.
- 6) Record the max value and add $10 \log (1/\text{duty cycle})$.

For U-NII-3 band

Duty cycle $\geq 98\%$

- 1) Set span to encompass the entire emission bandwidth (EBW) of the signal.
- 2) Set RBW = 300 kHz, Set VBW ≥ 1 MHz, Detector = RMS.
- 3) Use the peak marker function to determine the maximum power level in any 300 kHz band segment within the fundamental EBW.
- 4) Scale the observed power level to an equivalent value in 500 kHz by adjusting (reducing) the measured power by a bandwidth correction factor (BWCF) where $BWCF = 10\log(500 \text{ kHz} / 300 \text{ kHz})$.
- 5) Sweep time = auto, trigger set to "free run".
- 6) Trace average at least 100 traces in power averaging mode.
- 7) Record the max value.

Duty cycle $< 98\%$

- 1) Set span to encompass the entire emission bandwidth (EBW) of the signal.
- 2) Set RBW = 300 kHz, Set VBW ≥ 1 MHz, Detector = RMS
- 3) Use the peak marker function to determine the maximum power level in any 300 kHz band segment within the fundamental EBW.
- 4) Scale the observed power level to an equivalent value in 500 kHz by adjusting (reducing) the measured power by a bandwidth correction factor (BWCF) where $BWCF = 10\log(500 \text{ kHz}/300\text{kHz})$
- 5) Sweep time = auto, trigger set to "free run".
- 6) Trace average at least 100 traces in power averaging mode.
- 7) Record the max value and add $10 \log (1/\text{duty cycle})$

4.4.5 Deviation from Test Standard

No deviation.

4.4.6 EUT Operating Conditions

Same as item 4.2.6.

4.4.7 Test Results

For U-NII-1 (Outdoor Access Point Mode):

802.11a

Chan.	Freq. (MHz)	PSD w/o Duty Factor (dBm/MHz)		Duty Factor (dB)	Total PSD with Duty Factor (dBm/MHz)	Max. Limit (dBm/MHz)	Pass / Fail
		Chain 0	Chain 1				
36	5180	-9.97	-13.16	0.38	-7.89	17.00	Pass
40	5200	-10.16	-13.01	0.38	-7.97	17.00	Pass
48	5240	-9.64	-12.73	0.38	-7.53	17.00	Pass

Note:

- Method E) 2) a) of power density measurement of KDB 662911 is using for calculating total power density. Total power density is summing entire spectra across corresponding frequency bins on the various outputs by computer.
- Directional gain = $10 \log[(10^{G1/20} + 10^{G2/20} + \dots + 10^{GN/20})^2/N_{ANT}] = 3.69\text{dBi} < 6\text{dBi}$, so the power density limit no need to reduce.
- Refer to section 3.3 for duty cycle spectrum plot.

802.11n (HT20)

Chan.	Freq. (MHz)	PSD w/o Duty Factor (dBm/MHz)		Duty Factor (dB)	Total PSD with Duty Factor (dBm/MHz)	Max. Limit (dBm/MHz)	Pass / Fail
		Chain 0	Chain 1				
36	5180	-11.49	-14.83	0.74	-9.10	17.00	Pass
40	5200	-11.43	-13.91	0.74	-8.75	17.00	Pass
48	5240	-10.97	-13.66	0.74	-8.36	17.00	Pass

Note:

- Method E) 2) a) of power density measurement of KDB 662911 is using for calculating total power density. Total power density is summing entire spectra across corresponding frequency bins on the various outputs by computer.
- Directional gain = $10 \log[(10^{G1/20} + 10^{G2/20} + \dots + 10^{GN/20})^2/N_{ANT}] = 3.69\text{dBi} < 6\text{dBi}$, so the power density limit no need to reduce.
- Refer to section 3.3 for duty cycle spectrum plot.

802.11n (HT40)

Chan.	Freq. (MHz)	PSD w/o Duty Factor (dBm/MHz)		Duty Factor (dB)	Total PSD with Duty Factor (dBm/MHz)	Max. Limit (dBm/MHz)	Pass / Fail
		Chain 0	Chain 1				
38	5190	-14.62	-18.62	1.26	-11.91	17.00	Pass
46	5230	-14.70	-17.55	1.26	-11.63	17.00	Pass

Note:

- Method E) 2) a) of power density measurement of KDB 662911 is using for calculating total power density. Total power density is summing entire spectra across corresponding frequency bins on the various outputs by computer.
- Directional gain = $10 \log[(10^{G1/20} + 10^{G2/20} + \dots + 10^{GN/20})^2/N_{ANT}] = 3.69\text{dBi} < 6\text{dBi}$, so the power density limit no need to reduce.
- Refer to section 3.3 for duty cycle spectrum plot.

802.11ac (VHT80)

Chan.	Freq. (MHz)	PSD w/o Duty Factor (dBm/MHz)		Duty Factor (dB)	Total PSD with Duty Factor (dBm/MHz)	Max. Limit (dBm/MHz)	Pass / Fail
		Chain 0	Chain 1				
42	5210	-20.03	-23.46	1.73	-16.67	17.00	Pass

Note:

- Method E) 2) a) of power density measurement of KDB 662911 is using for calculating total power density. Total power density is summing entire spectra across corresponding frequency bins on the various outputs by computer.
- Directional gain = $10 \log[(10^{G^1/20} + 10^{G^2/20} + \dots + 10^{G^N/20})^2/N_{ANT}] = 3.69\text{dBi} < 6\text{dBi}$, so the power density limit no need to reduce.
- Refer to section 3.3 for duty cycle spectrum plot.

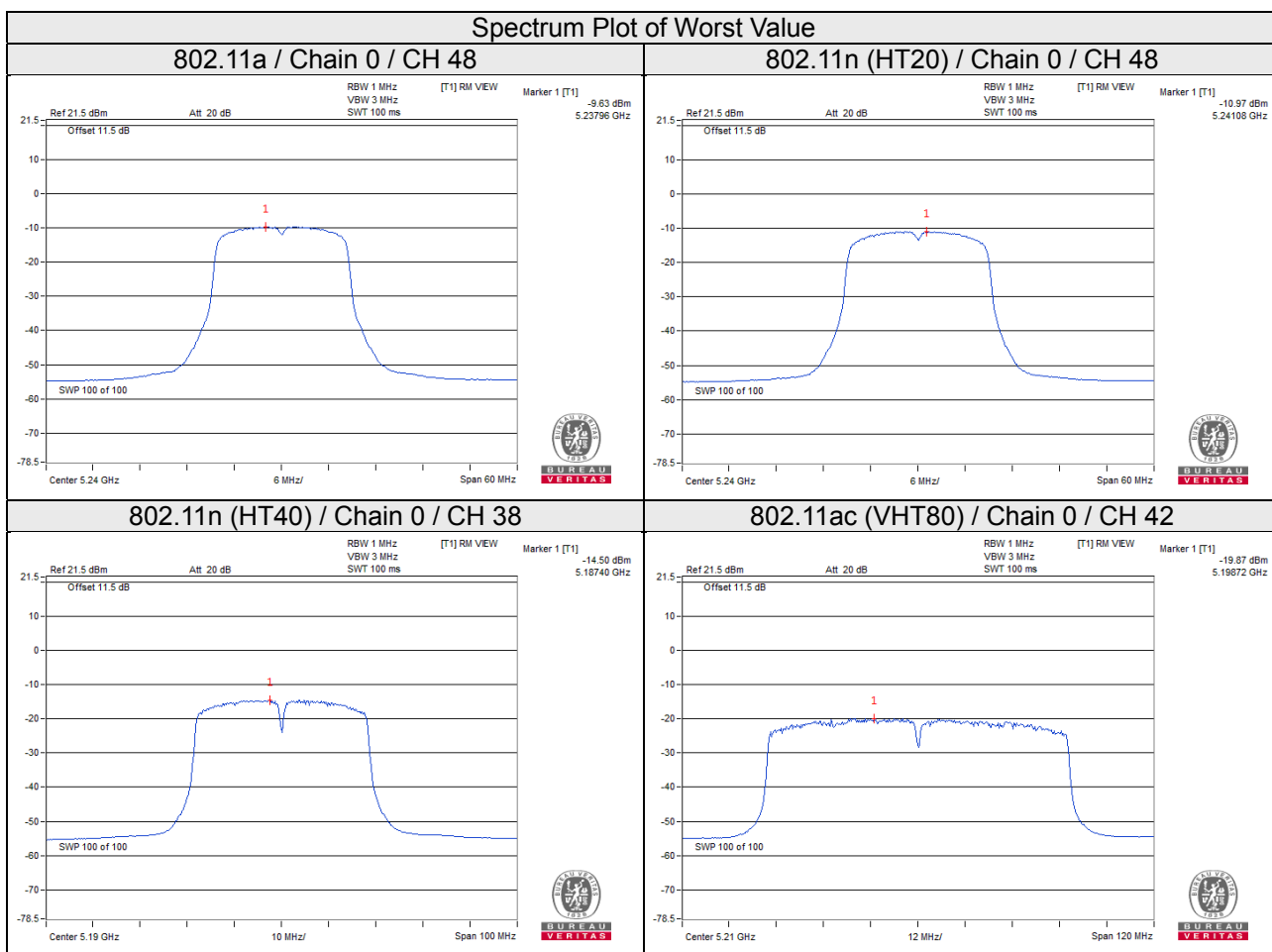

For U-NII-1 (Mobile and Portable client device Mode):

802.11a

Chan.	Freq. (MHz)	PSD W/O Duty Factor (dBm/MHz)		Duty Factor (dB)	Total PSD With Duty Factor (dBm/MHz)	Max. Limit (dBm/MHz)	Pass / Fail
		Chain 0	Chain 1				
36	5180	-9.97	-13.16	0.38	-7.89	11.00	Pass
40	5200	-10.16	-13.01	0.38	-7.97	11.00	Pass
48	5240	-9.64	-12.73	0.38	-7.53	11.00	Pass

Note:

- Method E) 2) a) of power density measurement of KDB 662911 is using for calculating total power density. Total power density is summing entire spectra across corresponding frequency bins on the various outputs by computer.
- Directional gain = $10 \log[(10^{G1/20} + 10^{G2/20} + \dots + 10^{GN/20})^2/N_{ANT}] = 3.69\text{dBi} < 6\text{dBi}$, so the power density limit no need to reduce.
- Refer to section 3.3 for duty cycle spectrum plot.

802.11n (HT20)

Chan.	Freq. (MHz)	PSD W/O Duty Factor (dBm/MHz)		Duty Factor (dB)	Total PSD With Duty Factor (dBm/MHz)	Max. Limit (dBm/MHz)	Pass / Fail
		Chain 0	Chain 1				
36	5180	-11.49	-14.83	0.74	-9.10	11.00	Pass
40	5200	-11.43	-13.91	0.74	-8.75	11.00	Pass
48	5240	-10.97	-13.66	0.74	-8.36	11.00	Pass

Note:

- Method E) 2) a) of power density measurement of KDB 662911 is using for calculating total power density. Total power density is summing entire spectra across corresponding frequency bins on the various outputs by computer.
- Directional gain = $10 \log[(10^{G1/20} + 10^{G2/20} + \dots + 10^{GN/20})^2/N_{ANT}] = 3.69\text{dBi} < 6\text{dBi}$, so the power density limit no need to reduce.
- Refer to section 3.3 for duty cycle spectrum plot.

802.11n (HT40)

Chan.	Freq. (MHz)	PSD W/O Duty Factor (dBm/MHz)		Duty Factor (dB)	Total PSD With Duty Factor (dBm/MHz)	Max. Limit (dBm/MHz)	Pass / Fail
		Chain 0	Chain 1				
38	5190	-14.62	-18.62	1.26	-11.91	11.00	Pass
46	5230	-14.70	-17.55	1.26	-11.63	11.00	Pass

Note:

- Method E) 2) a) of power density measurement of KDB 662911 is using for calculating total power density. Total power density is summing entire spectra across corresponding frequency bins on the various outputs by computer.
- Directional gain = $10 \log[(10^{G1/20} + 10^{G2/20} + \dots + 10^{GN/20})^2 / N_{ANT}] = 3.69 \text{dBi} < 6 \text{dBi}$, so the power density limit no need to reduce.
- Refer to section 3.3 for duty cycle spectrum plot.

802.11ac (VHT80)

Chan.	Freq. (MHz)	PSD W/O Duty Factor (dBm/MHz)		Duty Factor (dB)	Total PSD With Duty Factor (dBm/MHz)	Max. Limit (dBm/MHz)	Pass / Fail
		Chain 0	Chain 1				
42	5210	-20.03	-23.46	1.73	-16.67	11.00	Pass

Note:

- Method E) 2) a) of power density measurement of KDB 662911 is using for calculating total power density. Total power density is summing entire spectra across corresponding frequency bins on the various outputs by computer.
- Directional gain = $10 \log[(10^{G1/20} + 10^{G2/20} + \dots + 10^{GN/20})^2 / N_{ANT}] = 3.69 \text{dBi} < 6 \text{dBi}$, so the power density limit no need to reduce.
- Refer to section 3.3 for duty cycle spectrum plot.

Spectrum Plot of Worst Value

802.11a / Chain 0 / CH 48

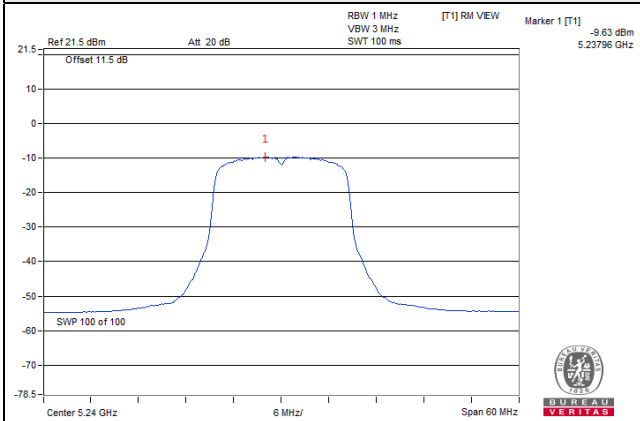

802.11n (HT20) / Chain 0 / CH 48

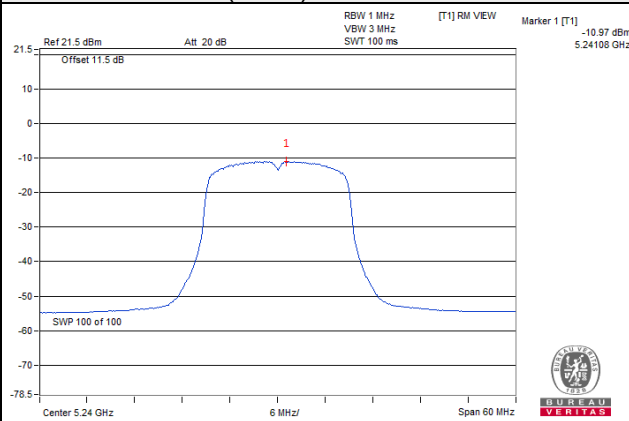

802.11n (HT40) / Chain 0 / CH 38

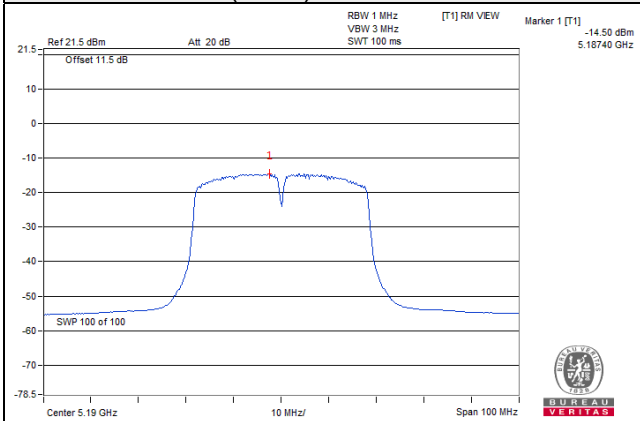

802.11ac (VHT80) / Chain 0 / CH 42

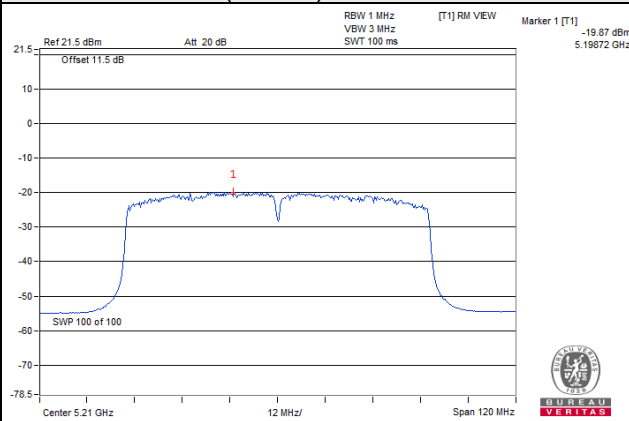

For U-NII-2A, U-NII-2C band

802.11a

Chan.	Freq. (MHz)	PSD W/O Duty Factor (dBm/MHz)		Duty Factor (dB)	Total PSD With Duty Factor (dBm/MHz)	Max. Limit (dBm/MHz)	Pass / Fail
		Chain 0	Chain 1				
52	5260	-9.69	-12.81	0.38	-7.59	11.00	Pass
60	5300	-10.11	-12.71	0.38	-7.83	11.00	Pass
64	5320	-9.98	-12.78	0.38	-7.77	11.00	Pass
100	5500	-12.30	-12.01	0.38	-8.76	11.00	Pass
116	5580	-11.84	-12.23	0.38	-8.64	11.00	Pass
140	5700	-13.43	-12.40	0.38	-9.49	11.00	Pass

Note:

- Method E) 2) a) of power density measurement of KDB 662911 is using for calculating total power density. Total power density is summing entire spectra across corresponding frequency bins on the various outputs by computer.
- Directional gain = $10 \log[(10^{G1/20} + 10^{G2/20} + \dots + 10^{GN/20})^2/N_{ANT}] = 3.86\text{dBi} < 6\text{dBi}$, so the power density limit no need to reduce.

802.11n (HT20)

Chan.	Freq. (MHz)	PSD W/O Duty Factor (dBm/MHz)		Duty Factor (dB)	Total PSD With Duty Factor (dBm/MHz)	Max. Limit (dBm/MHz)	Pass / Fail
		Chain 0	Chain 1				
52	5260	-11.03	-13.77	0.74	-8.44	11.00	Pass
60	5300	-11.37	-13.67	0.74	-8.62	11.00	Pass
64	5320	-11.37	-13.76	0.74	-8.65	11.00	Pass
100	5500	-13.04	-13.70	0.74	-9.61	11.00	Pass
116	5580	-13.00	-13.26	0.74	-9.38	11.00	Pass
140	5700	-14.50	-13.27	0.74	-10.09	11.00	Pass

Note:

- Method E) 2) a) of power density measurement of KDB 662911 is using for calculating total power density. Total power density is summing entire spectra across corresponding frequency bins on the various outputs by computer.
- Directional gain = $10 \log[(10^{G1/20} + 10^{G2/20} + \dots + 10^{GN/20})^2/N_{ANT}] = 3.86\text{dBi} < 6\text{dBi}$, so the power density limit no need to reduce.
- Refer to section 3.3 for duty cycle spectrum plot.

802.11n (HT40)

Chan.	Freq. (MHz)	PSD W/O Duty Factor (dBm/MHz)		Duty Factor (dB)	Total PSD With Duty Factor (dBm/MHz)	Max. Limit (dBm/MHz)	Pass / Fail
		Chain 0	Chain 1				
54	5270	-14.72	-17.57	1.26	-11.64	11.00	Pass
62	5310	-15.21	-17.34	1.26	-11.88	11.00	Pass
102	5510	-16.89	-16.85	1.26	-12.60	11.00	Pass
110	5550	-17.25	-16.71	1.26	-12.70	11.00	Pass
134	5670	-18.25	-16.93	1.26	-13.27	11.00	Pass

Note:

- Method E) 2) a) of power density measurement of KDB 662911 is using for calculating total power density. Total power density is summing entire spectra across corresponding frequency bins on the various outputs by computer.
- Directional gain = $10 \log[(10^{G1/20} + 10^{G2/20} + \dots + 10^{GN/20})^2/N_{ANT}] = 3.86\text{dBi} < 6\text{dBi}$, so the power density limit no need to reduce.
- Refer to section 3.3 for duty cycle spectrum plot.

802.11ac (VHT80)

Chan.	Freq. (MHz)	PSD W/O Duty Factor (dBm/MHz)		Duty Factor (dB)	Total PSD With Duty Factor (dBm/MHz)	Max. Limit (dBm/MHz)	Pass / Fail
		Chain 0	Chain 1				
58	5290	-19.93	-22.32	1.73	-16.22	11.00	Pass
106	5530	-21.82	-21.85	1.73	-17.09	11.00	Pass
122	5610	-22.06	-22.09	1.73	-17.33	11.00	Pass

Note:

- Method E) 2) a) of power density measurement of KDB 662911 is using for calculating total power density. Total power density is summing entire spectra across corresponding frequency bins on the various outputs by computer.
- Directional gain = $10 \log[(10^{G1/20} + 10^{G2/20} + \dots + 10^{GN/20})^2/N_{ANT}] = 3.86\text{dBi} < 6\text{dBi}$, so the power density limit no need to reduce.
- Refer to section 3.3 for duty cycle spectrum plot.

Spectrum Plot of Worst Value

802.11a / Chain 0 / CH 52

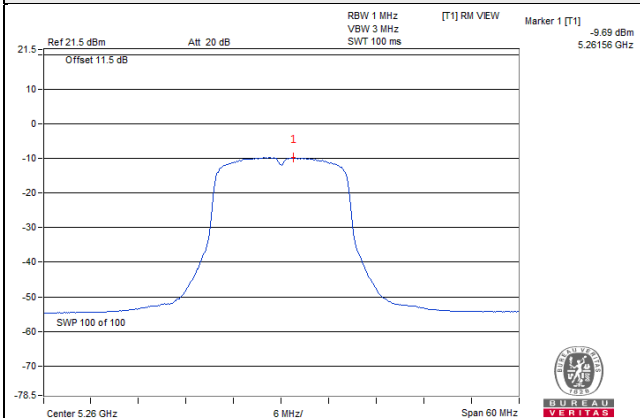

802.11n (HT20) / Chain 0 / CH 52

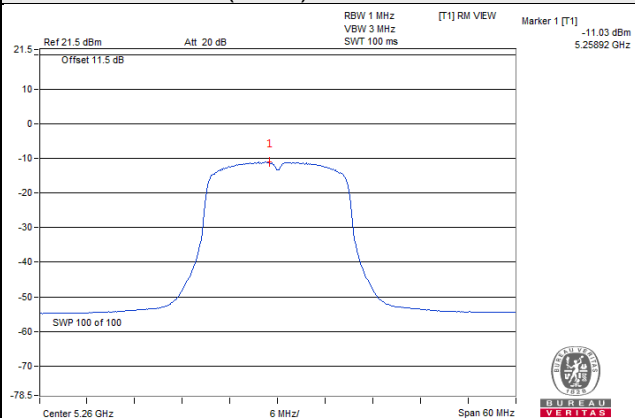

802.11n (HT40) / Chain 0 / CH 54

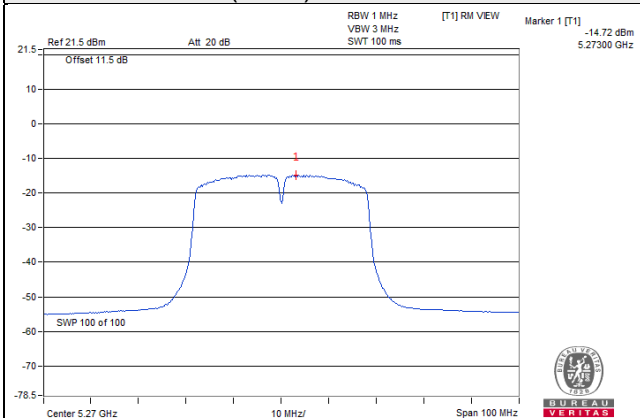

802.11ac (VHT80) / Chain 0 / CH 58

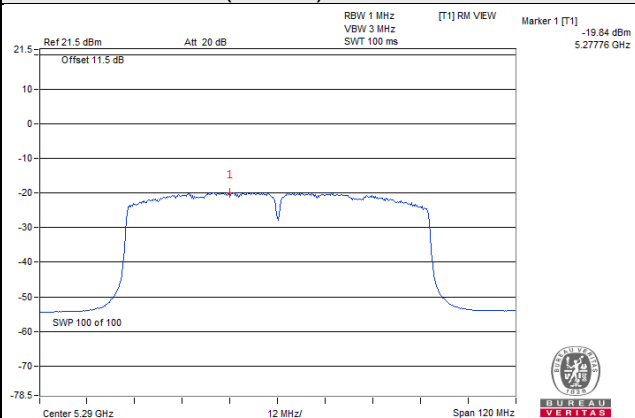

For U-NII-3 band

802.11a

TX chain	Chan.	Freq. (MHz)	PSD W/O Duty Factor		10 log (N=2) dB	Duty Factor (dB)	Total PSD With Duty Factor (dBm/500kHz)	Limit (dBm/500kHz)	Pass / Fail
			(dBm/300kHz)	(dBm/500kHz)					
0	149	5745	-21.97	-19.75	3.01	0.38	-16.36	30.00	Pass
	157	5785	-22.50	-20.28	3.01	0.38	-16.89	30.00	Pass
	165	5825	-22.39	-20.17	3.01	0.38	-16.78	30.00	Pass
1	149	5745	-20.82	-18.60	3.01	0.38	-15.21	30.00	Pass
	157	5785	-20.37	-18.15	3.01	0.38	-14.76	30.00	Pass
	165	5825	-20.19	-17.97	3.01	0.38	-14.58	30.00	Pass

Note:

- Method E) 2) c) of power density measurement of KDB 662911 is using for calculating total power density. Total power density is measure value add $10 \log (N_{ANT})$ dB.
- Directional gain = $10 \log[(10^{G1/20} + 10^{G2/20} + \dots + 10^{GN/20})^2/N_{ANT}] = 3.76\text{dBi} < 6\text{dBi}$, so the power density limit no need to reduce.
- Refer to section 3.3 for duty cycle spectrum plot.

802.11n (HT20)

TX chain	Chan.	Freq. (MHz)	PSD W/O Duty Factor		10 log (N=2) dB	Duty Factor (dB)	Total PSD With Duty Factor (dBm/500kHz)	Limit (dBm/500kHz)	Pass / Fail
			(dBm/300kHz)	(dBm/500kHz)					
0	149	5745	-22.89	-20.67	3.01	0.74	-16.92	30.00	Pass
	157	5785	-23.52	-21.30	3.01	0.74	-17.55	30.00	Pass
	165	5825	-23.67	-21.45	3.01	0.74	-17.70	30.00	Pass
1	149	5745	-21.69	-19.47	3.01	0.74	-15.72	30.00	Pass
	157	5785	-21.33	-19.11	3.01	0.74	-15.36	30.00	Pass
	165	5825	-21.16	-18.94	3.01	0.74	-15.19	30.00	Pass

Note:

- Method E) 2) c) of power density measurement of KDB 662911 is using for calculating total power density. Total power density is measure value add $10 \log (N_{ANT})$ dB.
- Directional gain = $10 \log[(10^{G1/20} + 10^{G2/20} + \dots + 10^{GN/20})^2/N_{ANT}] = 3.76\text{dBi} < 6\text{dBi}$, so the power density limit no need to reduce.
- Refer to section 3.3 for duty cycle spectrum plot.

802.11n (HT40)

TX chain	Chan.	Freq. (MHz)	PSD W/O Duty Factor		10 log (N=2) dB	Duty Factor (dB)	Total PSD With Duty Factor (dBm/500kHz)	Limit (dBm/500kHz)	Pass / Fail
			(dBm/300kHz)	(dBm/500kHz)					
0	151	5755	-26.94	-24.72	3.01	1.26	-20.45	30.00	Pass
	159	5795	-27.03	-24.81	3.01	1.26	-20.54	30.00	Pass
1	151	5755	-25.61	-23.39	3.01	1.26	-19.12	30.00	Pass
	159	5795	-25.13	-22.91	3.01	1.26	-18.64	30.00	Pass

Note:

- Method E) 2) c) of power density measurement of KDB 662911 is using for calculating total power density. Total power density is measure value add $10 \log (N_{ANT})$ dB.
- Directional gain = $10 \log[(10^{G1/20} + 10^{G2/20} + \dots + 10^{GN/20})^2/N_{ANT}] = 3.76\text{dBi} < 6\text{dBi}$, so the power density limit no need to reduce.
- Refer to section 3.3 for duty cycle spectrum plot.

802.11ac (VHT80)

TX chain	Chan.	Freq. (MHz)	PSD W/O Duty Factor		10 log (N=2) dB	Duty Factor (dB)	Total PSD With Duty Factor (dBm/500kHz)	Limit (dBm/500kHz)	Pass / Fail
			(dBm/300kHz)	(dBm/500kHz)					
0	155	5775	-32.07	-29.85	3.01	1.73	-25.11	30.00	Pass
1	155	5775	-30.06	-27.84	3.01	1.73	-23.10	30.00	Pass

Note:

- Method E) 2) c) of power density measurement of KDB 662911 is using for calculating total power density. Total power density is measure value add $10 \log (N_{ANT})$ dB.
- Directional gain = $10 \log[(10^{G1/20} + 10^{G2/20} + \dots + 10^{GN/20})^2/N_{ANT}] = 3.76\text{dBi} < 6\text{dBi}$, so the power density limit no need to reduce.
- Refer to section 3.3 for duty cycle spectrum plot.

Spectrum Plot of Worst Value

802.11a

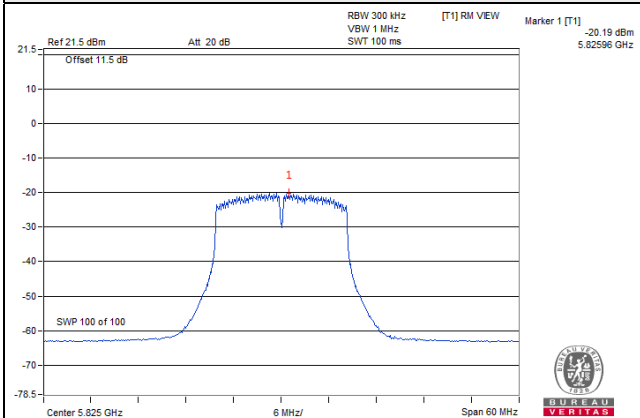

802.11n (HT20)

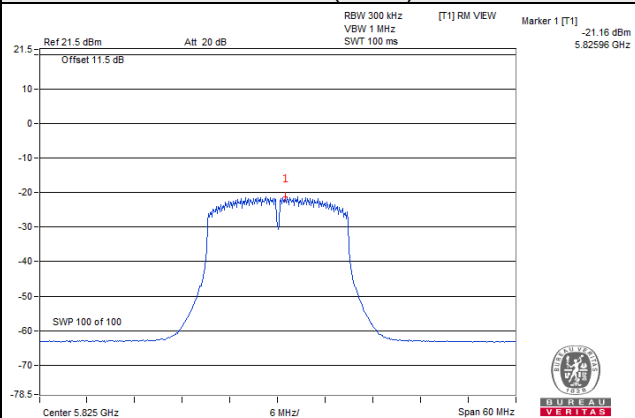

802.11n (HT40)

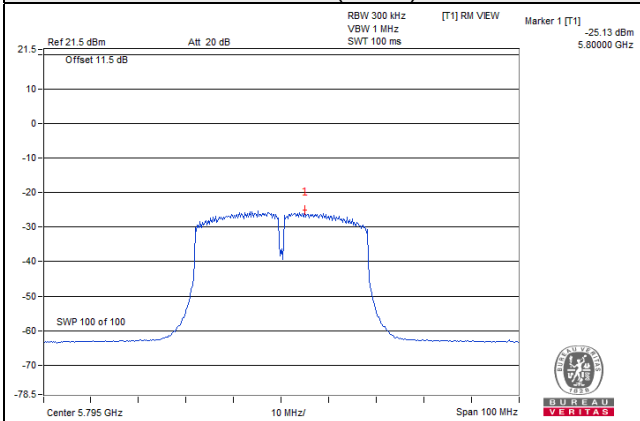

802.11ac (VHT80)

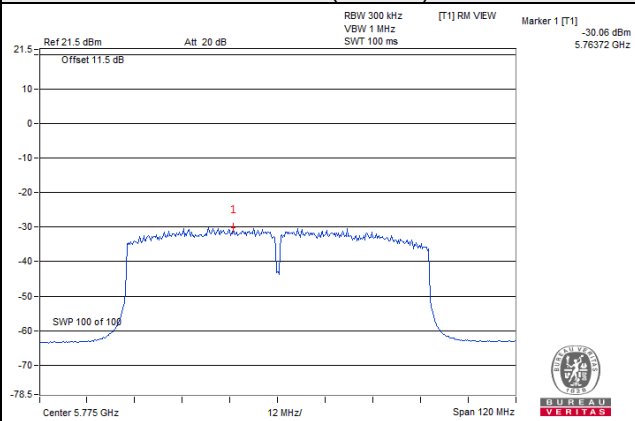

4.5 Frequency Stability

4.5.1 Limits of Frequency Stability Measurement

The frequency of the carrier signal shall be maintained within band of operation

4.5.2 Test Setup

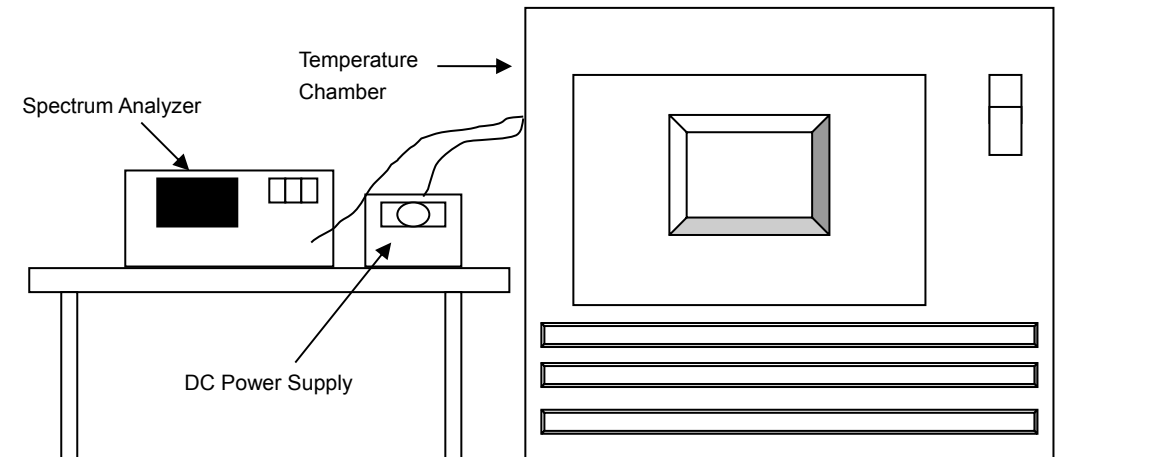

4.5.3 Test Instruments

Description & Manufacturer	Model No.	Serial No.	Cal. Date	Cal. Due
Spectrum Analyzer ROHDE & SCHWARZ	FSP40	100039	Jun. 12, 2019	Jun. 11, 2020
Standard Temperature And Humidity Chamber TERCHY	MHU-225AU	920842	May 31, 2019	May 30, 2020
Digital Multimeter Fluke	87-III	70360742	Jun. 27, 2019	Jun. 26, 2020
DC Power Supply Topward	6603D	700637	NA	NA

4.5.4 Test Procedure

- The EUT was placed inside the environmental test chamber and powered by nominal DC voltage.
- Turn the EUT on and couple its output to a spectrum analyzer.
- Turn the EUT off and set the chamber to the highest temperature specified.
- Allow sufficient time (approximately 30 min) for the temperature of the chamber to stabilize, turn the EUT on and measure the operating frequency after 2, 5, and 10 minutes.
- Repeat step (d) with the temperature chamber set to the next desired temperature until measurements down to the lowest specified temperature have been completed.
- The test chamber was allowed to stabilize at +20 degree C for a minimum of 30 minutes. The supply voltage was then adjusted on the EUT from 85% to 115% and the frequency record.

4.5.5 Deviation from Test Standard

No deviation.

4.5.6 EUT Operating Condition

Set the EUT transmit at un-modulation mode to test frequency stability.

4.5.7 Test Results

Frequency Stability Versus Temp.									
Operating Frequency: 5180MHz									
Temp. (°C)	Power Supply (Vdc)	0 Minute		2 Minute		5 Minute		10 Minute	
		Measured Frequency (MHz)	Result	Measured Frequency (MHz)	Result	Measured Frequency (MHz)	Result	Measured Frequency (MHz)	Result
75	12	5179.9801	PASS	5179.9823	PASS	5179.9784	PASS	5179.9811	PASS
70	12	5179.9864	PASS	5179.9887	PASS	5179.9891	PASS	5179.9862	PASS
60	12	5179.9885	PASS	5179.9892	PASS	5179.9866	PASS	5179.9866	PASS
50	12	5179.9916	PASS	5179.9906	PASS	5179.9914	PASS	5179.9929	PASS
40	12	5179.9825	PASS	5179.9813	PASS	5179.9798	PASS	5179.9822	PASS
30	12	5179.9842	PASS	5179.9882	PASS	5179.9856	PASS	5179.9856	PASS
20	12	5179.9818	PASS	5179.9848	PASS	5179.9826	PASS	5179.9854	PASS
10	12	5179.9747	PASS	5179.9756	PASS	5179.9743	PASS	5179.9766	PASS
0	12	5179.9745	PASS	5179.9742	PASS	5179.9752	PASS	5179.9759	PASS
-10	12	5179.9853	PASS	5179.9854	PASS	5179.9835	PASS	5179.9833	PASS
-20	12	5179.9733	PASS	5179.9773	PASS	5179.9757	PASS	5179.9759	PASS
-30	12	5180.0142	PASS	5180.0132	PASS	5180.0100	PASS	5180.0149	PASS
-40	12	5180.0023	PASS	5179.9996	PASS	5180.0031	PASS	5179.9993	PASS

Frequency Stability Versus Voltage									
Operating Frequency: 5180MHz									
Temp. (°C)	Power Supply (Vdc)	0 Minute		2 Minute		5 Minute		10 Minute	
		Measured Frequency (MHz)	Result	Measured Frequency (MHz)	Result	Measured Frequency (MHz)	Result	Measured Frequency (MHz)	Result
20	13.8	5179.9819	PASS	5179.9854	PASS	5179.9829	PASS	5179.9845	PASS
	12	5179.9818	PASS	5179.9848	PASS	5179.9826	PASS	5179.9854	PASS
	10.2	5179.9817	PASS	5179.985	PASS	5179.9818	PASS	5179.9863	PASS

4.6 6dB Bandwidth Measurement

4.6.1 Limits of 6dB Bandwidth Measurement

The minimum of 6dB Bandwidth Measurement is 0.5MHz.

4.6.2 Test Setup

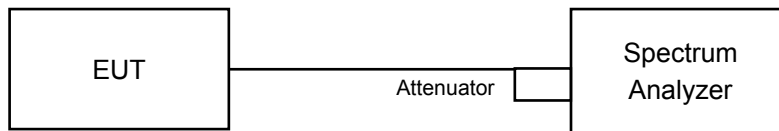

4.6.3 Test Instruments

Refer to section 4.1.2 to get information of above instrument.

4.6.4 Test Procedure

Measurement Procedure REF

- Set resolution bandwidth (RBW) = 100kHz
- Set the video bandwidth (VBW) $\geq 3 \times$ RBW, Detector = Peak.
- Trace mode = max hold.
- Sweep = auto couple.
- Measure the maximum width of the emission that is constrained by the frequencies associated with the two amplitude points (upper and lower) that are attenuated by 6 dB relative to the maximum level measured in the fundamental emission

4.6.5 Deviation from Test Standard

No deviation.

4.6.6 EUT Operating Condition

The software provided by client to enable the EUT under transmission condition continuously at lowest, middle and highest channel frequencies individually.

4.6.7 Test Results

802.11a

Channel	Frequency (MHz)	6dB Bandwidth (MHz)		Minimum Limit (MHz)	Pass / Fail
		Chain 0	Chain 1		
149	5745	15.39	15.17	0.5	Pass
157	5785	15.33	15.19	0.5	Pass
165	5825	15.17	15.18	0.5	Pass

802.11n (HT20)

Channel	Frequency (MHz)	6dB Bandwidth (MHz)		Minimum Limit (MHz)	Pass / Fail
		Chain 0	Chain 1		
149	5745	15.50	15.78	0.5	Pass
157	5785	15.19	15.77	0.5	Pass
165	5825	15.16	15.20	0.5	Pass

802.11n (HT40)

Channel	Frequency (MHz)	6dB Bandwidth (MHz)		Minimum Limit (MHz)	Pass / Fail
		Chain 0	Chain 1		
151	5755	35.26	35.23	0.5	Pass
159	5795	35.24	35.26	0.5	Pass

802.11ac (VHT80)

Channel	Frequency (MHz)	6dB Bandwidth (MHz)		Minimum Limit (MHz)	Pass / Fail
		Chain 0	Chain 1		
155	5775	75.36	75.38	0.5	Pass

Spectrum Plot of Worst Value

802.11a

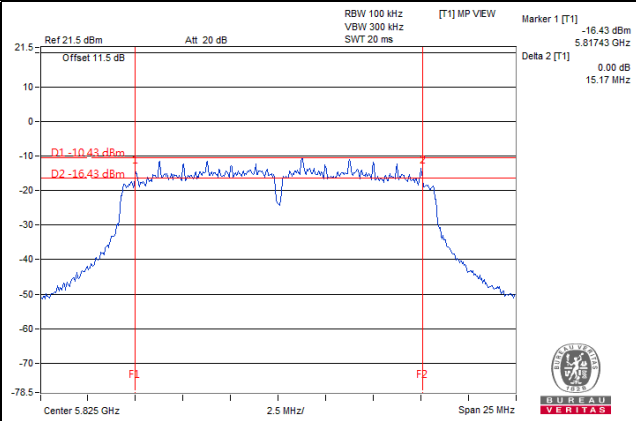

802.11n (HT20)

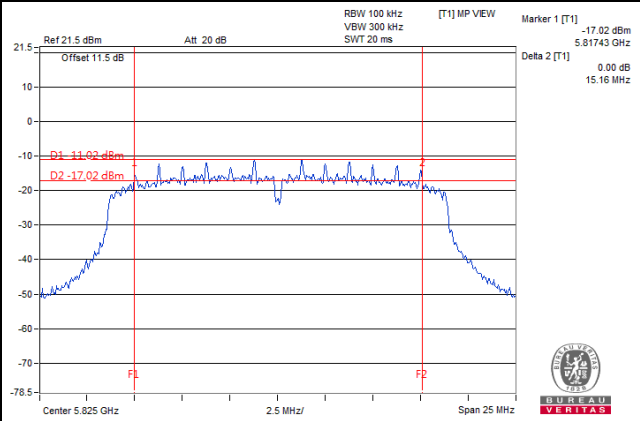

802.11n (HT40)

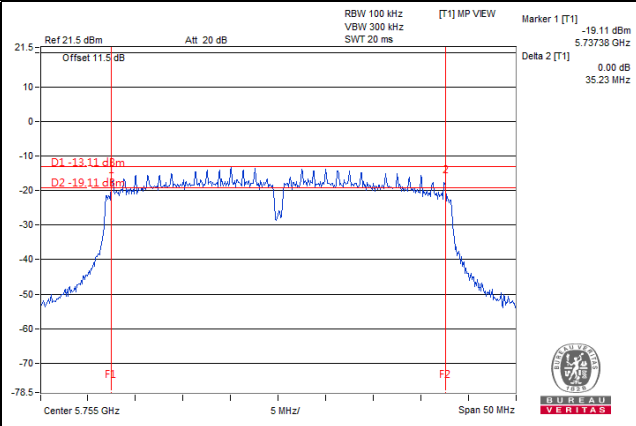

802.11ac (VHT80)

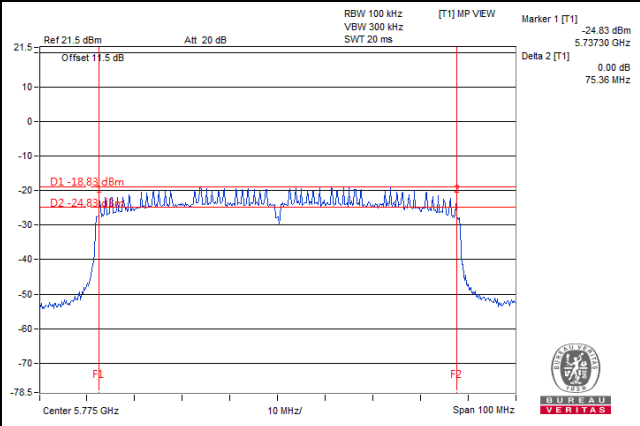

5 Pictures of Test Arrangements

Please refer to the attached file (Test Setup Photo).

Annex A- Radiated Out of Band Emission (OOBE) Measurement (For U-NII-3 band)

802.11a

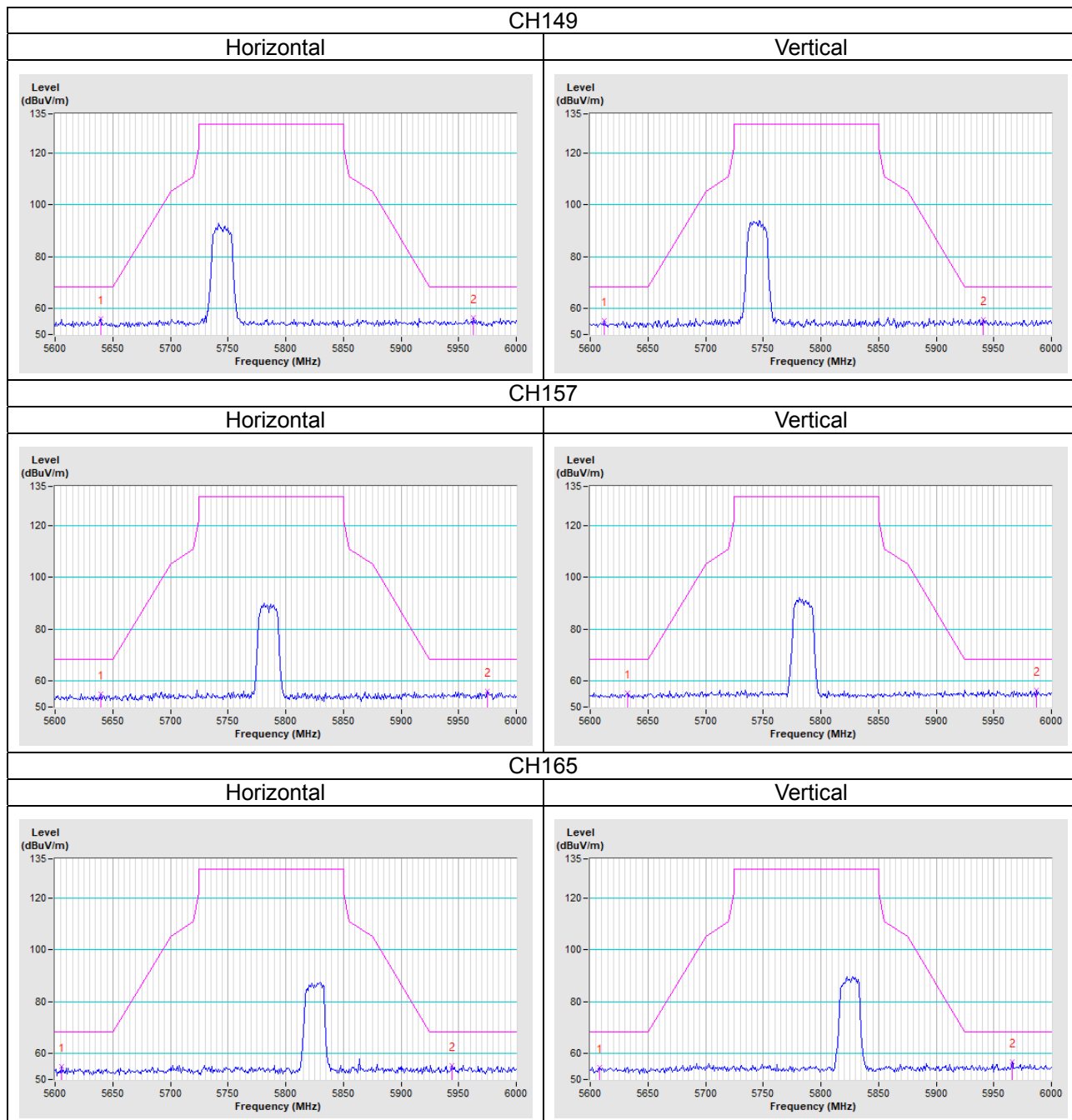

802.11n (HT20)

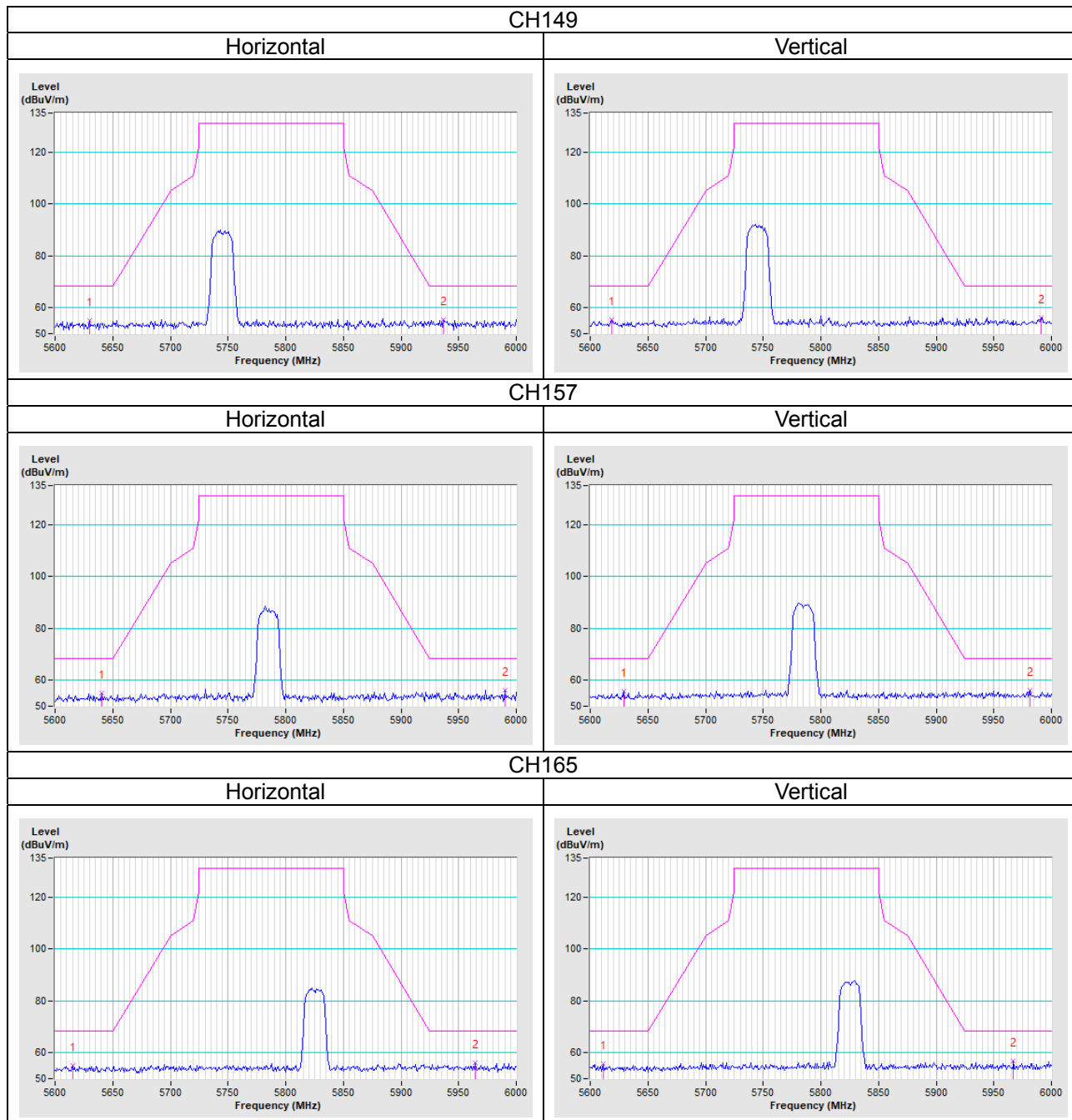

802.11n (HT40)

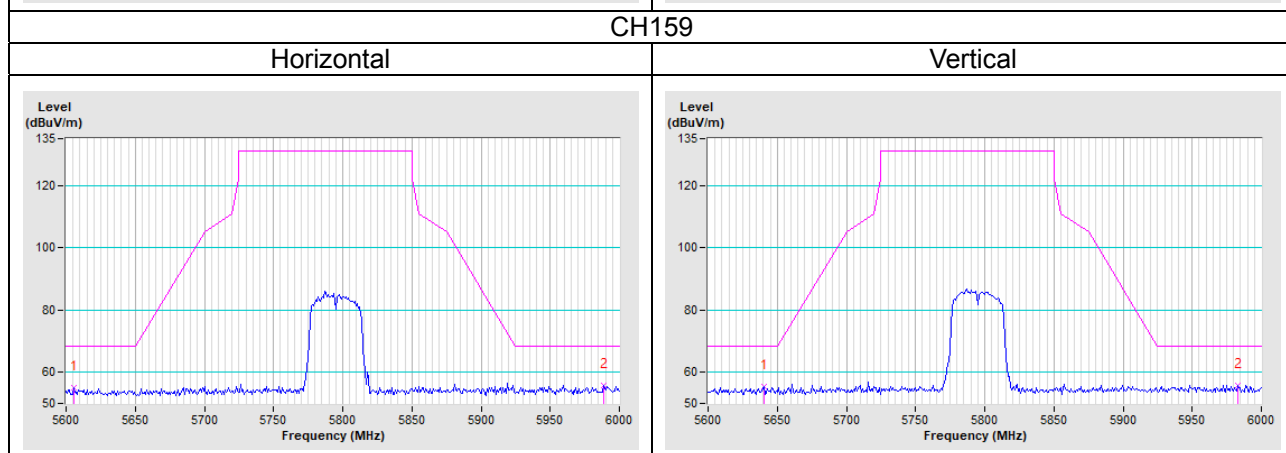
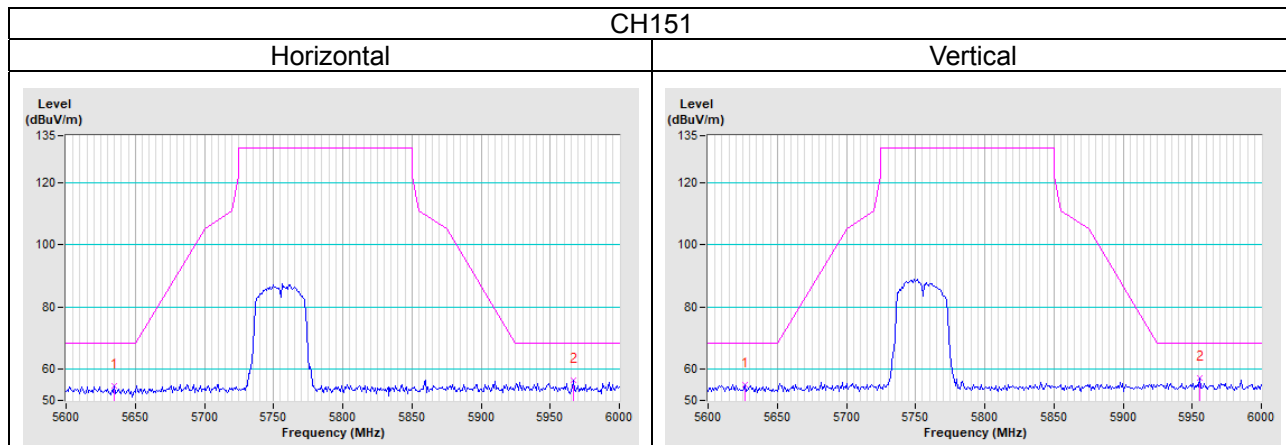

802.11ac (VHT80)

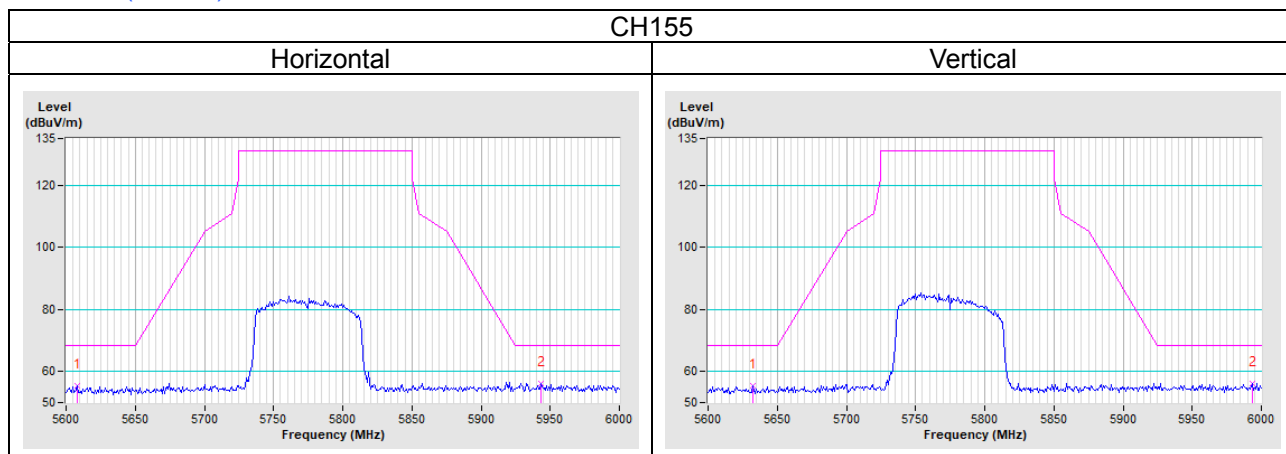

Appendix – Information of the Testing Laboratories

We, Bureau Veritas Consumer Products Services (H.K.) Ltd., Taoyuan Branch, were founded in 1988 to provide our best service in EMC, Radio, Telecom and Safety consultation. Our laboratories are FCC recognized accredited test firms and accredited and approved according to ISO/IEC 17025.

If you have any comments, please feel free to contact us at the following:

Lin Kou EMC/RF Lab

Tel: 886-2-26052180

Fax: 886-2-26051924

Hsin Chu EMC/RF/Telecom Lab

Tel: 886-3-6668565

Fax: 886-3-6668323

Hwa Ya EMC/RF/Safety Lab

Tel: 886-3-3183232

Fax: 886-3-3270892

Email: service.adt@tw.bureauveritas.com

Web Site: www.bureauveritas-adt.com

The address and road map of all our labs can be found in our web site also.

--- END ---