

**Positive Battery Post**

See below steps to prepare for jump starting:

1. Apply the parking brake, shift the automatic transmission into PARK and turn the ignition OFF.
2. Turn off the heater, radio, and all electrical accessories.
3. Pull upward and remove the protective cover over the remote positive (+) battery post.
4. If using another vehicle to jump start the battery, park the vehicle within the jumper cables' reach, apply the parking brake and make sure the ignition is OFF.

WARNING!

- Take care to avoid the radiator cooling fan whenever the hood is raised. It can start anytime the ignition switch is ON. You can be injured by moving fan blades.
- Remove any metal jewelry such as rings, watch bands and bracelets that could make an inadvertent electrical contact. You could be seriously injured.
- Batteries contain sulfuric acid that can burn your skin or eyes and generate hydrogen gas which is flammable and explosive. Keep open flames or sparks away from the battery.

WARNING!

Do not allow vehicles to touch each other as this could establish a ground connection and personal injury could result.

JUMP STARTING PROCEDURE**WARNING!**

Failure to follow this jump starting procedure could result in personal injury or property damage due to battery explosion.

CAUTION!

Failure to follow these procedures could result in damage to the charging system of the booster vehicle or the discharged vehicle.

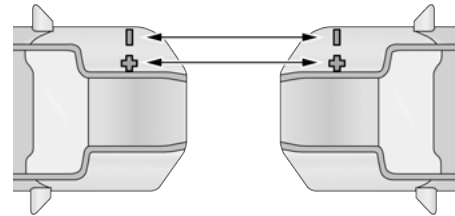
Connecting The Jumper Cables**Jumper Cable Connections**

A0710000113US

1. Connect the positive (+) end of the jumper cable to the positive (+) post of the discharged vehicle.

NOTE:

Do not jump off fuses. Only jump directly off positive post.

2. Connect the opposite end of the positive (+) jumper cable to the positive (+) post of the booster battery.
3. Connect the negative (-) end of the jumper cable to the negative (-) post of the booster battery.
4. Connect the opposite end of the negative (-) jumper cable to a good engine ground. A "ground" is an exposed metallic/unpainted part of the engine, frame or chassis, such as an accessory bracket or large bolt. The ground must be away from the battery and the fuel injection system.

WARNING!

Do not connect the jumper cable to the negative (-) post of the discharged battery. The resulting electrical spark could cause the battery to explode and could result in personal injury.

5. Start the engine in the vehicle that has the booster battery, let the engine idle a few minutes, and then start the engine in the vehicle with the discharged battery.

CAUTION!

Do not connect jumper cable to any of the fuses on the positive battery terminal. The resulting electrical current will blow the fuse.

6. Once the engine is started, follow the disconnection procedure below.

Disconnecting The Jumper Cables

1. Disconnect the negative (-) end of the jumper cable from the engine ground of the vehicle with the discharged battery.
2. Disconnect the opposite end of the negative (-) jumper cable from the negative (-) post of the booster battery.

3. Disconnect the positive (+) end of the jumper cable from the positive (+) post of the booster battery.
4. Disconnect the opposite end of the positive (+) jumper cable from the positive (+) post of the vehicle with the discharged battery.

If frequent jump starting is required to start your vehicle you should have the battery and charging system inspected at an authorized dealer.

CAUTION!

Accessories plugged into the vehicle power outlets draw power from the vehicle's battery, even when not in use (i.e., cellular devices, etc.). Eventually, if plugged in long enough without engine operation, the vehicle's battery will discharge sufficiently to degrade battery life and/or prevent the engine from starting.

REFUELING IN EMERGENCY – IF EQUIPPED

The fuel filling procedure in case of an emergency is described on ↗ page 208.

The vehicle is equipped with a refueling funnel. If refueling is necessary, while using an approved gas can, please insert the refueling funnel into the filler neck opening.

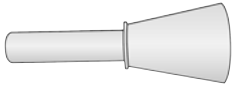

A071100008US

Refueling Funnel

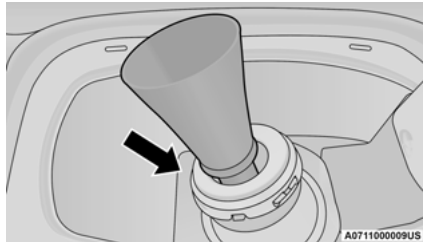

A071100009US

Inserting Funnel

IF YOUR ENGINE OVERHEATS

If the vehicle is overheating, it will need to be serviced by an authorized dealer.

In any of the following situations, you can reduce the potential for overheating by taking the appropriate action.

- On the highways – slow down.
- In city traffic – while stopped, place the transmission in NEUTRAL (N), but do not increase the engine idle speed while preventing vehicle motion with the brakes.

NOTE:

There are steps that you can take to slow down an impending overheat condition:

- If your Air Conditioner (A/C) is on, turn it off. The A/C system adds heat to the engine cooling system and turning the A/C off can help remove this heat.
- You can also turn the temperature control to maximum heat, the mode control to floor and the blower control to high. This allows the heater core to act as a supplement to the radiator and aids in removing heat from the engine cooling system.

WARNING!

You or others can be badly burned by hot engine coolant (antifreeze) or steam from your radiator. If you see or hear steam coming from under the hood, do not open the hood until the radiator has had time to cool. Never try to open a cooling system pressure cap when the radiator or coolant bottle is hot.

CAUTION!

Driving with a hot cooling system could damage your vehicle. If the temperature gauge reads HOT (H), pull over and stop the vehicle. Idle the vehicle with the air conditioner turned off until the pointer drops back into the normal range. If the pointer remains on HOT (H), and you hear continuous chimes, turn the engine off immediately and call for service.

MANUAL PARK RELEASE

WARNING!

Always secure your vehicle by fully applying the parking brake before activating the Manual Park Release. In addition, you should be seated in the driver's seat with your foot firmly on the brake pedal when activating the Manual Park Release. Activating the Manual Park Release will allow your vehicle to roll away if it is not secured by the parking brake, or by proper connection to a tow vehicle. Activating the Manual Park Release on an unsecured vehicle could lead to serious injury or death for those in or around the vehicle.

In order to move the vehicle in cases where the transmission will not shift out of PARK (P) (such as a depleted battery), a Manual Park Release is available.

Follow these steps to activate the Manual Park Release:

1. Apply firm pressure to the brake pedal while seated in the driver's seat.
2. Apply the parking brake if possible.

3. Using a small screwdriver or similar tool, open the Manual Park Release cover, which is located to the lower left of the steering column.

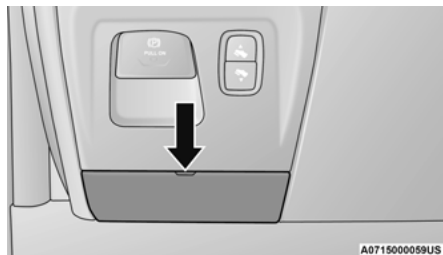

Manual Park Release Access Cover

4. Behind the Manual Park Release access cover is the orange tether strap. Pull the tether strap out as far as it will go, then release it. The tether and lever will remain outside of the trim panel and the transmission should now be in NEUTRAL, allowing the vehicle to be moved.

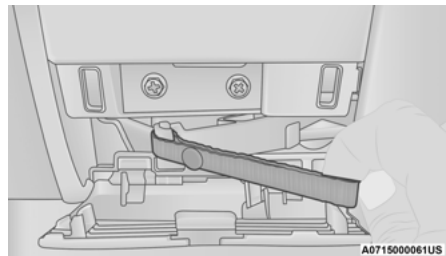

Manual Park Release Tether

To Reset The Manual Park Release:

1. Apply firm pressure to the brake pedal while seated in the driver's seat.
2. Pull the tether strap out again, then release it.

3. Allow the tether to retract with the lever back to its original position.

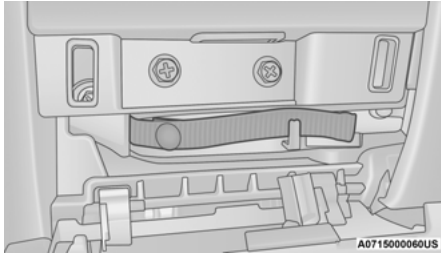

Manual Park Release Tether

4. Verify the transmission is in PARK.
5. Confirm that the tether has retracted fully and re-install the access cover. If the access cover cannot be reinstalled, repeat steps 1 through 4.

NOTE:

When the lever is locked in the released position the access cover cannot be reinstalled.

FREEING A STUCK VEHICLE

If your vehicle becomes stuck in mud, sand, or snow, it can often be moved using a rocking motion. Turn the steering wheel right and left to clear the area around the front wheels. Then shift back and forth between DRIVE (D) and REVERSE (R), while gently pressing the accelerator. Use the least amount of accelerator pedal pressure that will maintain the rocking motion, without spinning the wheels or racing the engine.

NOTE:

Shifts between DRIVE and REVERSE can only be achieved at wheel speeds of 5 mph (8 km/h) or less. Whenever the transmission remains in NEUTRAL (N) for more than two seconds, you must press the brake pedal to engage DRIVE or REVERSE.

Push the “ESC OFF” switch to place the Electronic Stability Control (ESC) system in “Partial OFF” mode, before rocking the vehicle ☞ page 312. Once the vehicle has been freed, push the “ESC OFF” switch again to restore “ESC On” mode.

WARNING!

Fast spinning tires can be dangerous. Forces generated by excessive wheel speeds may cause damage, or even failure, of the axle and tires. A tire could explode and injure someone. Do not spin your vehicle's wheels faster than 30 mph (48 km/h) or for longer than 30 seconds continuously without stopping when you are stuck and do not let anyone near a spinning wheel, no matter what the speed.

CAUTION!

- Racing the engine or spinning the wheels may lead to transmission overheating and failure. Allow the engine to idle with the transmission in NEUTRAL for at least one minute after every five rocking-motion cycles. This will minimize overheating and reduce the risk of transmission failure during prolonged efforts to free a stuck vehicle.

(Continued)

CAUTION! *(Continued)*

- When “rocking” a stuck vehicle by shifting between DRIVE and REVERSE, do not spin the wheels faster than 15 mph (24 km/h), or drivetrain damage may result.
- Revving the engine or spinning the wheels too fast may lead to transmission overheating and failure. It can also damage the tires. Do not spin the wheels above 30 mph (48 km/h) while in gear (no transmission shifting occurring).

TOWING A DISABLED VEHICLE

This section describes procedures for towing a disabled vehicle using a commercial towing service.

If the transmission and drivetrain are operable, disabled vehicles may also be towed as described on ⇨ page 230.

NOTE:

Vehicles equipped with the Active-Level Four Corner Air Suspension System must be placed in Transport mode, before tying them down (from the body) on a trailer or flatbed truck ⇨ page 165. If the vehicle cannot be placed in Transport mode (for example, engine will not run), tie-downs must be fastened to the axles (not to the body). Failure to follow these instructions may cause fault codes to be set and/or cause loss of proper tie-down tension.

Towing Condition	Wheels OFF The Ground	2WD Models	4WD Models
Flat Tow	NONE	If transmission is operable: <ul style="list-style-type: none"> • Transmission in NEUTRAL • 30 mph (48 km/h) max speed • 30 miles (48 km) max distance 	Detailed instruction on ⇨ page 230 <ul style="list-style-type: none"> • Automatic Transmission in PARK • Transfer Case in NEUTRAL (N) • Tow in forward direction
Wheel Lift Or Dolly Tow	Front		NOT ALLOWED
	Rear	OK	NOT ALLOWED
Flatbed	ALL	BEST METHOD	BEST METHOD

Proper towing or lifting equipment is required to prevent damage to your vehicle. Use only tow bars and other equipment designed for this purpose, following equipment FCA's instructions. Use of safety chains is mandatory. Attach a tow bar or other towing device to main structural members of the vehicle, not to fascia/bumpers or associated brackets. State and local laws regarding vehicles under tow must be observed.

If you must use the accessories (wipers, defrosters, etc.) while being towed, the ignition must be in the ON/RUN mode, not the ACC mode.

If the key fob is unavailable or the vehicle's battery is discharged, find Instructions on shifting the transmission out of PARK
 ⇨ page 390.

CAUTION!

- Do not use sling type equipment when towing. Vehicle damage may occur.
- When securing the vehicle to a flat bed truck, do not attach to front or rear suspension components. Damage to your vehicle may result from improper towing.

TWO-WHEEL DRIVE MODELS

FCA recommends towing your vehicle with all four wheels **OFF** the ground using a flatbed.

If flatbed equipment is not available, and the transmission is operable, the vehicle may be towed (with rear wheels on the ground) under the following conditions:

- The transmission must be in NEUTRAL (N). Instructions on shifting the transmission to NEUTRAL (N) when the engine is off
 ⇨ page 390.
- The towing speed must not exceed 30 mph (48 km/h).
- The towing distance must not exceed 30 miles (48 km).

If the transmission is not operable, or the vehicle must be towed faster than 30 mph (48 km/h) and farther than 30 miles (48 km), tow with the rear wheels **OFF** the ground. Acceptable methods to tow the vehicle on a flatbed are as follows:

- The front wheels raised and the rear wheels on a towing dolly

- Using a suitable steering wheel stabilizer to hold the front wheels in the straight position with the rear wheels raised when and the front wheels **ON** the ground.

CAUTION!

Towing this vehicle in violation of the above requirements can cause severe transmission damage. Damage from improper towing is not covered under the New Vehicle Limited Warranty.

FOUR-WHEEL DRIVE MODELS

FCA recommends towing with all wheels **OFF** the ground. Acceptable methods are to tow the vehicle on a flatbed or with one end of vehicle raised and the opposite end on a towing dolly.

CAUTION!

- Front or rear wheel lifts must not be used (if the remaining wheels are on the ground). Internal damage to the transmission or transfer case will occur if a front or rear wheel lift is used when towing.

(Continued)

CAUTION! *(Continued)*

- Towing this vehicle in violation of the above requirements can cause severe transmission and/or transfer case damage. Damage from improper towing is not covered under the New Vehicle Limited Warranty.

EMERGENCY TOW HOOKS — IF EQUIPPED

Your vehicle may be equipped with emergency tow hooks.

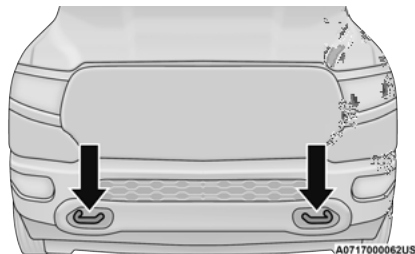

Emergency Tow Hooks

NOTE:

For off-road recovery, it is recommended to use both of the front tow hooks to minimize the risk of damage to the vehicle.

WARNING!

- Do not use a chain for freeing a stuck vehicle. Chains may break, causing serious injury or death.
- Stand clear of vehicles when pulling with tow hooks. Tow straps may become disengaged, causing serious injury.

CAUTION!

Tow hooks are for emergency use only, to rescue a vehicle stranded off road. Do not use tow hooks for tow truck hookup or highway towing. You could damage your vehicle.

ENHANCED ACCIDENT RESPONSE SYSTEM (EARS)

This vehicle is equipped with an Enhanced Accident Response System.

This feature is a communication network that takes effect in the event of an impact
 ⇨ page 353.

EVENT DATA RECORDER (EDR)

This vehicle is equipped with an Event Data Recorder (EDR). The main purpose of an EDR is to record data that will assist in understanding how a vehicle's systems performed under certain crash or near crash-like situations, such as an air bag deployment or hitting a road obstacle ⇨ page 355.

SERVICING AND MAINTENANCE

SCHEDULED SERVICING — GASOLINE ENGINE

Your vehicle is equipped with an automatic oil change indicator system. The oil change indicator system will remind you that it is time to take your vehicle in for scheduled maintenance.

Based on engine operation conditions, the oil change indicator message will illuminate. This means that service is required for your vehicle.

Operating conditions such as frequent short-trips, trailer tow, and extremely hot or cold ambient temperatures will influence when the “Oil Change Required” message is displayed. Severe operating conditions can cause the change oil message to illuminate as early as 3,500 miles (5,600 km) since last reset. Have your vehicle serviced as soon as possible, within the next 500 miles (805 km).

An authorized dealer will reset the oil change indicator message after completing the scheduled oil change. If a scheduled oil change is performed by someone other than an

authorized dealer, the message can be reset by referring to the steps described under Instrument Cluster Display ↪ page 114.

NOTE:

Under no circumstances should oil change intervals exceed 10,000 miles (16,000 km), 12 months or 350 hours of engine run time, whichever comes first. The 350 hours of engine run or idle time is generally only a concern for fleet customers.

Severe Duty All Models

NOTE:

Vehicles that are operated in a dusty and off-road environment, or predominately at idle or very low engine RPM are known as Severe Duty vehicles. It is recommended that you change the engine oil at 4,000 miles (6,500 km) or 350 hours of engine run time.

Once A Month Or Before A Long Trip:

- Check engine oil level.
- Check windshield washer fluid level.

- Check tire pressure and look for unusual wear or damage. Rotate tires at the first sign of irregular wear, even if it occurs before the oil indicator system turns on.
- Check the fluid levels of the coolant reservoir, brake master cylinder, and fill as needed.
- Check function of all interior and exterior lights.

MAINTENANCE PLAN

Refer to the Maintenance Plan for required maintenance. More frequent maintenance may be needed in severe conditions, such as dusty areas and very short trip driving. In some extreme conditions, additional maintenance not specified in the maintenance schedule may be required.

At Every Oil Change Interval As Indicated By Oil Change Indicator System:

- Change the oil and filter.
- Rotate the tires. **Rotate at the first sign of irregular wear, even if it occurs before the oil indicator system turns on.**
- Inspect the battery and clean and tighten terminals as required.
- Inspect the CV/Universal joints.
- Inspect the brake pads, shoes, rotors, drums, and hoses.
- Inspect the engine cooling system protection and hoses.
- Inspect the exhaust system.
- Inspect the engine air cleaner if using in dusty or off-road conditions, replace the engine air cleaner, as necessary.
- Inspect and replace the Evaporative System Fresh Air Filter as necessary; replacement may be more frequent if vehicle is operated in extreme dusty conditions.

NOTE:

Using white lithium grease, lubricate the door hinge roller pivot joints twice a year to prevent premature wear.

Mileage or time passed (whichever comes first)	20,000	30,000	40,000	50,000	60,000	70,000	80,000	90,000	100,000	110,000	120,000	130,000	140,000	150,000
Or Years:	2	3	4	5	6	7	8	9	10	11	12	13	14	15
Or Kilometers:	32,000	48,000	64,000	80,000	96,000	112,000	128,000	144,000	160,000	176,000	192,000	208,000	224,000	240,000
Additional Inspections														
Inspect the CV/Universal joints.	X	X	X	X	X	X	X	X	X	X	X	X	X	X
Inspect front suspension, tie rod ends, and replace if necessary.	X		X		X		X		X		X		X	
Inspect the front and rear axle surfaces. If gear oil leakage is suspected, check the fluid level. If using your vehicle for police, taxi, fleet, off-road or frequent trailer towing, change axle fluid.		X			X			X			X			X
Inspect the brake linings, replace as necessary.	X		X		X		X		X		X		X	
Inspect transfer case fluid.														X
Additional Maintenance														
Replace cabin air filter.	X		X		X		X		X		X		X	
Replace engine air cleaner.		X			X			X			X			X

Mileage or time passed (whichever comes first)	20,000	30,000	40,000	50,000	60,000	70,000	80,000	90,000	100,000	110,000	120,000	130,000	140,000	150,000
Or Years:	2	3	4	5	6	7	8	9	10	11	12	13	14	15
Or Kilometers:	32,000	48,000	64,000	80,000	96,000	112,000	128,000	144,000	160,000	176,000	192,000	208,000	224,000	240,000
If equipped with Stop/Start, replace accessory drive belt with OEM grade Mopar belt.														X
Replace spark plugs. ¹									X					
Flush and replace the engine coolant at 10 years or 150,000 miles (240,000 km) whichever comes first.									X					X
Inspect the transfer case fluid, change for any of the following: police, taxi, fleet, or frequent trailer towing.					X						X			
Change the transfer case fluid.											X			
Inspect and replace PCV valve if necessary.									X					

1. The spark plug change interval is mileage based only; yearly intervals do not apply.

WARNING!

- You can be badly injured working on or around a motor vehicle. Do only service work for which you have the knowledge and the right equipment. If you have any doubt about your ability to perform a service job, take your vehicle to a competent mechanic.
- Failure to properly inspect and maintain your vehicle could result in a component malfunction and affect vehicle handling and performance. This could cause an accident.

SCHEDULED SERVICING — DIESEL ENGINE

Your vehicle is equipped with an automatic oil change indicator system. The oil change indicator system will remind you that it is time to take your vehicle in for scheduled maintenance.

Based on engine operation conditions, the oil change indicator message will illuminate. This means that service is required for your vehicle. Operating conditions such as frequent short-trips, trailer tow, extremely hot or cold ambient temperatures will influence when the “Oil Change Required” message is displayed. Severe Operating Conditions will cause the change oil message to illuminate more frequently. Have your vehicle serviced as soon as possible, within the next 500 miles (805 km).

An authorized dealer will reset the oil change indicator message after completing the scheduled oil change. If a scheduled oil change is performed by someone other than an authorized dealer, the message can be reset by referring to the steps described under Instrument Cluster Display ⇨ page 114.

NOTE:

Under no circumstances should oil change intervals exceed 10,000 miles (16,000 km) or 12 months, whichever comes first.

Once A Month Or Before A Long Trip:

- Check engine oil level
- Check windshield washer fluid level
- Check the tire inflation pressures and look for unusual wear or damage
- Check the fluid levels of the coolant reservoir, brake master cylinder, and power steering, and fill as needed
- Check function of all interior and exterior lights

MAINTENANCE PLAN — DIESEL FUEL UP TO B5 BIODIESEL

Refer to the Maintenance Schedules for required maintenance.

At Every Oil Change Interval As Indicated By Oil Change Indicator System:

- Change oil and filter.
- Completely fill the Diesel Exhaust Fluid tank.
- Drain water from fuel filter assembly.
- Rotate the tires. **Rotate at the first sign of irregular wear, even if it occurs before the oil indicator system turns on.**
- Inspect battery and clean and tighten terminals as required.
- Inspect the CV/Universal joints.
- Inspect brake pads, shoes, rotors, drums, hoses and park brake.
- Inspect engine cooling system protection and hoses.
- Inspect exhaust system.
- Inspect engine air cleaner if using in dusty or off-road conditions. Replace engine air cleaner, as necessary.

NOTE:

Using white lithium grease, lubricate the door hinge roller pivot joints twice a year to prevent premature wear.

At Every Second Oil Change Interval As Indicated By Oil Change Indicator System:

- Change fuel filter.

Mileage or time passed (whichever comes first)	10,000	20,000	30,000	40,000	50,000	60,000	70,000	80,000	90,000	100,000	110,000	120,000	130,000	140,000	150,000
Or Years:	1	2	3	4	5	6	7	8	9	10	11	12	13	14	15
Or Kilometers:	16,000	32,000	48,000	64,000	80,000	96,000	112,000	128,000	144,000	160,000	176,000	192,000	208,000	224,000	240,000
Additional Inspections															
Completely fill the Diesel Exhaust Fluid tank.	X	X	X	X	X	X	X	X	X	X	X	X	X	X	X
Inspect the CV/Universal joints.	X	X	X	X	X	X	X	X	X	X	X	X	X	X	X
Inspect front suspension, tie rod ends, and replace if necessary.		X		X		X		X		X		X		X	
Inspect the front and rear axle fluid. If gear oil leakage is suspected, check the fluid level. If using your vehicle for police, taxi, fleet, off-road or frequent trailer towing change the axle fluid.			X			X			X			X			X
Inspect the brake linings, parking brake function.		X		X		X		X		X		X		X	
Additional Maintenance															
Replace cabin air filter		X		X		X		X		X		X		X	
Drain water from fuel filter assembly.	X	X	X	X	X	X	X	X	X	X	X	X	X	X	X
Replace fuel filter and drain water from the fuel filter assembly. ¹	Fuel filter replacement intervals should be every second oil change and must not exceed 20,000 miles (32,000 km) if using diesel fuel up to B5.														

Mileage or time passed (whichever comes first)	10,000	20,000	30,000	40,000	50,000	60,000	70,000	80,000	90,000	100,000	110,000	120,000	130,000	140,000	150,000
	1	2	3	4	5	6	7	8	9	10	11	12	13	14	15
Or Kilometers:	16,000	32,000	48,000	64,000	80,000	96,000	112,000	128,000	144,000	160,000	176,000	192,000	208,000	224,000	240,000
Replace engine air cleaner.			X			X			X			X			X
Flush and replace the engine coolant at 10 years or 150,000 miles (240,000 km) whichever comes first.										X					X
Replace accessory drive belt(s).										X					
Inspect the transfer case fluid, change for any of the following: police, taxi, fleet, or frequent trailer towing.						X						X			
Change transfer case fluid.															X

- Under normal conditions the diesel fuel filter should be replaced every 20,000 miles (32,000 km) (every other oil change). If the vehicle is being used in severe operating conditions, or in certain geographical areas of the country (Pennsylvania, New York, Ohio, Maryland, West Virginia, Arkansas, Oklahoma, Kansas, Iowa, Missouri and Nebraska) due to fuel cleanliness issues, it's recommended to replace the fuel filter every 10,000 miles (16,000 km).

WARNING!

- You can be badly injured working on or around a motor vehicle. Do only service work for which you have the knowledge and the right equipment. If you have any doubt about your ability to perform a service job, take your vehicle to a competent mechanic.
- Failure to properly inspect and maintain your vehicle could result in a component malfunction and affect vehicle handling and performance. This could cause an accident.

ADDITIONAL MAINTENANCE — B6 To B20 BIODIESEL**NOTE:**

- Under no circumstances should oil change intervals exceed 8,000 miles (12,875 km) or six months, whichever comes first when using biodiesel blends greater than 5% (B5).
- The owner is required to monitor mileage for B6-B20 biodiesel, the automatic oil change indicator system does not reflect the use of biofuels.
- Fuel filter change interval is maintained at every second oil change. This is especially important with biodiesel usage.

For more information on using biodiesel
☞ page 472.

ENGINE COMPARTMENT

3.6L ENGINE WITH STOP/START

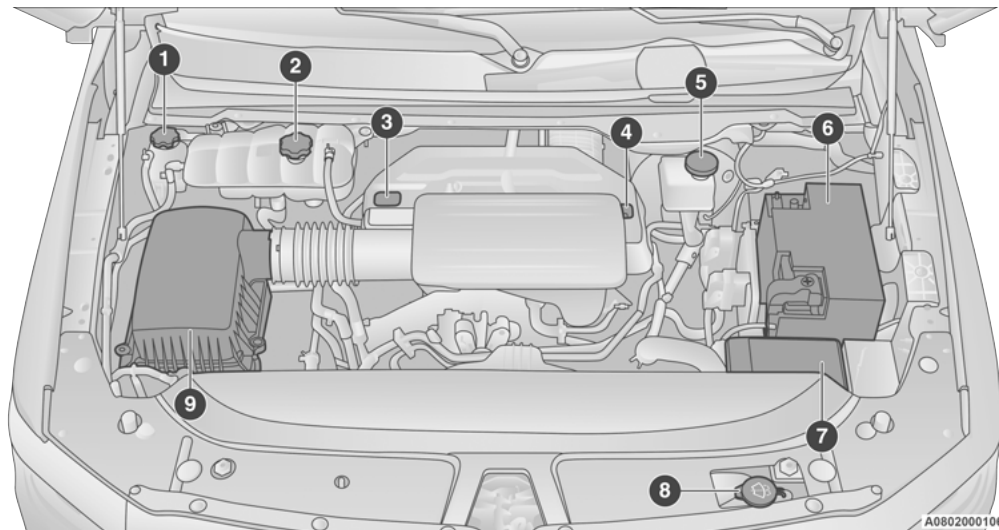

- 1 – Motor Generator Unit Coolant Reservoir Pressure Cap
- 2 – Engine Coolant Reservoir Pressure Cap
- 3 – Engine Oil Dipstick
- 4 – Engine Oil Fill
- 5 – Brake Fluid Reservoir

- 6 – Battery
- 7 – Power Distribution Center (Fuses)
- 8 – Washer Fluid Reservoir Cap
- 9 – Engine Air Cleaner Filter

5.7L ENGINE WITHOUT STOP/START

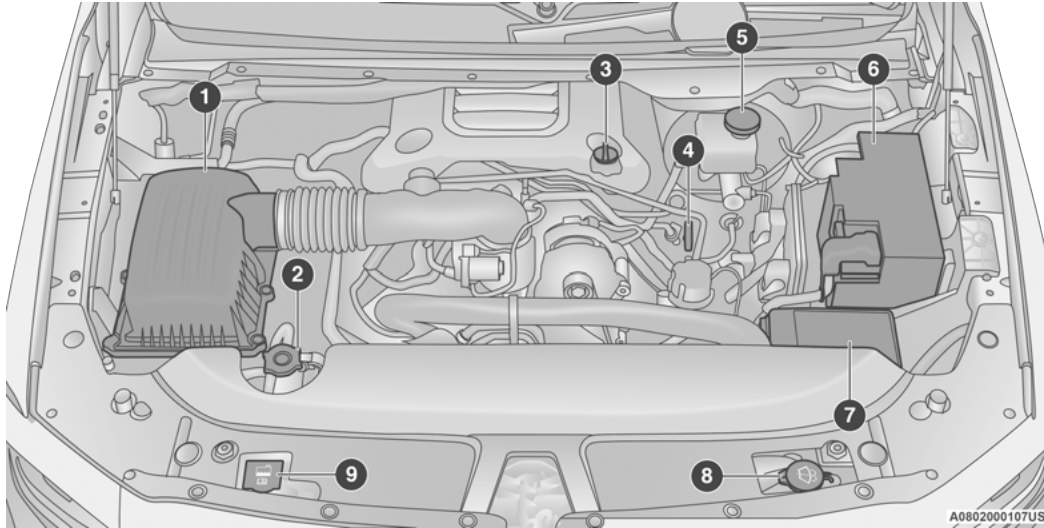

- 1 – Engine Air Cleaner Filter
- 2 – Engine Coolant Pressure Cap
- 3 – Engine Oil Fill
- 4 – Engine Oil Dipstick
- 5 – Brake Fluid Reservoir Cap

- 6 – Battery
- 7 – Power Distribution Center (Fuses)
- 8 – Washer Fluid Reservoir Cap
- 9 – Engine Coolant Reservoir Cap

5.7L ENGINE WITH STOP/START

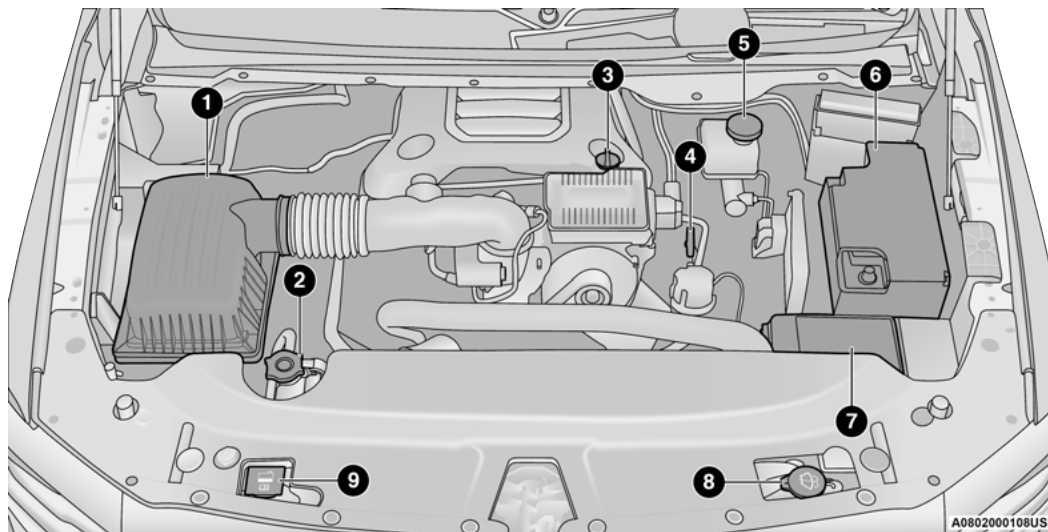

- 1 – Engine Air Cleaner Filter
- 2 – Engine Coolant Pressure Cap
- 3 – Engine Oil Fill
- 4 – Engine Oil Dipstick
- 5 – Brake Fluid Reservoir Cap

- 6 – Battery
- 7 – Power Distribution Center (Fuses)
- 8 – Washer Fluid Reservoir Cap
- 9 – Engine Coolant Reservoir Cap

3.0L DIESEL ENGINE

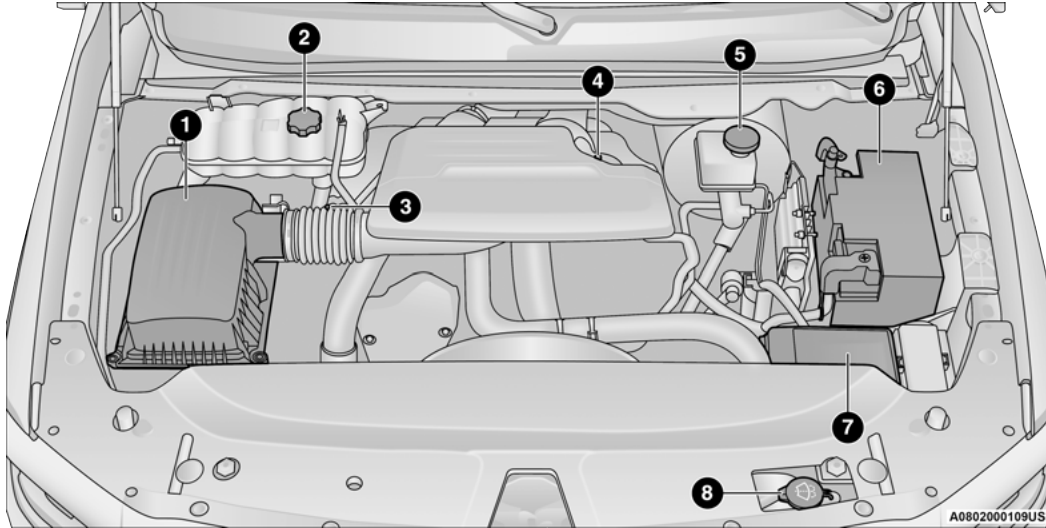

- 1 – Engine Air Cleaner Filter
- 2 – Engine Coolant Reservoir Pressure Cap
- 3 – Engine Oil Dipstick
- 4 – Engine Oil Fill

- 5 – Brake Fluid Reservoir Cap
- 6 – Battery
- 7 – Power Distribution Center (Fuses)
- 8 – Washer Fluid Reservoir Cap

CHECKING OIL LEVEL

To ensure proper engine lubrication, the engine oil must be maintained at the correct level.

Check the oil level at regular intervals, such as every fuel stop. The best time to check the engine oil level is about five minutes after a fully warmed up engine is shut off.

Checking the oil while the vehicle is on level ground will improve the accuracy of the oil level readings.

There are four possible dipstick types:

- Crosshatched zone.
- Crosshatched zone marked SAFE.
- Crosshatched zone marked with MIN at the low end of the range and MAX at the high end of the range.
- Crosshatched zone marked with dimples at the MIN and the MAX ends of the range.

NOTE:

Always maintain the oil level within the cross-hatch markings on the dipstick.

Adding 1 quart (1.0 liter) of oil when the reading is at the low end of the dipstick range will raise the oil level to the high end of the range marking.

CAUTION!

Overfilling or underfilling the crankcase will cause oil aeration or loss of oil pressure. This could damage your engine.

NOTE:

It is possible for your oil level to be slightly higher than a previous check. This would be due to diesel fuel that may temporarily be in the crankcase due to operation of the diesel particulate filter regeneration strategy (if equipped). This fuel will evaporate out under normal operation.

ADDING WASHER FLUID

The fluid reservoir is located under the hood and should be checked for fluid level at regular intervals. Fill the reservoir with windshield washer solvent only (not radiator antifreeze). When refilling the washer fluid reservoir, take some washer fluid and apply it to a cloth or towel and wipe the wiper blades clean. This will help blade performance.

To prevent freeze-up of your windshield washer system in cold weather, select a solution or mixture that meets or exceeds the temperature range of your climate. This rating information can be found on most washer fluid containers.

WARNING!

Commercially available windshield washer solvents are flammable. They could ignite and burn you. Care must be exercised when filling or working around the washer solution.

After the engine has warmed up, operate the defroster for a few minutes to reduce the possibility of smearing or freezing the fluid on the cold windshield. Windshield washer solution used with water as directed on the container, aids cleaning action, reduces the freezing point to avoid line clogging, and is not harmful to paint or trim.

MAINTENANCE-FREE BATTERY

Your vehicle is equipped with a maintenance-free battery. You will never have to add water, and periodic maintenance is not required.

WARNING!

- Battery fluid is a corrosive acid solution and can burn or even blind you. Do not allow battery fluid to contact your eyes, skin, or clothing. Do not lean over a battery when attaching clamps. If acid splashes in eyes or on skin, flush the area immediately with large amounts of water → page 386.
- Battery gas is flammable and explosive. Keep flame or sparks away from the battery. Do not use a booster battery or any other booster source with an output greater than 12 Volts. Do not allow cable clamps to touch each other.
- Battery posts, terminals, and related accessories contain lead and lead compounds. Wash hands after handling.

CAUTION!

- It is essential when replacing the cables on the battery that the positive cable is attached to the positive post and the negative cable is attached to the negative post. Battery posts are marked positive (+) and negative (-) and are identified on the battery case. Cable clamps should be tight on the terminal posts and free of corrosion.
- If a “fast charger” is used while the battery is in the vehicle, disconnect both vehicle battery cables before connecting the charger to the battery. Do not use a “fast charger” to provide starting voltage.

PRESSURE WASHING

Cleaning the engine compartment with a high pressure washer is not recommended.

CAUTION!

Precautions have been taken to safeguard all parts and connections however, the pressures generated by these machines is such that complete protection against water ingress cannot be guaranteed.

VEHICLE MAINTENANCE

An authorized dealer has the qualified service personnel, special tools, and equipment to perform all service operations in an expert manner. Service Manuals are available which include detailed service information for your vehicle. Refer to these Service Manuals before attempting any procedure yourself.

NOTE:

Intentional tampering with emissions control systems may void your warranty and could result in civil penalties being assessed against you.

WARNING!

You can be badly injured working on or around a motor vehicle. Only do service work for which you have the knowledge and the proper equipment. If you have any doubt about your ability to perform a service job, take your vehicle to a competent mechanic.

ENGINE OIL — GAS ENGINE

Engine Oil Selection — Gasoline Engine

For best performance and maximum protection under all types of operating conditions, FCA only recommends engine oils that are API Certified and meet the requirements of FCA Material Standard MS-6395.

NOTE:

Hemi engines (5.7L) at times can tick right after startup and then quiet down after approximately 30 seconds. This is normal and will not harm the engine. This characteristic can be caused by short drive cycles. For example, if the vehicle is started then shut off after driving a short distance. Upon restarting, you may experience a ticking sound. Other causes could be if the vehicle is unused for an extended period of time, incorrect oil, extended oil changes or extended idling. If the engine continues to tick or if the Malfunction Indicator Light (MIL) comes on, see the nearest authorized dealer.

Engine Oil Selection — Diesel Engine

For best performance and maximum protection under all types of operating conditions, FCA recommends engine oils that meet the requirements of FCA Material Standard

MS-12991, and that are API SN certified and meet the requirements of FCA LLC.

American Petroleum Institute (API) Engine Oil Identification Symbol



This symbol means that the oil has been certified by the American Petroleum Institute (API). The manufacturer only recommends API Certified engine oils.

This symbol certifies 0W-20, 5W-20, 0W-30, 5W-30 and 10W-30 engine oils.

CAUTION!

Do not use chemical flushes in your engine oil as the chemicals can damage your engine. Such damage is not covered by the New Vehicle Limited Warranty.

Synthetic Engine Oils

You may use synthetic engine oils provided the recommended oil quality requirements are met, and the recommended maintenance intervals for oil and filter changes are followed.

Synthetic engine oils which do not have both the engine oil certification mark and the correct SAE viscosity grade number should not be used.

Materials Added To Engine Oil

FCA strongly recommends against the addition of any additives (other than leak detection dyes) to the engine oil. Engine oil is an engineered product and its performance may be impaired by supplemental additives.

Disposing Of Used Engine Oil And Oil Filters

Care should be taken in disposing of used engine oil and oil filters from your vehicle. Used oil and oil filters, indiscriminately discarded, can present a problem to the environment. Contact an authorized dealer, service station or governmental agency for advice on how and where used oil and oil filters can be safely discarded in your area.

ENGINE OIL FILTER

The engine oil filter should be replaced with a new filter at every engine oil change.

Engine Oil Filter Selection

A full-flow type disposable oil filter should be used for replacement. The quality of replacement filters varies considerably. Only high quality Mopar certified filters should be used.

ENGINE AIR CLEANER FILTER

For the proper maintenance intervals
 ⇨ page 395.

NOTE:

Be sure to follow the “Severe Duty Conditions” maintenance interval if applicable.

WARNING!

The air induction system (air cleaner, hoses, etc.) can provide a measure of protection in the case of engine backfire. Do not remove the air induction system (air cleaner, hoses, etc.) unless such removal is necessary for repair or maintenance. Make sure that no one is near the engine compartment before starting the vehicle with the air induction system (air cleaner, hoses, etc.) removed. Failure to do so can result in serious personal injury.

Engine Air Cleaner Filter Selection

The quality of replacement filters varies considerably. Only high quality Mopar certified filters should be used.

Engine Air Cleaner Filter Inspection And Replacement

Inspect engine air cleaner filter for dirt and or debris, if you find evidence of either dirt or debris you should change your engine air cleaner filter.

Engine Air Cleaner Filter Removal

1. With suitable tool fully loosen (six) fasteners on the engine air cleaner filter cover.

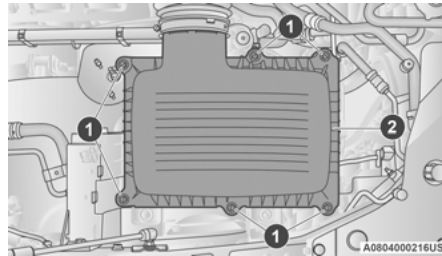

Engine Air Cleaner Filter

- 1 – Fasteners
 2 – Engine Air Cleaner Filter Cover

2. Lift the engine air cleaner filter cover to access the engine air cleaner filter.
3. Remove the engine air cleaner filter from the housing assembly.

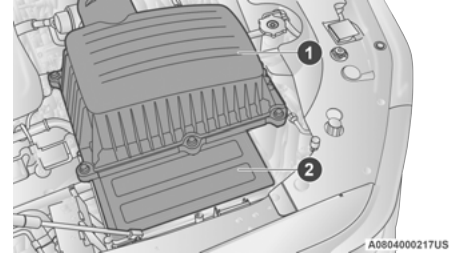

Engine Air Cleaner Filter

- 1 – Engine Air Cleaner Filter Cover
 2 – Engine Air Cleaner Filter

Engine Air Cleaner Filter Installation

NOTE:

Inspect and clean the housing if dirt or debris is present before replacing the engine air cleaner filter.

1. Install the engine air cleaner filter into the housing assembly with the engine air cleaner filter inspection surface facing downward.
2. Install the engine air cleaner filter cover onto the housing assembly.
3. Tighten the fasteners (six) on the engine air cleaner filter assembly.

DRAINING FUEL/WATER SEPARATOR FILTER — DIESEL ENGINE

The fuel/water separator filter housing is located inside the frame rail, behind the left front wheel. The best access to this water drain valve is from under the vehicle.

CAUTION!

- Do not drain the fuel/water separator filter when the engine is running.

(Continued)

CAUTION! (Continued)

- Diesel fuel will damage blacktop paving surfaces. Drain the filter into an appropriate container.

If water is detected in the water separator while the engine is running, or while the ignition switch is in the ON/RUN position, the “Water In Fuel Indicator Light” will illuminate and an audible chime will be heard. At this point, you should stop the engine and drain the water from the filter housing.

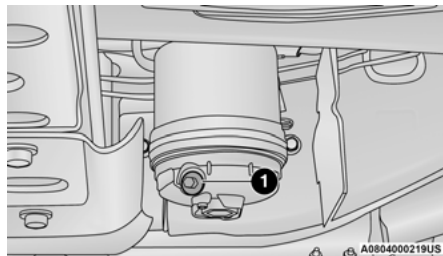

Fuel Filter Assembly

1 — Water In Fuel Drain Valve

CAUTION!

If the “Water In Fuel Indicator Light” remains on, DO NOT START the engine before you drain water from the fuel filter to avoid engine damage.

If the “Water In Fuel Indicator Light” comes on and a single chime is heard while you are driving, or with the ignition in the ON position, there may be a problem with your water separator wiring or sensor. See an authorized dealer for service.

Upon proper draining of the water from the fuel filter, the “Water In Fuel Indicator Light” will remain illuminated for approximately 10 seconds. If the water was drained while the engine was running, the “Water In Fuel Indicator Light” may remain on for approximately three minutes.

NOTE:

Care should be taken in disposing of used fluids from your vehicle. Used fluids, indiscriminately discarded, can present a problem to the environment. Contact an authorized dealer, service station, or government agency for advice on recycling programs and for where used fluids and filters can be properly disposed of in your area.

Drain the fuel/water separator filter when the “Water In Fuel Indicator Light” is ON. Within 10 minutes of vehicle shutdown, turn the filter drain valve (located on the bottom of the filter housing) counterclockwise to drain fuel/water, then turn the ignition switch to the ON position, and allow any accumulated water to drain. Leave the drain valve open until all water and contaminants have been removed. When clean fuel is visible, close the drain valve by turning it clockwise, and turn the ignition switch to OFF.

If more than two ounces or 60 milliliters of fuel have been drained → page 414.

UNDERBODY MOUNTED FUEL FILTER REPLACEMENT — DIESEL ENGINE

NOTE:

Using a fuel filter that does not meet FCA’s filtration and water separating requirements can severely impact fuel system life and reliability. Under normal conditions the diesel fuel filter should be replaced every 20,000 miles (every other oil change). If the vehicle is being used in severe operating conditions, or in certain geographical areas of the country (Pennsylvania, New York, Ohio, Maryland, West Virginia, Arkansas, Oklahoma, Kansas, Iowa, Missouri

and Nebraska) due to fuel cleanliness’ issues, it’s recommended to replace the fuel filter every 10,000 miles.

CAUTION!

- Diesel fuel will damage blacktop paving surfaces. Drain the filter into an appropriate container.
- Do not prefill the fuel filter when installing a new fuel filter. There is a possibility debris could be introduced into the fuel filter during this action. It is best to install the filter dry and allow the in-tank lift pump to prime the fuel system.

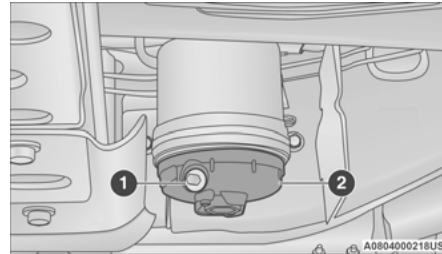

Fuel Filter Assembly

- 1 — Water In Fuel Drain Valve
2 — Fuel Filter Access

1. Turn engine off.
2. Place a drain pan under the fuel filter assembly.
3. Open the water drain valve, and let any accumulated water drain.
4. Close the water drain valve.
5. Remove bottom cover using a strap wrench. Rotate counterclockwise for removal. Remove the used o-ring and discard it.
6. Remove the used filter cartridge from the housing and dispose of it according to your local regulations.
7. Wipe the sealing surfaces of the lid and housing clean.
8. Install a new o-ring into the ring groove on the filter housing and lubricate with clean engine oil.

PRIMING IF THE ENGINE HAS RUN OUT OF FUEL — DIESEL ENGINE

WARNING!

Do not open the high pressure fuel system with the engine running. Engine operation causes high fuel pressure. High pressure fuel spray can cause serious injury or death.

1. Add a substantial amount of fuel to the tank, approximately 2 to 5 gal (8 L to 19 L).
2. Press ignition switch twice without your foot on brake to put vehicle in ON/RUN position. This will activate the in tank fuel pump for approximately 30 seconds. Repeat this process twice.
3. Start the engine using the "Normal Starting" procedure ⇨ page 144.

CAUTION!

The starter motor will engage for approximately 30 seconds at a time. Allow two minutes between cranking intervals.

NOTE:

The engine may run rough until the air is forced from all the fuel lines.

WARNING!

Do not use alcohol or gasoline as a fuel blending agent. They can be unstable under certain conditions and be hazardous or explosive when mixed with diesel fuel.

CAUTION!

Due to lack of lubricants in alcohol or gasoline, the use of these fuels can cause damage to the fuel system.

NOTE:

- Use of biodiesel mixture in excess of 20% can negatively impact the fuel filter's ability to separate water from the fuel, resulting in high pressure fuel system corrosion or damage.
- In addition, commercially available fuel additives are not necessary for the proper operation of your diesel engine.
- For extreme cold conditions, "Mopar Premium Diesel Fuel Treatment" is recommended to assist with cold starting.

INTERVENTION REGENERATION STRATEGY — MESSAGE PROCESS FLOW (DIESEL ENGINE)

This engine meets all required diesel engine emissions standards. To achieve these emissions standards, your vehicle is equipped with a state-of-the-art engine and exhaust system. These systems are seamlessly integrated into your vehicle and managed by the Powertrain Control Module (PCM). The PCM manages engine combustion to allow the exhaust system's catalyst to trap and burn Particulate Matter (PM) pollutants, with no input or interaction on your part.

Additionally, your vehicle has the ability to alert you to additional maintenance required on your vehicle or engine ⇨ page 114.

WARNING!

A hot exhaust system can start a fire if you park over materials that can burn, such as grass or leaves, and those items that come into contact with your exhaust system. Do not park or operate your vehicle in areas where your exhaust system can contact anything that can burn.

DIESEL EXHAUST FLUID

Diesel Exhaust Fluid (DEF) sometimes known simply by the name of its active component, UREA—is a key component of Selective Catalytic Reduction (SCR) systems, which help diesel vehicles meet stringent emission regulations. DEF is a liquid reducing agent that reacts with engine exhaust in the presence of a catalyst to convert smog-forming nitrogen oxides (NOx) into harmless nitrogen and water vapor.

Refer to Engine Fluids And Lubricants
 ⇨ page 475 for further information.

AIR CONDITIONER MAINTENANCE

For best possible performance, your air conditioner should be checked and serviced by an authorized dealer at the start of each warm season. This service should include cleaning of the condenser fins and a performance test. Drive belt tension should also be checked at this time.

WARNING!

- Use only refrigerants and compressor lubricants approved by FCA for your air conditioning system. Some unapproved refrigerants are flammable and can explode, injuring you. Other unapproved refrigerants or lubricants can cause the system to fail, requiring costly repairs. Refer to Warranty Information Book, for further warranty information.
- The air conditioning system contains refrigerant under high pressure. To avoid risk of personal injury or damage to the system, adding refrigerant or any repair requiring lines to be disconnected should be done by an experienced technician.

CAUTION!

Do not use chemical flushes in your air conditioning system as the chemicals can damage your air conditioning components. Such damage is not covered by the New Vehicle Limited Warranty.

Refrigerant Recovery And Recycling — R-1234yf

R-1234yf Air Conditioning Refrigerant is a hydrofluoroolefin (HFO) that is endorsed by the Environmental Protection Agency and is an ozone-friendly substance with a low global-warming potential. It is recommended that air conditioning service be performed by an authorized dealer using recovery and recycling equipment.

NOTE:

Use only FCA approved A/C system PAG compressor oil, and refrigerants.

Cabin Filter Replacement (A/C Air Filter)

For the proper maintenance intervals
 ⇨ page 395.

WARNING!

Do not remove the cabin air filter while the vehicle is running, or while the ignition is in the ACC or ON/RUN mode. With the cabin air filter removed and the blower operating, the blower can contact hands and may propel dirt and debris into your eyes, resulting in personal injury.

The cabin air filter is located in the fresh air inlet behind the glove compartment. Perform the following procedure to replace the filter:

1. Open the glove compartment and remove all contents.
2. With the glove compartment door open, remove the glove compartment tension tether and tether clip by sliding the clip toward the face of the glove compartment door. Lift the clip out of glove compartment door and release into dash panel.

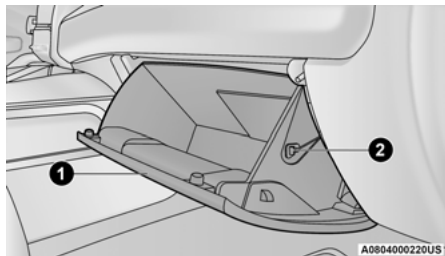

Right Side Of Glove Compartment

- 1 – Glove Compartment Door
- 2 – Glove Compartment Tension Tether

3. There are glove compartment travel stops on both sides of the glove compartment door. Push inward on both sides of the glove compartment to release the glove compartment travel stops.

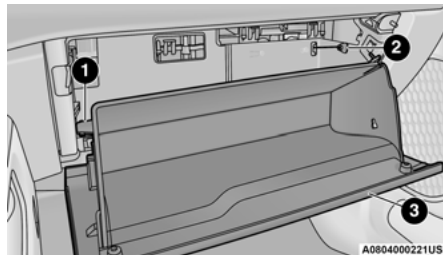

Glove Compartment

- 1 – Glove Compartment Travel Stop
- 2 – Glove Compartment Tension Tether
- 3 – Glove Compartment Door

4. Disengage the glove compartment door from its hinges by opening the glove compartment past the travel stop and pulling it toward you.

5. Remove the filter cover by pushing in on the finger tabs on each end of the filter cover.

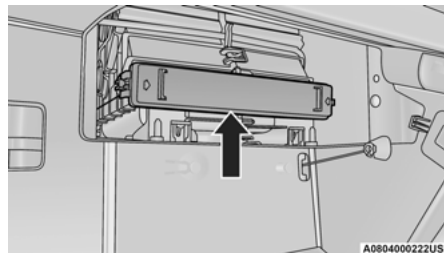

Filter Cover

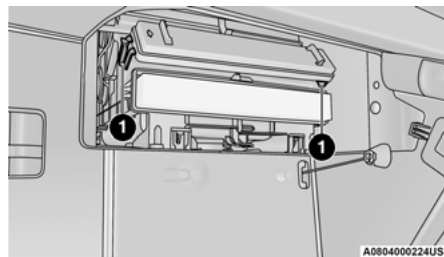

Filter Cover Removal

- 1 – Finger Tabs

6. Remove the cabin air filter by pulling it straight out of the housing.

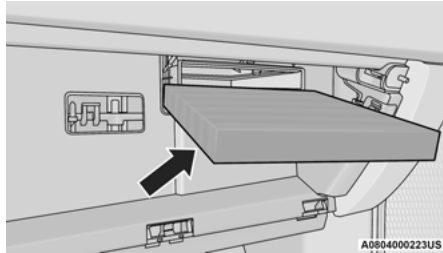

Cabin Air Filter

7. Install the cabin air filter with the arrow on the filter pointing toward the floor. When installing the filter cover, press on each end until you hear an audible click.

CAUTION!

The cabin air filter is identified with an arrow to indicate airflow direction through the filter. Failure to properly install the filter will result in the need to replace it more often.

8. Reinstall the glove compartment on the hinges.

9. Pull the tension tether outward and reinstall the glove compartment past the travel stops by pushing in on the glove compartment sides.

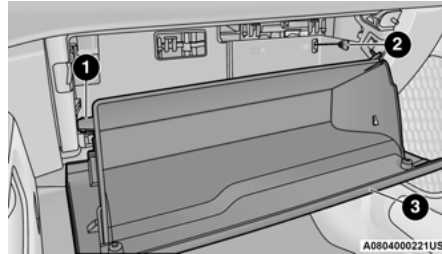

Glove Compartment

- 1 – Glove Compartment Travel Stop
2 – Glove Compartment Tension Tether
3 – Glove Compartment Door

NOTE:

Ensure the glove compartment door hinges and glove compartment travel stops are fully engaged.

10. Reattach the glove compartment tension tether by inserting the tether clip in the glove compartment and sliding the clip away from the face of the glove compartment door.

ACCESSORY DRIVE BELT INSPECTION

WARNING!

- Do not attempt to inspect an accessory drive belt with vehicle running.
- When working near the radiator cooling fan, disconnect the fan motor lead. The fan is temperature controlled and can start at any time regardless of ignition mode. You could be injured by the moving fan blades.
- You can be badly injured working on or around a motor vehicle. Only do service work for which you have the knowledge and the proper equipment. If you have any doubt about your ability to perform a service job, take your vehicle to a competent mechanic.

When inspecting accessory drive belts, small cracks that run across the ribbed surface of the belt from rib to rib, are considered normal. This is not a reason to replace the belt. However, cracks running along a rib (not across) are not normal. Any belt with cracks running along a rib must be replaced. Also have the belt replaced if it has excessive wear, frayed cords or severe glazing.

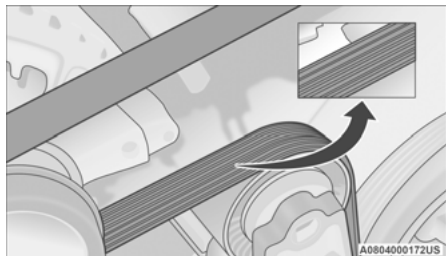

Accessory Belt (Serpentine Belt)

Conditions that would require replacement:

- Rib chunking (one or more ribs has separated from belt body)
- Rib or belt wear
- Longitudinal belt cracking (cracks between two ribs)
- Belt slips
- "Groove jumping" (belt does not maintain correct position on pulley)
- Belt broken
- Noise (objectionable squeal, squeak, or rumble is heard or felt while drive belt is in operation)

NOTE:

Identify and correct problem before new belt is installed.

NOTE:

If your vehicle is equipped with a Stop/Start, belt must be replaced with an OEM grade Mopar belt.

Some conditions can be caused by a faulty component such as a belt pulley. Belt pulleys should be carefully inspected for damage and proper alignment.

Belt replacement on some models requires the use of special tools, we recommend having your vehicle serviced at an authorized dealer.

BODY LUBRICATION

Locks and all body pivot points, including such items as seat tracks, door hinge pivot points and rollers, liftgate, tailgate, decklid, sliding doors and hood hinges, should be lubricated periodically. Use a lithium-based grease, such as Mopar Spray White Lube to assure quiet, easy operation and to protect against rust and wear. Prior to the application of any lubricant, the parts concerned should be wiped clean to remove dust and grit; after lubricating excess oil and grease should be removed. Particular

attention should also be given to hood latching components to ensure proper function. When performing other underhood services, the hood latch release mechanism, and safety catch should be cleaned and lubricated.

The external lock cylinders should be lubricated twice a year, preferably in the Autumn and Spring. Apply a small amount of a high quality lubricant, such as Mopar Lock Cylinder Lubricant directly into the lock cylinder.

WINDSHIELD WIPER BLADES

Clean the rubber edges of the wiper blades and the windshield periodically with a sponge or soft cloth and a mild nonabrasive cleaner. This will remove accumulations of salt or road film.

Operation of the wipers on dry glass for long periods may cause deterioration of the wiper blades. Always use washer fluid when using the wipers to remove salt or dirt from a dry windshield.

Avoid using the wiper blades to remove frost or ice from the windshield. Keep the blade rubber out of contact with petroleum products such as engine oil, gasoline, etc.

NOTE:

Life expectancy of wiper blades varies depending on geographical area and frequency of use. If chattering, marks, water lines or wet spots are present, clean the wiper blades or replace as necessary.

The wiper blades and wiper arms should be inspected periodically, not just when wiper performance problems are experienced. This inspection should include the following points:

- Wear or uneven edges
- Foreign material
- Hardening or cracking
- Deformation or fatigue

If a wiper blade or wiper arm is damaged, replace the affected wiper arm or blade with a new unit. Do not attempt to repair a wiper arm or blade that is damaged.

Wiper Blade Removal/Installation**CAUTION!**

Do not allow the wiper arm to spring back against the glass without the wiper blade in place or the glass may be damaged.

1. Lift the wiper arm to raise the wiper blade off of the glass, until the wiper arm is in the full up position.

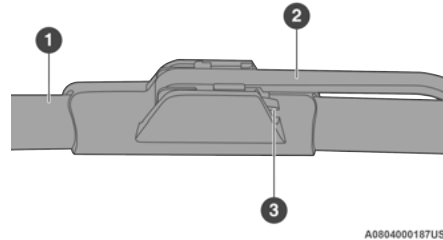
**Wiper Blade With Release Tab In Locked Position**

- 1 – Wiper Blade
- 2 – Wiper Arm
- 3 – Release Tab

2. To disengage the wiper blade from the wiper arm, press the release tab on the wiper blade and while holding the wiper arm with one hand, slide the wiper blade down towards the base of the wiper arm.

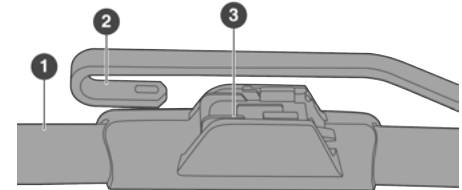

A0804000186US

Wiper Blade With Release Tab In Unlocked Position

- 1 – Wiper Blade
- 2 – Wiper Arm J Hook
- 3 – J Hook Retainer

3. With the wiper blade disengaged, remove the wiper blade from the wiper arm.
4. Gently lower the wiper arm onto the glass.

Installing The Front Wipers

1. Lift the wiper arm off of the glass, until the wiper arm is in the full up position.
2. Position the wiper blade near the hook on the tip of the wiper arm.
3. Slide the wiper blade up into the hook on the wiper arm, latch engagement will be accompanied by an audible click.
4. Gently lower the wiper blade onto the glass.

EXHAUST SYSTEM

The best protection against carbon monoxide entry into the vehicle body is a properly maintained engine exhaust system.

If you notice a change in the sound of the exhaust system; or if the exhaust fumes can be detected inside the vehicle; or when the underside or rear of the vehicle is damaged; have an authorized technician inspect the complete exhaust system and adjacent body areas for broken, damaged, deteriorated, or mispositioned parts. Open seams or loose connections could permit exhaust fumes to seep into the passenger compartment. In addition, have the exhaust system inspected

each time the vehicle is raised for lubrication or oil change. Replace as required.

WARNING!

- Exhaust gases can injure or kill. They contain carbon monoxide (CO), which is colorless and odorless. Breathing it can make you unconscious and can eventually poison you. To avoid breathing CO see [page 369](#).
- A hot exhaust system can start a fire if you park over materials that can burn. Such materials might be grass or leaves coming into contact with your exhaust system. Do not park or operate your vehicle in areas where your exhaust system can contact anything that can burn.

CAUTION!

- The catalytic converter requires the use of unleaded fuel only. Leaded gasoline will destroy the effectiveness of the catalyst as an emissions control device and may seriously reduce engine performance and cause serious damage to the engine.

(Continued)

CAUTION! *(Continued)*

- Damage to the catalytic converter can result if your vehicle is not kept in proper operating condition. In the event of engine malfunction, particularly involving engine misfire or other apparent loss of performance, have your vehicle serviced promptly. Continued operation of your vehicle with a severe malfunction could cause the converter to overheat, resulting in possible damage to the converter and vehicle.

Under normal operating conditions, the catalytic converter will not require maintenance. However, it is important to keep the engine properly tuned to assure proper catalyst operation and prevent possible catalyst damage.

NOTE:

Intentional tampering with emissions control systems can result in civil penalties being assessed against you.

In unusual situations involving grossly malfunctioning engine operation, a scorching odor may suggest severe and abnormal catalyst

overheating. If this occurs, stop the vehicle, turn off the engine and allow it to cool. Service, including a tune-up to manufacturer's specifications, should be obtained immediately.

To minimize the possibility of catalytic converter damage:

- Do not interrupt the ignition when the transmission is in gear and the vehicle is in motion.
- Do not try to start the vehicle by pushing or towing the vehicle.
- Do not idle the engine with any ignition components disconnected or removed, such as when diagnostic testing, or for prolonged periods during very rough idle or malfunctioning operating conditions.

COOLING SYSTEM

WARNING!

- You or others can be badly burned by hot engine coolant (antifreeze) or steam from your radiator. If you see or hear steam coming from under the hood, do not open the hood until the radiator has had time to cool. Never open a cooling system pressure cap when the radiator or coolant bottle is hot.
- Keep hands, tools, clothing, and jewelry away from the radiator cooling fan when the hood is raised. The fan starts automatically and may start at any time, whether the engine is running or not.
- When working near the radiator cooling fan, disconnect the fan motor lead or turn the ignition to the OFF mode. The fan is temperature controlled and can start at any time the ignition is in the ON mode.

Engine Coolant Checks

Check the engine coolant (antifreeze) protection every 12 months (before the onset of freezing weather, where applicable). If the engine coolant is dirty or rusty in appearance, the system should be drained, flushed and refilled with fresh coolant. Check the front of the A/C condenser (if equipped) or radiator for any accumulation of bugs, leaves, etc. If dirty, clean by gently spraying water from a garden hose vertically down the face of the A/C condenser (if equipped) or the back of the radiator core.

Check the engine cooling system hoses for brittle rubber, cracking, tears, cuts and tightness of the connection at the coolant recovery bottle and radiator. Inspect the entire system for leaks.

DO NOT REMOVE THE COOLANT PRESSURE CAP WHEN THE COOLING SYSTEM IS HOT.

Cooling System – Drain, Flush And Refill

NOTE:

Some vehicles require special tools to add coolant properly. Failure to fill these systems properly could lead to severe internal engine damage. If any coolant is needed to be added to the system please contact an authorized dealer.

If the engine coolant (antifreeze) is dirty or contains visible sediment, have an authorized dealer clean and flush with OAT coolant (conforming to MS.90032).

For the proper maintenance intervals
 ⇨ page 395.

Selection Of Coolant

For further information ⇨ page 475.

NOTE:

- Mixing of engine coolant (antifreeze) other than specified Organic Additive Technology (OAT) engine coolant, may result in engine damage and may decrease corrosion protection. OAT engine coolant is different and should not be mixed with Hybrid Organic Additive Technology (HOAT) engine coolant or any “globally compatible” coolant. If a

non-OAT engine coolant is introduced into the cooling system in an emergency, the cooling system will need to be drained, flushed, and refilled with fresh OAT coolant (conforming to MS.90032), by an authorized dealer as soon as possible.

- Do not use water alone or alcohol-based engine coolant products. Do not use additional rust inhibitors or anti-rust products, as they may not be compatible with the radiator engine coolant and may plug the radiator.
- This vehicle has not been designed for use with propylene glycol-based engine coolant. Use of propylene glycol-based engine coolant is not recommended.
- Some vehicles require special tools to add coolant properly. Failure to fill these systems properly could lead to severe internal engine damage. If any coolant is needed to be added to the system please contact an authorized dealer.

Adding Coolant

Your vehicle has been built with an improved engine coolant (OAT coolant conforming to MS.90032) that allows extended maintenance intervals. This engine coolant (antifreeze) can

be used up to 10 years or 150,000 miles (240,000 km) before replacement. To prevent reducing this extended maintenance period, it is important that you use the same engine coolant (OAT coolant conforming to MS.90032) throughout the life of your vehicle.

Please review these recommendations for using Organic Additive Technology (OAT) engine coolant that meets the requirements of FCA Material Standard MS.90032. When adding engine coolant:

- We recommend using Mopar® Antifreeze/Coolant 10 Year/150,000 Mile (240,000 km) Formula OAT that meets the requirements of FCA Material Standard MS.90032.
- Mix a minimum solution of 50% OAT engine coolant that meets the requirements of FCA Material Standard MS.90032 and distilled water. Use higher concentrations (not to exceed 70%) if temperatures below -34°F (-37°C) are anticipated. Please contact an authorized dealer for assistance.
- Use only high purity water such as distilled or deionized water when mixing the water/engine coolant solution. The use of lower quality water will reduce the amount of corrosion protection in the engine cooling system.

NOTE:

- It is the owner's responsibility to maintain the proper level of protection against freezing according to the temperatures occurring in the area where the vehicle is operated.
- Some vehicles require special tools to add coolant properly. Failure to fill these systems properly could lead to severe internal engine damage. If any coolant is needed to be added to the system, please contact an authorized dealer.
- Mixing engine coolant types is not recommended and can result in cooling system damage. If HOAT and OAT coolant are mixed in an emergency, have an authorized dealer drain, flush, and refill with OAT coolant (conforming to MS.90032) as soon as possible.

Cooling System Pressure Cap

The cap must be fully tightened to prevent loss of engine coolant (antifreeze), and to ensure that engine coolant will return to the radiator from the coolant expansion bottle/recovery tank (if equipped).

The cap should be inspected and cleaned if there is any accumulation of foreign material on the sealing surfaces.

WARNING!

- Do not open hot engine cooling system. Never add engine coolant (antifreeze) when the engine is overheated. Do not loosen or remove the cap to cool an overheated engine. Heat causes pressure to build up in the cooling system. To prevent scalding or injury, do not remove the pressure cap while the system is hot or under pressure.
- Do not use a pressure cap other than the one specified for your vehicle. Personal injury or engine damage may result.

Disposal Of Used Coolant

Used ethylene glycol-based coolant (antifreeze) is a regulated substance requiring proper disposal. Check with your local authorities to determine the disposal rules for your community. To prevent ingestion by animals or children, do not store ethylene glycol-based coolant in open containers or allow it to remain in puddles on the ground, clean up any ground spills immediately. If ingested, seek emergency assistance immediately.

Checking Coolant Level — 3.6L Engine

The level of the coolant in the pressurized coolant bottle should be between the "MIN" and "MAX" range on the bottle when the engine is cold.

The radiator normally remains completely full, so there is no need to remove the cap unless checking for coolant freeze point or replacing engine coolant (antifreeze). Advise your service attendant of this. As long as the engine operating temperature is satisfactory, the coolant bottle need only be checked once a month. When additional engine coolant is needed to maintain the proper level, it should be added to the coolant bottle. Do not overfill.

Checking Coolant Level — 5.7L Engines

With the engine off and cold, the level of the engine coolant should be between the ADD and SAFE range on the dipstick.

To check the coolant level:

1. Open the coolant reservoir.
2. Lift and remove the plastic dipstick from the reservoir neck.

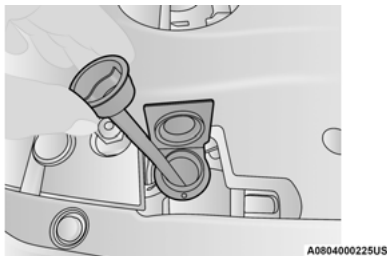

Coolant Reservoir Dipstick

3. Check the coolant level on the dipstick.

The radiator normally remains completely full, so there is no need to remove the radiator cap unless checking for engine coolant (antifreeze) freeze point or replacing engine coolant. Advise your service attendant of this. As long as the engine operating temperature is satisfactory, the coolant bottle need only be checked once a month.

When additional engine coolant is needed to maintain the proper level, it should be added to the coolant bottle. Do not overfill.

Cooling System Notes

NOTE:

When the vehicle is stopped after a few miles/kilometers of operation, you may observe vapor coming from the front of the engine compartment. This is normally a result of moisture from rain, snow, or high humidity accumulating on the radiator and being vaporized when the thermostat opens, allowing hot engine coolant (antifreeze) to enter the radiator.

If an examination of your engine compartment shows no evidence of radiator or hose leaks, the vehicle may be safely driven. The vapor will soon dissipate.

- Do not overfill the coolant expansion bottle.
- Check the coolant freeze point in the radiator and in the coolant expansion bottle. If engine coolant needs to be added, the contents of the coolant expansion bottle must also be protected against freezing.
- If frequent engine coolant additions are required, the cooling system should be pressure tested for leaks.

- Maintain engine coolant concentration at a minimum of 50% OAT coolant (conforming to MS.90032) and distilled water for proper corrosion protection of your engine which contains aluminum components.
- Make sure that the coolant expansion bottle overflow hoses are not kinked or obstructed.
- Keep the front of the radiator clean. If your vehicle is equipped with air conditioning, keep the front of the condenser clean.
- Do not change the thermostat for Summer or Winter operation. If replacement is ever necessary, install **ONLY** the correct type thermostat. Other designs may result in unsatisfactory engine cooling performance, poor gas mileage, and increased emissions.

CHARGE AIR COOLER — INTER-COOLER (DIESEL ENGINE)

The charge air cooler is positioned in front of the radiator and the air conditioner condenser. Air enters the engine through the air cleaner and passes through the turbocharger, where it is pressurized. This pressurized air rapidly reaches high temperature. The air is then directed through a hose to the charge air cooler

and through another hose to the intake manifold of the engine. This cooling process enables more efficient burning of fuel resulting in fewer emissions.

To guarantee optimum performance of the system, keep the surfaces of the charge air cooler, condenser and radiator clean and free of debris. Periodically check the hoses leading to and from the charge air cooler for cracks or loose clamps resulting in loss of pressure and reduced engine performance.

BRAKE SYSTEM

In order to ensure brake system performance, all brake system components should be inspected periodically ⇨ page 395.

WARNING!

Riding the brakes can lead to brake failure and possibly a collision. Driving with your foot resting or riding on the brake pedal can result in abnormally high brake temperatures, excessive lining wear, and possible brake damage. You would not have your full braking capacity in an emergency.

Fluid Level Check — Brake Master Cylinder

The fluid level of the brake master cylinder should be checked whenever the vehicle is serviced, or immediately if the brake system warning light is on. If necessary, add fluid to bring level within the designated marks on the side of the reservoir of the brake master cylinder. Be sure to clean the top of the master cylinder area before removing cap. With disc brakes, fluid level can be expected to fall as the brake pads wear. Brake fluid level should be checked when pads are replaced. If the brake fluid is abnormally low, check the system for leaks ⇨ page 478.

WARNING!

- Use only manufacturer's recommended brake fluid ⇨ page 478. Using the wrong type of brake fluid can severely damage your brake system and/or impair its performance. The proper type of brake fluid for your vehicle is also identified on the original factory installed hydraulic master cylinder reservoir.

(Continued)

WARNING! *(Continued)*

- To avoid contamination from foreign matter or moisture, use only new brake fluid or fluid that has been in a tightly closed container. Keep the master cylinder reservoir cap secured at all times. Brake fluid in a open container absorbs moisture from the air resulting in a lower boiling point. This may cause it to boil unexpectedly during hard or prolonged braking, resulting in sudden brake failure. This could result in a collision.
- Overfilling the brake fluid reservoir can result in spilling brake fluid on hot engine parts, causing the brake fluid to catch fire. Brake fluid can also damage painted and vinyl surfaces, care should be taken to avoid its contact with these surfaces.
- Do not allow petroleum based fluid to contaminate the brake fluid. Brake seal components could be damaged, causing partial or complete brake failure. This could result in a collision.

AUTOMATIC TRANSMISSION

Special Additives

FCA strongly recommends against using any special additives in the transmission. Automatic Transmission Fluid (ATF) is an engineered product and its performance may be impaired by supplemental additives. Therefore, do not add any fluid additives to the transmission. Avoid using transmission sealers as they may adversely affect seals.

CAUTION!

Do not use chemical flushes in your transmission as the chemicals can damage your transmission components. Such damage is not covered by the New Vehicle Limited Warranty.

Fluid Level Check

The fluid level is preset at the factory and does not require adjustment under normal operating conditions. Routine fluid level checks are not required, therefore the transmission has no dipstick. An authorized dealer can check your transmission fluid level using special service tools.

If you notice fluid leakage or transmission malfunction, visit an authorized dealer immediately to have the transmission fluid level checked. Operating the vehicle with an improper fluid level can cause severe transmission damage.

CAUTION!

If a transmission fluid leak occurs, visit an authorized dealer immediately. Severe transmission damage may occur. An authorized dealer has the proper tools to adjust the fluid level accurately.

Fluid And Filter Changes

Under normal operating conditions, the fluid installed at the factory will provide satisfactory lubrication for the life of the vehicle.

Routine fluid and filter changes are not required. However, change the fluid and filter if the fluid becomes contaminated (with water, etc.), or if the transmission is disassembled for any reason.

Selection Of Lubricant

It is important to use the proper transmission fluid to ensure optimum transmission

performance and life. Use only the recommended transmission fluid ⇨ page 478. It is important to maintain the transmission fluid at the correct level using the recommended fluid. No chemical flushes should be used in any transmission; only the approved lubricant should be used.

CAUTION!

Using a transmission fluid other than the manufacturer's recommended fluid may cause deterioration in transmission shift quality and/or torque converter shudder ⇨ page 478.

REAR AXLE AND 4x4 FRONT DRIVING AXLE FLUID LEVEL

For normal service, periodic fluid level checks are not required. When the vehicle is serviced for other reasons the exterior surfaces of the axle assembly should be inspected. If gear oil leakage is suspected inspect the fluid level ⇨ page 478. This inspection should be made with the vehicle in a level position.

The fluid level should be even with the bottom of the fill hole (within 1/4 in (6.4 mm) of edge of hole) for the front axle and rear axle.

Drain And Refill

For the proper maintenance intervals
 ⇨ page 395.

Lubricant Selection

For further information ⇨ page 478.

NOTE:

The presence of water in the gear lubricant will result in corrosion and possible failure of differential components. Operation of the vehicle in water, as may be encountered in some off-highway types of service, will require draining and refilling the axle to avoid damage.

Limited-Slip Differentials

Rear axles equipped with a Limited Slip Differential require that 5 oz. (148 ml) Mopar Limited Slip Additive be added to the gear lubricant ⇨ page 478. The Mopar Limited Slip Additive should be added to the gear lubricant whenever a fluid change is made to an axle equipped with a Limited Slip Differential.

NOTE:

When refilling a limited slip differential axle which requires a friction modification additive, the additive should be added before the gear lubricant to ensure proper additive fill.

TRANSFER CASE

Fluid Level Check

This fluid level can be checked by removing the filler plug. The fluid level should be to the bottom edge of the filler plug hole (or within 1/8 inch of the bottom) with the vehicle in a level position.

Drain And Refill

For the proper maintenance intervals
 ⇨ page 395.

Selection Of Lubricant

Use only the recommended fluid ⇨ page 478.

FUSES

General Information

WARNING!

- When replacing a blown fuse, always use an appropriate replacement fuse with the same amp rating as the original fuse. Never replace a fuse with another fuse of higher amp rating. Never replace a blown fuse with metal wires or any other material. Do not place a fuse inside a circuit breaker cavity or vice versa. Failure to use proper fuses may result in serious personal injury, fire and/or property damage.
- Before replacing a fuse, make sure that the ignition is off and that all the other services are switched off and/or disengaged.
- If the replaced fuse blows again, contact an authorized dealer.
- If a general protection fuse for safety systems (air bag system, braking system), power unit systems (engine system, transmission system) or steering system blows, contact an authorized dealer.

CAUTION!

If it is necessary to wash the engine compartment, take care not to directly hit the fuse box, and the windshield wiper motors with water.

The fuses protect electrical systems against excessive current.

When a device does not work, you must check the fuse element inside the blade fuse for a break/melt.

Also, please be aware that when using power outlets for extended periods of time with the engine off may result in vehicle battery discharge.

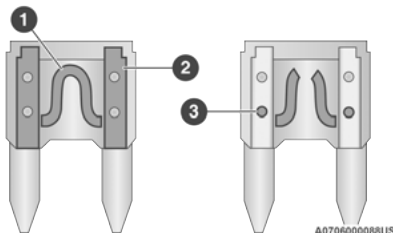
**Blade Fuses**

- 1 – Fuse Element
- 2 – Blade Fuse with a good/functional fuse element
- 3 – Blade fuse with a bad/not functional fuse element (blown fuse)

External Power Distribution Center

The Power Distribution Center is located in the engine compartment near the battery. This center contains cartridge fuses, micro fuses, relays, and circuit breakers. A description of each fuse and component may be stamped on the inside cover, otherwise the cavity number of each fuse is stamped on the inside cover that corresponds to the following chart.

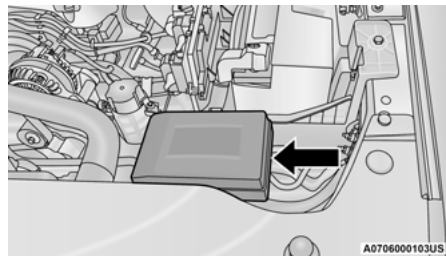
**Power Distribution Center**

Cavity	Cartridge Fuse	Micro Fuse	Description
F01	-	25 Amp Clear	Fuel Pump Motor
F03	-	5 Amp Tan	MGU
F04	-	-	Spare
F05	-	-	Spare

Cavity	Cartridge Fuse	Micro Fuse	Description
F06	-	10 Amp Red	OUTPUT TO UPFITTER PDC – If Equipped
F07	-	-	Spare
F08	20 Amp Blue	-	Trailer Tow Backup
F09	-	20 Amp Yellow	Trailer Stop / Turn Lamp Left
F10	-	20 Amp Yellow	Trailer Stop / Turn Lamp Right
F11	-	15 Amp Blue	ID/CLEARANCE LIGHTS – If Equipped
F12	20 Amp Blue	-	Trailer Tow Park Lamp
F13	-	-	Spare
F14	-	10 Amp Red	AC Clutch
F15	-	5 Amp Tan	Intelligent Battery Sensor (IBS)
F16	-	-	Spare
F17	-	20 Amp Yellow	Air Suspension
F18	-	15 Amp Blue	AGS / Rear Axle Cooling Valve / Active Air Dam
F19	-	-	Spare
F20	-	20 Amp Yellow	Adjustable Pedals
F21	30 Amp Pink	-	Power Side Step
F22	50 Amp Red	-	Air Module
F23	-	-	Spare
F24	-	20 Amp Yellow	TCM SBW
F25	40 Amp Green	-	Exterior Lights 2

Cavity	Cartridge Fuse	Micro Fuse	Description
F26	50 Amp Red	-	ESP Module
F27	30 Amp Pink	-	Front Wiper
F28	-	10 Amp Red	PCM / ECM
F29	40 Amp Green	-	ESP Module
F30	-	-	Spare
F31	-	-	Spare
F32	20 Amp Blue	-	ECM / PCM
F33	30 Amp Pink	-	Brake Vacuum Pump
F34	-	-	Spare
F35	-	10 Amp Red	PCM / ECM / Power Pack Unit (PPU) Motor Generator Unit (MGU) Wake Up / EPS / Active Tuned Mass Module (ATMM) / ESP
F36	-	-	Spare
F37	-	5 Amp Tan	R / S Output to iPDC
F38	-	10 Amp Red	DTCM / Active CL TEMP VLV
F39	-	15 Amp Red	MOD ATMM
F40	40 Amp Green	-	Starter
F41	-	10 Amp Red	IRCAM Heaters
F42	20 Amp Blue	-	AUX SWITCH #5 – If Equipped
F43	-	20 Amp Yellow	MGU Coolant Pump
F44	-	10 Amp Red	Trailer Camera
F45	-	10 Amp Red	ADCM – If Equipped

Cavity	Cartridge Fuse	Micro Fuse	Description
F46	30 Amp Pink	-	Fuel Heater
F47	30 Amp Pink	-	Rear Defroster
F48	-	-	Spare
F49	30 Amp Pink	-	Htr Ctrl (Diesel Only)
F50	20 Amp Blue	-	AUX SWITCH #6 – If Equipped
F51	25 Amp White	-	FUEL PUMP MOTOR #1 – If Equipped
F52	-	-	Spare
F53	-	10 Amp Red	Supply / Purging Pump – If Equipped
F54	-	15 Amp Blue	PCM
F55	-	15 Amp Blue	Right HID Headlamp
F56	-	-	Spare
F57	-	20 Amp Yellow	Horn
F58	25 Amp White	-	FUEL PUMP MOTOR #2 – If Equipped
F59	-	25 Amp Clear	Injectors / IGN Coil / Glow Plug Module
F60	-	20 Amp Yellow	ECM / PCM / ACT Short Running Valve
F61	-	15 Amp Blue	Left HID Headlamp / Spare
F62	60 Amp Blue 40 Amp Green	-	Glow Plug (DSL) / LTR Coolant Pump (TRX)
F63	20 Amp Blue	-	NOx Sensor
F64	-	10 Amp Red	PM Sensor – If Equipped

CAUTION!

- When installing the power distribution center cover, it is important to ensure the cover is properly positioned and fully latched. Failure to do so may allow water to get into the power distribution center and possibly result in an electrical system failure.
- When replacing a blown fuse, it is important to use only a fuse having the correct amperage rating. The use of a fuse with a rating other than indicated may result in a dangerous electrical system overload. If a properly rated fuse continues to blow, it indicates a problem in the circuit that must be corrected.

Internal Power Distribution Center

The Power Distribution Center is located under the drivers side instrument panel. This center contains cartridge fuses, micro fuses, relays, and circuit breakers. A description of each fuse and component may be stamped on the inside cover, otherwise the cavity number of each fuse is stamped on the inside cover that corresponds to the following chart.

Cavity	Cartridge Fuse	Micro Fuse	Description
F01	30 Amp Pink	-	Trailer Tow Receptacle
F03	-	20 Amp Yellow	Module Seat Heater Front (Pass)
F04	-	-	Spare
F05	-	20 Amp Yellow	Module PPU Cooling Fan
F06	-	-	Spare
F07	40 Amp Green	-	Mod CBC 3 PWR Locks
F08	-	-	Spare

Cavity	Cartridge Fuse	Micro Fuse	Description
F09	-	-	Spare
F10	40 Amp Green	-	HVAC Blower Motor
F11	-	5 Amp Tan	Output to Under-hood Power Distribution Center (UPDC) Run Coil
F12	-	25 Amp Clear	Mod Audio Amplifier / Active Noise Cancellation / SW Inverter
F13	-	20 Amp Yellow	Mod Seat Heater Front (Driver)
F14	-	15 Amp Blue	Mod Seat Heater Front (Steering Wheel)
F15	-	-	Spare
F16	-	-	Spare
F17	-	20 Amp Yellow	LT Spot Lamp – If Equipped
F18	30 Amp Pink	-	Motor Sunshade Sunroof
F19	-	-	Spare
F20	-	20 Amp Yellow	Comfort Rear Seat Module (CRSM) (Heat Rear RT)
F21	-	-	Spare
F22	-	-	Spare
F23	-	-	Spare
F24	-	15 Amp Blue	Mod RF Hub / Mod Ignition / Mod Cluster
F25	40 Amp Green	-	Mod Integrated Trailer Brake
F26	-	15 Amp Blue	Mod Cluster CCN / Mod Cyber Security
F27	-	5 Amp Tan	Mod Cluster CCN / Mod SGW
F28	-	10 Amp Red	Mod ORC

Cavity	Cartridge Fuse	Micro Fuse	Description
F29	-	20 Amp Yellow	Mod CRSM (Heat Rear LT)
F30	30 Amp Pink	-	Mod DTCM / Mod Tailgate
F31	30 Amp Pink	-	Mod CBC 1 Interior Light
F32	-	20 Amp Yellow	RT Spot Lamp – If Equipped
F33	-	10 Amp Red	Assy Overhead Console / Switch 911 / Switch Assist / Heads Up Display (HUD)
F34	-	15 Amp Blue	Frnt & RR Ventilated Seat Motor
F35	-	10 Amp Red	Mod Inverter / Mtr Sunshade Sunroof / Mtr Dual Sunroof / USB Charge Only
F36	40 Amp Green	-	Mod CBC 2 Exterior Light 1
F37	-	-	Spare
F38	-	-	Spare
F39	-	-	Spare
F40	20 Amp Blue	-	Dome Pursuit Vehicle – If Equipped
F41 A&B	-	15 Amp Blue	Lumbar Support & Pass SW / Mod ICS Sw Bank / HVAC Ctrl / Sw Bank Upper / Mod Ctrl Steering
F42 A&B	-	10 Amp Red	Mod Transfer Case Switch Module (TCSM) / SBW / Electric Park Brake SW / Overhead Console (OHC) SW / E-Call / Bank 3 SW / Seat LT & RT Vent / Mod Trailer A&B Tire Pressure / Mod Gateway Trailer
F43 A&B	-	10 Amp Red	Port Diagnostics / Mod CD / Front & Rear USB
F44	-	20 Amp Yellow	Radio / DCSD / Telematics Box Mod / Fleet Telematics Module (FTM)

Cavity	Cartridge Fuse	Micro Fuse	Description
F45	30 Amp Pink	-	Mod Door MUX Driver
F46	30 Amp Pink	-	Mod Door MUX Passenger
F47 A&B	-	-	Spare
F48A	-	10 Amp Red	Rear View Mirror / SW Window Passenger / Rear USB / Wireless Charging Pad Mod
F49	-	15 Amp Blue	Mod CVPM / SNSR Blind Spot / HDLP Adaptive Front Lighting Sensor (AFLS)
F50A	-	10 Amp Red	Battery PACK Control Mod
F51 A&B	-	-	Spare
F52	20 Amp Blue	-	Direct Battery Feed – If Equipped
F53	-	10 Amp Red	Trailer Reverse Steering Control / Trailer Steering Control Knob
F54B	-	20 Amp Yellow	Power Outlet Center Seat
F55	25 Amp White	-	Upfitter – If Equipped
F56	30 Amp Pink	-	Mod Network Interface – If Equipped
F57	20 Amp Blue	-	Direct Battery Feed – If Equipped
F58	20 Amp Blue	-	Direct Battery Feed – If Equipped
F60	50 Amp Red	-	Mod Inverter
F61	-	-	Spare
F62 A&B	-	10 Amp Red	ITBM / Mod Occupant Class / Mod IAIR Suspension / Mod HVAC Snsr Incar Temp / Rear Coolant Temp / PTS / Mod IRCM / HRLS / Mod Gateway Trailer TPM

Cavity	Cartridge Fuse	Micro Fuse	Description
F63	-	-	Spare
F64	-	-	Spare
F65	-	10 Amp Red	Mod ORC
F66	-	10 Amp Red	Run Accessory Feed — If Equipped

CAUTION!

- When installing the power distribution center cover, it is important to ensure the cover is properly positioned and fully latched. Failure to do so may allow water to get into the power distribution center and possibly result in an electrical system failure.
- When replacing a blown fuse, it is important to use only a fuse having the correct amperage rating. The use of a fuse with a rating other than indicated may result in a dangerous electrical system overload. If a properly rated fuse continues to blow, it indicates a problem in the circuit that must be corrected.

BULB REPLACEMENT

Replacement Bulbs

NOTE:

See an authorized dealer for LED bulb replacement.

All of the inside bulbs are brass or glass-wedge base. Aluminum base bulbs are not approved.

Interior Bulbs	
Bulb Name	Bulb Number
Overhead Console Lamps	TS 212-9
Dome Lamp	7679
NOTE: For lighted switches, see an authorized dealer for replacement instructions.	

Exterior Bulbs	
Bulb Name	Bulb Number
Low Beam (Halogen Reflector Headlamp)	H11LL
High Beam (Halogen Reflector Headlamp)	9005LL
Low & High Beam (LED Reflector Headlamp)	LED (Serviced at an authorized dealer)
Low & High Beam (LED Projector Headlamp)	LED (Serviced at an authorized dealer)
Turn Signal / Front Position (Halogen Reflector Headlamp)	7444NA
Turn Signal / Front Position (LED Headlamps)	LED (Serviced at an authorized dealer)

Exterior Bulbs	
Bulb Name	Bulb Number
Front Side Marker (Halogen Reflector Headlamp)	W5W
Front Side Marker (LED Headlamps)	LED (Serviced at an authorized dealer)
Front Fog Lamps (Halogen Reflector Headlamp)	H11LL
Front Fog Lamps (LED Headlamps)	LED (Serviced at an authorized dealer)
Side Indicators (Front And Side View Mirror)	LED (Serviced at an authorized dealer)
Base Rear Tail/Turn and Stop Lamp	7440LL/W21WLL
Premium Rear Tail/Turn/Backup and Stop Lamp	LED (Serviced at an authorized dealer)
Base Backup Lamp	7440/W21W
Center High Mounted Stop Lamp (CHMSL)	921
Cargo Lamp	921
Rear License Plate Lamp	LED (Serviced at an authorized dealer)
Base Turn Lamp	7440NA / WY21W

Replacing Exterior Bulbs

Base Quad: Low Beam Headlamp, High Beam Headlamp, Front Park And Turn — If Equipped

Low Beam

See below steps to replace:

1. Open the hood.
2. Disconnect and isolate the negative battery cable.
3. Locate the low beam access cover, which can be found on the back side of the headlamps.

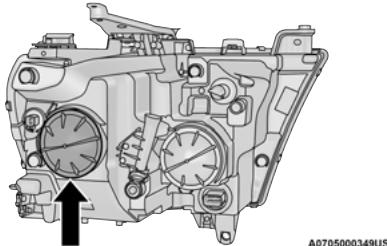

Low Beam Headlight Cover

NOTE:

It may be necessary to remove/reposition Air Cleaner Assembly to access passenger side headlamp/side marker light bulbs.

4. Disengage the bulb access cover by rotating counterclockwise.
5. Disconnect the internal lamp wiring harness connector from the low beam bulb.

CAUTION!

- Do not contaminate the bulb glass by touching it with your fingers or by allowing it to contact other oily surfaces. Shortened bulb life will result.
- Always use the correct bulb size and type for replacement. An incorrect bulb size or type may overheat and cause damage to the lamp, the bulb socket, or the lamp wiring.

6. Rotate the bulb counterclockwise a quarter turn to unlock the bulb from the lamp.
7. Pull the bulb straight out from the housing.
8. Reverse the procedure for installation of new bulb and covers.

High Beam

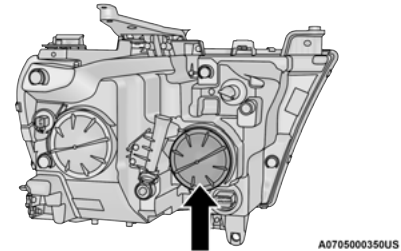

High Beam Headlight Cover

See below steps to replace:

1. Open the hood.
2. Disconnect and isolate the negative battery cable.
3. Locate the high beam access cover, which can be found on the back side of the headlamps.

NOTE:

It may be necessary to remove/reposition Air Cleaner Assembly to access passenger side headlamp/side marker light bulbs.

- Reach behind the headlamp and disengage the access cover by rotating counterclockwise.
- Disconnect the internal lamp wiring harness connector from the high beam bulb.

CAUTION!

- Do not contaminate the bulb glass by touching it with your fingers or by allowing it to contact other oily surfaces. Shortened bulb life will result.
- Always use the correct bulb size and type for replacement. An incorrect bulb size or type may overheat and cause damage to the lamp, the bulb socket, or the lamp wiring.

- Rotate the bulb counterclockwise a quarter turn to unlock the bulb from the lamp.
- Pull the bulb straight out from the housing.
- Reverse the procedure for installation of new bulb and cover.

Front Park And Turn

See below steps to replace:

- Open the hood.
- Disconnect and isolate the negative battery cable.
- Locate the park and turn socket, which can be found on the back side of the headlamps.

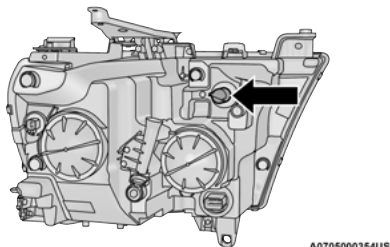
**Park And Turn Socket**

A0705000354US

- Reach behind the headlamp and unlock the park and turn socket from the lamp by rotating counterclockwise a quarter turn.
- Pull the bulb straight out from the housing.

- Separate the bulb from the socket without twisting.
- Reverse the procedure for installation of new bulb and covers.

Side Marker Lamp

See below steps to replace:

- Open the hood.
- Disconnect and isolate the negative battery cable.
- Locate the side marker lamp, which can be found on the back side of the headlamps.

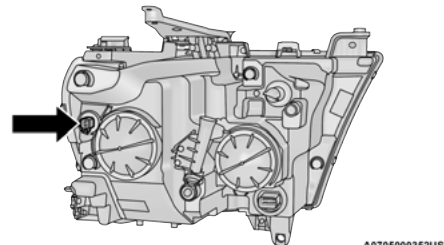
**Side Marker Lamp**

A0705000352US

- Disengage the side marker socket by rotating counterclockwise a quarter turn.
- Pull the socket and bulb straight out from the housing.
- Separate the bulb from the socket without twisting.
- Reverse the procedure for installation of new bulb and covers.

Fog Lamps – If Equipped

Please see an authorized dealer for service on LED and Halogen front fog lamps.

Halogen

See below steps to replace:

- Reach under and behind the front fascia/bumper to access the back of the front fog lamp housing.
- Disconnect the fog lamp wiring harness connector from the fog lamp bulb.

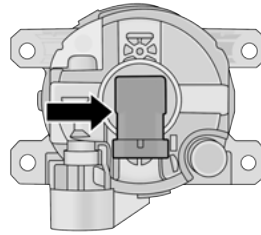

Fog Lamp Bulb

A0705000443US

- Rotate the bulb counterclockwise a quarter turn to unlock the bulb from the housing.
- Pull the bulb straight out from the housing.
- Reverse the procedure to install the bulb and cover.

CAUTION!

Do not contaminate the bulb glass by touching it with your fingers or by allowing it to contact other oily surfaces. Shortened bulb life will result.

Rear Tail/Stop, Turn Signal And Backup Lamps

See below steps to replace:

- Remove the two screws and push pins retainers that pass through the bed sheet metal.

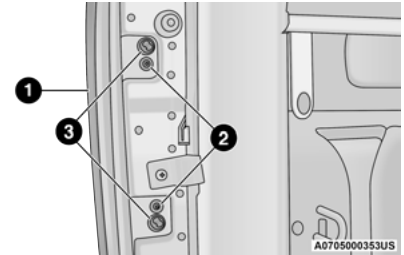

Tail Lamp Locations

- 1 – Tail Lamp
- 2 – Fasteners
- 3 – Push - Pin Retainers

2. Pull the outboard side of the lamp rearward far enough to unsnap the two receptacles on the outboard side of the lamp housing from the two plastic snap post retainers in the outer box side panel.

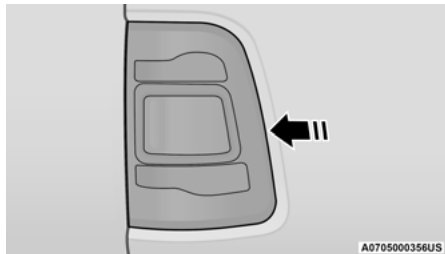

Tail Lamp Removal

A0705000356US

3. Disconnect the wiring harness connectors from the bulb socket.

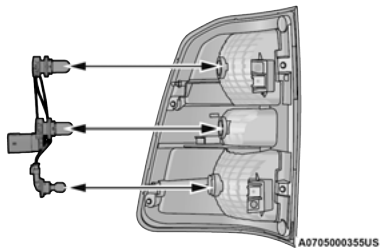

Wiring Harness Connector

A0705000355US

4. Rotate the bulb socket counterclockwise a quarter turn to unlock it from the housing.
5. Pull the bulb straight out of the socket.

CAUTION!

Do not contaminate the bulb glass by touching it with your fingers or by allowing it to contact other oily surfaces. Shortened bulb life will result.

6. Reverse the procedure to install the bulb and housing.

Center High Mounted Stop Lamp (CHMSL) With Cargo Lamp

See below steps to replace:

1. Remove the four screws holding the housing/lens to the body as shown.

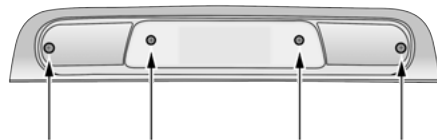

A0705000357US

CHMSL Mounting Screw Locations

2. Separate the connector holding the housing and wiring harness to the body.

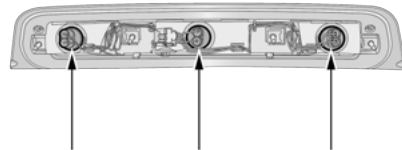

A0705000358US

CHMSL Bulb Location

- Turn the desired bulb socket a quarter turn counterclockwise and remove the socket and bulb from housing.
- Pull the desired bulb straight from the socket.

CAUTION!

Do not contaminate the bulb glass by touching it with your fingers or by allowing it to contact other oily surfaces. Shortened bulb life will result.

- Outside Bulbs: Cargo Lamps
 - Inside Bulb: Center High Mounted Stop Lamp
- Reverse the procedure for installation of bulbs and housing.

TIRES**TIRE SAFETY INFORMATION**

Tire safety information will cover aspects of the following information: Tire Markings, Tire Identification Numbers, Tire Terminology and Definitions, Tire Pressures, and Tire Loading.

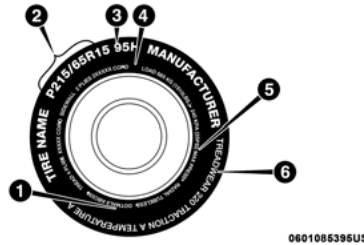
Tire Markings**Tire Markings**

1 – US DOT Safety Standards Code (TIN)
2 – Size Designation
3 – Service Description
4 – Maximum Load
5 – Maximum Pressure
6 – Treadwear, Traction and Temperature Grades

NOTE:

- P (Passenger) – Metric tire sizing is based on US design standards. P-Metric tires have the letter “P” molded into the sidewall preceding the size designation. Example: P215/65R15 95H.

- European – Metric tire sizing is based on European design standards. Tires designed to this standard have the tire size molded into the sidewall beginning with the section width. The letter “P” is absent from this tire size designation. Example: 215/65R15 96H.
- LT (Light Truck) – Metric tire sizing is based on US design standards. The size designation for LT-Metric tires is the same as for P-Metric tires except for the letters “LT” that are molded into the sidewall preceding the size designation. Example: LT235/85R16.
- Temporary spare tires are designed for temporary emergency use only. Temporary high pressure compact spare tires have the letter “T” or “S” molded into the sidewall preceding the size designation. Example: T145/80D18 103M.
- High flotation tire sizing is based on US design standards and it begins with the tire diameter molded into the sidewall. Example: 31x10.5 R15 LT.

Tire Sizing Chart

EXAMPLE:
Example Size Designation: P215/65R15XL 95H, 215/65R15 96H, LT235/85R16C, T145/80D18 103M, 31x10.5 R15 LT
P = Passenger car tire size based on US design standards, or
"....blank...." = Passenger car tire based on European design standards, or
LT = Light truck tire based on US design standards, or
T or S = Temporary spare tire or
31 = Overall diameter in inches (in)
215, 235, 145 = Section width in millimeters (mm)
65, 85, 80 = Aspect ratio in percent (%)
<ul style="list-style-type: none"> ● Ratio of section height to section width of tire, or
10.5 = Section width in inches (in)
R = Construction code
<ul style="list-style-type: none"> ● "R" means radial construction, or ● "D" means diagonal or bias construction
15, 16, 18 = Rim diameter in inches (in)
Service Description:
95 = Load Index
<ul style="list-style-type: none"> ● A numerical code associated with the maximum load a tire can carry

EXAMPLE:

H = Speed Symbol

- A symbol indicating the range of speeds at which a tire can carry a load corresponding to its load index under certain operating conditions
- The maximum speed corresponding to the speed symbol should only be achieved under specified operating conditions (i.e., tire pressure, vehicle loading, road conditions, and posted speed limits)

Load Identification:

Absence of the following load identification symbols on the sidewall of the tire indicates a Standard Load (SL) tire:

- **XL** = Extra load (or reinforced) tire, or
- **LL** = Light load tire or
- **C, D, E, F, G** = Load range associated with the maximum load a tire can carry at a specified pressure

Maximum Load – Maximum load indicates the maximum load this tire is designed to carry

Maximum Pressure – Maximum pressure indicates the maximum permissible cold tire inflation pressure for this tire

Tire Identification Number (TIN)

The Tire Identification Number (TIN) may be found on one or both sides of the tire; however, the date code may only be on one side. Tires with white sidewalls will have the full TIN, including the date code, located on the white sidewall side of the tire. Look for the TIN on the outboard side of black sidewall tires as mounted on the vehicle. If the TIN is not found on the outboard side, then you will find it on the inboard side of the tire.

EXAMPLE:

DOT MA L9 ABCD 0301

DOT = Department of Transportation

- This symbol certifies that the tire is in compliance with the US Department of Transportation tire safety standards and is approved for highway use

MA = Code representing the tire manufacturing location (two digits)

EXAMPLE:

L9 = Code representing the tire size (two digits)

ABCD = Code used by the tire manufacturer (one to four digits)

03 = Number representing the week in which the tire was manufactured (two digits)

- 03 means the 3rd week

01 = Number representing the year in which the tire was manufactured (two digits)

- 01 means the year 2001
- Prior to July 2000, tire manufacturers were only required to have one number to represent the year in which the tire was manufactured. Example: 031 could represent the 3rd week of 1981 or 1991

Tire Terminology And Definitions

Term	Definition
B-Pillar	The vehicle B-Pillar is the structural member of the body located behind the front door.
Cold Tire Inflation Pressure	Cold tire inflation pressure is defined as the tire pressure after the vehicle has not been driven for at least three hours, or driven less than 1 mile (1.6 km) after sitting for a minimum of three hours. Inflation pressure is measured in units of PSI (pounds per square inch) or kPa (kilopascals).
Maximum Inflation Pressure	The maximum inflation pressure is the maximum permissible cold tire inflation pressure for this tire. The maximum inflation pressure is molded into the sidewall.
Recommended Cold Tire Inflation Pressure	FCA's recommended cold tire inflation pressure as shown on the tire placard.
Tire Placard	A label permanently attached to the vehicle describing the vehicle's loading capacity, the original equipment tire sizes and the recommended cold tire inflation pressures.

Tire Loading And Tire Pressure

NOTE:

The proper cold tire inflation pressure is listed on the driver's side B-Pillar or the rear edge of the driver's side door.

Check the inflation pressure of each tire, including the spare tire (if equipped), at least monthly and inflate to the recommended pressure for your vehicle.

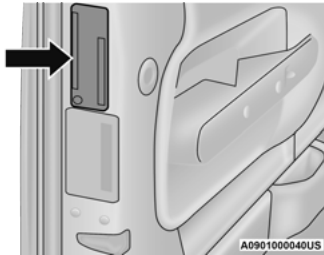

Example Tire Placard Location (Door)

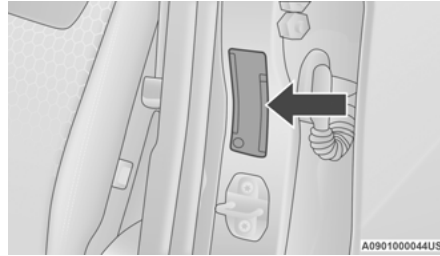

Example Tire Placard Location (B-Pillar)

Tire And Loading Information Placard

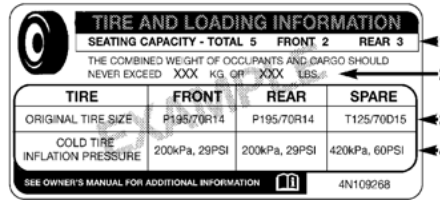

Tire And Loading Information Placard

This placard tells you important information about the:

1. Number of people that can be carried in the vehicle.
2. Total weight your vehicle can carry.
3. Tire size designed for your vehicle.
4. Cold tire inflation pressures for the front, rear, and spare tires.

Loading

The vehicle maximum load on the tire must not exceed the load carrying capacity of the tire on your vehicle. You will not exceed the tire's load carrying capacity if you adhere to the loading conditions, tire size, and cold tire inflation pressures specified on the Tire and Loading Information placard in Vehicle Loading page 213.

NOTE:

Under a maximum loaded vehicle condition, gross axle weight ratings (GAWRs) for the front and rear axles must not be exceeded.

For further information on GAWRs, vehicle loading, and trailer towing → page 213.

To determine the maximum loading conditions of your vehicle, locate the statement “The combined weight of occupants and cargo should never exceed XXX kg or XXX lbs” on the Tire and Loading Information placard. The combined weight of occupants, cargo/luggage and trailer tongue weight (if applicable) should never exceed the weight referenced here.

Steps For Determining Correct Load Limit—

(1) Locate the statement “The combined weight of occupants and cargo should never exceed XXX kg or XXX lbs.” on your vehicle's placard.

(2) Determine the combined weight of the driver and passengers that will be riding in your vehicle.

(3) Subtract the combined weight of the driver and passengers from XXX kg or XXX lbs.

(4) The resulting figure equals the available amount of cargo and luggage load capacity. For example, if “XXX” amount equals 1400 lbs. and there will be five 150 lb passengers in your vehicle, the amount of available cargo and luggage load capacity is 650 lbs. (1400-750 (5x150) = 650 lbs.)

(5) Determine the combined weight of luggage and cargo being loaded on the vehicle. That weight may not safely exceed the available cargo and luggage load capacity calculated in Step 4.

(6) If your vehicle will be towing a trailer, load from your trailer will be transferred to your vehicle. Consult this manual to determine how this reduces the available cargo and luggage load capacity of your vehicle.

Metric Example For Load Limit

For example, if “XXX” amount equals 635 kg and there will be five 68 kg passengers in your vehicle, the amount of available cargo and luggage load capacity is 295 kg (635-340 (5x68) = 295 kg) as shown in step 4.

NOTE:

- If your vehicle will be towing a trailer, load from your trailer will be transferred to your vehicle. The following table shows examples on how to calculate total load, cargo/luggage, and towing capacities of your vehicle with varying seating configurations and number and size of occupants. This table is for illustration purposes only and may not be accurate for the seating and load carry capacity of your vehicle.
- For the following example, the combined weight of occupants and cargo should never exceed 865 lbs (392 kg).

Occupants			Combined weight of occupants and cargo from Tire Placard	MINUS	Combined Occupant's weight	=	AVAILABLE Cargo/Luggage and Trailer Tongue Weight
TOTAL	FRONT	REAR					
EXAMPLE 1			865 lbs	minus	670 lbs	=	195 lbs
5	2	3					
EXAMPLE 2			865 lbs	minus	540 lbs	=	325 lbs
3	2	1					
EXAMPLE 3			865 lbs	minus	400 lbs	=	465 lbs
2	2	0					

811a4d11

WARNING!

Overloading of your tires is dangerous. Overloading can cause tire failure, affect vehicle handling, and increase your stopping distance. Use tires of the recommended load capacity for your vehicle. Never overload them.

TIRES — GENERAL INFORMATION

Tire Pressure

Proper tire inflation pressure is essential to the safe and satisfactory operation of your vehicle.

Four primary areas are affected by improper tire pressure:

- Safety
- Fuel Economy
- Tread Wear
- Ride Comfort and Vehicle Stability

Safety**WARNING!**

- Improperly inflated tires are dangerous and can cause collisions.
- Underinflation increases tire flexing and can result in overheating and tire failure.
- Overinflation reduces a tire's ability to cushion shock. Objects on the road and chuckholes can cause damage that result in tire failure.
- Overinflated or underinflated tires can affect vehicle handling and can fail suddenly, resulting in loss of vehicle control.
- Unequal tire pressures can cause steering problems. You could lose control of your vehicle.
- Unequal tire pressures from one side of the vehicle to the other can cause the vehicle to drift to the right or left.
- Always drive with each tire inflated to the recommended cold tire inflation pressure.

Both underinflation and overinflation affect the stability of the vehicle and can produce a feeling of sluggish response or over responsiveness in the steering.

NOTE:

- Unequal tire pressures from side to side may cause erratic and unpredictable steering response.
- Unequal tire pressure from side to side may cause the vehicle to drift left or right.

Fuel Economy

Underinflated tires will increase tire rolling resistance resulting in higher fuel consumption.

Tread Wear

Improper cold tire inflation pressures can cause abnormal wear patterns and reduced tread life, resulting in the need for earlier tire replacement.

Ride Comfort And Vehicle Stability

Proper tire inflation contributes to a comfortable ride. Overinflation produces a jarring and uncomfortable ride.

Tire Inflation Pressures

The proper cold tire inflation pressure is listed on the driver's side B-Pillar or rear edge of the driver's side door.

At least once a month:

- Check and adjust tire pressure with a good quality pocket-type pressure gauge. Do not make a visual judgement when determining proper inflation. Tires may look properly inflated even when they are underinflated.
- Inspect tires for signs of tire wear or visible damage.

CAUTION!

After inspecting or adjusting the tire pressure, always reinstall the valve stem cap. This will prevent moisture and dirt from entering the valve stem, which could damage the valve stem.

Inflation pressures specified on the placard are always "cold tire inflation pressure". Cold tire inflation pressure is defined as the tire pressure after the vehicle has not been driven for at least three hours, or driven less than 1 mile (1.6 km) after sitting for a minimum of three hours. The

cold tire inflation pressure must not exceed the maximum inflation pressure molded into the tire sidewall.

Check tire pressures more often if subject to a wide range of outdoor temperatures, as tire pressures vary with temperature changes.

Tire pressures change by approximately 1 psi (7 kPa) per 12°F (7°C) of air temperature change. Keep this in mind when checking tire pressure inside a garage, especially in the Winter.

Example: If garage temperature = 68°F (20°C) and the outside temperature = 32°F (0°C) then the cold tire inflation pressure should be increased by 3 psi (21 kPa), which equals 1 psi (7 kPa) for every 12°F (7°C) for this outside temperature condition.

Tire pressure may increase from 2 to 6 psi (13 to 40 kPa) during operation. DO NOT reduce this normal pressure build up or your tire pressure will be too low.

Tire Pressures For High Speed Operation

The manufacturer advocates driving at safe speeds and within posted speed limits. Where speed limits or conditions are such that the vehicle can be driven at high speeds,

maintaining correct tire inflation pressure is very important. Increased tire pressure and reduced vehicle loading may be required for high-speed vehicle operation. Refer to an authorized tire dealer or original equipment vehicle dealer for recommended safe operating speeds, loading and cold tire inflation pressures.

WARNING!

High speed driving with your vehicle under maximum load is dangerous. The added strain on your tires could cause them to fail. You could have a serious collision. Do not drive a vehicle loaded to the maximum capacity at continuous speeds above 75 mph (120 km/h).

Radial Ply Tires

WARNING!

Combining radial ply tires with other types of tires on your vehicle will cause your vehicle to handle poorly. The instability could cause a collision. Always use radial ply tires in sets of four. Never combine them with other types of tires.

Tire Repair

If your tire becomes damaged, it may be repaired if it meets the following criteria:

- The tire has not been driven on when flat
- The damage is only on the tread section of your tire (sidewall damage is not repairable)
- The puncture is no greater than a ¼ of an inch (6 mm)

Consult an authorized tire dealer for tire repairs and additional information.

Damaged Run Flat tires, or Run Flat tires that have experienced a loss of pressure should be replaced immediately with another Run Flat tire of identical size and service description (Load Index and Speed Symbol). Replace the tire pressure sensor as well as it is not designed to be reused.

Run Flat Tires — If Equipped

Run Flat tires allow you the capability to drive 50 miles (80 km) at 50 mph (80 km/h) after a rapid loss of inflation pressure. This rapid loss of inflation is referred to as the Run Flat mode. A Run Flat mode occurs when the tire inflation pressure is of/or below 14 psi (96 kPa). Once a Run Flat tire reaches the Run Flat mode it has

limited driving capabilities and needs to be replaced immediately. A Run Flat tire is not repairable. When a Run Flat tire is changed after driving with underinflated tire condition, please replace the TPM sensor as it is not designed to be reused when driven under Run Flat mode 14 psi (96 kPa) condition.

NOTE:

TPM Sensor must be replaced after driving the vehicle on a flat tire condition.

It is not recommended driving a vehicle loaded at full capacity or to tow a trailer while a tire is in the Run Flat mode.

For more information ⇨ page 327.

Tire Spinning

When stuck in mud, sand, snow, or ice conditions, do not spin your vehicle's wheels above 30 mph (48 km/h) or for longer than 30 seconds continuously without stopping.

For further information ⇨ page 391.

WARNING!

Fast spinning tires can be dangerous. Forces generated by excessive wheel speeds may cause tire damage or failure. A tire could explode and injure someone. Do not spin your vehicle's wheels faster than 30 mph (48 km/h) for more than 30 seconds continuously when you are stuck, and do not let anyone near a spinning wheel, no matter what the speed.

Tread Wear Indicators

Tread wear indicators are in the original equipment tires to help you in determining when your tires should be replaced.

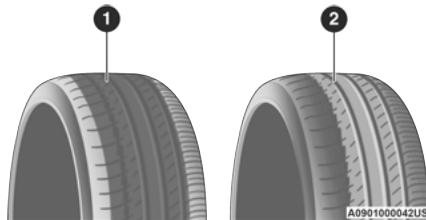

Tire Tread

1 – Worn Tire

2 – New Tire

These indicators are molded into the bottom of the tread grooves. They will appear as bands when the tread depth becomes a 1/16 of an inch (1.6 mm). When the tread is worn to the tread wear indicators, the tire should be replaced.

For further information ⇨ page 453.

Life Of Tire

The service life of a tire is dependent upon varying factors including, but not limited to:

- Driving style
- Tire pressure - Improper cold tire inflation pressures can cause uneven wear patterns to develop across the tire tread. These abnormal wear patterns will reduce tread life, resulting in the need for earlier tire replacement
- Distance driven
- Performance tires, tires with a speed rating of V or higher, and Summer tires typically have a reduced tread life. Rotation of these tires per the vehicle scheduled maintenance is highly recommended

WARNING!

Tires and the spare tire should be replaced after six years, regardless of the remaining tread. Failure to follow this warning can result in sudden tire failure. You could lose control and have a collision resulting in serious injury or death.

NOTE:

Wheel Valve Stem must be replaced as well when installing new tires due to wear and tear in existing tires.

Keep dismounted tires in a cool, dry place with as little exposure to light as possible. Protect tires from contact with oil, grease, and gasoline.

Replacement Tires

The tires on your new vehicle provide a balance of many characteristics. They should be inspected regularly for wear and correct cold tire inflation pressures. FCA strongly recommends that you use tires equivalent to the originals in size, quality and performance when replacement is needed → page 452.

Refer to the Tire and Loading Information placard or the Vehicle Certification Label for the size designation of your tire. The Load Index and Speed Symbol for your tire will be found on the original equipment tire sidewall.

For more information relating to the Load Index and Speed Symbol of a tire → page 444.

It is recommended to replace the two front tires or two rear tires as a pair. Replacing just one tire can seriously affect your vehicle's handling. If you ever replace a wheel, make sure that the wheel's specifications match those of the original wheels.

It is recommended you contact an authorized tire dealer or original equipment dealer with any questions you may have on tire specifications or capability. Failure to use equivalent replacement tires may adversely affect the safety, handling, and ride of your vehicle.

WARNING!

- Do not use a tire, wheel size, load rating, or speed rating other than that specified for your vehicle. Some combinations of unapproved tires and wheels may change suspension dimensions and performance characteristics, resulting in changes to steering, handling, and braking of your vehicle. This can cause unpredictable handling and stress to steering and suspension components. You could lose control and have a collision resulting in serious injury or death. Use only the tire and wheel sizes with load ratings approved for your vehicle.
- Never use a tire with a smaller load index or capacity, other than what was originally equipped on your vehicle. Using a tire with a smaller load index could result in tire overloading and failure. You could lose control and have a collision.

(Continued)

WARNING! *(Continued)*

- Failure to equip your vehicle with tires having adequate speed capability can result in sudden tire failure and loss of vehicle control.

CAUTION!

Replacing original tires with tires of a different size may result in false speedometer and odometer readings.

TIRE TYPES**All Season Tires — If Equipped**

All Season tires provide traction for all seasons (Spring, Summer, Autumn, and Winter). Traction levels may vary between different all season tires. All season tires can be identified by the M+S, M&S, M/S or MS designation on the tire sidewall. Use all season tires only in sets of four; failure to do so may adversely affect the safety and handling of your vehicle.

Summer Or Three Season Tires — If Equipped

Summer tires provide traction in both wet and dry conditions, and are not intended to be driven in snow or on ice. If your vehicle is equipped with Summer tires, be aware these tires are not designed for Winter or cold driving conditions. Install Winter tires on your vehicle when ambient temperatures are less than 40° F (5° C) or if roads are covered with ice or snow. For more information, contact an authorized dealer.

Summer tires do not contain the all season designation or mountain/snowflake symbol on the tire sidewall. Use Summer tires only in sets of four; failure to do so may adversely affect the safety and handling of your vehicle.

WARNING!

Do not use Summer tires in snow/ice conditions. You could lose vehicle control, resulting in severe injury or death. Driving too fast for conditions also creates the possibility of loss of vehicle control.

Snow Tires

Some areas of the country require the use of snow tires during the Winter. Snow tires can be identified by a “mountain/snowflake” symbol on the tire sidewall.



If you need snow tires, select tires equivalent in size and type to the original equipment tires. Use snow tires only in sets of four; failure to do so may adversely affect the safety and handling of your vehicle.

Snow tires generally have lower speed ratings than what was originally equipped with your vehicle and should not be operated at sustained speeds over 75 mph (120 km/h). For speeds above 75 mph (120 km/h) refer to original equipment or an authorized tire dealer for recommended safe operating speeds, loading and cold tire inflation pressures.

While studded tires improve performance on ice, skid and traction capability on wet or dry surfaces may be poorer than that of non-studded tires. Some states prohibit studded tires; therefore, local laws should be checked before using these tire types.

SPARE TIRES — IF EQUIPPED

NOTE:

For vehicles equipped with Tire Service Kit instead of a spare tire, please refer to “Tire Service Kit” in “In Case Of Emergency” for further information.

CAUTION!

Because of the reduced ground clearance, do not take your vehicle through an automatic car wash with a compact or limited use temporary spare installed. Damage to the vehicle may result.

For restrictions when towing with a spare tire designated for temporary emergency use
 ➤ page 222.

Spare Tire Matching Original Equipped Tire And Wheel — If Equipped

Your vehicle may be equipped with a spare tire and wheel equivalent in look and function to the original equipment tire and wheel found on the front or rear axle of your vehicle. This spare tire may be used in the tire rotation for your vehicle. If your vehicle has this option, refer to an authorized tire dealer for the recommended tire rotation pattern.

Compact Spare Tire — If Equipped

The compact spare is for temporary emergency use only. You can identify if your vehicle is equipped with a compact spare by looking at the spare tire description on the Tire and Loading Information Placard located on the driver’s side door opening or on the sidewall of the tire. Compact spare tire descriptions begin with the letter “T” or “S” preceding the size designation. Example: T145/80D18 103M.

T, S = Temporary Spare Tire

Since this tire has limited tread life, the original equipment tire should be repaired (or replaced) and reinstalled on your vehicle at the first opportunity.

Do not install a wheel cover or attempt to mount a conventional tire on the compact spare wheel, since the wheel is designed specifically for the compact spare tire. Do not install more than one compact spare tire and wheel on the vehicle at any given time.

WARNING!

Compact and collapsible spares are for temporary emergency use only. With these spares, do not drive more than 50 mph (80 km/h). Temporary use spares have limited tread life. When the tread is worn to the tread wear indicators, the temporary use spare tire needs to be replaced. Be sure to follow the warnings, which apply to your spare. Failure to do so could result in spare tire failure and loss of vehicle control.

Collapsible Spare Tire — If Equipped

The collapsible spare is for temporary emergency use only. You can identify if your vehicle is equipped with a collapsible spare by looking at the spare tire description on the Tire and Loading Information Placard located on the driver’s side door opening or on the sidewall of the tire.

Collapsible spare tire description example:
 165/80-17 101P.

Since this tire has limited tread life, the original equipment tire should be repaired (or replaced) and reinstalled on your vehicle at the first opportunity.

Inflate collapsible tire only after the wheel is properly installed to the vehicle. Inflate the collapsible tire using the electric air pump before lowering the vehicle.

Do not install a wheel cover or attempt to mount a conventional tire on the collapsible spare wheel, since the wheel is designed specifically for the collapsible spare tire.

WARNING!

Compact and Collapsible spares are for temporary emergency use only. With these spares, do not drive more than 50 mph (80 km/h). Temporary use spares have limited tread life. When the tread is worn to the tread wear indicators, the temporary use spare tire needs to be replaced. Be sure to follow the warnings, which apply to your spare. Failure to do so could result in spare tire failure and loss of vehicle control.

Full Size Spare — If Equipped

The full size spare is for temporary emergency use only. This tire may look like the originally equipped tire on the front or rear axle of your vehicle, but it is not. This spare tire may have limited tread life. When the tread is worn to the tread wear indicators, the temporary use full size spare tire needs to be replaced. Since it is not the same as your original equipment tire, replace (or repair) the original equipment tire and reinstall on the vehicle at the first opportunity.

Limited Use Spare — If Equipped

The limited use spare tire is for temporary emergency use only. This tire is identified by a label located on the limited use spare wheel. This label contains the driving limitations for this spare. This tire may look like the original equipped tire on the front or rear axle of your vehicle, but it is not. Installation of this limited use spare tire affects vehicle handling. Since it is not the same as your original equipment tire, replace (or repair) the original equipment tire and reinstall on the vehicle at the first opportunity.

WARNING!

Limited use spares are for emergency use only. Installation of this limited use spare tire affects vehicle handling. With this tire, do not drive more than the speed listed on the limited use spare wheel. Keep inflated to the cold tire inflation pressures listed on your Tire and Loading Information Placard located on the driver's side B-Pillar or the rear edge of the driver's side door. Replace (or repair) the original equipment tire at the first opportunity and reinstall it on your vehicle. Failure to do so could result in loss of vehicle control.

WHEEL AND WHEEL TRIM CARE

All wheels and wheel trim, especially aluminum and chrome plated wheels, should be cleaned regularly using mild (neutral Ph) soap and water to maintain their luster and to prevent corrosion. Wash wheels with the same soap solution recommended for the body of the vehicle and remember to always wash when the surfaces are not hot to the touch.

Your wheels are susceptible to deterioration caused by salt, sodium chloride, magnesium chloride, calcium chloride, etc., and other road chemicals used to melt ice or control dust on dirt roads. Use a soft cloth or sponge and mild soap to wipe away promptly. Do not use harsh chemicals or a stiff brush. They can damage the wheel's protective coating that helps keep them from corroding and tarnishing.

CAUTION!

Avoid products or automatic car washes that use acidic solutions or strong alkaline additives or harsh brushes. Many aftermarket wheel cleaners and automatic car washes may damage the wheel's protective finish. Such damage is not covered by the New Vehicle Limited Warranty. Only car wash soap, Mopar Wheel Cleaner or equivalent is recommended.

When cleaning extremely dirty wheels including excessive brake dust, care must be taken in the selection of tire and wheel cleaning chemicals and equipment to prevent damage to the wheels. Mopar Wheel Treatment or Mopar Chrome Cleaner or their equivalent is recommended or select a non-abrasive, non-acidic cleaner for aluminum or chrome wheels.

CAUTION!

Do not use scouring pads, steel wool, a bristle brush, metal polishes or oven cleaner. These products may damage the wheel's protective finish. Such damage is not covered by the New Vehicle Limited Warranty. Only car wash soap, Mopar Wheel Cleaner or equivalent is recommended.

NOTE:

If you intend parking or storing your vehicle for an extended period after cleaning the wheels with wheel cleaner, drive your vehicle and apply the brakes to remove the water droplets from the brake components. This activity will remove the red rust on the brake rotors and prevent vehicle vibration when braking.

Dark Vapor Chrome, Black Satin Chrome, or Low Gloss Clear Coat Wheels

CAUTION!

If your vehicle is equipped with these specialty wheels, DO NOT USE wheel cleaners, abrasives, or polishing compounds. They will permanently damage this finish and such damage is not covered by the New Vehicle Limited Warranty. **HAND WASH ONLY USING MILD SOAP AND WATER WITH A SOFT CLOTH.** Used on a regular basis; this is all that is required to maintain this finish.

SNOW TRACTION DEVICES

Use of traction devices require sufficient tire-to-body clearance. Due to limited clearance, the following snow traction devices are recommended. Follow these recommendations to guard against damage:

- Snow traction device must be of proper size for the tire, as recommended by the snow traction device manufacturer.
- No other tire sizes are recommended for use with the snow traction device.
- Please follow the table below for the recommended tire size, axle and snow traction device:

4x2 (2WD) Trim Level	Axle	Tire/Wheel Size	Snow Traction Device (maximum projection beyond tire profile or equivalent)
HFE Tradesman Bighorn Lonestar Laramie	Rear	275/65R18 275/55R20	S Class
Longhorn Sport Limited	Rear	275/55R20	S Class
REBEL		Not Chainable	

4x4 (4WD) Trim Level	Axle	Tire/Wheel Size	Snow Traction Device (maximum projection beyond tire profile or equivalent)
Tradesman Bighorn Lonestar Laramie	Rear	275/65R18 275/55/R20	S Class
Longhorn Sport Limited	Rear	275/55R20	S Class
REBEL		Not Chainable	

WARNING!

Using tires of different size and type (M+S, Snow) between front and rear axles can cause unpredictable handling. You could lose control and have a collision.

CAUTION!

To avoid damage to your vehicle or tires, observe the following precautions:

- Because of restricted traction device clearance between tires and other suspension components, it is important that only traction devices in good condition are used. Broken devices can cause serious damage. Stop the vehicle immediately if noise occurs that could indicate device breakage. Remove the damaged parts of the device before further use.

*(Continued)***CAUTION!** *(Continued)*

- Install device as tightly as possible and then retighten after driving about ½ mile (0.8 km). Autosock traction devices do not require retightening.
- Do not exceed 30 mph (48 km/h).
- Drive cautiously and avoid severe turns and large bumps, especially with a loaded vehicle.
- Do not drive for a prolonged period on dry pavement.

(Continued)

CAUTION! *(Continued)*

- Observe the traction device manufacturer's instructions on the method of installation, operating speed, and conditions for use. Always use the suggested operating speed of the device manufacturer's if it is less than 30 mph (48 km/h).
- Do not use traction devices on a compact spare tire.

TIRE ROTATION RECOMMENDATIONS

Tires on the front and rear axles of vehicles operate at different loads and perform different steering, driving, and braking functions. For these reasons, they wear at unequal rates.

These effects can be reduced by timely rotation of tires. The benefits of rotation are especially worthwhile with aggressive tread designs such as those on all season type tires. Rotation will increase tread life, help to maintain mud, snow and wet traction levels and contribute to a smooth, quiet ride.

For the proper maintenance intervals ↪ page 395. More frequent rotation is permissible if desired. The reasons for any rapid

or unusual wear should be corrected prior to rotation being performed.

The suggested rotation method is the "rearward cross" shown in the following diagram. This rotation pattern does not apply to some directional tires that must not be reversed.

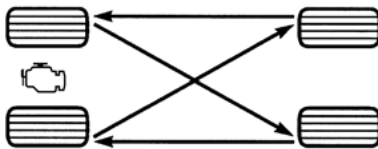

Tire Rotation (Rearward Cross)

055703771

DEPARTMENT OF TRANSPORTATION UNIFORM TIRE QUALITY GRADES

The following tire grading categories were established by the National Highway Traffic Safety Administration. The specific grade rating assigned by the tire's manufacturer in each category is

shown on the sidewall of the tires on your vehicle.

All passenger vehicle tires must conform to Federal safety requirements in addition to these grades.

TREADWEAR

The Treadwear grade is a comparative rating, based on the wear rate of the tire when tested under controlled conditions on a specified government test course. For example, a tire graded 150 would wear one and one-half times as well on the government course as a tire graded 100. The relative performance of tires depends upon the actual conditions of their use, however, and may depart significantly from the norm due to variations in driving habits, service practices, and differences in road characteristics and climate.

TRACTION GRADES

The Traction grades, from highest to lowest, are AA, A, B, and C. These grades represent the tire's ability to stop on wet pavement, as measured under controlled conditions on specified government test surfaces of asphalt and concrete. A tire marked C may have poor traction performance.

WARNING!

The traction grade assigned to this tire is based on straight-ahead braking traction tests, and does not include acceleration, cornering, hydroplaning, or peak traction characteristics.

TEMPERATURE GRADES

The Temperature grades are A (the highest), B, and C, representing the tire's resistance to the generation of heat and its ability to dissipate heat, when tested under controlled conditions on a specified indoor laboratory test wheel.

Sustained high temperature can cause the material of the tire to degenerate and reduce tire life, and excessive temperature can lead to sudden tire failure. The grade C corresponds to a level of performance, which all passenger vehicle tires must meet under the Federal Motor Vehicle Safety Standard No. 109. Grades B and A represent higher levels of performance on the laboratory test wheel, than the minimum required by law.

WARNING!

The temperature grade for this tire is established for a tire that is properly inflated and not overloaded. Excessive speed, underinflation, or excessive loading, either separately or in combination, can cause heat buildup and possible tire failure.

STORING THE VEHICLE

If you are storing your vehicle for more than three weeks, we recommend that you take the following steps to minimize the drain on your vehicle's battery:

- Disconnect the negative cable from battery.
- Any time you store your vehicle or keep it out of service (i.e., vacation) for two weeks or more, run the air conditioning system at idle for about five minutes in the fresh air and high blower setting. This will ensure adequate system lubrication to minimize the possibility of compressor damage when the system is started again.

BODYWORK

PROTECTION FROM ATMOSPHERIC AGENTS

Vehicle body care requirements vary according to geographic locations and usage. Chemicals that make roads passable in snow and ice and those that are sprayed on trees and road surfaces during other seasons are highly corrosive to the metal in your vehicle. Outside parking, which exposes your vehicle to airborne

contaminants, road surfaces on which the vehicle is operated, extreme hot or cold weather and other extreme conditions will have an adverse effect on paint, metal trim, and underbody protection.

The following maintenance recommendations will enable you to obtain maximum benefit from the corrosion resistance built into your vehicle.

What Causes Corrosion?

Corrosion is the result of deterioration or removal of paint and protective coatings from your vehicle.

The most common causes are:

- Road salt, dirt and moisture accumulation.
- Stone and gravel impact.
- Insects, tree sap and tar.
- Salt in the air near seacoast localities.
- Atmospheric fallout/industrial pollutants.

BODY AND UNDERBODY MAINTENANCE

Cleaning Headlights

Your vehicle is equipped with plastic headlights and fog lights that are lighter and less

susceptible to stone breakage than glass headlights.

Plastic is not as scratch resistant as glass and therefore different lens cleaning procedures must be followed.

To minimize the possibility of scratching the lenses and reducing light output, avoid wiping with a dry cloth. To remove road dirt, wash with a mild soap solution followed by rinsing.

Do not use abrasive cleaning components, solvents, steel wool or other aggressive material to clean the lenses.

Tri-Fold Soft Tonneau Cover Care

For cleaning and protecting the vinyl Tri-Fold Tonneau cover, use Mopar Whitewall & Vinyl Top Cleaner and Mopar Leather and Vinyl Conditioner/Protectant.

PRESERVING THE BODYWORK

Washing

- Wash your vehicle regularly. Always wash your vehicle in the shade using Mopar Car Wash, or a mild car wash soap, and rinse the panels completely with water.

- If insects, tar, or other similar deposits have accumulated on your vehicle, use Mopar Super Kleen Bug and Tar Remover to remove.
- Use a high quality cleaner wax, such as Mopar Cleaner Wax to remove road film, stains and to protect your paint finish. Use precautions to not scratch the paint.
- Avoid using abrasive compounds and power buffing that may diminish the gloss or thin out the paint finish.

CAUTION!

- Do not use abrasive or strong cleaning materials such as steel wool or scouring powder that will scratch metal and painted surfaces.
- Use of power washers exceeding 1,200 psi (8,274 kPa) can result in damage or removal of paint and decals.

Bumper Care

The customer is responsible to clean and maintain the chrome components of the vehicle. Washing away road debris and salt using an automotive soap. Fascia/bumpers should be cleaned regularly using mild (neutral Ph) soap and water to maintain their luster and to prevent corrosion.

Your fascia/bumpers are susceptible to deterioration caused by salt, sodium chloride, magnesium chloride, calcium chloride, etc., and other road chemicals used to melt ice or control dust on dirt roads. Do not use harsh chemicals or a stiff brush. They can stain or damage the protective coating that helps keep them from corroding and tarnishing.

CAUTION!

- Do not use scouring pads, steel wool, a bristle brush, metal polishes, or oven cleaner. These products may damage the bumper's protective finish. Such damage is not covered by the New Vehicle Limited Warranty. Only car wash soap, Mopar Chrome Cleaner, or equivalent is recommended.

(Continued)

CAUTION! (Continued)

- Avoid products or automatic car washes that use acidic solutions, strong alkaline additives, or harsh brushes. Many after-market cleaners and automatic car washes may damage the bumper's protective finish. Such damage is not covered by the New Vehicle Limited Warranty. Only car wash soap, Mopar Chrome Cleaner, or equivalent is recommended.

Special Care

- If you drive on salted or dusty roads or if you drive near the ocean, hose off the undercarriage at least once a month.
- It is important that the drain holes in the lower edges of the doors, rocker panels, and trunk be kept clear and open.
- If you detect any stone chips or scratches in the paint, touch them up immediately.
- If your vehicle is damaged due to a collision or similar cause that destroys the paint and protective coating, have your vehicle repaired as soon as possible.

- If you carry special cargo such as chemicals, fertilizers, de-icer salt, etc., be sure that such materials are well packaged and sealed.
- If a lot of driving is done on gravel roads, consider mud or stone shields behind each wheel.
- Use Mopar Touch Up Paint on scratches as soon as possible. An authorized dealer has touch up paint to match the color of your vehicle.

Spray-On Bedliner – If Equipped

During ownership, the shine and luster of the Spray-On Bedliner can fade from oxidation, road dirt, heavy-duty hauling and hard water stains. Weathering and UV exposure will lead to fading.

To help maintain the appearance of your Spray-On Bedliner, the manufacturer recommends you periodically rinse all loose dirt from your truck bed and clean your truck at least twice per year using the Mopar Spray-On Bedliner Conditioner available at a local authorized dealer.

To Help Maintain The Appearance Of Your Spray-On Bedliner, Follow The Steps Below:

1. Rinse your truck bed out with water to remove any loose dirt and debris.
2. Mix a mild soap or detergent with water. Then apply solution with a soft cloth or brush.
3. Rinse bedliner with water.
4. Once dry, apply a small amount of Mopar Spray-On Bedliner Conditioner to a moist towel or sponge and wipe over the entire surface of the truck bedliner.

WARNING!

Do not use silicon-based protection products to clean your bedliner. Silicon-based products can become slippery and may result in personal injury.

Spray-On Bedliners are chemically-resistant to many different types of chemicals (including gasoline, oil, hydraulic fluids) for short periods of time. If a spill occurs on your Spray-On Bedliner, rinse the truck out as soon as possible to avoid permanent damage.

Repairing The Spray-On Bedliner

While extremely tough, it is possible to damage a Spray-On Bedliner. One common condition is when loading a heavy pallet and dragging that pallet across the floor of the bed. If a nail or sharp point is exposed under the weight of the pallet a scratch or tear is possible. While not covered by your new vehicle warranty, a cosmetic fix to cover the metal exposed by the scratch is required. To repair a tear or gouge, follow the directions provided in the Mopar Quick Repair Kit.

INTERIORS

SEATS AND FABRIC PARTS

Use Mopar Total Clean to clean fabric upholstery and carpeting.

WARNING!

Do not use volatile solvents for cleaning purposes. Many are potentially flammable, and if used in closed areas they may cause respiratory harm.

Stain Repel Fabric Cleaning Procedure — If Equipped

Stain Repel seats may be cleaned in the following manner:

- Remove as much of the stain as possible by blotting with a clean, dry towel.
- Blot any remaining stain with a clean, damp towel.
- For tough stains, apply Mopar Total Clean, or a mild soap solution to a clean, damp cloth and remove stain. Use a fresh, damp towel to remove soap residue.
- For grease stains, apply Mopar Multi-Purpose Cleaner to a clean, damp cloth and remove stain. Use a fresh, damp towel to remove soap residue.
- Do not use any harsh solvents or any other form of protectants on Stain Repel products.

Seat Belt Maintenance

Do not bleach, dye or clean the belts with chemical solvents or abrasive cleaners. This will weaken the fabric.

If the belts need cleaning, use a mild soap solution or lukewarm water. Do not remove the belts from the vehicle to wash them. Dry with a soft cloth.

Sun damage can also weaken the fabric. Replace the belts if they appear frayed or worn or if the buckles do not work properly.

NOTE:

If the belts retract slowly, inspect the upper turning loop for soiling. If soiling is present, clean with a wet soft cloth until all residue is removed.

WARNING!

A frayed or torn belt could rip apart in a collision and leave you with no protection. Inspect the belt system periodically, checking for cuts, frays, or loose parts. Damaged parts must be replaced immediately. Do not disassemble or modify the system. Seat belt assemblies must be replaced after a collision if they have been damaged (i.e., bent retractor, torn webbing, etc.).

PLASTIC AND COATED PARTS

Use Mopar Total Clean to clean vinyl upholstery.

CAUTION!

- Direct contact of air fresheners, insect repellents, suntan lotions, or hand sanitizers to the plastic, painted, or decorated surfaces of the interior may cause permanent damage. Wipe away immediately.
- Damage caused by these type of products may not be covered by your New Vehicle Limited Warranty.

Cleaning Plastic Instrument Cluster Lenses

The lenses in front of the instruments in this vehicle are molded in clear plastic. When cleaning the lenses, care must be taken to avoid scratching the plastic.

Clean with a wet soft cloth. A mild soap solution may be used, but do not use high alcohol content or abrasive cleaners. If soap is used, wipe clean with a clean damp cloth. Dry with a soft cloth.

LEATHER SURFACES

Mopar Total Clean is specifically recommended for leather upholstery.

Your leather upholstery can be best preserved by regular cleaning with a damp soft cloth. Small particles of dirt can act as an abrasive and damage the leather upholstery and should be removed promptly with a damp cloth. Stubborn soils can be removed easily with a soft cloth and Mopar Total Clean. Care should be taken to avoid soaking your leather upholstery with any liquid. Please do not use polishes, oils, cleaning fluids, solvents, detergents, or ammonia-based cleaners to clean your leather upholstery.

NOTE:

If equipped with light colored leather, it tends to show any foreign material, dirt, and fabric dye transfer more so than darker colors. The leather is designed for easy cleaning, and FCA recommends Mopar Total Clean leather cleaner applied on a cloth to clean the leather seats as needed.

CAUTION!

Do not use Alcohol and Alcohol-based and/or Ketone based cleaning products to clean leather upholstery, as damage to the upholstery may result.

GLASS SURFACES

All glass surfaces should be cleaned on a regular basis with Mopar Glass Cleaner, or any commercial household-type glass cleaner. Never use an abrasive type cleaner. Use caution when cleaning the inside rear window equipped with electric defrosters or windows equipped with radio antennas. Do not use scrapers or other sharp instruments that may scratch the elements.

When cleaning the rear view mirror, spray cleaner on the towel or cloth that you are using. Do not spray cleaner directly on the mirror.

TECHNICAL SPECIFICATIONS

VEHICLE IDENTIFICATION NUMBER

The Vehicle Identification Number (VIN) is found on the left front corner of the instrument panel, visible through the windshield.

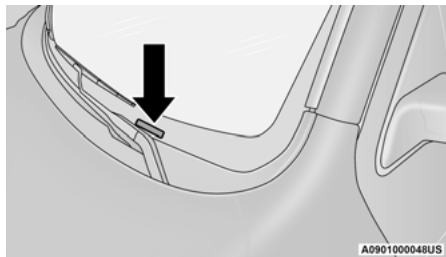

Vehicle Identification Number

NOTE:

It is illegal to remove or alter the VIN.

BRAKE SYSTEM

If power assist is lost for any reason (for example, repeated brake applications with the engine off), the brakes will still function. However, you will experience a substantial increase in braking effort to stop the vehicle.

If either the front or rear hydraulic system loses normal braking capability, the remaining system will still function with some loss of overall braking effectiveness. This will be evident by increased pedal travel during application, greater pedal force required to slow or stop, and the “Brake Warning Light” and the “ABS Warning Light” will activate during brake use.

WHEEL AND TIRE TORQUE SPECIFICATIONS

Proper lug nut/bolt torque is very important to ensure that the wheel is properly mounted to the vehicle. Any time a wheel has been removed and reinstalled on the vehicle, the lug nuts/bolts should be torqued using a properly calibrated torque wrench using a six sided (hex) deep wall socket.

TORQUE SPECIFICATIONS

Lug Nut/ Bolt Torque	Lug Nut/ Bolt Type	**Lug Nut/Bolt Size	Lug Nut/ Bolt Socket Size
130 Ft-Lbs (176 N·m)	Cone	M14 x 1.50	22 mm

**Use only authorized dealer recommended lug nuts/bolts and clean or remove any dirt or oil before tightening.

NOTE:

Do not oil wheel studs. For chrome wheels, do not substitute with chrome plated wheel nuts.

Inspect the wheel mounting surface prior to mounting the tire and remove any corrosion or loose particles.

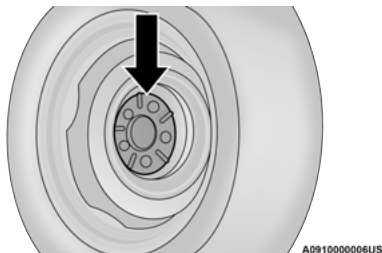

Wheel Mounting Surface

Tighten the lug nuts/bolts in a star pattern until each nut/bolt has been tightened twice. Ensure that the socket is fully engaged on the lug nut/bolt (do not insert it halfway).

After 25 miles (40 km), check the lug nut/bolt torque to be sure that all the lug nuts/bolts are properly seated against the wheel.

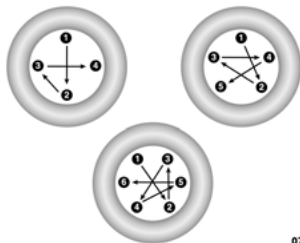

0705125609US

Four, Five, And Six Lug Nuts/Bolts Torque Pattern

WARNING!

To avoid the risk of forcing the vehicle off the jack, do not tighten the lug nuts/bolts fully until the vehicle has been lowered. Failure to follow this warning may result in personal injury.

FUEL REQUIREMENTS — GASOLINE ENGINE

While operating on gasoline with the required octane number, hearing a light knocking sound from the engine is not a cause for concern. However, if the engine is heard making a heavy knocking sound, see a dealer immediately. Use of gasoline with a lower than recommended

octane number can cause engine failure and may void or not be covered by the New Vehicle Limited Warranty.

Poor quality gasoline can cause problems such as hard starting, stalling, and hesitations. If you experience these symptoms, try another brand of gasoline before considering service for the vehicle.

3.6L ENGINE

Do not use E-85 flex fuel or ethanol blends greater than 15% in this engine.



This engine is designed to meet all emissions regulations and provide optimum fuel economy and performance when using high quality unleaded "Regular" gasoline having a posted octane number of 87 as specified by the (R+M)/2 method. The use of higher octane "Premium" gasoline is not required, as it will not provide any benefit over "Regular" gasoline in these engines.

5.7L ENGINE

Do not use E-85 flex fuel or ethanol blends greater than 15% in this engine.



This engine is designed to meet all emissions regulations and provide satisfactory fuel economy and performance when using high-quality unleaded gasoline having an octane range of 87 to 89 as specified by the (R+M)/2 method. The use of 89 octane "Plus" gasoline is recommended for optimum performance and fuel economy.

REFORMULATED GASOLINE

Many areas of the country require the use of cleaner burning gasoline referred to as "reformulated gasoline". Reformulated gasoline contains oxygenates and are specifically blended to reduce vehicle emissions and improve air quality.

The use of reformulated gasoline is recommended. Properly blended reformulated gasoline will provide improved performance and durability of engine and fuel system components.

MATERIALS ADDED TO FUEL

Besides using unleaded gasoline with the proper octane rating, gasolines that contain detergents, corrosion and stability additives are recommended. Using gasolines that have these additives will help improve fuel economy, reduce emissions, and maintain vehicle performance.



Designated TOP TIER Detergent Gasoline contains a higher level of detergents to further aid in minimizing engine and fuel system deposits. When available, the usage of TOP TIER Detergent Gasoline is recommended. Visit www.toptiergas.com for a list of TOP TIER Detergent Gasoline retailers.

Indiscriminate use of fuel system cleaning agents should be avoided. Many of these materials intended for gum and varnish removal may contain active solvents or similar ingredients. These can harm fuel system gasket and diaphragm materials.

GASOLINE/OXYGENATE BLENDS

Some fuel suppliers blend unleaded gasoline with oxygenates such as ethanol.

CAUTION!
<p>DO NOT use E-85, gasoline containing methanol, or gasoline containing more than 15% ethanol (E-15). Use of these blends may result in starting and drivability problems, damage critical fuel system components, cause emissions to exceed the applicable standard, and/or cause the Malfunction Indicator Light to illuminate. Please observe pump labels as they should clearly communicate if a fuel contains greater than 15% ethanol (E-15).</p>

Problems that result from using gasoline containing more than 15% ethanol (E-15) or gasoline containing methanol are not the responsibility of FCA and may void the New Vehicle Limited Warranty.

Do Not Use E-85 In Non-Flex Fuel Vehicles

Non-Flex Fuel Vehicles (FFV) are compatible with gasoline containing up to 15% ethanol (E-15). Use of gasoline with higher ethanol content may void the New Vehicle Limited Warranty.

If a Non-FFV vehicle is inadvertently fueled with E-85 fuel, the engine will have some or all of these symptoms:

- Operate in a lean mode.
- OBD II Malfunction Indicator Light on.
- Poor engine performance.
- Poor cold start and cold drivability.
- Increased risk for fuel system component corrosion.

CNG AND LP FUEL SYSTEM MODIFICATIONS

Modifications that allow the engine to run on Compressed Natural Gas (CNG) or Liquid Propane (LP) may result in damage to the engine, emissions, and fuel system components. Problems that result from running

CNG or LP are not the responsibility of FCA and may void the New Vehicle Limited Warranty.

METHYLCYCLOPENTADIENYL MANGANESE TRICARBONYL (MMT) IN GASOLINE

MMT is a manganese-containing metallic additive that is blended into some gasoline to increase octane. Gasoline blended with MMT provides no performance advantage beyond gasoline of the same octane number without MMT. Gasoline blended with MMT reduces spark plug life and reduces emissions system performance in some vehicles. FCA recommends that gasoline without MMT be used in your vehicle. The MMT content of gasoline may not be indicated on the gasoline pump; therefore, you should ask the gasoline retailer whether the gasoline contains MMT. MMT is prohibited in Federal and California reformulated gasoline.

FUEL SYSTEM CAUTIONS

CAUTION!

Follow these guidelines to maintain your vehicle's performance:

(Continued)

CAUTION! *(Continued)*

- The use of leaded gasoline is prohibited by Federal law. Using leaded gasoline can impair engine performance and damage the emissions control system.
- An out-of-tune engine or certain fuel or ignition malfunctions can cause the catalytic converter to overheat. If you notice a pungent burning odor or some light smoke, your engine may be out of tune or malfunctioning and may require immediate service. Contact an authorized dealer for service assistance.
- The use of fuel additives, which are now being sold as octane enhancers, is not recommended. Most of these products contain high concentrations of methanol. Fuel system damage or vehicle performance problems resulting from the use of such fuels or additives is not the responsibility of FCA and may void or not be covered under the New Vehicle Limited Warranty.

NOTE:

Intentional tampering with the emissions control system can result in civil penalties being assessed against you.

FUEL REQUIREMENTS – DIESEL ENGINE

Federal law requires that you must fuel this vehicle with Ultra Low Sulfur Highway Diesel fuel (15 ppm Sulfur maximum) and prohibits the use of Low Sulfur Highway Diesel fuel (500 ppm Sulfur maximum) to avoid damage to the emissions control system.

Use good quality diesel fuel from a reputable supplier in your vehicle. For most year-round service, No. 2 diesel fuel meeting ASTM (formerly known as the American Society for Testing and Materials) specification D-975 Grade S15 will provide good performance. If the vehicle is exposed to extreme cold (below 20°F or -7°C), or is required to operate at colder-than-normal conditions for prolonged periods, use Climatized Number 2 diesel fuel or dilute the Number 2 diesel fuel with 50% Number 1 diesel fuel. This will provide better protection from fuel gelling or wax-plugging of the fuel filters.

WARNING!

Do not use alcohol or gasoline as a fuel blending agent. They can be unstable under certain conditions and hazardous or explosive when mixed with diesel fuel.

Diesel fuel is seldom completely free of water. To prevent fuel system trouble, drain the accumulated water from the fuel/water separator filter using the fuel/water separator drain provided on the fuel filter housing. If you buy good quality fuel and follow the cold weather advice above, fuel conditioners should not be required in your vehicle. If available in your area, a high cetane “premium” diesel fuel may offer improved cold-starting and warm-up performance.

CAUTION!

If the “Water in Fuel Indicator Light” remains on, DO NOT START engine before you drain the water from the fuel filter(s) to avoid engine damage → page 412.

DIESEL FUEL SPECIFICATIONS

This diesel engine has been developed to take advantage of the high energy content and generally lower cost Number 2 Ultra Low Sulfur diesel fuel or Number 2 Ultra Low Sulfur Climatized diesel fuels.

NOTE:

- If you accidentally fill the fuel tank with gasoline on your diesel vehicle, do not start the engine. Damage to the engine and fuel system could occur. Please call an authorized dealer for service.
- A maximum blend of 5% biodiesel meeting ASTM specification D-975 may be used with your diesel engine without any adjustments to regular service schedules.
- Commercially available fuel additives are not necessary for the proper operation of your diesel engine.
- Number 1 Ultra Low Sulfur diesel fuel should only be used where extended arctic conditions (-10°F or -23°C) exist.

BIODIESEL FUEL REQUIREMENTS

A maximum blend of 5% biodiesel meeting ASTM specification D975 is recommended for use with your diesel engine. If frequent operation with Biodiesel blends that are between 6% and 20% (B6–B20) is desired, the maintenance schedule is subject to shorter intervals.

The oil and filter change along with fuel filter replacement is subject to shorter intervals when operating your engine on biodiesel greater than 5%. Do not use biodiesel greater than 20%.

For regular use of biodiesel blends between 6% and 20% (B6–B20) it is important that you understand and comply with these requirements. For further direction
 ⇨ page 403.

CAUTION!

Failure to comply with Oil Change requirements for vehicles operating on biodiesel blends between 6% and 20% (B6–B20) will result in premature engine wear. Such wear is not covered by the New Vehicle Limited Warranty.

Biodiesel is a fuel produced from renewable resources typically derived from animal fat, rapeseed oil (Rapeseed Methyl Ester (RME) base), or soybean oil (Soy Methyl Ester (SME or SOME) base).

Biodiesel fuel has inherent limitations which require that you understand and adhere to the following requirements if you use blends of Biodiesel between 6% and 20% (B6–B20). There are no unique restrictions for the use of B5.

CAUTION!

Use of blends greater than 20% is not approved. Use of blends greater than 20% can result in engine damage. Such damage is not covered by the New Vehicle Limited Warranty.

CAUTION!

In the event that the vehicle is filled with biodiesel and not used for more than a month, the fuel should either be used up by driving (up to quarter tank) and filled with standard diesel blends with less than 5% that is normally available. This will help prevent the fuel filter clogging and potential damage to the fuel injection system due to degraded biodiesel, which is not covered by the New Vehicle Limited Warranty.

Biodiesel Fuel Properties – Low Ambient Temperatures

Biodiesel fuel may gel or solidify at low ambient temperatures, which may pose problems for both storage and operation. Precautions can be necessary at low ambient temperatures, such as storing the fuel in a heated building or a heated storage tank, or using cold temperature additives.

Fuel Quality — Must Comply With ASTM Standards

The quality of Biodiesel fuel may vary widely. Only fuel produced by a BQ9000 supplier to the following specifications may be blended to meet Biodiesel blend B6 – B20 fuel meeting ASTM specification D-7467:

Petrodiesel fuel meeting ASTM specification D-975 and Biodiesel fuel (B100) meeting ASTM specification D-6751

Fuel Oxidation Stability — Must Use Fuel Within Six Months Of Manufacture

Biodiesel fuel has poor oxidation stability which can result in long term storage problems. Fuel produced to approved ASTM standards, if stored properly, provides for protection against fuel oxidation for up to six months.

Fuel Water Separation — Must Use Mopar Approved Fuel Filter Elements

Biodiesel fuel has a natural affinity to water and water accelerates microbial growth. Your Mopar filtration system is designed to provide adequate fuel water separation capabilities.

Fuel In Oil Dilution — Must Adhere To Required Oil Change Interval

Fuel dilution of lubricating oil has been observed with the use of Biodiesel fuel. Fuel in oil must not exceed 5%. To ensure this limit is met your oil change interval must be maintained with in the suggested schedule. The regular use of biodiesel between 6% and 20% requires intervals shorter than the outlined 10,000 miles (16,100 km) and must not exceed the suggested schedule. When routinely operating on biodiesel between 6% and 20%, oil and filter replacement intervals must not exceed 8,000 Miles (12,900 km) or six months, which ever comes first.

Biodiesel Fuel Filter Change Intervals

The use of biodiesel requires more frequent fuel filter change intervals. When operating on biodiesel between 6% and 20%, fuel filter replacement intervals should be every second oil change, and must not exceed 16,000 miles (25,750 km).

NOTE:

Under no circumstances should oil change intervals exceed 8,000 miles (12,875 km) or six months, if regular operation occurs with 6% - 20% biodiesel blends. Under no circumstances should fuel filter replacement intervals exceed every second oil change and must not exceed 16,000 miles (25,750 km), if regular operation occurs with 6% - 20% biodiesel blends. Failure to comply with these oil change and fuel filter requirements for vehicles operating on biodiesel blends up to B20 may result in premature engine wear. Such wear is not covered by the New Vehicle Limited Warranty. The engine may suffer severe damage if operated with concentrations of biodiesel higher than 20%.

FLUID CAPACITIES

	US	Metric
Fuel (Approximate)		
1500 Regular Cab Shortbed/Crew Quad Cab Models	23 Gallons	87 Liters
1500 Regular Cab Shortbed/Crew Quad Cab Models	26 Gallons	98 Liters
1500 Regular Cab Longbed/Crew Quad Cab Models (Optional)	33 Gallons	121 Liters
Engine Oil With Filter		
3.6L Engine	5 Quarts	4.7 Liters
5.7L Engine	7 Quarts	6.6 Liters
Cooling System		
3.6L Engine	13.7 Quarts	13 Liters
3.6L Motor Generator Unit	1.8 Quarts	1.7 Liters
5.7L Engine	18.3 Quarts	17.3 Liters
Fuel (Approximate)		
3.0L Turbo Diesel Engine	26 Gallons	98.5 Liters
Diesel Exhaust Fluid Tank		
Tradesman/Rebel Models	5.14 Gallons	19.5 Liters
All Other Models	5.74 Gallons	21.7 Liters
Engine Oil With Filter		
3.0L Turbo Diesel Engine	8.5 Quarts	8.0 Liters
Cooling System		
3.0L Turbo Diesel Engine	11.6 Quarts	11 Liters

ENGINE FLUIDS AND LUBRICANTS

Component	Fluid, Lubricant, or Genuine Part
Gas Engine Coolant	We recommend you use Mopar Antifreeze/Coolant 10 Year/150,000 Mile (240,000 km) Formula OAT (Organic Additive Technology).
Motor Generator Unit – 3.6L Engine (If Equipped)	We recommend you use Mopar Antifreeze/Coolant 10 Year/150,000 Mile (240,000 km) Formula OAT (Organic Additive Technology).
Engine Oil – 3.6L Engine	We recommend you use API Certified SAE OW-20 engine oil, meeting the requirements of FCA Material Standard MS-6395 such as Mopar, Pennzoil, and Shell Helix. Refer to your engine oil filler cap for correct SAE grade.
Engine Oil – 5.7L Engine	We recommend you use API Certified SAE 5W-20 engine oil, meeting the requirements of FCA Material Standard MS-6395 such as Mopar, Pennzoil, and Shell Helix. Refer to your engine oil filler cap for correct SAE grade.
Gas Engine Oil Filter	We recommend you use Mopar brand engine oil filters.
Fuel Selection – 3.6L Engine	87 Octane (R+M)/2 Method, 0-15% ethanol (Do not use E-85).
Fuel Selection – 5.7L Engines	89 Octane Recommended - 87 Octane Acceptable (R+M)/2 Method, 0-15% ethanol (Do not use E-85).
Diesel Engine Coolant	We recommend you use Mopar Antifreeze/Coolant 10 Year/150,000 Mile (240,000 km) Formula OAT (Organic Additive Technology).
Engine Oil – 3.0L Turbo Diesel Engine	We recommend you use 5W-40 synthetic engine oil such as Mopar that meets FCA Material Standard MS-12991 and the API SN engine oil category is required.
Diesel Engine Oil Filter	We recommend you use Mopar engine oil filters. Using an oil filter that does not meet FCA's filtration requirements can severely impact engine life and reliability.

Component	Fluid, Lubricant, or Genuine Part
Fuel Filters — 3.0L Turbo Diesel Engine	<p>We recommend you use Mopar fuel filter. Must meet 3 micron rating. Using a fuel filter that does not meet FCA's filtration and water separating requirements can severely impact fuel system life and reliability. Under normal conditions the diesel fuel filter should be replaced every 20,000 miles (32,000 km) (every other oil change). If the vehicle is being used in severe operating conditions, or In certain geographical areas of the country (Pennsylvania, New York, Ohio, Maryland, West Virginia, Arkansas, Oklahoma, Kansas, Iowa, Missouri and Nebraska) due to fuel cleanliness issues, it's recommended to replace the fuel filter every 10,000 miles (16,000 km).</p>
Fuel Selection — 3.0L Turbo Diesel Engine	<p>Use good quality diesel fuel from a reputable supplier in your vehicle. Federal law requires that you must fuel this vehicle with Ultra Low Sulfur Highway Diesel fuel (15 ppm Sulfur maximum) and prohibits the use of Low Sulfur Highway Diesel fuel (500 ppm Sulfur maximum) to avoid damage to the emissions control system.</p> <p>For most year-round service, Number 2 diesel fuel meeting ASTM specification D-975 Grade S15 will provide good performance. We recommend you use a blend of up to 5% biodiesel, meeting ASTM specification D-975 with your diesel engine.</p> <p>This vehicle is compatible with biodiesel blends greater than 5% but no greater than 20% biodiesel meeting ASTM specification D-7467 provided the shortened maintenance intervals are followed as directed.</p>
Diesel Exhaust Fluid	<p>Mopar Diesel Exhaust Fluid (API Certified) (DEF) or equivalent that has been API Certified to the ISO 22241 standard. Use of fluids not API Certified to ISO 22241 may result in system damage.</p>

NOTE:

If Climatized or Number 1 ULSD fuel is not available, and you are operating below 20° F (-6° C), in sustained arctic conditions, Mopar Premium Diesel Fuel Treatment (or equivalent) is recommended to avoid gelling.

CAUTION!

- Mixing of engine coolant (antifreeze) other than specified Organic Additive Technology (OAT) engine coolant (antifreeze), may result in engine damage and may decrease corrosion protection. Organic Additive Technology (OAT) engine coolant is different and should not be mixed with Hybrid Organic Additive Technology (HOAT) engine coolant (antifreeze) or any "globally compatible" coolant (antifreeze). If a non-OAT engine coolant (antifreeze) is introduced into the cooling system in an emergency, the cooling system will need to be drained, flushed, and refilled with fresh OAT coolant (conforming to MS.90032), by an authorized dealer as soon as possible.

(Continued)

CAUTION! *(Continued)*

- Do not use water alone or alcohol-based engine coolant (antifreeze) products. Do not use additional rust inhibitors or anti-rust products, as they may not be compatible with the radiator engine coolant and may plug the radiator.
- This vehicle has not been designed for use with propylene glycol-based engine coolant (antifreeze). Use of propylene glycol-based engine coolant (antifreeze) is not recommended.

CHASSIS FLUIDS AND LUBRICANTS

Component	Fluid, Lubricant, or Genuine Part
Automatic Transmission	Use only Mopar ZF 8&9 Speed ATF Automatic Transmission Fluid, or equivalent. Failure to use the correct fluid may affect the function or performance of your transmission.
Transfer Case – 48-11 Active On-Demand 2–speed Transfer Case (With 4WD AUTO)	We recommend you use Mobil Fluid LT.
Transfer Case – 48-12 Part Time 2–Speed Transfer Case (Without 4WD AUTO)	We recommend you use Shell Spirax S2 ATF A389.
Front Axle	We recommend you use Mopar GL-5 Synthetic Axle Lubricant SAE 75W-85.
Rear Axle (3.21/3.55)	We recommend you use Mopar Synthetic Gear Lubricant SAE 75W-90 (MS-A0160). Limited-Slip Rear Axles require the addition of 5 oz. (148 ml) Mopar Limited Slip Additive (MS-10111).
Rear Axle (3.92)	We recommend you use Mopar Synthetic Gear Lubricant SAE 75W-140 (MS-8985). Limited-Slip Rear Axles require the addition of 5 oz. (148 ml) Mopar Limited Slip Additive (MS-10111).
Max Tow Rear Axle (3.92)	We recommend You Use Dana SAE 80W90 Axle Lubricant.
Brake Master Cylinder	We recommend you use Mopar DOT 3 Brake Fluid, SAE J1709.

CUSTOMER ASSISTANCE

SUGGESTIONS FOR OBTAINING SERVICE FOR YOUR VEHICLE

PREPARE FOR THE APPOINTMENT

All work to be performed may not be covered by the warranty. Discuss additional charges with the service manager. Keep a maintenance log of your vehicle's service history. This can often provide a clue to the current problem.

PREPARE A LIST

Make a written list of your vehicle's problems or the specific work you want done. If you've had an accident or work done that is not on your maintenance log, let the service advisor know.

BE REASONABLE WITH REQUESTS

If you list a number of items and you must have your vehicle by the end of the day, discuss the situation with the service advisor and list the items in order of priority. At many authorized dealers, you may obtain a rental vehicle

(additional charges may apply). If you need a rental, it is advisable to make these arrangements when you call for an appointment.

IF YOU NEED ASSISTANCE

FCA US LLC and its authorized dealers are vitally interested in your satisfaction. We want you to be happy with our products and services.

Warranty service must be done by an authorized dealer. We strongly recommend that you take the vehicle to an authorized dealer. They know your vehicle the best, and are most concerned that you get prompt and high quality service. FCA US LLC's authorized dealers have the facilities, factory-trained technicians, special tools, and the latest information to ensure the vehicle is fixed correctly and in a timely manner.

This is why you should always talk to an authorized dealer's service manager first. If for some reason you are still not satisfied, talk to the general manager or owner of the authorized dealer. They want to know if you need assistance. If an authorized dealer is unable to resolve the concern, you may contact the FCA US LLC's Customer Assistance center.

Any communication to FCA US LLC's customer center should include the following information:

- Owner's name and address
- Owner's telephone number (home, mobile, and office)
- Authorized dealer name
- Vehicle Identification Number (VIN)
- Vehicle delivery date and mileage

FCA US LLC CUSTOMER CENTER

P.O. Box 21-8004

Auburn Hills, MI 48321-8004

Phone: (866) 726-4636

FCA CANADA INC. CUSTOMER CENTER

P.O. Box 1621

Windsor, Ontario N9A 4H6

Phone: (800) 465-2001 English /
(800) 387-9983 French

MEXICO

Av. Prolongacion Paseo de la Reforma, 1240

Sante Fe C.P. 05109

Mexico, D. F.

In Mexico City: 800-505-1300

Outside Mexico City: +(52) 55 50817568

PUERTO RICO AND US VIRGIN ISLANDS

FCA Caribbean LLC

P.O. Box 191857

San Juan 00919-1857

Phone: (866) 726-4636

Fax: (787) 782-3345

CUSTOMER ASSISTANCE FOR THE HEARING OR SPEECH IMPAIRED (TDD/ TTY)

To assist customers who have hearing difficulties, FCA US LLC has installed special TDD (Telecommunication Devices for the Deaf) equipment at its customer center. Any hearing or speech impaired customer, who has access to a TDD or a conventional teletypewriter (TTY) in the United States, can communicate with FCA US LLC by dialing 1-800-380-2479.

Canadian residents with hearing difficulties that require assistance can use the special needs relay service offered by Bell Canada. For TTY teletypewriter users, dial 711 and for Voice callers, dial 1-800-855-0511 to connect with a Bell Relay Service operator.

SERVICE CONTRACT

You may have purchased a service contract for a vehicle to help protect you from the high cost of unexpected repairs after the FCA US LLC's New Vehicle Limited Warranty expires. The Mopar Vehicle Protection plans are the ONLY vehicle extended protection plans authorized, endorsed and backed by FCA US LLC to provide additional protection beyond your vehicle's warranty. If you purchased a Mopar Vehicle Protection Plan, you will receive Plan Provisions and an Owner Identification Card in the mail within three weeks of the vehicle delivery date. If you have any questions about the service contract, call the FCA US LLC's Service Contract National Customer Hotline at 1-800-521-9922 (Canadian residents, call (800) 465-2001 English / (800) 387-9983 French).

FCA US LLC is not responsible for any service contract you may have purchased from another manufacturer. If you require service after the FCA US LLC New Vehicle Limited Warranty expires, please refer to the contract documents, and contact the person listed in those documents.

We appreciate that you have made a major investment when you purchased the vehicle. An authorized dealer has also made a major investment in facilities, tools, and training to ensure that you are absolutely delighted with the ownership experience.

WARNING!

Engine exhaust (internal combustion engines only), some of its constituents, and certain vehicle components contain, or emit, chemicals known to the State of California to cause cancer and birth defects, or other reproductive harm. In addition, certain fluids contained in vehicles and certain products of component wear contain, or emit, chemicals known to the State of California to cause cancer and birth defects, or other reproductive harm.

WARRANTY INFORMATION

See the Warranty Information for the terms and provisions of FCA US LLC warranties applicable to this vehicle and market. Refer to www.mopar.com/om for further information.

MOPAR® PARTS

Mopar® original equipment parts & accessories and factory filled fluids are available from an authorized dealer. They are recommended for your vehicle to keep it operating at its best and maintain its original condition.

REPORTING SAFETY DEFECTS

IN THE 50 UNITED STATES AND WASHINGTON, D.C.

If you believe that your vehicle has a defect that could cause a crash or cause injury or death, you should immediately inform the National Highway Traffic Safety Administration (NHTSA) in addition to notifying FCA US LLC.

If NHTSA receives similar complaints, it may open an investigation, and if it finds that a safety defect exists in a group of vehicles, it may order a recall and remedy campaign. However, NHTSA

cannot become involved in individual problems between you, an authorized dealer or FCA US LLC.

To contact NHTSA, you may call the Vehicle Safety Hotline toll free at 1-888-327-4236 (TTY: 1-800-424-9153); or go to <http://www.safercar.gov>; or write to: Administrator, NHTSA, 1200 New Jersey Avenue, SE., West Building, Washington, D.C. 20590. You can also obtain other information about motor vehicle safety from <http://www.safercar.gov>.

IN CANADA

If you believe that your vehicle has a safety defect, you should contact the Customer Service Department immediately. Canadian customers who wish to report a safety defect to the Canadian government should contact Transport Canada, Motor Vehicle Defect Investigations and Recalls at 1-800-333-0510 or go to wwwapps.tc.gc.ca/Saf-Sec-Sur/7/PCDB-BDPP.

PUBLICATION ORDER FORMS

To order the following manuals, you may use either the website or the phone numbers listed below.

Service Manuals

These comprehensive Service Manuals provide a complete working knowledge of the vehicle, system, and/or components and is written in straightforward language with illustrations, diagrams, and charts.

Diagnostic Procedure Manuals

Diagnostic Procedure Manuals are filled with diagrams, charts and detailed illustrations. These manuals make it easy to find and fix problems on computer-controlled vehicle systems and features. They show exactly how to find and correct problems, using step-by-step troubleshooting and drivability procedures, proven diagnostic tests and a complete list of all tools and equipment.

Owner's Manuals

These Owner's Manuals have been prepared with the assistance of service and engineering specialists to acquaint you with specific FCA US LLC vehicles.

To access your Owner's Information online, visit www.mopar.com/om

To order a hard copy of your Owner's Information, visit:

- www.techauthority.com (US)

Or

Call Tech Authority toll free at:

- **1-800-890-4038 (US)**
- **1-800-387-1143 (Canada)**

GENERAL INFORMATION

The following regulatory statement applies to all Radio Frequency (RF) devices equipped in this vehicle:

This device complies with Part 15 of the FCC Rules and with Innovation, Science and Economic Development Canada license-exempt RSS standard(s). Operation is subject to the following two conditions:

1. This device may not cause harmful interference, and
2. This device must accept any interference received, including interference that may cause undesired operation.

Le présent appareil est conforme aux CNR d'Innovation, Science and Economic Development applicables aux appareils radio exempts de licence. L'exploitation est autorisée aux deux conditions suivantes:

1. l'appareil ne doit pas produire de brouillage, et
2. l'utilisateur de l'appareil doit accepter tout brouillage radioélectrique subi, même si le brouillage est susceptible d'en compromettre le fonctionnement.

La operación de este equipo está sujeta a las siguientes dos condiciones:

1. es posible que este equipo o dispositivo no cause interferencia perjudicial y
2. este equipo o dispositivo debe aceptar cualquier interferencia, incluyendo la que pueda causar su operación no deseada.

NOTE:

Changes or modifications not expressly approved by the party responsible for compliance could void the user's authority to operate the equipment.

INDEX

- A**
- Adaptive Cruise Control (ACC) (Cruise Control)..... 177, 179
 - Adding Engine Coolant (Antifreeze)422
 - Adding Fuel..... 208, 210
 - Additives, Fuel 469
 - Adjust
 - Down 36
 - Forward 36
 - Rearward..... 36
 - Up..... 36
 - Adjustable Pedals..... 43
 - Advance Phone Connectivity 279
 - Air Bag
 - Air Bag Operation 344
 - Air Bag Warning Light 342, 345
 - Enhanced Accident Response 353, 394
 - Event Data Recorder (EDR) 394
 - Front Air Bag 345
 - If Deployment Occurs 352
 - Knee Impact Bolsters 349
 - Maintaining Your Air Bag System 354
 - Maintenance 354
 - Redundant Air Bag Warning Light 343
 - Transporting Pets 369
 - Air Bag Light 126, 342, 369
 - Air Cleaner, Engine (Engine Air Cleaner Filter) 411
 - Air Conditioner Maintenance 415
 - Air Conditioner Refrigerant 415
 - Air Conditioner System 415
 - Air Conditioning..... 63
 - Air Conditioning Filter.....67, 415
 - Air Conditioning System 65
 - Air Conditioning, Operating Tips..... 66
 - Air Filter 411
 - Air Pressure
 - Tires 450
 - Air Suspension 165, 169
 - Alarm
 - Security Alarm 26, 127
 - Alterations/Modifications
 - Vehicle..... 11
 - Antifreeze (Engine Coolant) 422, 474
 - Disposal 423
 - Anti-Lock Brake System (ABS) 310
 - Anti-Lock Warning Light 132
 - Assist, Hill Start..... 317
 - Audio Settings..... 266
 - Audio Systems (Radio)..... 236
 - Auto Down Power Windows 78
 - Automatic Door Locks..... 30
 - Automatic Headlights.....54
 - Automatic High Beams.....53
 - Automatic Tailgate Release 85
 - Automatic Temperature Control (ATC).....65
 - Automatic Transmission..... 156, 426
 - Adding Fluid 426
 - Fluid And Filter Change..... 426
 - Fluid Change..... 426
 - Fluid Level Check..... 426
 - Fluid Type 426, 478
 - Special Additives 426
 - Automatic Transmission Limp Home Mode... 159
 - AutoPark 141
 - AUX Camera 204, 208
 - Auxiliary Driving Systems 318
 - Axle Fluid..... 426, 478
 - Axle Lubrication 426
- B**
- Back-Up..... 202
 - Back-Up Camera 202
 - Battery 128, 409
 - Charging System Light 128
 - Keyless Key Fob Replacement 18
 - Battery Saver Feature 57
 - Belts, Seat 369

Blind Spot Monitoring.....	318	Carbon Monoxide Warning.....	371, 372	Compact Spare Tire	455
Bluetooth		Cargo Light.....	56	Connected Services	282
Connecting To A Particular Mobile Phone		CD	268	Connected Services FAQ	301
Or Audio Device After Pairing	275	Cellular Phone	309	Connected Services Features	286
Body Builders Guide	11	Center High Mounted Stop Light.....	442	Connected Services, Getting Started	284
Body Mechanism Lubrication	418	Center Seat Storage Compartment.....	68	Connected Services, Introduction	282
B-Pillar Location.....	447	Charge Air Cooler.....	424	Contract, Service.....	480
Brake Assist System	311	Chart, Tire Sizing.....	444	Controls	259
Brake Control System	311	Check Engine Light (Malfunction Indicator		Cooling Pressure Cap (Radiator Cap)	423
Brake Fluid	425, 478	Light).....	138	Cooling System	421
Brake System	425, 467	Checking Your Vehicle For Safety	369	Adding Coolant (Antifreeze)	422
Fluid Check	425	Checks, Safety	369	Coolant Level.....	421, 423
Master Cylinder	425	Child Restraint	355	Cooling Capacity	474
Parking.....	151	Child Restraints		Disposal Of Used Coolant	423
Warning Light	126	Booster Seats.....	358	Drain, Flush, And Refill	422
Brake/Transmission Interlock	155	Child Seat Installation	364, 365	Inspection	423
Bulb Replacement	437	How To Stow An unused ALR Seat Belt	363	Points To Remember	424
Bulbs, Light.....	371, 437	Infant And Child Restraints.....	357	Pressure Cap	423
C		Locating The LATCH Anchorages	362	Radiator Cap.....	423
Camera.....	202	Lower Anchors And Tethers For Children..	360	Selection Of Coolant	
Camera, AUX.....	204, 208	Older Children And Child Restraints	357	(Antifreeze).....	422, 474, 475
Camera, Rear	202, 204	Seating Positions.....	359	Corrosion Protection	461
Camper.....	97	Clean Air Gasoline.....	469	Cruise Control	
Capacities, Fuel	474	Cleaning		Accel/Decel	178
Caps, Filler		Wheels	456	Cancel.....	179
Oil (Engine).....	404	Climate Control.....	60	Resume	179
Radiator (Coolant Pressure).....	423	Automatic	60	Cruise Control (Speed Control).....	177, 179
Car Washes	462	Manual	63	Cruise Light	136
		Cold Weather Operation	146	Customer Assistance	479
				Cybersecurity	236

D

Daytime Running Lights.....	53
Dealer Service	409
Defroster, Rear Window.....	63
Defroster, Windshield.....	63, 369
Deleting A Phone	275
Diagnostic System, Onboard	137
Diesel Fuel.....	471
Diesel Fuel Requirements	471
Bulk Storage Of.....	210
Diesel Fuel System, Re-Priming.....	414
Differential, Limited Slip	174
Disable Vehicle Towing.....	392
Disc Drive	268
Disconnecting.....	275
Disposal	
Antifreeze (Engine Coolant).....	423
Disturb.....	278
Door Ajar.....	129
Door Ajar Light.....	129
Door Locks	
Automatic.....	30
Doors.....	27
Draining Fuel/Water Separator Filter	412
Driver Memory Presets	265
Driver's Seat Back Tilt	34
Driving	
Through Flowing, Rising, Or Shallow	
Standing Water	234
Dual Rear Wheels.....	467

E

Electric Brake Control System.....	311
Anti-Lock Brake System.....	310
Electronic Roll Mitigation.....	312, 318
Electric Parking Brake.....	151
Electrical Power Outlets	74
Electronic Range Select (ERS)	159
Electronic Stability Control (ESC)	312
Electronic Throttle Control Warning Light.....	128
Electronically Shifted Transfer Case	161, 163
Emergency Braking.....	327
Emergency Gas Can Refueling.....	389
Emergency, In Case Of	
Freeing Vehicle When Stuck.....	391
Hazard Warning Flasher	373
Jump Starting	386
Emission Control System Maintenance	138
Engine.....	404
Air Cleaner	411
Block Heater.....	150
Break-In Recommendations	150
Compartment	404, 405, 406, 407
Compartment	
Identification	404, 405, 406, 407
Coolant (Antifreeze).....	475
Exhaust Gas Caution	371, 372
Fails To Start	144
Flooded, Starting.....	144
Fuel Requirements	468, 474
Idling	148

Jump Starting	386
Oil	410, 474, 475
Oil Filler Cap	404
Oil Filter	410
Oil Selection.....	410, 474
Oil Synthetic.....	410
Overheating.....	389
Starting.....	143, 144

Enhanced Accident Response

Feature	353, 394
Entry System, Illuminated	58
Ethanol.....	469
Exhaust Gas Cautions	371, 372
Exhaust System	371, 420
Exterior Lighting.....	52
Exterior Lights	52, 371

F

Family Alerts	300
Filters	
Air Cleaner	411
Air Conditioning	67, 415
Engine Fuel.....	412
Engine Oil	410, 475
Engine Oil Disposal.....	410
Flashers	
Turn Signals.....	55, 136, 371
Flash-To-Pass.....	54
Flat Tire Stowage	384
Fluid Capacities	474

Fluid Leaks	371	G	Heated Mirrors	48	
Fluid Level Checks		Garage Door Opener (HomeLink)	49	Heated Seats	38
Brake	425	Gasoline, Clean Air	469	Heater, Engine Block	150
Fluid, Brake	478	Gasoline, Reformulated	469	High Beam/Low Beam Select (Dimmer) Switch	53
Fog Lights	55, 441	Gauges		Hill Descent Control	315
Fold-Flat Seats	34	Voltage	146	Hill Descent Control Indicator	315
Forward Collision Warning	324	Glass Cleaning	466	Hill Start Assist	317
Four Wheel Drive	161	Grocery Bag Retainer	39	Hitches	
Four-Way Hazard Flasher	373	Gross Axle Weight Rating	215	Trailer Towing	218
Freeing A Stuck Vehicle	391	Gross Vehicle Weight Rating	214	HomeLink (Garage Door Opener)	49
Front Axle (Differential)	426	Guide		Hood Prop	84
Fuel	210, 468, 471	Body Builders	11	Hood Release	84
Adding	208, 210	GVWR	213		
Additives	469	H		I	
Clean Air	469	Hazard		Ignition	21
Ethanol	469	Driving Through Flowing, Rising, Or Shallow Standing Water	234	Switch	21
Filter	412	Hazard Warning Flashers	373	Illuminated Entry	58
Gasoline	468	Head Restraints	40	Inside Rearview Mirror	44, 45, 373
Light	131	Head Rests	40	Instrument Cluster	110, 113
Materials Added	469	Headlights	439	Descriptions	110, 113, 136
Methanol	469	Cleaning	462	Display	114
Octane Rating	468, 469, 475	High Beam	53	Instrument Panel Lens Cleaning	465
Requirements	468, 471, 474	High Beam/Low Beam Select Switch	53	Integrated Trailer Brake Control	223
Specifications	471	Lights On Reminder	55	Interior Appearance Care	464
Tank Capacity	474	Passing	54	Interior Lights	57
Fuses	427	Switch	52	Intervention Regeneration Strategy	121, 414
				Inverter Outlet (115V)	75

J

Jack Location.....	377
Jump Starting.....	386

K

Key Fob	
Programming Additional Key Fobs.....	20
Key Fob Battery Service (Remote Keyless Entry).....	18
Key Fob Programming (Remote Keyless Entry).....	20
Keyless Enter-N-Go.....	28, 143
Passive Entry.....	28
Keys.....	17

L

Lane Change And Turn Signals.....	55
Lane Change Assist.....	55
LaneSense.....	199
Lap/Shoulder Belts.....	336
Latches.....	371
Hood.....	84
Lead Free Gasoline.....	468
Leaks, Fluid.....	371
Life Of Tires.....	452
Light Bulbs.....	371, 437

Lights.....	371
Air Bag.....	126, 342, 369
Brake Assist Warning.....	314
Brake Warning.....	126
Bulb Replacement.....	437
Cargo.....	56
Center Mounted Stop.....	442
Courtesy/Reading.....	57
Cruise.....	136
Daytime Running.....	53
Electronic Stability Program (ESP)	
Indicator.....	128
Exterior.....	52, 371
Fog.....	441
Hazard Warning Flasher.....	373
Headlights.....	52, 54
High Beam.....	53
High Beam/Low Beam Select.....	53
Hill Descent Control Indicator.....	315
Illuminated Entry.....	58
Interior.....	57
Lights On Reminder.....	55
Low Fuel.....	131
Malfunction Indicator (Check Engine).....	130
Park.....	135
Passing.....	54

Seat Belt Reminder.....	126
Security Alarm.....	127
Service.....	437
Traction Control.....	314
Turn Signals.....	55, 136, 371, 439, 441
Warning Instrument Cluster	
Descriptions.....	128, 136
Limited-Slip Differential.....	174, 427
Load Shed Battery Saver Mode.....	125
Load Shed Battery Saver On.....	125
Load Shed Electrical Load Reduction.....	125
Load Shed Intelligent Battery Sensor.....	125
Loading Vehicle.....	213
Tires.....	447
Locks	
Automatic Door.....	30
Child Protection.....	31
Power Door.....	28
Low Tire Pressure System.....	327
Lubrication, Body.....	418
Lug Nuts.....	467
Lug Nuts/Bolts.....	467

M

Maintenance.....	81, 84
Maintenance Free Battery.....	409
Maintenance Schedule.....	395, 399, 400

Malfunction Indicator Light (Check Engine)	130
Manual	
Service	482
Media Hub	72
Media Mode	268
Memory Seat	32
Memory Settings	32
Methanol	469
Mirrors	44
Electric Powered	47
Heated	48
Memory	32
Outside	46
Rearview	44, 45, 373
Trailer Towing	48
Modifications/Alterations	
Vehicle	11
Monitor, Tire Pressure System	327
Mopar Parts	481
MP3 Control	72
Multi-Function Control Lever	53

N

New Vehicle Break-In Period	150, 151
-----------------------------------	----------

O

Occupant Restraints	334
Octane Rating, Gasoline (Fuel)	468, 469
Off-Pavement Driving (Off-Road)	235

Off-Road Driving (Off-Pavement)	235
Oil Filter, Change	410
Oil Filter, Selection	410
Oil Pressure Light	128
Oil, Engine	410, 475
Capacity	474
Dipstick	408
Disposal	410
Filter	410, 475
Filter Disposal	410
Identification Logo	410
Materials Added To	410
Pressure Warning Light	128
Recommendation	410, 474
Synthetic	410
Viscosity	474
Onboard Diagnostic System	137
Operating Precautions	137
Operator Manual	
Owner's Manual	482
Outside Rearview Mirrors	46
Overheating, Engine	389

P

Paint Care	461
Parking Brake	151
ParkSense Active Park Assist	195
ParkSense System, Rear	189
Passive Entry	28
Pedals, Adjustable	43

Pets	369
Phone Mode	271
Pickup Box	90, 92
Pinch Protection	81, 83
Placard, Tire And Loading Information	447
Power	
Distribution Center (Fuses)	428, 432
Door Locks	28
Mirrors	47
Outlet (Auxiliary Electrical Outlet)	74, 75
Seats	36
Side Steps	28
Sliding Rear Window	79
Steering	47, 174
Sunroof	80, 82
Windows	77
Power Seats	
Down	36
Forward	36
Rearward	36
Recline	37
Tilt	37
Up	36
Pregnant Women And Seat Belts	340
Presets	265
Pretensioners	
Seat Belts	340

R

Radial Ply Tires	451
Radiator Cap (Coolant Pressure Cap) ..	421, 423
Radio	
Presets	265
Radio Controls	259
Radio Mode	259
Radio Operation	259, 309
Radio Remote Controls.....	259
Rain Sensitive Wiper System	59
Rear Axle (Differential).....	426
Rear Camera	204
Rear Cargo Area Utility Rails	91
Rear Cross Path.....	321
Rear ParkSense System	189
Rear Window, Sliding.....	79
Reclining Rear Seats	36
Recreational Towing	230
Shifting Into Transfer Case Neutral (N)	232
Shifting Out Of Transfer Case Neutral (N)..	233
Reformulated Gasoline.....	469
Refrigerant	415
Registering SiriusXM Guardian	283
Release, Hood	84
Release, Tailgate	85
Reminder, Seat Belt	335
Remote Features, Door Lock/Unlock ..	290, 302
Remote Features, Horn And Lights.....	291
Remote Features, Starting	291, 303

Remote Keyless Entry	
Programming Additional Key Fobs.....	20
Remote Sound System (Radio) Control.....	259
Remote Start (Diesel)	25
Remote Start (Gasoline)	22
Remote Starting	
Exit Remote Start Mode	23
Remote Starting System	22, 25
Remove, Tailgate	86
Replacement Bulbs	437
Replacement Tires.....	453
Reporting Safety Defects	481
Restraints, Child	355
Restraints, Head	40
Roadside Assistance.....	292, 302
Rotation, Tires	460

S

Safety	258
Safety Checks Inside Vehicle	369
Safety Checks Outside Vehicle	371
Safety Defects, Reporting	481
Safety Features.....	258
Safety Information, Tire	443
Safety Tips	369
Safety, Exhaust Gas	371
Satellite Radio	261
Saved Radio Stations	265

Schedule, Maintenance	395, 399, 400
Seat Belt Reminder	126
Seat Belts	335, 369
Adjustable Shoulder Belt	339
Adjustable Upper Shoulder Anchorage	339
Adjustable Upper Shoulder Belt	
Anchorage	339
Automatic Locking Retractor (ALR)	341
Child Restraints	355
Energy Management Feature	340
Extender	340
Front Seat.....	335, 336, 338
Inspection	369
Lap/Shoulder Belt Operation.....	338
Lap/Shoulder Belt Untwisting.....	339
Lap/Shoulder Belts.....	336
Operating Instructions	338
Pregnant Women	340
Pretensioners	340
Rear Seat.....	336
Reminder.....	335
Seat Belt Extender.....	340
Seat Belt Pretensioner.....	340
Seat Belt Reminder	335
Untwisting Procedure.....	339
Seat Belts Maintenance.....	465

Seats	34, 35, 36	SiriusXM Satellite Radio		Steps, Power Side	28
Adjustment.....	34, 36	Browse in SXM	264	Stolen Vehicle Assistance	297, 303
Easy Entry	37	Favorites.....	264	Storage	68
Head Restraints	40	Replay	262	Storage Compartment, Center Seat	68
Memory.....	32	Sliding Rear Window, Power	79	Storage, Vehicle	66, 461
Power	36	Smart Watch	300	Store Radio Presets	265
Rear Folding.....	34	Snow Chains (Tire Chains)	458	Storing Your Vehicle.....	461
Reclining Rear.....	36	Snow Plow	227	Sun Roof	80, 81, 82, 84
Tilting	34	Snow Tires	454	Sunglasses Storage	70
Security System	26, 127	SOS Call.....	286, 301	Sunshade Operation	81
Selection Of Coolant (Antifreeze).....	475	Spare Tires	455, 456	Suspension	
Send & Go	293, 302	Spark Plugs.....	475	Air	165, 169
Sentry Key (Immobilizer).....	20	Speed Control (Cruise Control)	179	Sway Control, Trailer	318
Service Assistance.....	479	Starting.....	140, 143, 144	Synthetic Engine Oil	410
Service Contract	480	Automatic Transmission	141	T	
Service Manuals	482	Button	21	Tailgate Removal	86
Settings, Audio	266	Cold Weather.....	146	Tailgate, Electronic Lowering	85
Shifting	154	Engine Fails To Start.....	144	Telescoping Steering Column.....	31
Automatic Transmission.....	156	Starting And Operating.....	143, 144	Temperature Control, Automatic (ATC).....	65
Transfer Case, Shifting Into Transfer		Starting Procedures	143, 144	Tilt	
Case Neutral (N)	232	Starting Procedures (Gas Engines)	140	Down	37
Transfer Case, Shifting Out Of Transfer		Steering		Up	37
Case Neutral (N)	233	Power	174	Tilt Steering Column.....	31
Shoulder Belts	336	Tilt Column	31	Tip Start	143
Side Steps, Power.....	28	Wheel, Heated.....	31, 32	Tire And Loading Information Placard	447
Signals, Turn.....	55, 136, 371	Wheel, Tilt.....	31	Tire Markings	443
Sirius Satellite Radio	261	Steering Wheel Audio Controls	259	Tire Safety Information.....	443
Favorites	264	Steering Wheel Mounted Sound System	259		
Replay	262				