


Annex B

External photographs of EUT

part of / in addition to

Test report no.: 21086128-23003-1

Tested by
(name, function, signature) *Piotr Sardyko*
Deputy Head of Laboratory RF



signature

Approved by
(name, function, signature) *Dr.-Ing. Harald Ansorge*
Managing Director



signature

1 TABLE OF CONTENTS

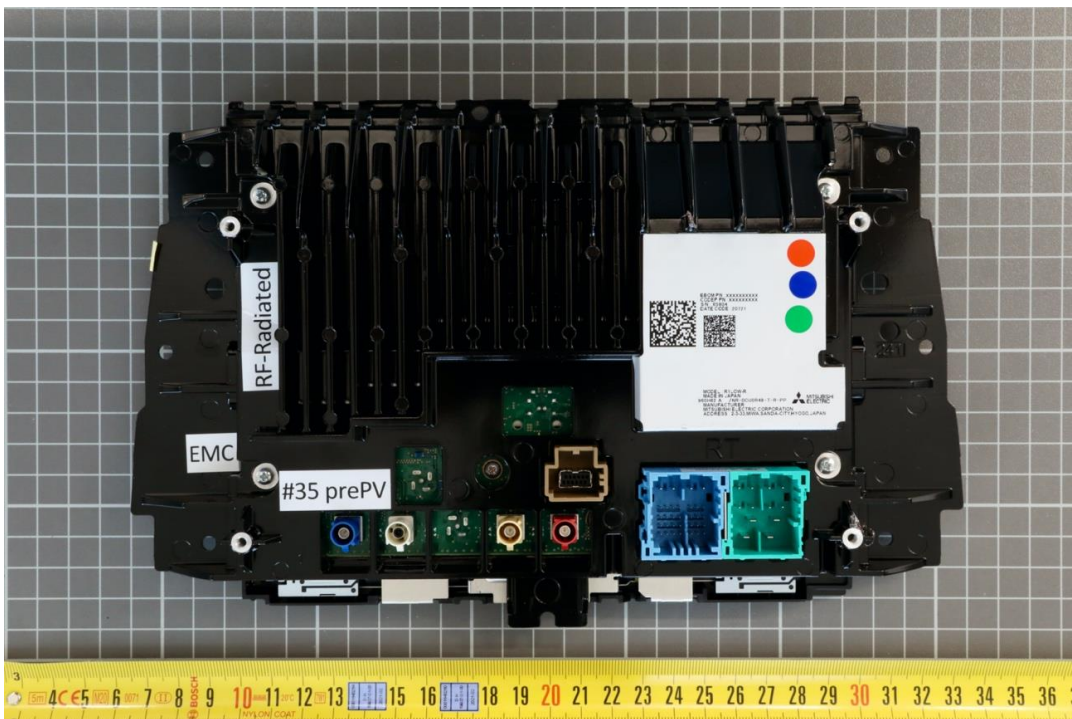
1	TABLE OF CONTENTS	2
2	External photos EUT	3
2.1	Variant ID #35	3
2.2	Variant ID #36	7
2.3	Variant ID #38	12
2.4	Variant ID #40	17
2.5	Variant ID #50	21
2.6	Variant ID #52	26
2.7	Variant ID #54	30
2.8	Variant ID #56	34
2.9	Variant ID #57	39
2.10	Variant ID #62	43
3	Revision History	48

2 External photos EUT

2.1 Variant ID #35

2.1.1 Radiated EUT, serial number 65804

Photo No. 1: rear view



Annex B of TR no.: 21086128-23003-1

Photo No. 2: front view



Photo No. 3: top view

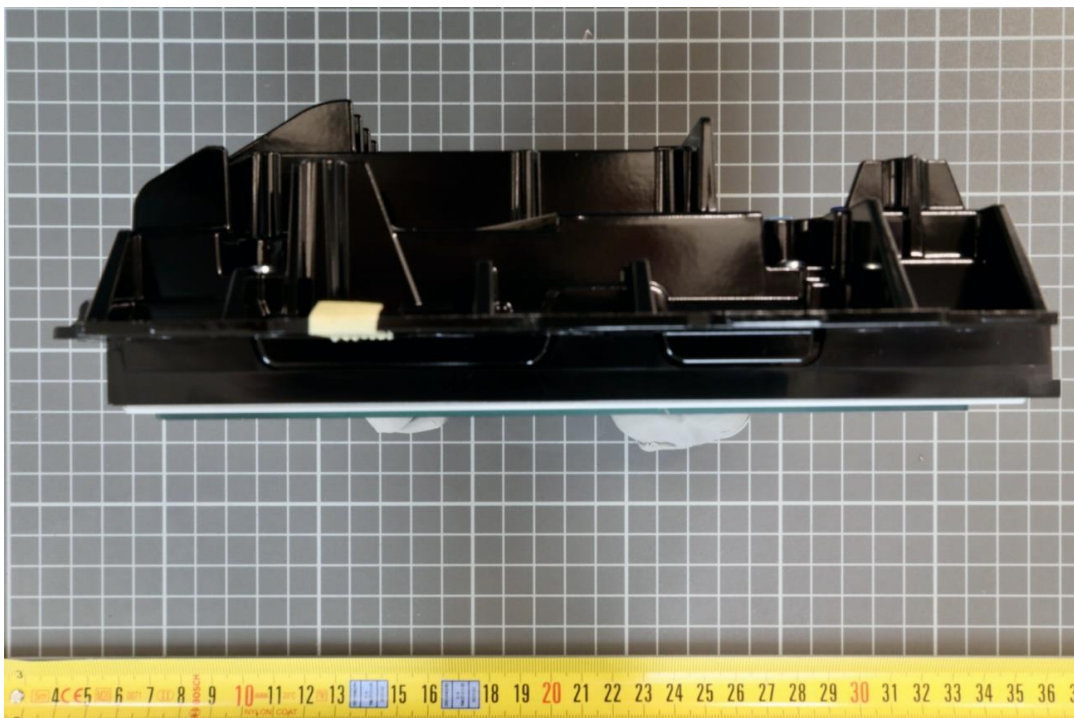


Annex B of TR no.: 21086128-23003-1

Photo No. 4: bottom view

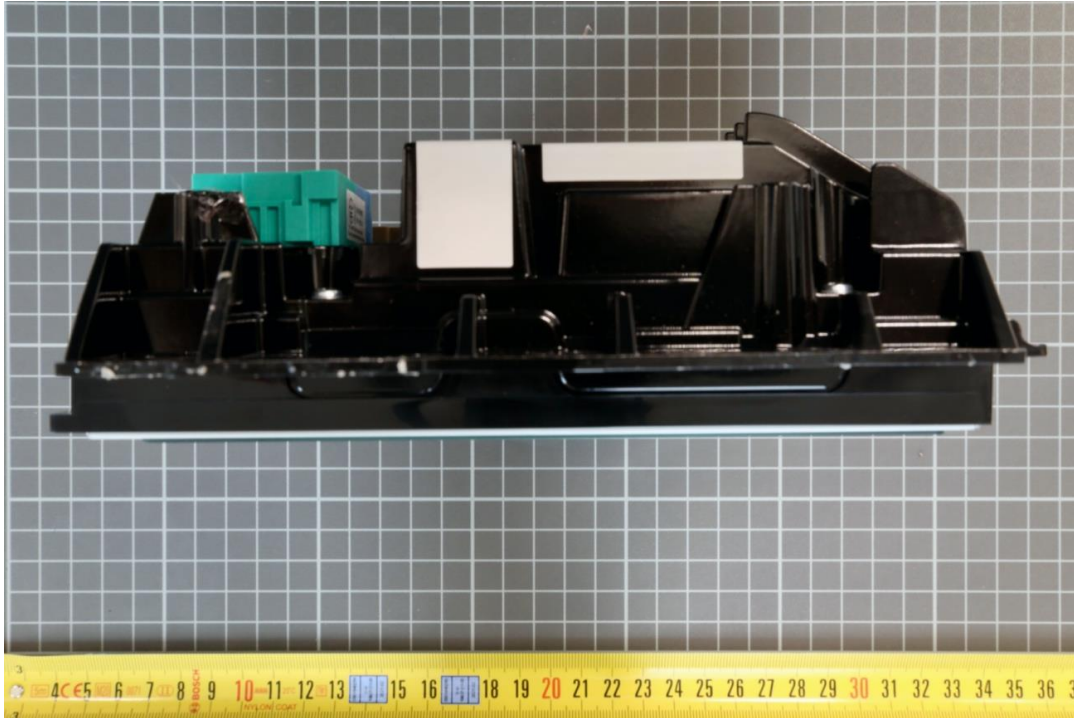


Photo No. 5: side view left



Annex B of TR no.: 21086128-23003-1

Photo No. 6: side view right



Annex B of TR no.: 21086128-23003-1

Photo No. 8: front view



Photo No. 9: top view



Annex B of TR no.: 21086128-23003-1

Photo No. 10: bottom view

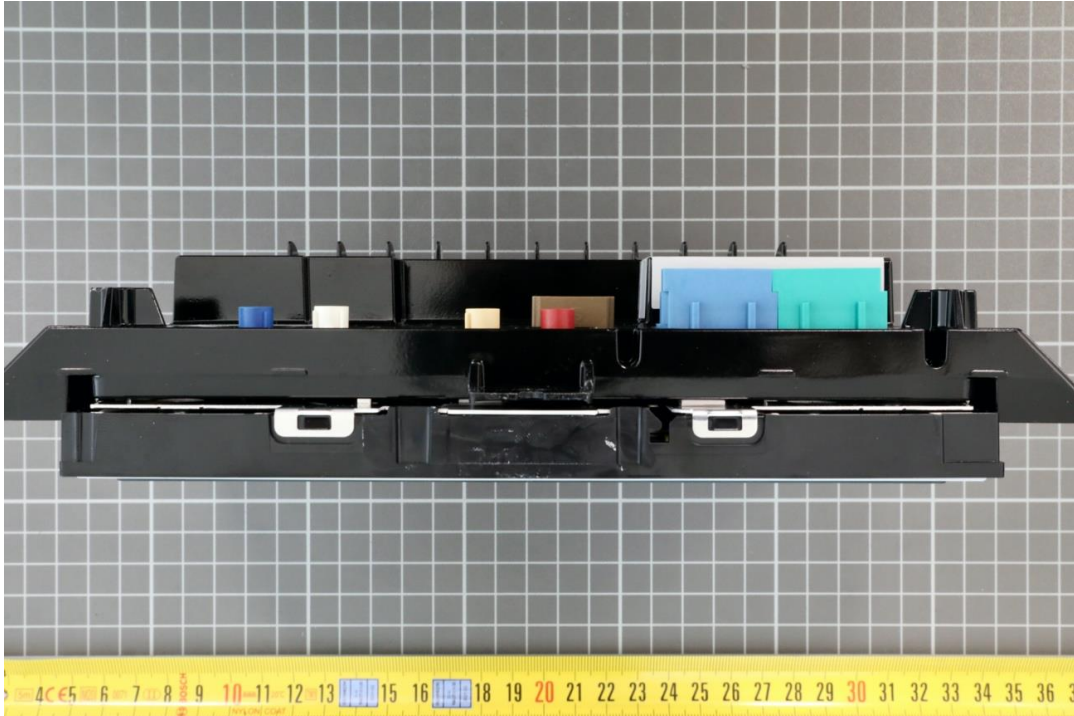
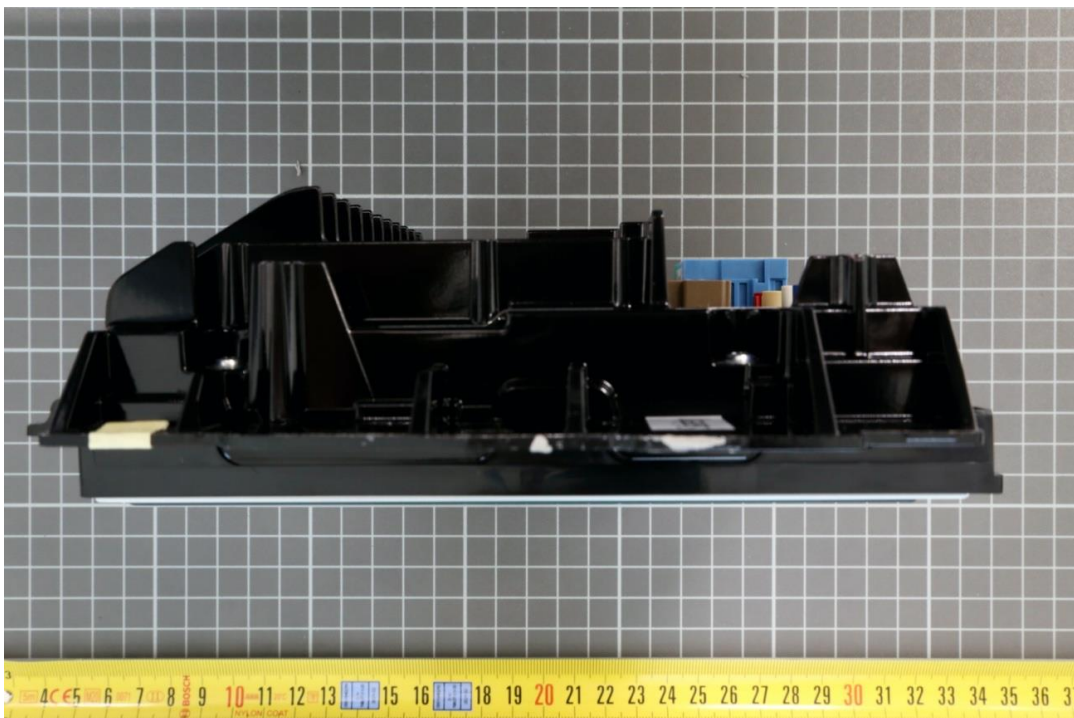
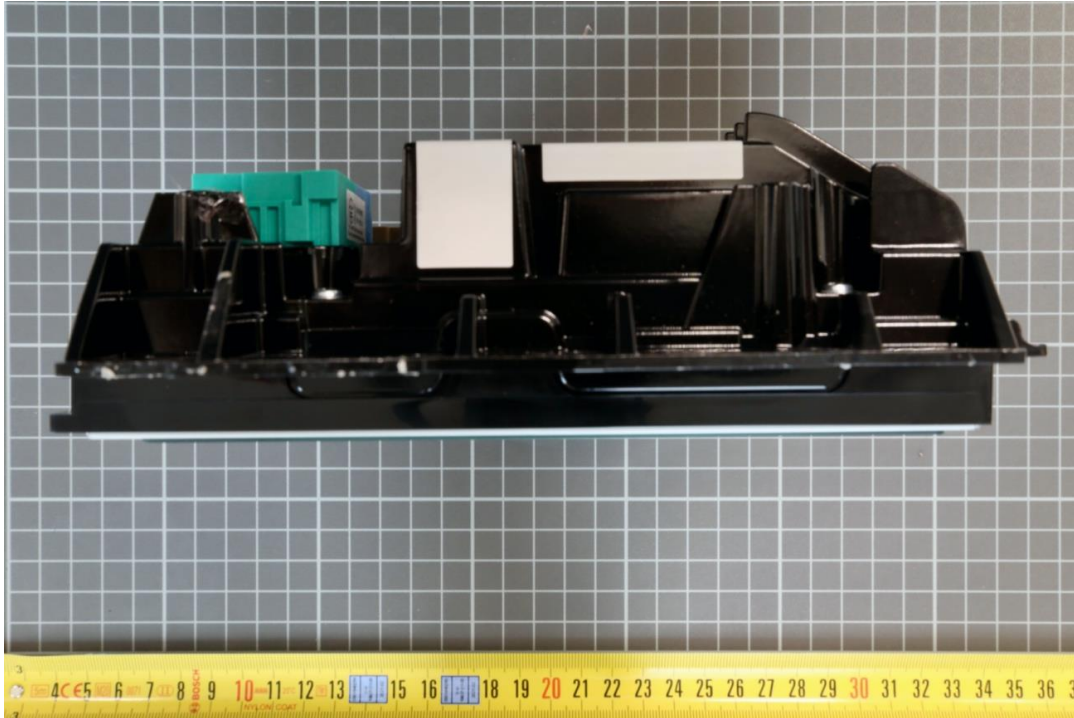


Photo No. 11: side view left



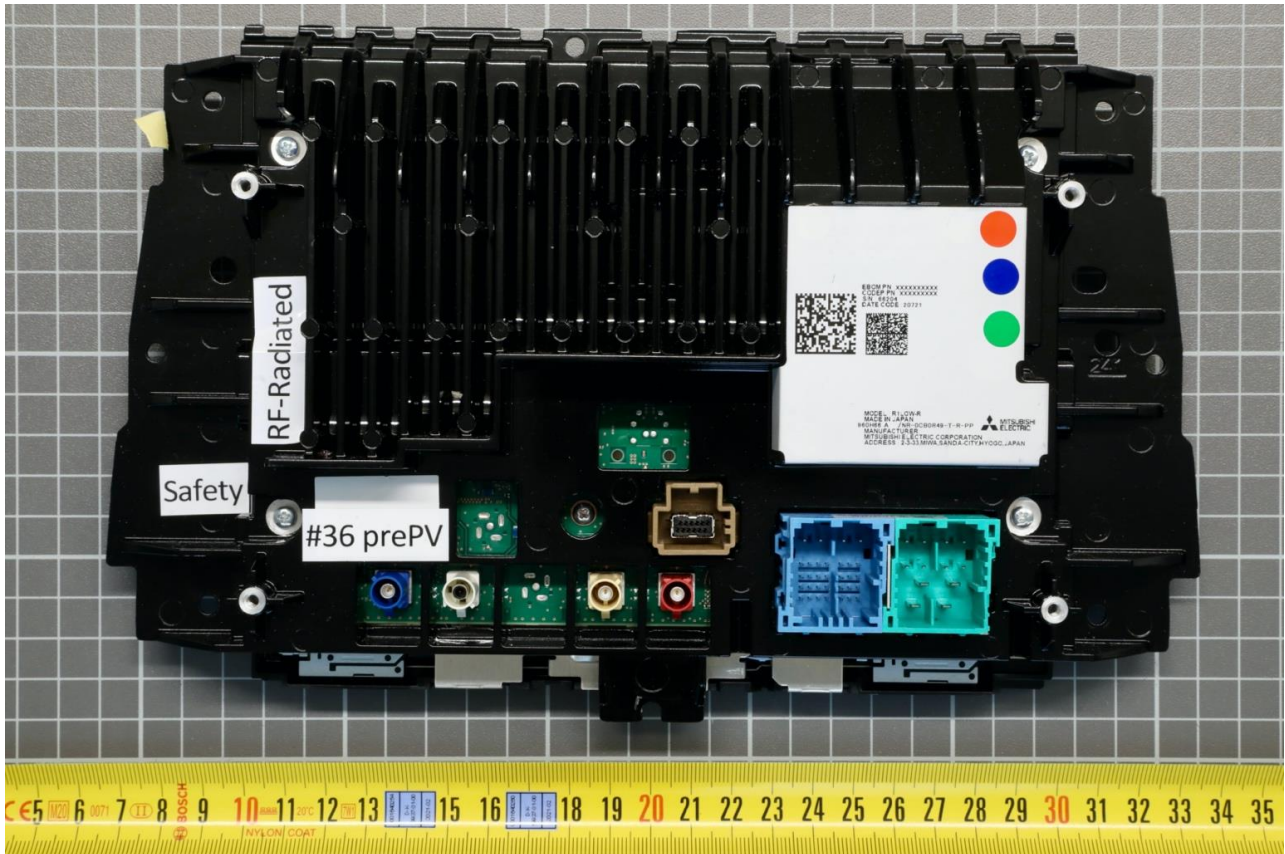
Annex B of TR no.: 21086128-23003-1

Photo No. 12: side view right



2.2.2 Radiated EUT, serial number 66204

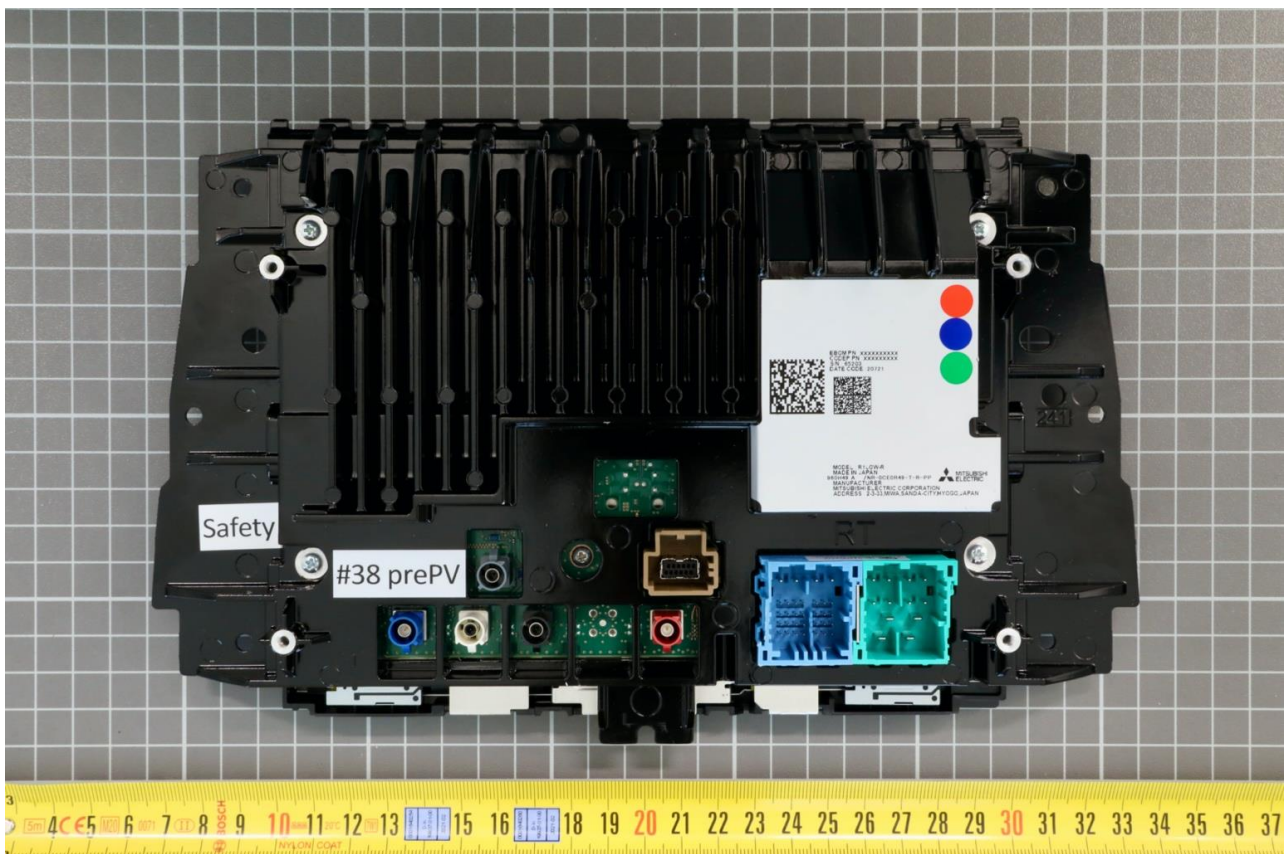
Photo No. 13: rear view



2.3 Variant ID #38

2.3.1 Radiated EUT, serial number 65203

Photo No. 14: rear view



Annex B of TR no.: 21086128-23003-1

Photo No. 15: front view



Photo No. 16: top view

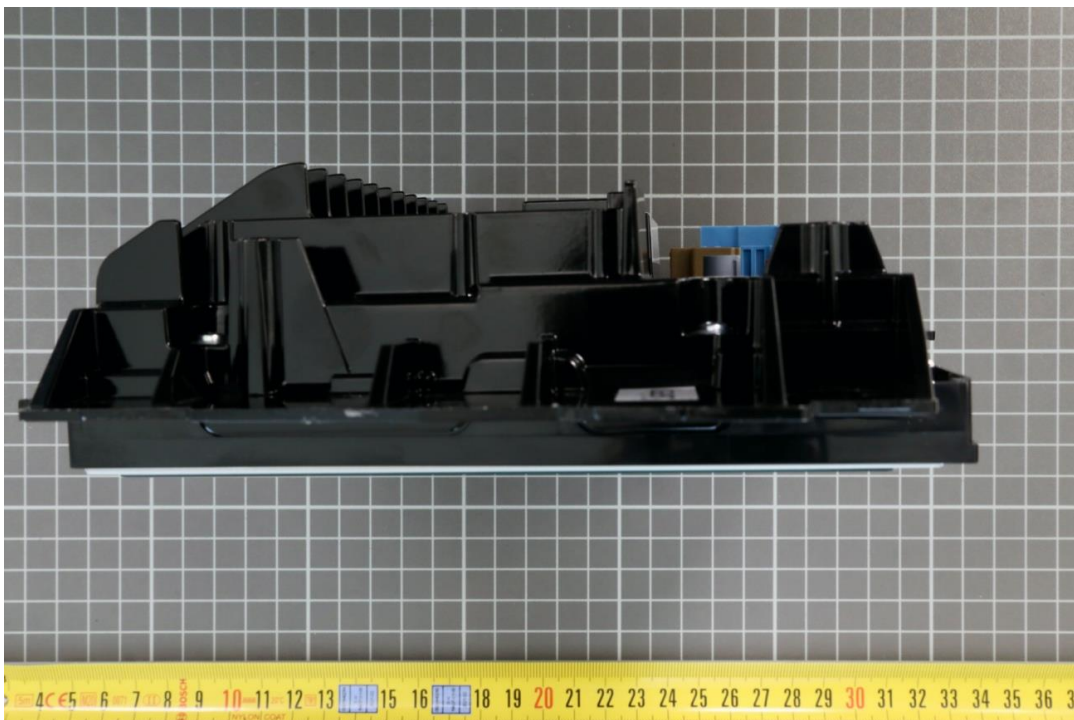


Annex B of TR no.: 21086128-23003-1

Photo No. 17: bottom view

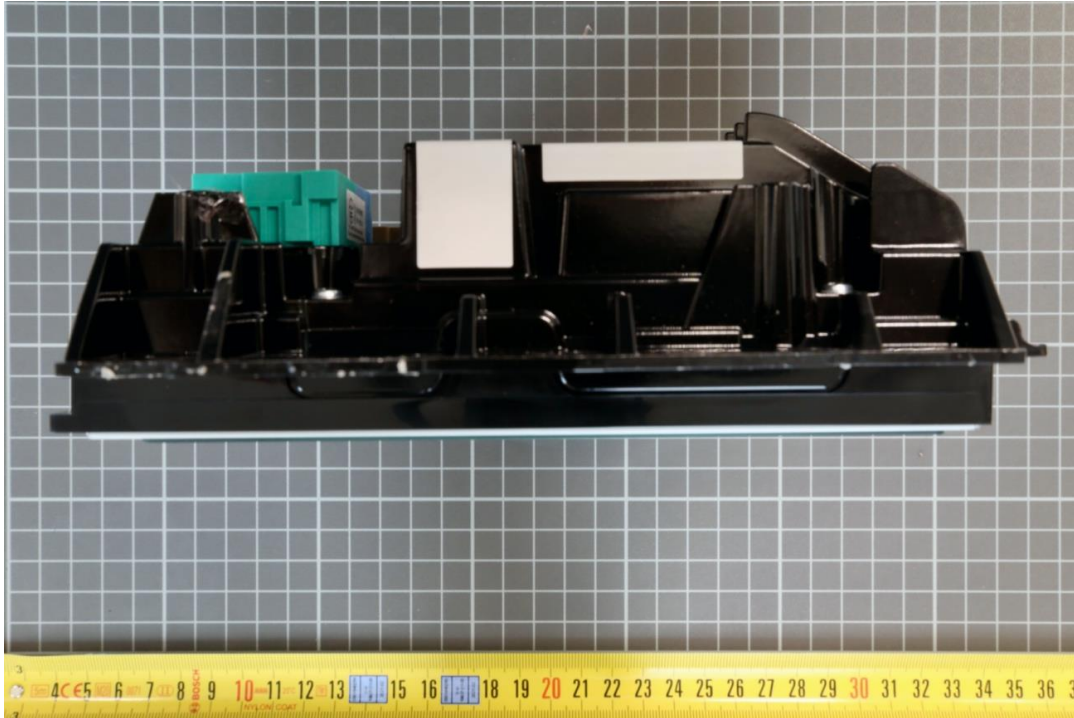


Photo No. 18: side view left



Annex B of TR no.: 21086128-23003-1

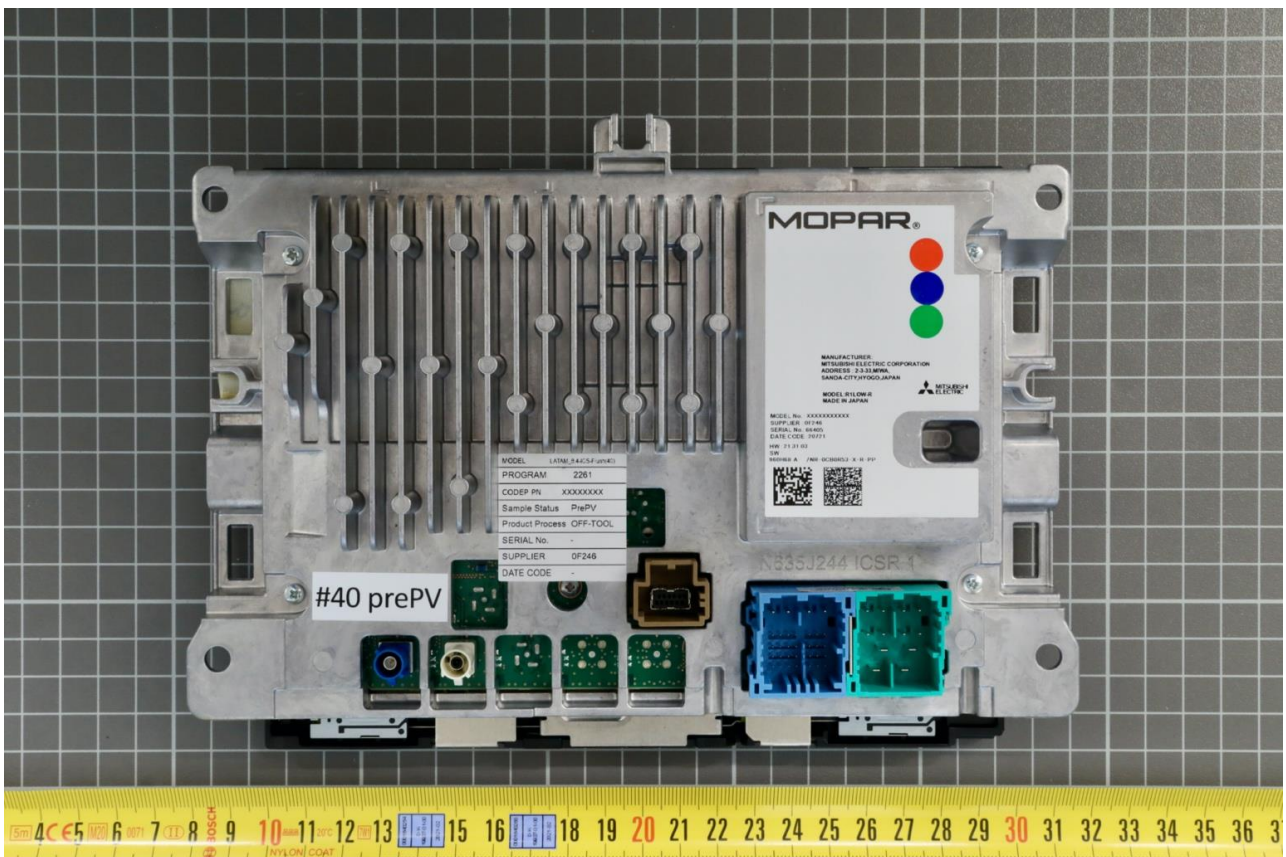
Photo No. 19: side view right



2.4 Variant ID #40

2.4.1 Radiated EUT, serial number 66404

Photo No. 21: rear view

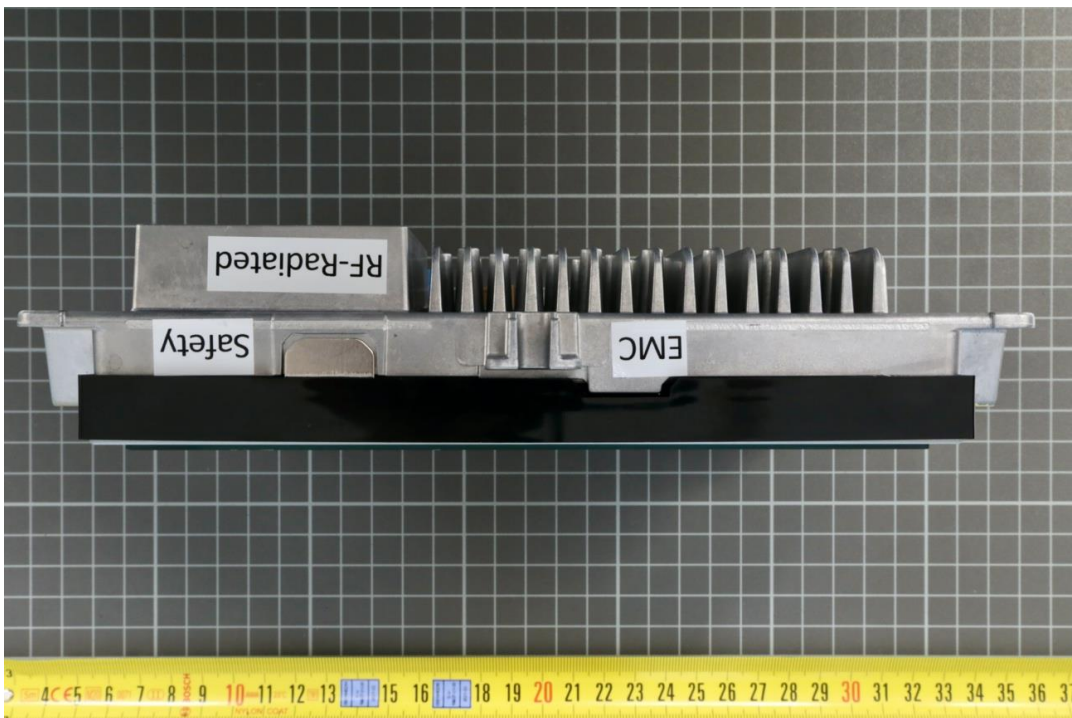


Annex B of TR no.: 21086128-23003-1

Photo No. 22: front view



Photo No. 23: top view



Annex B of TR no.: 21086128-23003-1

Photo No. 24: bottom view

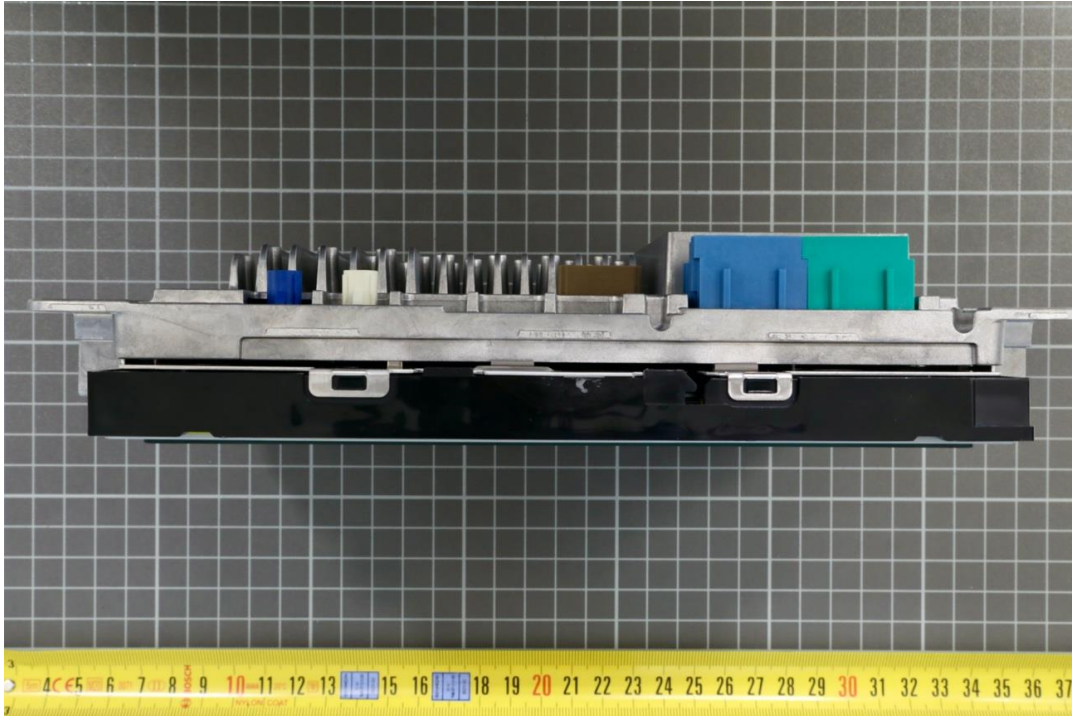
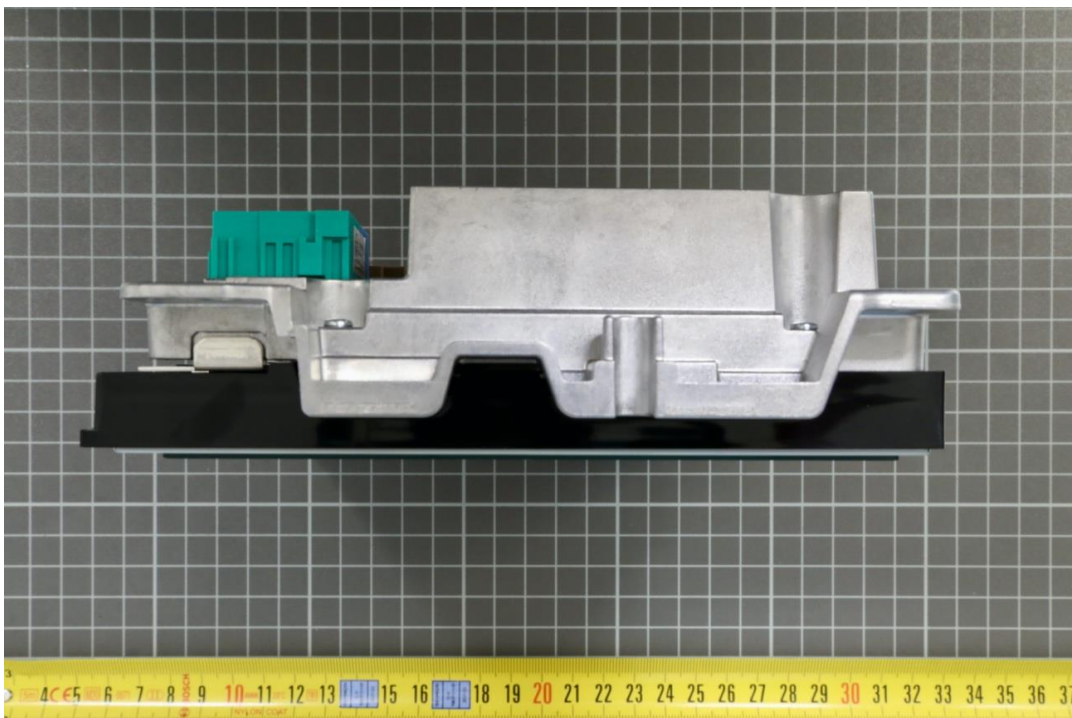
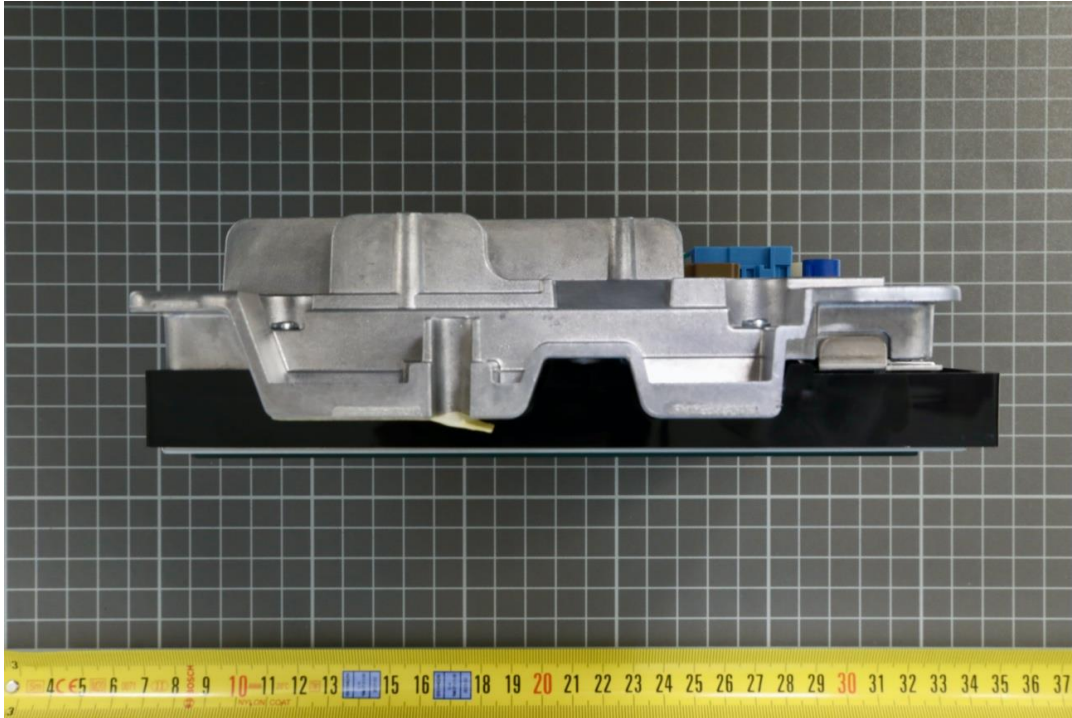


Photo No. 25: side view left



Annex B of TR no.: 21086128-23003-1

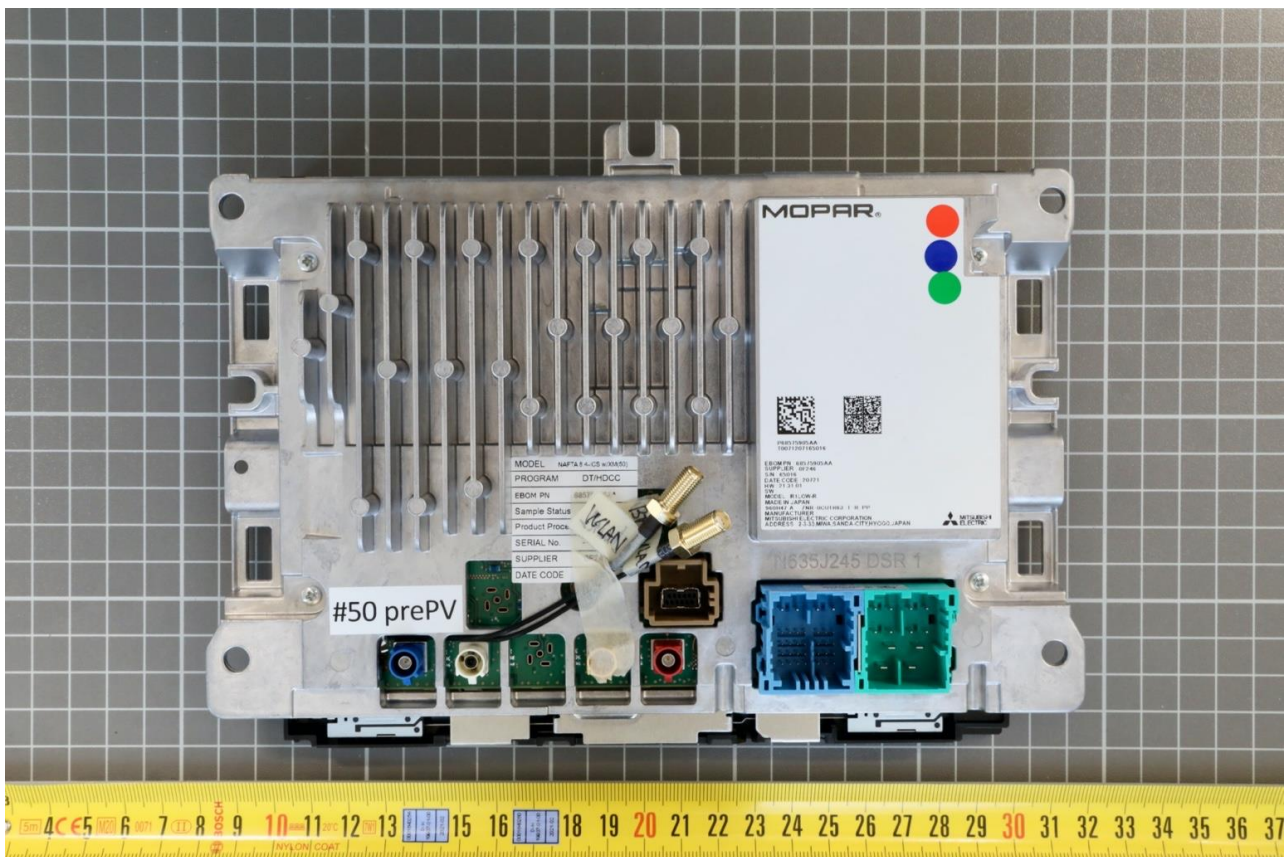
Photo No. 26: side view right



2.5 Variant ID #50

2.5.1 Conducted EUT, serial number 65016

Photo No. 27: rear view



Annex B of TR no.: 21086128-23003-1

Photo No. 28: front view

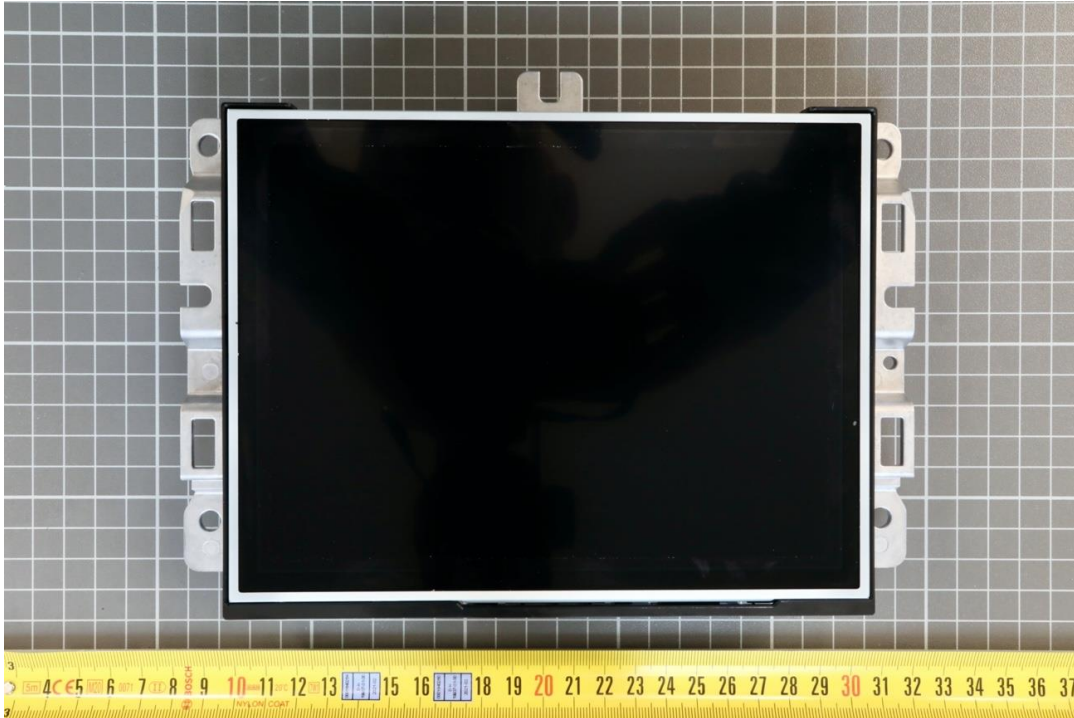
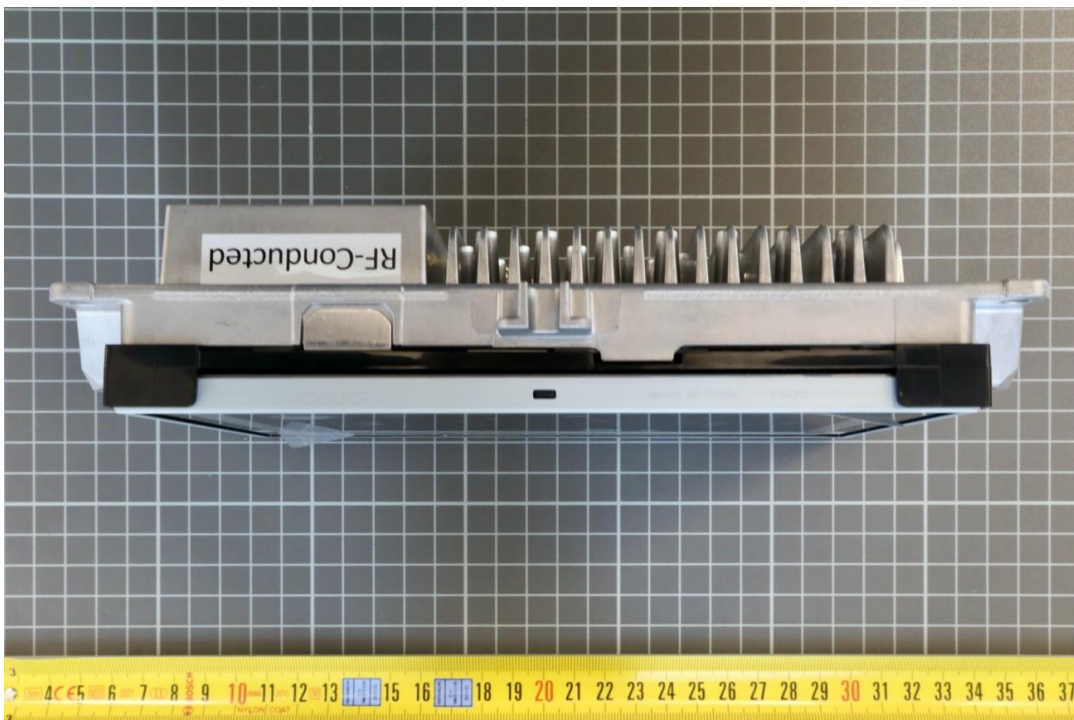


Photo No. 29: top view



Annex B of TR no.: 21086128-23003-1

Photo No. 30: bottom view

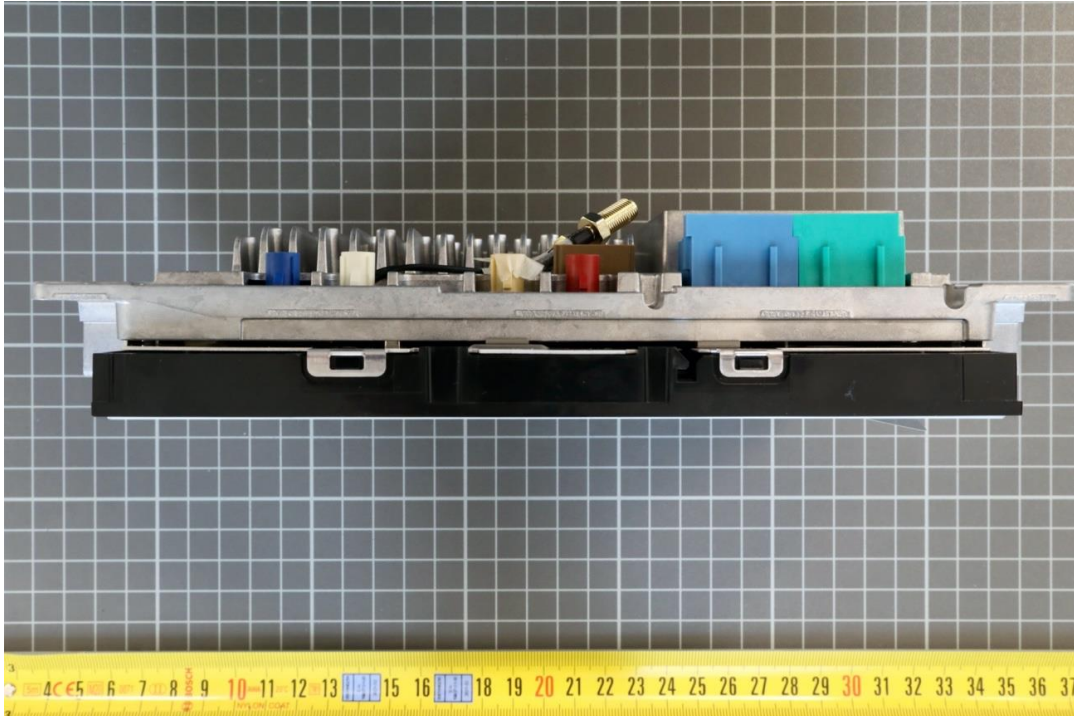
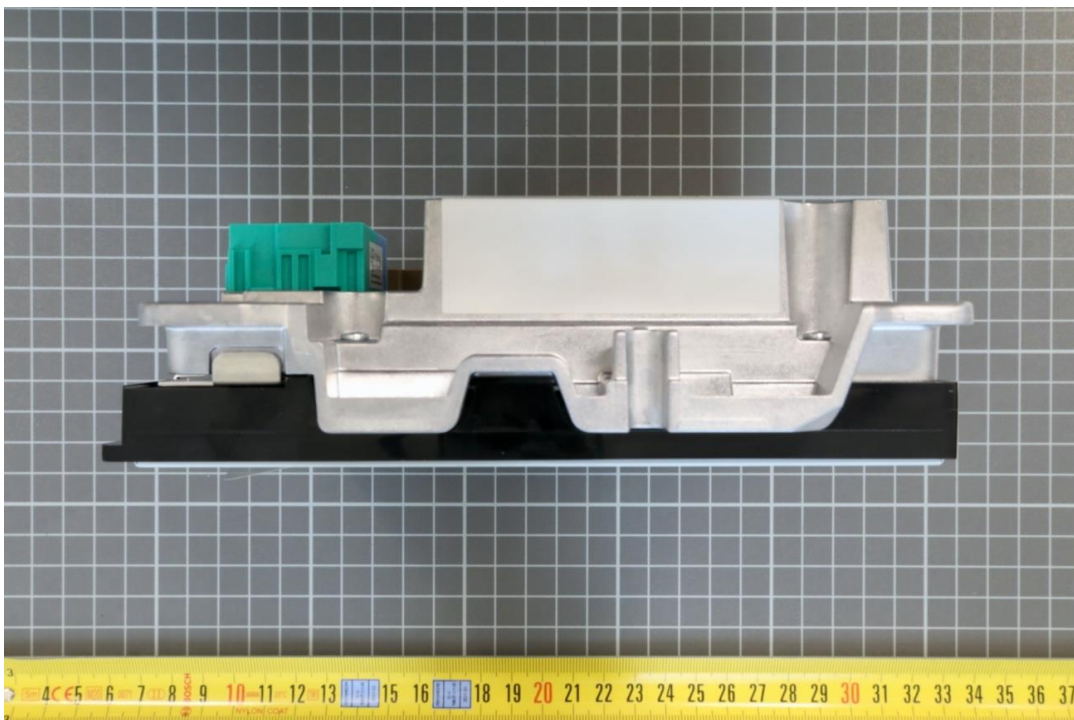
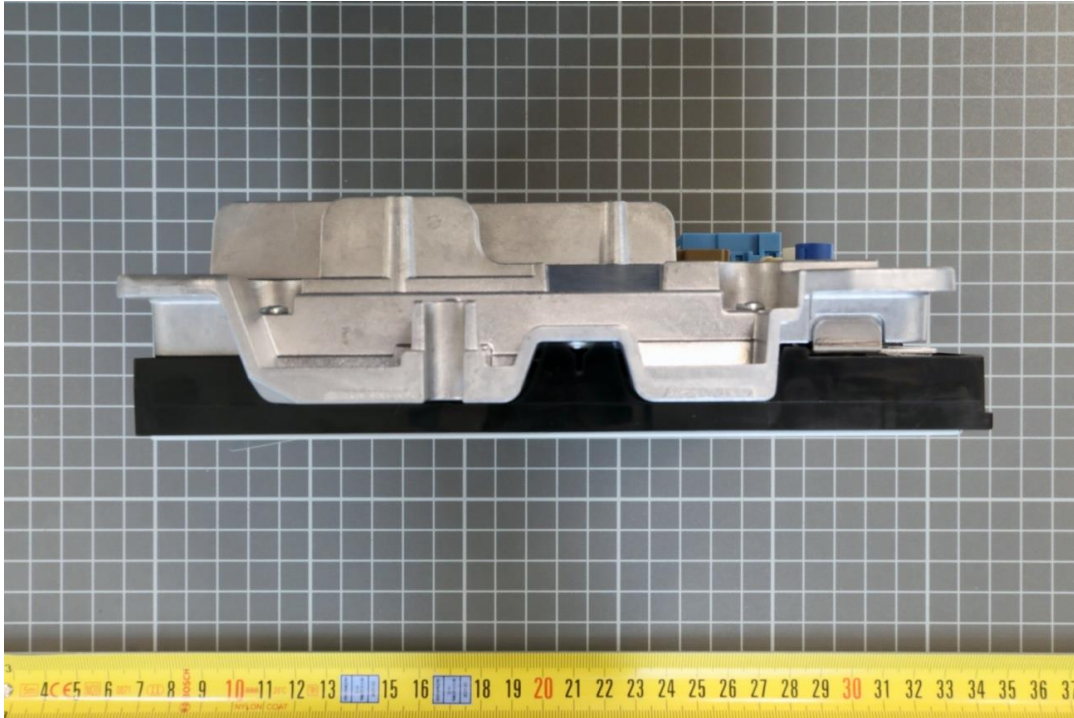


Photo No. 31: side view left



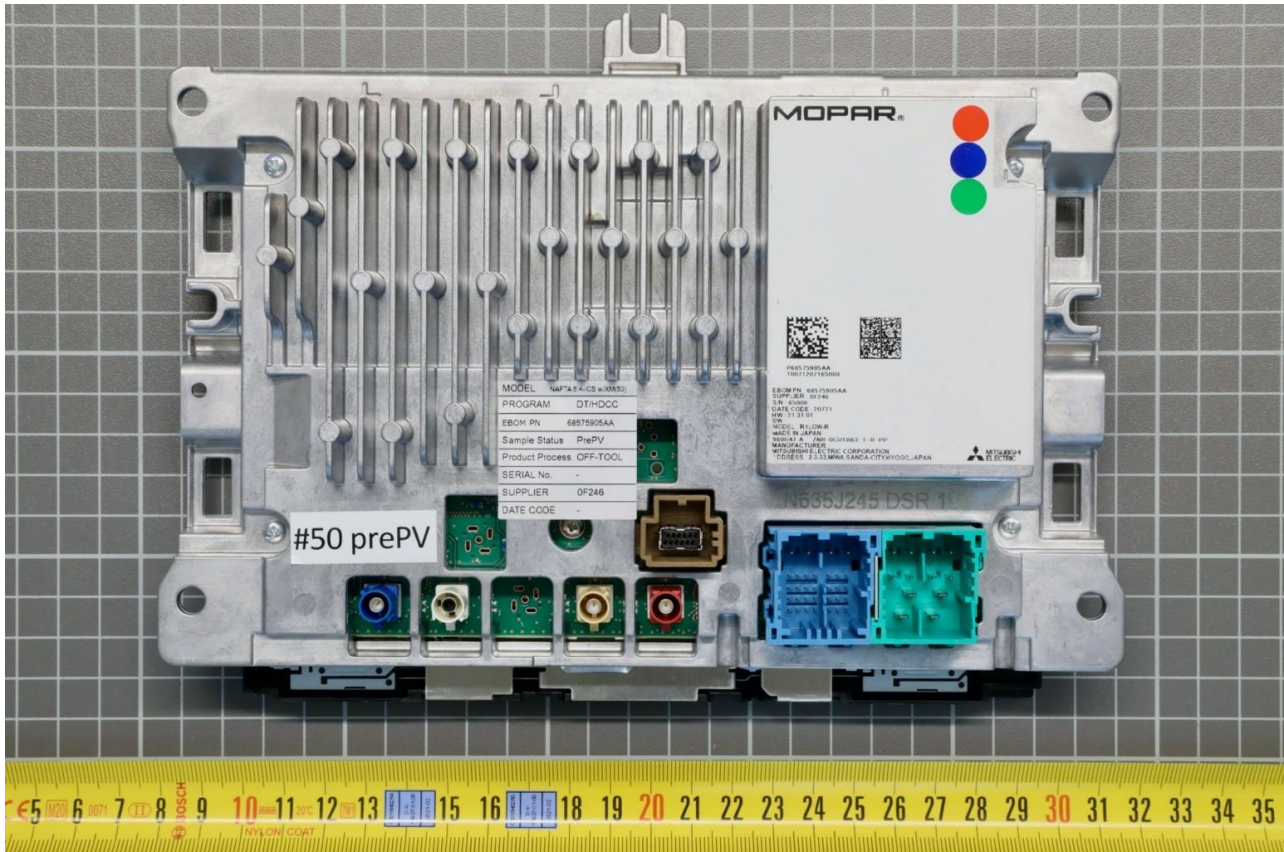
Annex B of TR no.: 21086128-23003-1

Photo No. 32: side view right



2.5.2 Radiated EUT, serial number 65008

Photo No. 33: rear view



Annex B of TR no.: 21086128-23003-1

Photo No. 35: front view

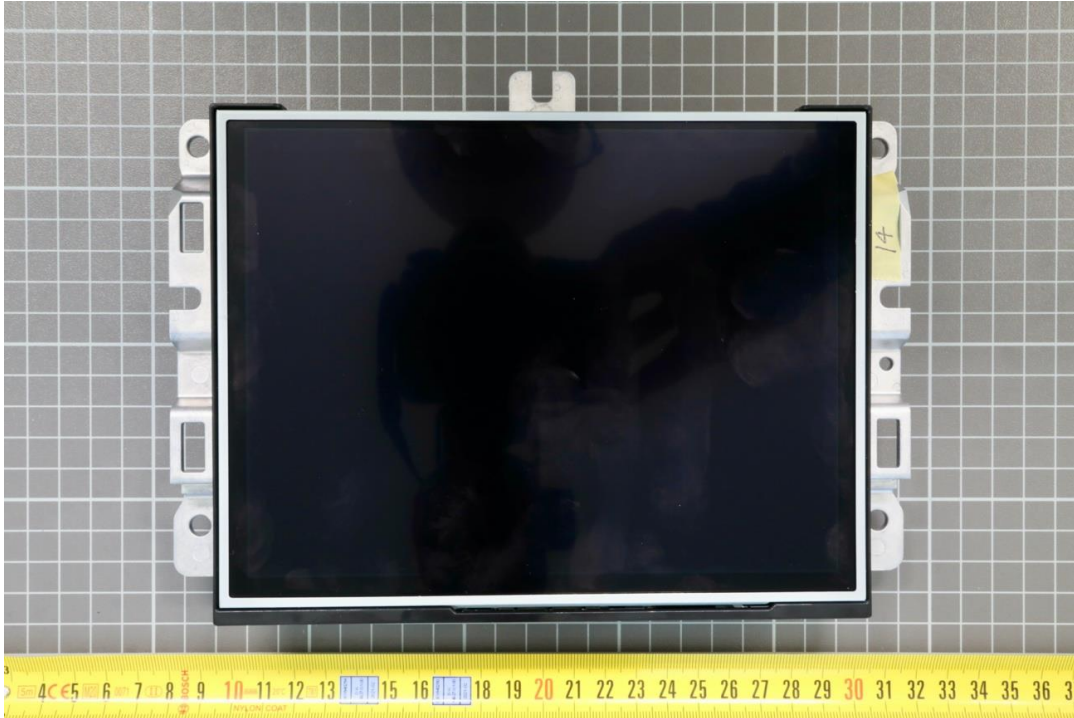


Photo No. 36: top view

