

Annex B


External photographs of EUT

part of / in addition to

Test report no.: 21086129-23007-1

Tested by
(name, function, signature)

Piotr Sardyko
Deputy Head of Laboratory RF



signature

Approved by
(name, function, signature)

Dr.-Ing. Harald Ansorge
Managing Director



signature

1 TABLE OF CONTENTS

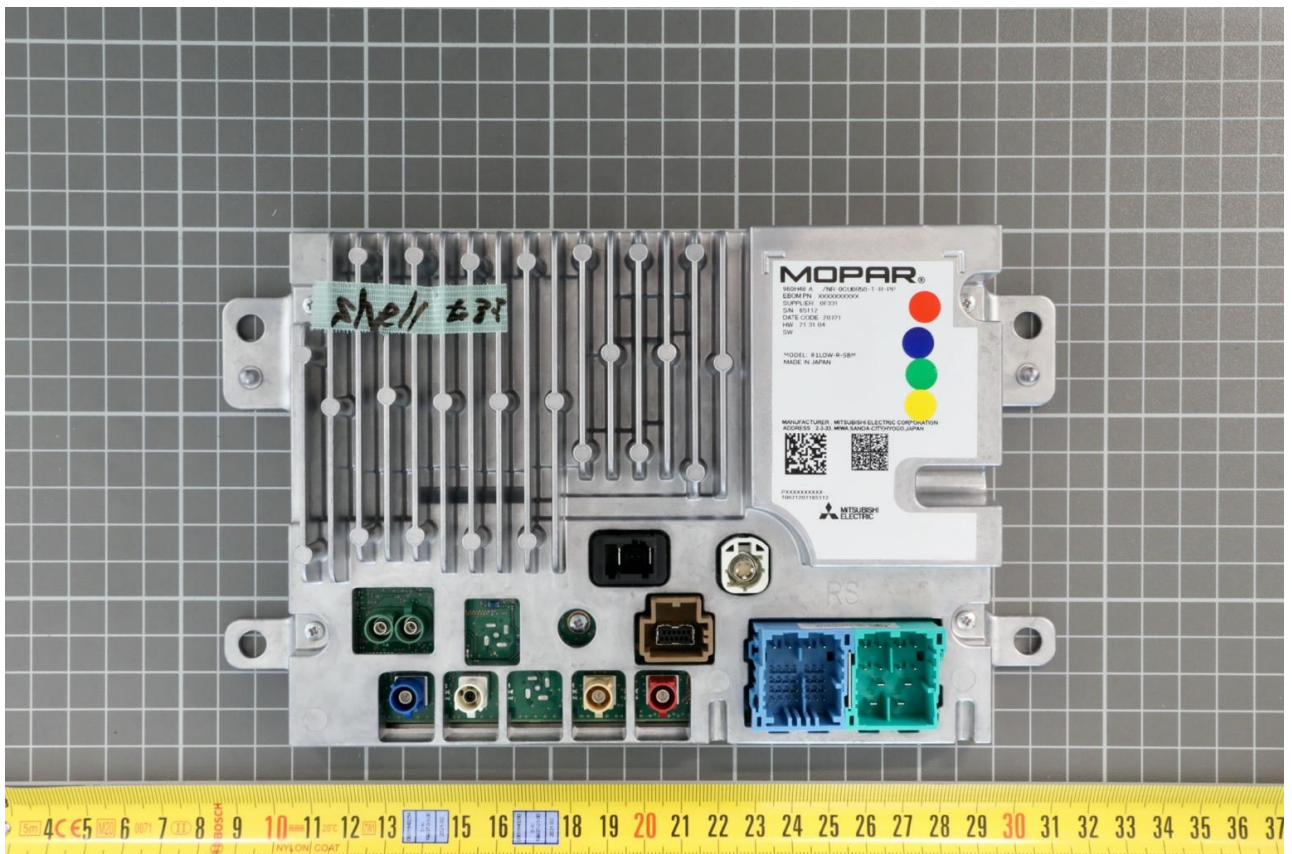
1	TABLE OF CONTENTS	2
2	External photos EUT	3
2.1	Variant ID #28	3
2.2	Variant ID #33	9
2.3	Variant ID #39	13
2.4	Variant ID #43	17
2.5	Variant ID #48	21
2.6	External antenna	27
3	Revision History	28

2 External photos EUT

2.1 Variant ID #28

2.1.1 Conducted EUT, serial number 65112

Photo No. 1: rear view



Annex B of TR no.: 21086129-23007-1

Photo No. 2: front view

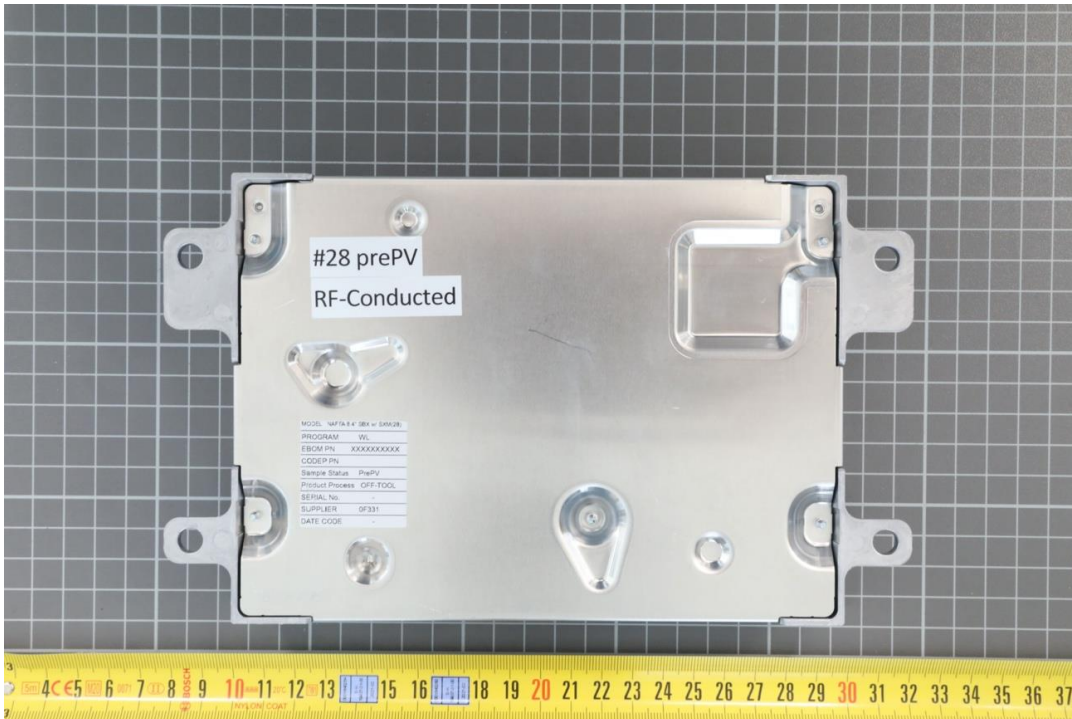
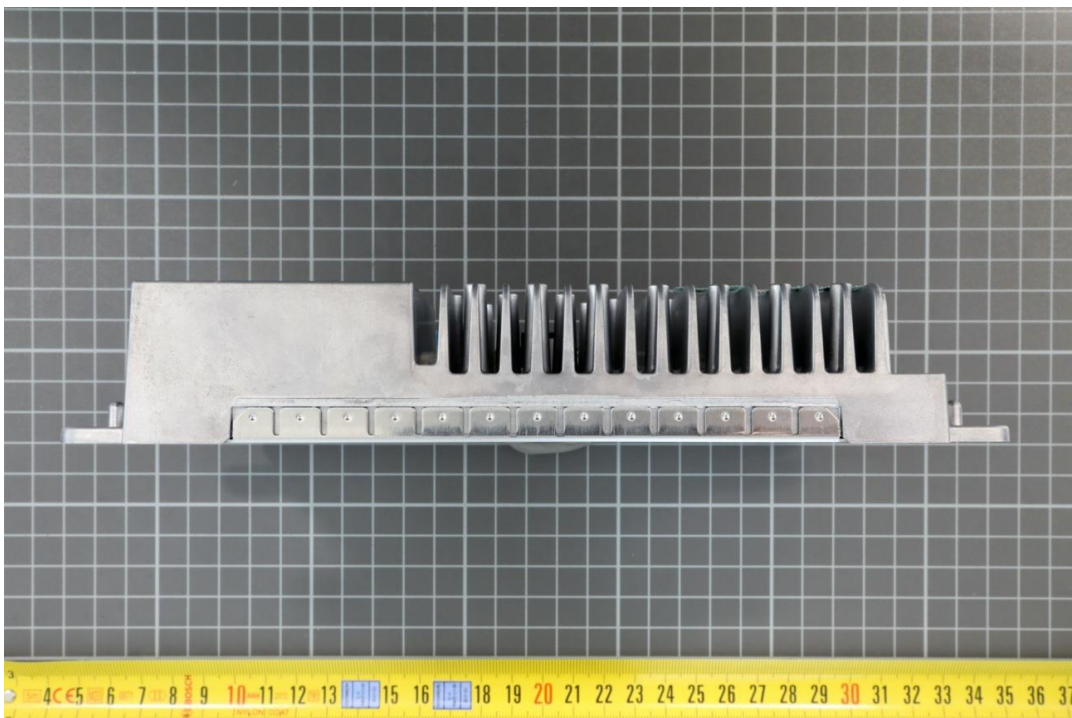


Photo No. 3: top view



Annex B of TR no.: 21086129-23007-1

Photo No. 4: bottom view

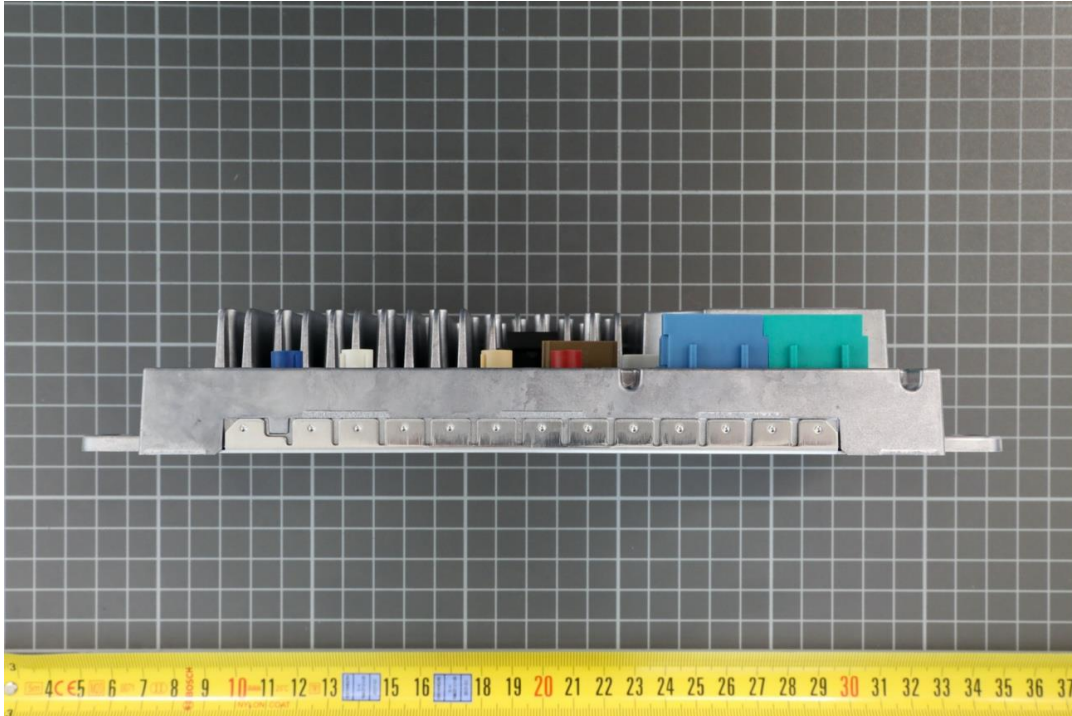
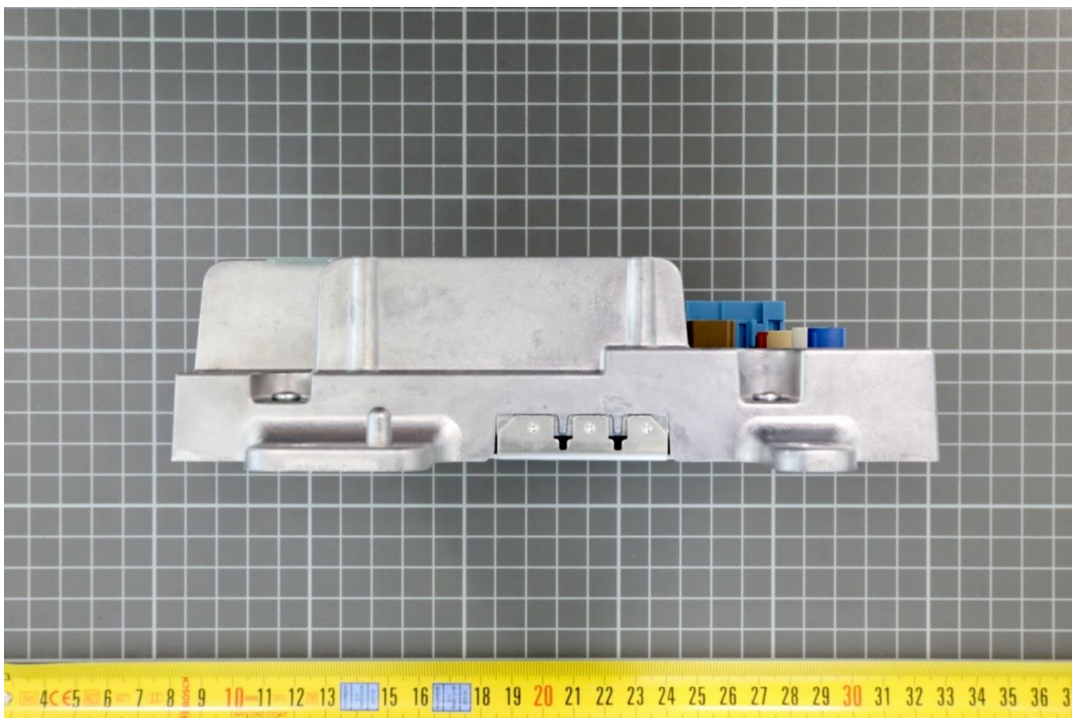
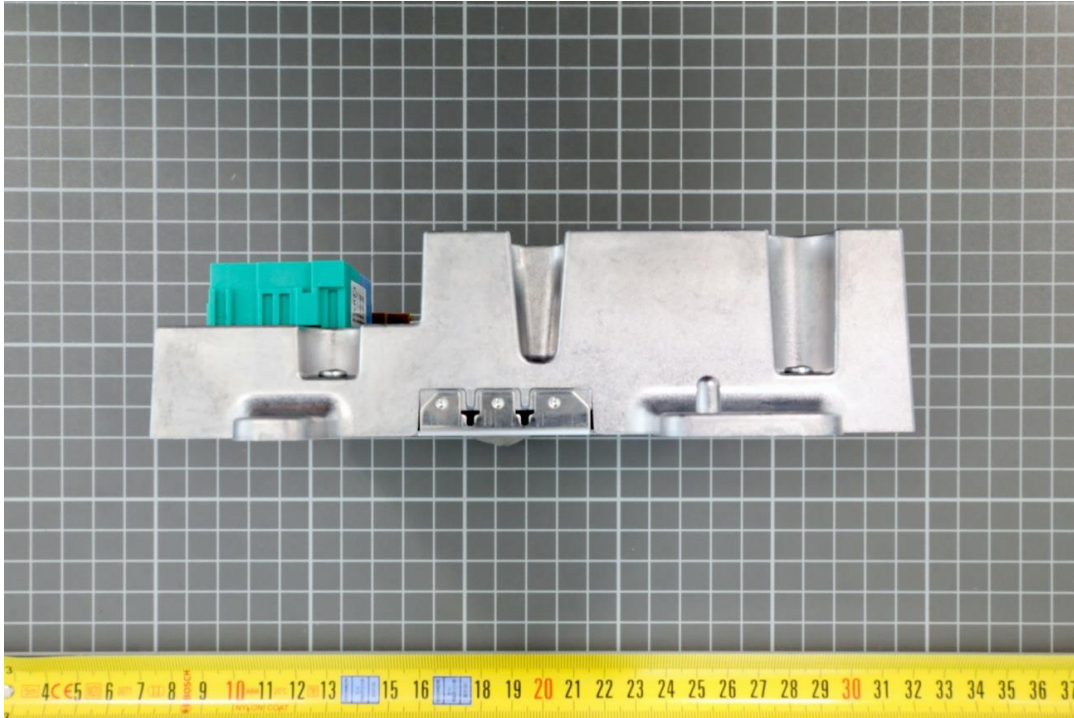


Photo No. 5: side view left



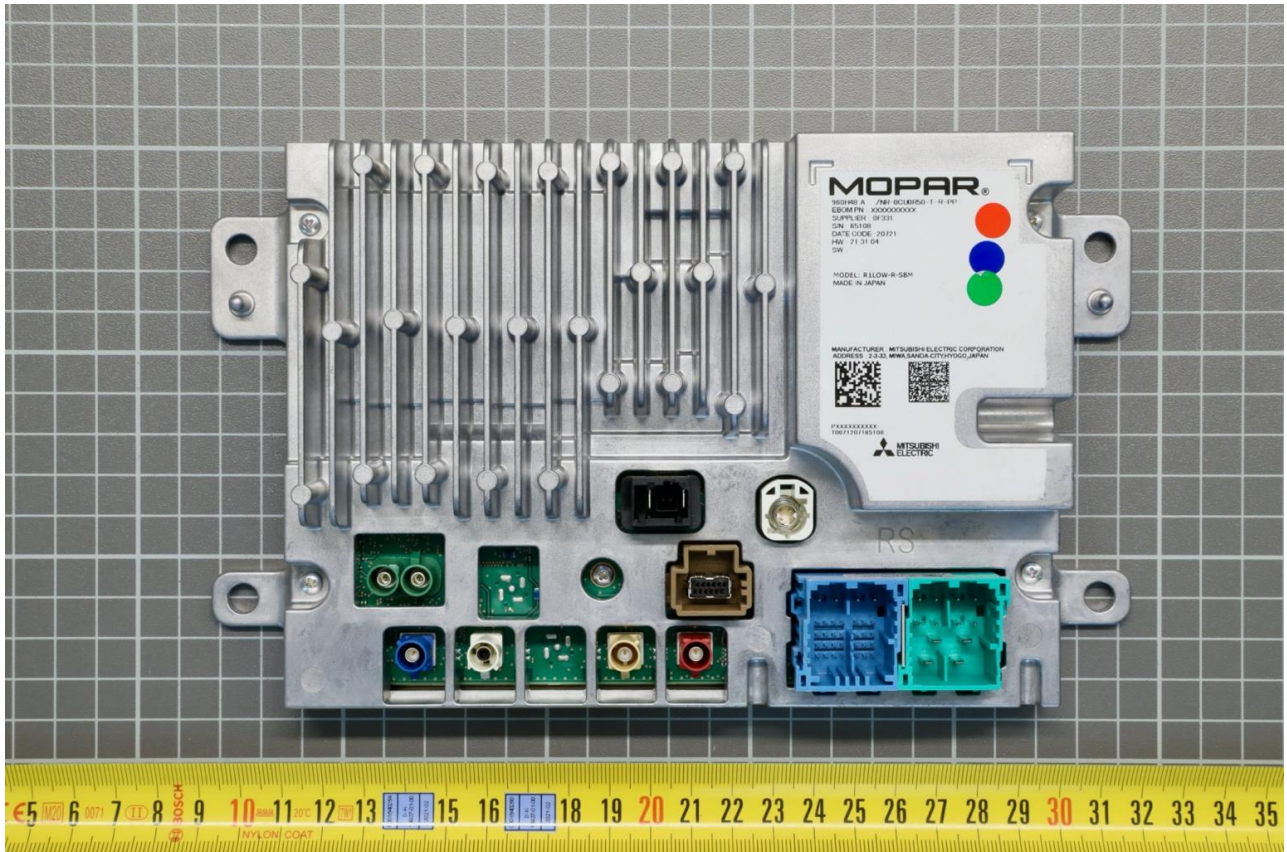
Annex B of TR no.: 21086129-23007-1

Photo No. 6: side view right



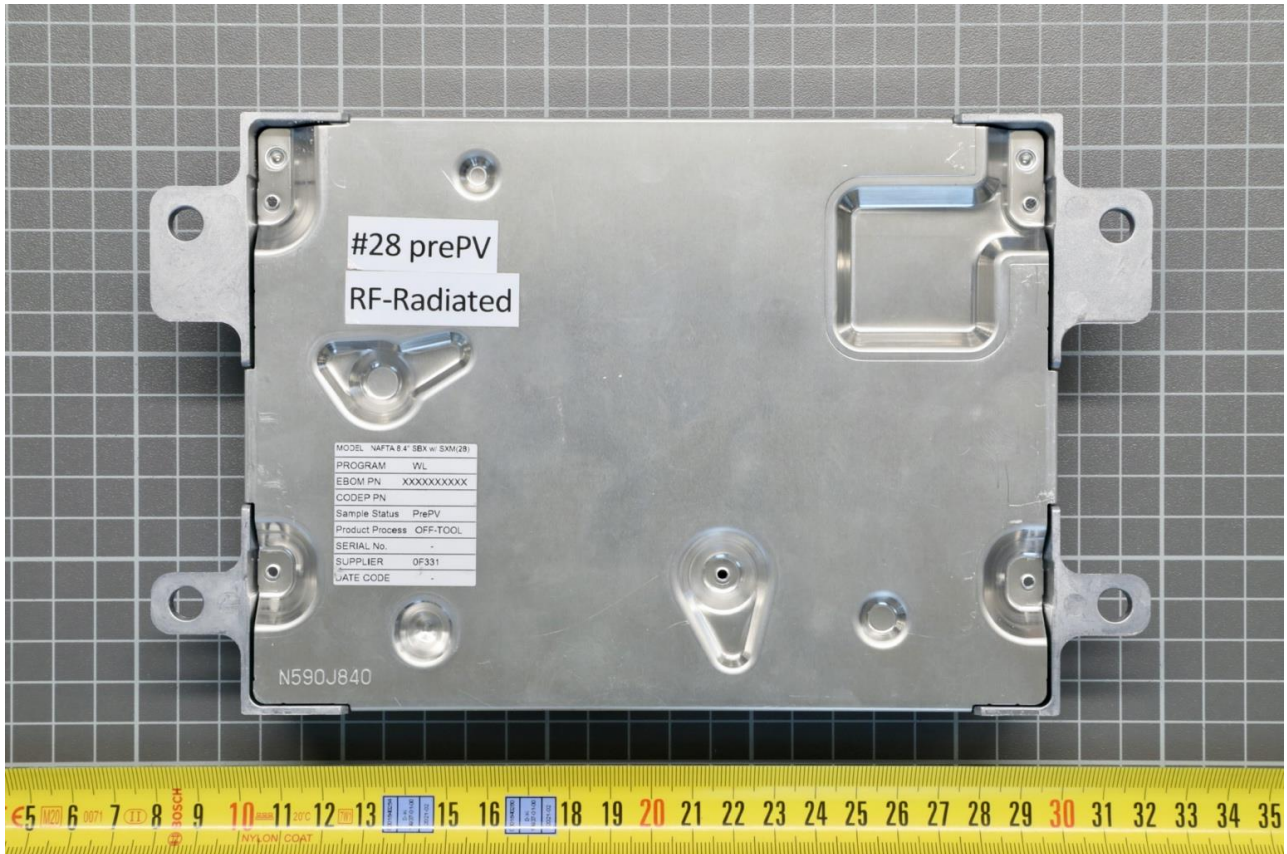
2.1.2 Radiated EUT, serial number 65108

Photo No. 7: rear view



Annex B of TR no.: 21086129-23007-1

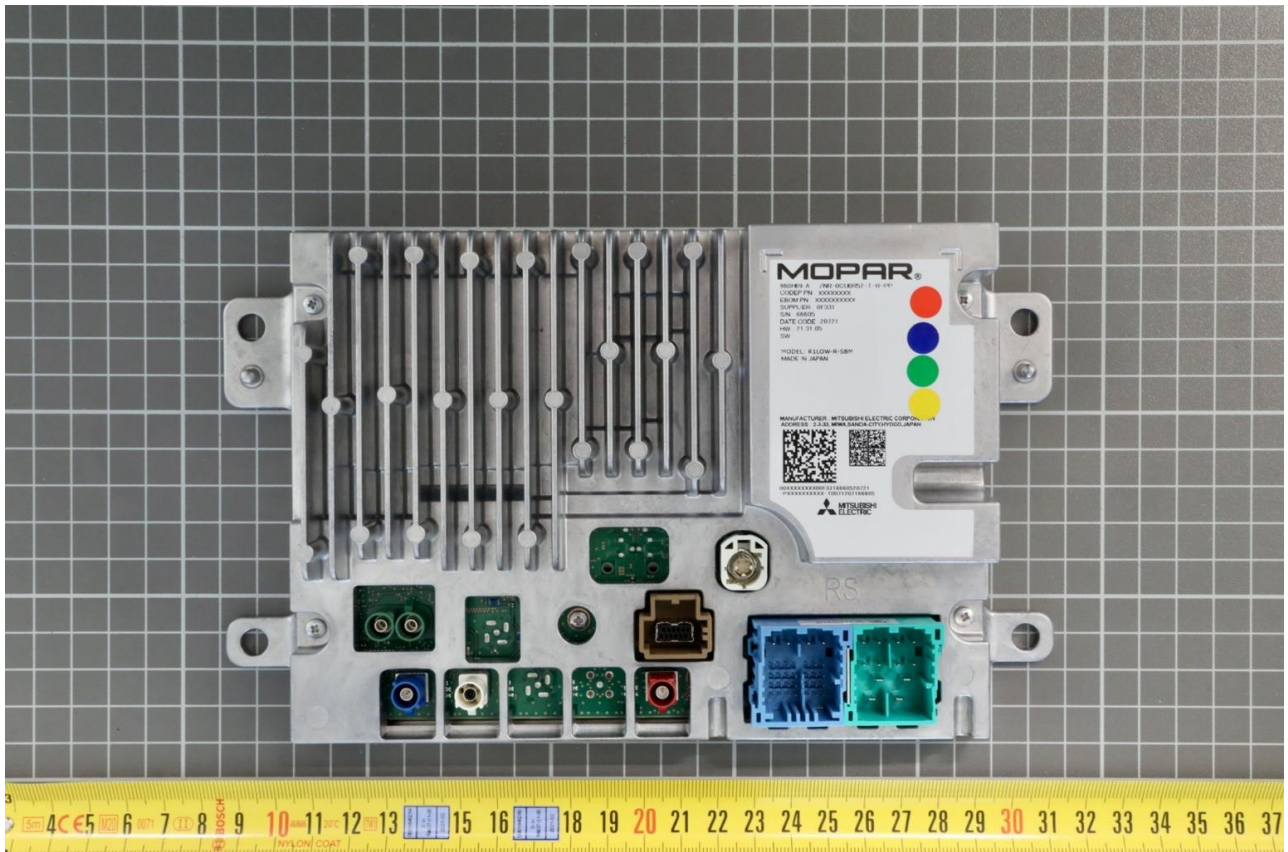
Photo No. 8: front view



2.2 Variant ID #33

2.2.1 Radiated EUT, serial number 66605

Photo No. 9: rear view



Annex B of TR no.: 21086129-23007-1

Photo No. 10: front view

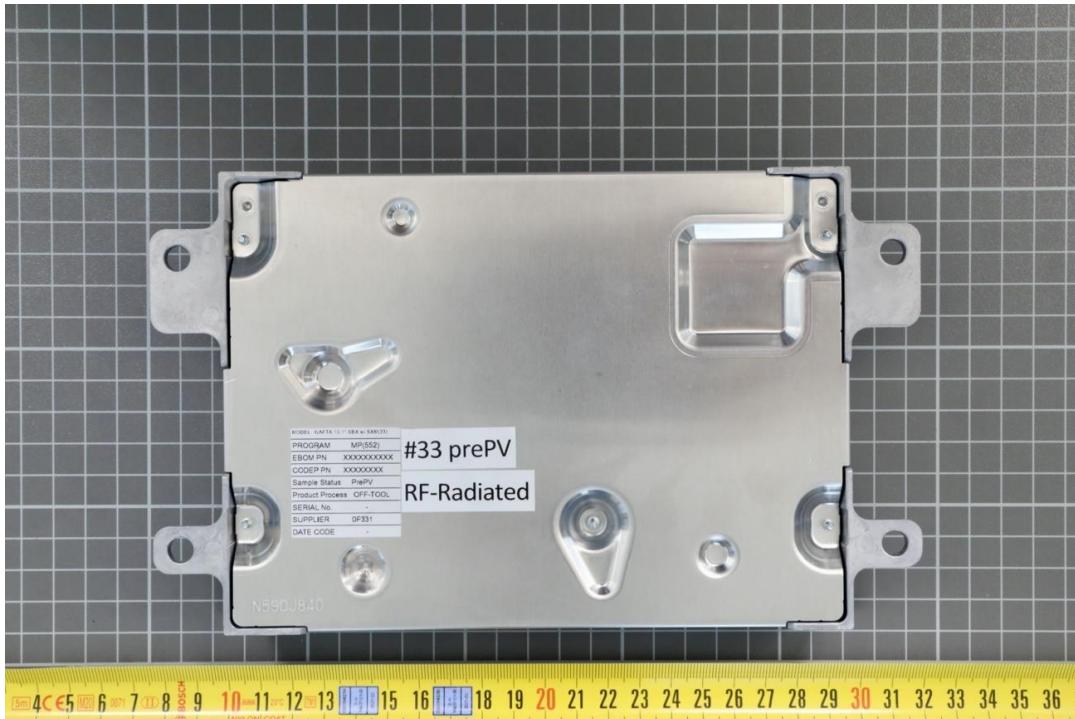
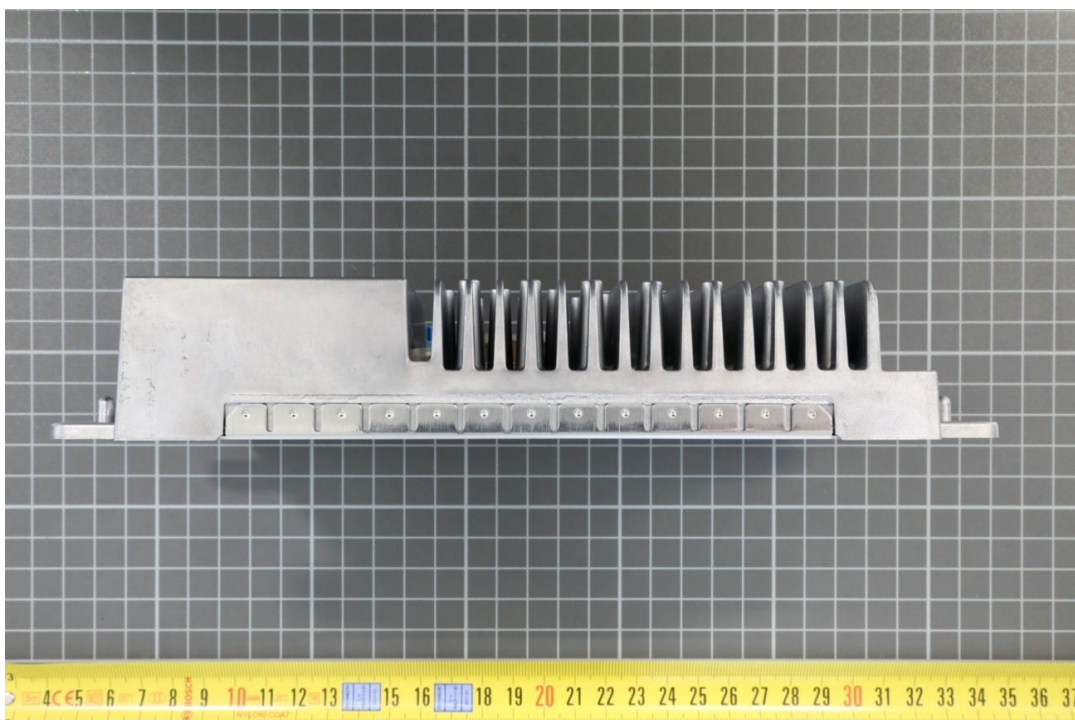


Photo No. 11: top view



Annex B of TR no.: 21086129-23007-1

Photo No. 12: bottom view

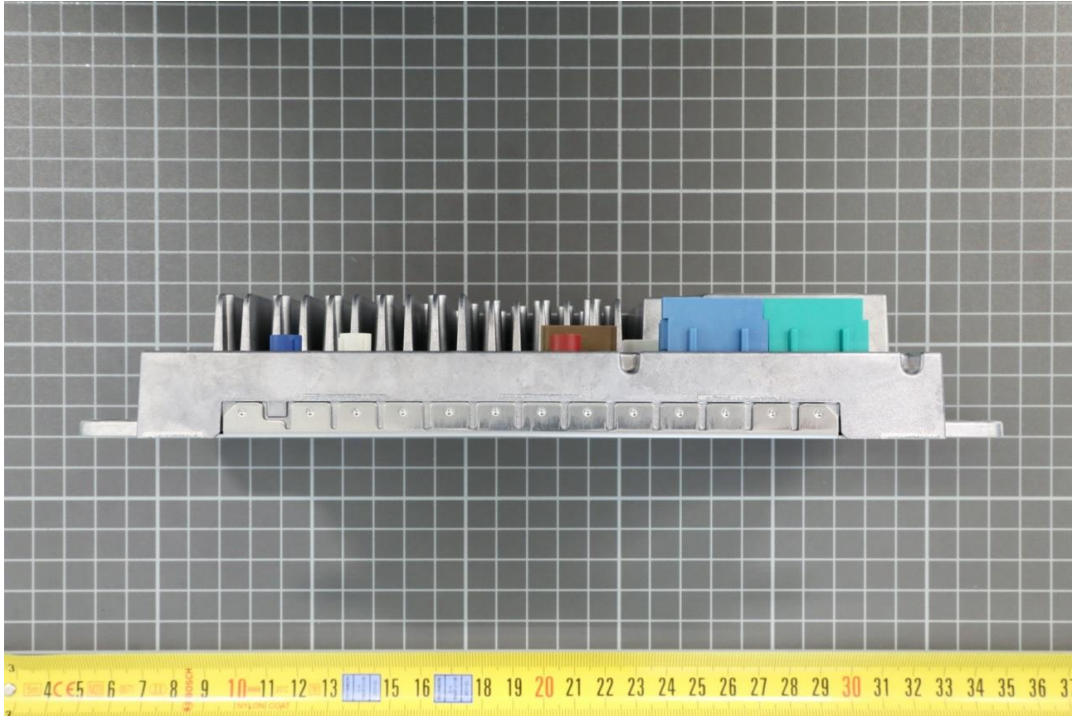
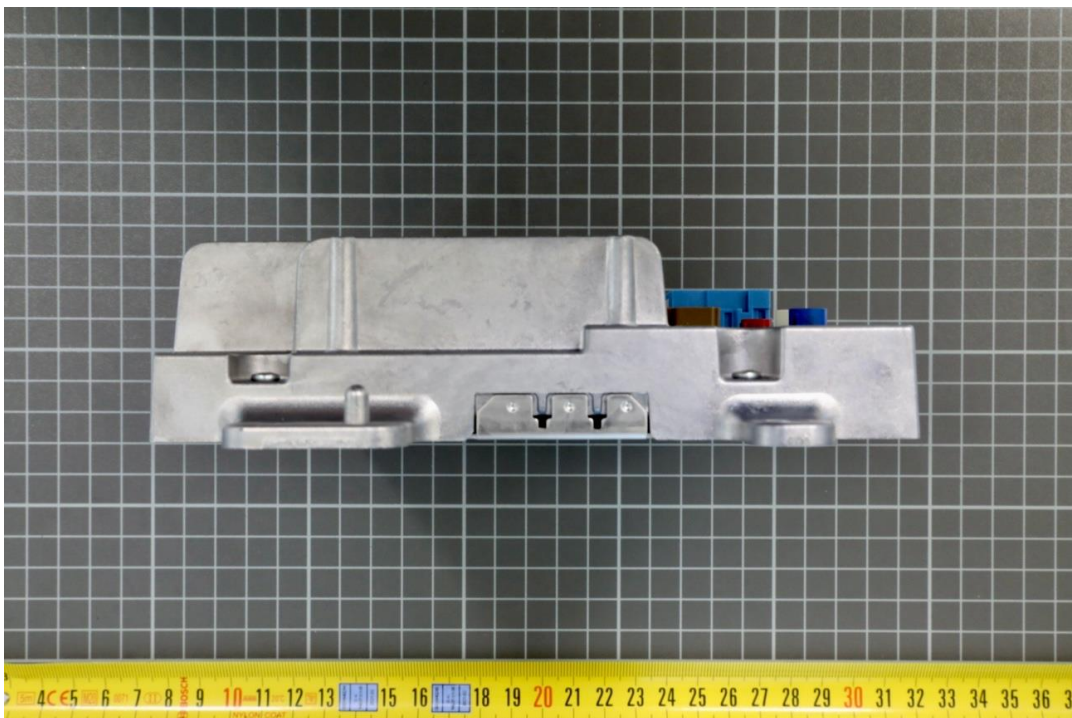
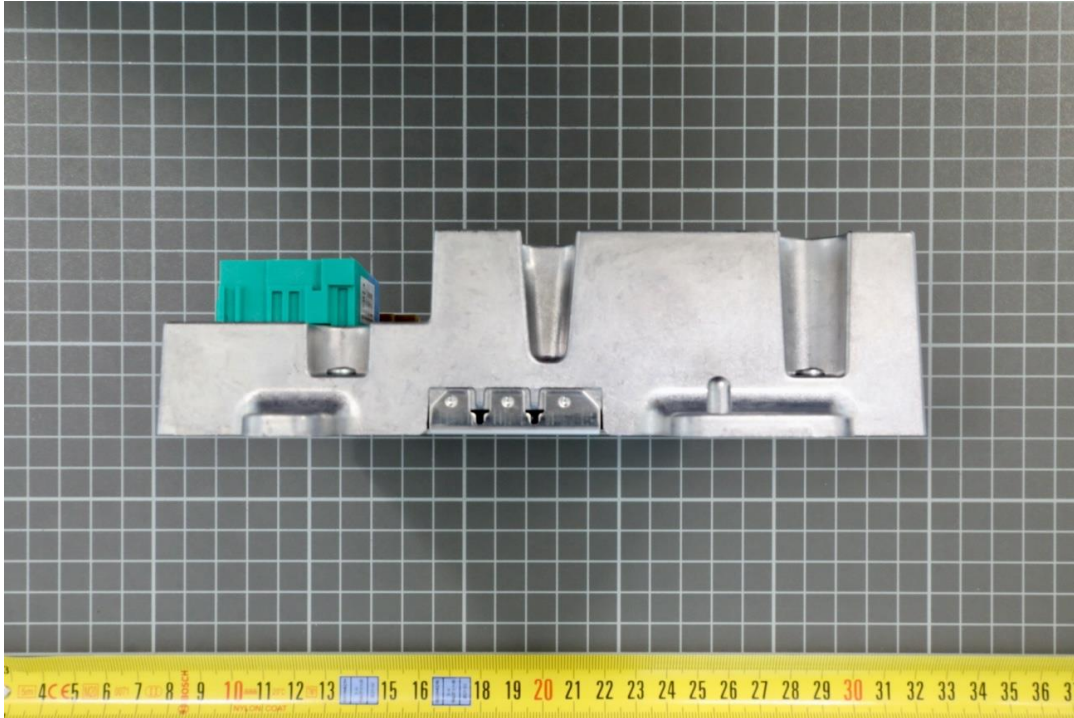


Photo No. 13: side view left



Annex B of TR no.: 21086129-23007-1

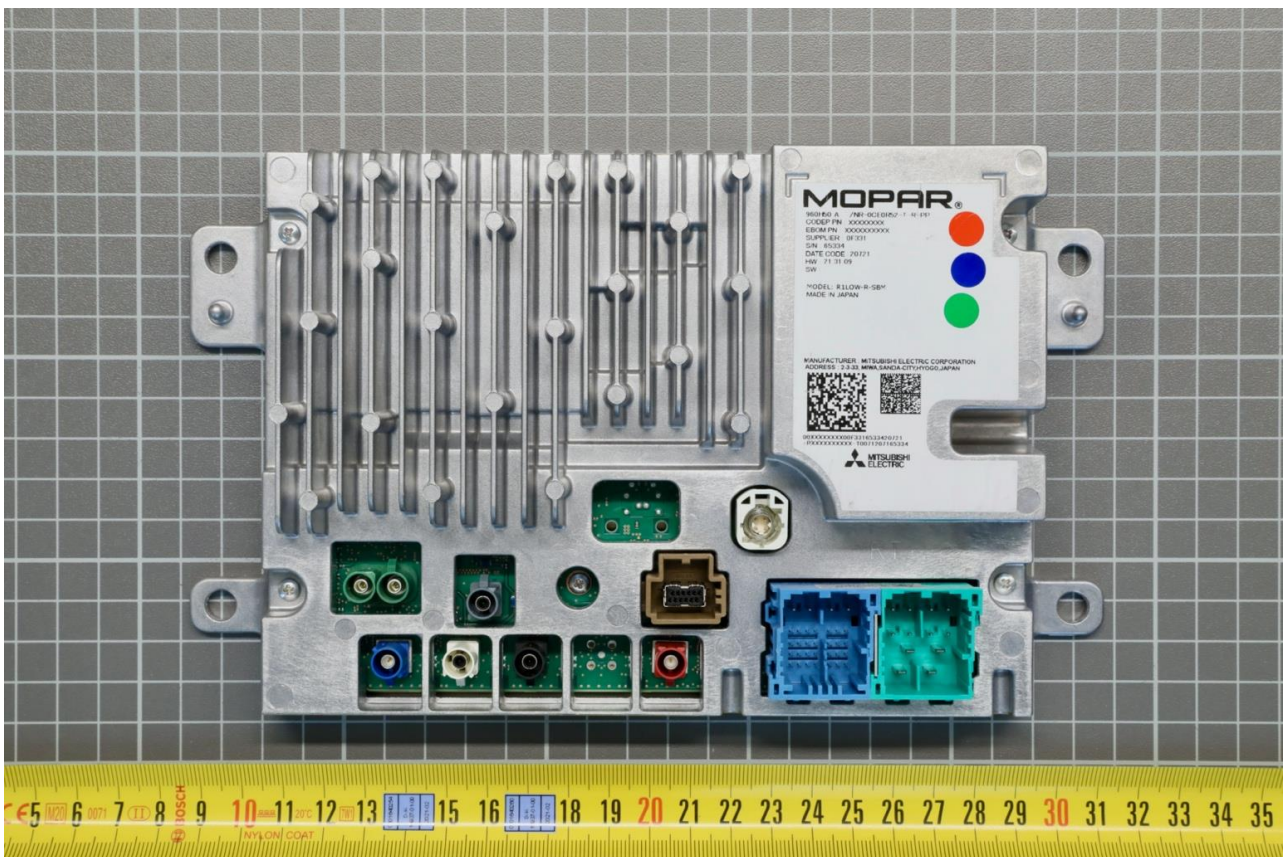
Photo No. 14: side view right



2.3 Variant ID #39

2.3.1 Radiated EUT, serial number 65334

Photo No. 15: rear view



Annex B of TR no.: 21086129-23007-1

Photo No. 16: front view

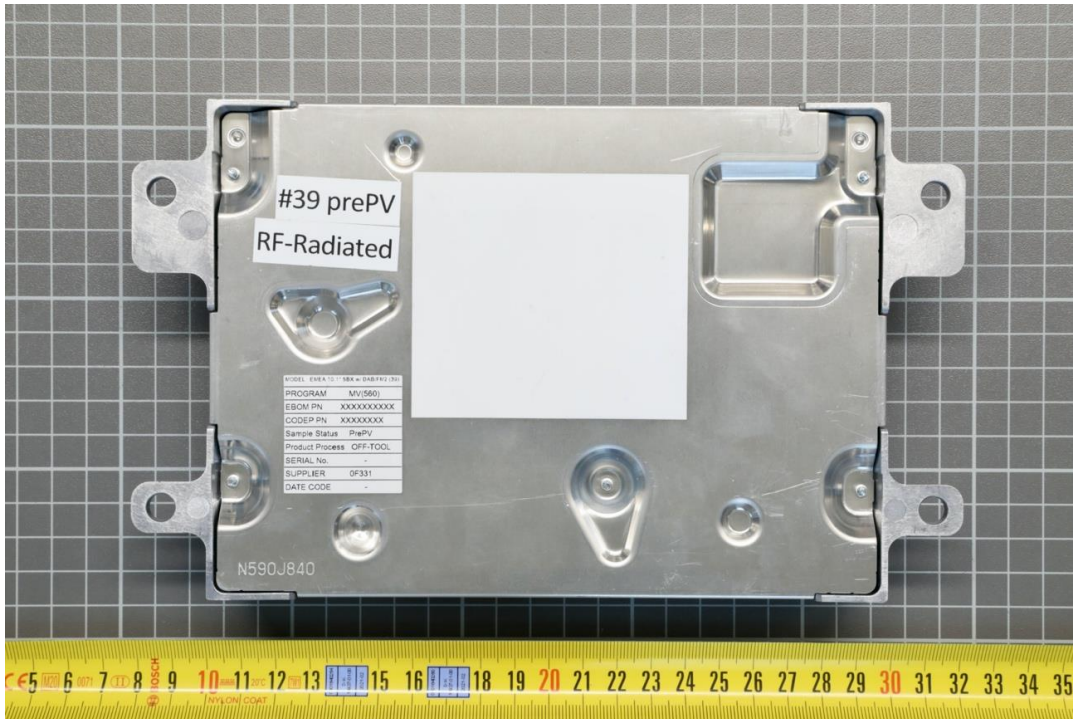
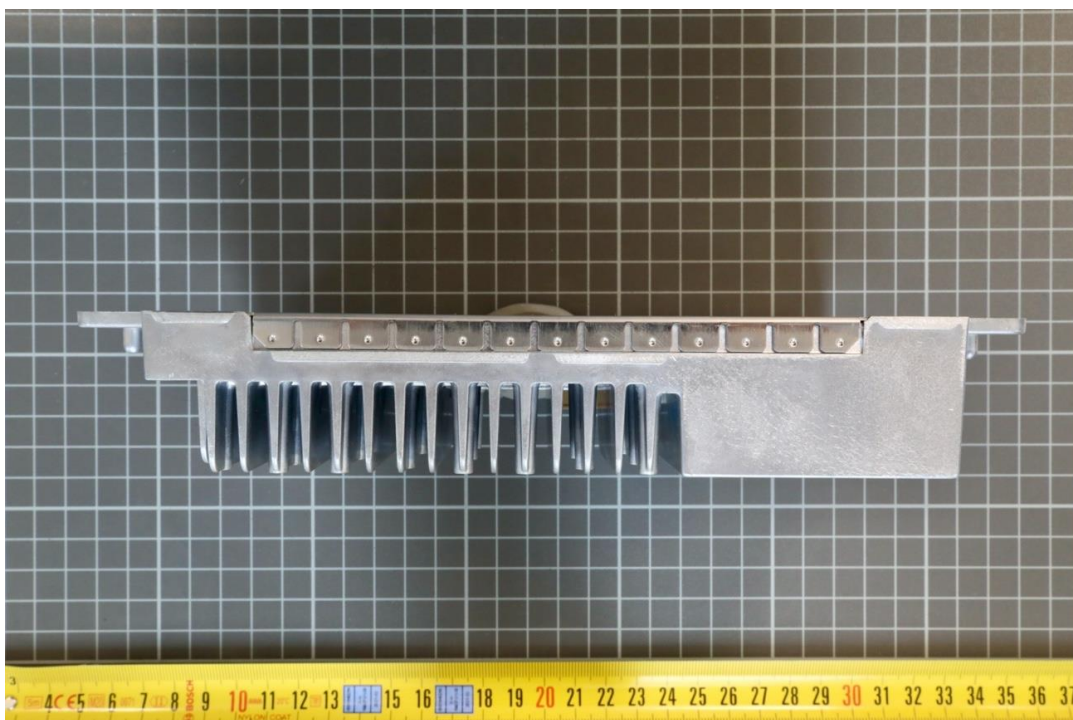


Photo No. 17: top view



Annex B of TR no.: 21086129-23007-1

Photo No. 18: bottom view

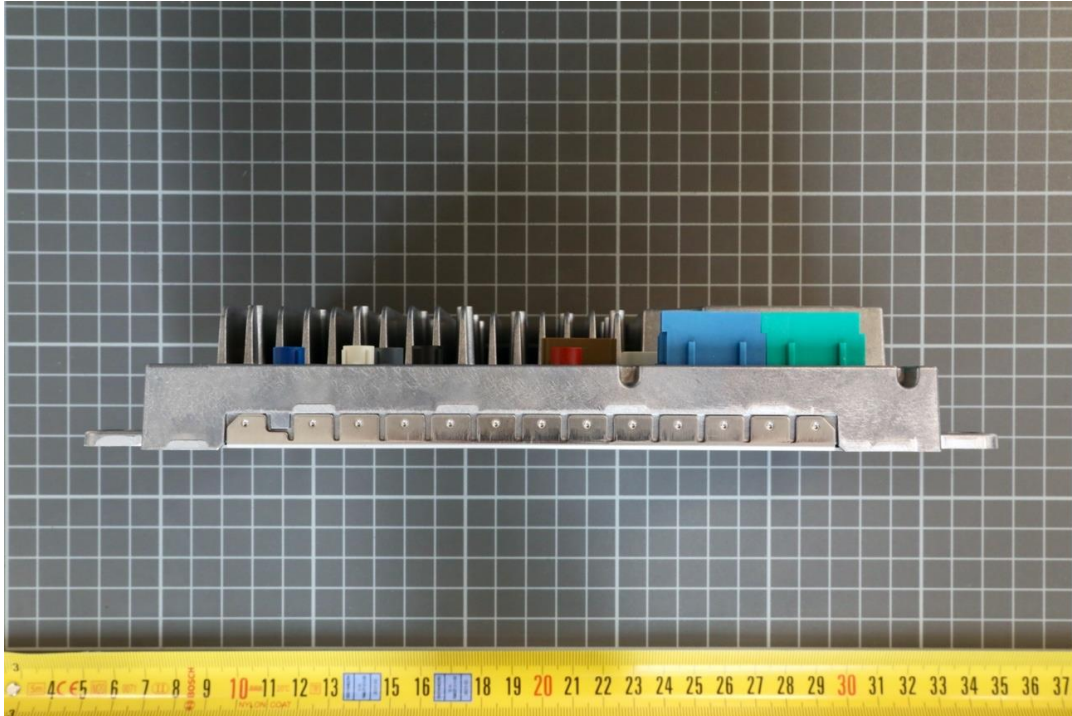
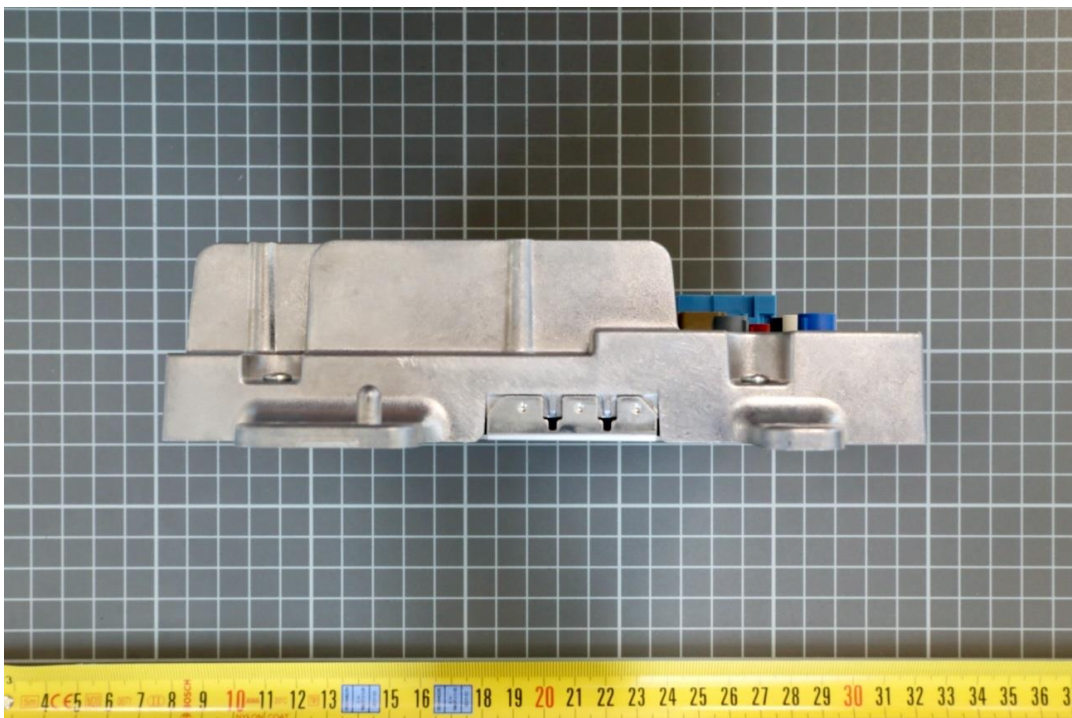
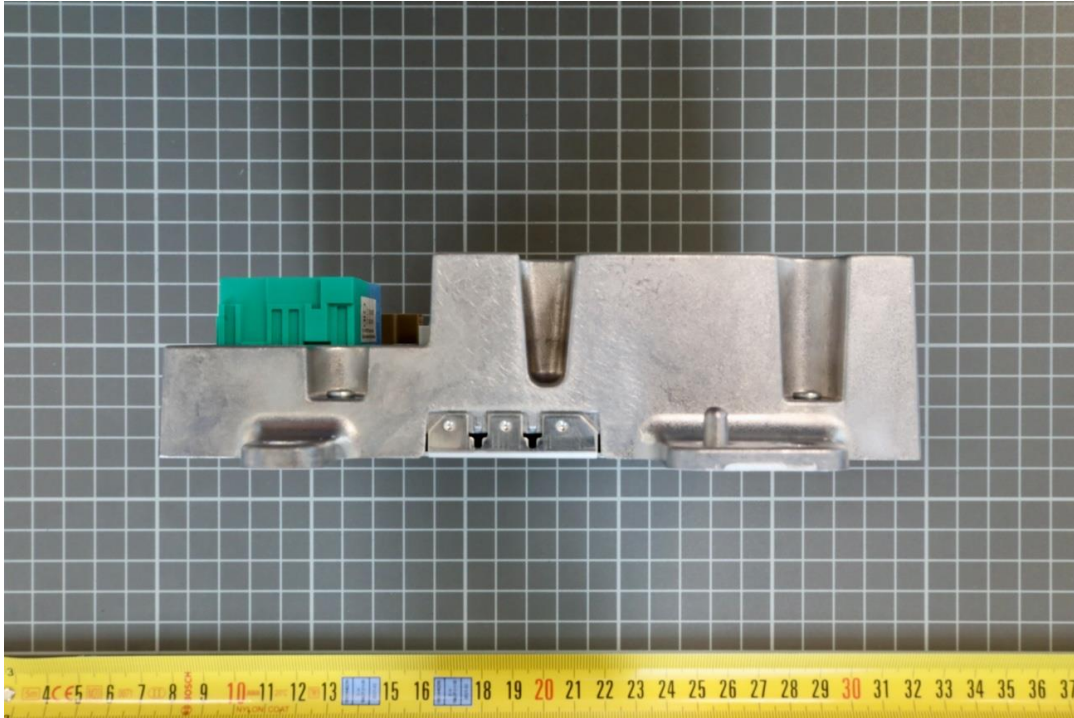


Photo No. 19: side view left



Annex B of TR no.: 21086129-23007-1

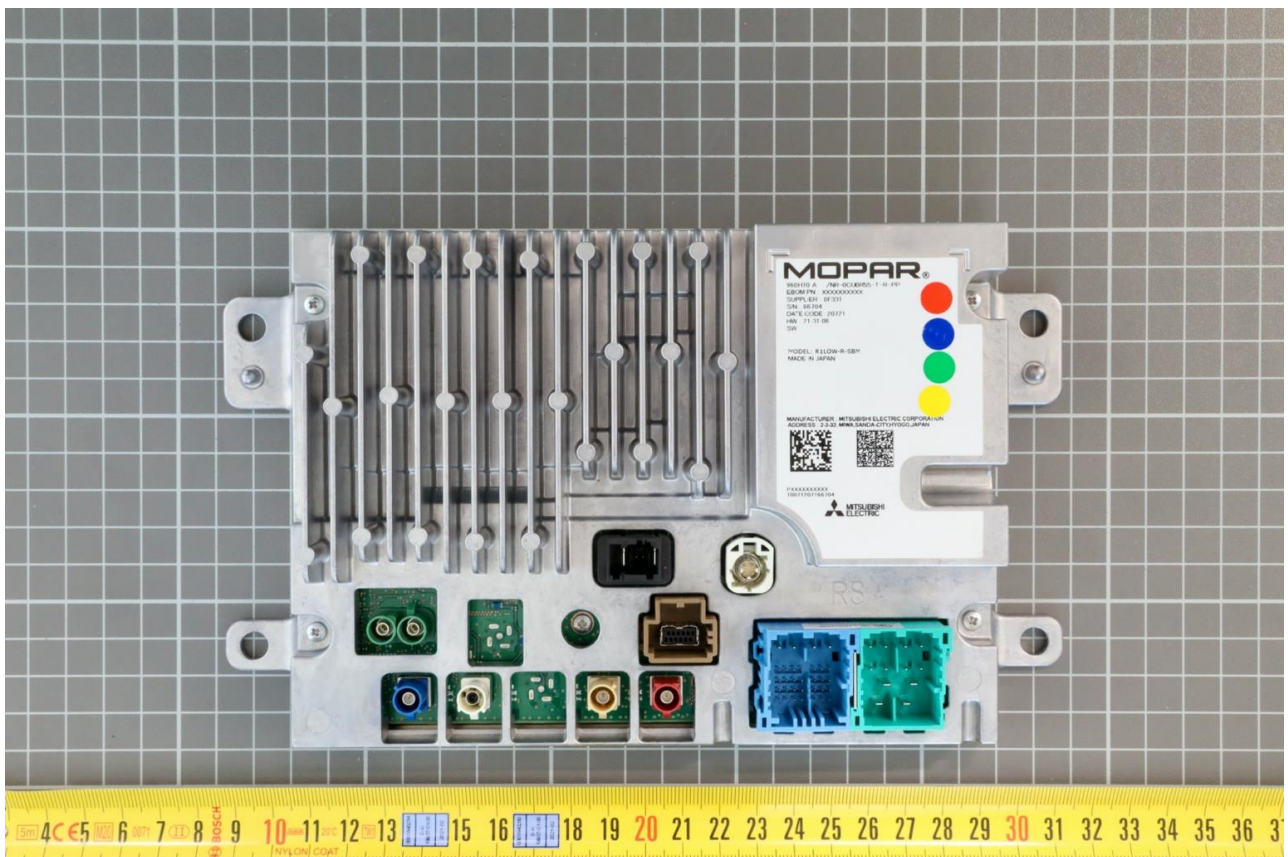
Photo No. 20: side view right



2.4 Variant ID #43

2.4.1 Radiated EUT, serial number 66704

Photo No. 21: rear view

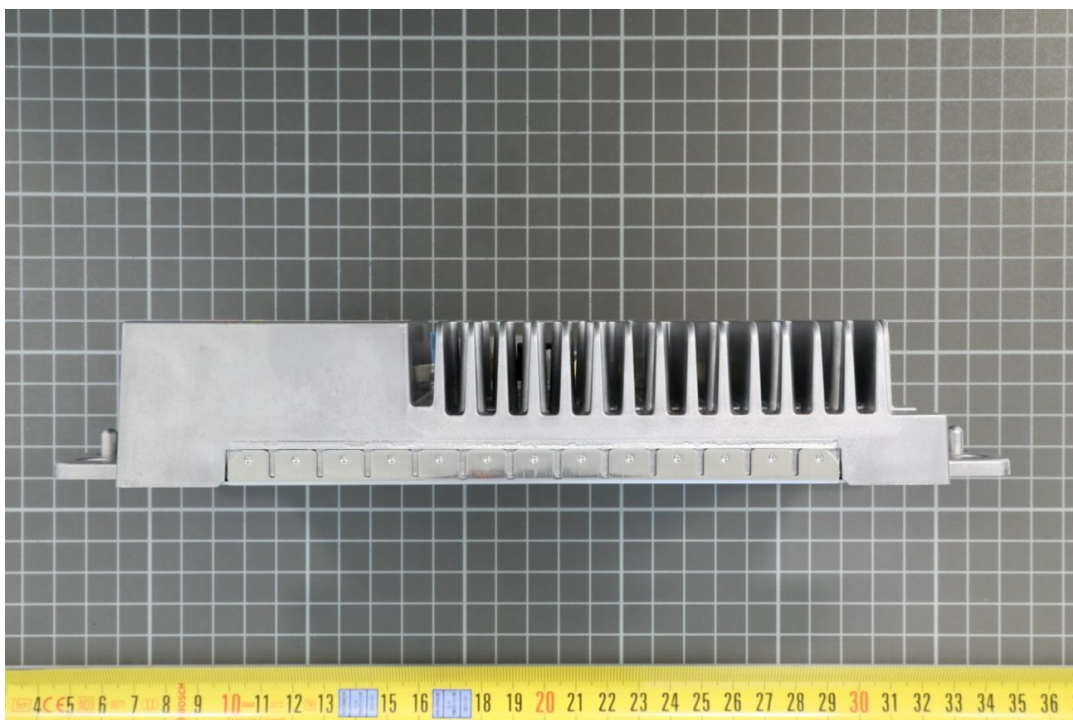


Annex B of TR no.: 21086129-23007-1

Photo No. 22: front view



Photo No. 23: top view



Annex B of TR no.: 21086129-23007-1

Photo No. 24: bottom view

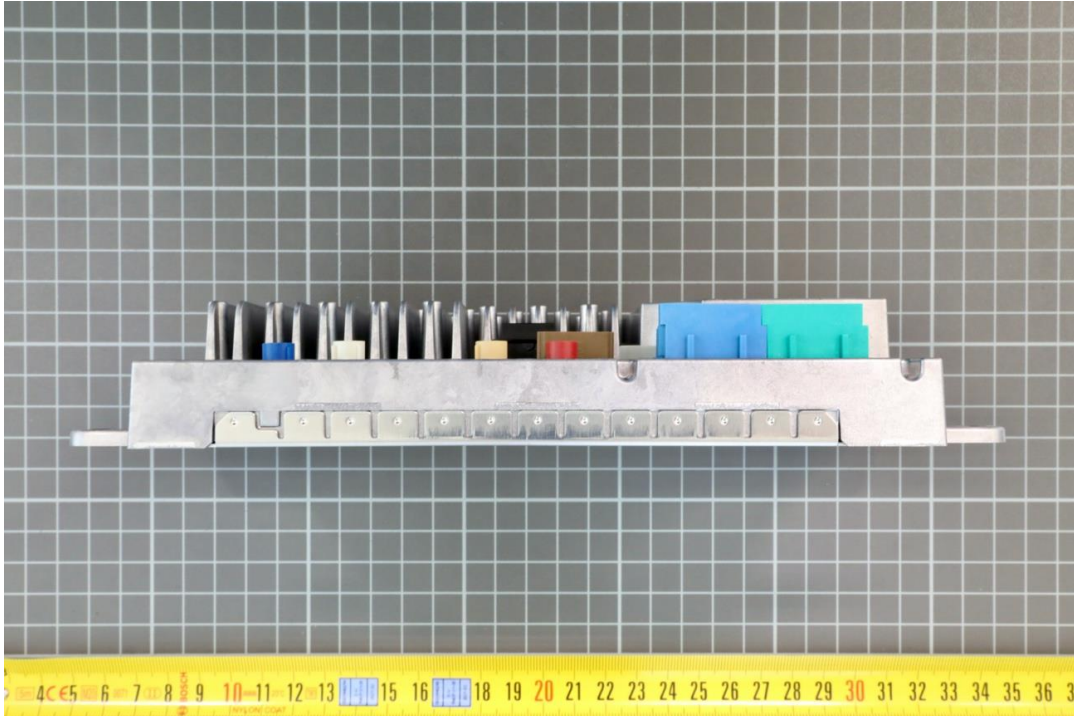
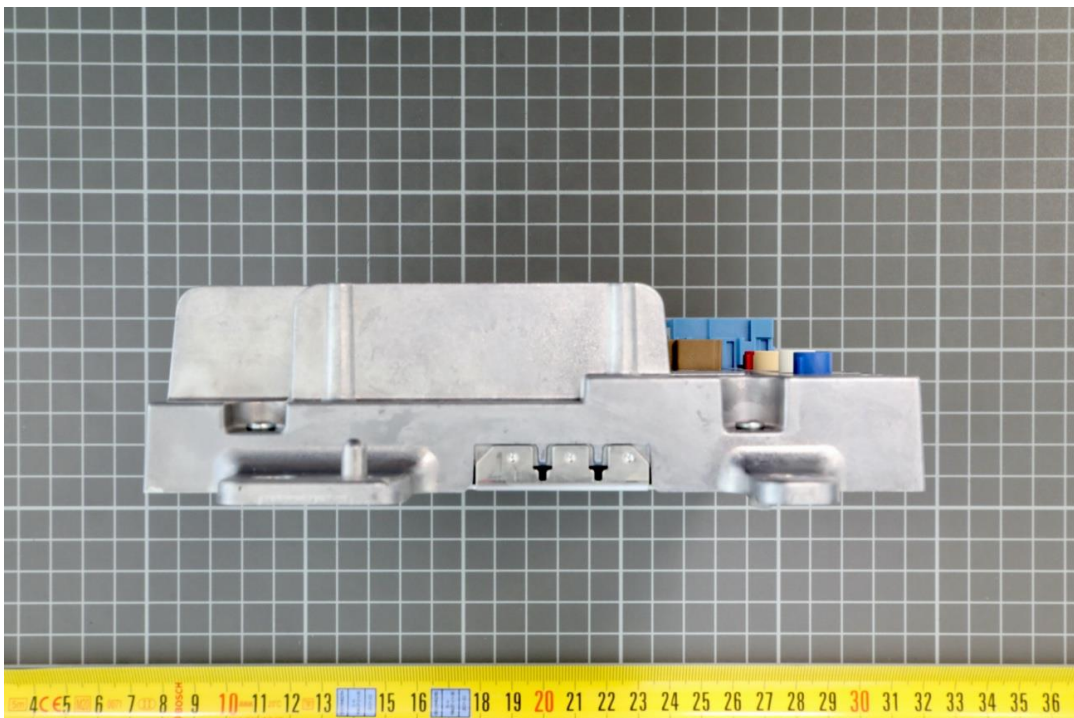
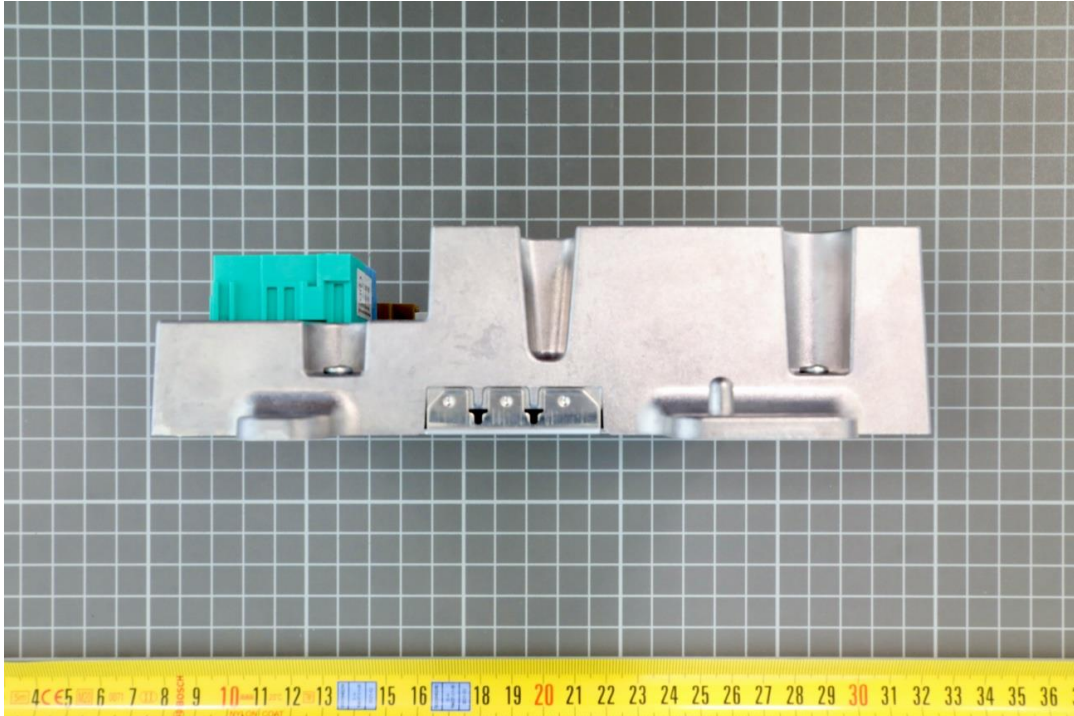


Photo No. 25: side view left



Annex B of TR no.: 21086129-23007-1

Photo No. 26: side view right

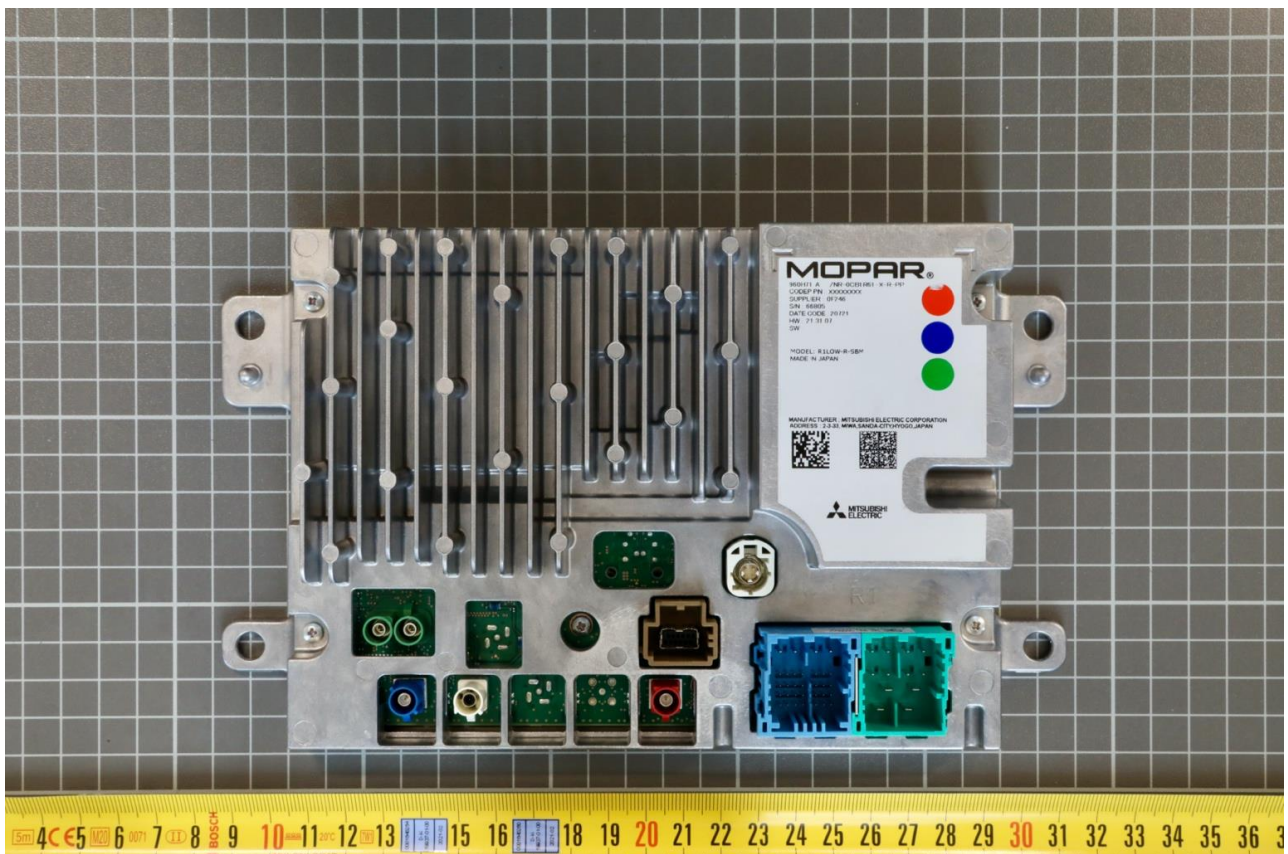


Annex B of TR no.: 21086129-23007-1

2.5 Variant ID #48

2.5.1 Radiated EUT, serial number 66805

Photo No. 27: rear view



Annex B of TR no.: 21086129-23007-1

Photo No. 28: front view

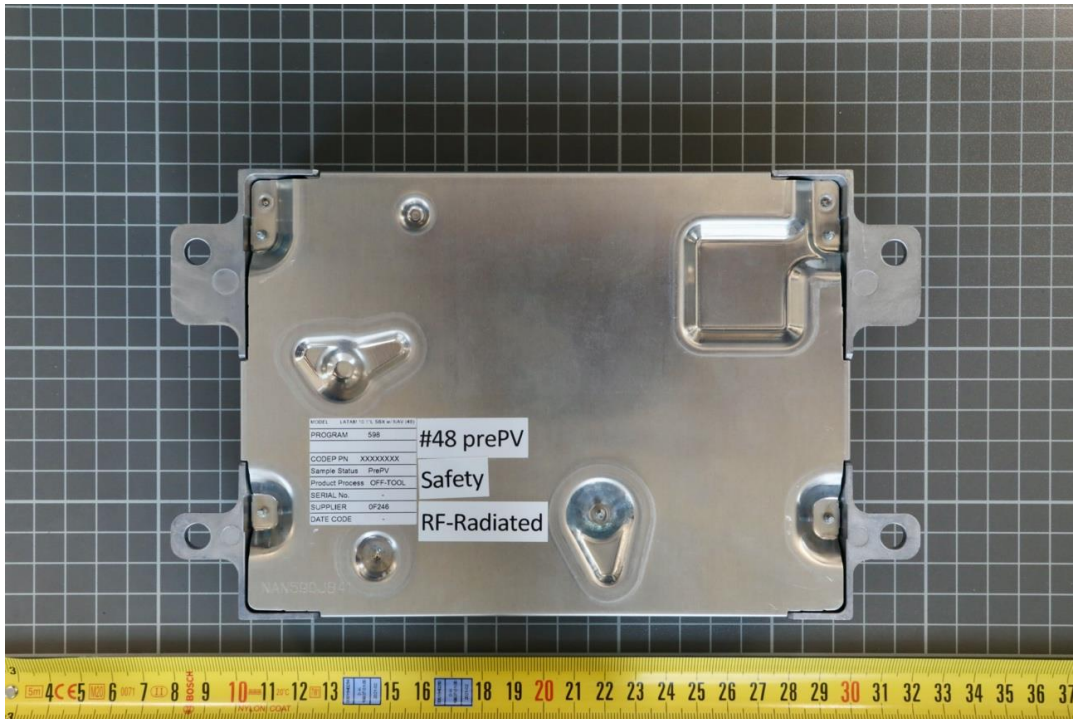
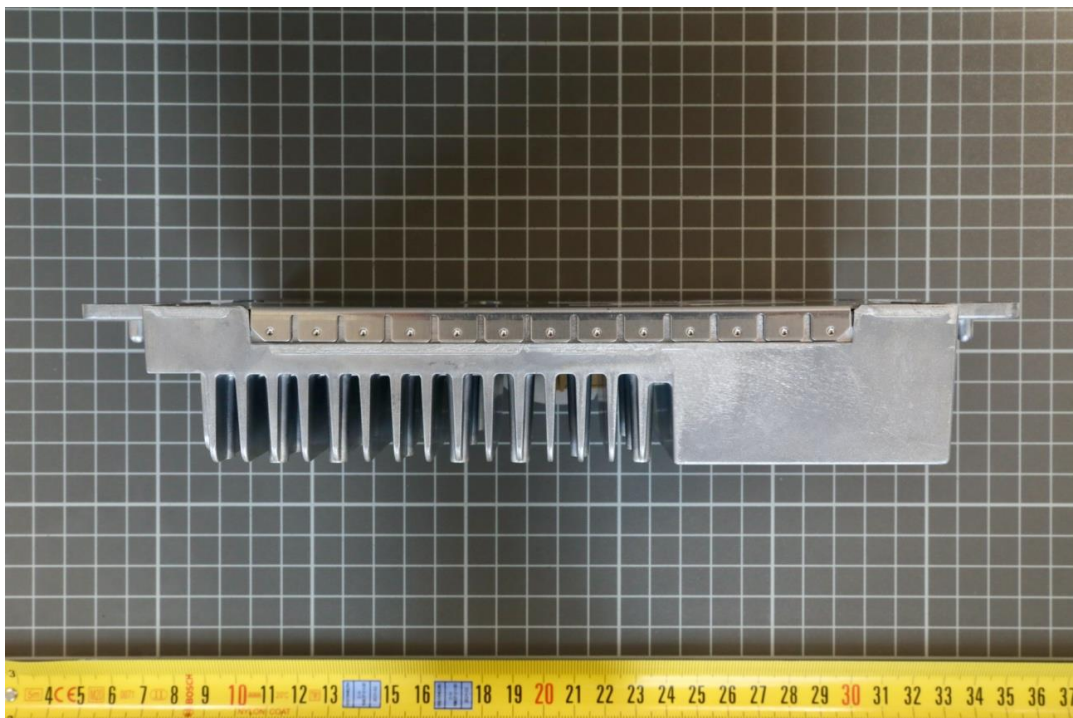


Photo No. 29: top view

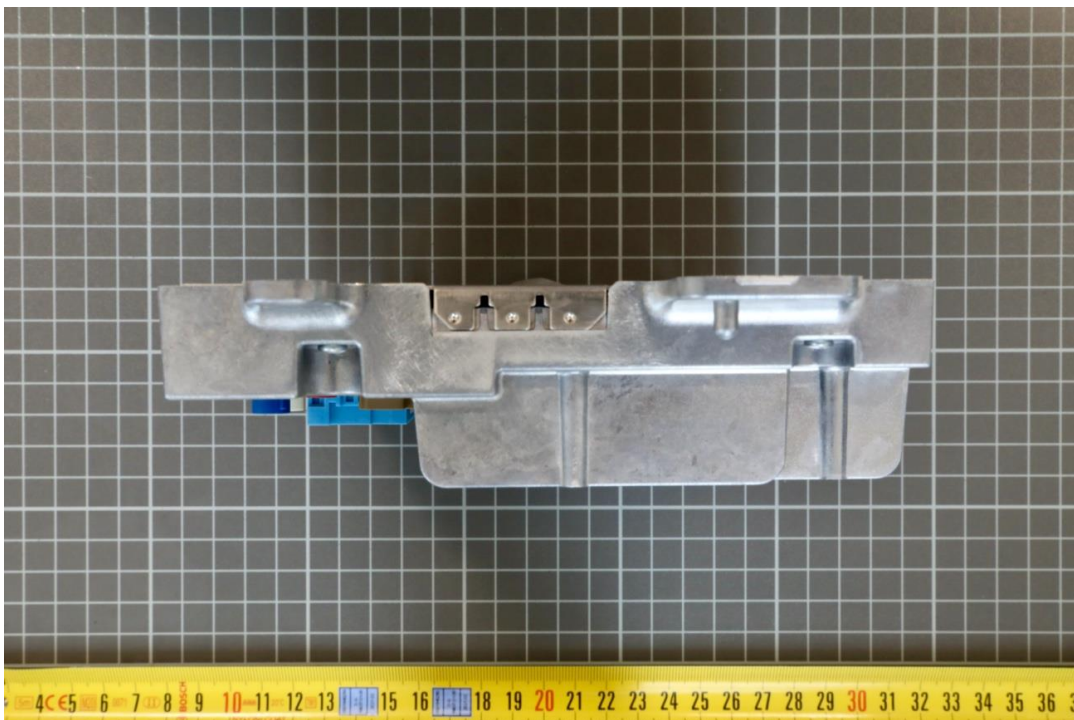


Annex B of TR no.: 21086129-23007-1

Photo No. 30: bottom view

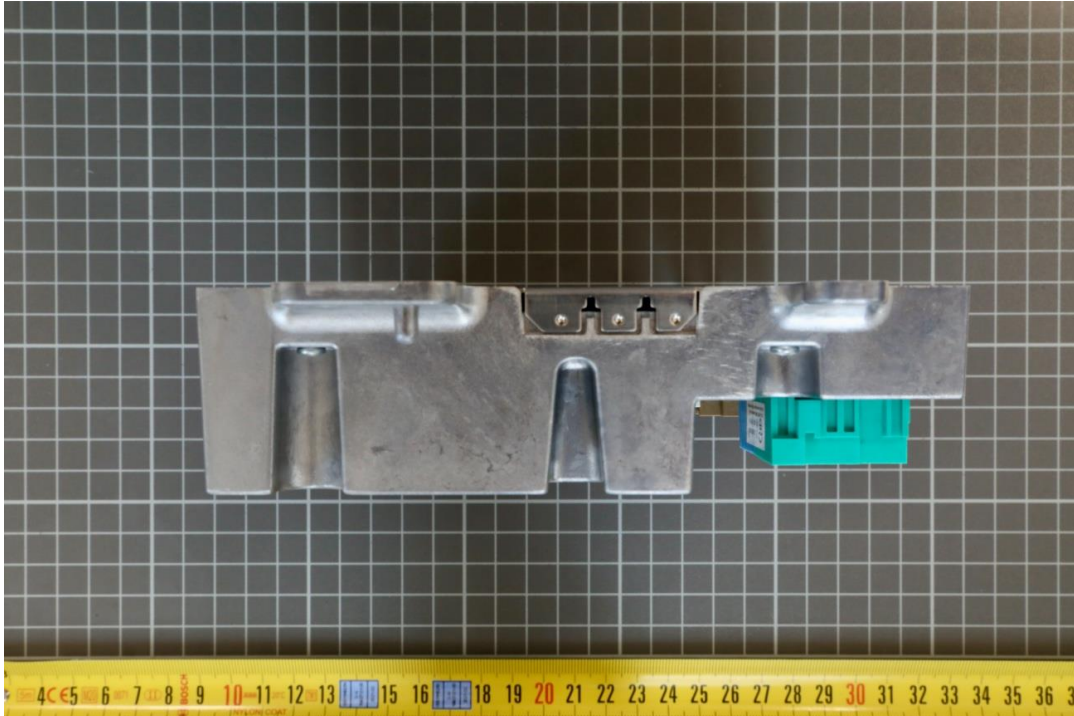


Photo No. 31: side view left



Annex B of TR no.: 21086129-23007-1

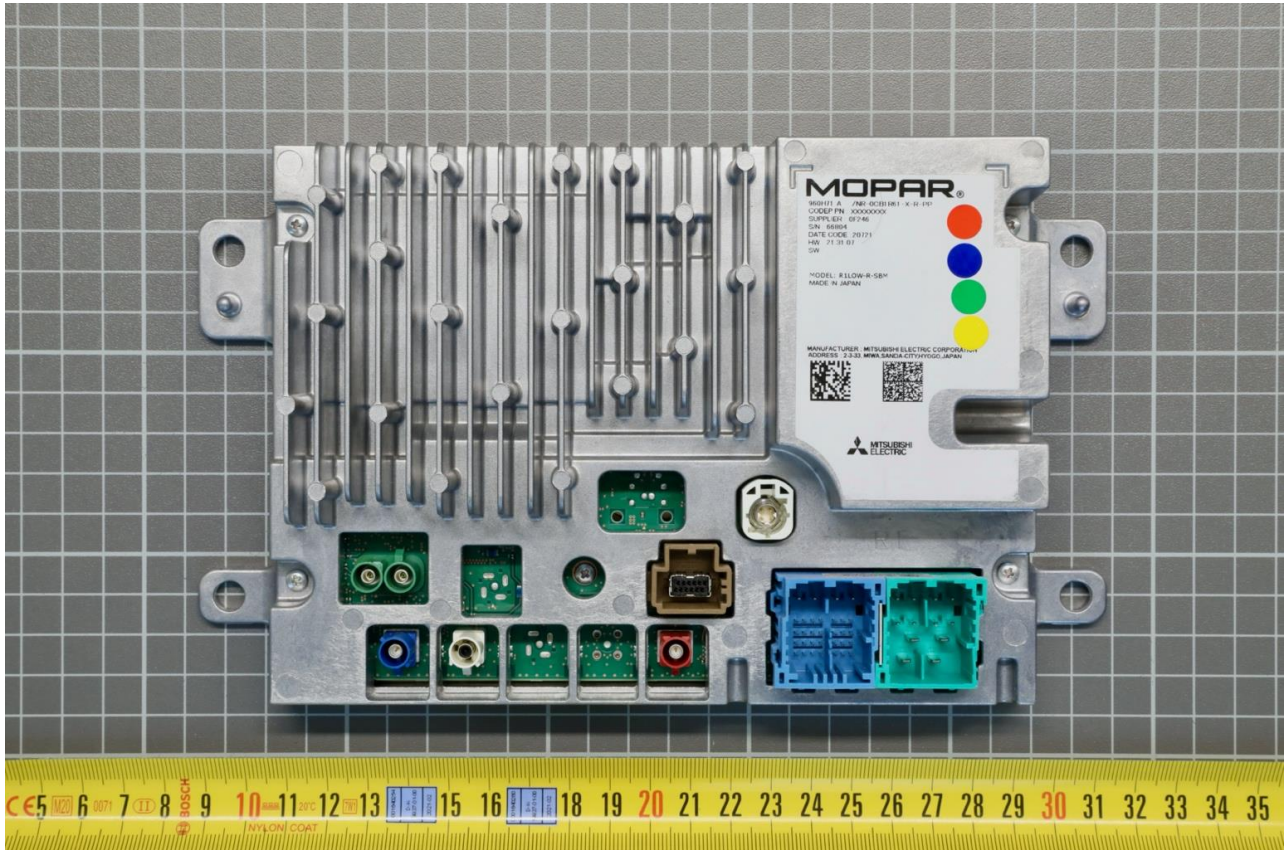
Photo No. 32: side view right



Annex B of TR no.: 21086129-23007-1

2.5.2 Radiated EUT, serial number 66804

Photo No. 33: rear view



Annex B of TR no.: 21086129-23007-1

Photo No. 34: front view



2.6 External antenna

Photo No. 35: R1LOW-R-SBM external antenna



Photo No. 36: R1LOW-R-SBM external antenna



3 Revision History

-0 Initial Version

-1 Revision: administrative modification/correction

Change of HVIN

This test report 21086129-23007-1 replaces the previous test report 21086129-23007-0

End of Annex
