

CONSTRUCTION PHOTOS OF EUT

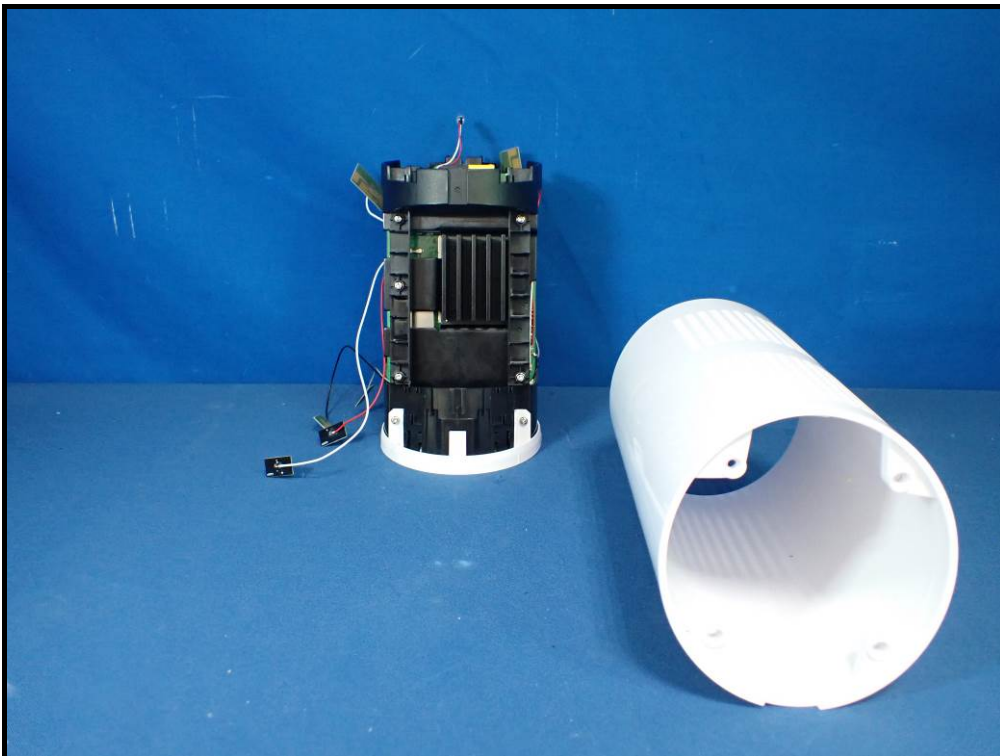

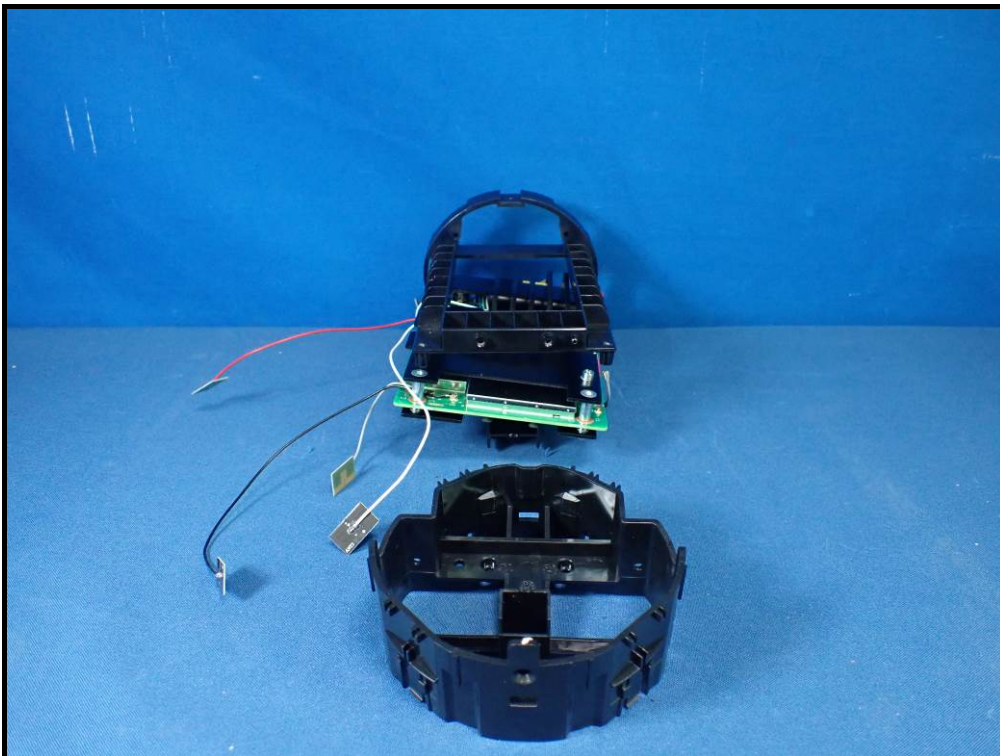

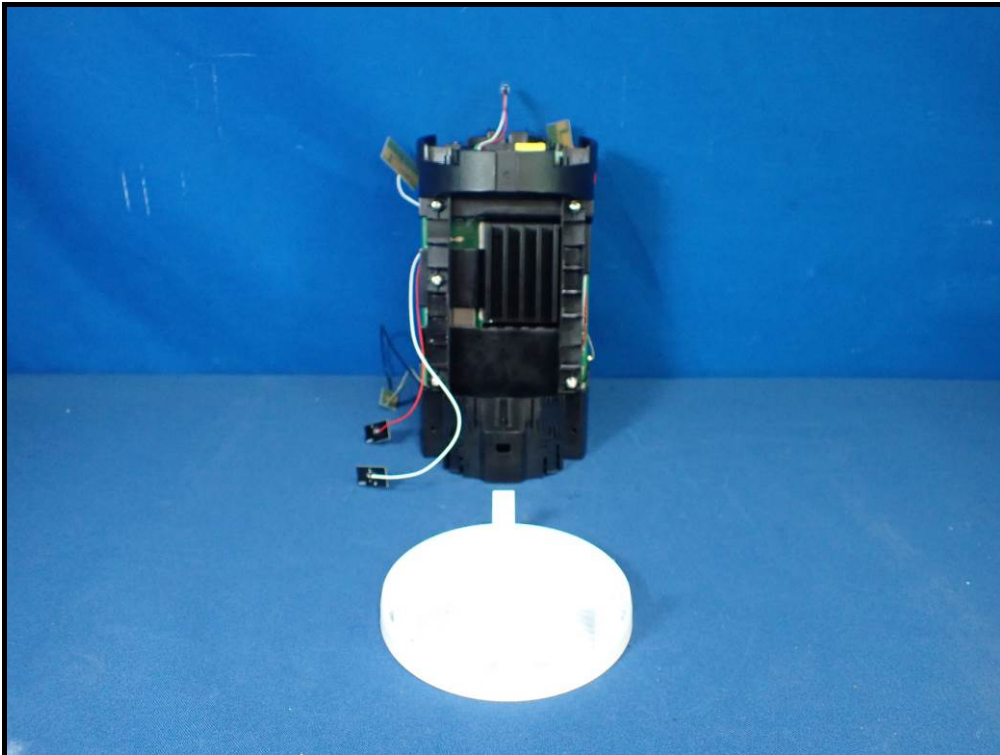

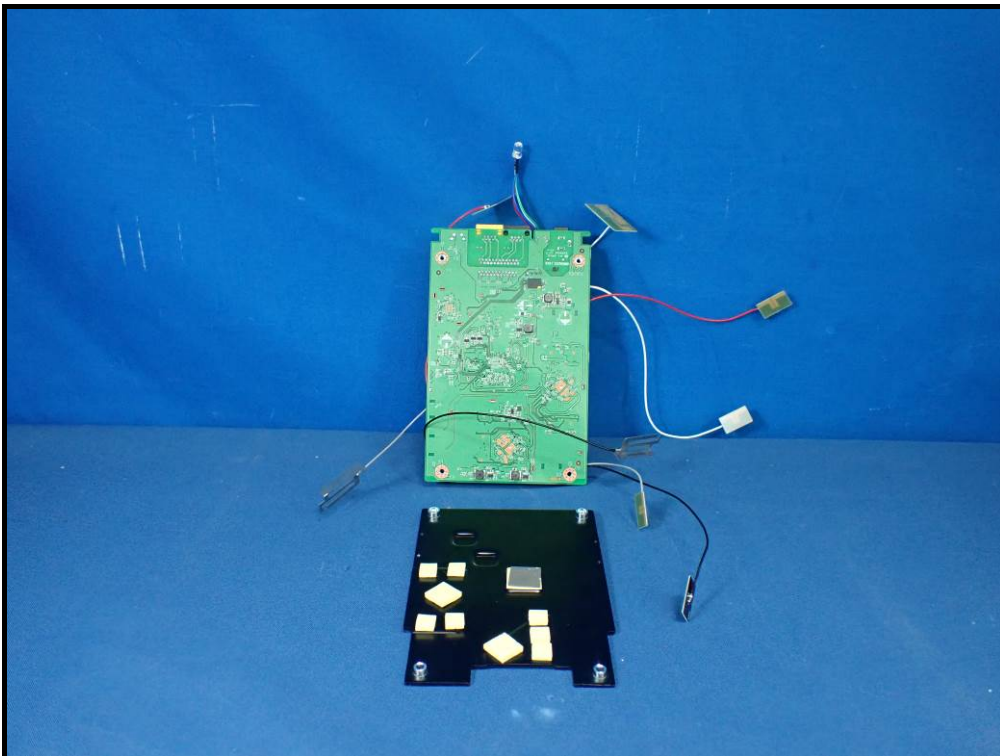
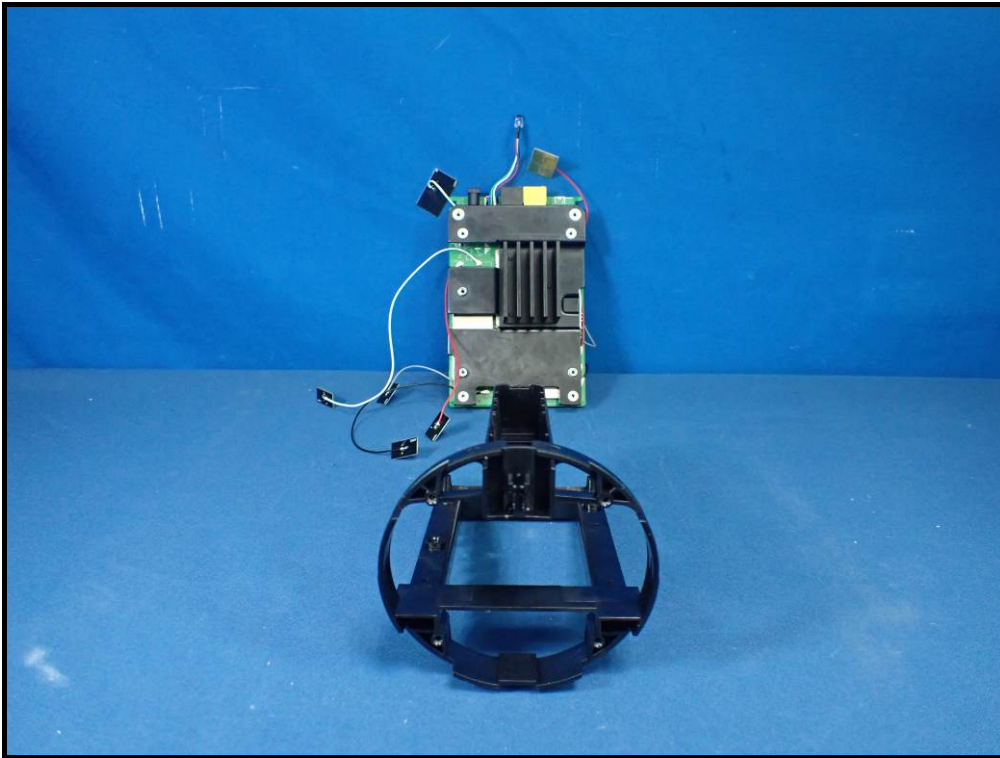
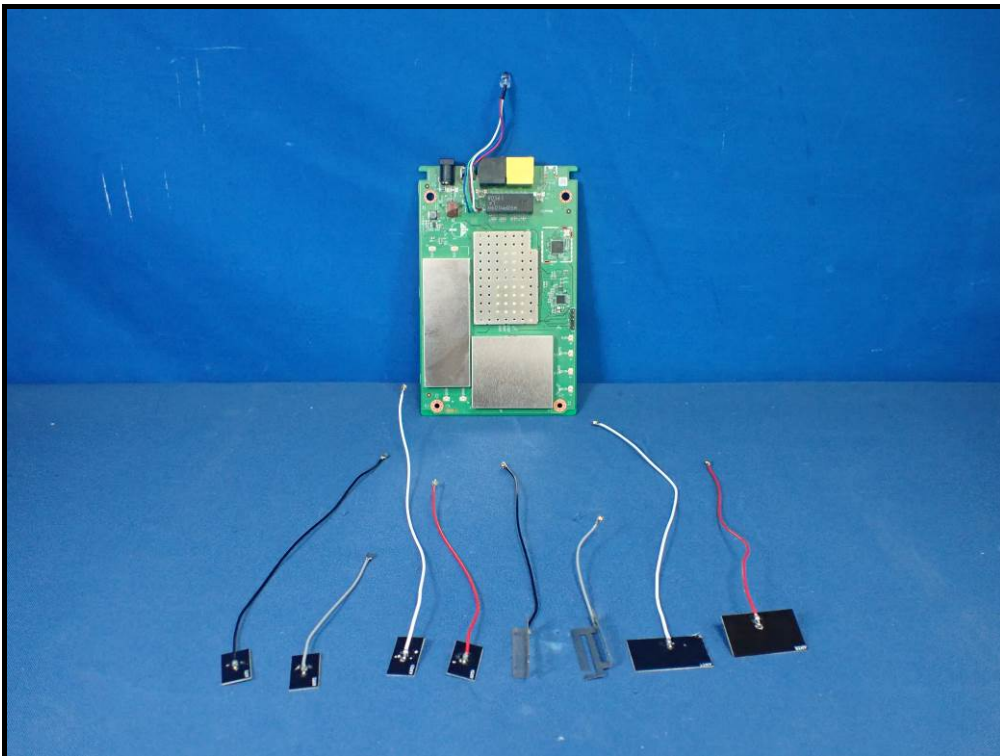
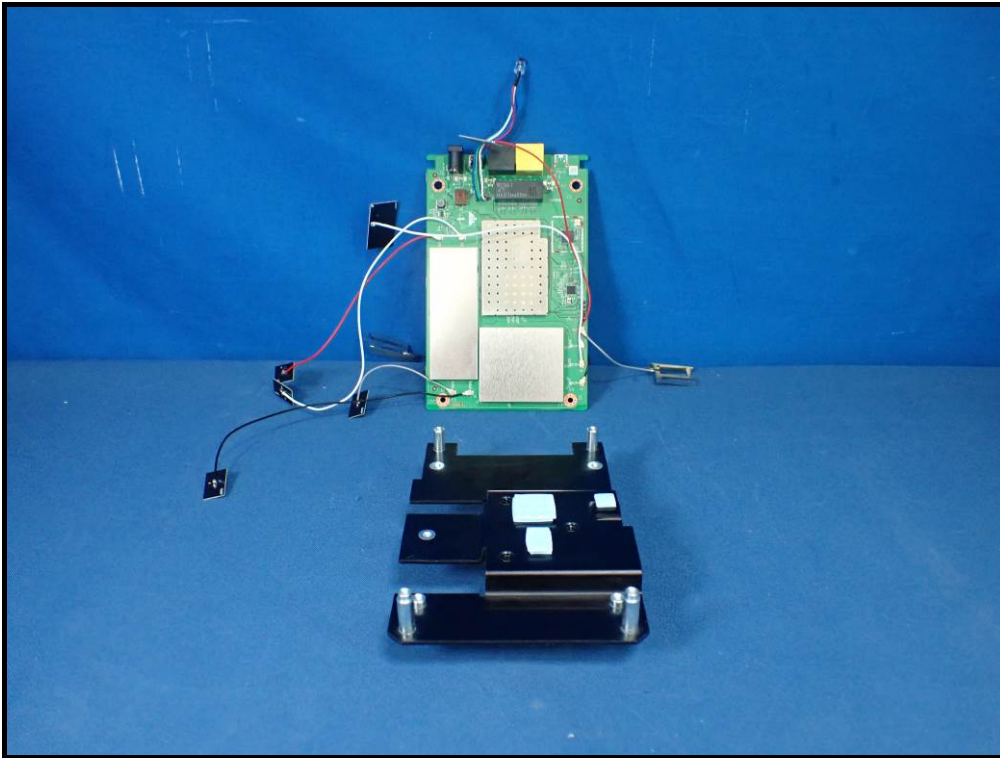

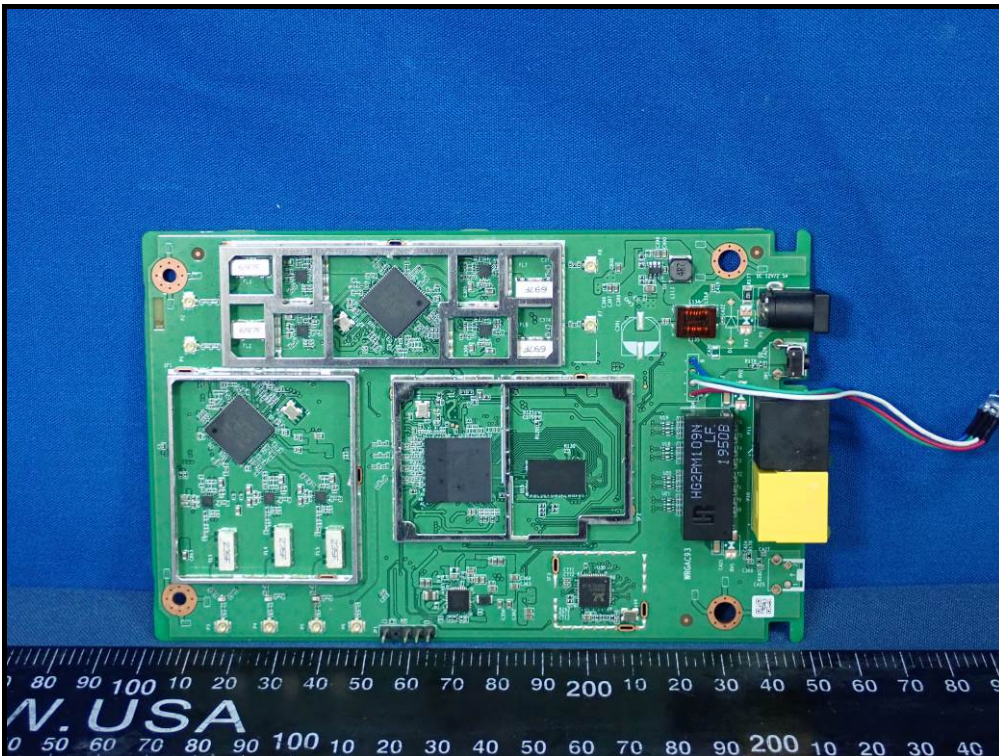
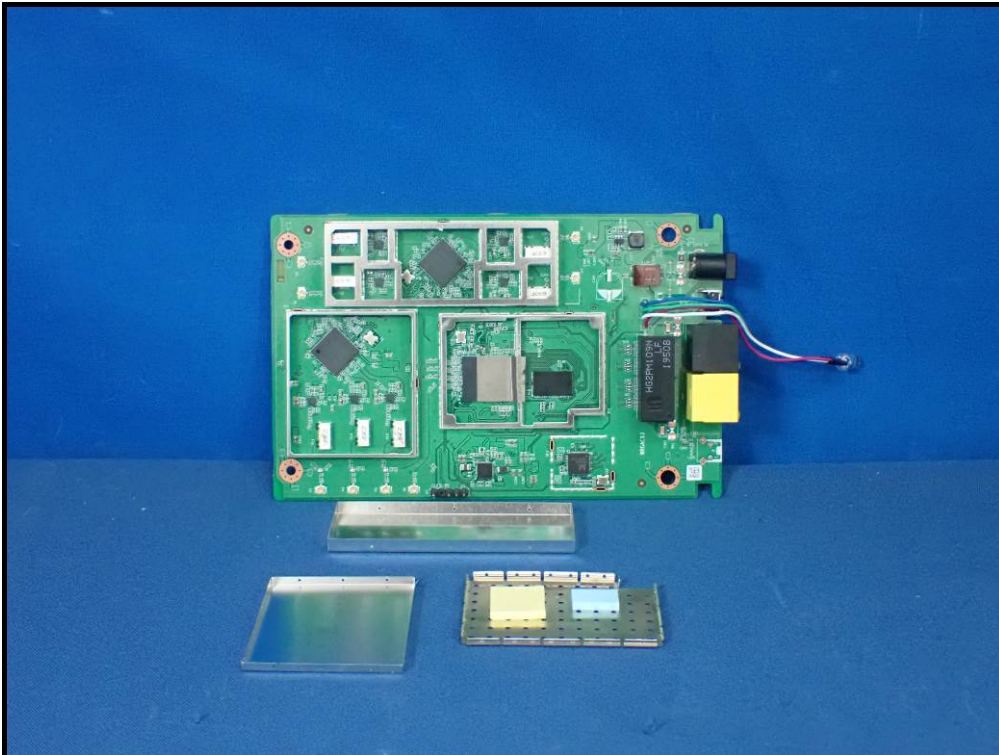

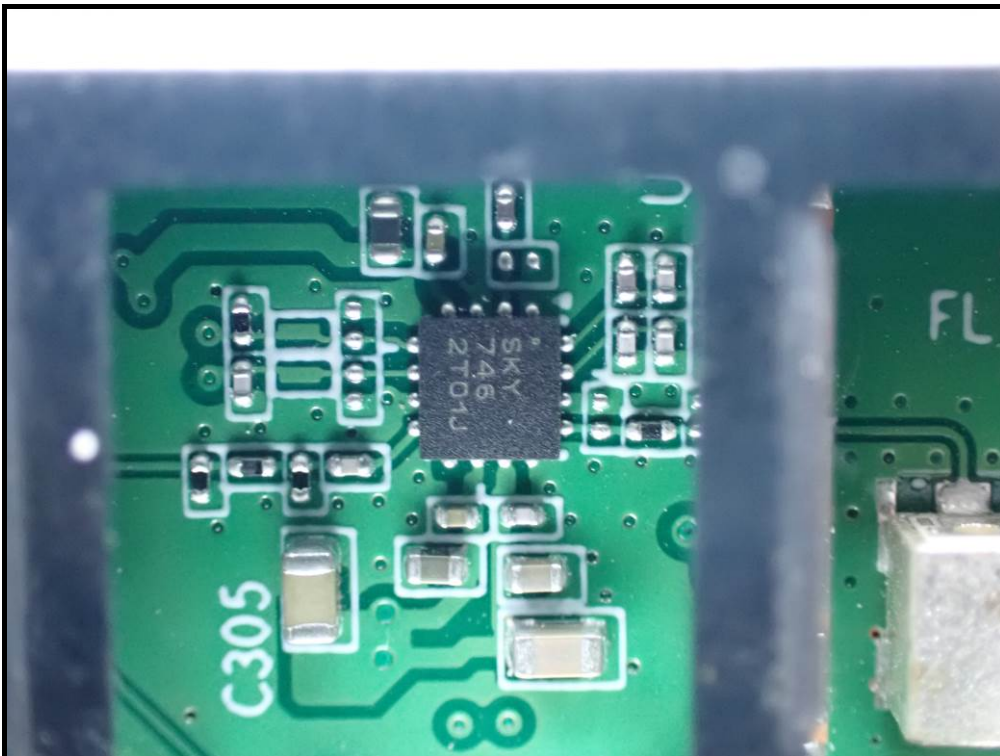
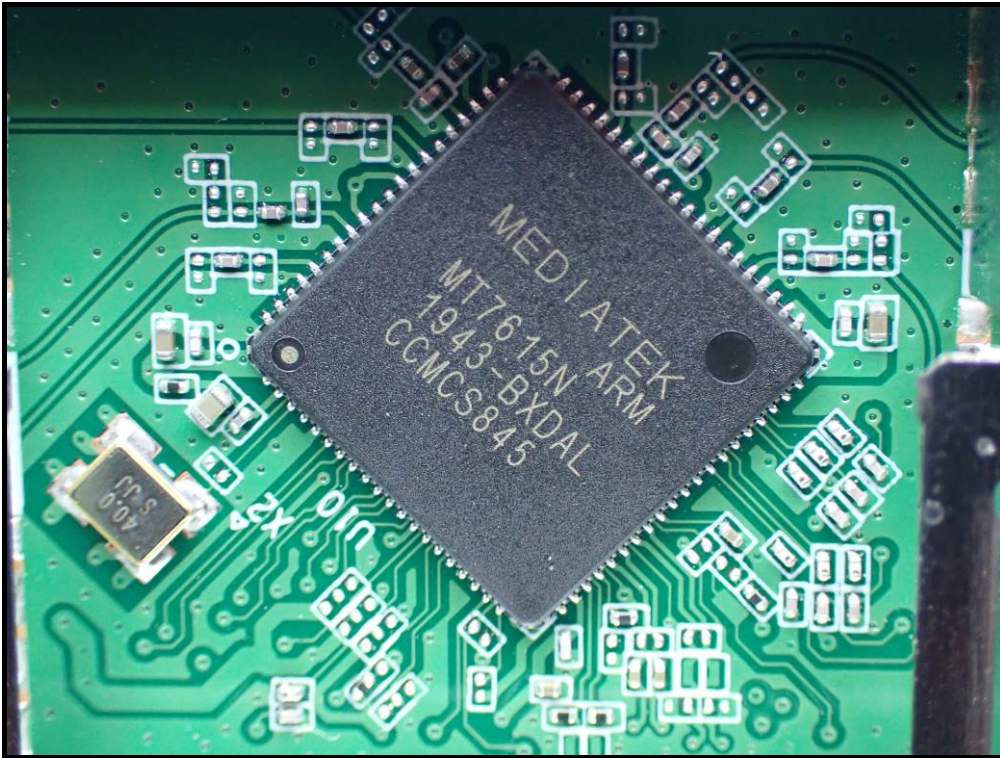

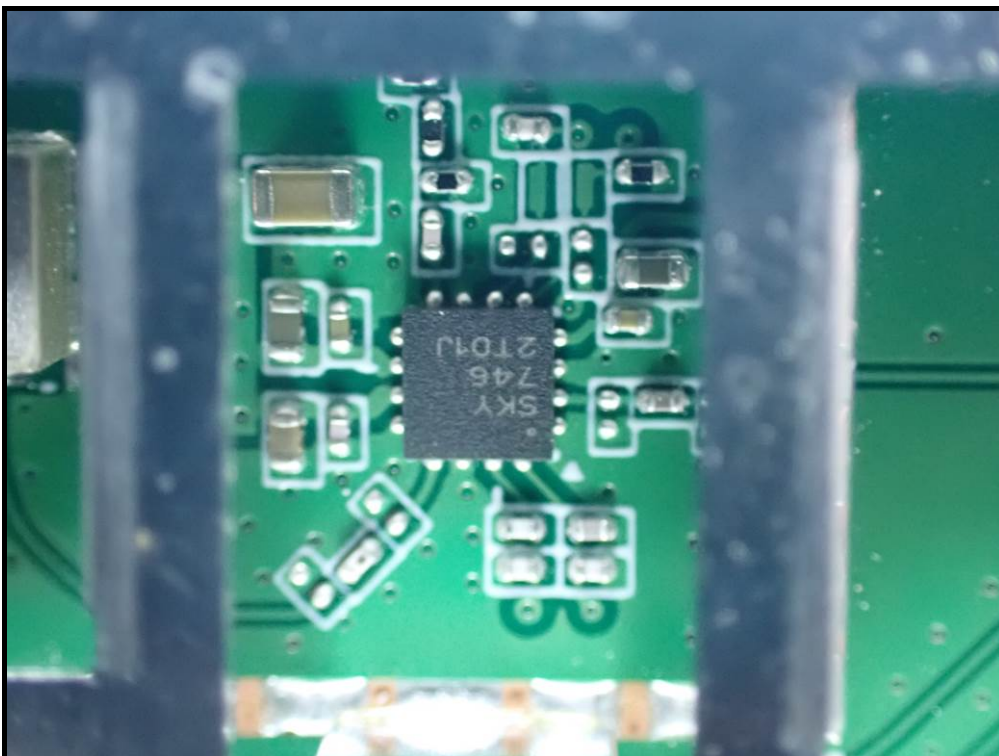
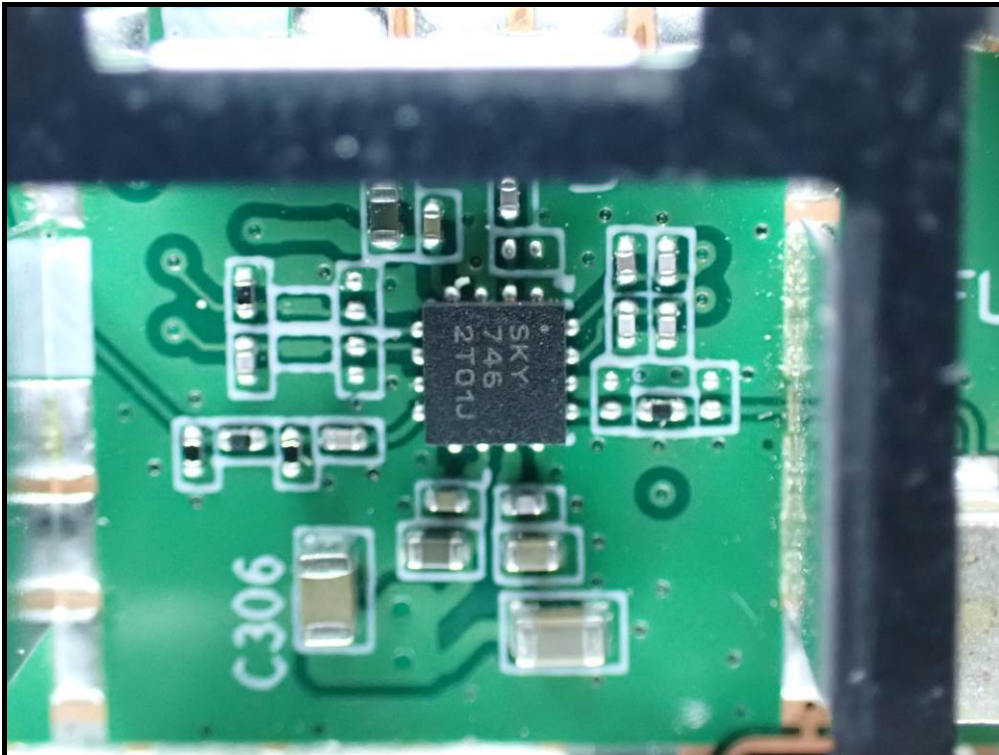

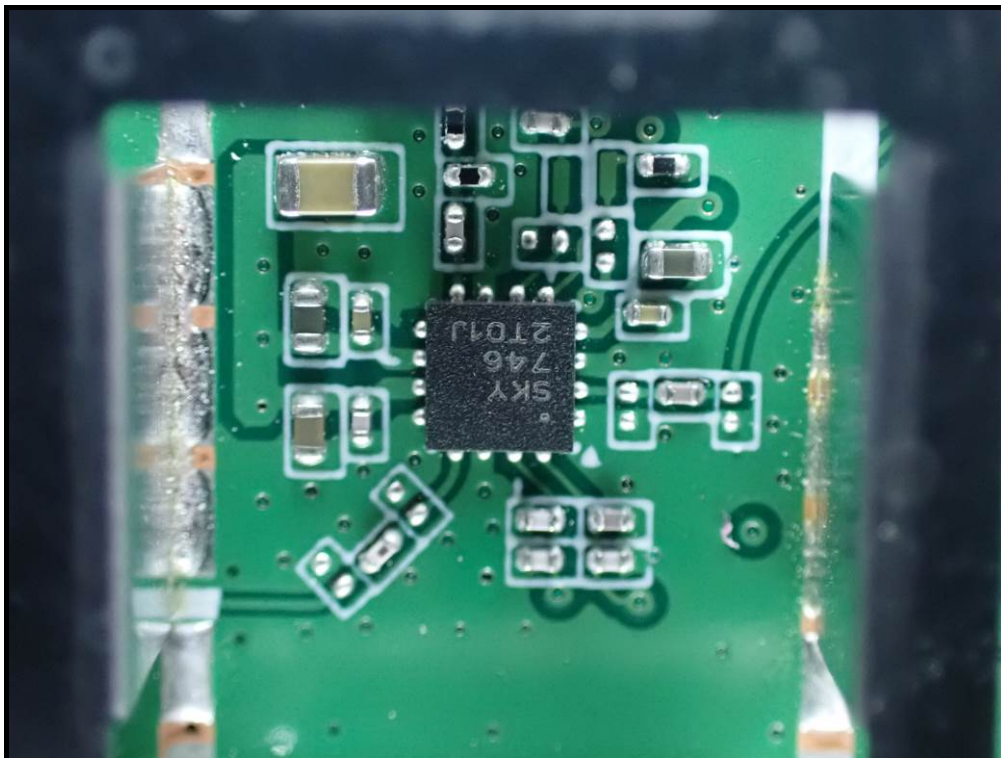

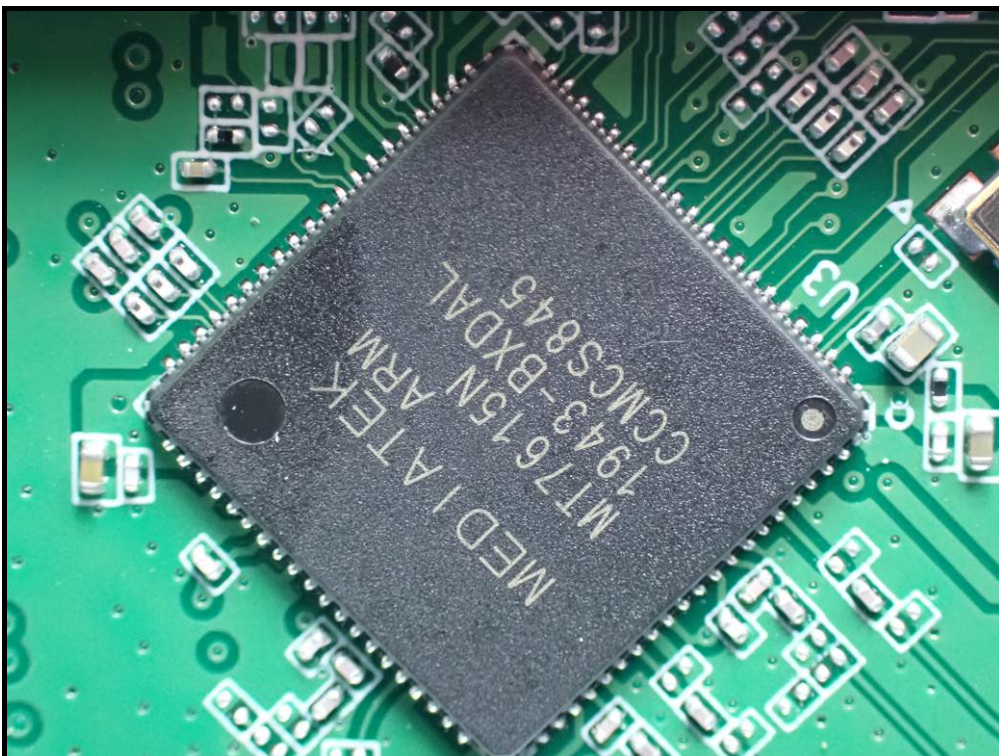
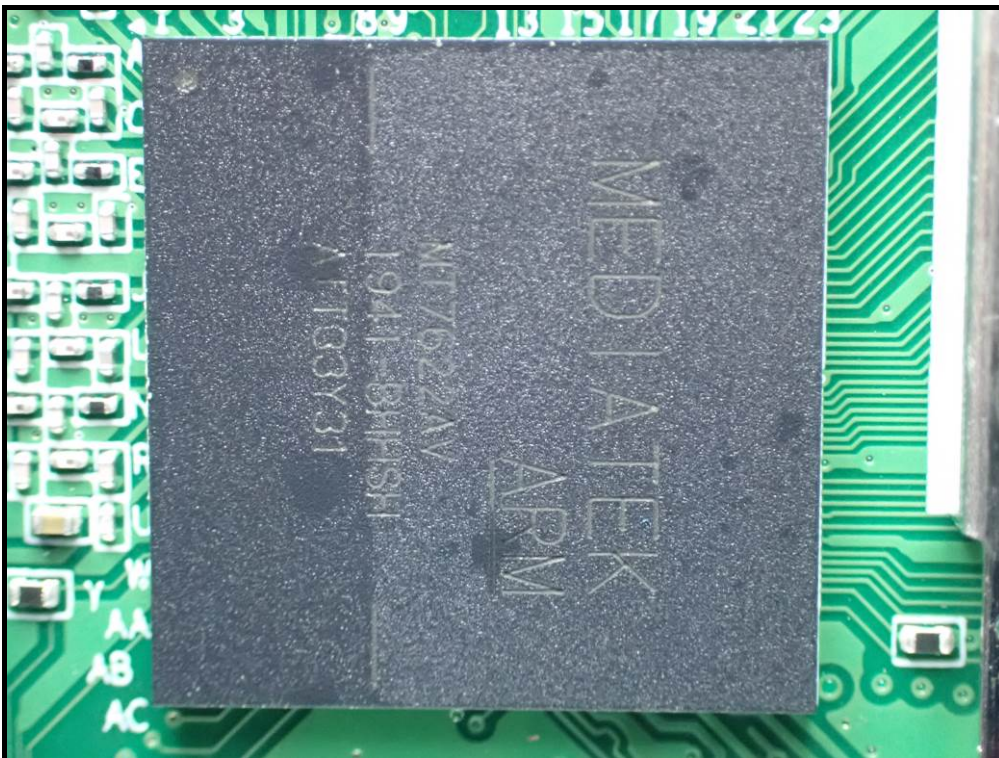

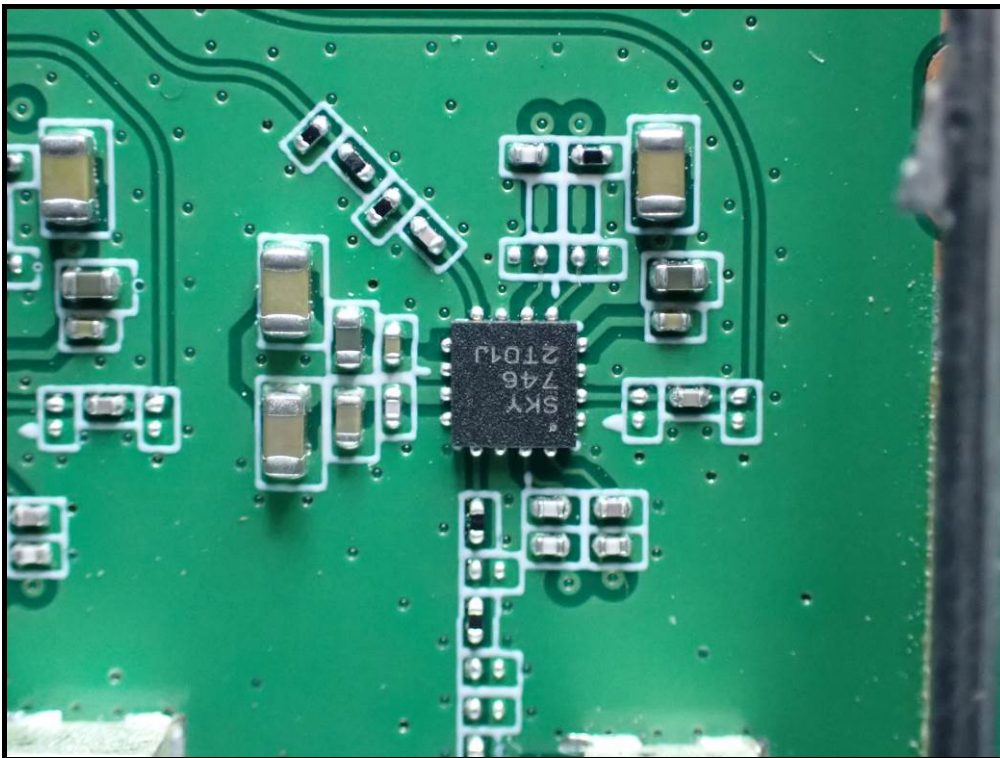
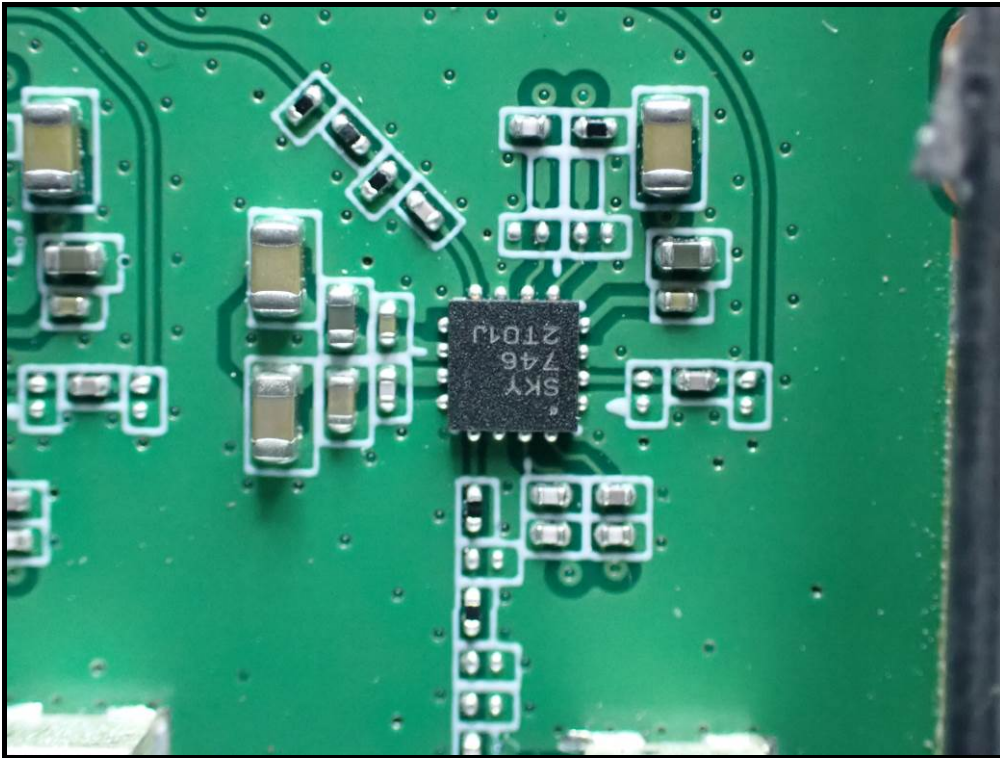

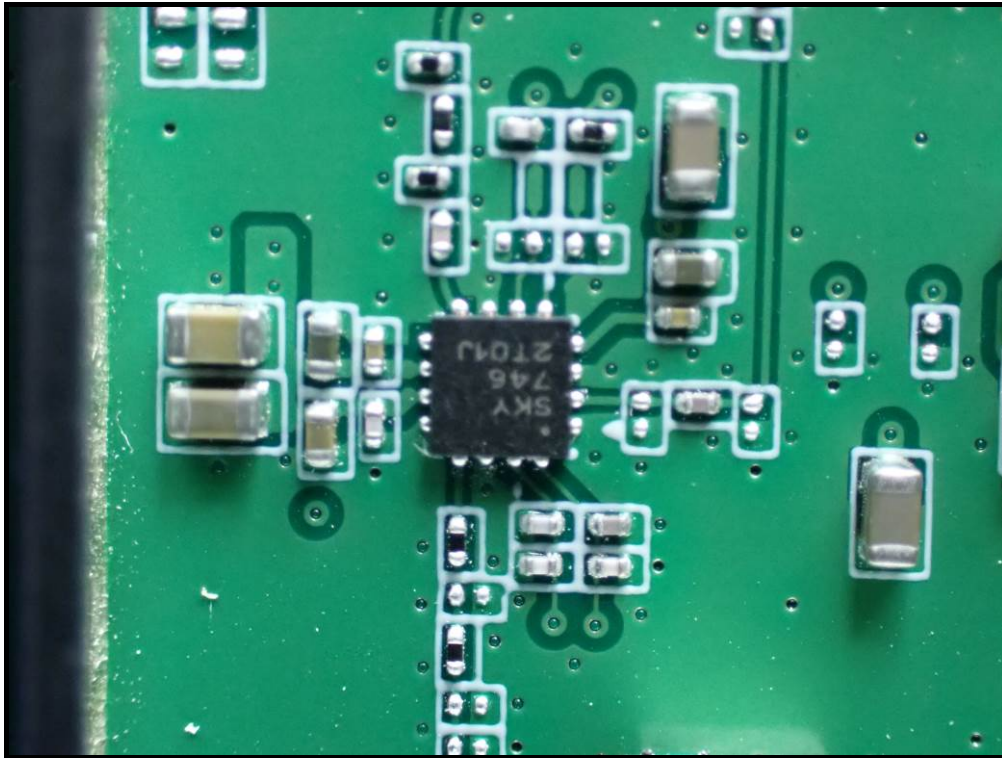

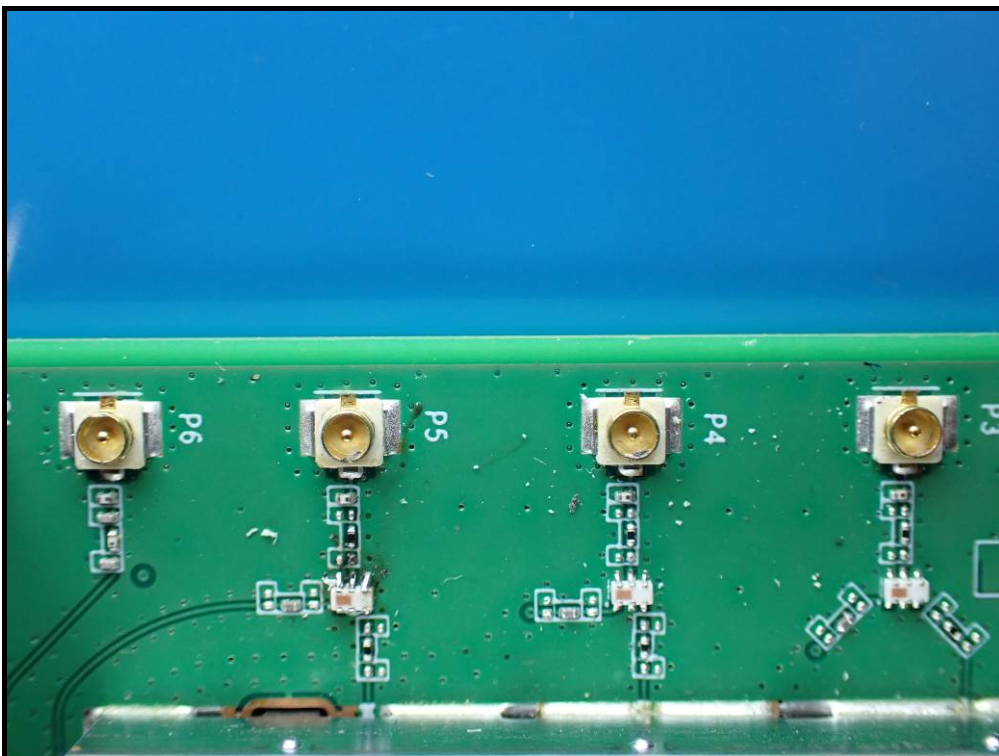
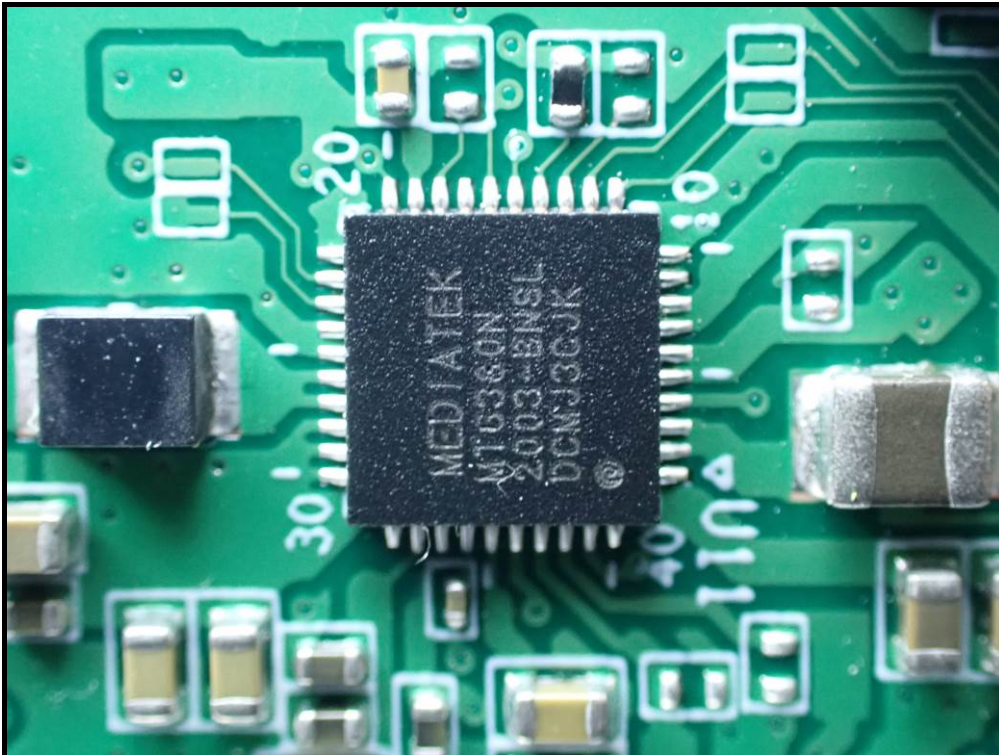

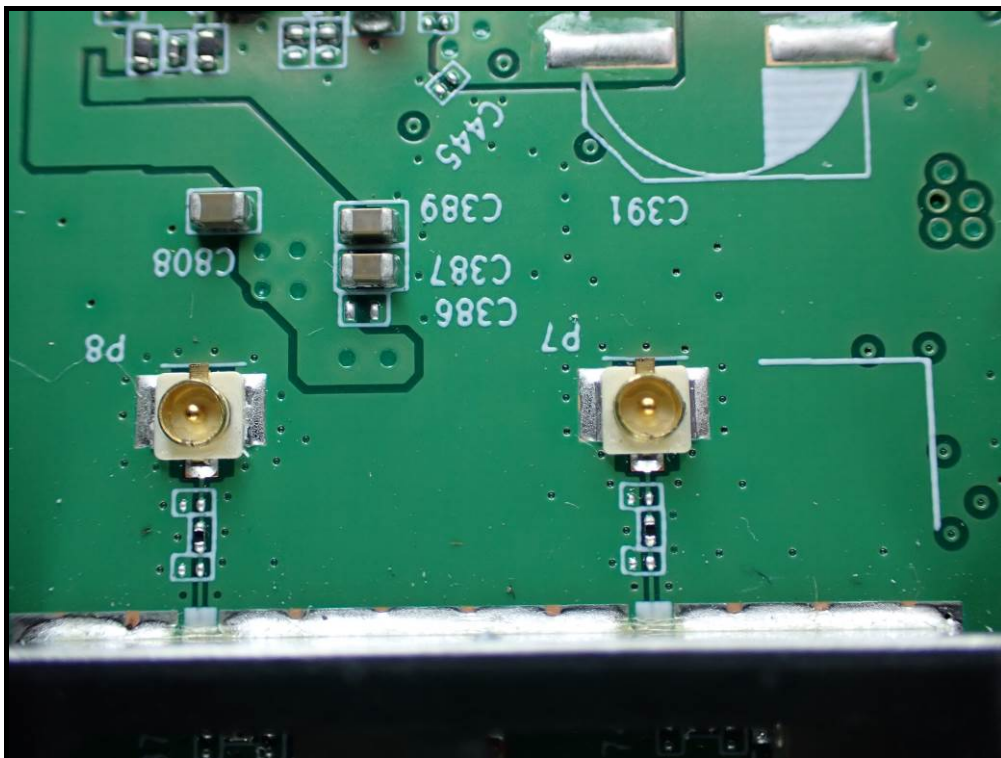
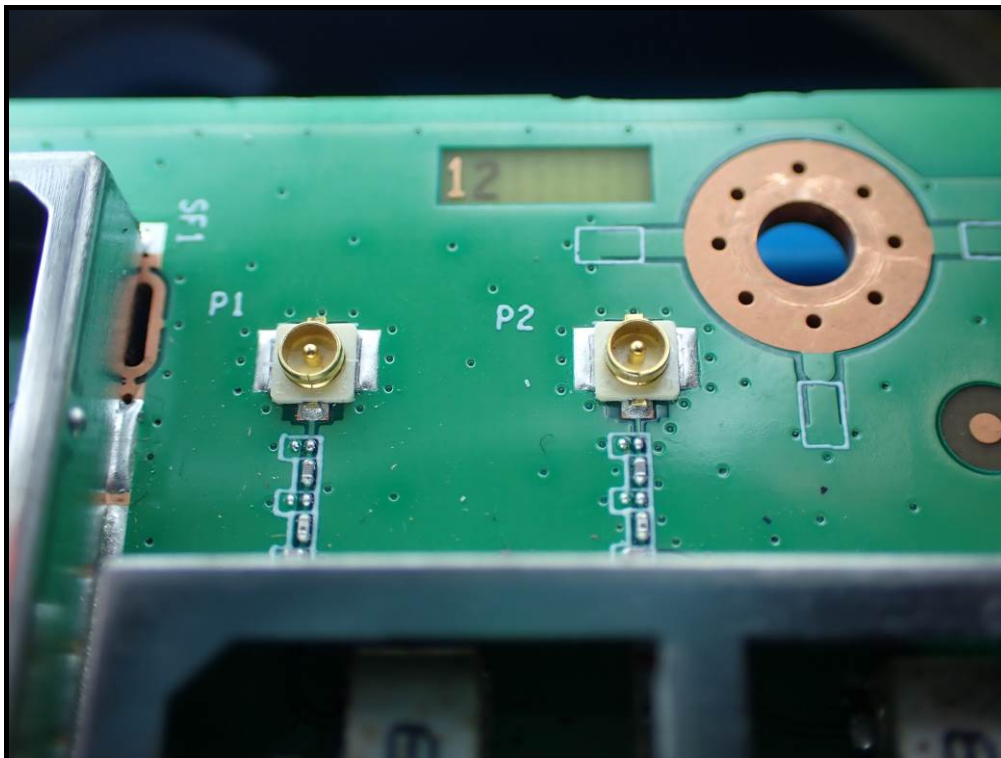

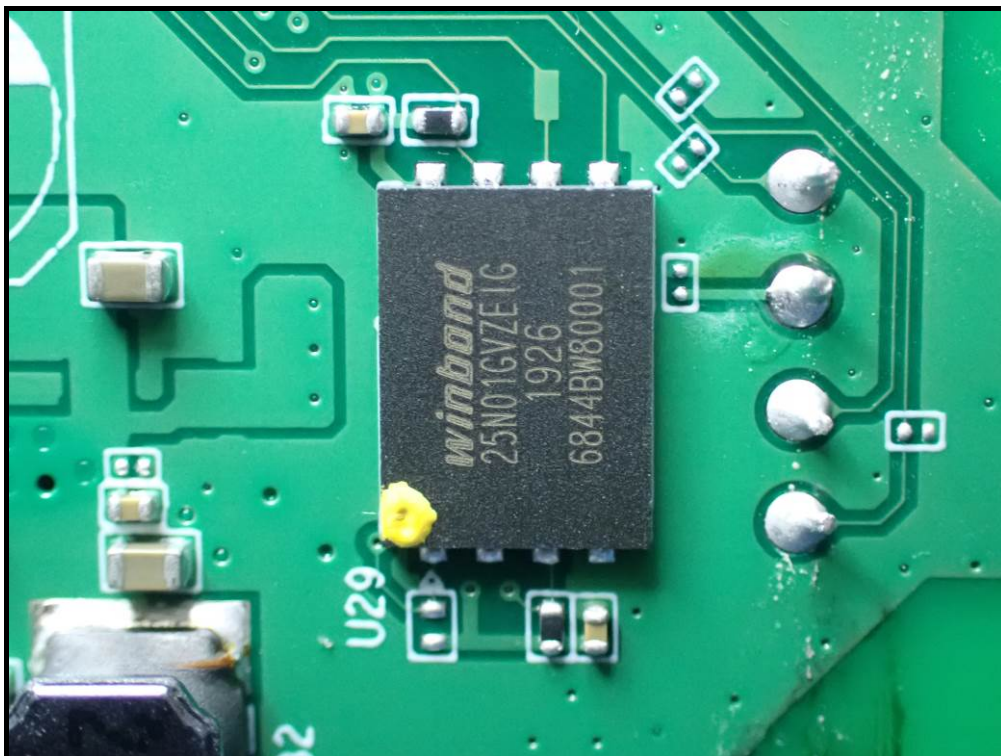
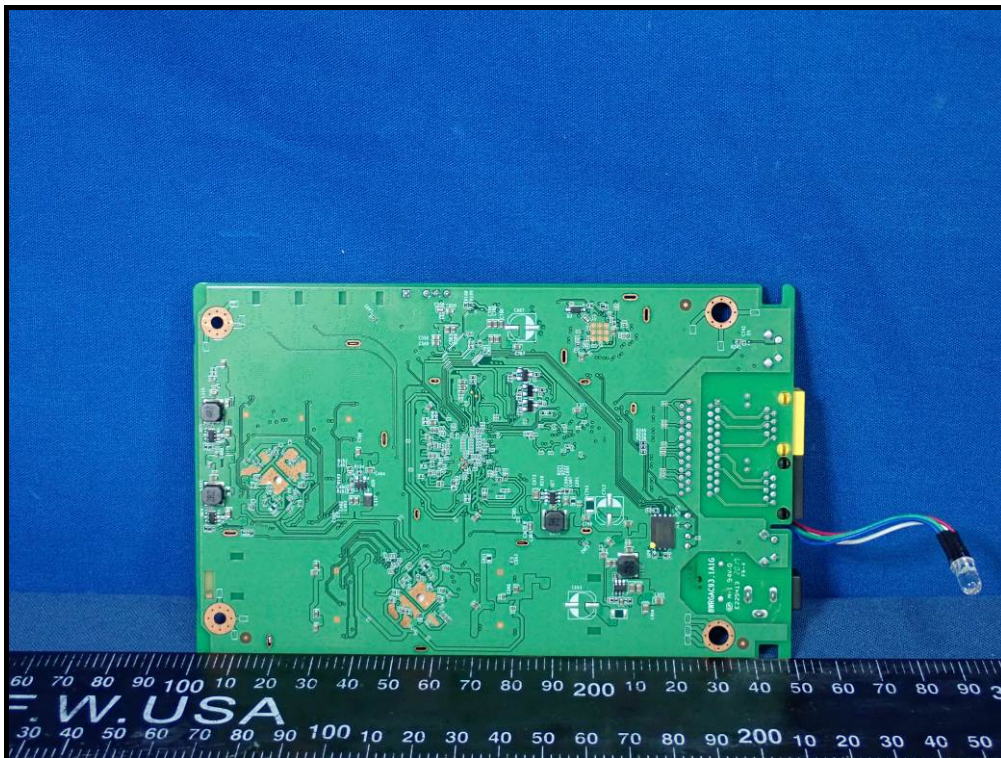

Main Source Antenna



Antenna 1



Antenna 2

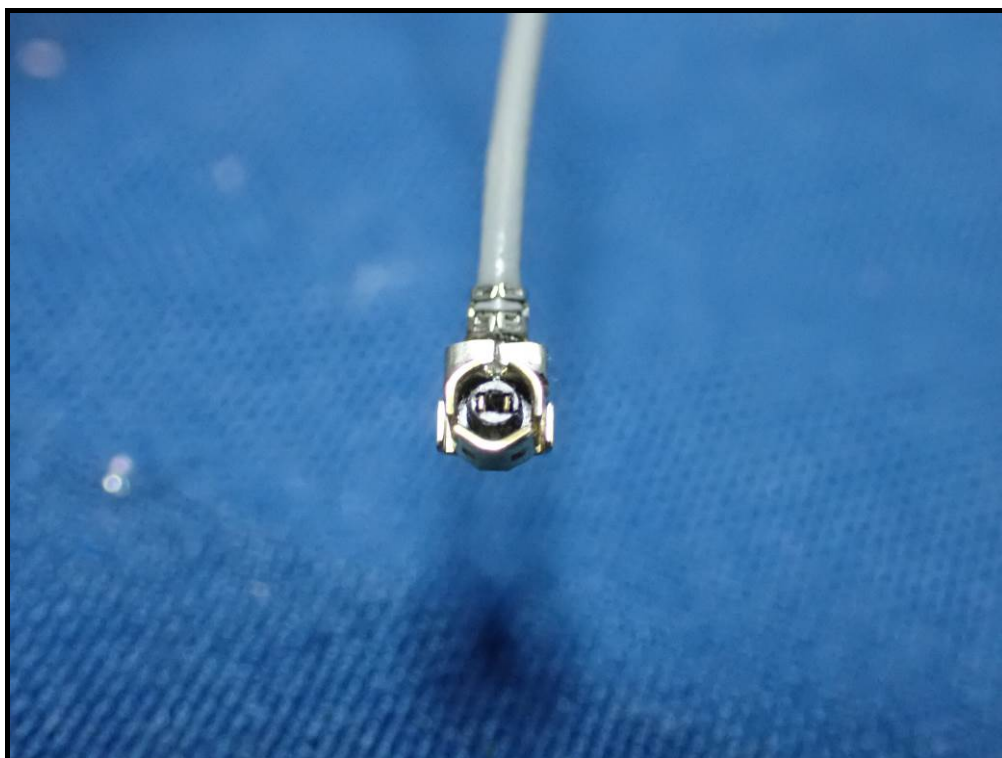

Antenna 3

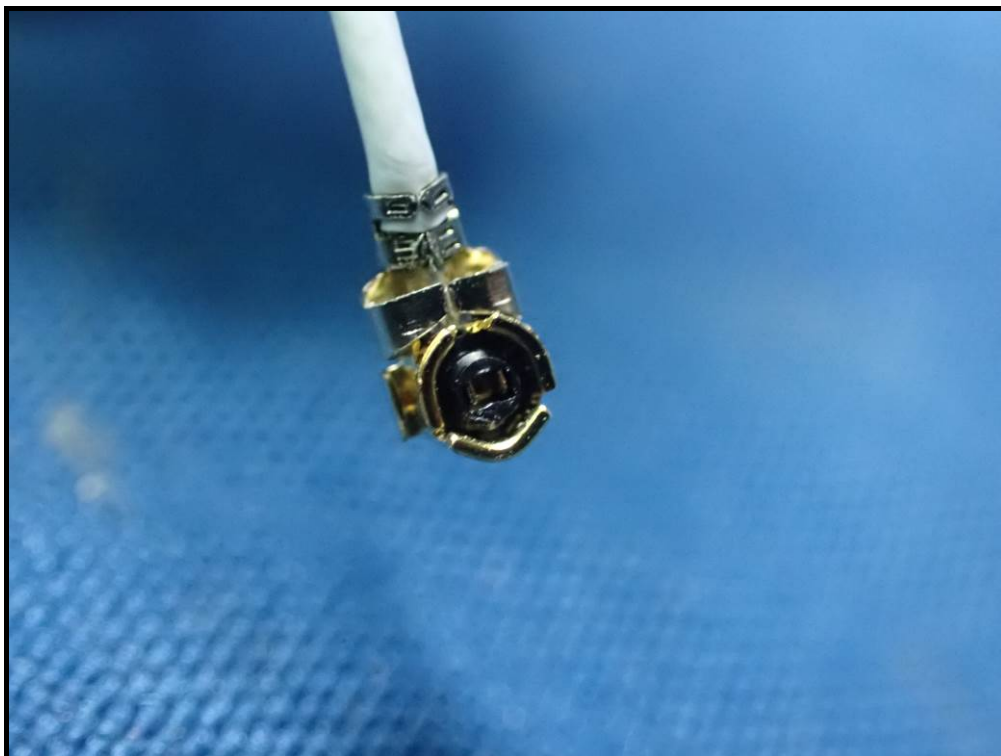
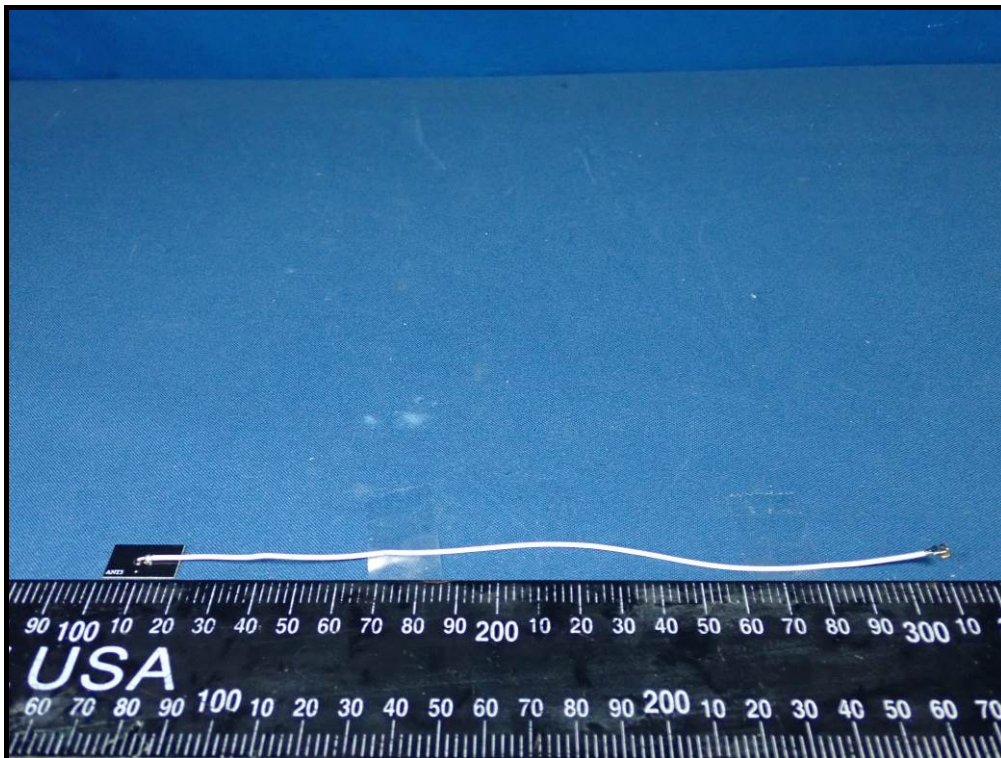

Antenna 4

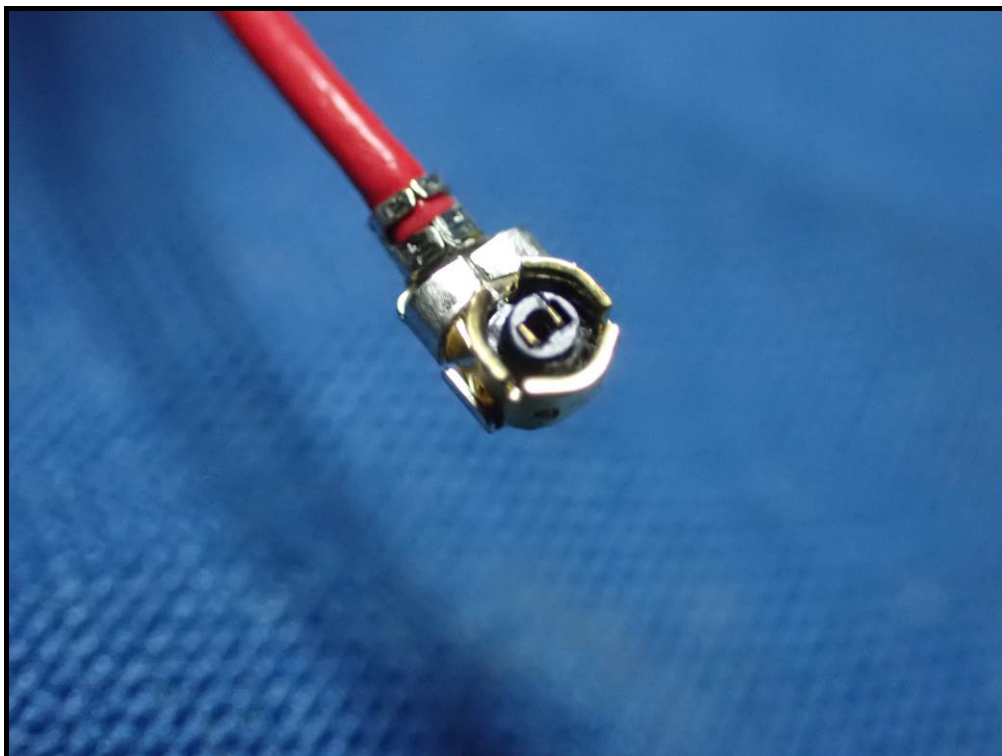
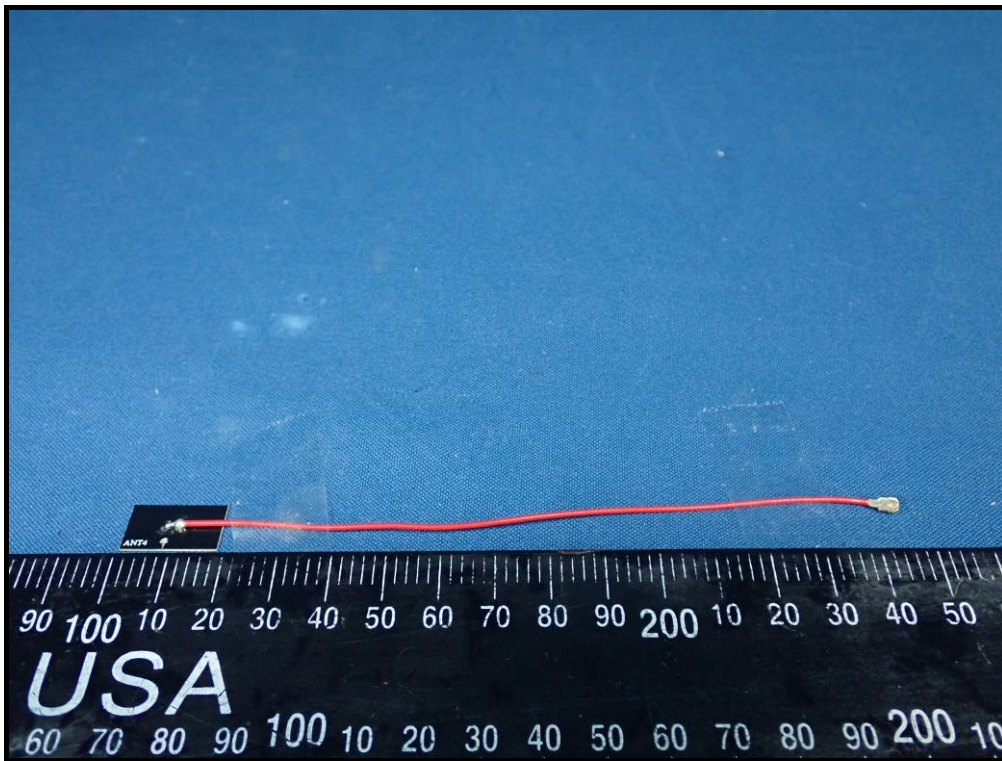

Antenna 5

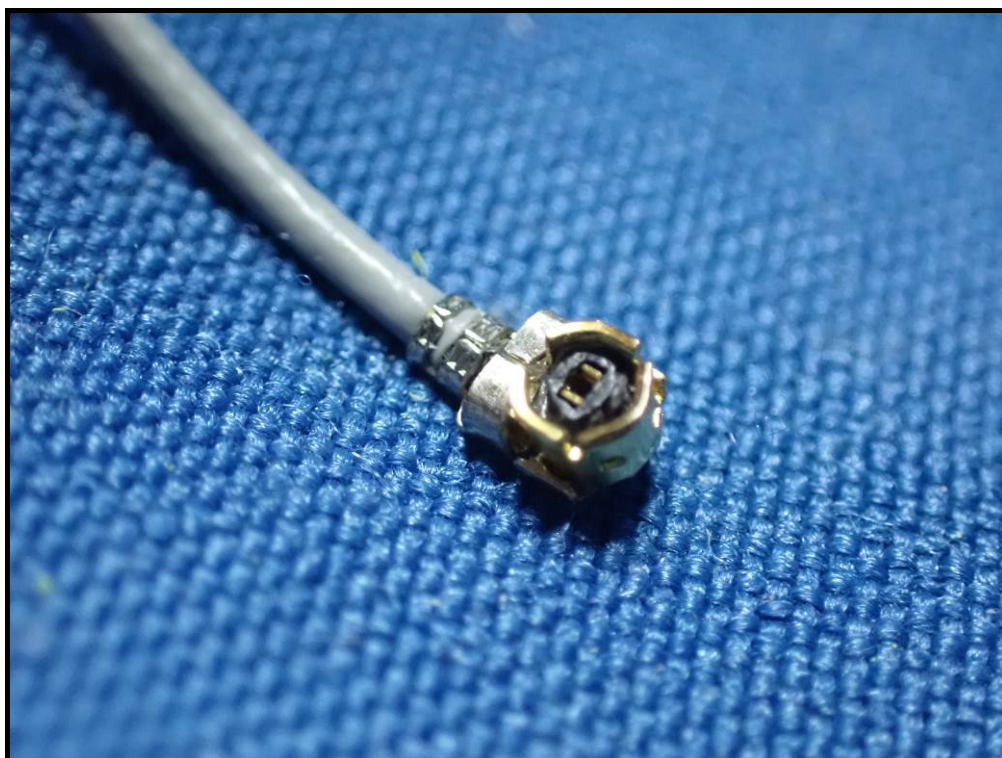
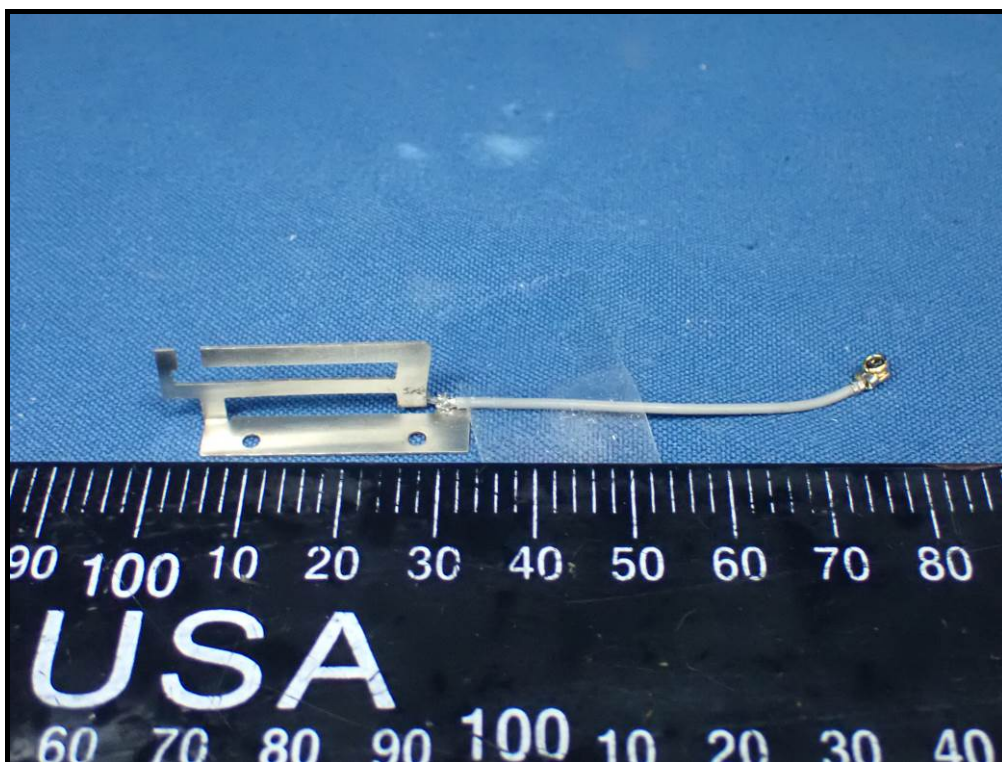

Antenna 6

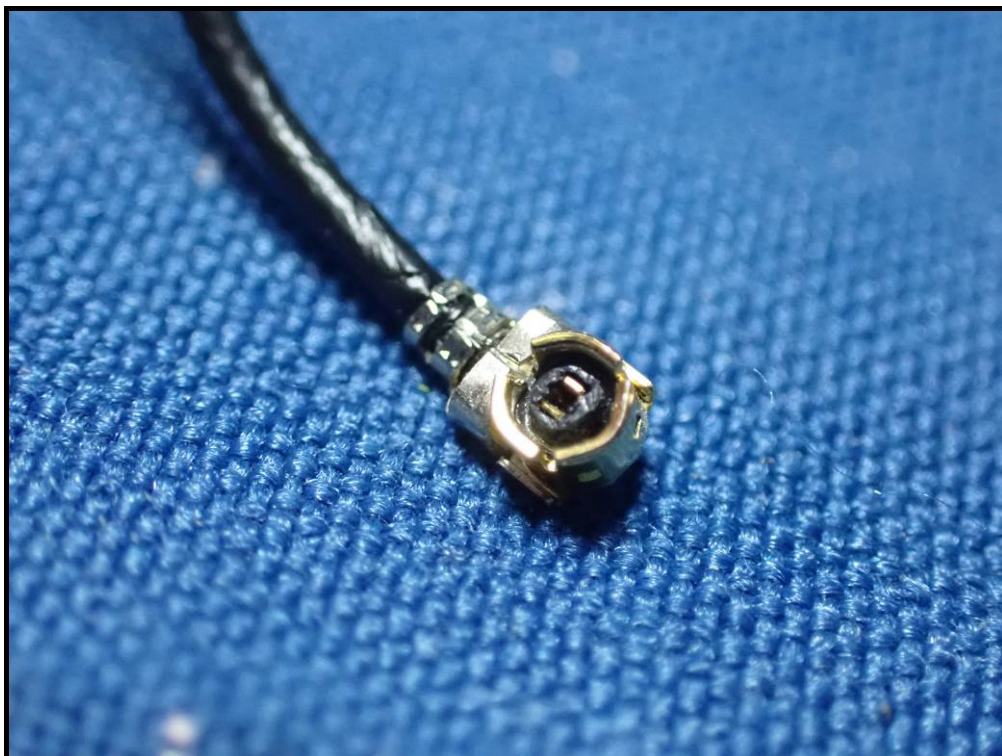
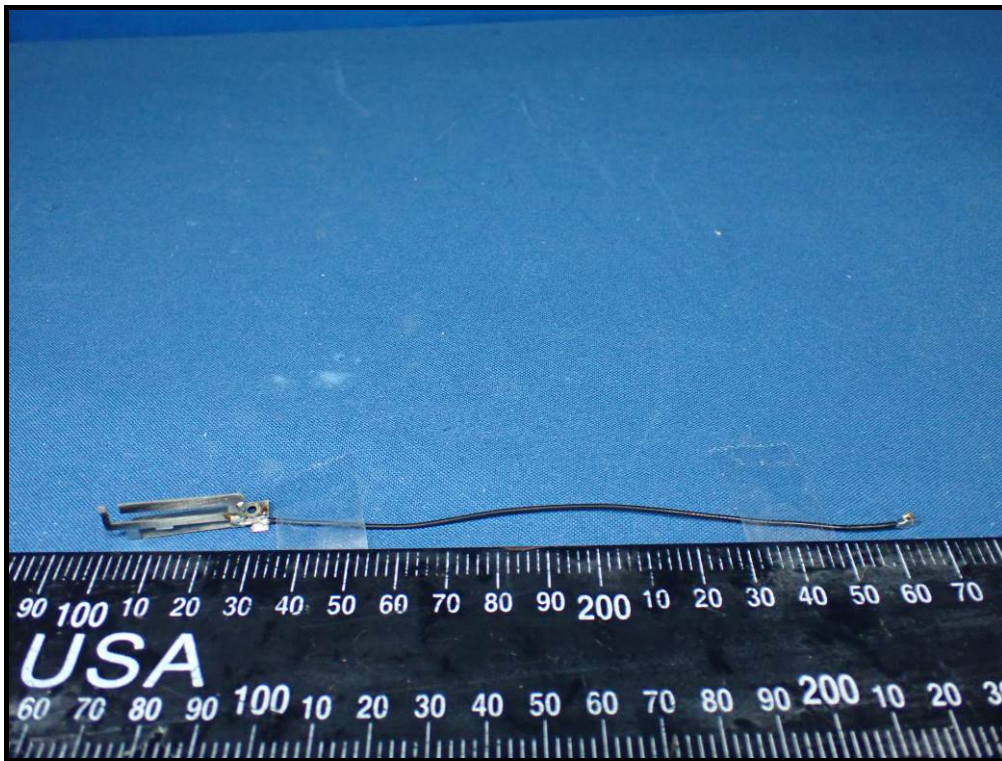

Antenna 7

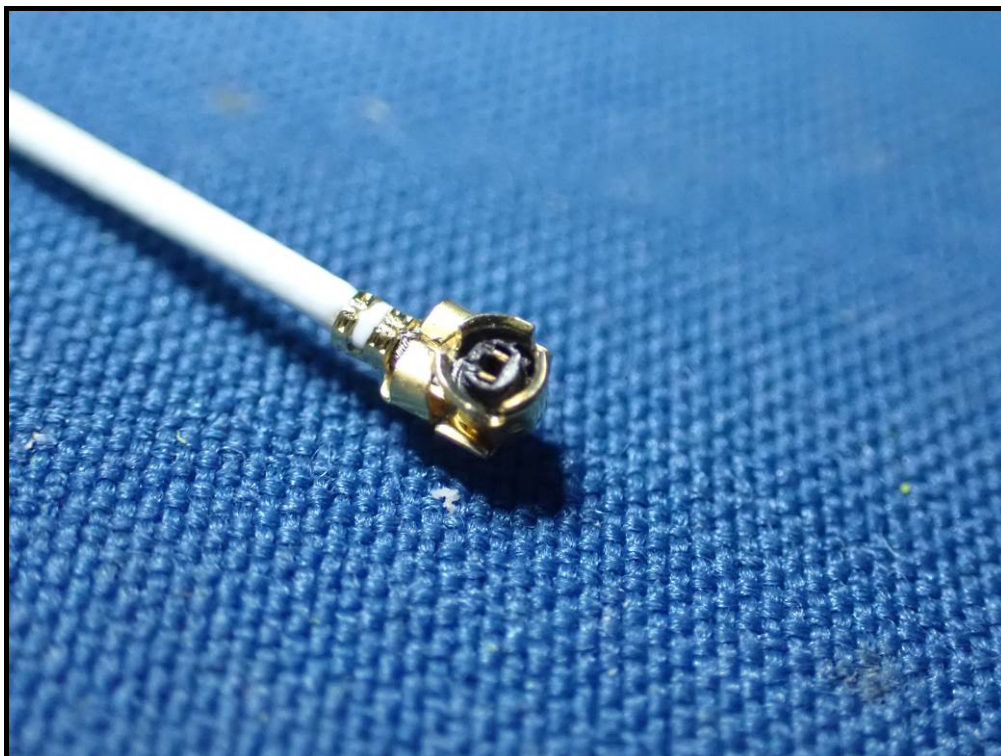

Antenna 8

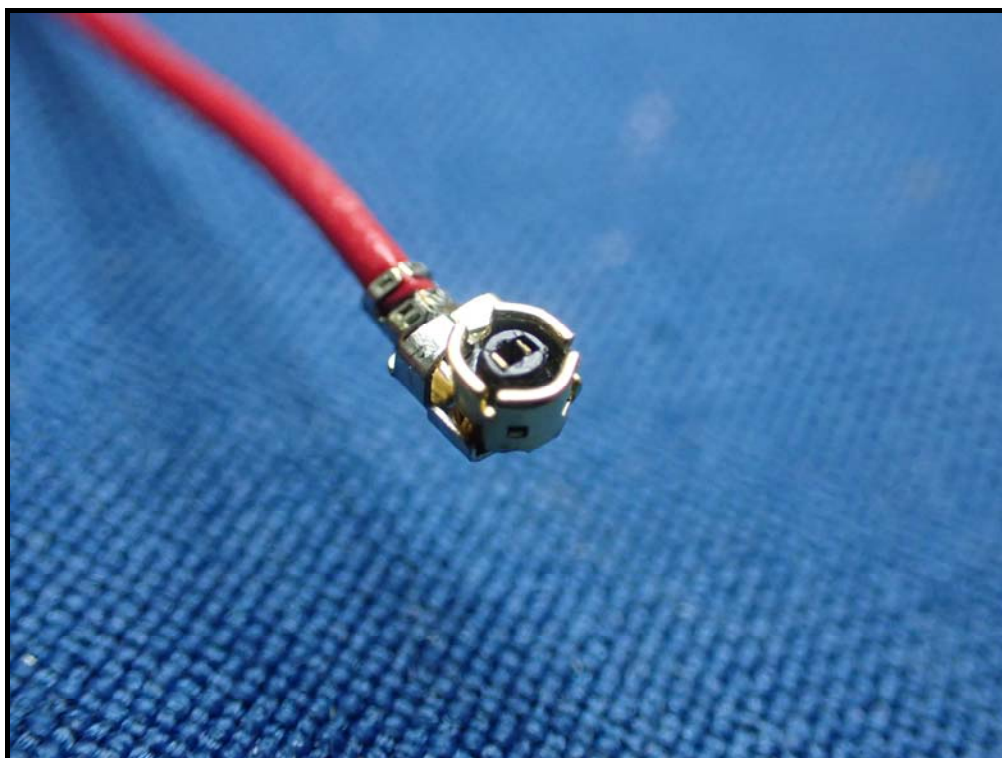
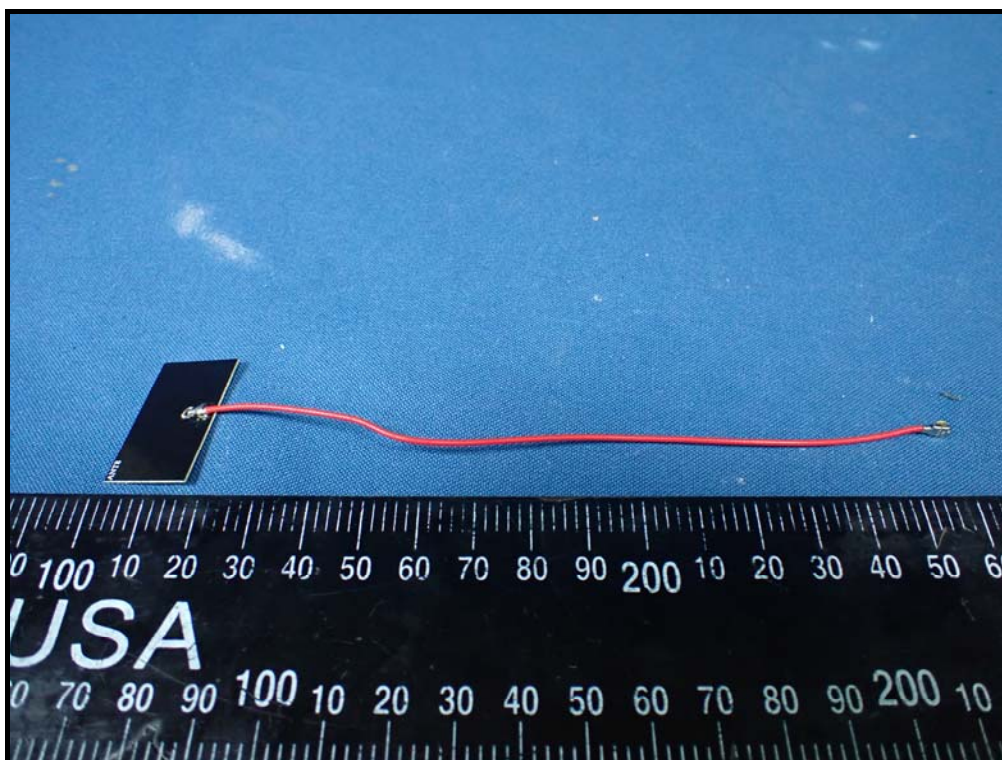

Second Source Antenna



Antenna 1

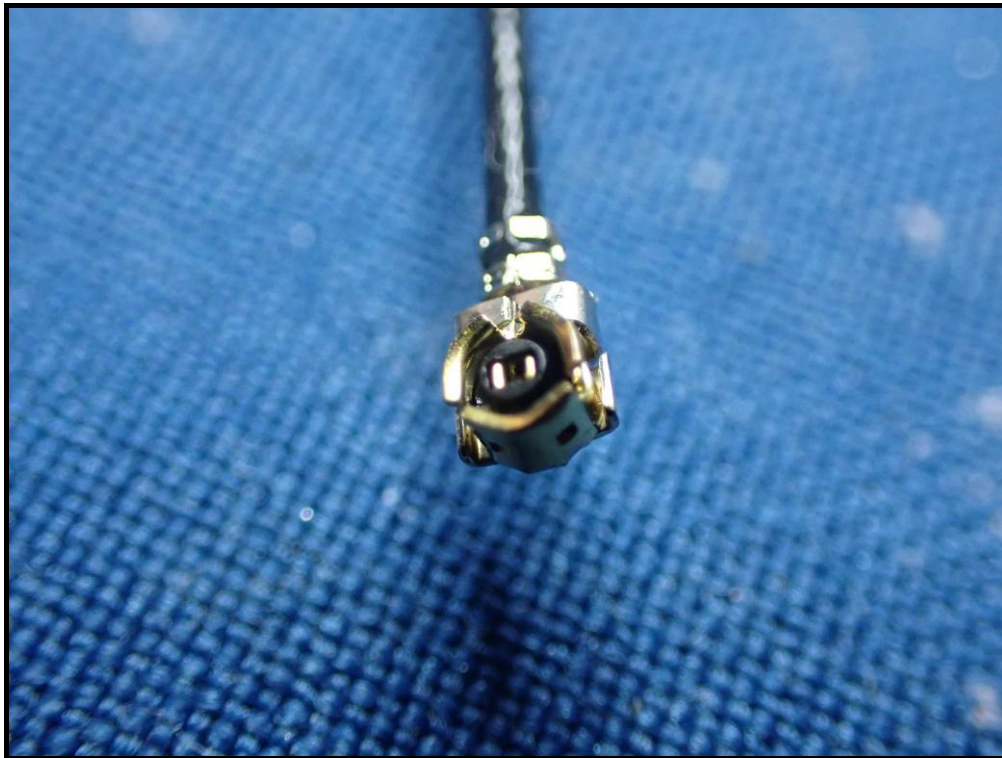
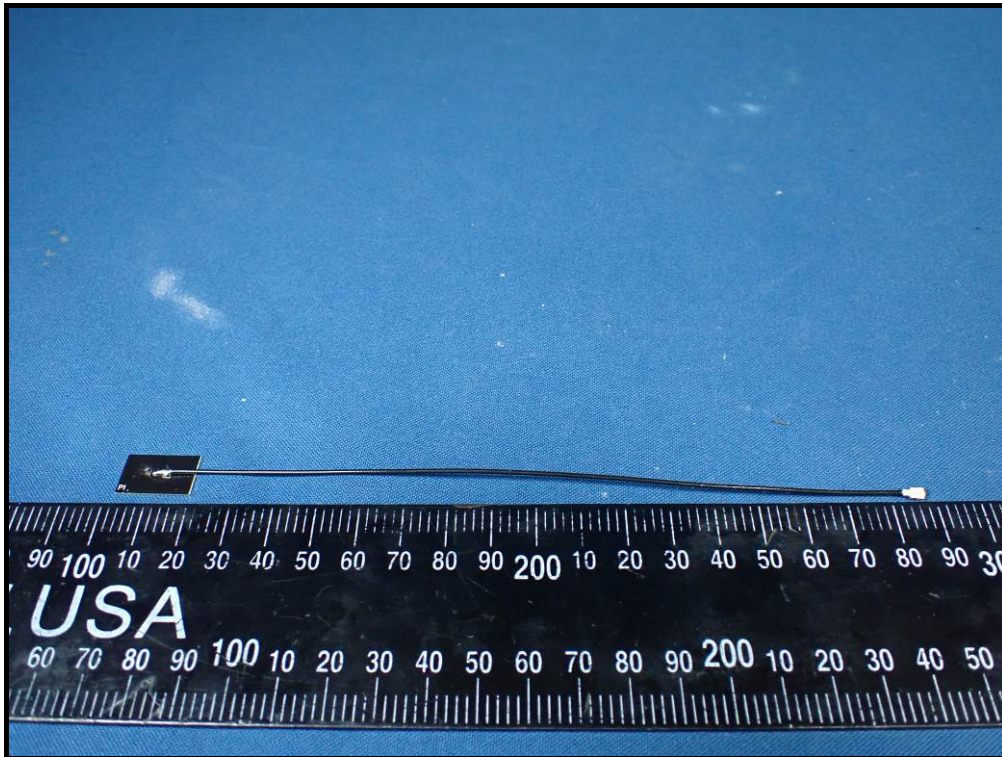

Antenna 2

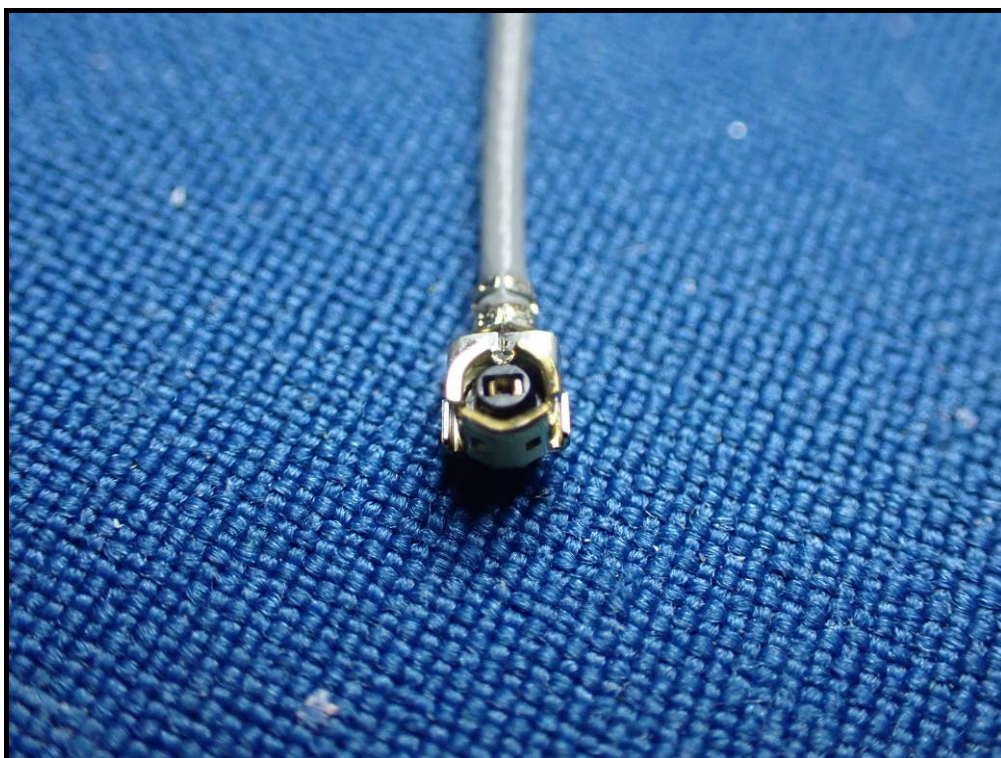
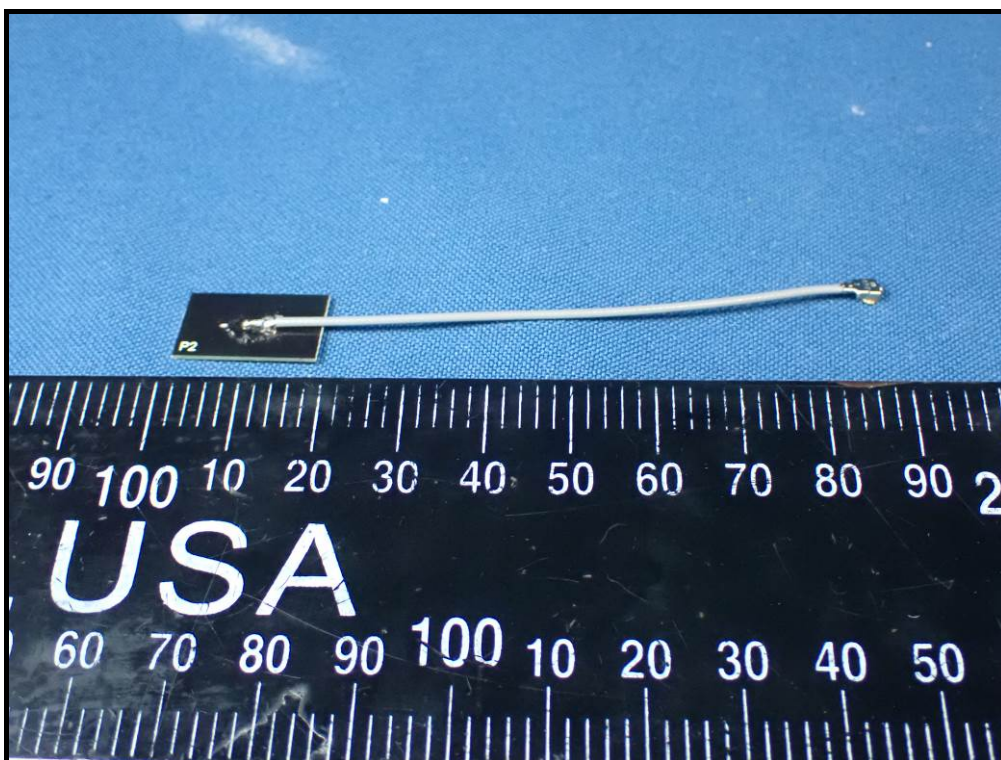

Antenna 3

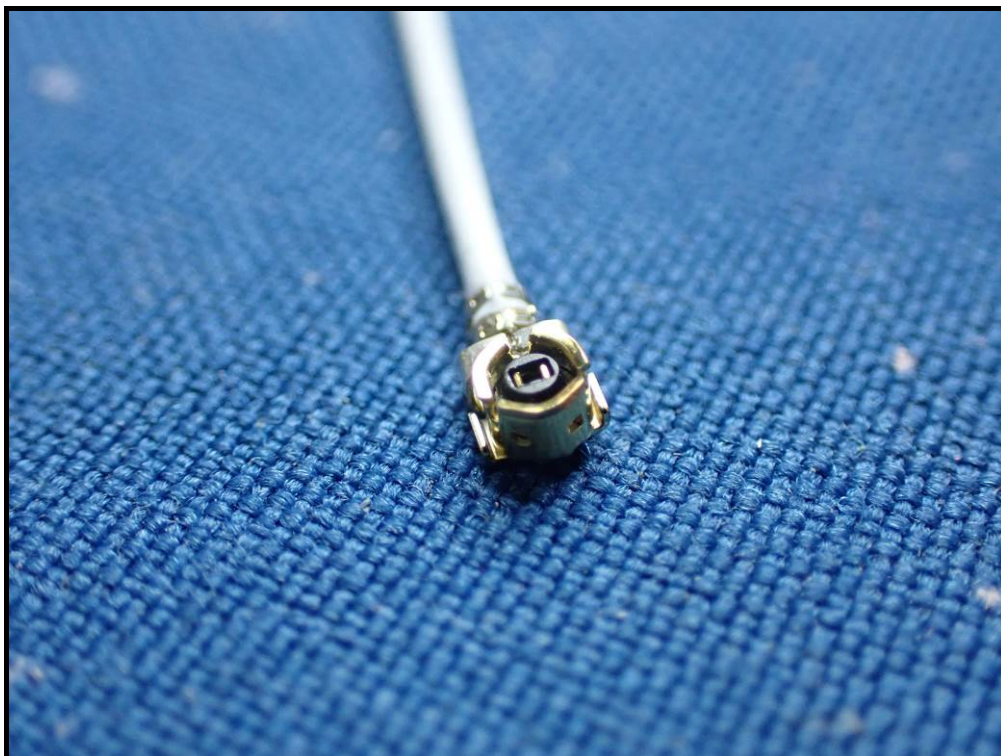
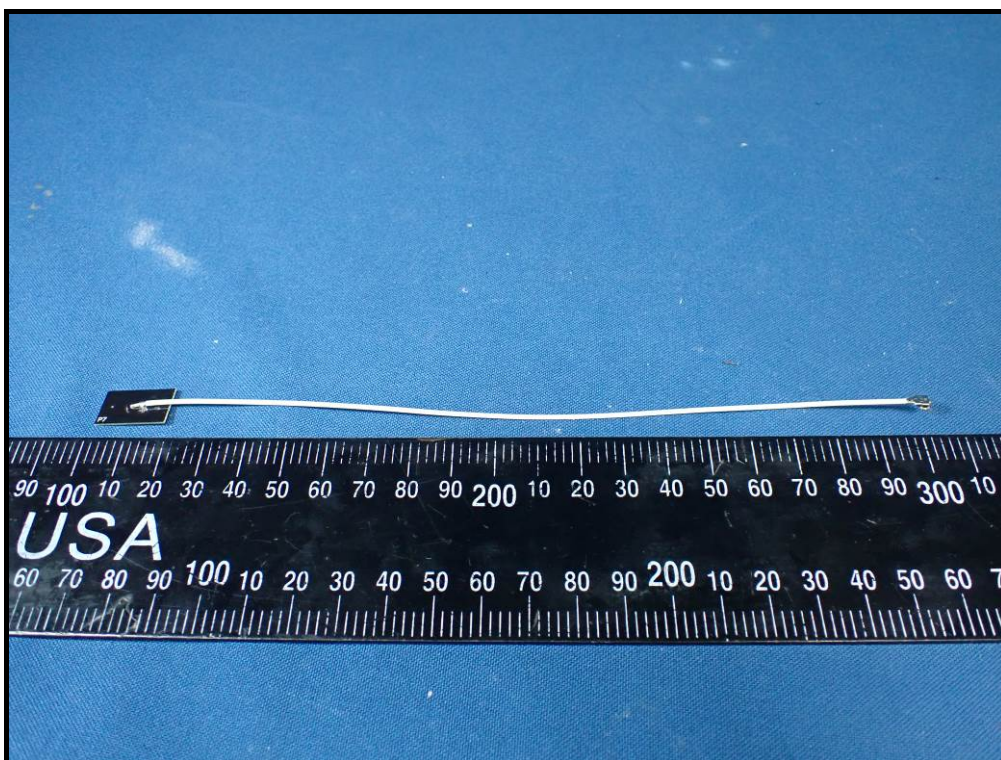

Antenna 4

