

**COMPLIANCE WORLDWIDE INC.
TEST REPORT 220-13R1**

**In Accordance with the Requirements of
FCC PART 15.247, SUBPART C
INDUSTRY CANADA RSS 210, ISSUE 8**

**Low Power License-Exempt Radio Communication Devices
Intentional Radiators**

Issued to

**ARRIS International, Inc.
3871 Lakefield Drive, Suite 300
Suwanee, GA 30024**

for the

**Touchstone Telephony Gateway
Models TG1672G & TG1662G**

**FCC ID: UIDTG1672
IC: 6670A-TG1672**

**Report Issued on July 1, 2013
Revised Report Issued on July 18, 2013**

Tested by

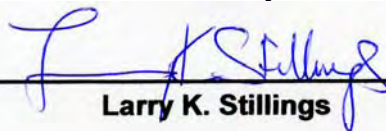
Larry K. Stillings

Reviewed By

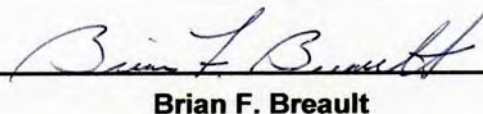
Brian F. Breault

This test report shall not be reproduced, except in full, without written permission from Compliance Worldwide, Inc.

Table of Contents

1. Scope.....	3
2. Product Details	3
2.1 Manufacturer.....	3
2.3 Serial Number.....	3
2.4 Description.....	3
2.5 Power Source	3
2.6 EMC Modifications.....	3
3. Product Configuration.....	3
3.1 Operational Characteristics & Software.....	3
3.2 EUT Hardware	4
3.3 EUT Cables/Transducers	4
3.4 Support Equipment.....	4
3.5 Block Diagram	4
4. Measurements Parameters	5
4.1 Measurement Equipment Used to Perform Test.....	5
4.2 Measurement & Equipment Setup.....	6
4.3 Measurement Procedure	6
4.4 Measurement Uncertainty.....	7
5. Choice of Equipment for Test Suits.....	7
5.1 Choice of Model.....	7
5.2 Presentation.....	7
5.3 Choice of Operating Frequencies.....	7
5.4 Modes of Operation	8
6. Measurement Summary	10
7. Measurement Data	10
7.1 Antenna Requirement.....	10
7.2 Minimum DTS and Occupied Bandwidths.....	11
7.3 99% Bandwidth.....	43
7.4 Maximum Peak (Average) Conducted Output Power	75
7.5 Operation with directional antenna gains greater than 6 dBi	108
7.6 Transmitter Spurious Radiated Emissions	109
7.7 Band Edge Measurements	117
7.8 Power Spectral Density	249
7.9 Conducted Emissions.....	281
7.10 Duty Cycle	284
7.11 Public Exposure to Radio Frequency Energy Levels	315
8. Test Setup Photographs.....	318
9. Test Site Description	326

1. Scope

This test report certifies that the ARRIS TG1672G, as tested, meets the FCC Part 15, Subpart C and Industry Canada RSS 210, Issue 8 requirements. The scope of this test report is limited to the test sample provided by the client, only in as much as that sample represents other production units. If any significant changes are made to the unit, the changes shall be evaluated and a retest may be required. Revision R1: Updated test report per TCB findings letter.

2. Product Details

- 2.1. Manufacturer:** ARRIS International
- 2.2. Model Numbers:** TG1672G, TG1662G (MoCA Chipset is depopulated)
- 2.3. Serial Number:** CCFBSN222200200
- 2.4. Description:** The TG1672G combines two analog voice lines, a 4-port Gigabit Router, and 802.11n wireless access point with two independent, simultaneously operating 802.11n radios into a single device capable of support both home and small office applications. The TG1672G can achieve high bandwidth performance without affecting voice quality.
- 2.5. Power Source:** 120 Volts AC, 60 Hz
- 2.6. EMC Modifications:** None

3. Product Configuration

3.1. Operational Characteristics & Software

Operating Instructions for Test

Connect the ARRIS TG1672G to the computer with an Ethernet cable.

To use QA tool on TG1672G:

Open a command Window.

If the UUT is not ranged and registered, perform the following to stop it from scanning. If not, the UUT will eventually reboot. And the following sequence repeated.

```
telnet to 192.168.100.1,
```

```
Password: arristi
```

```
While the display is scrolling, enter, rf <cr> and then sc 0 <cr>
```

Open a NEW Command window.

```
telnet to 192.168.100.3 and at the hash prompt change directory with the command:
```

```
run: cd /etc/Wireless/CLR260/
```

```
then run: ./ce_host.sh start 24g (2.4 GHz Radio) or  
./ce_host.sh start 5g (5 GHz Radio)
```

to start the wifi. This command may not be necessary depending on the load, but it won't hurt to run it anyway.

```
then run: ./ated -i cei00 -e eth0 (2.4 GHz Radio) or  
./ated -i ce00 -e eth0 (5 GHz Radio)
```

```
turn off 5 GHz radio: iwpriv cei00 set RadioOn=0 (2.4 GHz Radio) or
```

```
turn off 2.4 GHz radio: iwpriv ce00 set RadioOn=0 (5 GHz Radio)
```

This will allow QA tool to communicate via the Ethernet port.

3. Product Configuration

3.1. Operational Characteristics & Software (continued)

Operating Instructions for Test

Start the QA tool and select the appropriate Ethernet card and select OK.

Note: You do not have to check the iNICMode box. BufferMode or EEPROM is checked by default.

Note: This sequence of commands can also be entered via the serial connector J4.

3.2. EUT Hardware

Manufacturer	Model/Part # / Options	Serial Number	Input Voltage	Frq (Hz)	Description/Function
ARRIS	TG1672G	CCFBSN222200200	120	60	Telephony Gateway

3.3. EUT Cables/Transducers

Cable Type	Length	Shield	From	To
Ethernet x 4 Ports	2 M	No	EUT	1 – Vostro Laptop, 3 Unterminated
Telephone Cables x 2	2 M	No	EUT	1 – Telephone, 1 Unterminated
USB Cable x 2	2 M	Yes	EUT	1 – USB Flash Drive, 1 Unterminated
Coaxial Cable	2 M	Yes	EUT	75 ohm Termination
Power Cable	2 M + 1M	No	EUT	12 VDC Power Supply

3.4. Support Equipment

Manufacturer	Model/Part #	Input Voltage	Input Freq	Description/Function
Dell	Vostro	120V	60 Hz	Ethernet Cable Config / Control
Emerson	EM-2115RW	N/A	N/A	Telephone
Verbatim	4 GB	N/A	N/A	USB Flash Drive

3.5. Block Diagram

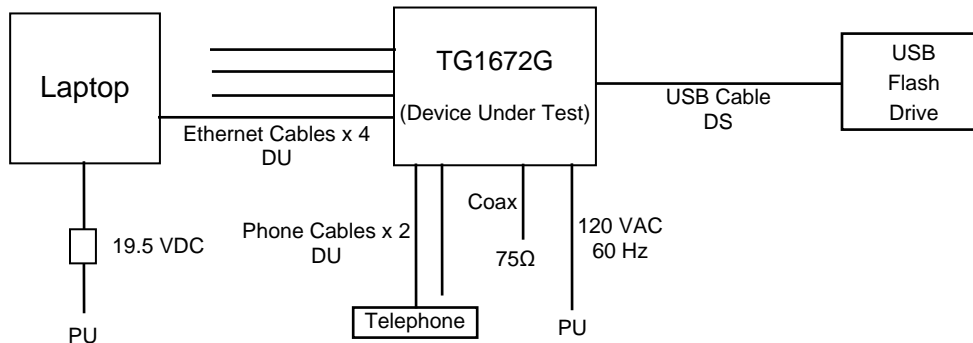

4. Measurements Parameters

4.1. Measurement Equipment Used to Perform Tests

Device	Manufacturer	Model No.	Serial No.	Cal Due
Spectrum Analyzer	Rohde & Schwarz	FSV40	100899	6/6/2015
EMI Receiver	Hewlett Packard	8546A	3650A00360	6/13/2014
Microwave Preamp	Hewlett Packard	83050A	3331A00404	6/28/2015
Loop Antenna	EMCO	6512	9309-1139	8/28/2014
Bilog Antenna	Com-Power	AC-220	25509	8/20/2013
Horn Antenna	ETS-Lindgren	3117	00143292	1/14/2015
Horn Antenna	Com-Power	AH-840	03075	8/27/2014
RF Signal Generator	Rohde & Schwarz	SMB 100A	175352	5/14/2014
2.4 GHz Notch Filter	Micro-Tronics	BRM50702	14	6/6/2014
5 GHz Notch Filter	Micro-Tronics	BRM50716-03	001	5/12/2014
LISN 50 Ω 50 μ H, 9 kHz to 30 MHz	EMCO	3825/2	9109-1860	6/5/2014
RF Power Meter	Boonton	4220A	323203AC	6/13/2014
Power Sensor	Boonton	51081	29412	6/13/2014
Compact Digital Barometer	Control Company	4195	ID236	2/25/2015

4. Measurements Parameters

4.2. Measurement & Equipment Setup

Test Dates:	May24 th to June 27 th , 2013, July 18 th , 2013
Test Engineers:	Cody Merry, Brian Breault
Normal Site Temperature (15 - 35°C):	21.7
Relative Humidity (20 -75%RH):	32%
Frequency Range:	150 kHz to 40 GHz
Measurement Distance:	3 Meters
EMI Receiver IF Bandwidth:	9 kHz – 150 kHz to 30 MHz 120 kHz– 30 MHz to 1 GHz 1 MHz – Above 1 GHz
EMI Receiver Avg Bandwidth:	30 kHz – 150 kHz to 30 MHz 300 kHz– 30 MHz to 1 GHz 3 MHz – Above 1 GHz
Detector Function:	Peak, QP - 150 kHz to 1 GHz Peak, Avg- Above 1 GHz Unless otherwise specified.

4.3. Measurement Procedures

Test measurements were made in accordance FCC Part 15.247, IC RSS-210 Annex II: Operation within the bands 902 - 928 MHz, 2400 - 2483.5 MHz, 5725 - 5850 MHz, and 24.0 - 24.25 GHz.

The test procedures detailed in the Federal Communications Commission Office of Engineering and Technology (FCC OET) Publication Number KDB 558074 D01 DTS Measurement Guidance v03r01, Guidance for Performing Compliance Measurements on Digital Transmission Systems (DTS) Operating Under §15.247, dated 4/9/2013 and FCC OET Publication Number KDB 662911 D01 Multiple Transmitter Output v02, Emissions Testing of Transmitters with Multiple Outputs in the Same Band, dated 5/28/2013 were used to generate the data in this test report.

The test methods used to generate the data in this test report is in accordance with ANSI C63.10:2009, American National Standard for Testing Unlicensed Wireless Devices.

4. Measurements Parameters

4.4. Measurement Uncertainty

The following uncertainties are expressed for an expansion/coverage factor of K=2.

RF Frequency	$\pm 1 \times 10^{-8}$
Radiated Emission of Transmitter	± 4.55 dB
Radiated Emission of Receiver	± 4.55 dB
Temperature	$\pm 0.91^{\circ}$ C
Humidity	$\pm 5\%$

5. Choice of Equipment for Test Suits

5.1 Choice of Model

This test report is based on the test samples supplied by the manufacturer and are reported by the manufacturer to be equivalent to the production units.

5.2 Presentation

This test sample was tested complete with all required ancillary equipment. Refer to Section 3 of this report for product equipment configuration.

5.3 Choice of Operating Frequencies

The ARRIS TG1672G, as tested, operates on 11 channels, from channels 1 to 11 in the 2.4 GHz band and 7 Channels 149 to 165 in the 5.8 GHz band.

In accordance with ANSI C63.10-2009, section 5.6, the choice of operating frequencies selected for the testing detailed in this report are outlined in the following tables:

Channel	Frequency (MHz)	802.11b,g & HT20	HT40
1	2412	Tested	Not Tested
2	2417	Not Tested	Not Tested
3	2422	Not Tested	Tested
4	2427	Not Tested	Not Tested
5	2432	Not Tested	Not Tested
6	2437	Tested	Tested
7	2442	Not Tested	Not Tested
8	2447	Not Tested	Not Tested
9	2452	Not Tested	Tested
10	2457	Not Tested	Not Tested
11	2462	Tested	Not Tested

5. Choice of Equipment for Test Suits (continued)

5.3 Choice of Operating Frequencies (continued)

Channel	Frequency (MHz)	802.11a & HT20	HT40
149	5745	Tested	Not Tested
151	5755	Not Tested	Tested
153	5765	Not Tested	Not Tested
157	5785	Tested	Not Tested
159	5795	Not Tested	Tested
161	5805	Not Tested	Not Tested
165	5825	Tested	Not Tested

5.4 Modes of Operation

Upon receipt of the EUT, each of the modulation types and data rates for the modes supported by the device are evaluated. It was determined that the ARRIS TG1672G produced the worst case emissions in 802.11b mode using 1 MB Long PN9 data, 802.11g mode using 6 MB PN9 data, 802.11a mode using 6 MB PN9 data, 802.11n HT20 mode using 6.5 MB MCS0 data and in 802.11n HT40 mode using 13.5 MB MCS0 data. Refer to the following tables for the individual channel settings used for this test.

2.4 GHz Test Configurations

Frequency (MHz)	Modulation	Channel	Data Rate	Power Level Settings
				TX0/TX1/TX2
2412	CCK	1	1M	0B / 0F / 0C
2437	CCK	6	1M	0E / 11 / 0E
2462	CCK	11	1M	0F / 12 / 10
2412	OFDM	1	6M	0F / 0F / 0C
2437	OFDM	6	6M	12 / 11 / 0E
2462	OFDM	11	6M	13 / 12 / 10
2412	HT20	1	MCS0	0F / 0F / 0C
2437	HT20	6	MCS0	12 / 11 / 0E
2462	HT20	11	MCS0	13 / 12 / 10
2422	HT40	3	6.5M	10 / 10 / 0D
2437	HT40	6	6.5M	12 / 11 / 0E
2452	HT40	9	6.5M	12 / 12 / 10

5. Choice of Equipment for Test Suits (continued)

5.4 Modes of Operation (continued)

5 GHz Test Configurations

Frequency (MHz)	Modulation	Channel	Data Rate	Power Level Settings
				TX0/TX1/TX2
5745	OFDM	149	6M	14/17/13
5785	OFDM	157	6M	13/18/12
5825	OFDM	165	6M	13/1A/12
5745	HT20	149	6.5M	14/17/13
5785	HT20	157	6.5M	13/18/12
5825	HT20	165	6.5M	13/1A/12
5755	HT40	151	MCS0	14/17/13
5795	HT40	159	MCS0	13/19/12

6. Measurement Summary

Test Requirement	FCC Rule Reference	IC Rule Reference	Test Report Section	Result
Antenna Requirement	15.203	RSS-GEN 7.1.2	7.1	Compliant
Minimum DTS and Occupied Bandwidths	15.247 (a) (2)	RSS-210 A8.2	7.2	Compliant
99% Power Bandwidth	N/A	RSS-GEN 4.6.1	7.3	Compliant
Maximum Peak (Average) Conducted Output Power	15.247 (b) (1)	RSS-210 A8.4 (4)	7.4	Compliant
Operation with directional antenna gains greater than 6 dBi	15.247 (b) (4)	RSS-GEN 7.1.2	7.5	Compliant
Spurious Radiated Emissions	15.247 (d)	RSS-GEN 4.9	7.6	Compliant
Spurious Radiated Emissions (> GHz) - Harmonic Measurements	15.247 (d)	RSS-210 A8.9	7.6	Compliant
Lower and Upper Band Edges	15.247 (d)	RSS-210 A8.5	7.7	Compliant
Power Spectral Density	15.247(e)		7.8	Compliant
Conducted Emissions	15.207	RSS-GEN	7.9	Compliant
Public Exposure to Radio Frequency Energy Levels	1.1307 (b) (1)	RSS-GEN 5.5 RSS-102	7.10	Compliant

7. Measurement Data

7.1. Antenna Requirement (15.203, RSS GEN 7.1.2)

Requirement: An intentional radiator shall be designed to ensure that no antenna other than that furnished by the responsible party shall be used with the device. The use of a permanently attached antenna or of an antenna that uses a unique coupling to the intentional radiator shall be considered sufficient to comply with the provisions of this Section.

Conclusion: The ARRIS TG1672G uses printed circuit board etched antennas. In addition, UFL connectors are provided for RF conducted measurements. The connectors are not user accessible.”

7. Measurement Data

7.2. Minimum DTS and Occupied Bandwidths

Requirement: (15.247 (a) (2), RSS 210 A8.2(a))

Systems using digital modulation techniques may operate in the 902 - 928 MHz, 2400 - 2483.5 MHz, and 5725 - 5850 MHz bands. The minimum 6 dB bandwidth shall be at least 500 kHz.

Procedure: This test was performed in accordance with the procedure detailed in FCC OET publication number 558074, Section 8.0, DTS (6 dB) Channel Bandwidth.

Conclusion: The device under test meets the minimum 500 kHz 6 dB bandwidth requirement.

Measurement Results for 2400 to 2483.5 MHz Band

802.11b Mode Channel	Frequency (MHz)	-6 dB Bandwidth (kHz)			Minimum -6 dB Bandwidth (kHz)	Result
		J2400	J2401	J2402		
Low	2412	12375	12135	12435	>500	Compliant
Middle	2437	12390	12375	12420	>500	Compliant
High	2462	12375	12360	12675	>500	Compliant

802.11g Mode Channel	Frequency (MHz)	-6 dB Bandwidth (kHz)			Minimum -6 dB Bandwidth (kHz)	Result
		J2400	J2401	J2402		
Low	2412	16395	16395	16380	>500	Compliant
Middle	2437	16395	16395	16380	>500	Compliant
High	2462	16395	16380	16395	>500	Compliant

HT20 Mode Channel	Frequency (MHz)	-6 dB Bandwidth (kHz)			Minimum -6 dB Bandwidth (kHz)	Result
		J2400	J2401	J2402		
Low	2412	17310	17100	17565	>500	Compliant
Middle	2437	17535	17505	17505	>500	Compliant
High	2462	17295	17310	17295	>500	Compliant

HT40 Mode Channel	Frequency (MHz)	-6 dB Bandwidth (kHz)			Minimum -6 dB Bandwidth (kHz)	Result
		J2400	J2401	J2402		
Low	2422	35385	35745	35775	>500	Compliant
Middle	2437	35595	35625	35745	>500	Compliant
High	2452	36000	36000	35760	>500	Compliant

7. Measurement Data

7.2. Minimum DTS and Occupied Bandwidths (15.247 (a) (2)) (continued)

7.2.1. 802.11b: Low Channel – 1, J2400

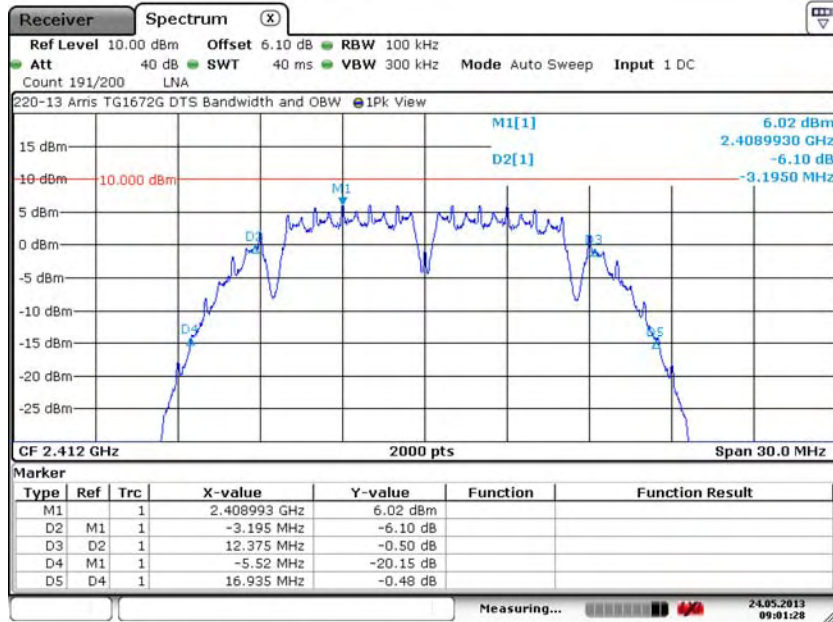

Date: 24.MAY.2013 09:01:27

7.2.2. 802.11b: Low Channel – 1, J2401

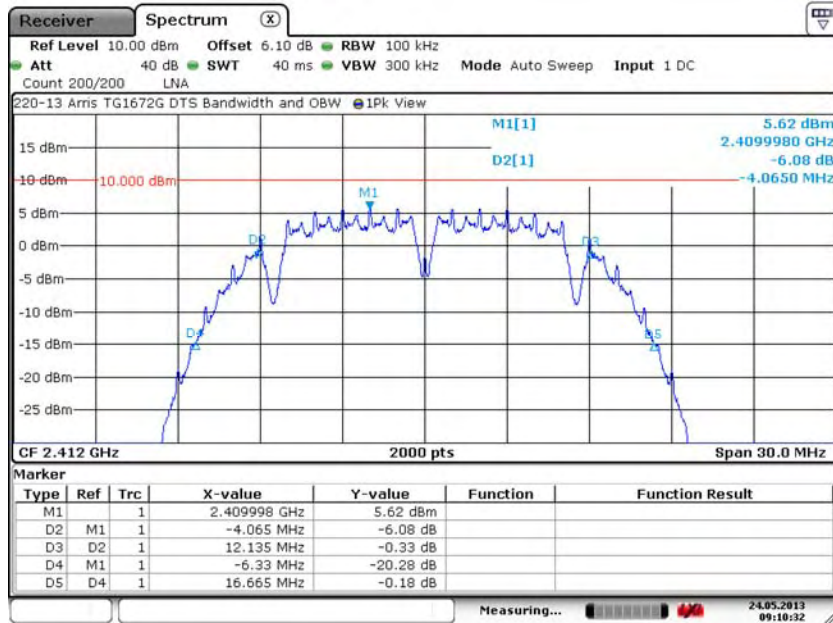

Date: 24.MAY.2013 09:10:31

7. Measurement Data

7.2. Minimum DTS and Occupied Bandwidths (15.247 (a) (2)) (continued)

7.2.3. 802.11b: Low Channel – 1, J2402

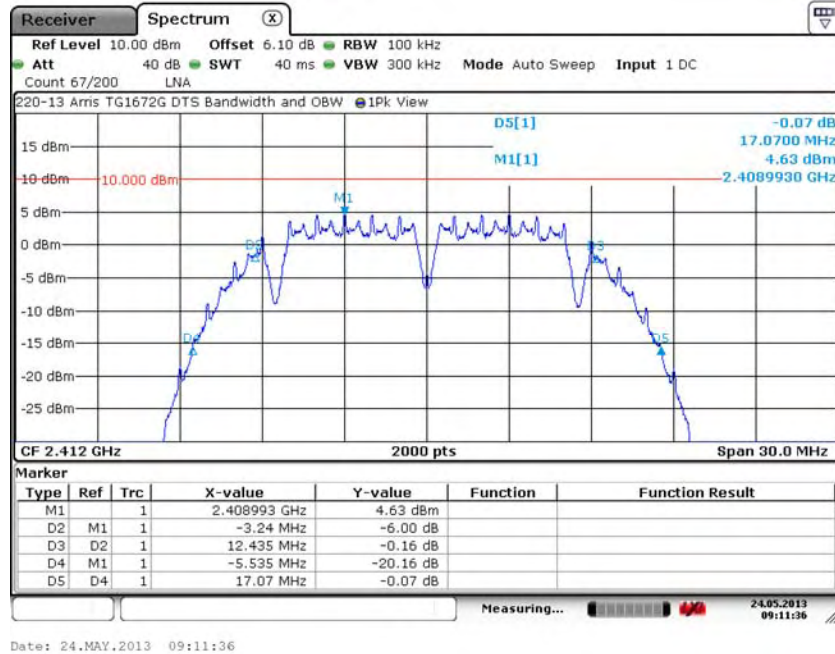

7.2.4. 802.11b: Middle Channel – 6, J2400

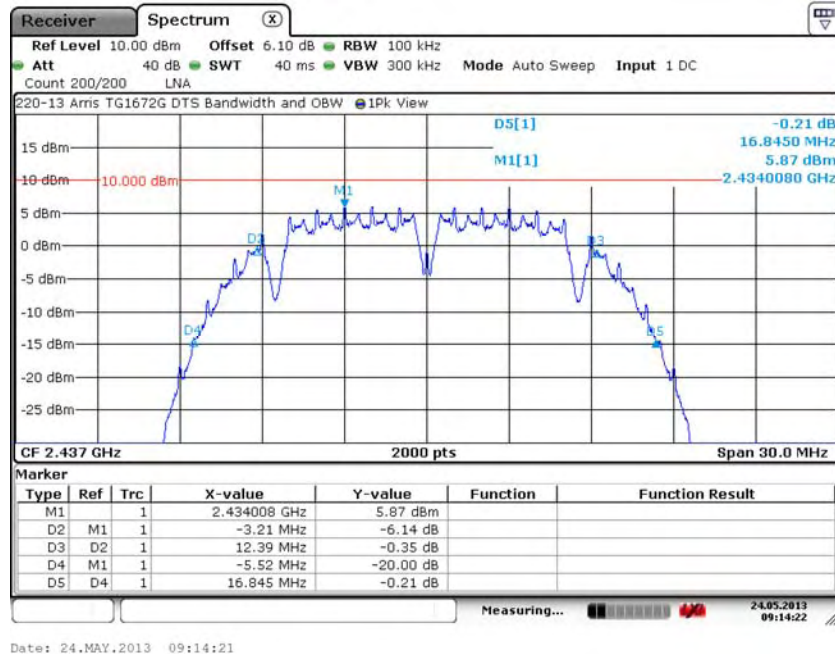

7. Measurement Data

7.2. Minimum DTS and Occupied Bandwidths (15.247 (a) (2)) (continued)

7.2.5. 802.11b: Middle Channel – 6, J2401

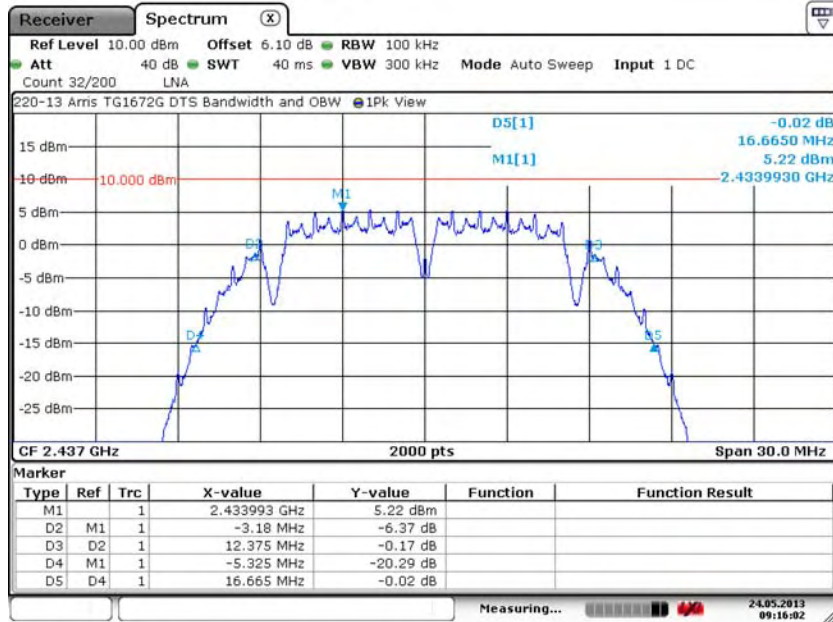

Date: 24.MAY.2013 09:16:01

7.2.6. 802.11b: Middle Channel – 6, J2402

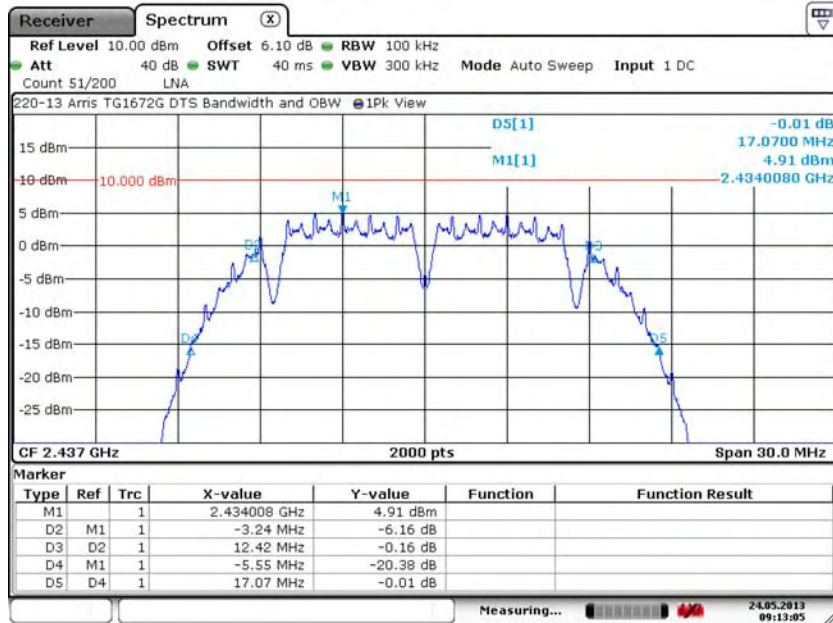

Date: 24.MAY.2013 09:13:04

7. Measurement Data

7.2. Minimum DTS and Occupied Bandwidths (15.247 (a) (2)) (continued)

7.2.7. 802.11b: High Channel – 11, J2400

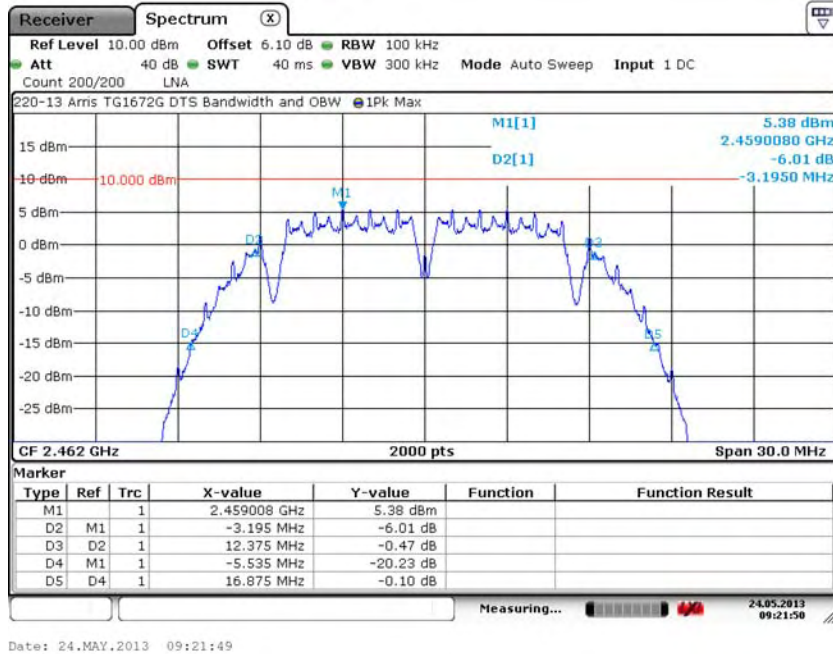

Date: 24.MAY.2013 09:21:49

7.2.8. 802.11b: High Channel – 11, J2401

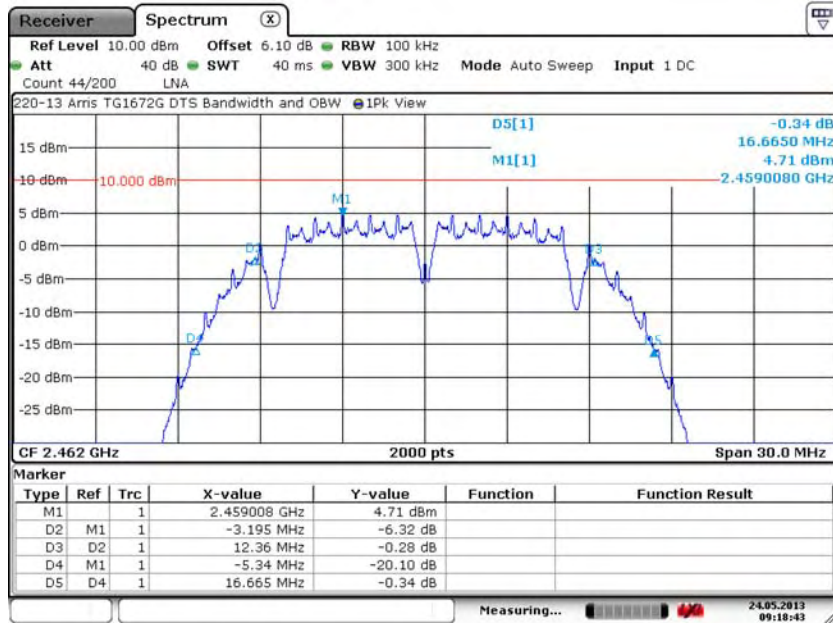

Date: 24.MAY.2013 09:18:42

7. Measurement Data

7.2. Minimum DTS and Occupied Bandwidths (15.247 (a) (2)) (continued)

7.2.9. 802.11b: High Channel – 11, J2402

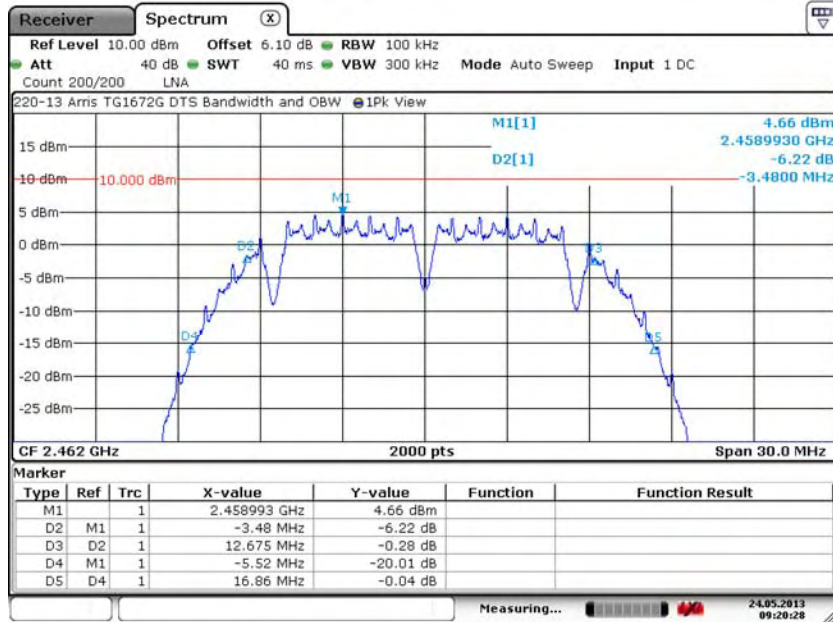

Date: 24.MAY.2013 09:20:27

7.2.10. 802.11g: Low Channel – 1, J2400

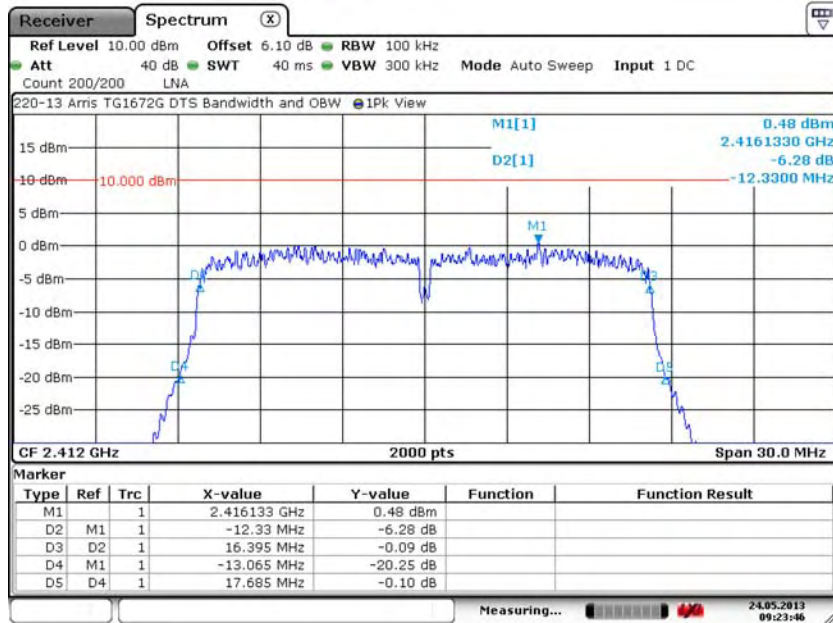

Date: 24.MAY.2013 09:23:45

7. Measurement Data

7.2. Minimum DTS and Occupied Bandwidths (15.247 (a) (2)) (continued)

7.2.11. 802.11g: Low Channel – 1, J2401

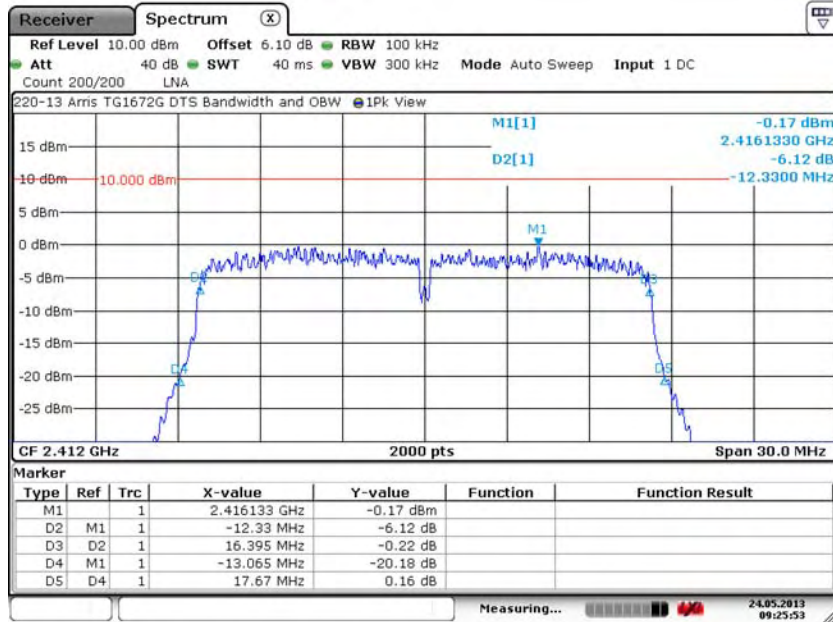

Date: 24.MAY.2013 09:25:53

7.2.12. 802.11g: Low Channel – 1, J2402

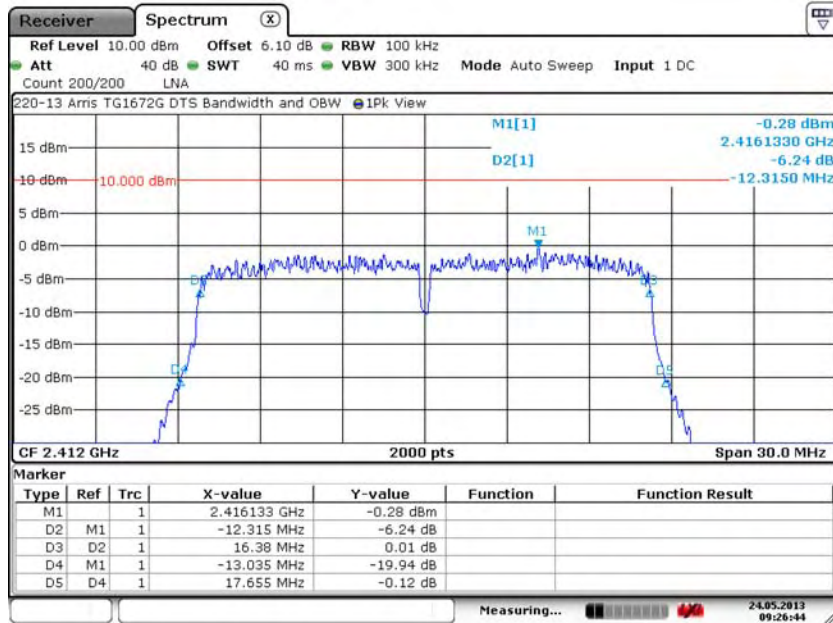

Date: 24.MAY.2013 09:26:44

7. Measurement Data

7.2. Minimum DTS and Occupied Bandwidths (15.247 (a) (2)) (continued)

7.2.13. 802.11g: Middle Channel – 6, J2400

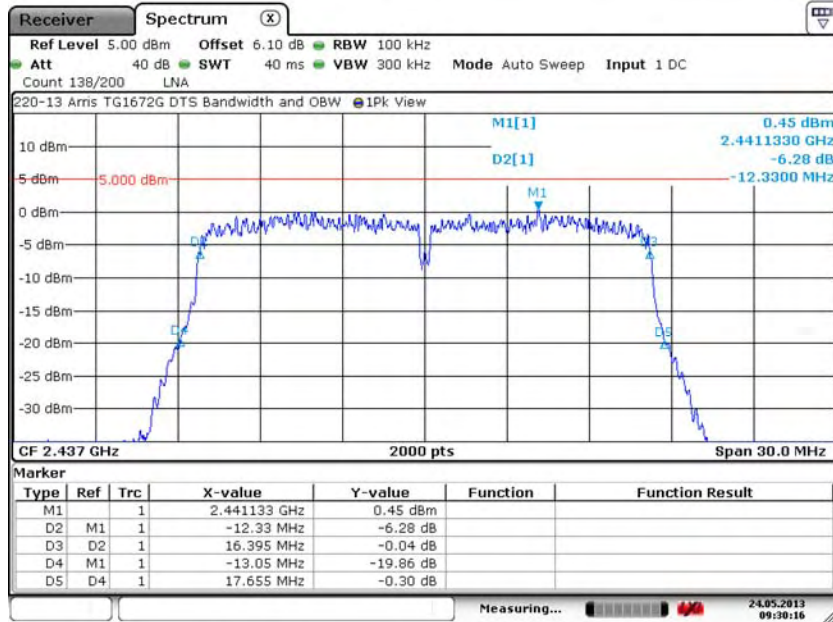

Date: 24.MAY.2013 09:30:16

7.2.14. 802.11g: Middle Channel – 6, J2401

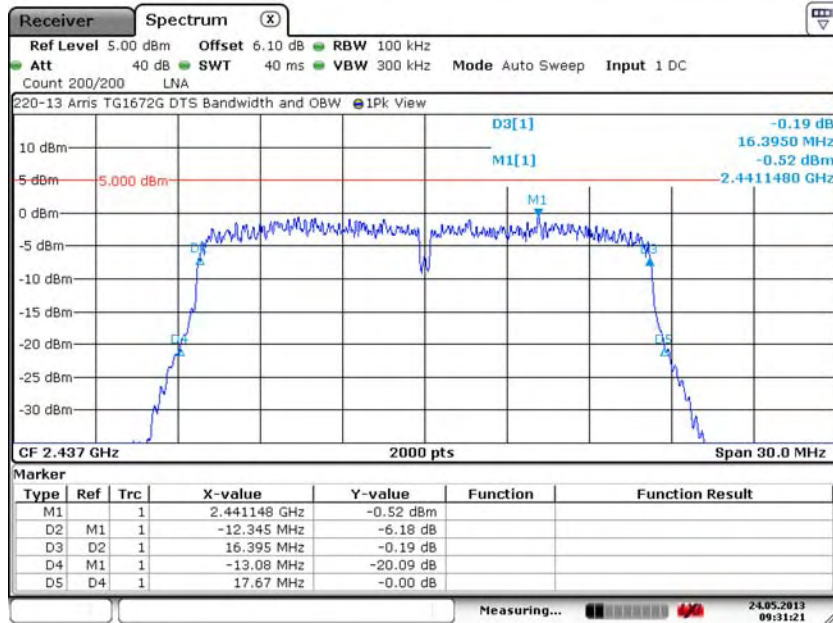

Date: 24.MAY.2013 09:31:21

7. Measurement Data

7.2. Minimum DTS and Occupied Bandwidths (15.247 (a) (2)) (continued)

7.2.15. 802.11g: Middle Channel – 6, J2402

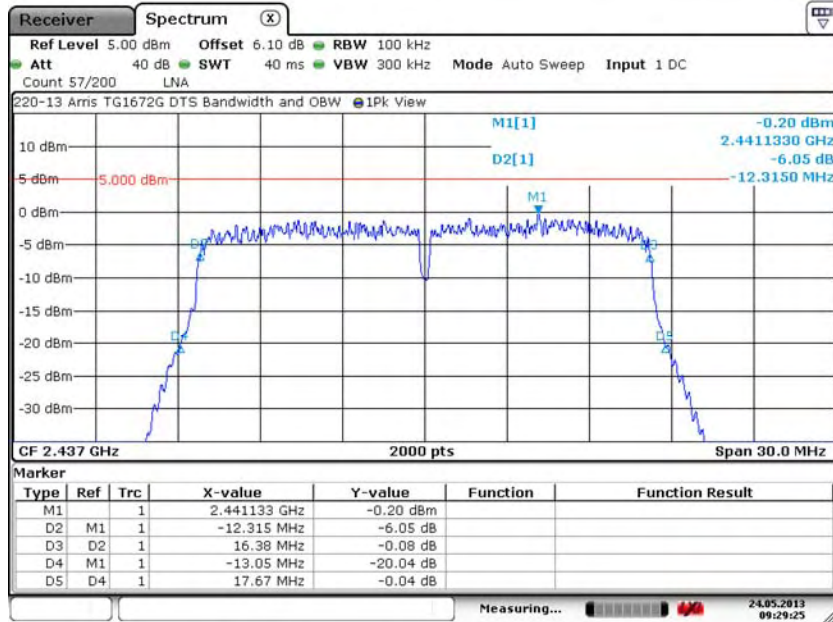

Date: 24.MAY.2013 09:29:24

7.2.16. 802.11g: High Channel – 11, J2400

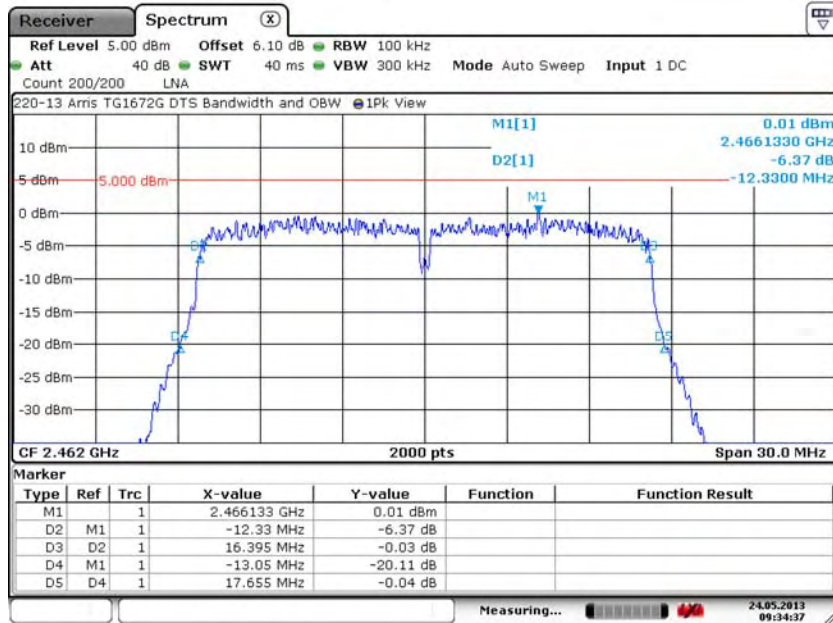

Date: 24.MAY.2013 09:34:37

7. Measurement Data

7.2. Minimum DTS and Occupied Bandwidths (15.247 (a) (2)) (continued)

7.2.17. 802.11g: High Channel – 11, J2401

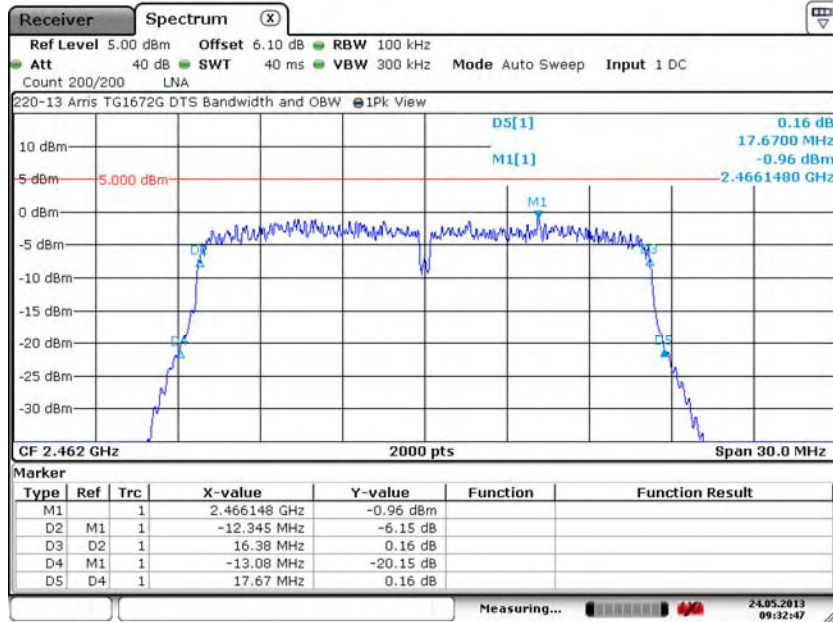

Date: 24.MAY.2013 09:32:47

7.2.18. 802.11g: High Channel – 11, J2402

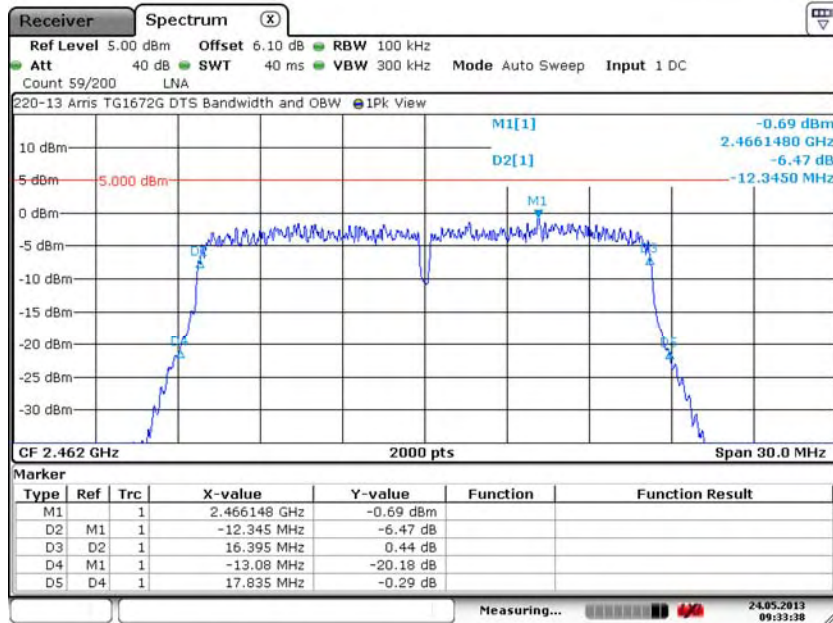

Date: 24.MAY.2013 09:33:37

7. Measurement Data

7.2. Minimum DTS and Occupied Bandwidths (15.247 (a) (2)) (continued)

7.2.19. HT20: Low Channel – 1, J2400

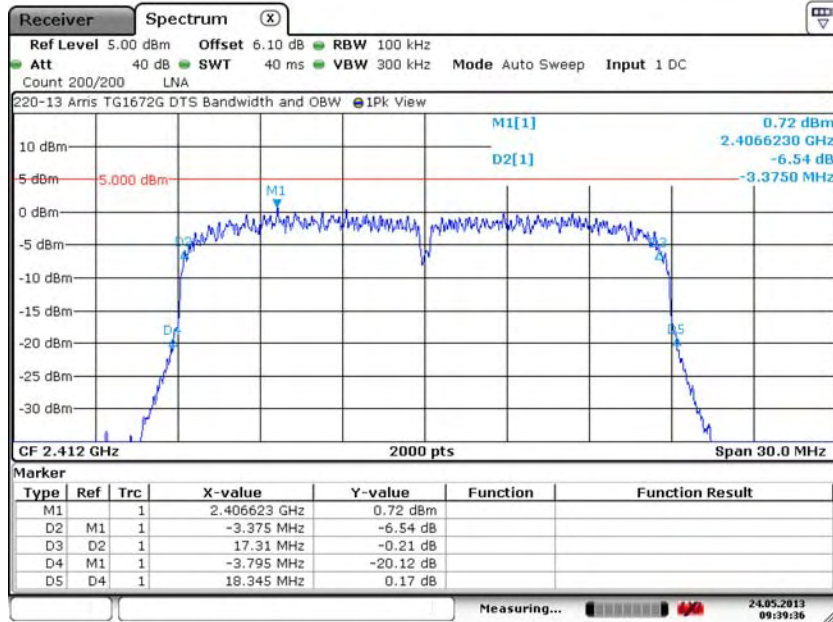

Date: 24.MAY.2013 09:39:36

7.2.20. HT20: Low Channel – 1, J2401

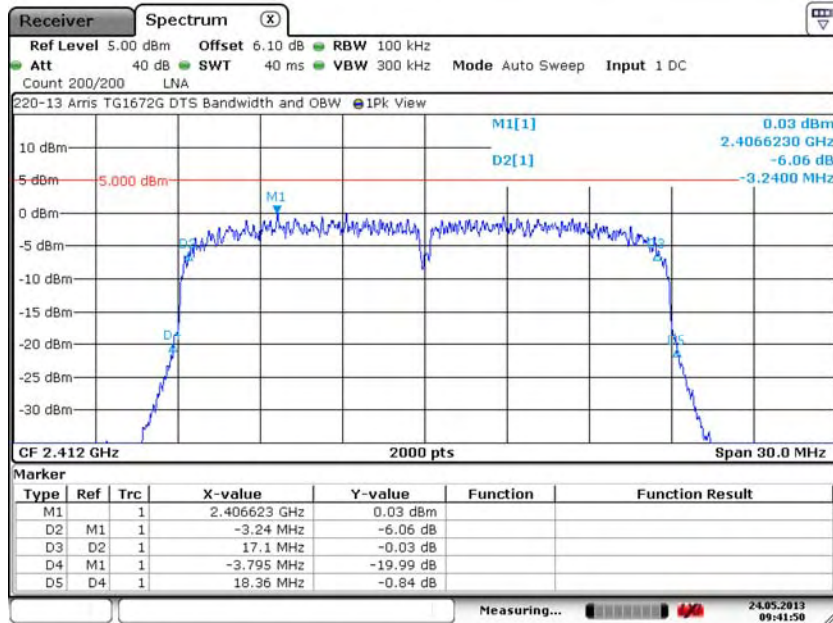

Date: 24.MAY.2013 09:41:49

7. Measurement Data

7.2. Minimum DTS and Occupied Bandwidths (15.247 (a) (2)) (continued)

7.2.21. HT20: Low Channel – 1, J2402

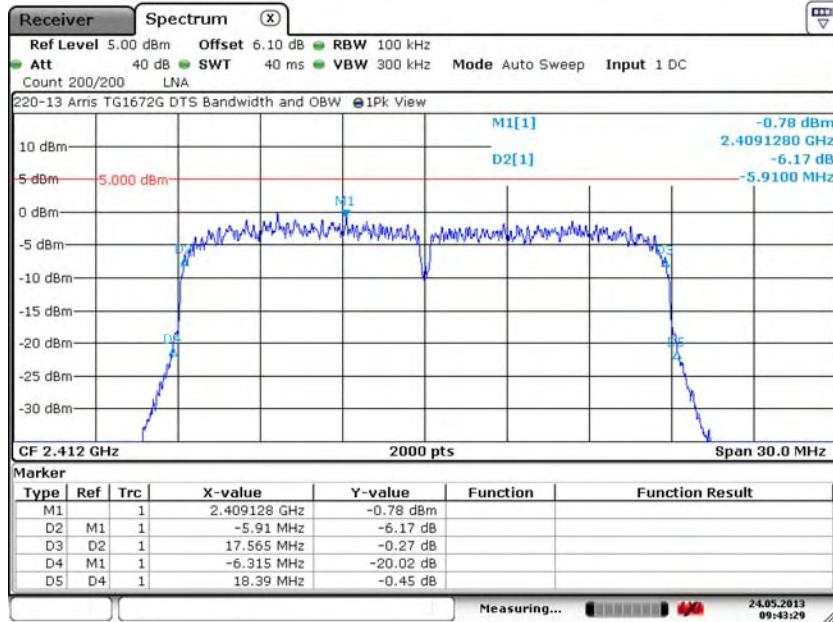

Date: 24.MAY.2013 09:43:29

7.2.22. HT20: Mid Channel – 6, J2400

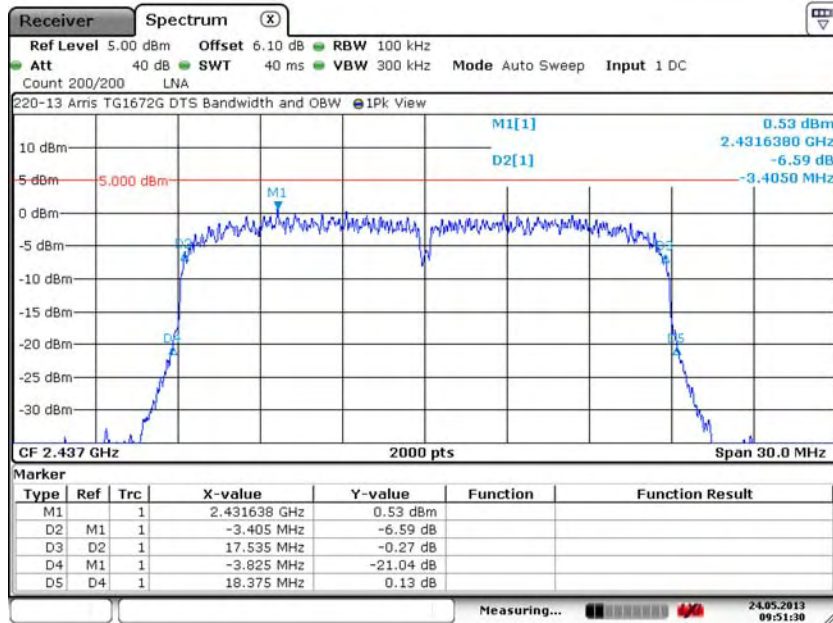

Date: 24.MAY.2013 09:51:30

7. Measurement Data

7.2. Minimum DTS and Occupied Bandwidths (15.247 (a) (2)) (continued)

7.2.23. HT20: Mid Channel – 6, J2401

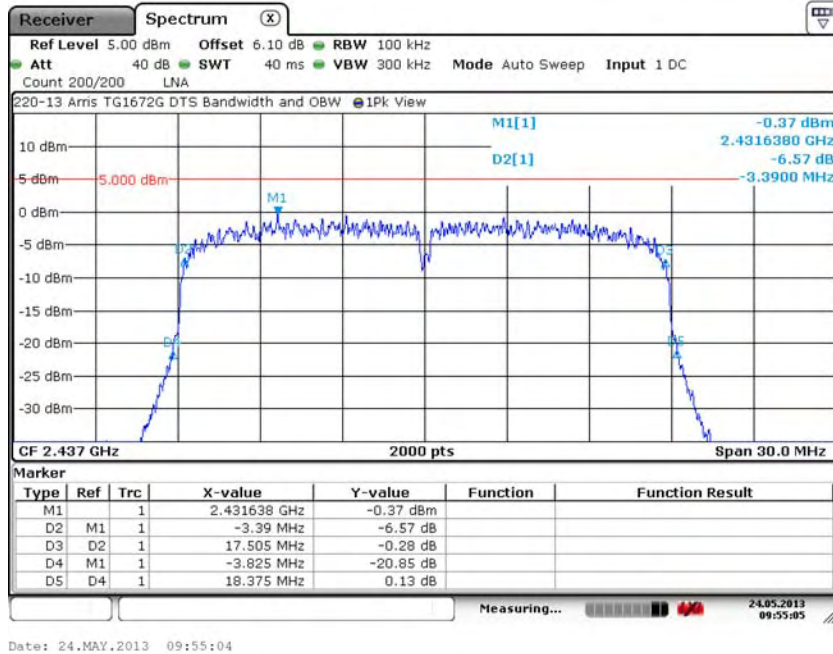

Date: 24.MAY.2013 09:55:04

7.2.24. HT20: Mid Channel – 6, J2402

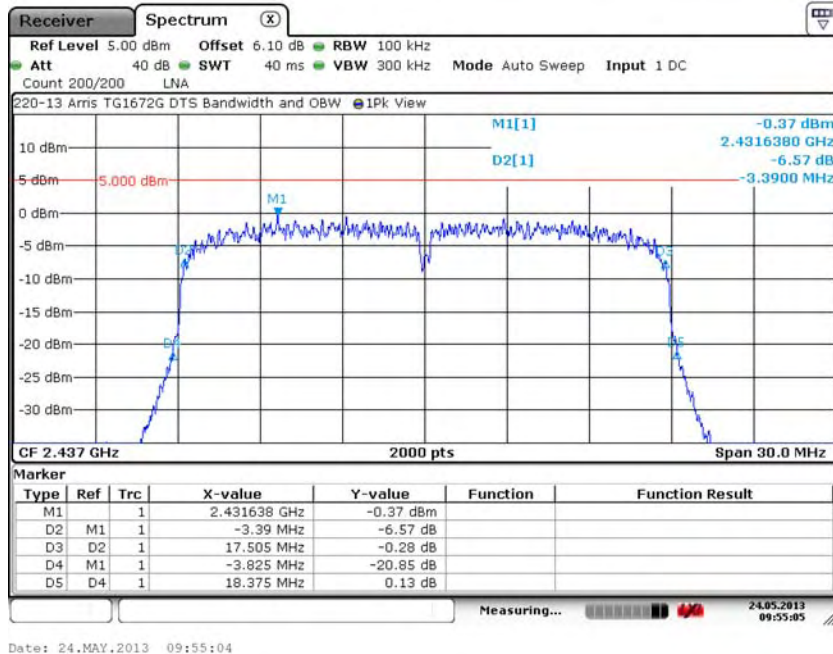

Date: 24.MAY.2013 09:55:04

7. Measurement Data

7.2. Minimum DTS and Occupied Bandwidths (15.247 (a) (2)) (continued)

7.2.25. HT20: High Channel – 11, J2400

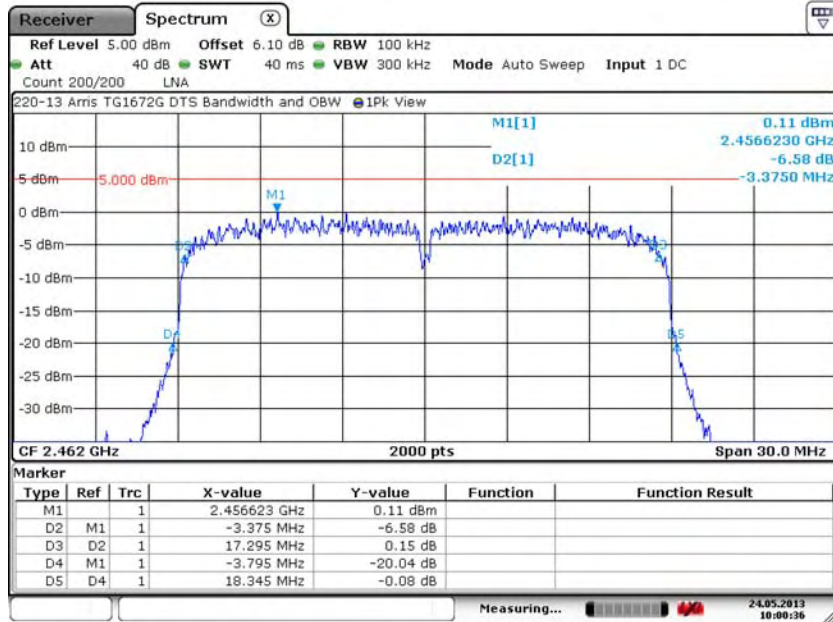

Date: 24.MAY.2013 10:00:35

7.2.26. HT20: High Channel – 11, J2401

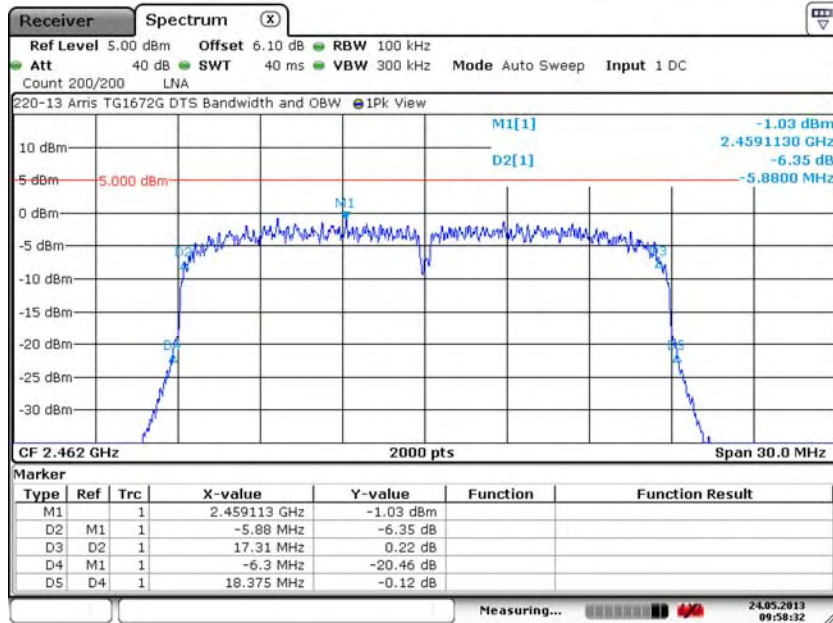

Date: 24.MAY.2013 09:58:31

7. Measurement Data

7.2. Minimum DTS and Occupied Bandwidths (15.247 (a) (2)) (continued)

7.2.27. HT20: High Channel – 11, J2402

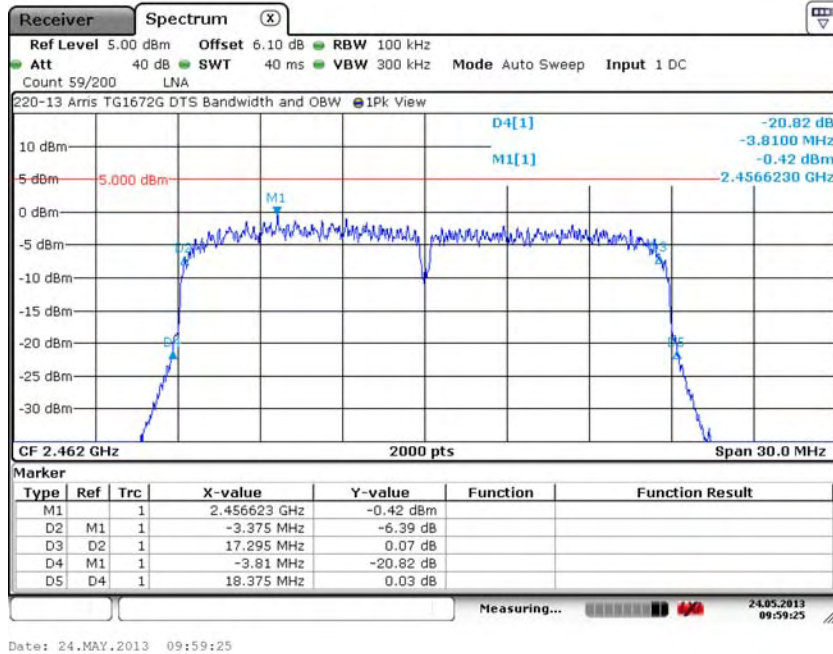

Date: 24.MAY.2013 09:59:25

7.2.28. HT40: Low Channel – 3, J2400

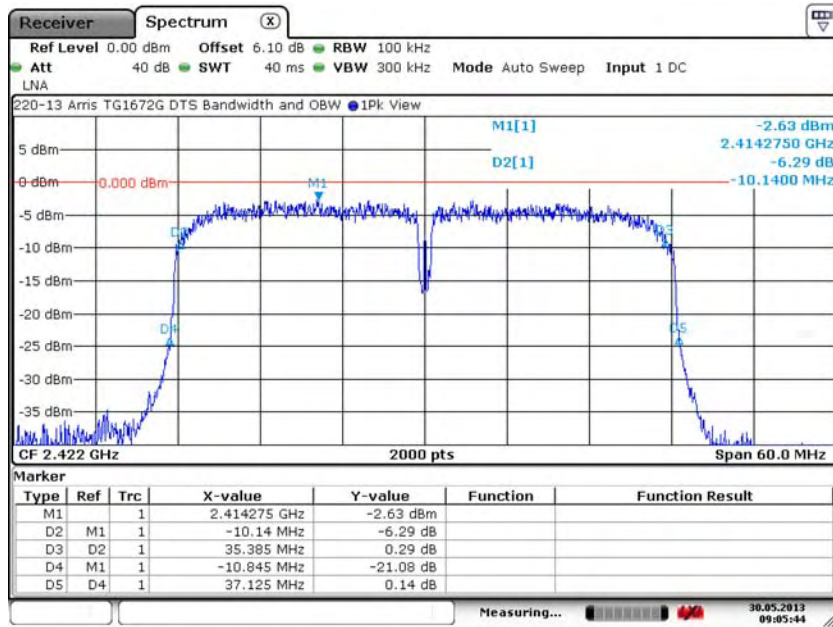

Date: 30.MAY.2013 09:05:45

7. Measurement Data

7.2. Minimum DTS and Occupied Bandwidths (15.247 (a) (2)) (continued)

7.2.29. HT40: Low Channel – 3, J2401

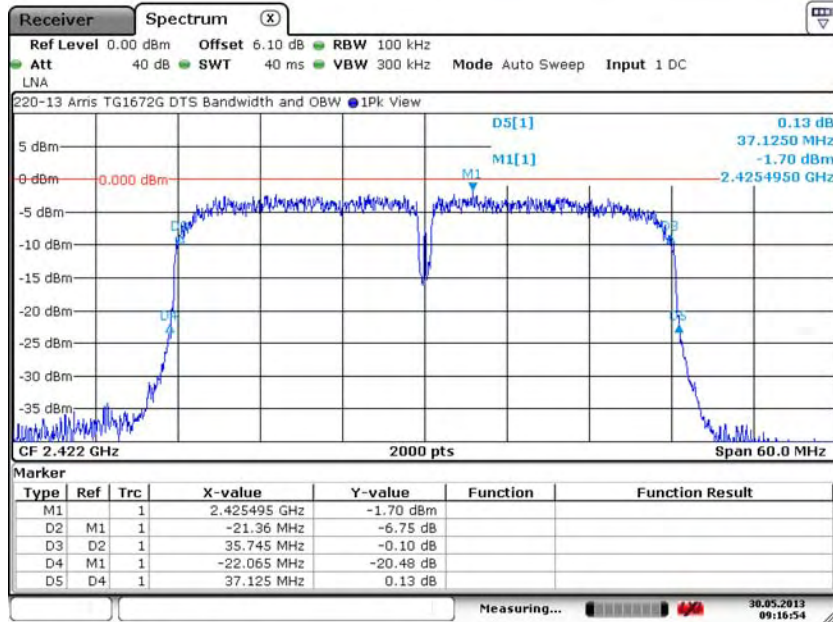

Date: 30.MAY.2013 09:16:54

7.2.30. HT40: Low Channel – 3, J2402

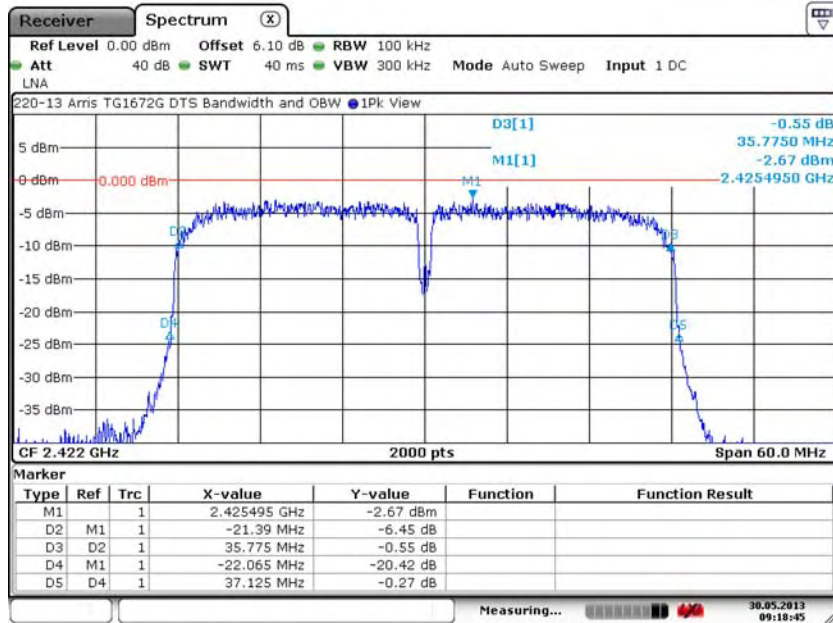

Date: 30.MAY.2013 09:18:45

7. Measurement Data

7.2. Minimum DTS and Occpied Bandwidths (15.247 (a) (2)) (continued)

7.2.31. HT40: Mid Channel – 6, J2400

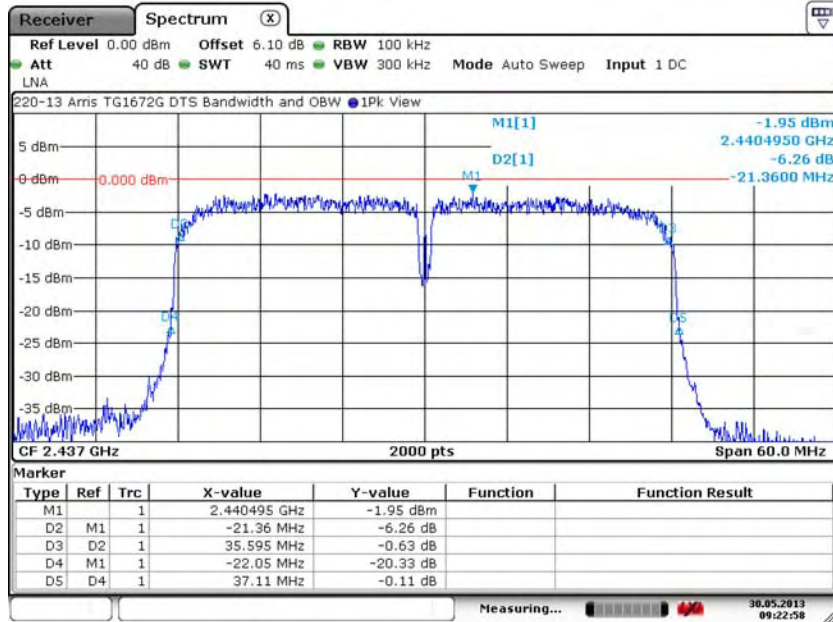

Date: 30.MAY.2013 09:22:58

7.2.32. HT40: Mid Channel – 6, J2401

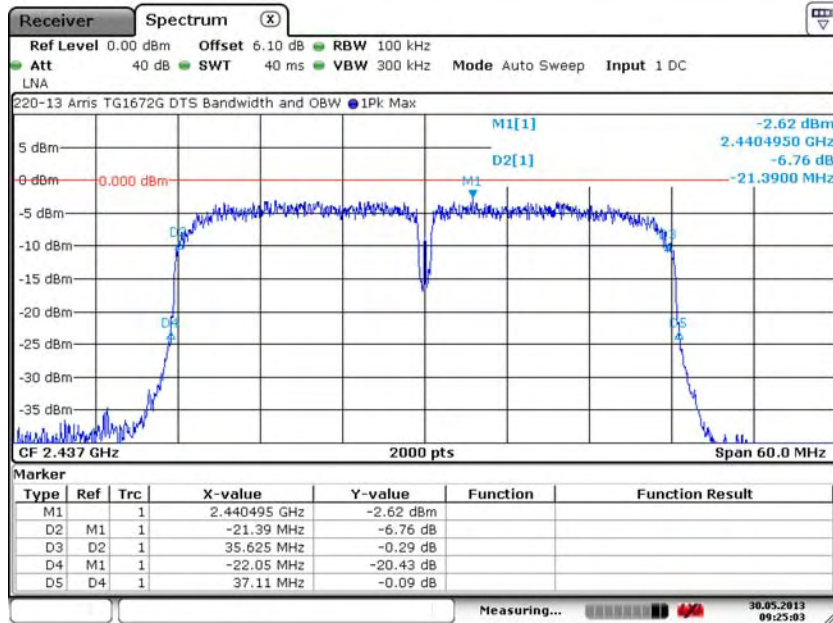

Date: 30.MAY.2013 09:25:04

7. Measurement Data

7.2. Minimum DTS and Occupied Bandwidths (15.247 (a) (2)) (continued)

7.2.33. HT40: Mid Channel – 6, J2402

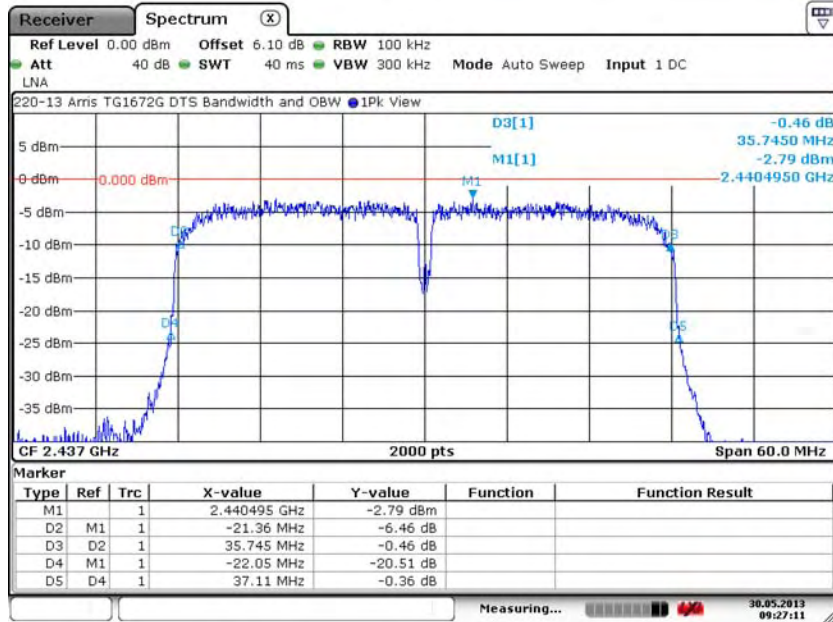

Date: 30.MAY.2013 09:27:12

7.2.34. HT40: High Channel – 9, J2400

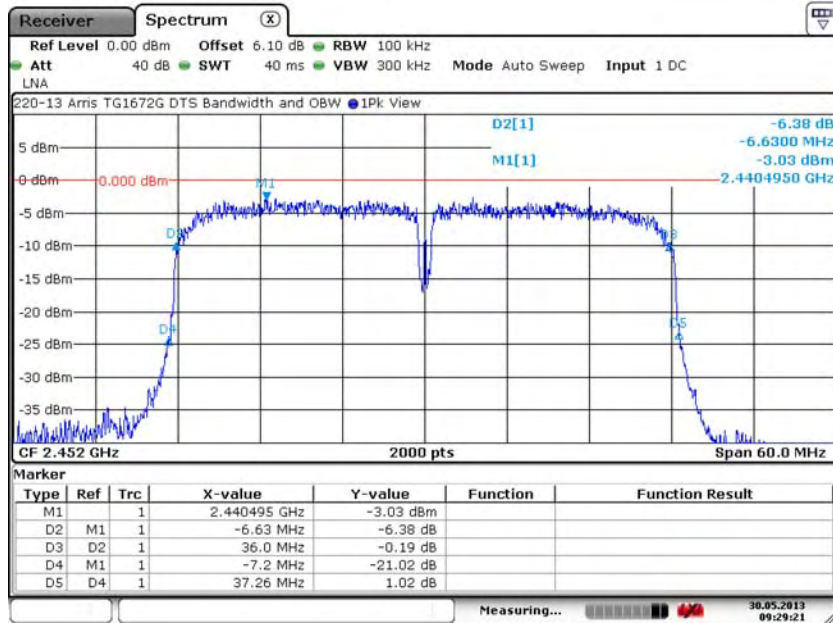

Date: 30.MAY.2013 09:29:21

7. Measurement Data

7.2. Minimum DTS and Occupied Bandwidths (15.247 (a) (2)) (continued)

7.2.35. HT40: High Channel – 9, J2401

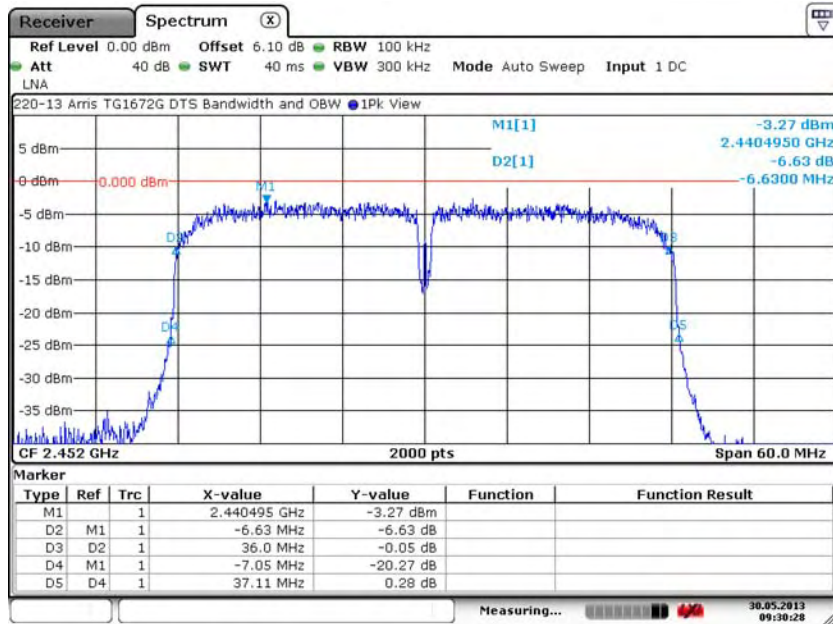

Date: 30.MAY.2013 09:30:28

7.2.36. HT40: High Channel – 9, J2402

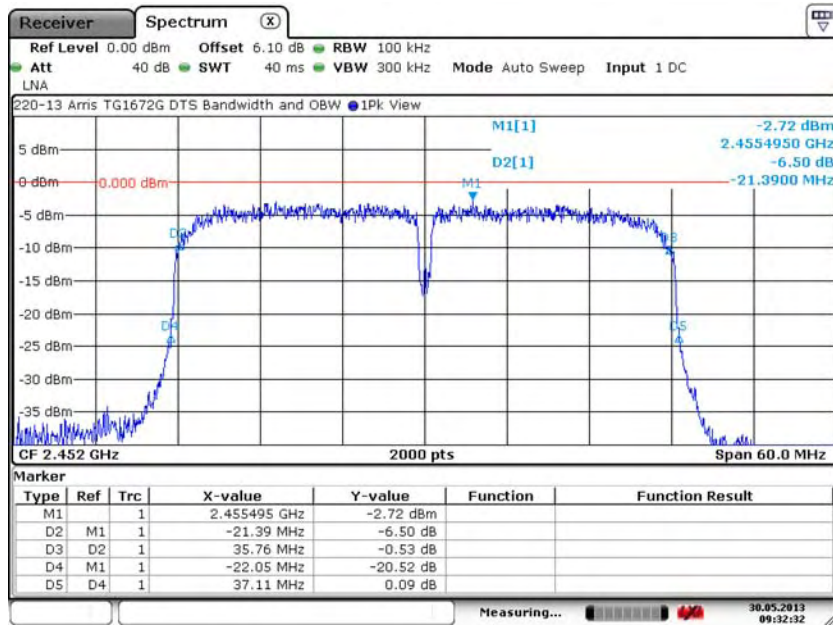

Date: 30.MAY.2013 09:32:32

7. Measurement Data

7.2. Minimum DTS and Occupied Bandwidths (15.247 (a) (2)) (continued)

Requirement: (15.247 (a) (2), RSS 210 A8.2(a))

Systems using digital modulation techniques may operate in the 902 - 928 MHz, 2400 - 2483.5 MHz, and 5725 - 5850 MHz bands. The minimum 6 dB bandwidth shall be at least 500 kHz.

Procedure: This test was performed in accordance with the procedure detailed in FCC OET publication number 558074, Section 8.0, DTS (6 dB) Channel Bandwidth.

Conclusion: The device under test meets the minimum 500 kHz 6 dB bandwidth requirement.

Measurement Results for 5725 to 5850 MHz Band

802.11a Mode Channel	Frequency (MHz)	-6 dB Bandwidth (kHz)			Minimum -6 dB Bandwidth (kHz)	Result
		J5000	J5001	J5002		
Low	5745	16485	16395	16425	>500	Compliant
Middle	5785	16380	16455	16455	>500	Compliant
High	5825	16440	16455	16455	>500	Compliant

HT20 Mode Channel	Frequency (MHz)	-6 dB Bandwidth (kHz)			Minimum -6 dB Bandwidth (kHz)	Result
		J5000	J5001	J5002		
Low	5745	17520	17505	17520	>500	Compliant
Middle	5785	17520	17520	17505	>500	Compliant
High	5825	17520	17520	17520	>500	Compliant

HT40 Mode Channel	Frequency (MHz)	-6 dB Bandwidth (kHz)			Minimum -6 dB Bandwidth (kHz)	Result
		J5000	J5001	J5002		
Low	5755	35400	36030	36240	>500	Compliant
High	5795	35414	35774	35384	>500	Compliant

7. Measurement Data (continued)

7.2. Minimum DTS and Occupied Bandwidths (15.247 (a) (2)) (continued)

7.2.37. 802.11a: Low Channel – 149, J5000

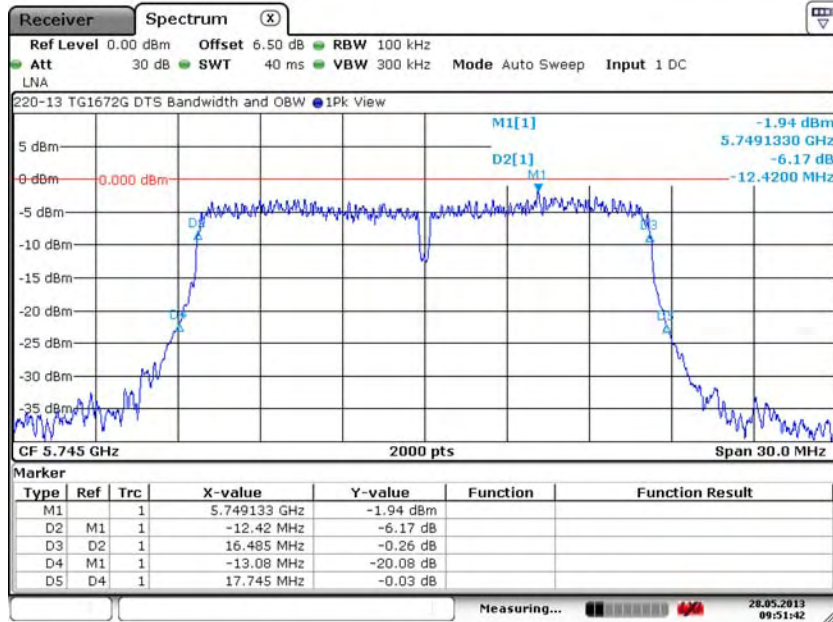

Date: 28.MAY.2013 09:51:42

7.2.38. 802.11a: Low Channel – 149, J5001

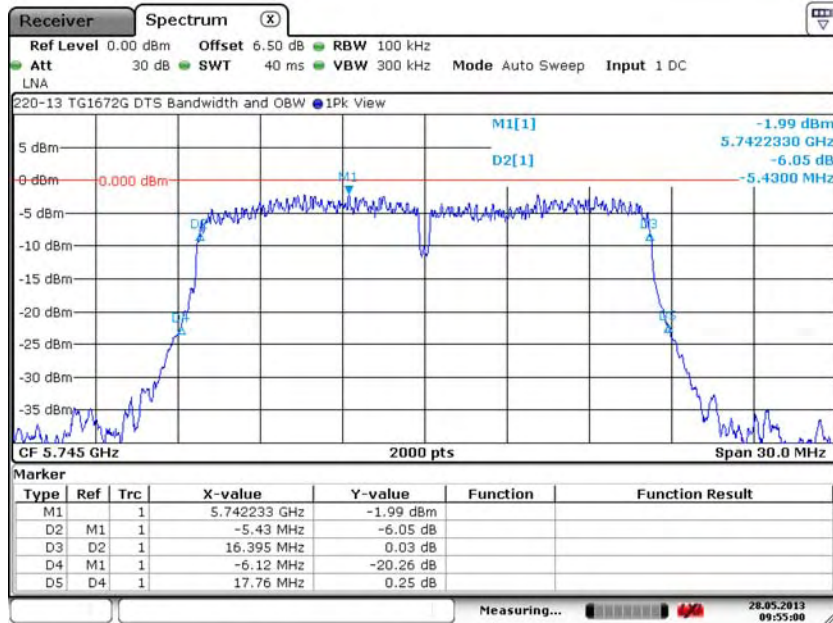

Date: 28.MAY.2013 09:55:00

7. Measurement Data (continued)

7.2. Minimum DTS and Occupied Bandwidths (15.247 (a) (2)) (continued)

7.2.39. 802.11a: Low Channel – 149, J5002

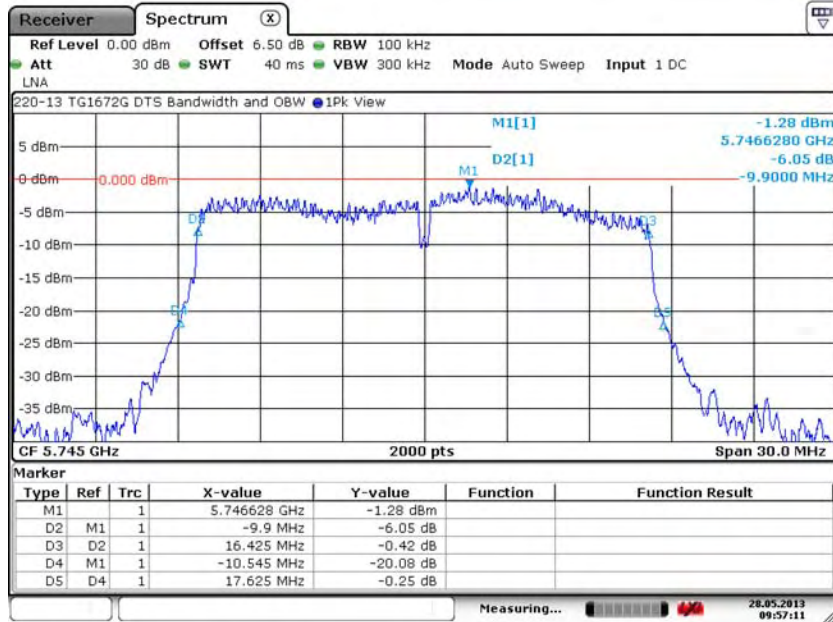

Date: 28.MAY.2013 09:57:11

7.2.40. 802.11a: Middle Channel – 157, J5000

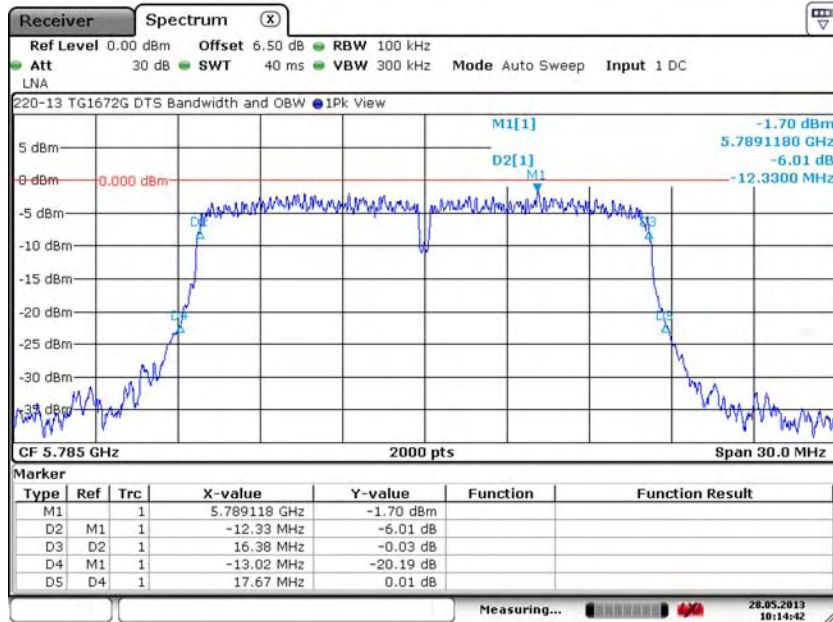

Date: 28.MAY.2013 10:14:42

7. Measurement Data (continued)

7.2. Minimum DTS and Occupied Bandwidths (15.247 (a) (2)) (continued)

7.2.41. 802.11a: Middle Channel – 157, J5001

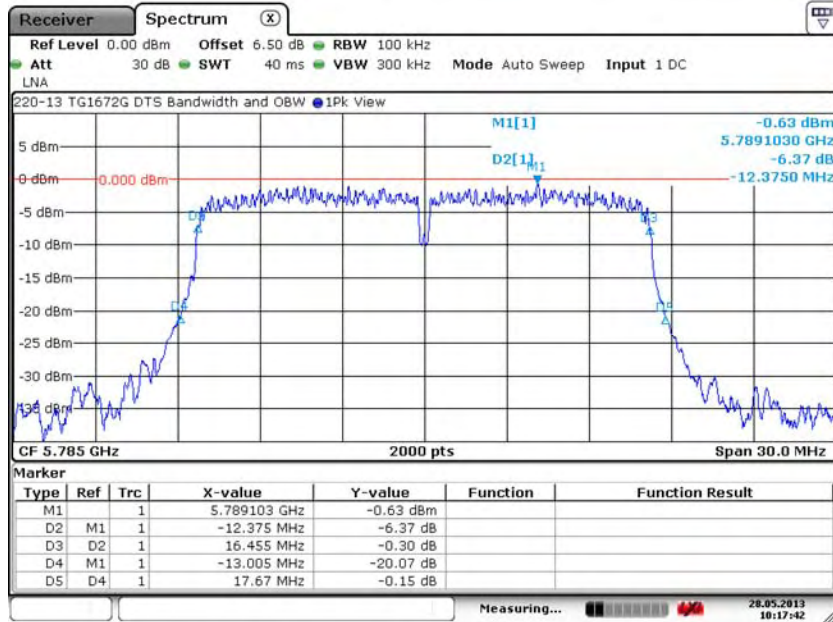

Date: 28.MAY.2013 10:17:42

7.2.42. 802.11a: Middle Channel – 157, J5002

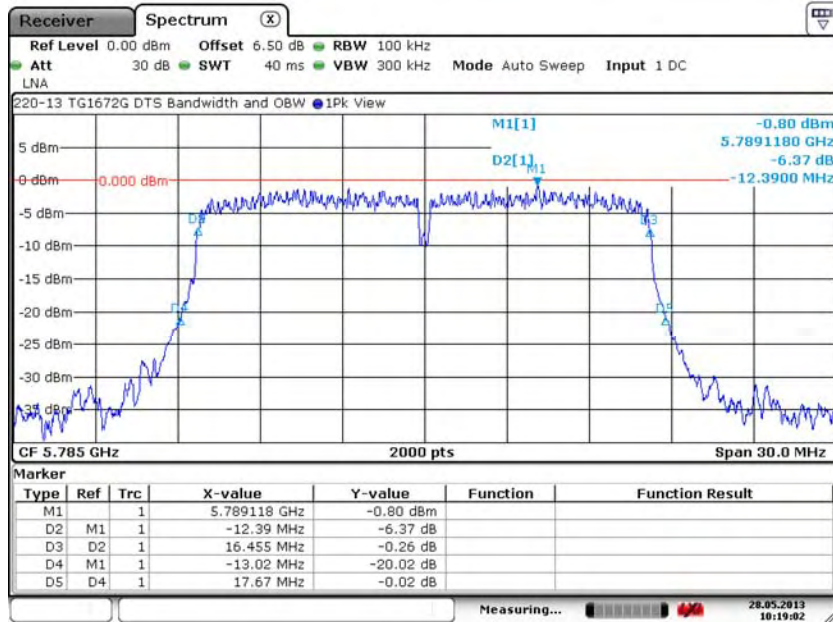

Date: 28.MAY.2013 10:19:02

7. Measurement Data (continued)

7.2. Minimum DTS and Occupied Bandwidths (15.247 (a) (2)) (continued)

7.2.43. 802.11a: High Channel – 165, J5000

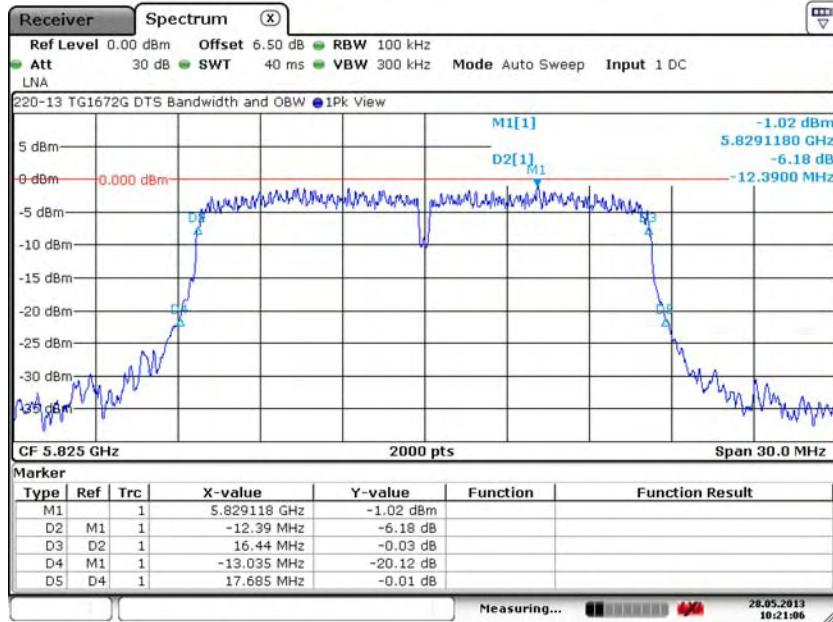

Date: 28.MAY.2013 10:21:06

7.2.44. 802.11a: High Channel – 165, J5001

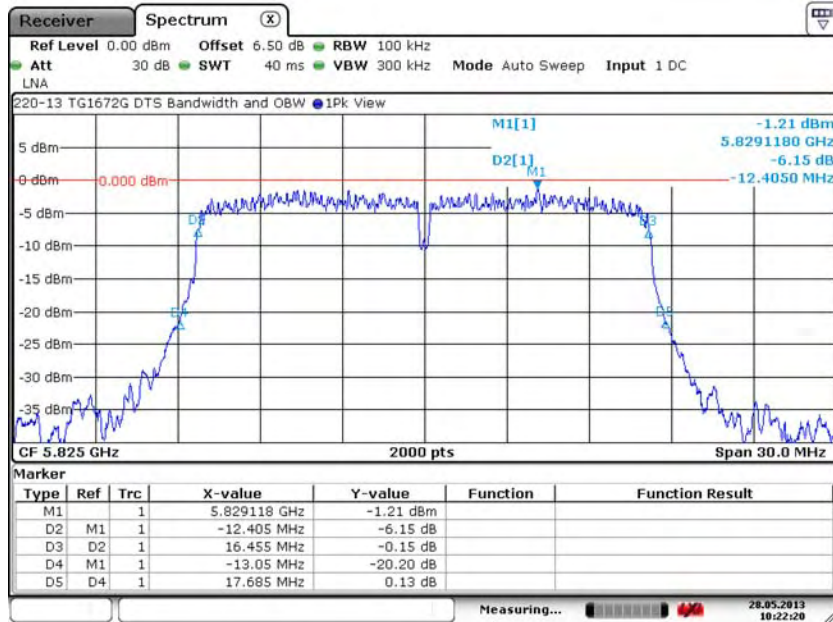

Date: 28.MAY.2013 10:22:20

7. Measurement Data (continued)

7.2. Minimum DTS and Occupied Bandwidths (15.247 (a) (2)) (continued)

7.2.45. 802.11a: High Channel – 165, J5002

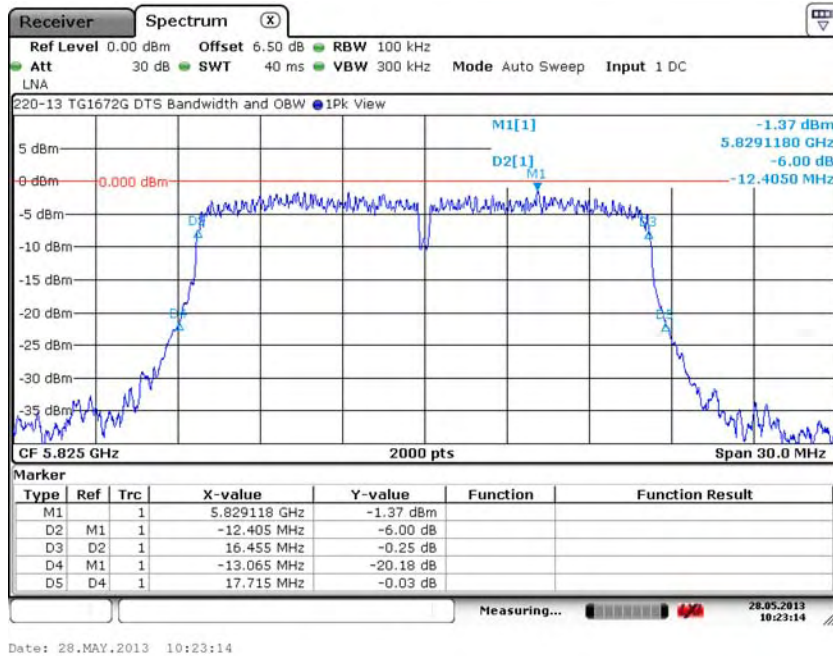

Date: 28.MAY.2013 10:23:14

7.2.46. HT20: Low Channel – 149, J5000

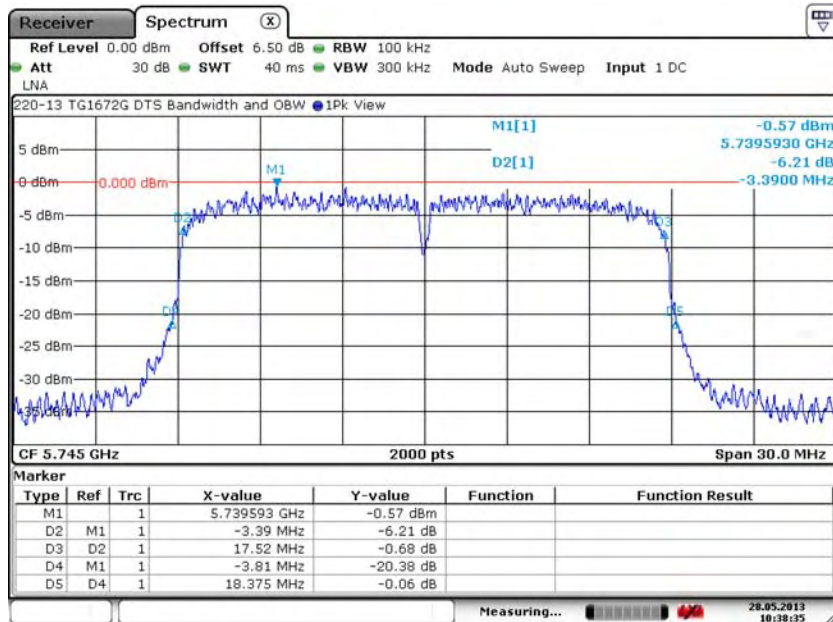

Date: 28.MAY.2013 10:38:35

7. Measurement Data (continued)

7.2. Minimum DTS and Occupied Bandwidths (15.247 (a) (2)) (continued)

7.2.47. HT20: Low Channel – 149, J5001

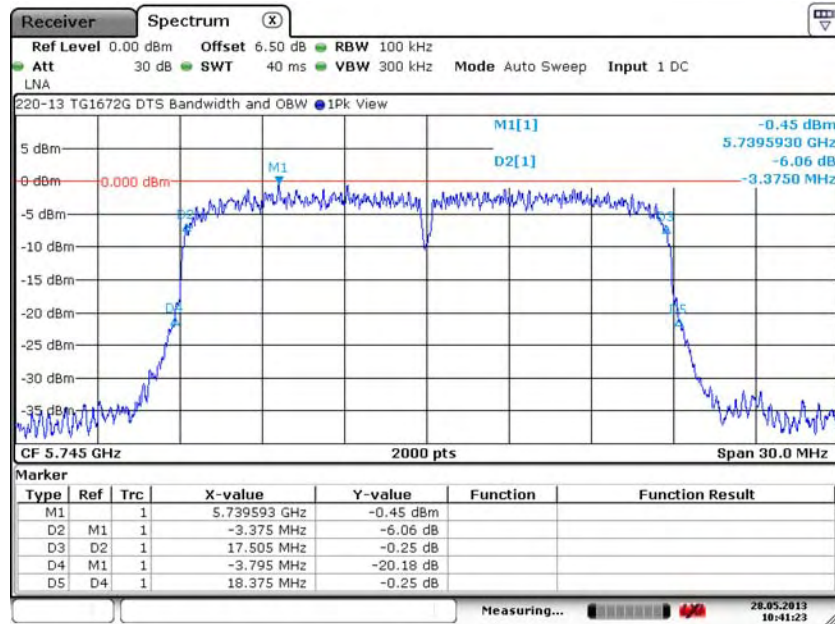

Date: 28.MAY.2013 10:41:23

7.2.48. HT20: Low Channel – 149, J5002

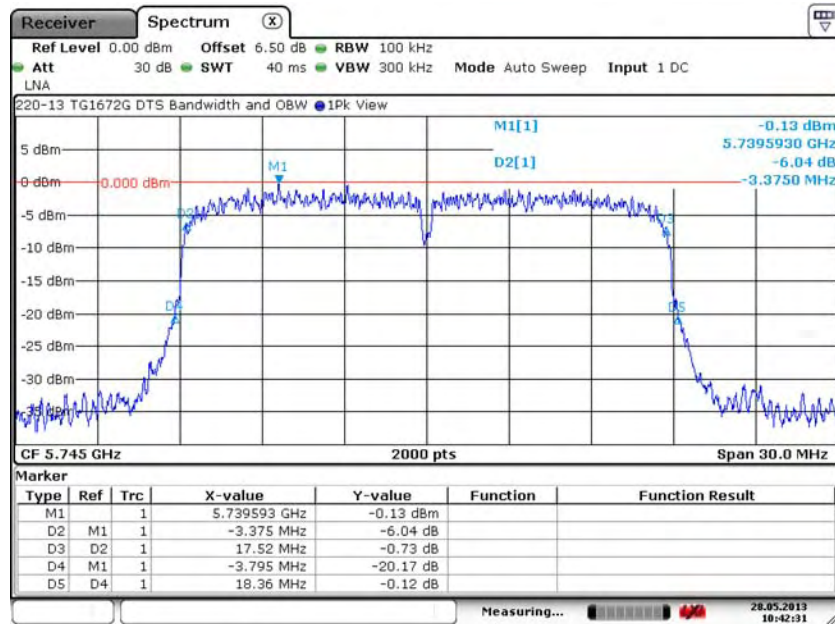

Date: 28.MAY.2013 10:42:31

7. Measurement Data (continued)

7.2. Minimum DTS and Occupied Bandwidths (15.247 (a) (2)) (continued)

7.2.49. HT20: Middle Channel – 157, J5000

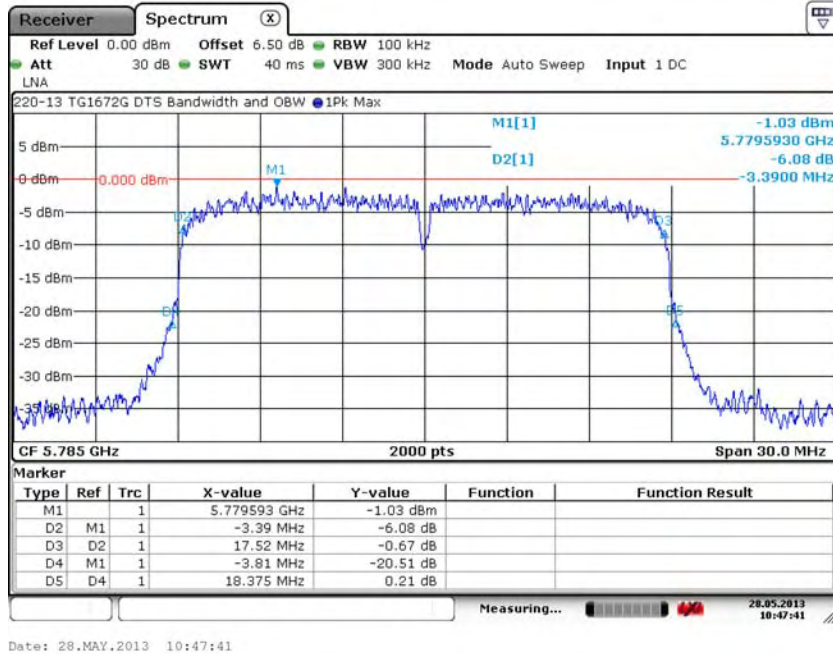

Date: 28.MAY.2013 10:47:41

7.2.50. HT20: Middle Channel – 157, J5001

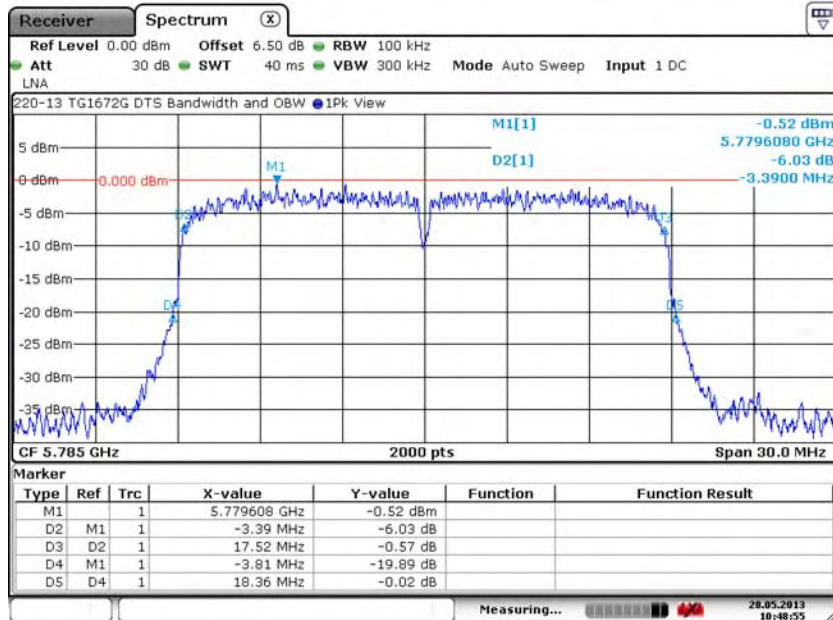

Date: 28.MAY.2013 10:48:55

7. Measurement Data (continued)

7.2. Minimum DTS and Occupied Bandwidths (15.247 (a) (2)) (continued)

7.2.51. HT20: Middle Channel – 157, J5002

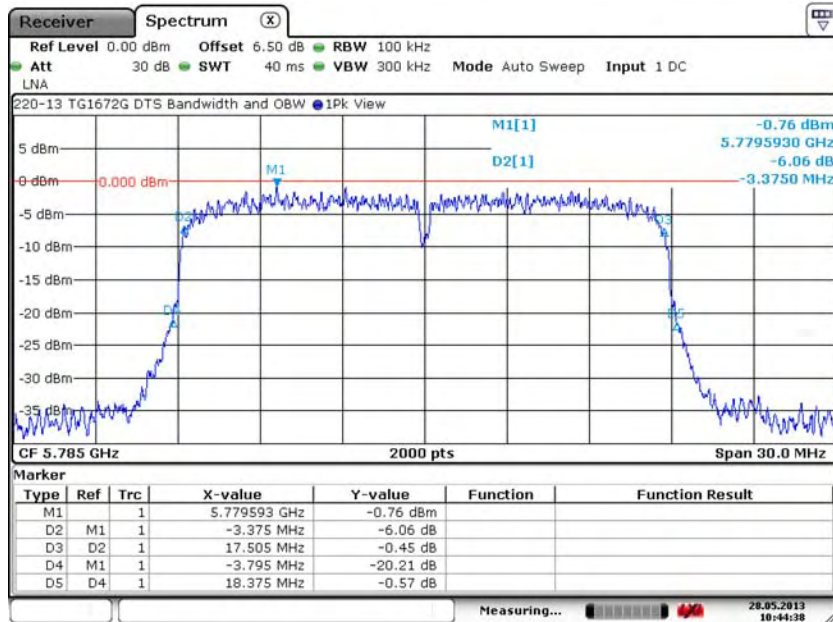

Date: 28.MAY.2013 10:44:38

7.2.52. HT20: High Channel – 165, J5000

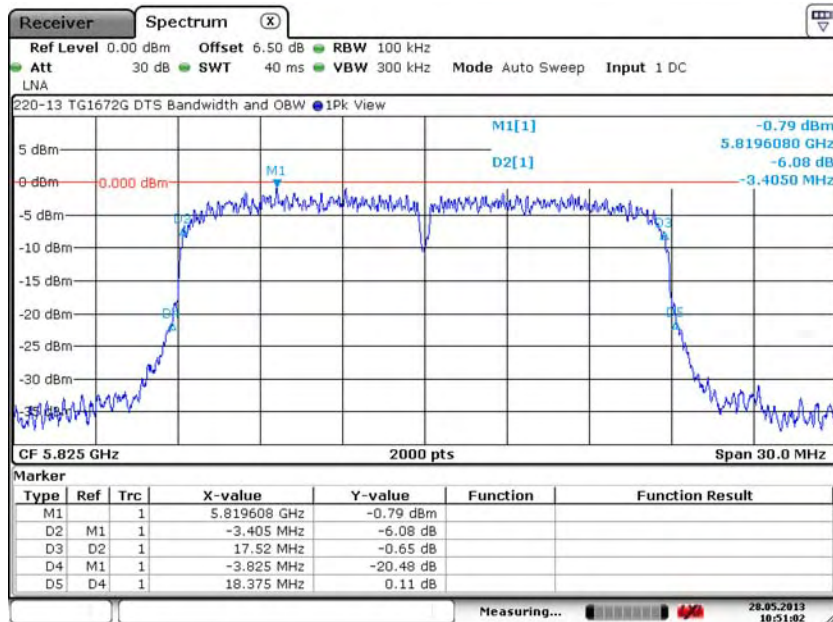

Date: 28.MAY.2013 10:51:02

7. Measurement Data (continued)

7.2. Minimum DTS and Occupied Bandwidths (15.247 (a) (2)) (continued)

7.2.53. HT20: High Channel – 165, J5001

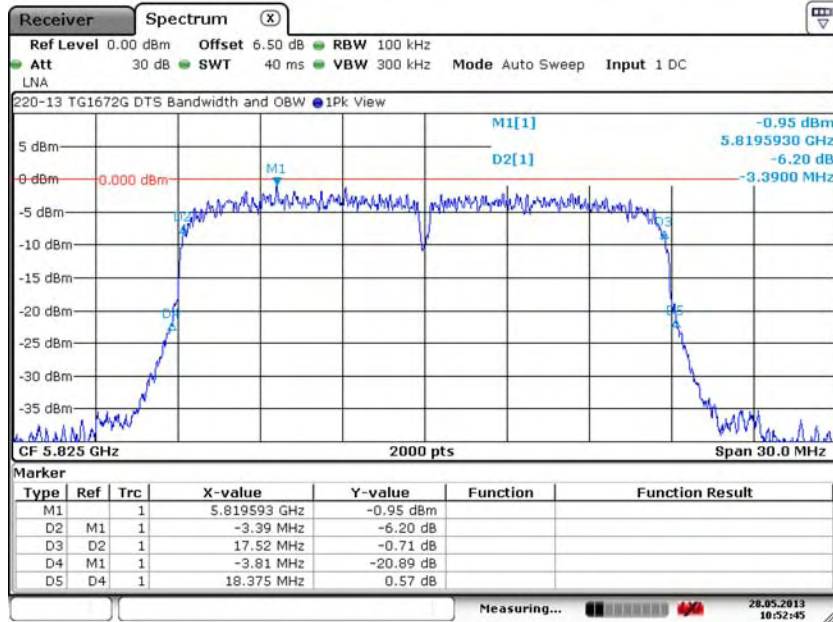

Date: 28.MAY.2013 10:52:45

7.2.54. HT20: High Channel – 165, J5002

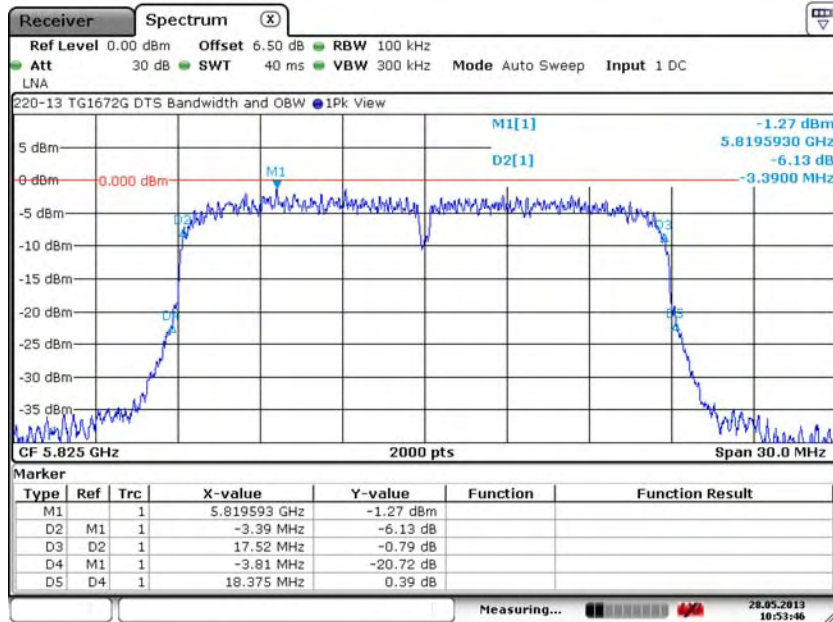

Date: 28.MAY.2013 10:53:46

7. Measurement Data (continued)

7.2. Minimum DTS and Occupied Bandwidths (15.247 (a) (2)) (continued)

7.2.55. HT40: Low Channel – 151, J5000

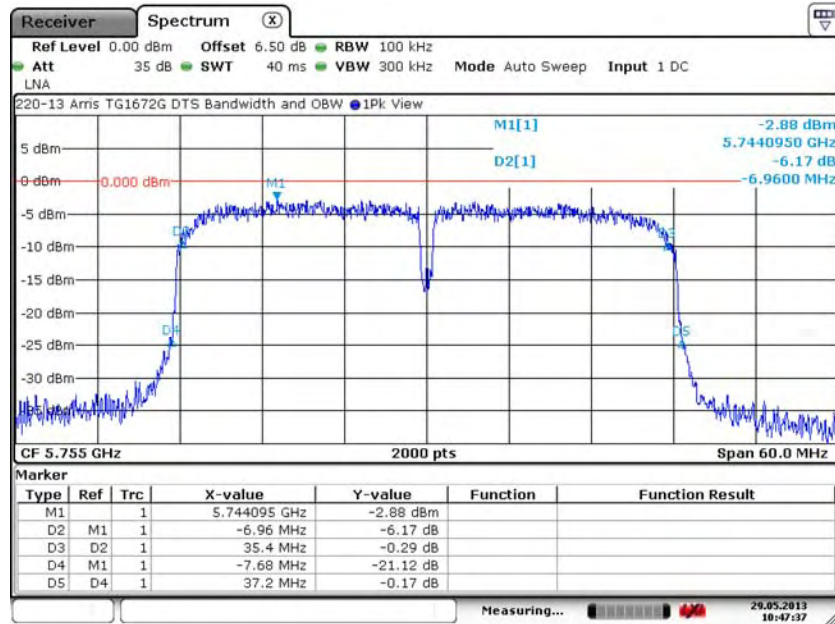

Date: 29.MAY.2013 10:47:37

7.2.56. HT40: Low Channel – 151, J5001

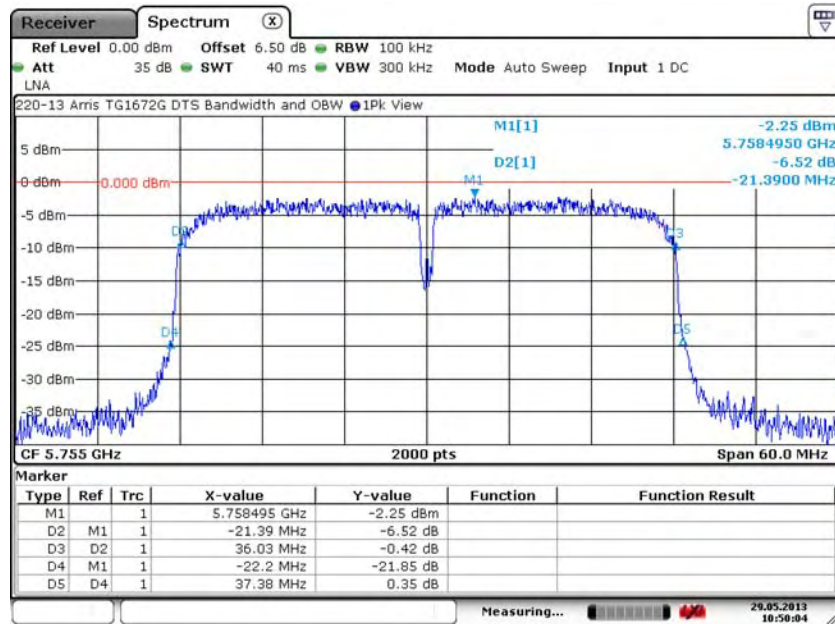

Date: 29.MAY.2013 10:50:05

7. Measurement Data (continued)

7.2. Minimum DTS and Occupied Bandwidths (15.247 (a) (2)) (continued)

7.2.57. HT40: Low Channel – 151, J5002

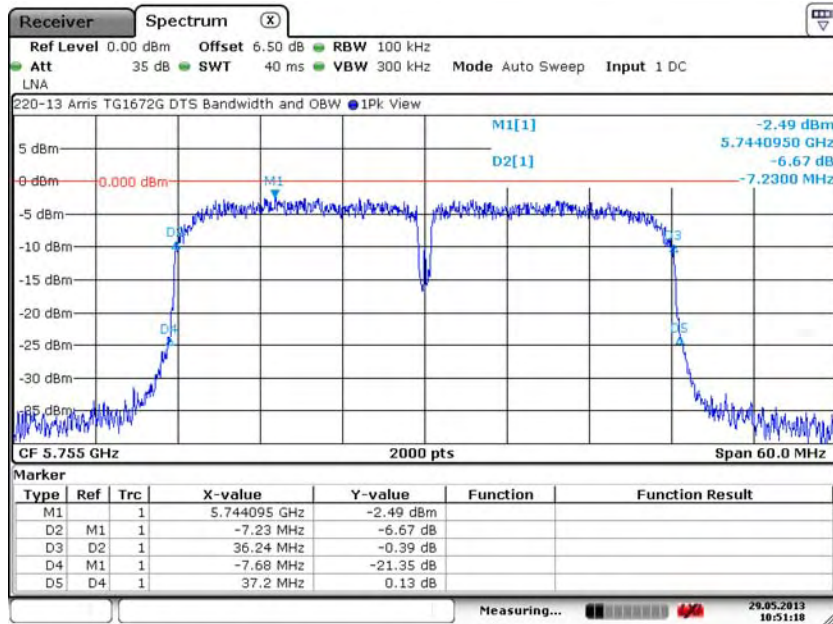

Date: 29.MAY.2013 10:51:18

7.2.58. HT40: High Channel – 159, J5000

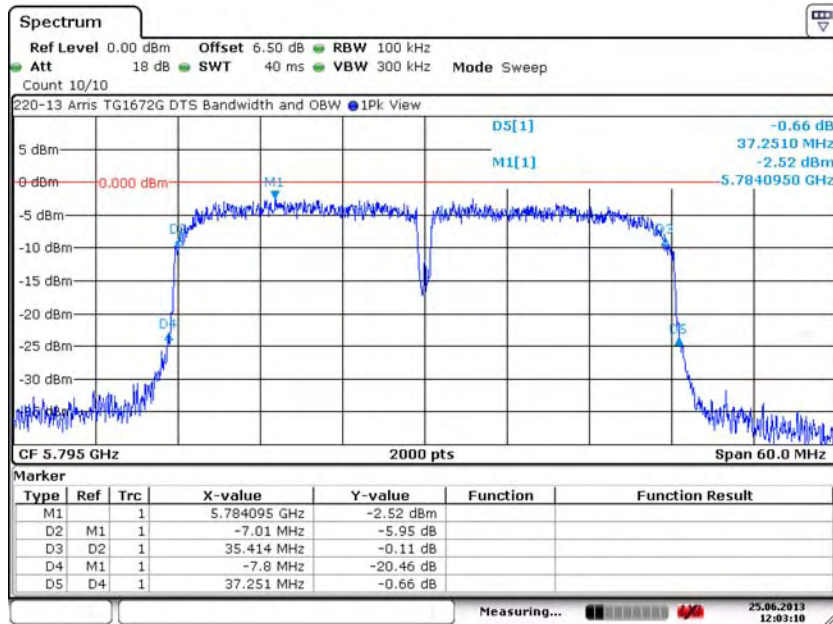

Date: 25.JUN.2013 12:03:09

7. Measurement Data (continued)

7.2. Minimum DTS and Occupied Bandwidths (15.247 (a) (2)) (continued)

7.2.59. HT40: High Channel – 159, J5001

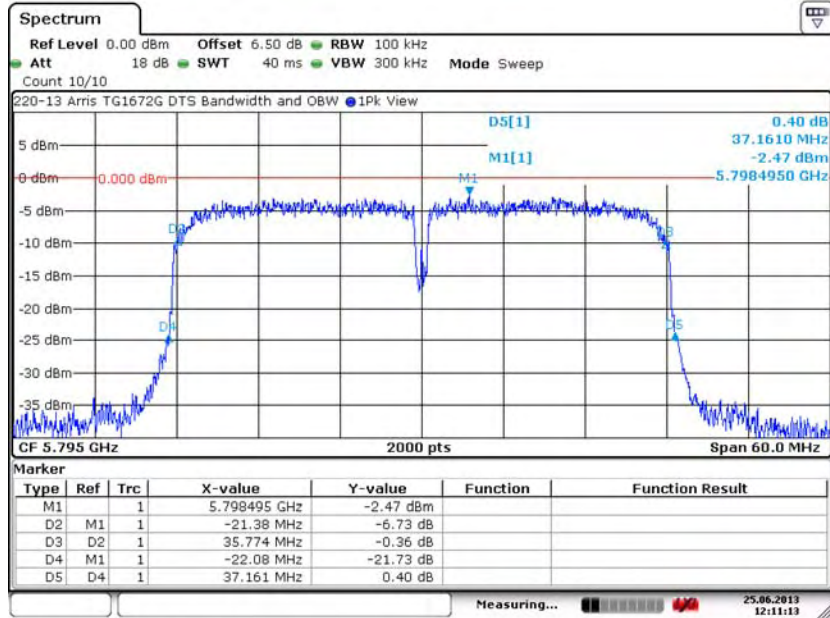

Date: 25.JUN.2013 12:11:12

7.2.60. HT40: High Channel – 159, J5002

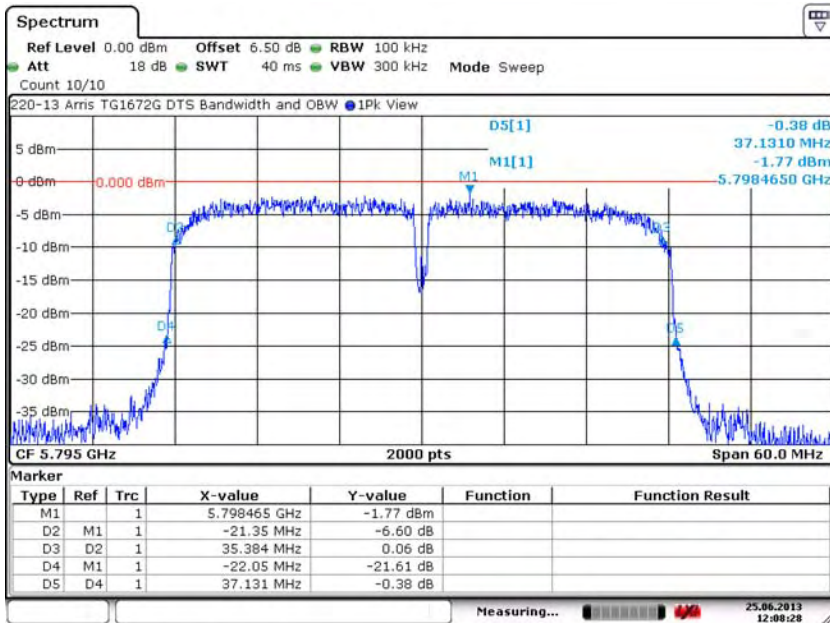

Date: 25.JUN.2013 12:08:28

7. Measurement Data (continued)

7.3. 99% Bandwidth (RSS 210)

Requirement: When an occupied bandwidth value is not specified in the applicable RSS, the transmitted signal bandwidth to be reported is to be its 99% emission bandwidth, as calculated or measured.

The resolution bandwidth shall be set to as close to 1% of the selected span as is possible without being below 1%. The video bandwidth shall be set to 3 times the resolution bandwidth.

Procedure: This test was performed utilizing the automated 99% bandwidth function of the spectrum analyzer.

Conclusion: The device under test meets the required 99% bandwidth.

Measured results in 2400 to 2483.5 MHz Band

802.11b Mode Channel	Frequency (MHz)	99% Power Bandwidth (MHz)		
		J2400	J2401	J2402
Low	2412	14.910	14.820	15.010
Middle	2437	14.895	14.820	14.985
High	2462	14.895	14.820	14.970

802.11g Mode Channel	Frequency (MHz)	99% Power Bandwidth (MHz)		
		J2400	J2401	J2402
Low	2412	16.500	16.515	16.455
Middle	2437	16.500	16.515	16.470
High	2462	16.515	16.515	16.470

HT20 Mode Channel	Frequency (MHz)	99% Power Bandwidth (MHz)		
		J2400	J2401	J2402
Low	2412	17.340	17.340	17.310
Middle	2437	17.340	17.355	17.295
High	2462	17.340	17.340	17.295

HT40 Mode Channel	Frequency (MHz)	99% Power Bandwidth (MHz)		
		J2400	J2401	J2402
Low	2422	35.52	35.49	35.43
Middle	2437	35.52	35.49	35.40
High	2452	35.55	35.46	35.55

7. Measurement Data

7.3. 99% Bandwidth (RSS 210) (continued)

7.3.1. 802.11b: Low Channel – 1, J2400

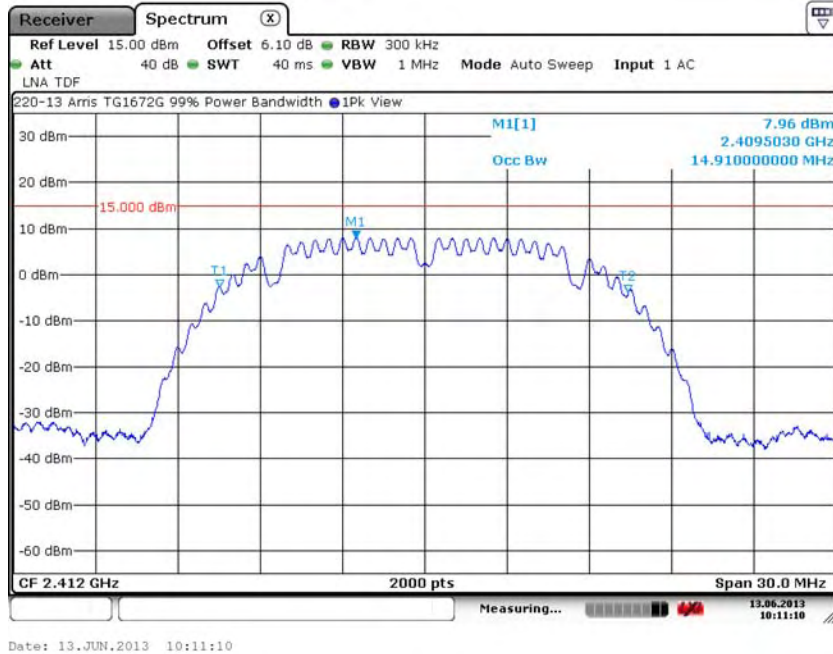

7.3.2. 802.11b: Low Channel – 1, J2401

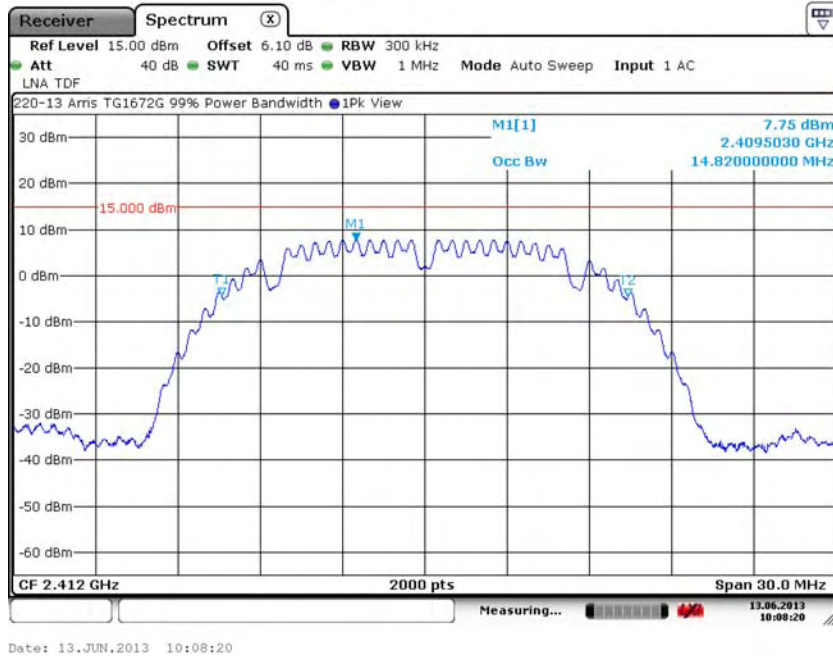

7. Measurement Data

7.3. 99% Bandwidth (RSS 210) (continued)

7.3.3. 802.11b: Low Channel – 1, J2402

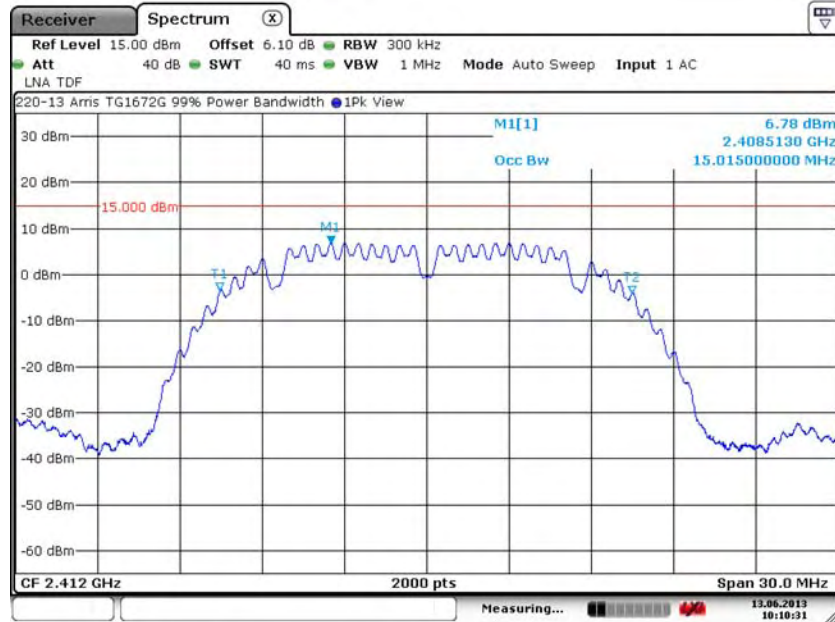

Date: 13. JUN. 2013 10:10:31

7.3.4. 802.11b: Middle Channel – 6, J2400

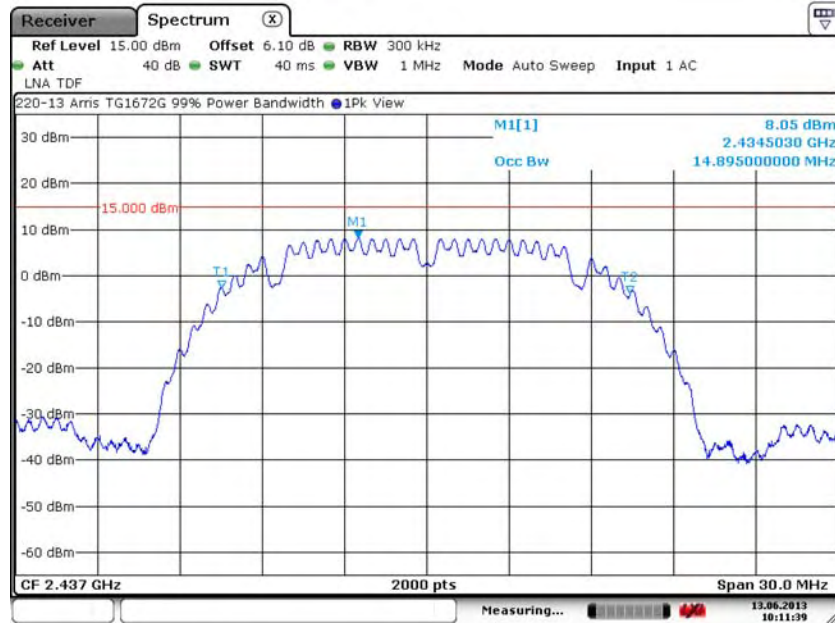

Date: 13. JUN. 2013 10:11:39

7. Measurement Data

7.3. 99% Bandwidth (RSS 210) (continued)

7.3.5. 802.11b: Middle Channel – 6, J2401

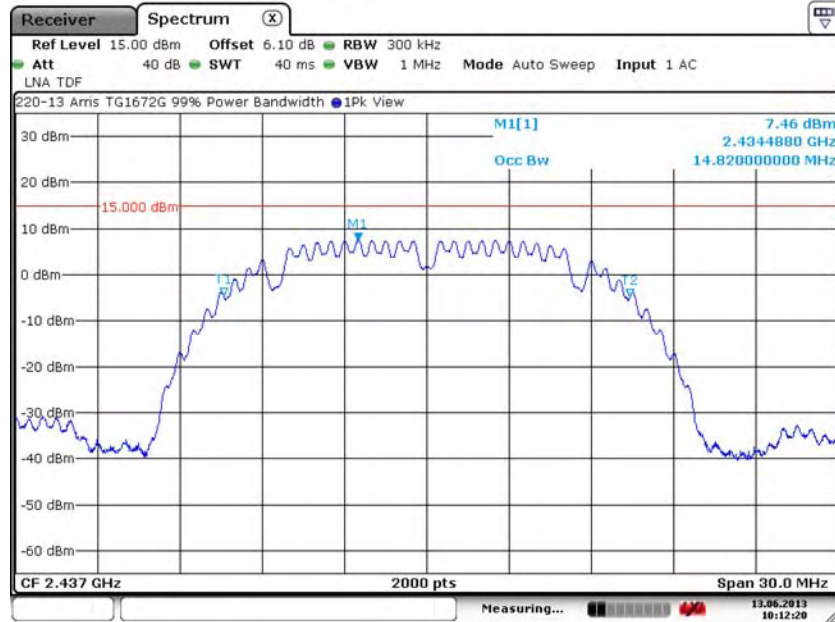

Date: 13. JUN. 2013 10:12:21

7.3.6. 802.11b: Middle Channel – 6, J2402

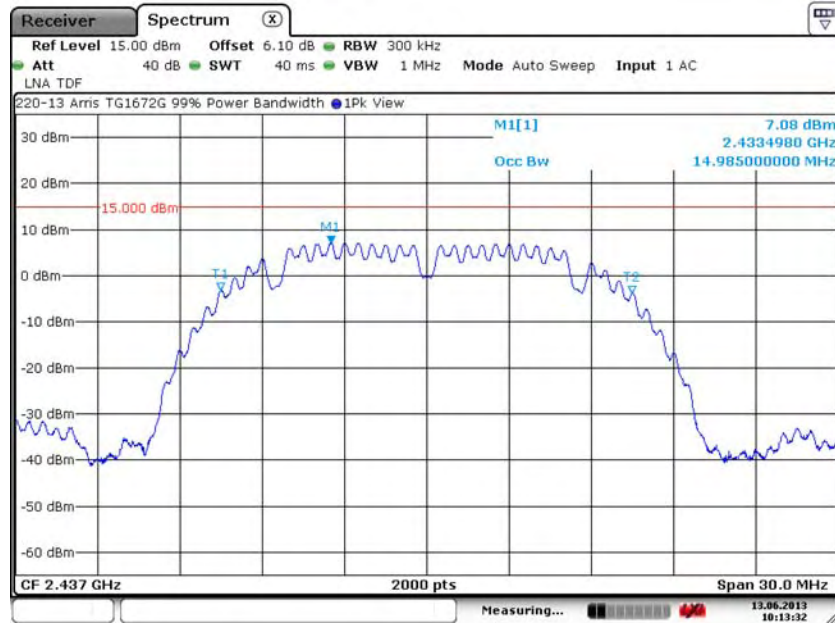

Date: 13. JUN. 2013 10:13:31

7. Measurement Data

7.3. 99% Bandwidth (RSS 210) (continued)

7.3.7. 802.11b: High Channel – 11, J2400

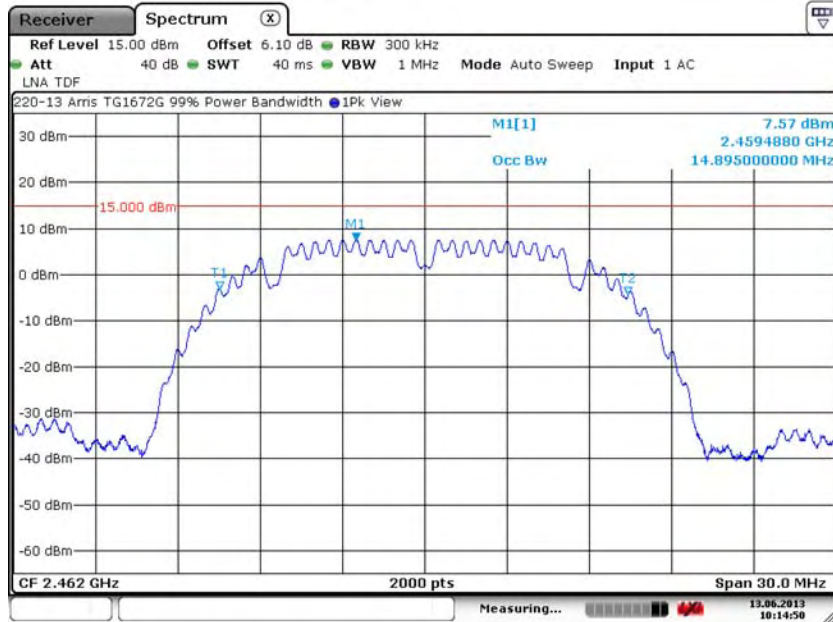

Date: 13. JUN. 2013 10:14:49

7.3.8. 802.11b: High Channel – 11, J2401

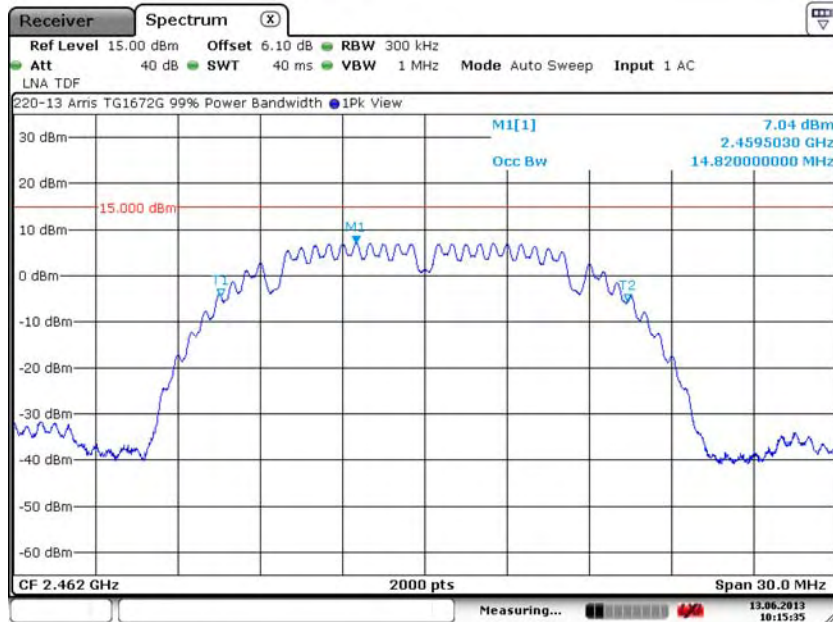

Date: 13. JUN. 2013 10:15:35

7. Measurement Data

7.3. 99% Bandwidth (RSS 210) (continued)

7.3.9. 802.11b: High Channel – 11, J2402

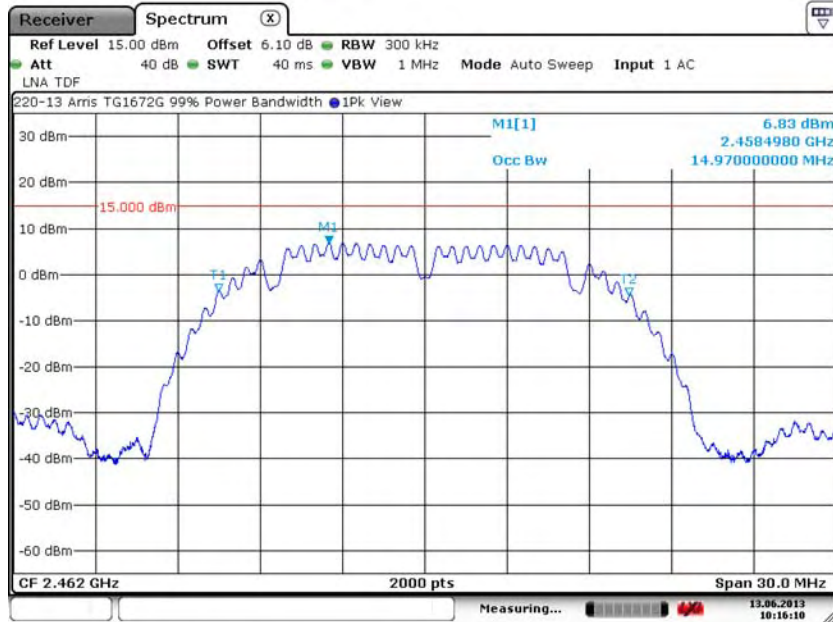

Date: 13. JUN. 2013 10:16:11

7.3.10. 802.11g: Low Channel – 1, J2400

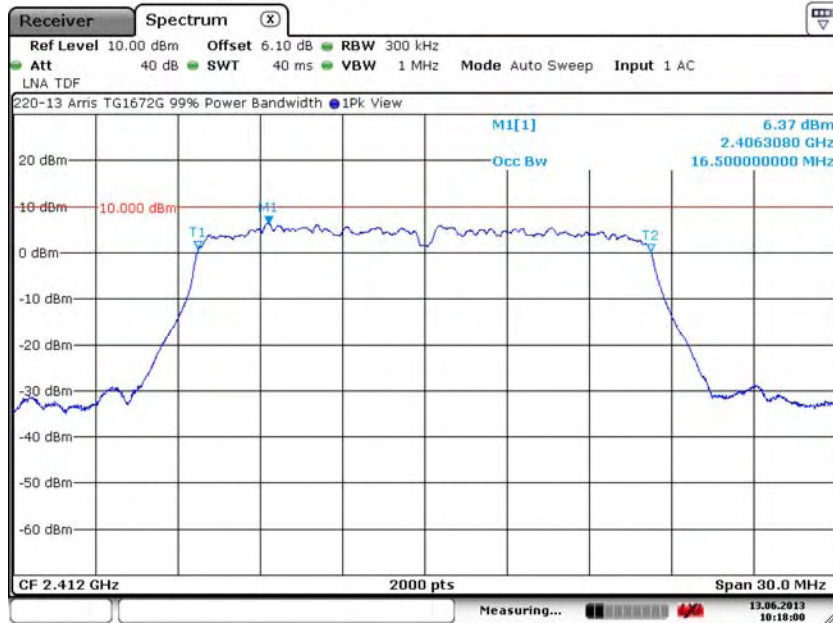

Date: 13. JUN. 2013 10:18:00

7. Measurement Data

7.3. 99% Bandwidth (RSS 210) (continued)

7.3.11. 802.11g: Low Channel – 1, J2401

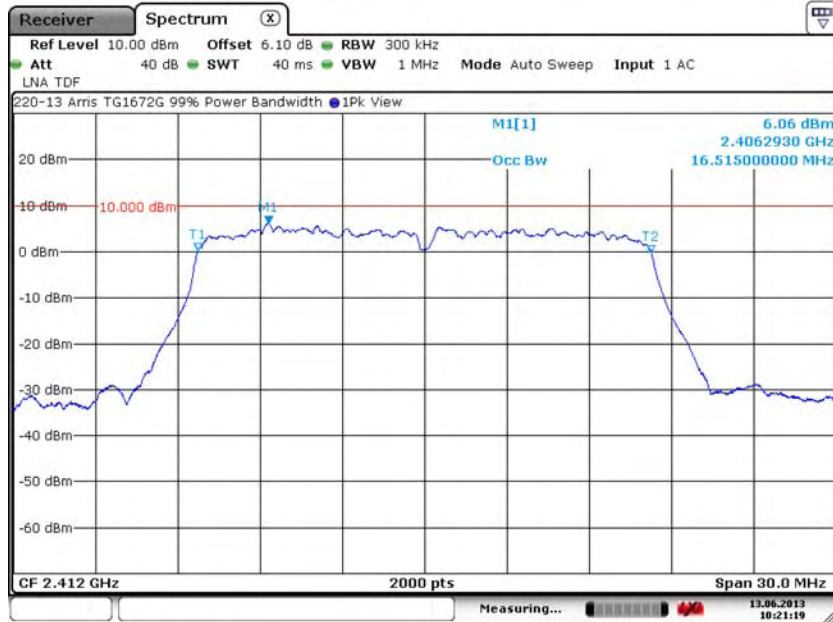

Date: 13. JUN. 2013 10:21:19

7.3.12. 802.11g: Low Channel – 1, J2402

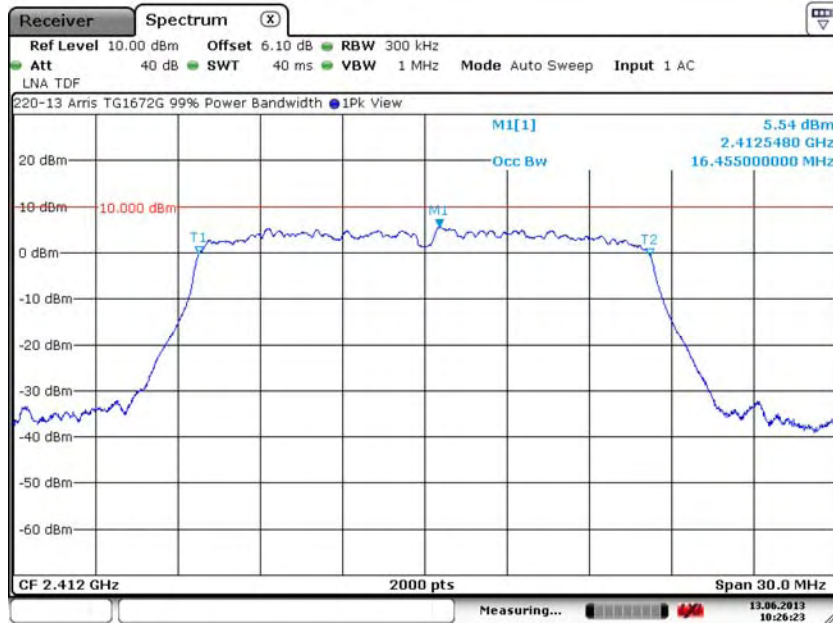

Date: 13. JUN. 2013 10:26:23

7. Measurement Data

7.3. 99% Bandwidth (RSS 210) (continued)

7.3.13. 802.11g: Middle Channel – 6, J2400



7.3.14. 802.11g: Middle Channel – 6, J2401



7. Measurement Data

7.3. 99% Bandwidth (RSS 210) (continued)

7.3.15. 802.11g: Middle Channel – 6, J2402

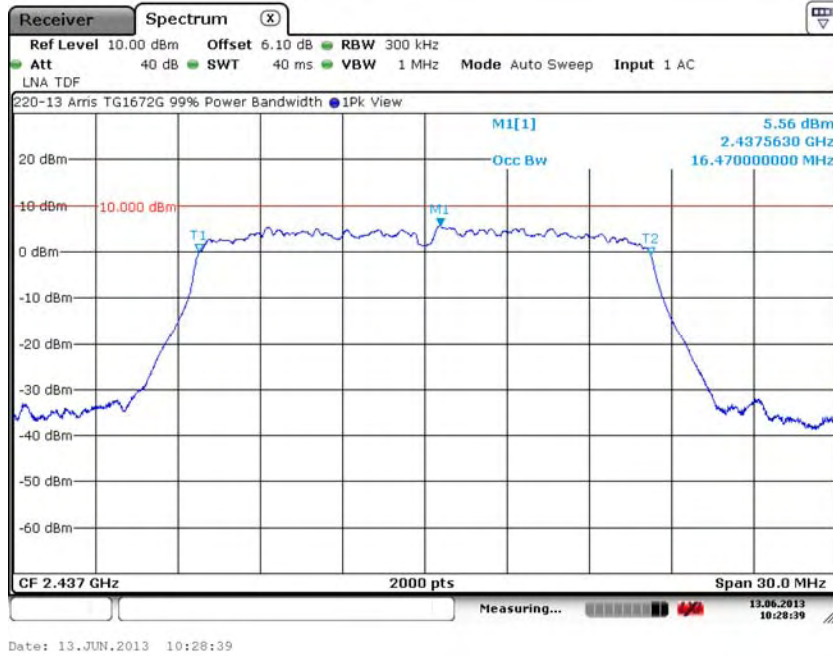

7.3.16. 802.11g: High Channel – 11, J2400

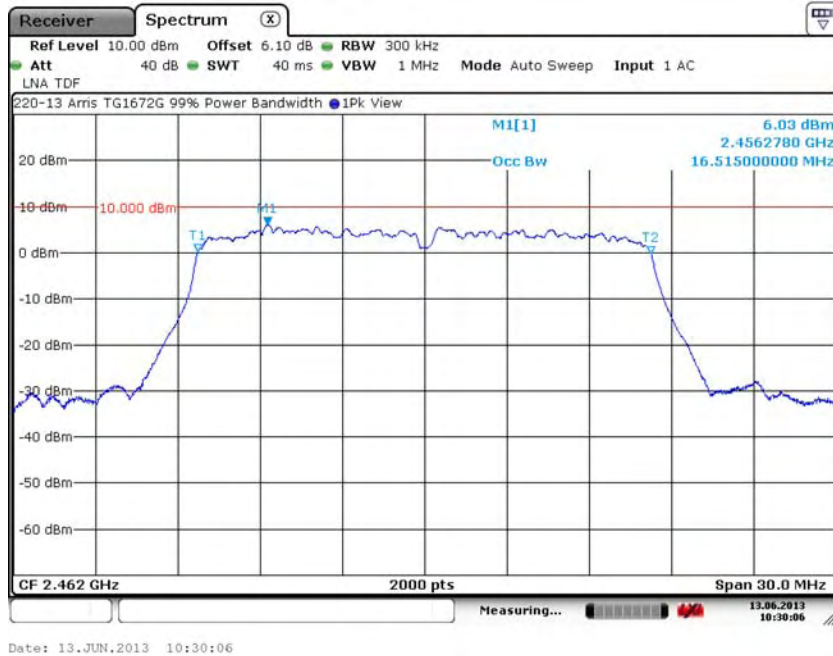

7. Measurement Data

7.3. 99% Bandwidth (RSS 210) (continued)

7.3.17. 802.11g: High Channel – 11, J2401



7.3.18. 802.11g: High Channel – 11, J2402

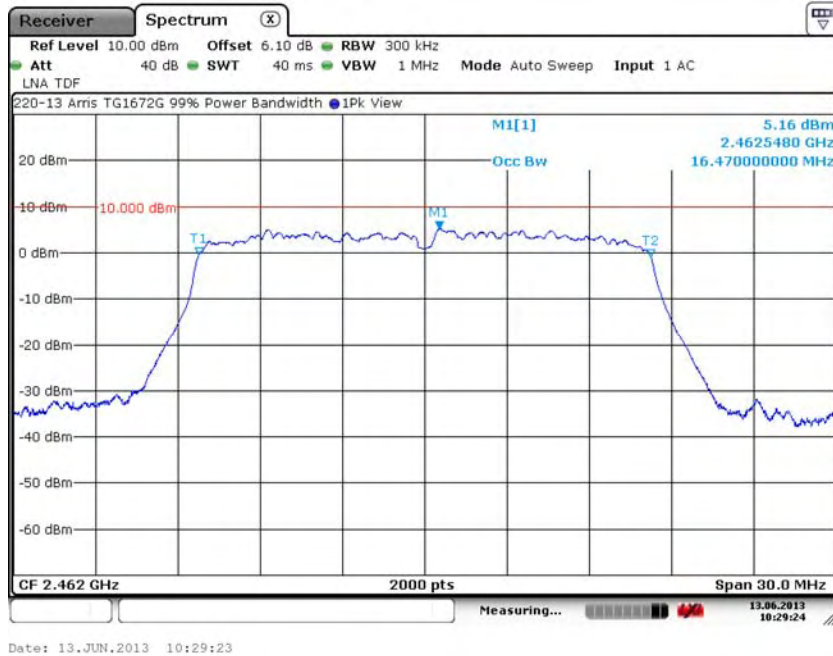

7. Measurement Data

7.3. 99% Bandwidth (RSS 210) (continued)

7.3.19. HT20: Low Channel – 1, J2400

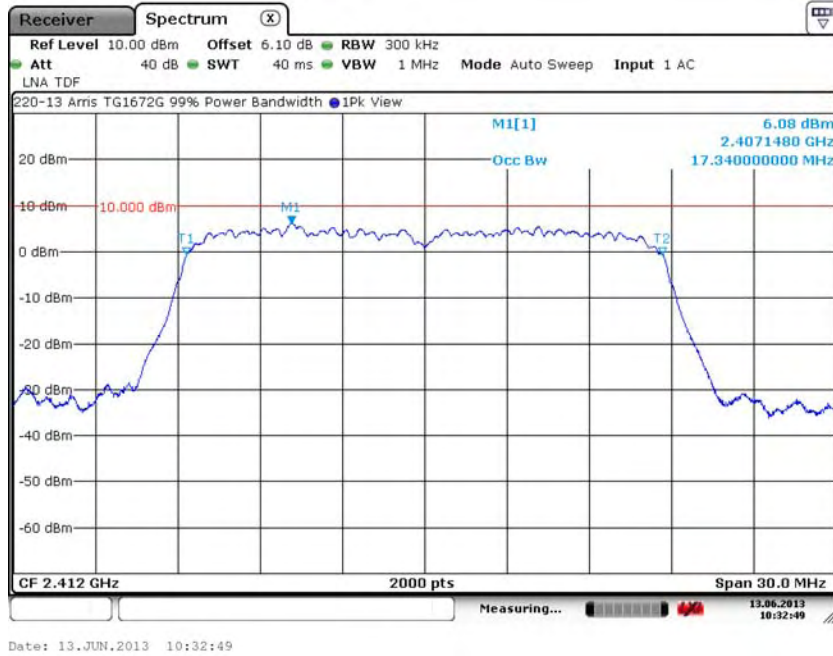

7.3.20. HT20: Low Channel – 1, J2401

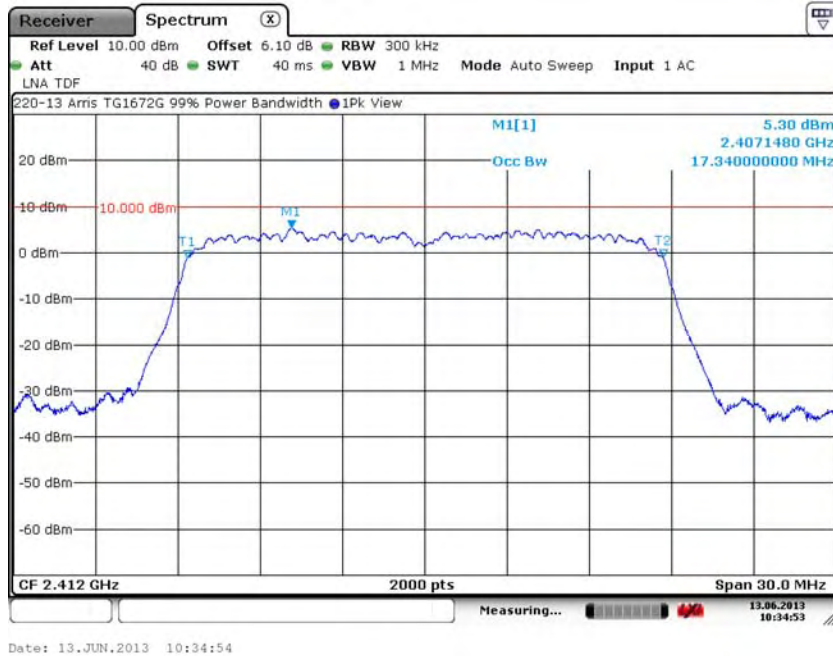

7. Measurement Data

7.3. 99% Bandwidth (RSS 210) (continued)

7.3.21. HT20: Low Channel – 1, J2402



7.3.22. HT20: Mid Channel – 6, J2400



7. Measurement Data

7.3. 99% Bandwidth (RSS 210) (continued)

7.3.23. HT20: Mid Channel – 6, J2401

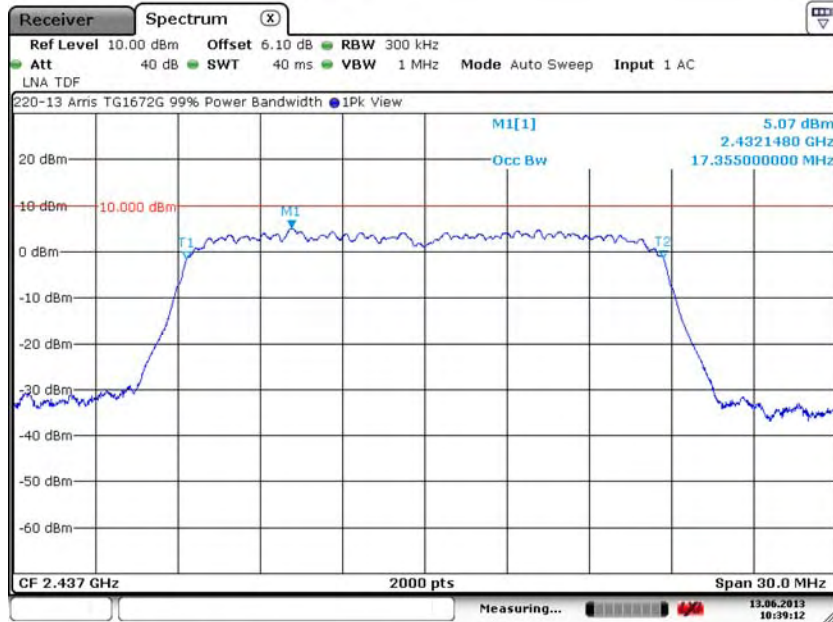

Date: 13. JUN. 2013 10:39:11

7.3.24. HT20: Mid Channel – 6, J2402

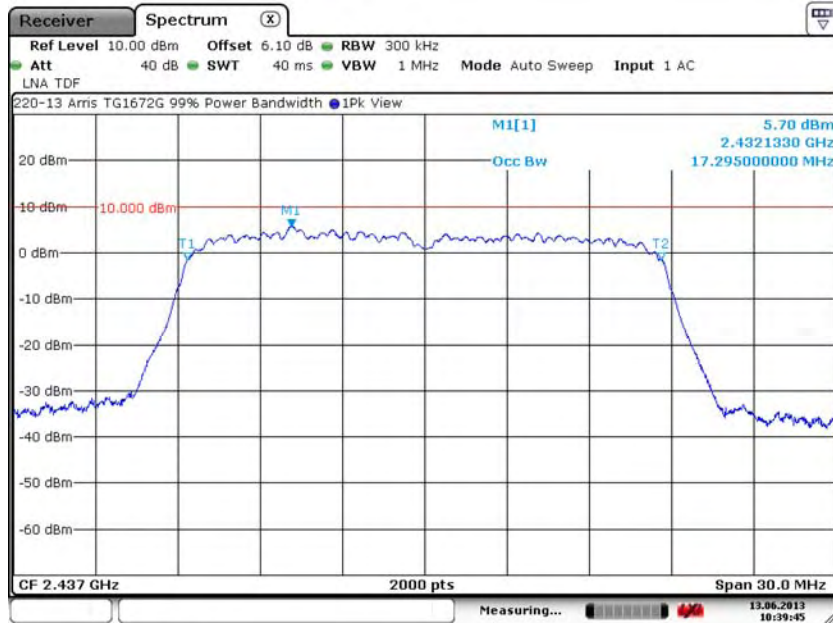

Date: 13. JUN. 2013 10:39:45

7. Measurement Data

7.3. 99% Bandwidth (RSS 210) (continued)

7.3.25. HT20: High Channel – 11, J2400



7.3.26. HT20: High Channel – 11, J2401

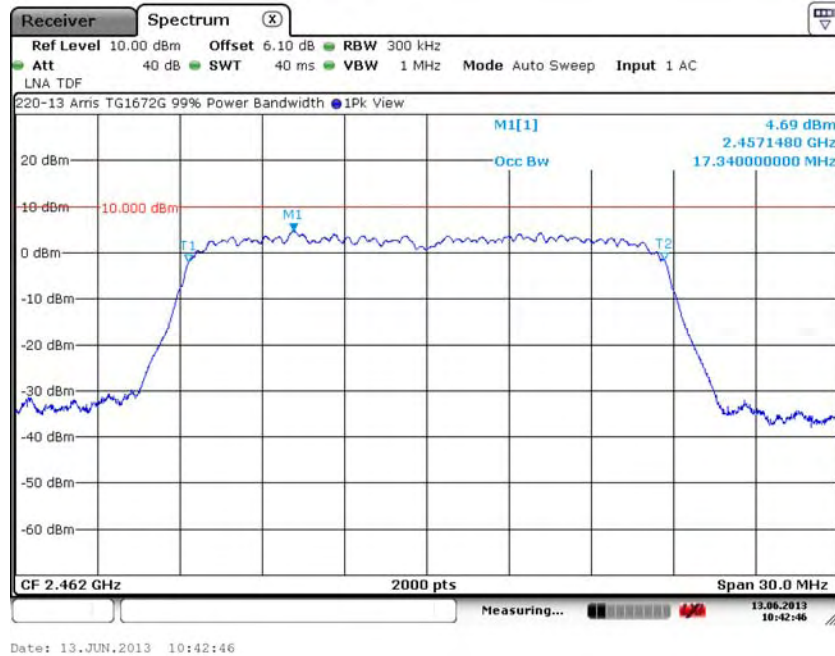

7. Measurement Data

7.3. 99% Bandwidth (RSS 210) (continued)

7.3.27. HT20: High Channel – 11, J2402

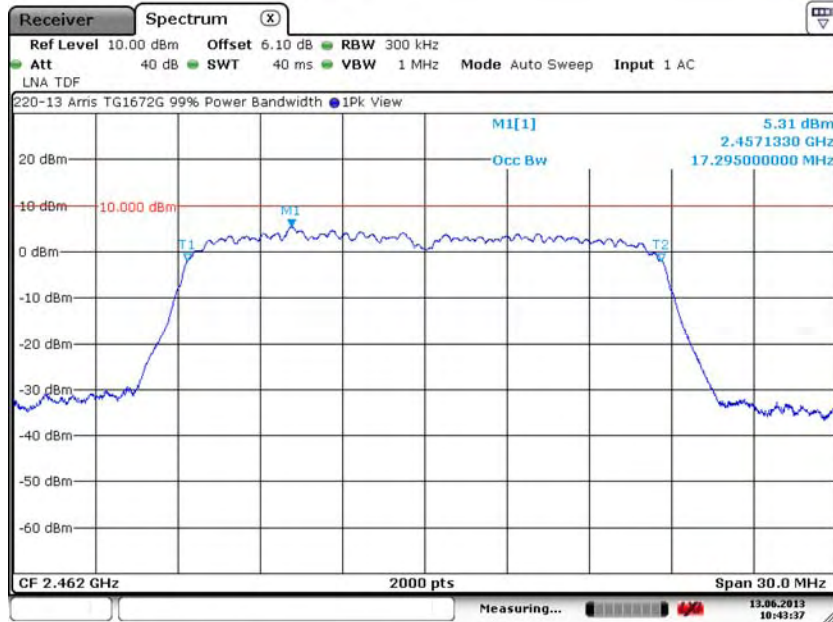

Date: 13. JUN. 2013 10:43:36

7.3.28. HT40: Low Channel – 3, J2400



Date: 13. JUN. 2013 10:52:19

7. Measurement Data

7.3. 99% Bandwidth (RSS 210) (continued)

7.3.29. HT40: Low Channel – 3, J2401



7.3.30. HT40: Low Channel – 3, J2402



7. Measurement Data

7.3. 99% Bandwidth (RSS 210) (continued)

7.3.31. HT40: Mid Channel – 6, J2400



Date: 13. JUN. 2013 10:55:22

7.3.32. HT40: Mid Channel – 6, J2401



Date: 13. JUN. 2013 10:56:27

7. Measurement Data

7.3. 99% Bandwidth (RSS 210) (continued)

7.3.33. HT40: Mid Channel – 6, J2402



7.3.34. HT40: High Channel – 9, J2400



7. Measurement Data

7.3. 99% Bandwidth (RSS 210) (continued)

7.3.35. HT40: High Channel – 9, J2401

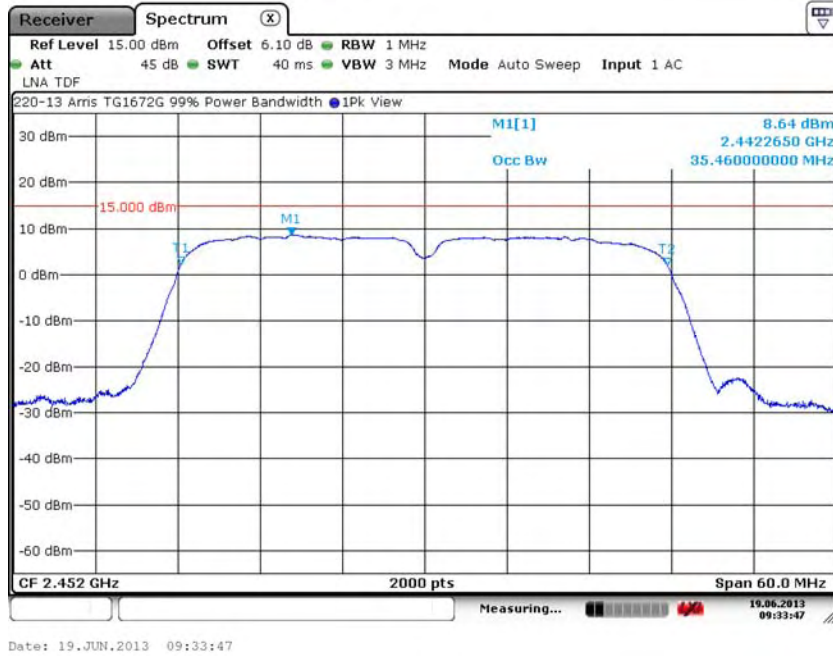

7.3.36. HT40: High Channel – 9, J2402



7. Measurement Data (continued)

7.3. 99% Bandwidth (RSS 210) (cont)

Requirement: When an occupied bandwidth value is not specified in the applicable RSS, the transmitted signal bandwidth to be reported is to be its 99% emission bandwidth, as calculated or measured. The resolution bandwidth shall be set to as close to 1% of the selected span as is possible without being below 1%. The video bandwidth shall be set to 3 times the resolution bandwidth.

Procedure: This test was performed utilizing the automated 99% bandwidth function of the spectrum analyzer.

Conclusion: The device under test meets the required 99% bandwidth.

Measured results in 5725 to 5850 MHz Band

802.11a Mode Channel	Frequency (MHz)	99% Power Bandwidth (MHz)		
		J5000	J5001	J5002
Low	5745	16.530	16.650	16.635
Middle	5785	16.785	16.785	16.635
High	5825	16.515	16.725	16.500

HT20 Mode Channel	Frequency (MHz)	99% Power Bandwidth (MHz)		
		J5000	J5001	J5002
Low	5745	17.475	17.355	17.385
Middle	5785	17.235	17.385	17.490
High	5825	17.505	17.295	17.460

HT40 Mode Channel	Frequency (MHz)	99% Power Bandwidth (MHz)		
		J5000	J5001	J5002
Low	5755	35.46	35.61	35.64
High	5795	35.58	35.52	35.58

7. Measurement Data (continued)

7.3. 99% Bandwidth (RSS 210) (continued)

7.3.37. 802.11a: Low Channel – 149, J5000



Date: 13. JUN. 2013 11:43:36

7.3.38. 802.11a: Low Channel – 149, J5001



Date: 13. JUN. 2013 11:49:08

7. Measurement Data (continued)

7.3. 99% Bandwidth (RSS 210) (continued)

7.3.39. 802.11a: Low Channel – 149, J5002

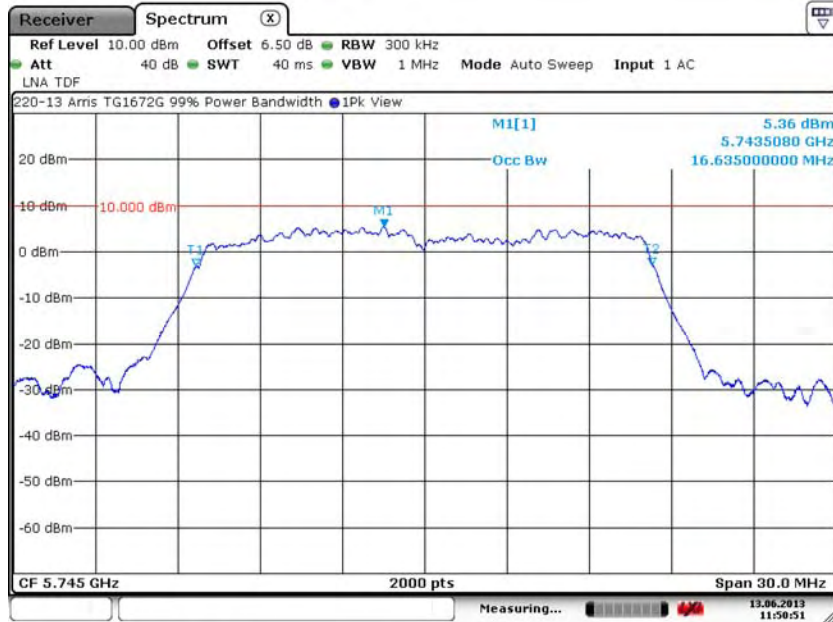

Date: 13. JUN. 2013 11:50:51

7.3.40. 802.11a: Middle Channel – 157, J5000

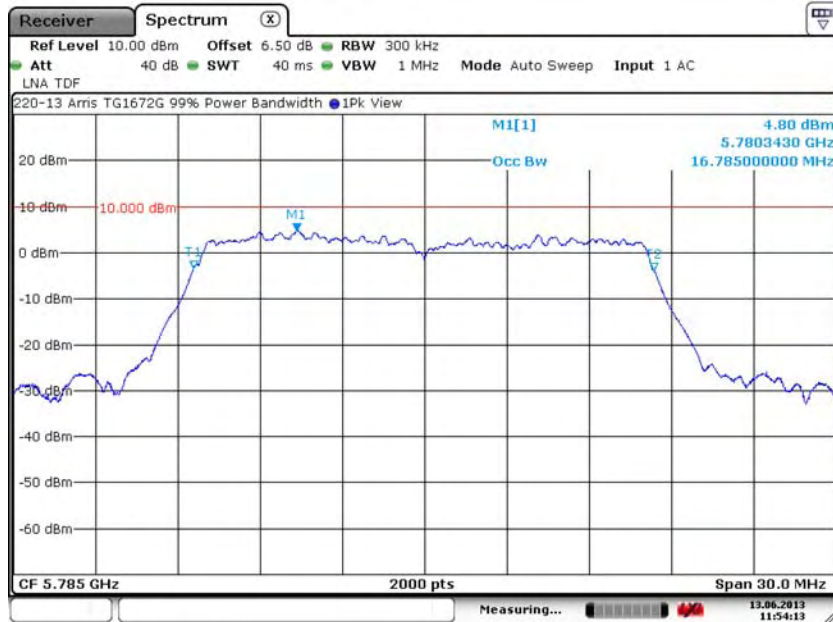

Date: 13. JUN. 2013 11:54:14

7. Measurement Data (continued)

7.3. 99% Bandwidth (RSS 210) (continued)

7.3.41. 802.11a: Middle Channel – 157, J5001



Date: 13. JUN. 2013 11:54:14

7.3.42. 802.11a: Middle Channel – 157, J5002



Date: 13. JUN. 2013 12:02:26