

FCC Test Report

Report No.: RF150122E07A-1

FCC ID: UIDSBG6900

Test Model: SBG6900-AC

Received Date: Jan. 22, 2015

Test Date: Feb. 26 to Mar. 24, 2015

Issued Date: July 23, 2015

Applicant: ARRIS Group, Inc.

Address: 3871 Lakefield Drive Suite 300 Suwanee, GA30024

Issued By: Bureau Veritas Consumer Products Services (H.K.) Ltd., Taoyuan Branch
Hsin Chu Laboratory

Lab Address: No. 81-1, Lu Liao Keng, 9th Ling, Wu Lung Tsuen, Chiung Lin Hsiang, Hsin
Chu Hsien 307, Taiwan R.O.C.

Test Location (1): No. 81-1, Lu Liao Keng, 9th Ling, Wu Lung Tsuen, Chiung Lin Hsiang, Hsin
Chu Hsien 307, Taiwan R.O.C.

Test Location (2): No. 49, Ln. 206, Wende Rd., Shangshan Tsuen, Chiung Lin Hsiang, Hsin
Chu Hsien 307, Taiwan R.O.C.



This report is for your exclusive use. Any copying or replication of this report to or for any other person or entity, or use of our name or trademark, is permitted only with our prior written permission. This report sets forth our findings solely with respect to the test samples identified herein. The results set forth in this report are not indicative or representative of the quality or characteristics of the lot from which a test sample was taken or any similar or identical product unless specifically and expressly noted. Our report includes all of the tests requested by you and the results thereof based upon the information that you provided to us. You have 60 days from date of issuance of this report to notify us of any material error or omission caused by our negligence, provided, however, that such notice shall be in writing and shall specifically address the issue you wish to raise. A failure to raise such issue within the prescribed time shall constitute your unqualified acceptance of the completeness of this report, the tests conducted and the correctness of the report contents. Unless specific mention, the uncertainty of measurement has been explicitly taken into account to declare the compliance or non-compliance to the specification. The report must not be used by the client to claim product certification, approval, or endorsement by TAF or any government agencies.

Table of Contents

Release Control Record	4
1 Certificate of Conformity	5
2 Summary of Test Results	6
2.1 Measurement Uncertainty	6
2.2 Modification Record	6
3 General Information	7
3.1 General Description of EUT (DFS Band)	7
3.2 Description of Test Modes	10
3.2.1 Test Mode Applicability and Tested Channel Detail	11
3.3 Duty Cycle of Test Signal	14
3.4 Description of Support Units	15
3.4.1 Configuration of System under Test	16
3.5 General Description of Applied Standards	17
4 Test Types and Results	18
4.1 Radiated Emission and Bandedge Measurement	18
4.1.1 Limits of Radiated Emission and Bandedge Measurement	18
4.1.2 Test Instruments	19
4.1.3 Test Procedures	21
4.1.4 Deviation from Test Standard	21
4.1.5 Test Setup	22
4.1.6 EUT Operating Conditions	22
4.1.7 Test Results	23
4.2 Conducted Emission Measurement	65
4.2.1 Limits of Conducted Emission Measurement	65
4.2.2 Test Instruments	65
4.2.3 Test Procedures	66
4.2.4 Deviation from Test Standard	66
4.2.5 Test Setup	66
4.2.6 EUT Operating Conditions	66
4.2.7 Test Results	67
4.3 Transmit Power Measurement	69
4.3.1 Limits of Transmit Power Measurement	69
4.3.2 Test Setup	70
4.3.3 Test Instruments	70
4.3.4 Test Procedure	71
4.3.5 Deviation from Test Standard	71
4.3.6 EUT Operating Conditions	71
4.3.7 Test Result	72
4.4 Peak Power Spectral Density Measurement	83
4.4.1 Limits of Peak Power Spectral Density Measurement	83
4.4.2 Test Setup	83
4.4.3 Test Instruments	83
4.4.4 Test Procedures	84
4.4.5 Deviation from Test Standard	84
4.4.6 EUT Operating Conditions	84
4.4.7 Test Results	85
4.5 Frequency Stability	95
4.5.1 Limits of Frequency Stability Measurement	95
4.5.2 Test Setup	95
4.5.3 Test Instruments	95
4.5.4 Test Procedure	96
4.5.5 Deviation from Test Standard	96
4.5.6 EUT Operating Condition	96



4.5.7 Test Results.....	97
4.6 6dB Bandwidth Measurement	98
4.6.1 Limits of 6dB Bandwidth Measurement.....	98
4.6.2 Test Setup	98
4.6.3 Test Instruments.....	98
4.6.4 Test Procedure	98
4.6.5 Deviation from Test Standard.....	98
4.6.6 EUT Operating Condition	98
4.6.7 Test Results.....	99
5 Pictures of Test Arrangements	103
Appendix – Information on the Testing Laboratories.....	104



A D T

Release Control Record

Issue No.	Description	Date Issued
RF150122E07A-1	Original release.	July 23, 2015



A D T

1 Certificate of Conformity

Product: Wireless Cable Modem & Router

Brand: ARRIS

Test Model: SBG6900-AC

Sample Status: ENGINEERING SAMPLE

Applicant: ARRIS Group, Inc.

Test Date: Feb. 26 to Mar. 24, 2015

Standards: 47 CFR FCC Part 15, Subpart E (Section 15.407)
ANSI C63.10:2009

The above equipment has been tested by **Bureau Veritas Consumer Products Services (H.K.) Ltd., Taoyuan Branch**, and found compliance with the requirement of the above standards. The test record, data evaluation & Equipment Under Test (EUT) configurations represented herein are true and accurate accounts of the measurements of the sample's EMC characteristics under the conditions specified in this report.

Prepared by :  , **Date:** July 23, 2015
Lori Chung / Specialist

Approved by :  , **Date:** July 23, 2015
May Chen / Manager

2 Summary of Test Results

47 CFR FCC Part 15, Subpart E (SECTION 15.407 Under New Rule)			
FCC Clause	Test Item	Result	Remarks
15.407(b)(6)	AC Power Conducted Emissions	PASS	Meet the requirement of limit. Minimum passing margin is -16.69dB at 0.42687MHz.
15.407(b)(1/2/3/4/6)	Radiated Emissions & Band Edge Measurement	PASS	Meet the requirement of limit. Minimum passing margin is -0.1dB at 5424.00MHz, 5441.00MHz, 5470.00MHz, 5350.00MHz, 5850.00MHz
15.407(a)(1/2/3)	Max Average Transmit Power Transmit Power	PASS	Meet the requirement of limit.
15.407(a)(1/2/3)	Peak Power Spectral Density	PASS	Meet the requirement of limit.
15.407(e)	6dB bandwidth	PASS	Meet the requirement of limit. (U-NII-3 Band only)
15.407(g)	Frequency Stability	PASS	Meet the requirement of limit.
15.203	Antenna Requirement	PASS	Antenna connector is i-pex(MHF) not a standard connector.

- NOTE:** 1. This report is prepared for FCC class II permissive change. (Add DFS band: 5250~5350MHz & 5470~5725MHz).
2. The DFS report was recorded in another test report.

2.1 Measurement Uncertainty

Where relevant, the following measurement uncertainty levels have been estimated for tests performed on the EUT:

The listed uncertainties are the worst case uncertainty for the entire range of measurement. Please note that the uncertainty values are provided for informational purposes only and are not used in determining the PASS/FAIL results.

Measurement	Frequency	Expanded Uncertainty (k=2) (±)
Conducted Emissions at mains ports	150kHz ~ 30MHz	2.86 dB
Radiated Emissions up to 1 GHz	30MHz ~ 1GHz	5.43 dB
Radiated Emissions above 1 GHz	1GHz ~ 6GHz	3.65 dB
	6GHz ~ 18GHz	3.88 dB
	18GHz ~ 40GHz	4.11 dB

2.2 Modification Record

There were no modifications required for compliance.

3 General Information

3.1 General Description of EUT (DFS Band)

Product	Wireless Cable Modem & Router
Brand	ARRIS
Test Model	SBG6900-AC
Status of EUT	ENGINEERING SAMPLE
Power Supply Rating	100~240Vac, 50/60Hz
Modulation Type	64QAM, 16QAM, QPSK, BPSK for OFDM 256QAM for OFDM in 11ac mode
Modulation Technology	OFDM
Transfer Rate	802.11a: up to 54Mbps 802.11n: up to 450Mbps 802.11ac: up to 1300Mbps
Operating Frequency	5.26 ~ 5.32GHz, 5.5~5.72GHz
Number of Channel	16 for 802.11a, 802.11n (HT20), 802.11ac (VHT20) 8 for 802.11n (HT40), 802.11ac (VHT40) 4 for 802.11ac (VHT80)
Output Power	CDD Mode: 802.11a: 121.032mW 802.11ac (VHT20): 122.175mW 802.11ac (VHT40): 241.715mW 802.11ac (VHT80): 239.322mW Beamforming Mode: 802.11ac (VHT20): 122.175mW 802.11ac (VHT40): 121.234mW 802.11ac (VHT80): 121.084mW
Antenna Type	Refer to Note
Antenna Connector	Refer to Note
Accessory Device	NA
Data Cable Supplied	NA

Note:

1. This report is prepared for FCC class II permissive change. The difference compared with the Report No.: RF150122E07-1 design is as the following:

- ◆ Add DFS band <5250~5350MHz & 5470~5725MHz>

2. According to above condition, all test items need to be performed. And all data were verified to meet the requirements.

3. The emission of the simultaneous operation (2.4GHz & 5GHz) has been evaluated and no non-compliance was found.

4. The antennas provided to the EUT, please refer to the following table:

2.4GHz								
Antenna No.	PCB Chain No.	Brand	Model	Ant. Gain(dBi) <Including cable loss>	Frequency range (GHz to GHz)	Ant. Type	Connector Type	Cable Length (mm)
361.00624.005	1	FIT	FX02A04-0G-EF	3.72	2.4~2.4835	PCB	i-pex(MHF)	185
361.00625.005	2	FIT	FX02A05-0G-EF	4.59	2.4~2.4835	PCB	i-pex(MHF)	111
361.00626.005	0	FIT	FX02A06-0G-EF	4.2	2.4~2.4835	PCB	i-pex(MHF)	210
5GHz								
Antenna No.	PCB Chain No.	Brand	Model	Ant. Gain(dBi) <Including cable loss>	Frequency range (GHz to GHz)	Ant. Type	Connector Type	Cable Length (mm)
361.00628.005	1	FIT	FX02A07-0G-EF	5.59	5.15~5.85	PCB	i-pex(MHF)	120
361.00629.005	2	FIT	FX02A08-0G-EF	3.42	5.15~5.85	PCB	i-pex(MHF)	190
361.00630.005	0	FIT	FX02A10-0G-EF	3.88	5.15~5.85	PCB	i-pex(MHF)	255

5. The EUT must be supplied with an internal power supply as below table :

Brand	Model No.	Spec.
DVE	DSO-36PFE-12 2 120300	AC Input: 100~240V, 1.3A, 50/60Hz DC Output: 12V, 3A

6. The EUT incorporates a MIMO function.

2.4GHz Band			
MODULATION MODE	DATA RATE (MCS)	TX & RX CONFIGURATION	
802.11b	1 ~ 11Mbps	3TX	3RX
802.11g	6 ~ 54Mbps	3TX	3RX
802.11n (HT20)	MCS 0~7	3TX	3RX
	MCS 8~15	3TX	3RX
	MCS 16~23	3TX	3RX
802.11n (HT40)	MCS 0~7	3TX	3RX
	MCS 8~15	3TX	3RX
	MCS 16~23	3TX	3RX
VHT20	MCS 0~8, Nss=1	3TX	3RX
	MCS 0~8, Nss=2	3TX	3RX
	MCS 0~9, Nss=3	3TX	3RX
VHT40	MCS 0~9, Nss=1	3TX	3RX
	MCS 0~9, Nss=2	3TX	3RX
	MCS 0~9, Nss=3	3TX	3RX
5GHz Band			
MODULATION MODE	DATA RATE (MCS)	TX & RX CONFIGURATION	
802.11a	6 ~ 54Mbps	3TX	3RX
802.11n (HT20)	MCS 0~7	3TX	3RX
	MCS 8~15	3TX	3RX
	MCS 16~23	3TX	3RX
802.11n (HT40)	MCS 0~7	3TX	3RX
	MCS 8~15	3TX	3RX
	MCS 16~23	3TX	3RX
802.11ac (VHT20)	MCS 0~8, Nss=1	3TX	3RX
	MCS 0~8, Nss=2	3TX	3RX
	MCS 0~9, Nss=3	3TX	3RX
802.11ac (VHT40)	MCS 0~9, Nss=1	3TX	3RX
	MCS 0~9, Nss=2	3TX	3RX
	MCS 0~9, Nss=3	3TX	3RX
802.11ac (VHT80)	MCS 0~9, Nss=1	3TX	3RX
	MCS 0~9, Nss=2	3TX	3RX
	MCS 0~9, Nss=3	3TX	3RX

Note: The modulation and bandwidth are similar for 802.11n mode for 20MHz (40MHz) and 802.11ac mode for 20MHz (40MHz), therefore investigated worst case to representative mode in test report. (Final test mode refer section 3.2.1)

7. The above EUT information was declared by the manufacturer and for more detailed features description, please refer to the manufacturer's specifications or User's Manual.

3.2 Description of Test Modes

FOR 5260 ~ 5320MHz

4 channels are provided for 802.11a, 802.11n (HT20), 802.11ac (VHT20):

Channel	Frequency	Channel	Frequency
52	5260 MHz	60	5300 MHz
56	5280 MHz	64	5320 MHz

2 channels are provided for 802.11n (HT40), 802.11ac (VHT40):

Channel	Frequency	Channel	Frequency
54	5270 MHz	62	5310 MHz

1 channel is provided for 802.11ac (VHT80):

Channel	Frequency
58	5290MHz

FOR 5500 ~ 5720MHz

12 channels are provided for 802.11a, 802.11n (HT20), 802.11ac (VHT20):

Channel	Frequency	Channel	Frequency
100	5500 MHz	124	5620 MHz
104	5520 MHz	128	5640 MHz
108	5540 MHz	132	5660 MHz
112	5560 MHz	136	5680 MHz
116	5580 MHz	140	5700 MHz
120	5600 MHz	144	5720 MHz

6 channels are provided for 802.11n (HT40), 802.11ac (VHT40):

Channel	Frequency	Channel	Frequency
102	5510 MHz	126	5630 MHz
110	5550 MHz	134	5670 MHz
118	5590 MHz	142	5710 MHz

3 channels are provided for 802.11ac (VHT80):

Channel	Frequency	Channel	Frequency
106	5530MHz	138	5690 MHz
122	5610 MHz		

3.2.1 Test Mode Applicability and Tested Channel Detail

EUT CONFIGURE MODE	APPLICABLE TO				DESCRIPTION
	RE≥1G	RE<1G	PLC	APCM	
-	√	√	√	√	-

Where **RE≥1G**: Radiated Emission above 1GHz **RE<1G**: Radiated Emission below 1GHz
PLC: Power Line Conducted Emission **APCM**: Antenna Port Conducted Measurement

Radiated Emission Test (Above 1GHz):

- Pre-Scan has been conducted to determine the worst-case mode from all possible combinations between available modulations, data rates and antenna ports (if EUT with antenna diversity architecture).
- Following channel(s) was (were) selected for the final test as listed below.

CDD MODE						
MODE	FREQ. BAND (MHz)	AVAILABLE CHANNEL	TESTED CHANNEL	MODULATION TECHNOLOGY	MODULATION TYPE	DATA RATE (Mbps)
802.11a	5260-5320	52 to 64	52, 60, 64	OFDM	BPSK	6
802.11ac (VHT20)		52 to 64	52, 60, 64	OFDM	BPSK	6.5
802.11ac (VHT40)		54 to 62	54, 62	OFDM	BPSK	13.5
802.11ac (VHT80)		58	58	OFDM	BPSK	29.3
802.11a	5500-5720	100 to 144	100, 120, 140, 144	OFDM	BPSK	6
802.11ac (VHT20)		100 to 144	100, 120, 140, 144	OFDM	BPSK	6.5
802.11ac (VHT40)		102 to 142	102, 118, 134, 142	OFDM	BPSK	13.5
802.11ac (VHT80)		106 to 138	106, 122, 138	OFDM	BPSK	29.3
Beamforming MODE						
MODE	FREQ. BAND (MHz)	AVAILABLE CHANNEL	TESTED CHANNEL	MODULATION TECHNOLOGY	MODULATION TYPE	DATA RATE (Mbps)
802.11ac (VHT20)	5260-5320	52 to 64	52, 60, 64	OFDM	BPSK	6.5
802.11ac (VHT40)		54 to 62	54, 62	OFDM	BPSK	13.5
802.11ac (VHT80)		58	58	OFDM	BPSK	29.3
802.11ac (VHT20)	5500-5720	100 to 144	100, 120, 140, 144	OFDM	BPSK	6.5
802.11ac (VHT40)		102 to 142	102, 118, 134, 142	OFDM	BPSK	13.5
802.11ac (VHT80)		106 to 138	106, 122, 138	OFDM	BPSK	29.3

Radiated Emission Test (Below 1GHz):

- Pre-Scan has been conducted to determine the worst-case mode from all possible combinations between available modulations, data rates and antenna ports (if EUT with antenna diversity architecture).
- Following channel(s) was (were) selected for the final test as listed below.

CDD MODE						
MODE	FREQ. BAND (MHz)	AVAILABLE CHANNEL	TESTED CHANNEL	MODULATION TECHNOLOGY	MODULATION TYPE	DATA RATE (Mbps)
802.11ac (VHT40)	5500-5720	102 to 142	134	OFDM	BPSK	13.5

Power Line Conducted Emission Test:

- Pre-Scan has been conducted to determine the worst-case mode from all possible combinations between available modulations, data rates and antenna ports (if EUT with antenna diversity architecture).
- Following channel(s) was (were) selected for the final test as listed below.

CDD MODE						
MODE	FREQ. BAND (MHz)	AVAILABLE CHANNEL	TESTED CHANNEL	MODULATION TECHNOLOGY	MODULATION TYPE	DATA RATE (Mbps)
802.11ac (VHT40)	5500-5720	102 to 142	134	OFDM	BPSK	13.5

Antenna Port Conducted Measurement:

- This item includes all test value of each mode, but only includes spectrum plot of worst value of each mode.
- Pre-Scan has been conducted to determine the worst-case mode from all possible combinations between available modulations, data rates and antenna ports (if EUT with antenna diversity architecture).
- Following channel(s) was (were) selected for the final test as listed below.

CDD MODE						
MODE	FREQ. BAND (MHz)	AVAILABLE CHANNEL	TESTED CHANNEL	MODULATION TECHNOLOGY	MODULATION TYPE	DATA RATE (Mbps)
802.11a	5260-5320	52 to 64	52, 60, 64	OFDM	BPSK	6
802.11ac (VHT20)		52 to 64	52, 60, 64	OFDM	BPSK	6.5
802.11ac (VHT40)		54 to 62	54, 62	OFDM	BPSK	13.5
802.11ac (VHT80)		58	58	OFDM	BPSK	29.3
802.11a	5500-5720	100 to 144	100, 120, 140, 144	OFDM	BPSK	6
802.11ac (VHT20)		100 to 144	100, 120, 140, 144	OFDM	BPSK	6.5
802.11ac (VHT40)		102 to 142	102, 118, 134, 142	OFDM	BPSK	13.5
802.11ac (VHT80)		106 to 138	106, 122, 138	OFDM	BPSK	29.3
Beamforming MODE						
MODE	FREQ. BAND (MHz)	AVAILABLE CHANNEL	TESTED CHANNEL	MODULATION TECHNOLOGY	MODULATION TYPE	DATA RATE (Mbps)
802.11ac (VHT20)	5260-5320	52 to 64	52, 60, 64	OFDM	BPSK	6.5
802.11ac (VHT40)		54 to 62	54, 62	OFDM	BPSK	13.5
802.11ac (VHT80)		58	58	OFDM	BPSK	29.3
802.11ac (VHT20)	5500-5720	100 to 144	100, 120, 140, 144	OFDM	BPSK	6.5
802.11ac (VHT40)		102 to 142	102, 118, 134, 142	OFDM	BPSK	13.5
802.11ac (VHT80)		106 to 138	106, 122, 138	OFDM	BPSK	29.3

Test Condition:

APPLICABLE TO	ENVIRONMENTAL CONDITIONS	INPUT POWER	TESTED BY
RE≥1G	23deg. C, 68%RH	120Vac, 60Hz	Robert Cheng
RE<1G	24deg. C, 71%RH	120Vac, 60Hz	Gary Cheng
PLC	21deg. C, 70%RH	120Vac, 60Hz	Wythe Lin
APCM	25deg. C, 60%RH	120Vac, 60Hz	Robert Cheng

3.3 Duty Cycle of Test Signal

If duty cycle of test signal is $\geq 98\%$, duty factor is not required.

If duty cycle of test signal is $< 98\%$, duty factor shall be considered.

802.11a: Duty cycle = $2.062 \text{ ms} / 2.093 \text{ ms} = 0.985$

802.11ac (VHT20): Duty cycle = $1.926 \text{ ms} / 1.957 \text{ ms} = 0.984$

802.11ac (VHT40): Duty cycle = $0.952 \text{ ms} / 0.981 \text{ ms} = 0.97$, Duty factor = $10 * \log(1/0.97) = 0.13$

802.11ac (VHT80): Duty cycle = $0.459 \text{ ms} / 0.49 \text{ ms} = 0.937$, Duty factor = $10 * \log(1/0.937) = 0.28$

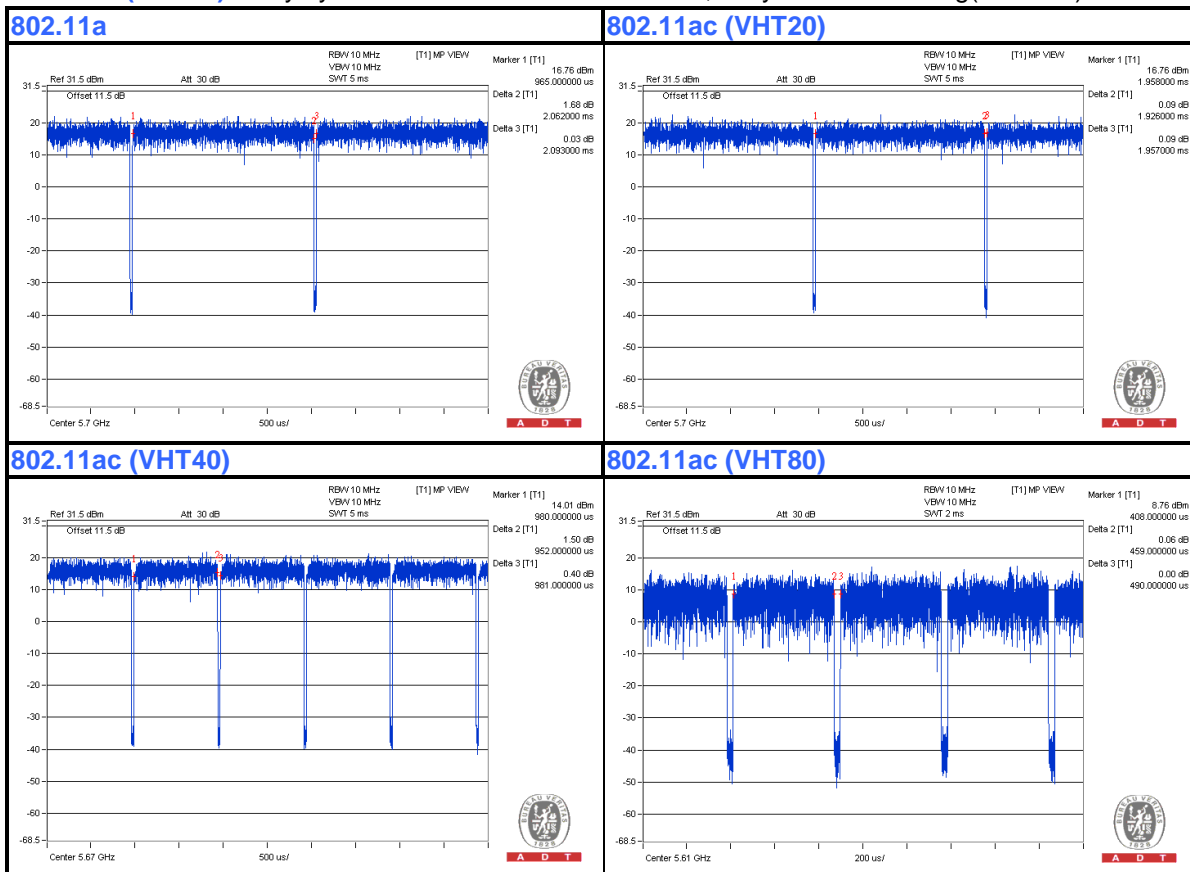

3.4 Description of Support Units

The EUT has been tested as an independent unit together with other necessary accessories or support units. The following support units or accessories were used to form a representative test configuration during the tests.

No.	Product	Brand	Model No.	Serial No.	FCC ID	Remark
A	iPod shuffle	Apple	MC749TA/A	CC4DMFJUDFDM	NA	Provided by Lab
B	iPod shuffle	Apple	MC749TA/A	CC4DN25WDFDM	NA	Provided by Lab
C	NOTEBOOK COMPUTER	DELL	E6420	H62T3R1	FCC DoC	Supplied by Client
D	HUB	ZyXEL	ES-116P	S060H02000215	FCC DoC	Provided by Lab

NOTE:

1. All power cords of the above support units are non-shielded (1.8 m).

No.	Cable	Qty.	Length (m)	Shielded (Yes/ No)	Cores (Number)	Remark
1	AC	1	1.5	No	0	Supplied by Client
2	Coaxial	1	10	No	0	Provided by Lab
3	UTP	1	10	No	0	Provided by Lab
4	UTP	1	10	No	0	Provided by Lab
5	USB	1	0.1	No	0	Provided by Lab

3.4.1 Configuration of System under Test

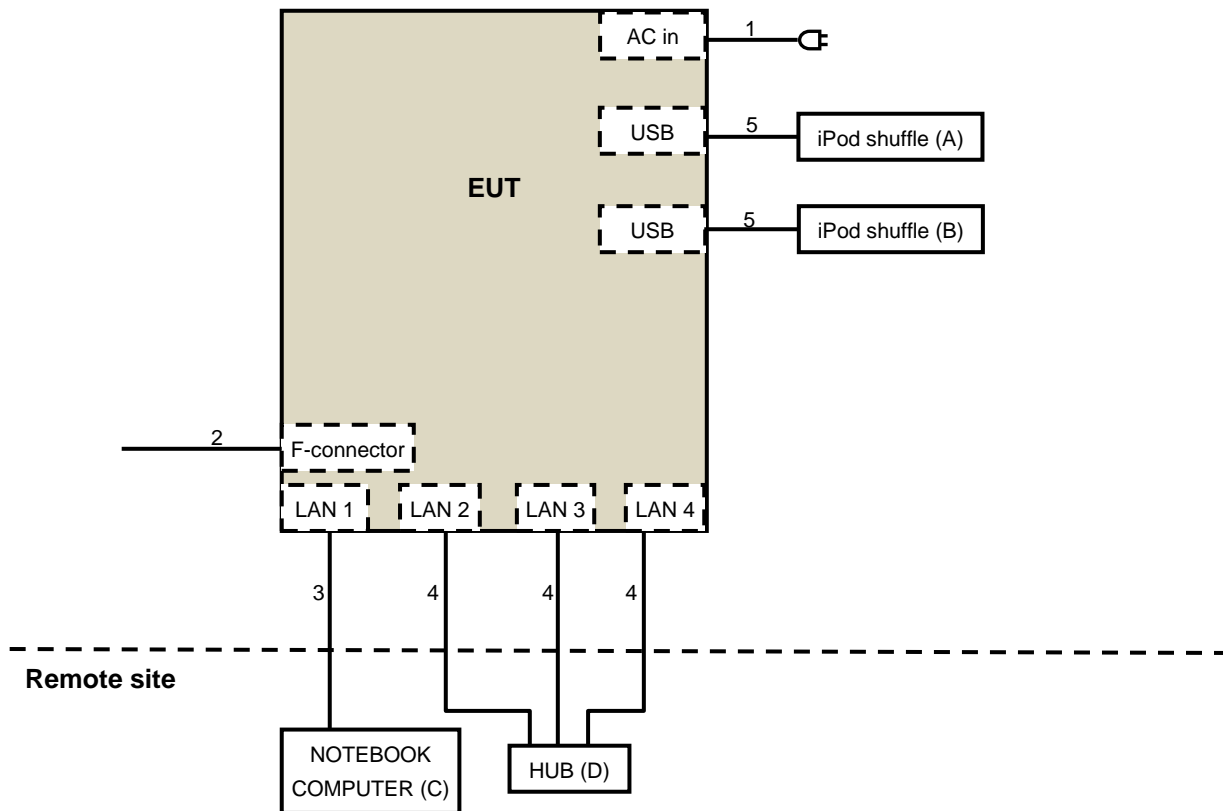

3.5 General Description of Applied Standards

The EUT is a RF Product. According to the specifications of the manufacturer, it must comply with the requirements of the following standards:

FCC Part 15, Subpart E (15.407)
789033 D02 General UNII Test Procedures New Rules v01
662911 D01 Multiple Transmitter Output v02r01
ANSI C63.10-2009

All test items have been performed and recorded as per the above standards.

Note: The EUT has been verified to comply with the requirements of FCC Part 15, Subpart B, Class B (DoC).
The test report has been issued separately.

4 Test Types and Results

4.1 Radiated Emission and Bandedge Measurement

4.1.1 Limits of Radiated Emission and Bandedge Measurement

Radiated emissions which fall in the restricted bands must comply with the radiated emission limits specified as below table. Other emissions shall be at least 20dB below the highest level of the desired power:

Frequencies (MHz)	Field Strength (microvolts/meter)	Measurement Distance (meters)
0.009 ~ 0.490	2400/F(kHz)	300
0.490 ~ 1.705	24000/F(kHz)	30
1.705 ~ 30.0	30	30
30 ~ 88	100	3
88 ~ 216	150	3
216 ~ 960	200	3
Above 960	500	3

NOTE:

1. The lower limit shall apply at the transition frequencies.
2. Emission level (dBuV/m) = 20 log Emission level (uV/m).
3. For frequencies above 1000MHz, the field strength limits are based on average detector, however, the peak field strength of any emission shall not exceed the maximum permitted average limits, specified above by more than 20dB under any condition of modulation.

LIMITS OF UNWANTED EMISSION OUT OF THE RESTRICTED BANDS

APPLICABLE TO	LIMIT	
789033 D02 General UNII Test Procedures New Rules v01	FIELD STRENGTH AT 3m	
	PK:74 (dBuV/m)	AV:54 (dBuV/m)
APPLICABLE TO	EIRP LIMIT	EQUIVALENT FIELD STRENGTH AT 3m
15.407(b)(1)	PK:-27 (dBm/MHz)	PK:68.2(dBuV/m)
15.407(b)(2)		
15.407(b)(3)		
15.407(b)(4)	PK:-27 (dBm/MHz) ^{*1} PK:-17 (dBm/MHz) ^{*2}	PK: 68.2(dBuV/m) ^{*1} PK:78.2 (dBuV/m) ^{*2}

NOTE: ^{*1} beyond 10MHz of the band edge ^{*2} within 10 MHz of band edge

The following formula is used to convert the equipment isotropic radiated power (eirp) to field strength:

$$E = \frac{1000000\sqrt{30P}}{3} \mu\text{V/m, where P is the eirp (Watts).}$$

4.1.2 Test Instruments

For below 1GHz test:

DESCRIPTION & MANUFACTURER	MODEL NO.	SERIAL NO.	CALIBRATED DATE	CALIBRATED UNTIL
MXE EMI Receiver Agilent	N9038A	MY50010156	Aug. 11, 2014	Aug. 10, 2015
Pre-Amplifier Mini-Circuits	ZFL-1000VH2 B	AMP-ZFL-04	Nov. 12, 2014	Nov. 11, 2015
Trilog Broadband Antenna SCHWARZBECK	VULB 9168	9168-361	Feb. 09, 2015	Feb. 08, 2016
RF Cable	NA	CHHCAB_001	Oct. 05, 2014	Oct. 04, 2015
Horn_Antenna AISI	AIH.8018	0000220091110	Aug. 26, 2014	Aug. 25, 2015
Pre-Amplifier Agilent	8449B	300801923	Oct. 28, 2014	Oct. 27, 2015
RF Cable	NA	131206 131215 SNMY23685/4	Jan. 16, 2015	Jan. 15, 2016
Spectrum Analyzer R&S	FSV40	100964	July 05, 2014	July 04, 2015
Pre-Amplifier EMCI	EMC184045	980143	Jan. 16, 2015	Jan. 15, 2016
Horn_Antenna SCHWARZBECK	BBHA 9170	9170-424	Aug. 26, 2014	Aug. 25, 2015
RF Cable	NA	RF104-121 RF104-204	Dec. 11, 2014	Dec. 10, 2015
Software	ADT_Radiated _V8.7.07	NA	NA	NA
Antenna Tower & Turn Table CT	NA	NA	NA	NA
Power meter Anritsu	ML2495A	1014008	Apr. 30, 2014	Apr. 29, 2015
Power sensor Anritsu	MA2411B	0917122	Apr. 30, 2014	Apr. 29, 2015
SPECTRUM ANALYZER R&S	FSP 40	100060	May 08, 2014	May 07, 2015
Temperature & Humidity Chamber GIANTFORCE	GTH-150-40-S P-AR	MAA0812-008	Jan. 12, 2015	Jan. 11, 2016

Note:

1. The calibration interval of the above test instruments is 12 months and the calibrations are traceable to NML/ROC and NIST/USA.
2. The horn antenna, preamplifier (model: 8449B) are used only for the measurement of emission frequency above 1GHz if tested.
- 3 The test was performed in 966 Chamber No. H.
4. The FCC Site Registration No. is 797305.
- 5 The CANADA Site Registration No. is IC 7450H-3.
- 6 Tested Date: Feb. 26, 2015

For above 1GHz:

DESCRIPTION & MANUFACTURER	MODEL NO.	SERIAL NO.	CALIBRATED DATE	CALIBRATED UNTIL
MXE EMI Receiver Agilent	N9038A	MY51210105	July 21, 2014	July 20, 2015
Pre-Amplifier Mini-Circuits	ZFL-1000VH2 B	AMP-ZFL-03	Nov. 12, 2014	Nov. 11, 2015
Trilog Broadband Antenna SCHWARZBECK	VULB 9168	9168-360	Feb. 06, 2015	Feb. 05, 2016
RF Cable	NA	CHGCAB_001	Oct. 04, 2014	Oct. 03, 2015
Horn_Antenna AISI	AIH.8018	0000320091110	Aug. 27, 2014	Aug. 26, 2015
Pre-Amplifier Agilent	8449B	3008A02578	June 24, 2014	June 23, 2015
RF Cable	NA	131205 131214 SNMY23684/4	Jan. 16, 2015	Jan. 15, 2016
Spectrum Analyzer R&S	FSV40	100964	July 05, 2014	July 04, 2015
Pre-Amplifier EMCI	EMC184045	980143	Jan. 16, 2015	Jan. 15, 2016
Horn_Antenna SCHWARZBECK	BBHA 9170	9170-424	Aug. 26, 2014	Aug. 25, 2015
RF Cable	NA	RF104-121 RF104-204	Dec. 05, 2014	Dec. 04, 2015
Antenna Tower & Turn Table CT	NA	NA	NA	NA

Note:

1. The calibration interval of the above test instruments is 12 months and the calibrations are traceable to NML/ROC and NIST/USA.
2. The horn antenna, preamplifier (model: 8449B) are used only for the measurement of emission frequency above 1GHz if tested.
3. The test was performed in 966 Chamber No. G.
4. The FCC Site Registration No. is 966073.
5. The VCCI Site Registration No. is G-137.
6. The CANADA Site Registration No. is IC 7450H-2.
7. Tested Date: Mar. 06, 2015

4.1.3 Test Procedures

- a. The EUT was placed on the top of a rotating table 0.8 meters above the ground at 3 meter chamber room for test. The table was rotated 360 degrees to determine the position of the highest radiation.
- b. The EUT was set 3 meters away from the interference-receiving antenna, which was mounted on the top of a variable-height antenna tower.
- c. The height of antenna is varied from one meter to four meters above the ground to determine the maximum value of the field strength. Both horizontal and vertical polarizations of the antenna are set to make the measurement.
- d. For each suspected emission, the EUT was arranged to its worst case and then the antenna was tuned to heights from 1 meter to 4 meters and the rotatable table was turned from 0 degrees to 360 degrees to find the maximum reading.
- e. The test-receiver system was set to quasi-peak detect function and specified bandwidth with maximum hold mode when the test frequency is below 1 GHz.
- f. The test-receiver system was set to peak and average detect function and specified bandwidth with maximum hold mode when the test frequency is above 1 GHz. If the peak reading value also meets average limit, measurement with the average detector is unnecessary.

Note:

1. For emission measurements above 1 GHz, the EUT shall be placed at a height of 1.5 m above the ground at 3 meter chamber room for test
2. The resolution bandwidth and video bandwidth of test receiver/spectrum analyzer is 120kHz for Quasi-peak detection (QP) at frequency below 1GHz.
3. The resolution bandwidth of test receiver/spectrum analyzer is 1 MHz and the video bandwidth is 3 MHz for Peak detection (PK) at frequency above 1GHz.
4. The resolution bandwidth of test receiver/spectrum analyzer is 1MHz and the video bandwidth is 3MHz for RMS Average (Duty cycle < 98%) for Average detection (AV) at frequency above 1GHz, then the measurement results was added to a correction factor ($10 \log(1/\text{duty cycle})$).
5. The resolution bandwidth of test receiver/spectrum analyzer is 1MHz and the video bandwidth is 10Hz (Duty cycle $\geq 98\%$) for Average detection (AV) at frequency above 1GHz.
6. All modes of operation were investigated and the worst-case emissions are reported.

4.1.4 Deviation from Test Standard

No deviation.

4.1.5 Test Setup

<Frequency Range below 1GHz>

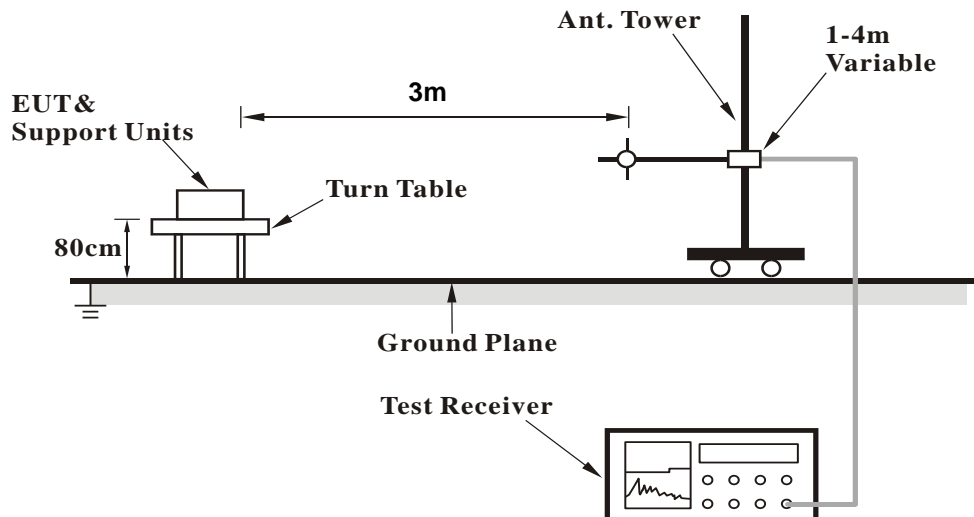

<Frequency Range above 1GHz>

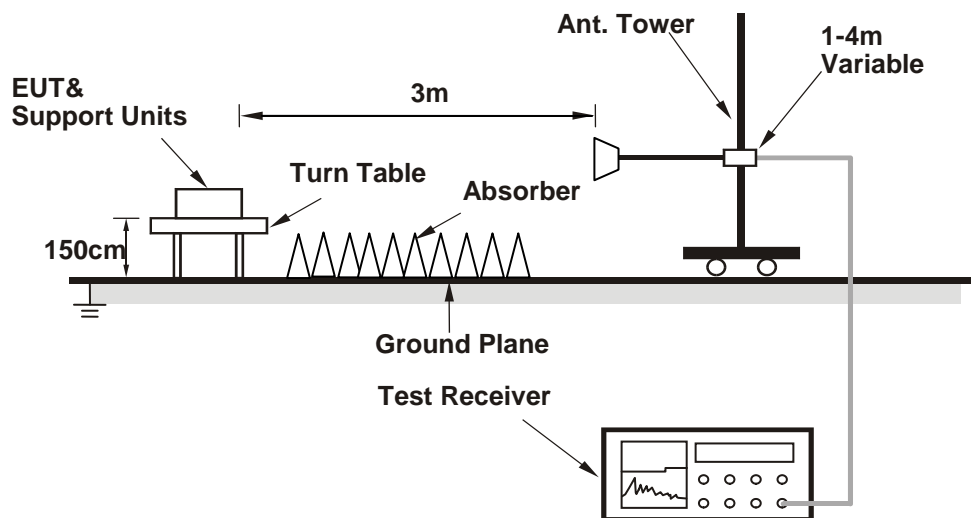

4.1.6 EUT Operating Conditions

1. Placed the EUT on testing table.
2. Prepared computer system (support unit C) to act as communication partner.
3. The communication partner ran test program "Mtool 2.0.1.0.exe" to enable EUT under transmission/receiving condition continuously.

4.1.7 Test Results

CDD MODE

ABOVE 1GHz DATA

802.11a

CHANNEL	TX Channel 52	DETECTOR FUNCTION	Peak (PK)
FREQUENCY RANGE	1GHz ~ 40GHz		Average (AV)

ANTENNA POLARITY & TEST DISTANCE: HORIZONTAL AT 3 M

NO.	FREQ. (MHz)	EMISSION LEVEL (dBuV/m)	LIMIT (dBuV/m)	MARGIN (dB)	ANTENNA HEIGHT (m)	TABLE ANGLE (Degree)	RAW VALUE (dBuV)	CORRECTION FACTOR (dB/m)
1	5040.00	55.7 PK	74.0	-18.3	2.05 H	177	52.50	3.20
2	5040.00	46.6 AV	54.0	-7.4	2.05 H	177	43.40	3.20
3	*5260.00	114.9 PK			1.71 H	126	111.04	3.86
4	*5260.00	105.6 AV			1.71 H	126	101.74	3.86
5	5418.00	60.5 PK	74.0	-13.5	2.05 H	122	56.20	4.30
6	5418.00	53.5 AV	54.0	-0.5	2.05 H	122	49.20	4.30
7	#5479.00	58.5 PK	74.0	-15.5	2.08 H	95	54.15	4.35
8	#5479.00	52.5 AV	54.0	-1.5	2.08 H	95	48.15	4.35
9	#10520.00	59.3 PK	74.0	-14.7	1.79 H	103	49.58	9.72
10	#10520.00	48.1 AV	54.0	-5.9	1.79 H	103	38.38	9.72
11	15780.00	63.6 PK	74.0	-10.4	1.61 H	197	49.38	14.22
12	15780.00	51.2 AV	54.0	-2.8	1.61 H	197	36.98	14.22

ANTENNA POLARITY & TEST DISTANCE: VERTICAL AT 3 M

NO.	FREQ. (MHz)	EMISSION LEVEL (dBuV/m)	LIMIT (dBuV/m)	MARGIN (dB)	ANTENNA HEIGHT (m)	TABLE ANGLE (Degree)	RAW VALUE (dBuV)	CORRECTION FACTOR (dB/m)
1	5040.00	51.6 PK	74.0	-22.4	1.10 V	91	48.40	3.20
2	5040.00	42.3 AV	54.0	-11.7	1.10 V	91	39.10	3.20
3	*5260.00	110.4 PK			1.10 V	95	106.54	3.86
4	*5260.00	102.0 AV			1.10 V	95	98.14	3.86
5	5418.00	59.2 PK	74.0	-14.8	1.13 V	106	54.90	4.30
6	5418.00	52.8 AV	54.0	-1.2	1.13 V	106	48.50	4.30
7	#5479.00	57.4 PK	74.0	-16.6	1.13 V	102	53.05	4.35
8	#5479.00	52.0 AV	54.0	-2.0	1.13 V	102	47.65	4.35
9	#10520.00	57.5 PK	74.0	-16.5	2.06 V	300	47.78	9.72
10	#10520.00	45.9 AV	54.0	-8.1	2.06 V	300	36.18	9.72
11	15780.00	67.3 PK	74.0	-6.7	1.87 V	319	53.08	14.22
12	15780.00	52.4 AV	54.0	-1.6	1.87 V	319	38.18	14.22

REMARKS:

1. Emission Level(dBuV/m) = Raw Value(dBuV) + Correction Factor(dB/m)
2. Correction Factor(dB/m) = Antenna Factor(dB/m) + Cable Factor(dB) – Pre-Amplifier Factor(dB)
3. The other emission levels were very low against the limit.
4. Margin value = Emission Level – Limit value
5. " * ": Fundamental frequency.
6. " # ": The radiated frequency is out of the restricted band.

CHANNEL	TX Channel 60	DETECTOR FUNCTION	Peak (PK)
FREQUENCY RANGE	1GHz ~ 40GHz		Average (AV)

ANTENNA POLARITY & TEST DISTANCE: HORIZONTAL AT 3 M

NO.	FREQ. (MHz)	EMISSION LEVEL (dBuV/m)	LIMIT (dBuV/m)	MARGIN (dB)	ANTENNA HEIGHT (m)	TABLE ANGLE (Degree)	RAW VALUE (dBuV)	CORRECTION FACTOR (dB/m)
1	5150.00	57.6 PK	74.0	-16.4	1.97 H	184	53.97	3.63
2	5150.00	47.9 AV	54.0	-6.1	1.97 H	184	44.27	3.63
3	*5300.00	116.1 PK			1.93 H	126	112.22	3.88
4	*5300.00	106.3 AV			1.93 H	126	102.42	3.88
5	5460.00	62.5 PK	74.0	-11.5	1.19 H	143	58.16	4.34
6	5460.00	53.5 AV	54.0	-0.5	1.19 H	143	49.16	4.34
7	#5467.00	62.1 PK	74.0	-11.9	1.19 H	141	57.77	4.33
8	#5467.00	52.3 AV	54.0	-1.7	1.19 H	141	47.97	4.33
9	#5520.00	57.5 PK	74.0	-16.5	1.67 H	145	53.04	4.46
10	#5520.00	52.0 AV	54.0	-2.0	1.67 H	145	47.54	4.46
11	10600.00	60.1 PK	74.0	-13.9	1.77 H	98	50.07	10.03
12	10600.00	49.0 AV	54.0	-5.0	1.77 H	98	38.97	10.03
13	15900.00	64.7 PK	74.0	-9.3	1.62 H	200	50.16	14.54
14	15900.00	51.7 AV	54.0	-2.3	1.62 H	200	37.16	14.54

ANTENNA POLARITY & TEST DISTANCE: VERTICAL AT 3 M

NO.	FREQ. (MHz)	EMISSION LEVEL (dBuV/m)	LIMIT (dBuV/m)	MARGIN (dB)	ANTENNA HEIGHT (m)	TABLE ANGLE (Degree)	RAW VALUE (dBuV)	CORRECTION FACTOR (dB/m)
1	5150.00	53.5 PK	74.0	-20.5	2.02 V	30	49.87	3.63
2	5150.00	43.6 AV	54.0	-10.4	2.02 V	30	39.97	3.63
3	*5300.00	111.4 PK			1.10 V	86	107.52	3.88
4	*5300.00	102.5 AV			1.10 V	86	98.62	3.88
5	5460.00	66.8 PK	74.0	-7.2	2.08 V	14	62.46	4.34
6	5460.00	50.0 AV	54.0	-4.0	2.08 V	14	45.66	4.34
7	#5467.00	57.7 PK	74.0	-16.3	2.00 V	30	53.37	4.33
8	#5467.00	47.8 AV	54.0	-6.2	2.00 V	30	43.47	4.33
9	#5520.00	54.3 PK	74.0	-19.7	2.01 V	33	49.84	4.46
10	#5520.00	47.6 AV	54.0	-6.4	2.01 V	33	43.14	4.46
11	10600.00	58.5 PK	74.0	-15.5	2.08 V	291	48.47	10.03
12	10600.00	46.2 AV	54.0	-7.8	2.08 V	291	36.17	10.03
13	15900.00	68.1 PK	74.0	-5.9	1.82 V	310	53.56	14.54
14	15900.00	52.6 AV	54.0	-1.4	1.82 V	310	38.06	14.54

REMARKS:

1. Emission Level(dBuV/m) = Raw Value(dBuV) + Correction Factor(dB/m)
2. Correction Factor(dB/m) = Antenna Factor(dB/m) + Cable Factor(dB) – Pre-Amplifier Factor(dB)
3. The other emission levels were very low against the limit.
4. Margin value = Emission Level – Limit value
5. " * ": Fundamental frequency.
6. " # ": The radiated frequency is out of the restricted band.

CHANNEL	TX Channel 64	DETECTOR FUNCTION	Peak (PK)
FREQUENCY RANGE	1GHz ~ 40GHz		Average (AV)

ANTENNA POLARITY & TEST DISTANCE: HORIZONTAL AT 3 M

NO.	FREQ. (MHz)	EMISSION LEVEL (dBuV/m)	LIMIT (dBuV/m)	MARGIN (dB)	ANTENNA HEIGHT (m)	TABLE ANGLE (Degree)	RAW VALUE (dBuV)	CORRECTION FACTOR (dB/m)
1	5150.00	58.5 PK	74.0	-15.5	2.03 H	190	54.87	3.63
2	5150.00	50.5 AV	54.0	-3.5	2.03 H	190	46.87	3.63
3	*5320.00	116.8 PK			1.97 H	136	112.83	3.97
4	*5320.00	107.1 AV			1.97 H	136	103.13	3.97
5	5350.00	60.8 PK	74.0	-13.2	1.70 H	127	56.72	4.08
6	5350.00	53.8 AV	54.0	-0.2	1.70 H	127	49.72	4.08
7	#5480.00	62.5 PK	74.0	-11.5	1.64 H	156	58.16	4.34
8	#5480.00	53.3 AV	54.0	-0.7	1.64 H	156	48.96	4.34
9	10640.00	57.0 PK	74.0	-17.0	1.25 H	14	46.97	10.03
10	10640.00	44.0 AV	54.0	-10.0	1.25 H	14	33.97	10.03
11	15960.00	66.8 PK	74.0	-7.2	1.03 H	25	52.28	14.52
12	15960.00	49.5 AV	54.0	-4.5	1.03 H	25	34.98	14.52

ANTENNA POLARITY & TEST DISTANCE: VERTICAL AT 3 M

NO.	FREQ. (MHz)	EMISSION LEVEL (dBuV/m)	LIMIT (dBuV/m)	MARGIN (dB)	ANTENNA HEIGHT (m)	TABLE ANGLE (Degree)	RAW VALUE (dBuV)	CORRECTION FACTOR (dB/m)
1	5150.00	54.7 PK	74.0	-19.3	1.60 V	233	51.07	3.63
2	5150.00	46.4 AV	54.0	-7.6	1.60 V	233	42.77	3.63
3	*5320.00	113.1 PK			1.07 V	86	109.13	3.97
4	*5320.00	103.8 AV			1.07 V	86	99.83	3.97
5	5350.00	58.9 PK	74.0	-15.1	2.20 V	313	54.82	4.08
6	5350.00	52.9 AV	54.0	-1.1	2.20 V	313	48.82	4.08
7	#5480.00	60.7 PK	74.0	-13.3	1.58 V	333	56.36	4.34
8	#5480.00	52.5 AV	54.0	-1.5	1.58 V	333	48.16	4.34
9	10640.00	57.3 PK	74.0	-16.7	1.92 V	293	47.27	10.03
10	10640.00	46.1 AV	54.0	-7.9	1.92 V	293	36.07	10.03
11	15960.00	63.0 PK	74.0	-11.0	1.11 V	329	48.48	14.52
12	15960.00	51.8 AV	54.0	-2.2	1.11 V	329	37.28	14.52

REMARKS:

1. Emission Level(dBuV/m) = Raw Value(dBuV) + Correction Factor(dB/m)
2. Correction Factor(dB/m) = Antenna Factor(dB/m) + Cable Factor(dB) – Pre-Amplifier Factor(dB)
3. The other emission levels were very low against the limit.
4. Margin value = Emission Level – Limit value
5. " * ": Fundamental frequency.
6. " # ": The radiated frequency is out of the restricted band.



CHANNEL	TX Channel 100	DETECTOR FUNCTION	Peak (PK)
FREQUENCY RANGE	1GHz ~ 40GHz		Average (AV)

ANTENNA POLARITY & TEST DISTANCE: HORIZONTAL AT 3 M

NO.	FREQ. (MHz)	EMISSION LEVEL (dBuV/m)	LIMIT (dBuV/m)	MARGIN (dB)	ANTENNA HEIGHT (m)	TABLE ANGLE (Degree)	RAW VALUE (dBuV)	CORRECTION FACTOR (dB/m)
1	#5270.00	56.1 PK	74.0	-17.9	1.83 H	130	52.22	3.88
2	#5270.00	49.7 AV	54.0	-4.3	1.83 H	130	45.82	3.88
3	#5339.00	62.5 PK	74.0	-11.5	1.93 H	125	58.46	4.04
4	#5339.00	53.1 AV	54.0	-0.9	1.93 H	125	49.06	4.04
5	#5470.00	70.5 PK	74.0	-3.5	1.80 H	121	66.15	4.35
6	#5470.00	53.6 AV	54.0	-0.4	1.80 H	121	49.25	4.35
7	*5500.00	117.4 PK			1.79 H	121	113.04	4.36
8	*5500.00	109.6 AV			1.79 H	121	105.24	4.36
9	#5729.00	60.2 PK	74.0	-13.8	2.35 H	151	55.24	4.96
10	#5729.00	52.9 AV	54.0	-1.1	2.35 H	151	47.94	4.96
11	11000.00	57.3 PK	74.0	-16.7	1.00 H	30	47.02	10.28
12	11000.00	44.3 AV	54.0	-9.7	1.00 H	30	34.02	10.28
13	#16500.00	67.1 PK	74.0	-6.9	1.02 H	12	50.29	16.81
14	#16500.00	50.2 AV	54.0	-3.8	1.02 H	12	33.39	16.81

ANTENNA POLARITY & TEST DISTANCE: VERTICAL AT 3 M

NO.	FREQ. (MHz)	EMISSION LEVEL (dBuV/m)	LIMIT (dBuV/m)	MARGIN (dB)	ANTENNA HEIGHT (m)	TABLE ANGLE (Degree)	RAW VALUE (dBuV)	CORRECTION FACTOR (dB/m)
1	#5270.00	50.2 PK	74.0	-23.8	1.77 V	139	46.32	3.88
2	#5270.00	45.8 AV	54.0	-8.2	1.77 V	139	41.92	3.88
3	#5339.00	58.3 PK	74.0	-15.7	1.06 V	86	54.26	4.04
4	#5339.00	48.2 AV	54.0	-5.8	1.06 V	86	44.16	4.04
5	#5470.00	67.2 PK	74.0	-6.8	2.05 V	3	62.85	4.35
6	#5470.00	50.3 AV	54.0	-3.7	2.05 V	3	45.95	4.35
7	*5500.00	114.6 PK			2.40 V	20	110.24	4.36
8	*5500.00	105.1 AV			2.40 V	20	100.74	4.36
9	#5729.00	57.6 PK	74.0	-16.4	2.06 V	76	52.64	4.96
10	#5729.00	48.6 AV	54.0	-5.4	2.06 V	76	43.64	4.96
11	11000.00	58.1 PK	74.0	-15.9	1.89 V	292	47.82	10.28
12	11000.00	46.7 AV	54.0	-7.3	1.89 V	292	36.42	10.28
13	#16500.00	63.5 PK	74.0	-10.5	1.03 V	325	46.69	16.81
14	#16500.00	52.1 AV	54.0	-1.9	1.03 V	325	35.29	16.81

REMARKS:

1. Emission Level(dBuV/m) = Raw Value(dBuV) + Correction Factor(dB/m)
2. Correction Factor(dB/m) = Antenna Factor(dB/m) + Cable Factor(dB) – Pre-Amplifier Factor(dB)
3. The other emission levels were very low against the limit.
4. Margin value = Emission Level – Limit value
5. " * ": Fundamental frequency.
6. " # ": The radiated frequency is out of the restricted band.

CHANNEL	TX Channel 120	DETECTOR FUNCTION	Peak (PK)
FREQUENCY RANGE	1GHz ~ 40GHz		Average (AV)

ANTENNA POLARITY & TEST DISTANCE: HORIZONTAL AT 3 M

NO.	FREQ. (MHz)	EMISSION LEVEL (dBuV/m)	LIMIT (dBuV/m)	MARGIN (dB)	ANTENNA HEIGHT (m)	TABLE ANGLE (Degree)	RAW VALUE (dBuV)	CORRECTION FACTOR (dB/m)
1	5439.00	63.5 PK	74.0	-10.5	1.83 H	122	59.19	4.31
2	5439.00	53.5 AV	54.0	-0.5	1.83 H	122	49.19	4.31
3	#5470.00	57.3 PK	74.0	-16.7	1.83 H	122	52.95	4.35
4	#5470.00	44.3 AV	54.0	-9.7	1.83 H	122	39.95	4.35
5	*5600.00	115.8 PK			1.80 H	120	110.94	4.86
6	*5600.00	106.5 AV			1.80 H	120	101.64	4.86
7	#5761.00	61.9 PK	74.0	-12.1	1.68 H	118	56.90	5.00
8	#5761.00	51.7 AV	54.0	-2.3	1.68 H	118	46.70	5.00
9	#5833.00	57.9 PK	74.0	-16.1	1.54 H	135	52.75	5.15
10	#5833.00	51.5 AV	54.0	-2.5	1.54 H	135	46.35	5.15
11	11200.00	58.6 PK	74.0	-15.4	1.63 H	124	48.15	10.45
12	11200.00	47.5 AV	54.0	-6.5	1.63 H	124	37.05	10.45
13	#16800.00	63.8 PK	74.0	-10.2	1.65 H	198	46.68	17.12
14	#16800.00	51.9 AV	54.0	-2.1	1.65 H	198	34.78	17.12

ANTENNA POLARITY & TEST DISTANCE: VERTICAL AT 3 M

NO.	FREQ. (MHz)	EMISSION LEVEL (dBuV/m)	LIMIT (dBuV/m)	MARGIN (dB)	ANTENNA HEIGHT (m)	TABLE ANGLE (Degree)	RAW VALUE (dBuV)	CORRECTION FACTOR (dB/m)
1	5439.00	62.3 PK	74.0	-11.7	2.00 V	15	57.99	4.31
2	5439.00	52.8 AV	54.0	-1.2	2.00 V	15	48.49	4.31
3	#5470.00	55.0 PK	74.0	-19.0	2.01 V	14	50.65	4.35
4	#5470.00	40.7 AV	54.0	-13.3	2.01 V	14	36.35	4.35
5	*5600.00	111.3 PK			1.54 V	210	106.44	4.86
6	*5600.00	103.0 AV			1.54 V	210	98.14	4.86
7	#5761.00	57.7 PK	74.0	-16.3	2.02 V	12	52.70	5.00
8	#5761.00	47.3 AV	54.0	-6.7	2.02 V	12	42.30	5.00
9	#5833.00	53.6 PK	74.0	-20.4	2.10 V	20	48.45	5.15
10	#5833.00	47.0 AV	54.0	-7.0	2.10 V	20	41.85	5.15
11	11200.00	56.5 PK	74.0	-17.5	2.03 V	304	46.05	10.45
12	11200.00	45.3 AV	54.0	-8.7	2.03 V	304	34.85	10.45
13	#16800.00	68.0 PK	74.0	-6.0	1.88 V	327	50.88	17.12
14	#16800.00	52.7 AV	54.0	-1.3	1.88 V	327	35.58	17.12

REMARKS:

1. Emission Level(dBuV/m) = Raw Value(dBuV) + Correction Factor(dB/m)
2. Correction Factor(dB/m) = Antenna Factor(dB/m) + Cable Factor(dB) – Pre-Amplifier Factor(dB)
3. The other emission levels were very low against the limit.
4. Margin value = Emission Level – Limit value
5. " * ": Fundamental frequency.
6. " # ": The radiated frequency is out of the restricted band.

CHANNEL	TX Channel 140	DETECTOR FUNCTION	Peak (PK)
FREQUENCY RANGE	1GHz ~ 40GHz		Average (AV)

ANTENNA POLARITY & TEST DISTANCE: HORIZONTAL AT 3 M

NO.	FREQ. (MHz)	EMISSION LEVEL (dBuV/m)	LIMIT (dBuV/m)	MARGIN (dB)	ANTENNA HEIGHT (m)	TABLE ANGLE (Degree)	RAW VALUE (dBuV)	CORRECTION FACTOR (dB/m)
1	#5462.00	57.7 PK	74.0	-16.3	1.76 H	124	53.36	4.34
2	#5462.00	50.1 AV	54.0	-3.9	1.76 H	124	45.76	4.34
3	*5700.00	116.1 PK			1.33 H	148	111.18	4.92
4	*5700.00	107.2 AV			1.33 H	148	102.28	4.92
5	#5725.00	70.2 PK	74.0	-3.8	1.36 H	125	65.24	4.96
6	#5725.00	53.7 AV	54.0	-0.3	1.36 H	125	48.74	4.96
7	#5862.00	62.5 PK	74.0	-11.5	1.63 H	145	57.28	5.22
8	#5862.00	52.7 AV	54.0	-1.3	1.63 H	145	47.48	5.22
9	11400.00	58.9 PK	74.0	-15.1	1.57 H	136	48.45	10.45
10	11400.00	47.6 AV	54.0	-6.4	1.57 H	136	37.15	10.45
11	#17100.00	63.3 PK	74.0	-10.7	1.68 H	197	46.22	17.08
12	#17100.00	51.4 AV	54.0	-2.6	1.68 H	197	34.32	17.08

ANTENNA POLARITY & TEST DISTANCE: VERTICAL AT 3 M

NO.	FREQ. (MHz)	EMISSION LEVEL (dBuV/m)	LIMIT (dBuV/m)	MARGIN (dB)	ANTENNA HEIGHT (m)	TABLE ANGLE (Degree)	RAW VALUE (dBuV)	CORRECTION FACTOR (dB/m)
1	#5462.00	57.5 PK	74.0	-16.5	1.97 V	14	53.16	4.34
2	#5462.00	47.0 AV	54.0	-7.0	1.97 V	14	42.66	4.34
3	*5700.00	111.6 PK			1.55 V	220	106.68	4.92
4	*5700.00	103.7 AV			1.55 V	220	98.78	4.92
5	#5725.00	62.7 PK	74.0	-11.3	2.01 V	15	57.74	4.96
6	#5725.00	53.2 AV	54.0	-0.8	2.01 V	15	48.24	4.96
7	#5862.00	55.3 PK	74.0	-18.7	1.98 V	12	50.08	5.22
8	#5862.00	41.1 AV	54.0	-12.9	1.98 V	12	35.88	5.22
9	11400.00	56.8 PK	74.0	-17.2	2.02 V	298	46.35	10.45
10	11400.00	45.7 AV	54.0	-8.3	2.02 V	298	35.25	10.45
11	#17100.00	67.9 PK	74.0	-6.1	1.93 V	313	50.82	17.08
12	#17100.00	53.2 AV	54.0	-0.8	1.93 V	313	36.12	17.08

REMARKS:

1. Emission Level(dBuV/m) = Raw Value(dBuV) + Correction Factor(dB/m)
2. Correction Factor(dB/m) = Antenna Factor(dB/m) + Cable Factor(dB) – Pre-Amplifier Factor(dB)
3. The other emission levels were very low against the limit.
4. Margin value = Emission Level – Limit value
5. " * ": Fundamental frequency.
6. " # ": The radiated frequency is out of the restricted band.

CHANNEL	TX Channel 144	DETECTOR FUNCTION	Peak (PK)
FREQUENCY RANGE	1GHz ~ 40GHz		Average (AV)

ANTENNA POLARITY & TEST DISTANCE: HORIZONTAL AT 3 M

NO.	FREQ. (MHz)	EMISSION LEVEL (dBuV/m)	LIMIT (dBuV/m)	MARGIN (dB)	ANTENNA HEIGHT (m)	TABLE ANGLE (Degree)	RAW VALUE (dBuV)	CORRECTION FACTOR (dB/m)
1	#5248.00	58.3 PK	68.2	-9.9	1.75 H	150	54.43	3.87
2	*5720.00	120.1 PK			1.49 H	150	115.15	4.95
3	*5720.00	111.1 AV			1.49 H	150	106.15	4.95
4	#5850.00	56.3 PK	68.2	-11.9	1.44 H	147	51.12	5.18
5	#5881.00	67.9 PK	68.2	-0.3	1.35 H	147	62.63	5.27
6	11440.00	60.3 PK	74.0	-13.7	1.65 H	113	49.78	10.52
7	11440.00	48.7 AV	54.0	-5.3	1.65 H	113	38.18	10.52
8	#17160.00	62.4 PK	68.2	-5.8	1.63 H	193	44.74	17.66

ANTENNA POLARITY & TEST DISTANCE: VERTICAL AT 3 M

NO.	FREQ. (MHz)	EMISSION LEVEL (dBuV/m)	LIMIT (dBuV/m)	MARGIN (dB)	ANTENNA HEIGHT (m)	TABLE ANGLE (Degree)	RAW VALUE (dBuV)	CORRECTION FACTOR (dB/m)
1	#5248.00	57.8 PK	68.2	-10.4	1.54 V	254	53.93	3.87
2	*5720.00	116.4 PK			1.55 V	11	111.45	4.95
3	*5720.00	107.3 AV			1.55 V	11	102.35	4.95
4	#5850.00	56.2 PK	68.2	-12.0	2.01 V	102	51.02	5.18
5	#5881.00	67.4 PK	68.2	-0.8	1.14 V	136	62.13	5.27
6	11440.00	57.5 PK	74.0	-16.5	1.90 V	308	46.98	10.52
7	11440.00	46.4 AV	54.0	-7.6	1.90 V	308	35.88	10.52
8	#17160.00	67.7 PK	68.2	-0.5	1.75 V	321	50.04	17.66

REMARKS:

1. Emission Level(dBuV/m) = Raw Value(dBuV) + Correction Factor(dB/m)
2. Correction Factor(dB/m) = Antenna Factor(dB/m) + Cable Factor(dB) – Pre-Amplifier Factor(dB)
3. The other emission levels were very low against the limit.
4. Margin value = Emission Level – Limit value
5. " * ": Fundamental frequency.
6. " # ": The radiated frequency is out of the restricted band.

802.11ac (VHT20)

CHANNEL	TX Channel 52	DETECTOR FUNCTION	Peak (PK)
FREQUENCY RANGE	1GHz ~ 40GHz		Average (AV)

ANTENNA POLARITY & TEST DISTANCE: HORIZONTAL AT 3 M

NO.	FREQ. (MHz)	EMISSION LEVEL (dBuV/m)	LIMIT (dBuV/m)	MARGIN (dB)	ANTENNA HEIGHT (m)	TABLE ANGLE (Degree)	RAW VALUE (dBuV)	CORRECTION FACTOR (dB/m)
1	5101.00	57.0 PK	74.0	-17.0	1.74 H	154	53.59	3.41
2	5101.00	47.1 AV	54.0	-6.9	1.74 H	154	43.69	3.41
3	*5260.00	114.5 PK			1.69 H	148	110.64	3.86
4	*5260.00	104.6 AV			1.69 H	148	100.74	3.86
5	5420.00	62.5 PK	74.0	-11.5	1.76 H	118	58.18	4.32
6	5420.00	53.6 AV	54.0	-0.4	1.76 H	118	49.28	4.32
7	#5479.00	57.7 PK	74.0	-16.3	1.76 H	121	53.35	4.35
8	#5479.00	50.4 AV	54.0	-3.6	1.76 H	121	46.05	4.35
9	#5698.00	57.6 PK	74.0	-16.4	1.64 H	145	52.68	4.92
10	#5698.00	50.8 AV	54.0	-3.2	1.64 H	145	45.88	4.92
11	#10520.00	59.2 PK	74.0	-14.8	1.86 H	108	49.48	9.72
12	#10520.00	48.2 AV	54.0	-5.8	1.86 H	108	38.48	9.72
13	15780.00	64.8 PK	74.0	-9.2	1.66 H	179	50.58	14.22
14	15780.00	51.0 AV	54.0	-3.0	1.66 H	179	36.78	14.22

ANTENNA POLARITY & TEST DISTANCE: VERTICAL AT 3 M

NO.	FREQ. (MHz)	EMISSION LEVEL (dBuV/m)	LIMIT (dBuV/m)	MARGIN (dB)	ANTENNA HEIGHT (m)	TABLE ANGLE (Degree)	RAW VALUE (dBuV)	CORRECTION FACTOR (dB/m)
1	5101.00	57.0 PK	74.0	-17.0	1.71 V	275	53.59	3.41
2	5101.00	46.8 AV	54.0	-7.2	1.71 V	275	43.39	3.41
3	*5260.00	111.1 PK			1.65 V	115	107.24	3.86
4	*5260.00	101.9 AV			1.65 V	115	98.04	3.86
5	5420.00	62.5 PK	74.0	-11.5	1.69 V	360	58.18	4.32
6	5420.00	52.8 AV	54.0	-1.2	1.69 V	360	48.48	4.32
7	#5479.00	56.7 PK	74.0	-17.3	1.60 V	215	52.35	4.35
8	#5479.00	50.4 AV	54.0	-3.6	1.60 V	215	46.05	4.35
9	#5698.00	56.4 PK	74.0	-17.6	1.72 V	239	51.48	4.92
10	#5698.00	46.2 AV	54.0	-7.8	1.72 V	239	41.28	4.92
11	#10520.00	57.3 PK	74.0	-16.7	2.11 V	308	47.58	9.72
12	#10520.00	45.6 AV	54.0	-8.4	2.11 V	308	35.88	9.72
13	15780.00	67.1 PK	74.0	-6.9	1.89 V	321	52.88	14.22
14	15780.00	52.2 AV	54.0	-1.8	1.89 V	321	37.98	14.22

REMARKS:

1. Emission Level(dBuV/m) = Raw Value(dBuV) + Correction Factor(dB/m)
2. Correction Factor(dB/m) = Antenna Factor(dB/m) + Cable Factor(dB) – Pre-Amplifier Factor(dB)
3. The other emission levels were very low against the limit.
4. Margin value = Emission Level – Limit value
5. " * ": Fundamental frequency.
6. " # ": The radiated frequency is out of the restricted band.

CHANNEL	TX Channel 60	DETECTOR FUNCTION	Peak (PK)
FREQUENCY RANGE	1GHz ~ 40GHz		Average (AV)

ANTENNA POLARITY & TEST DISTANCE: HORIZONTAL AT 3 M

NO.	FREQ. (MHz)	EMISSION LEVEL (dBuV/m)	LIMIT (dBuV/m)	MARGIN (dB)	ANTENNA HEIGHT (m)	TABLE ANGLE (Degree)	RAW VALUE (dBuV)	CORRECTION FACTOR (dB/m)
1	5141.00	57.4 PK	74.0	-16.6	1.85 H	152	53.80	3.60
2	5141.00	48.5 AV	54.0	-5.5	1.85 H	152	44.90	3.60
3	*5300.00	116.3 PK			1.88 H	129	112.42	3.88
4	*5300.00	106.8 AV			1.88 H	129	102.92	3.88
5	5460.00	63.1 PK	74.0	-10.9	1.77 H	123	58.76	4.34
6	5460.00	53.8 AV	54.0	-0.2	1.77 H	123	49.46	4.34
7	#5520.00	58.5 PK	74.0	-15.5	1.85 H	120	54.04	4.46
8	#5520.00	52.7 AV	54.0	-1.3	1.85 H	120	48.24	4.46
9	10600.00	58.5 PK	74.0	-15.5	1.61 H	143	48.47	10.03
10	10600.00	47.3 AV	54.0	-6.7	1.61 H	143	37.27	10.03
11	15900.00	64.1 PK	74.0	-9.9	1.72 H	212	49.56	14.54
12	15900.00	51.9 AV	54.0	-2.1	1.72 H	212	37.36	14.54

ANTENNA POLARITY & TEST DISTANCE: VERTICAL AT 3 M

NO.	FREQ. (MHz)	EMISSION LEVEL (dBuV/m)	LIMIT (dBuV/m)	MARGIN (dB)	ANTENNA HEIGHT (m)	TABLE ANGLE (Degree)	RAW VALUE (dBuV)	CORRECTION FACTOR (dB/m)
1	5141.00	53.3 PK	74.0	-20.7	1.97 V	36	49.70	3.60
2	5141.00	43.6 AV	54.0	-10.4	1.97 V	36	40.00	3.60
3	*5300.00	112.9 PK			1.50 V	118	109.02	3.88
4	*5300.00	104.1 AV			1.50 V	118	100.22	3.88
5	5460.00	66.8 PK	74.0	-7.2	2.04 V	1	62.46	4.34
6	5460.00	48.3 AV	54.0	-5.7	2.04 V	1	43.96	4.34
7	#5520.00	54.3 PK	74.0	-19.7	2.07 V	44	49.84	4.46
8	#5520.00	47.7 AV	54.0	-6.3	2.07 V	44	43.24	4.46
9	10600.00	57.2 PK	74.0	-16.8	2.03 V	312	47.17	10.03
10	10600.00	46.0 AV	54.0	-8.0	2.03 V	312	35.97	10.03
11	15900.00	68.1 PK	74.0	-5.9	1.96 V	298	53.56	14.54
12	15900.00	52.1 AV	54.0	-1.9	1.96 V	298	37.56	14.54

REMARKS:

1. Emission Level(dBuV/m) = Raw Value(dBuV) + Correction Factor(dB/m)
2. Correction Factor(dB/m) = Antenna Factor(dB/m) + Cable Factor(dB) – Pre-Amplifier Factor(dB)
3. The other emission levels were very low against the limit.
4. Margin value = Emission Level – Limit value
5. " * ": Fundamental frequency.
6. " # ": The radiated frequency is out of the restricted band.



CHANNEL	TX Channel 64	DETECTOR FUNCTION	Peak (PK)
FREQUENCY RANGE	1GHz ~ 40GHz		Average (AV)

ANTENNA POLARITY & TEST DISTANCE: HORIZONTAL AT 3 M

NO.	FREQ. (MHz)	EMISSION LEVEL (dBuV/m)	LIMIT (dBuV/m)	MARGIN (dB)	ANTENNA HEIGHT (m)	TABLE ANGLE (Degree)	RAW VALUE (dBuV)	CORRECTION FACTOR (dB/m)
1	#5161.00	60.2 PK	74.0	-13.8	1.83 H	151	56.51	3.69
2	#5161.00	49.4 AV	54.0	-4.6	1.83 H	151	45.71	3.69
3	*5320.00	117.3 PK			1.83 H	129	113.33	3.97
4	*5320.00	107.4 AV			1.83 H	129	103.43	3.97
5	5350.00	72.2 PK	74.0	-1.8	1.78 H	122	68.12	4.08
6	5350.00	53.7 AV	54.0	-0.3	1.78 H	122	49.62	4.08
7	#5479.00	63.2 PK	74.0	-10.8	1.70 H	125	58.85	4.35
8	#5479.00	53.1 AV	54.0	-0.9	1.70 H	125	48.75	4.35
9	#5541.00	58.6 PK	74.0	-15.4	1.80 H	119	54.03	4.57
10	#5541.00	53.1 AV	54.0	-0.9	1.80 H	119	48.53	4.57
11	10640.00	56.9 PK	74.0	-17.1	1.29 H	8	46.87	10.03
12	10640.00	44.2 AV	54.0	-9.8	1.29 H	8	34.17	10.03
13	15960.00	67.0 PK	74.0	-7.0	1.07 H	29	52.48	14.52
14	15960.00	49.5 AV	54.0	-4.5	1.07 H	29	34.98	14.52

ANTENNA POLARITY & TEST DISTANCE: VERTICAL AT 3 M

NO.	FREQ. (MHz)	EMISSION LEVEL (dBuV/m)	LIMIT (dBuV/m)	MARGIN (dB)	ANTENNA HEIGHT (m)	TABLE ANGLE (Degree)	RAW VALUE (dBuV)	CORRECTION FACTOR (dB/m)
1	#5161.00	54.3 PK	74.0	-19.7	1.58 V	247	50.61	3.69
2	#5161.00	46.2 AV	54.0	-7.8	1.58 V	247	42.51	3.69
3	*5320.00	113.8 PK			1.60 V	123	109.83	3.97
4	*5320.00	104.8 AV			1.60 V	123	100.83	3.97
5	5350.00	58.9 PK	74.0	-15.1	2.17 V	301	54.82	4.08
6	5350.00	51.8 AV	54.0	-2.2	2.17 V	301	47.72	4.08
7	#5479.00	60.5 PK	74.0	-13.5	1.55 V	340	56.15	4.35
8	#5479.00	52.0 AV	54.0	-2.0	1.55 V	340	47.65	4.35
9	#5541.00	52.7 PK	74.0	-21.3	2.10 V	311	48.13	4.57
10	#5541.00	51.1 AV	54.0	-2.9	2.10 V	311	46.53	4.57
11	10640.00	57.0 PK	74.0	-17.0	1.88 V	282	46.97	10.03
12	10640.00	45.8 AV	54.0	-8.2	1.88 V	282	35.77	10.03
13	15960.00	62.6 PK	74.0	-11.4	1.12 V	317	48.08	14.52
14	15960.00	51.3 AV	54.0	-2.7	1.12 V	317	36.78	14.52

REMARKS:

1. Emission Level(dBuV/m) = Raw Value(dBuV) + Correction Factor(dB/m)
2. Correction Factor(dB/m) = Antenna Factor(dB/m) + Cable Factor(dB) – Pre-Amplifier Factor(dB)
3. The other emission levels were very low against the limit.
4. Margin value = Emission Level – Limit value
5. " * ": Fundamental frequency.
6. " # ": The radiated frequency is out of the restricted band.

CHANNEL	TX Channel 100	DETECTOR FUNCTION	Peak (PK)
FREQUENCY RANGE	1GHz ~ 40GHz		Average (AV)

ANTENNA POLARITY & TEST DISTANCE: HORIZONTAL AT 3 M

NO.	FREQ. (MHz)	EMISSION LEVEL (dBuV/m)	LIMIT (dBuV/m)	MARGIN (dB)	ANTENNA HEIGHT (m)	TABLE ANGLE (Degree)	RAW VALUE (dBuV)	CORRECTION FACTOR (dB/m)
1	#5270.00	56.6 PK	74.0	-17.4	1.85 H	126	52.72	3.88
2	#5270.00	50.2 AV	54.0	-3.8	1.85 H	126	46.32	3.88
3	#5339.00	62.1 PK	74.0	-11.9	1.92 H	127	58.06	4.04
4	#5339.00	52.8 AV	54.0	-1.2	1.92 H	127	48.76	4.04
5	#5470.00	71.5 PK	74.0	-2.5	1.90 H	122	67.15	4.35
6	#5470.00	53.7 AV	54.0	-0.3	1.90 H	122	49.35	4.35
7	*5500.00	117.1 PK			1.77 H	128	112.74	4.36
8	*5500.00	108.6 AV			1.77 H	128	104.24	4.36
9	#5729.00	60.6 PK	74.0	-13.4	1.76 H	162	55.64	4.96
10	#5729.00	53.2 AV	54.0	-0.8	1.76 H	162	48.24	4.96
11	11000.00	56.8 PK	74.0	-17.2	1.04 H	20	46.52	10.28
12	11000.00	44.0 AV	54.0	-10.0	1.04 H	20	33.72	10.28
13	#16500.00	66.7 PK	74.0	-7.3	1.03 H	14	49.89	16.81
14	#16500.00	49.9 AV	54.0	-4.1	1.03 H	14	33.09	16.81

ANTENNA POLARITY & TEST DISTANCE: VERTICAL AT 3 M

NO.	FREQ. (MHz)	EMISSION LEVEL (dBuV/m)	LIMIT (dBuV/m)	MARGIN (dB)	ANTENNA HEIGHT (m)	TABLE ANGLE (Degree)	RAW VALUE (dBuV)	CORRECTION FACTOR (dB/m)
1	#5270.00	56.1 PK	74.0	-17.9	1.90 V	129	52.22	3.88
2	#5270.00	49.4 AV	54.0	-4.6	1.90 V	129	45.52	3.88
3	#5339.00	57.4 PK	74.0	-16.6	1.89 V	135	53.36	4.04
4	#5339.00	48.2 AV	54.0	-5.8	1.89 V	135	44.16	4.04
5	#5470.00	67.9 PK	74.0	-6.1	1.90 V	117	63.55	4.35
6	#5470.00	50.4 AV	54.0	-3.6	1.90 V	117	46.05	4.35
7	*5500.00	113.7 PK			1.76 V	138	109.34	4.36
8	*5500.00	104.7 AV			1.76 V	138	100.34	4.36
9	#5729.00	56.2 PK	74.0	-17.8	1.80 V	172	51.24	4.96
10	#5729.00	48.7 AV	54.0	-5.3	1.80 V	172	43.74	4.96
11	11000.00	58.2 PK	74.0	-15.8	1.87 V	299	47.92	10.28
12	11000.00	46.9 AV	54.0	-7.1	1.87 V	299	36.62	10.28
13	#16500.00	63.4 PK	74.0	-10.6	1.06 V	312	46.59	16.81
14	#16500.00	52.1 AV	54.0	-1.9	1.06 V	312	35.29	16.81

REMARKS:

1. Emission Level(dBuV/m) = Raw Value(dBuV) + Correction Factor(dB/m)
2. Correction Factor(dB/m) = Antenna Factor(dB/m) + Cable Factor(dB) – Pre-Amplifier Factor(dB)
3. The other emission levels were very low against the limit.
4. Margin value = Emission Level – Limit value
5. " * ": Fundamental frequency.
6. " # ": The radiated frequency is out of the restricted band.



CHANNEL	TX Channel 120	DETECTOR FUNCTION	Peak (PK)
FREQUENCY RANGE	1GHz ~ 40GHz		Average (AV)

ANTENNA POLARITY & TEST DISTANCE: HORIZONTAL AT 3 M

NO.	FREQ. (MHz)	EMISSION LEVEL (dBuV/m)	LIMIT (dBuV/m)	MARGIN (dB)	ANTENNA HEIGHT (m)	TABLE ANGLE (Degree)	RAW VALUE (dBuV)	CORRECTION FACTOR (dB/m)
1	5439.00	63.5 PK	74.0	-10.5	1.69 H	140	59.19	4.31
2	5439.00	53.5 AV	54.0	-0.5	1.69 H	140	49.19	4.31
3	#5470.00	58.6 PK	74.0	-15.4	1.83 H	122	54.25	4.35
4	#5470.00	45.3 AV	54.0	-8.7	1.83 H	122	40.95	4.35
5	*5600.00	117.5 PK			1.52 H	63	112.64	4.86
6	*5600.00	107.5 AV			1.52 H	63	102.64	4.86
7	#5761.00	62.9 PK	74.0	-11.1	1.68 H	118	57.90	5.00
8	#5761.00	52.7 AV	54.0	-1.3	1.68 H	118	47.70	5.00
9	#5833.00	58.9 PK	74.0	-15.1	1.54 H	135	53.75	5.15
10	#5833.00	52.5 AV	54.0	-1.5	1.54 H	135	47.35	5.15
11	11200.00	57.1 PK	74.0	-16.9	1.00 H	39	46.65	10.45
12	11200.00	44.1 AV	54.0	-9.9	1.00 H	39	33.65	10.45
13	#16800.00	67.1 PK	74.0	-6.9	1.00 H	18	49.98	17.12
14	#16800.00	50.1 AV	54.0	-3.9	1.00 H	18	32.98	17.12

ANTENNA POLARITY & TEST DISTANCE: VERTICAL AT 3 M

NO.	FREQ. (MHz)	EMISSION LEVEL (dBuV/m)	LIMIT (dBuV/m)	MARGIN (dB)	ANTENNA HEIGHT (m)	TABLE ANGLE (Degree)	RAW VALUE (dBuV)	CORRECTION FACTOR (dB/m)
1	5439.00	67.2 PK	74.0	-6.8	1.99 V	123	62.89	4.31
2	5439.00	49.9 AV	54.0	-4.1	1.99 V	123	45.59	4.31
3	#5470.00	54.7 PK	74.0	-19.3	2.01 V	15	50.35	4.35
4	#5470.00	40.3 AV	54.0	-13.7	2.01 V	15	35.95	4.35
5	*5600.00	114.1 PK			1.65 V	211	109.24	4.86
6	*5600.00	103.6 AV			1.65 V	211	98.74	4.86
7	#5761.00	57.1 PK	74.0	-16.9	1.98 V	13	52.10	5.00
8	#5761.00	46.8 AV	54.0	-7.2	1.98 V	13	41.80	5.00
9	#5833.00	53.1 PK	74.0	-20.9	1.55 V	200	47.95	5.15
10	#5833.00	46.6 AV	54.0	-7.4	1.55 V	200	41.45	5.15
11	11200.00	57.8 PK	74.0	-16.2	1.91 V	304	47.35	10.45
12	11200.00	46.5 AV	54.0	-7.5	1.91 V	304	36.05	10.45
13	#16800.00	63.1 PK	74.0	-10.9	1.50 V	329	45.98	17.12
14	#16800.00	51.9 AV	54.0	-2.1	1.50 V	329	34.78	17.12

REMARKS:

1. Emission Level(dBuV/m) = Raw Value(dBuV) + Correction Factor(dB/m)
2. Correction Factor(dB/m) = Antenna Factor(dB/m) + Cable Factor(dB) – Pre-Amplifier Factor(dB)
3. The other emission levels were very low against the limit.
4. Margin value = Emission Level – Limit value
5. " * ": Fundamental frequency.
6. " # ": The radiated frequency is out of the restricted band.

CHANNEL	TX Channel 140	DETECTOR FUNCTION	Peak (PK)
FREQUENCY RANGE	1GHz ~ 40GHz		Average (AV)

ANTENNA POLARITY & TEST DISTANCE: HORIZONTAL AT 3 M

NO.	FREQ. (MHz)	EMISSION LEVEL (dBuV/m)	LIMIT (dBuV/m)	MARGIN (dB)	ANTENNA HEIGHT (m)	TABLE ANGLE (Degree)	RAW VALUE (dBuV)	CORRECTION FACTOR (dB/m)
1	#5462.00	58.9 PK	74.0	-15.1	1.75 H	121	54.56	4.34
2	#5462.00	52.4 AV	54.0	-1.6	1.75 H	121	48.06	4.34
3	*5700.00	116.8 PK			1.81 H	114	111.88	4.92
4	*5700.00	106.4 AV			1.81 H	114	101.48	4.92
5	#5725.00	72.2 PK	74.0	-1.8	1.84 H	117	67.24	4.96
6	#5725.00	53.6 AV	54.0	-0.4	1.84 H	117	48.64	4.96
7	#5860.00	60.9 PK	74.0	-13.1	1.86 H	116	55.69	5.21
8	#5860.00	50.8 AV	54.0	-3.2	1.86 H	116	45.59	5.21
9	11400.00	58.4 PK	74.0	-15.6	1.57 H	131	47.95	10.45
10	11400.00	47.2 AV	54.0	-6.8	1.57 H	131	36.75	10.45
11	#17100.00	62.8 PK	74.0	-11.2	1.67 H	196	45.72	17.08
12	#17100.00	51.0 AV	54.0	-3.0	1.67 H	196	33.92	17.08

ANTENNA POLARITY & TEST DISTANCE: VERTICAL AT 3 M

NO.	FREQ. (MHz)	EMISSION LEVEL (dBuV/m)	LIMIT (dBuV/m)	MARGIN (dB)	ANTENNA HEIGHT (m)	TABLE ANGLE (Degree)	RAW VALUE (dBuV)	CORRECTION FACTOR (dB/m)
1	#5462.00	53.8 PK	74.0	-20.2	2.03 V	29	49.46	4.34
2	#5462.00	47.3 AV	54.0	-6.7	2.03 V	29	42.96	4.34
3	*5700.00	112.9 PK			1.50 V	174	107.98	4.92
4	*5700.00	103.2 AV			1.50 V	174	98.28	4.92
5	#5725.00	62.2 PK	74.0	-11.8	2.01 V	28	57.24	4.96
6	#5725.00	53.0 AV	54.0	-1.0	2.01 V	28	48.04	4.96
7	#5860.00	55.1 PK	74.0	-18.9	2.02 V	14	49.89	5.21
8	#5860.00	40.9 AV	54.0	-13.1	2.02 V	14	35.69	5.21
9	11400.00	57.4 PK	74.0	-16.6	2.00 V	312	46.95	10.45
10	11400.00	46.0 AV	54.0	-8.0	2.00 V	312	35.55	10.45
11	#17100.00	67.9 PK	74.0	-6.1	1.93 V	304	50.82	17.08
12	#17100.00	52.4 AV	54.0	-1.6	1.93 V	304	35.32	17.08

REMARKS:

1. Emission Level(dBuV/m) = Raw Value(dBuV) + Correction Factor(dB/m)
2. Correction Factor(dB/m) = Antenna Factor(dB/m) + Cable Factor(dB) – Pre-Amplifier Factor(dB)
3. The other emission levels were very low against the limit.
4. Margin value = Emission Level – Limit value
5. " * ": Fundamental frequency.
6. " # ": The radiated frequency is out of the restricted band.

CHANNEL	TX Channel 144	DETECTOR FUNCTION	Peak (PK)
FREQUENCY RANGE	1GHz ~ 40GHz		Average (AV)

ANTENNA POLARITY & TEST DISTANCE: HORIZONTAL AT 3 M

NO.	FREQ. (MHz)	EMISSION LEVEL (dBuV/m)	LIMIT (dBuV/m)	MARGIN (dB)	ANTENNA HEIGHT (m)	TABLE ANGLE (Degree)	RAW VALUE (dBuV)	CORRECTION FACTOR (dB/m)
1	#5248.00	57.7 PK	68.2	-10.5	1.69 H	142	53.83	3.87
2	*5720.00	119.7 PK			1.51 H	138	114.75	4.95
3	*5720.00	110.7 AV			1.51 H	138	105.75	4.95
4	#5850.00	56.5 PK	68.2	-11.7	1.80 H	120	51.32	5.18
5	#5880.00	67.6 PK	68.2	-0.6	1.33 H	152	62.33	5.27
6	11440.00	59.8 PK	74.0	-14.2	1.69 H	113	49.28	10.52
7	11440.00	48.4 AV	54.0	-5.6	1.69 H	113	37.88	10.52
8	#17160.00	61.7 PK	68.2	-6.5	1.68 H	196	44.04	17.66

ANTENNA POLARITY & TEST DISTANCE: VERTICAL AT 3 M

NO.	FREQ. (MHz)	EMISSION LEVEL (dBuV/m)	LIMIT (dBuV/m)	MARGIN (dB)	ANTENNA HEIGHT (m)	TABLE ANGLE (Degree)	RAW VALUE (dBuV)	CORRECTION FACTOR (dB/m)
1	#5248.00	53.1 PK	68.2	-15.1	1.56 V	247	49.23	3.87
2	*5720.00	115.8 PK			1.55 V	180	110.85	4.95
3	*5720.00	107.5 AV			1.55 V	180	102.55	4.95
4	#5850.00	52.1 PK	68.2	-16.1	2.02 V	100	46.92	5.18
5	#5880.00	63.1 PK	68.2	-5.1	1.16 V	142	57.83	5.27
6	11440.00	56.8 PK	74.0	-17.2	1.92 V	300	46.28	10.52
7	11440.00	45.8 AV	54.0	-8.2	1.92 V	300	35.28	10.52
8	#17160.00	67.1 PK	68.2	-1.1	1.73 V	327	49.44	17.66

REMARKS:

1. Emission Level(dBuV/m) = Raw Value(dBuV) + Correction Factor(dB/m)
2. Correction Factor(dB/m) = Antenna Factor(dB/m) + Cable Factor(dB) – Pre-Amplifier Factor(dB)
3. The other emission levels were very low against the limit.
4. Margin value = Emission Level – Limit value
5. " * ": Fundamental frequency.
6. " # ": The radiated frequency is out of the restricted band.

802.11ac (VHT40)

CHANNEL	TX Channel 54	DETECTOR FUNCTION	Peak (PK)
FREQUENCY RANGE	1GHz ~ 40GHz		Average (AV)

ANTENNA POLARITY & TEST DISTANCE: HORIZONTAL AT 3 M

NO.	FREQ. (MHz)	EMISSION LEVEL (dBuV/m)	LIMIT (dBuV/m)	MARGIN (dB)	ANTENNA HEIGHT (m)	TABLE ANGLE (Degree)	RAW VALUE (dBuV)	CORRECTION FACTOR (dB/m)
1	5106.00	56.4 PK	74.0	-17.6	1.66 H	150	52.97	3.43
2	5106.00	46.6 AV	54.0	-7.4	1.66 H	150	43.17	3.43
3	*5270.00	114.7 PK			1.79 H	129	110.82	3.88
4	*5270.00	105.6 AV			1.79 H	129	101.72	3.88
5	5425.00	62.0 PK	74.0	-12.0	1.81 H	121	57.68	4.32
6	5425.00	53.5 AV	54.0	-0.5	1.81 H	121	49.18	4.32
7	#5709.00	61.3 PK	68.2	-6.9	1.91 H	115	56.37	4.93
8	#10540.00	58.9 PK	68.2	-9.3	1.55 H	128	49.11	9.79
9	15810.00	63.9 PK	74.0	-10.1	1.71 H	224	49.62	14.28
10	15810.00	51.8 AV	54.0	-2.2	1.71 H	224	37.52	14.28

ANTENNA POLARITY & TEST DISTANCE: VERTICAL AT 3 M

NO.	FREQ. (MHz)	EMISSION LEVEL (dBuV/m)	LIMIT (dBuV/m)	MARGIN (dB)	ANTENNA HEIGHT (m)	TABLE ANGLE (Degree)	RAW VALUE (dBuV)	CORRECTION FACTOR (dB/m)
1	5106.00	52.6 PK	74.0	-21.4	1.89 V	50	49.17	3.43
2	5106.00	42.7 AV	54.0	-11.3	1.89 V	50	39.27	3.43
3	*5270.00	110.9 PK			1.65 V	196	107.02	3.88
4	*5270.00	102.7 AV			1.65 V	196	98.82	3.88
5	5425.00	66.1 PK	74.0	-7.9	2.08 V	321	61.78	4.32
6	5425.00	48.0 AV	54.0	-6.0	2.08 V	321	43.68	4.32
7	#5709.00	54.2 PK	68.2	-14.0	2.05 V	34	49.27	4.93
8	#10540.00	56.6 PK	68.2	-11.6	2.04 V	325	46.81	9.79
9	15810.00	68.0 PK	74.0	-6.0	1.83 V	293	53.72	14.28
10	15810.00	52.1 AV	54.0	-1.9	1.83 V	293	37.82	14.28

REMARKS:

1. Emission Level(dBuV/m) = Raw Value(dBuV) + Correction Factor(dB/m)
2. Correction Factor(dB/m) = Antenna Factor(dB/m) + Cable Factor(dB) – Pre-Amplifier Factor(dB)
3. The other emission levels were very low against the limit.
4. Margin value = Emission Level – Limit value
5. " * ": Fundamental frequency.
6. " # ": The radiated frequency is out of the restricted band.



CHANNEL	TX Channel 62	DETECTOR FUNCTION	Peak (PK)
FREQUENCY RANGE	1GHz ~ 40GHz		Average (AV)

ANTENNA POLARITY & TEST DISTANCE: HORIZONTAL AT 3 M

NO.	FREQ. (MHz)	EMISSION LEVEL (dBuV/m)	LIMIT (dBuV/m)	MARGIN (dB)	ANTENNA HEIGHT (m)	TABLE ANGLE (Degree)	RAW VALUE (dBuV)	CORRECTION FACTOR (dB/m)
1	4999.00	52.4 PK	74.0	-21.6	1.93 H	119	49.35	3.05
2	4999.00	45.5 AV	54.0	-8.5	1.93 H	119	42.45	3.05
3	*5310.00	110.0 PK			1.78 H	126	106.08	3.92
4	*5310.00	101.5 AV			1.78 H	126	97.58	3.92
5	5350.00	65.3 PK	74.0	-8.7	1.71 H	123	61.22	4.08
6	5350.00	53.6 AV	54.0	-0.4	1.71 H	123	49.52	4.08
7	#5752.00	60.1 PK	68.2	-8.1	1.86 H	112	55.11	4.99
8	10620.00	57.5 PK	74.0	-16.5	1.23 H	5	47.46	10.04
9	10620.00	44.6 AV	54.0	-9.4	1.23 H	5	34.56	10.04
10	15930.00	66.9 PK	74.0	-7.1	1.01 H	6	52.37	14.53
11	15930.00	49.7 AV	54.0	-4.3	1.01 H	6	35.17	14.53

ANTENNA POLARITY & TEST DISTANCE: VERTICAL AT 3 M

NO.	FREQ. (MHz)	EMISSION LEVEL (dBuV/m)	LIMIT (dBuV/m)	MARGIN (dB)	ANTENNA HEIGHT (m)	TABLE ANGLE (Degree)	RAW VALUE (dBuV)	CORRECTION FACTOR (dB/m)
1	4999.00	53.8 PK	74.0	-20.2	1.60 V	213	50.75	3.05
2	4999.00	46.1 AV	54.0	-7.9	1.60 V	213	43.05	3.05
3	*5310.00	106.2 PK			2.00 V	202	102.28	3.92
4	*5310.00	98.6 AV			2.00 V	202	94.68	3.92
5	5350.00	58.5 PK	74.0	-15.5	2.23 V	288	54.42	4.08
6	5350.00	51.7 AV	54.0	-2.3	2.23 V	288	47.62	4.08
7	#5752.00	60.3 PK	68.2	-7.9	1.56 V	322	55.31	4.99
8	10620.00	56.6 PK	74.0	-17.4	1.79 V	292	46.56	10.04
9	10620.00	45.4 AV	54.0	-8.6	1.79 V	292	35.36	10.04
10	15930.00	63.0 PK	74.0	-11.0	1.07 V	310	48.47	14.53
11	15930.00	51.5 AV	54.0	-2.5	1.07 V	310	36.97	14.53

REMARKS:

1. Emission Level(dBuV/m) = Raw Value(dBuV) + Correction Factor(dB/m)
2. Correction Factor(dB/m) = Antenna Factor(dB/m) + Cable Factor(dB) – Pre-Amplifier Factor(dB)
3. The other emission levels were very low against the limit.
4. Margin value = Emission Level – Limit value
5. " * ": Fundamental frequency.
6. " # ": The radiated frequency is out of the restricted band.



CHANNEL	TX Channel 102	DETECTOR FUNCTION	Peak (PK)
FREQUENCY RANGE	1GHz ~ 40GHz		Average (AV)

ANTENNA POLARITY & TEST DISTANCE: HORIZONTAL AT 3 M

NO.	FREQ. (MHz)	EMISSION LEVEL (dBuV/m)	LIMIT (dBuV/m)	MARGIN (dB)	ANTENNA HEIGHT (m)	TABLE ANGLE (Degree)	RAW VALUE (dBuV)	CORRECTION FACTOR (dB/m)
1	5355.00	56.7 PK	74.0	-17.3	1.95 H	125	52.59	4.11
2	5355.00	46.4 AV	54.0	-7.6	1.95 H	125	42.29	4.11
3	#5470.00	72.5 PK	74.0	-1.5	1.80 H	122	68.15	4.35
4	#5470.00	53.8 AV	54.0	-0.2	1.80 H	122	49.45	4.35
5	*5510.00	110.3 PK			1.33 H	140	105.89	4.41
6	*5510.00	101.9 AV			1.33 H	140	97.49	4.41
7	#5969.00	56.8 PK	74.0	-17.2	2.32 H	159	51.29	5.51
8	#5969.00	49.2 AV	54.0	-4.8	2.32 H	159	43.69	5.51
9	11020.00	56.7 PK	74.0	-17.3	1.06 H	13	46.39	10.31
10	11020.00	43.8 AV	54.0	-10.2	1.06 H	13	33.49	10.31
11	#16530.00	66.4 PK	74.0	-7.6	1.05 H	23	49.61	16.79
12	#16530.00	49.8 AV	54.0	-4.2	1.05 H	23	33.01	16.79

ANTENNA POLARITY & TEST DISTANCE: VERTICAL AT 3 M

NO.	FREQ. (MHz)	EMISSION LEVEL (dBuV/m)	LIMIT (dBuV/m)	MARGIN (dB)	ANTENNA HEIGHT (m)	TABLE ANGLE (Degree)	RAW VALUE (dBuV)	CORRECTION FACTOR (dB/m)
1	5355.00	53.6 PK	74.0	-20.4	1.85 V	110	49.49	4.11
2	5355.00	44.2 AV	54.0	-9.8	1.85 V	110	40.09	4.11
3	#5470.00	68.1 PK	74.0	-5.9	1.84 V	116	63.75	4.35
4	#5470.00	49.0 AV	54.0	-5.0	1.84 V	116	44.65	4.35
5	*5510.00	106.1 PK			2.31 V	207	101.69	4.41
6	*5510.00	99.6 AV			2.31 V	207	95.19	4.41
7	#5969.00	53.7 PK	74.0	-20.3	1.98 V	112	48.19	5.51
8	#5969.00	47.0 AV	54.0	-7.0	1.98 V	112	41.49	5.51
9	11020.00	58.2 PK	74.0	-15.8	1.89 V	288	47.89	10.31
10	11020.00	46.7 AV	54.0	-7.3	1.89 V	288	36.39	10.31
11	#16530.00	63.6 PK	74.0	-10.4	1.11 V	320	46.81	16.79
12	#16530.00	52.4 AV	54.0	-1.6	1.11 V	320	35.61	16.79

REMARKS:

1. Emission Level(dBuV/m) = Raw Value(dBuV) + Correction Factor(dB/m)
2. Correction Factor(dB/m) = Antenna Factor(dB/m) + Cable Factor(dB) – Pre-Amplifier Factor(dB)
3. The other emission levels were very low against the limit.
4. Margin value = Emission Level – Limit value
5. " * ": Fundamental frequency.
6. " # ": The radiated frequency is out of the restricted band.

CHANNEL	TX Channel 118	DETECTOR FUNCTION	Peak (PK)
FREQUENCY RANGE	1GHz ~ 40GHz		Average (AV)

ANTENNA POLARITY & TEST DISTANCE: HORIZONTAL AT 3 M

NO.	FREQ. (MHz)	EMISSION LEVEL (dBuV/m)	LIMIT (dBuV/m)	MARGIN (dB)	ANTENNA HEIGHT (m)	TABLE ANGLE (Degree)	RAW VALUE (dBuV)	CORRECTION FACTOR (dB/m)
1	5435.00	64.1 PK	74.0	-9.9	1.80 H	122	59.78	4.32
2	5435.00	53.5 AV	54.0	-0.5	1.80 H	122	49.18	4.32
3	*5590.00	114.9 PK			1.79 H	117	110.09	4.81
4	*5590.00	106.5 AV			1.79 H	117	101.69	4.81
5	#5745.00	61.1 PK	74.0	-12.9	1.77 H	113	56.13	4.97
6	#5745.00	51.4 AV	54.0	-2.6	1.77 H	113	46.43	4.97
7	11180.00	56.9 PK	74.0	-17.1	1.78 H	119	46.45	10.45
8	11180.00	44.5 AV	54.0	-9.5	1.78 H	119	34.05	10.45
9	#16770.00	57.1 PK	74.0	-16.9	1.74 H	107	40.04	17.06
10	#16770.00	44.8 AV	54.0	-9.2	1.74 H	107	27.74	17.06

ANTENNA POLARITY & TEST DISTANCE: VERTICAL AT 3 M

NO.	FREQ. (MHz)	EMISSION LEVEL (dBuV/m)	LIMIT (dBuV/m)	MARGIN (dB)	ANTENNA HEIGHT (m)	TABLE ANGLE (Degree)	RAW VALUE (dBuV)	CORRECTION FACTOR (dB/m)
1	5435.00	61.0 PK	74.0	-13.0	2.01 V	215	56.68	4.32
2	5435.00	50.3 AV	54.0	-3.7	2.01 V	215	45.98	4.32
3	*5590.00	111.0 PK			1.78 V	206	106.19	4.81
4	*5590.00	103.5 AV			1.78 V	206	98.69	4.81
5	#5745.00	57.9 PK	74.0	-16.1	1.55 V	122	52.93	4.97
6	#5745.00	47.0 AV	54.0	-7.0	1.55 V	122	42.03	4.97
7	11180.00	60.2 PK	74.0	-13.8	1.89 V	254	49.75	10.45
8	11180.00	47.7 AV	54.0	-6.3	1.89 V	254	37.25	10.45
9	#16770.00	63.7 PK	74.0	-10.3	1.09 V	314	46.64	17.06
10	#16770.00	52.2 AV	54.0	-1.8	1.09 V	314	35.14	17.06

REMARKS:

1. Emission Level(dBuV/m) = Raw Value(dBuV) + Correction Factor(dB/m)
2. Correction Factor(dB/m) = Antenna Factor(dB/m) + Cable Factor(dB) – Pre-Amplifier Factor(dB)
3. The other emission levels were very low against the limit.
4. Margin value = Emission Level – Limit value
5. " * ": Fundamental frequency.
6. " # ": The radiated frequency is out of the restricted band.

CHANNEL	TX Channel 134	DETECTOR FUNCTION	Peak (PK)
FREQUENCY RANGE	1GHz ~ 40GHz		Average (AV)

ANTENNA POLARITY & TEST DISTANCE: HORIZONTAL AT 3 M

NO.	FREQ. (MHz)	EMISSION LEVEL (dBuV/m)	LIMIT (dBuV/m)	MARGIN (dB)	ANTENNA HEIGHT (m)	TABLE ANGLE (Degree)	RAW VALUE (dBuV)	CORRECTION FACTOR (dB/m)
1	#5197.00	55.0 PK	74.0	-19.0	1.88 H	133	51.15	3.85
2	#5197.00	46.3 AV	54.0	-7.7	1.88 H	133	42.45	3.85
3	*5670.00	115.5 PK			1.69 H	117	110.60	4.90
4	*5670.00	106.2 AV			1.69 H	117	101.30	4.90
5	#5725.00	71.5 PK	74.0	-2.5	1.73 H	115	66.54	4.96
6	#5725.00	53.5 AV	54.0	-0.5	1.73 H	115	48.54	4.96
7	11340.00	56.2 PK	74.0	-17.8	1.84 H	109	45.63	10.57
8	11340.00	44.0 AV	54.0	-10.0	1.84 H	109	33.43	10.57
9	#17010.00	58.2 PK	74.0	-15.8	1.70 H	101	41.50	16.70
10	#17010.00	45.2 AV	54.0	-8.8	1.70 H	101	28.50	16.70

ANTENNA POLARITY & TEST DISTANCE: VERTICAL AT 3 M

NO.	FREQ. (MHz)	EMISSION LEVEL (dBuV/m)	LIMIT (dBuV/m)	MARGIN (dB)	ANTENNA HEIGHT (m)	TABLE ANGLE (Degree)	RAW VALUE (dBuV)	CORRECTION FACTOR (dB/m)
1	#5197.00	51.9 PK	74.0	-22.1	1.23 V	123	48.05	3.85
2	#5197.00	43.3 AV	54.0	-10.7	1.23 V	123	39.45	3.85
3	*5670.00	111.6 PK			1.74 V	206	106.70	4.90
4	*5670.00	103.2 AV			1.74 V	206	98.30	4.90
5	#5725.00	68.2 PK	74.0	-5.8	1.20 V	321	63.24	4.96
6	#5725.00	50.3 AV	54.0	-3.7	1.20 V	321	45.34	4.96
7	11340.00	60.5 PK	74.0	-13.5	1.84 V	246	49.93	10.57
8	11340.00	48.1 AV	54.0	-5.9	1.84 V	246	37.53	10.57
9	#17010.00	63.6 PK	74.0	-10.4	1.00 V	328	46.90	16.70
10	#17010.00	52.1 AV	54.0	-1.9	1.00 V	328	35.40	16.70

REMARKS:

- Emission Level(dBuV/m) = Raw Value(dBuV) + Correction Factor(dB/m)
- Correction Factor(dB/m) = Antenna Factor(dB/m) + Cable Factor(dB) – Pre-Amplifier Factor(dB)
- The other emission levels were very low against the limit.
- Margin value = Emission Level – Limit value
- " * ": Fundamental frequency.
- " # ": The radiated frequency is out of the restricted band.

CHANNEL	TX Channel 142	DETECTOR FUNCTION	Peak (PK)
FREQUENCY RANGE	1GHz ~ 40GHz		Average (AV)

ANTENNA POLARITY & TEST DISTANCE: HORIZONTAL AT 3 M

NO.	FREQ. (MHz)	EMISSION LEVEL (dBuV/m)	LIMIT (dBuV/m)	MARGIN (dB)	ANTENNA HEIGHT (m)	TABLE ANGLE (Degree)	RAW VALUE (dBuV)	CORRECTION FACTOR (dB/m)
1	*5710.00	116.4 PK			1.76 H	114	111.47	4.93
2	*5710.00	106.9 AV			1.76 H	114	101.97	4.93
3	#5850.00	61.3 PK	74.0	-12.7	1.89 H	113	56.12	5.18
4	#5850.00	50.9 AV	54.0	-3.1	1.89 H	113	45.72	5.18
5	#5860.00	62.4 PK	74.0	-11.6	1.80 H	122	57.19	5.21
6	#5860.00	53.5 AV	54.0	-0.5	1.80 H	122	48.29	5.21
7	11420.00	56.5 PK	74.0	-17.5	1.57 H	112	46.02	10.48
8	11420.00	44.3 AV	54.0	-9.7	1.57 H	112	33.82	10.48
9	#17130.00	58.5 PK	74.0	-15.5	1.60 H	213	41.13	17.37
10	#17130.00	46.5 AV	54.0	-7.5	1.60 H	213	29.13	17.37

ANTENNA POLARITY & TEST DISTANCE: VERTICAL AT 3 M

NO.	FREQ. (MHz)	EMISSION LEVEL (dBuV/m)	LIMIT (dBuV/m)	MARGIN (dB)	ANTENNA HEIGHT (m)	TABLE ANGLE (Degree)	RAW VALUE (dBuV)	CORRECTION FACTOR (dB/m)
1	*5710.00	112.4 PK			1.87 V	199	107.47	4.93
2	*5710.00	103.8 AV			1.87 V	199	98.87	4.93
3	#5850.00	56.8 PK	74.0	-17.2	1.65 V	320	51.62	5.18
4	#5850.00	48.9 AV	54.0	-5.1	1.65 V	320	43.72	5.18
5	#5860.00	57.9 PK	74.0	-16.1	1.87 V	251	52.69	5.21
6	#5860.00	51.5 AV	54.0	-2.5	1.87 V	251	46.29	5.21
7	11420.00	60.8 PK	74.0	-13.2	1.75 V	221	50.32	10.48
8	11420.00	48.5 AV	54.0	-5.5	1.75 V	221	38.02	10.48
9	#17130.00	64.0 PK	74.0	-10.0	1.78 V	223	46.63	17.37
10	#17130.00	52.7 AV	54.0	-1.3	1.78 V	223	35.33	17.37

REMARKS:

1. Emission Level(dBuV/m) = Raw Value(dBuV) + Correction Factor(dB/m)
2. Correction Factor(dB/m) = Antenna Factor(dB/m) + Cable Factor(dB) – Pre-Amplifier Factor(dB)
3. The other emission levels were very low against the limit.
4. Margin value = Emission Level – Limit value
5. " * ": Fundamental frequency.
6. " # ": The radiated frequency is out of the restricted band.

802.11ac (VHT80)

CHANNEL	TX Channel 58	DETECTOR FUNCTION	Peak (PK)
FREQUENCY RANGE	1GHz ~ 40GHz		Average (AV)

ANTENNA POLARITY & TEST DISTANCE: HORIZONTAL AT 3 M

NO.	FREQ. (MHz)	EMISSION LEVEL (dBuV/m)	LIMIT (dBuV/m)	MARGIN (dB)	ANTENNA HEIGHT (m)	TABLE ANGLE (Degree)	RAW VALUE (dBuV)	CORRECTION FACTOR (dB/m)
1	4999.00	52.5 PK	74.0	-21.5	1.73 H	116	49.45	3.05
2	4999.00	43.5 AV	54.0	-10.5	1.73 H	116	40.45	3.05
3	*5290.00	107.2 PK			1.63 H	125	103.31	3.89
4	*5290.00	96.2 AV			1.63 H	125	92.31	3.89
5	5350.00	70.2 PK	74.0	-3.8	1.72 H	122	66.12	4.08
6	5350.00	53.7 AV	54.0	-0.3	1.72 H	122	49.62	4.08
7	#5877.00	60.2 PK	68.2	-8.0	1.56 H	124	54.95	5.25
8	#10580.00	56.6 PK	68.2	-11.6	1.97 H	124	46.65	9.95
9	15870.00	55.5 PK	74.0	-18.5	1.79 H	52	41.05	14.45
10	15870.00	44.3 AV	54.0	-9.7	1.79 H	52	29.85	14.45

ANTENNA POLARITY & TEST DISTANCE: VERTICAL AT 3 M

NO.	FREQ. (MHz)	EMISSION LEVEL (dBuV/m)	LIMIT (dBuV/m)	MARGIN (dB)	ANTENNA HEIGHT (m)	TABLE ANGLE (Degree)	RAW VALUE (dBuV)	CORRECTION FACTOR (dB/m)
1	4999.00	51.9 PK	74.0	-22.1	1.81 V	100	48.85	3.05
2	4999.00	41.6 AV	54.0	-12.4	1.81 V	100	38.55	3.05
3	*5290.00	104.8 PK			1.93 V	15	100.91	3.89
4	*5290.00	94.6 AV			1.93 V	15	90.71	3.89
5	5350.00	63.1 PK	74.0	-10.9	2.02 V	360	59.02	4.08
6	5350.00	49.1 AV	54.0	-4.9	2.02 V	360	45.02	4.08
7	#5877.00	58.9 PK	68.2	-9.3	2.00 V	102	53.65	5.25
8	#10580.00	56.1 PK	68.2	-12.1	1.49 V	124	46.15	9.95
9	15870.00	63.2 PK	74.0	-10.8	1.18 V	290	48.75	14.45
10	15870.00	51.3 AV	54.0	-2.7	1.18 V	290	36.85	14.45

REMARKS:

- Emission Level(dBuV/m) = Raw Value(dBuV) + Correction Factor(dB/m)
- Correction Factor(dB/m) = Antenna Factor(dB/m) + Cable Factor(dB) – Pre-Amplifier Factor(dB)
- The other emission levels were very low against the limit.
- Margin value = Emission Level – Limit value
- " * ": Fundamental frequency.
- " # ": The radiated frequency is out of the restricted band.

CHANNEL	TX Channel 106	DETECTOR FUNCTION	Peak (PK)
FREQUENCY RANGE	1GHz ~ 40GHz		Average (AV)

ANTENNA POLARITY & TEST DISTANCE: HORIZONTAL AT 3 M

NO.	FREQ. (MHz)	EMISSION LEVEL (dBuV/m)	LIMIT (dBuV/m)	MARGIN (dB)	ANTENNA HEIGHT (m)	TABLE ANGLE (Degree)	RAW VALUE (dBuV)	CORRECTION FACTOR (dB/m)
1	4999.00	52.5 PK	74.0	-21.5	1.80 H	64	49.45	3.05
2	4999.00	42.6 AV	54.0	-11.4	1.80 H	64	39.55	3.05
3	5460.00	68.2 PK	74.0	-5.8	1.74 H	127	63.86	4.34
4	5460.00	52.1 AV	54.0	-1.9	1.74 H	127	47.76	4.34
5	#5470.00	72.6 PK	74.0	-1.4	1.77 H	121	68.25	4.35
6	#5470.00	53.7 AV	54.0	-0.3	1.77 H	121	49.35	4.35
7	*5530.00	107.7 PK			1.85 H	119	103.18	4.52
8	*5530.00	96.5 AV			1.85 H	119	91.98	4.52
9	11060.00	57.6 PK	74.0	-16.4	1.97 H	144	47.22	10.38
10	11060.00	44.3 AV	54.0	-9.7	1.97 H	144	33.92	10.38
11	#16590.00	56.1 PK	74.0	-17.9	1.80 H	65	39.35	16.75
12	#16590.00	44.9 AV	54.0	-9.1	1.80 H	65	28.15	16.75

ANTENNA POLARITY & TEST DISTANCE: VERTICAL AT 3 M

NO.	FREQ. (MHz)	EMISSION LEVEL (dBuV/m)	LIMIT (dBuV/m)	MARGIN (dB)	ANTENNA HEIGHT (m)	TABLE ANGLE (Degree)	RAW VALUE (dBuV)	CORRECTION FACTOR (dB/m)
1	4999.00	50.8 PK	74.0	-23.2	1.80 V	97	47.75	3.05
2	4999.00	40.5 AV	54.0	-13.5	1.80 V	97	37.45	3.05
3	5460.00	61.2 PK	74.0	-12.8	1.52 V	12	56.86	4.34
4	5460.00	48.7 AV	54.0	-5.3	1.52 V	12	44.36	4.34
5	#5470.00	65.6 PK	74.0	-8.4	1.05 V	212	61.25	4.35
6	#5470.00	49.3 AV	54.0	-4.7	1.05 V	212	44.95	4.35
7	*5530.00	104.9 PK			1.87 V	122	100.38	4.52
8	*5530.00	93.1 AV			1.87 V	122	88.58	4.52
9	11060.00	56.8 PK	74.0	-17.2	1.46 V	137	46.42	10.38
10	11060.00	43.9 AV	54.0	-10.1	1.46 V	137	33.52	10.38
11	#16590.00	63.5 PK	74.0	-10.5	1.09 V	306	46.75	16.75
12	#16590.00	51.4 AV	54.0	-2.6	1.09 V	306	34.65	16.75

REMARKS:

1. Emission Level(dBuV/m) = Raw Value(dBuV) + Correction Factor(dB/m)
2. Correction Factor(dB/m) = Antenna Factor(dB/m) + Cable Factor(dB) – Pre-Amplifier Factor(dB)
3. The other emission levels were very low against the limit.
4. Margin value = Emission Level – Limit value
5. " * ": Fundamental frequency.
6. " # ": The radiated frequency is out of the restricted band.

CHANNEL	TX Channel 122	DETECTOR FUNCTION	Peak (PK)
FREQUENCY RANGE	1GHz ~ 40GHz		Average (AV)

ANTENNA POLARITY & TEST DISTANCE: HORIZONTAL AT 3 M

NO.	FREQ. (MHz)	EMISSION LEVEL (dBuV/m)	LIMIT (dBuV/m)	MARGIN (dB)	ANTENNA HEIGHT (m)	TABLE ANGLE (Degree)	RAW VALUE (dBuV)	CORRECTION FACTOR (dB/m)
1	4986.00	53.9 PK	74.0	-20.1	1.95 H	161	50.92	2.98
2	4986.00	45.3 AV	54.0	-8.7	1.95 H	161	42.32	2.98
3	*5610.00	112.3 PK			1.84 H	116	107.43	4.87
4	*5610.00	101.4 AV			1.84 H	116	96.53	4.87
5	#5725.00	66.9 PK	74.0	-7.1	1.86 H	118	61.94	4.96
6	#5725.00	53.8 AV	54.0	-0.2	1.86 H	118	48.84	4.96
7	11220.00	57.7 PK	74.0	-16.3	1.95 H	139	47.21	10.49
8	11220.00	44.1 AV	54.0	-9.9	1.95 H	139	33.61	10.49
9	#16830.00	56.3 PK	74.0	-17.7	1.75 H	56	39.26	17.04
10	#16830.00	44.9 AV	54.0	-9.1	1.75 H	56	27.86	17.04

ANTENNA POLARITY & TEST DISTANCE: VERTICAL AT 3 M

NO.	FREQ. (MHz)	EMISSION LEVEL (dBuV/m)	LIMIT (dBuV/m)	MARGIN (dB)	ANTENNA HEIGHT (m)	TABLE ANGLE (Degree)	RAW VALUE (dBuV)	CORRECTION FACTOR (dB/m)
1	4986.00	46.9 PK	74.0	-27.1	1.45 V	111	43.92	2.98
2	4986.00	42.5 AV	54.0	-11.5	1.45 V	111	39.52	2.98
3	*5610.00	109.5 PK			1.78 V	213	104.63	4.87
4	*5610.00	98.0 AV			1.78 V	213	93.13	4.87
5	#5725.00	59.9 PK	74.0	-14.1	1.54 V	222	54.94	4.96
6	#5725.00	49.7 AV	54.0	-4.3	1.54 V	222	44.74	4.96
7	11220.00	56.2 PK	74.0	-17.8	1.45 V	143	45.71	10.49
8	11220.00	43.4 AV	54.0	-10.6	1.45 V	143	32.91	10.49
9	#16830.00	62.9 PK	74.0	-11.1	1.03 V	293	45.86	17.04
10	#16830.00	50.6 AV	54.0	-3.4	1.03 V	293	33.56	17.04

REMARKS:

1. Emission Level(dBuV/m) = Raw Value(dBuV) + Correction Factor(dB/m)
2. Correction Factor(dB/m) = Antenna Factor(dB/m) + Cable Factor(dB) – Pre-Amplifier Factor(dB)
3. The other emission levels were very low against the limit.
4. Margin value = Emission Level – Limit value
5. " * ": Fundamental frequency.
6. " # ": The radiated frequency is out of the restricted band.

CHANNEL	TX Channel 138	DETECTOR FUNCTION	Peak (PK)
FREQUENCY RANGE	1GHz ~ 40GHz		Average (AV)

ANTENNA POLARITY & TEST DISTANCE: HORIZONTAL AT 3 M

NO.	FREQ. (MHz)	EMISSION LEVEL (dBuV/m)	LIMIT (dBuV/m)	MARGIN (dB)	ANTENNA HEIGHT (m)	TABLE ANGLE (Degree)	RAW VALUE (dBuV)	CORRECTION FACTOR (dB/m)
1	5057.00	56.5 PK	74.0	-17.5	1.67 H	87	53.24	3.26
2	5057.00	50.1 AV	54.0	-3.9	1.67 H	87	46.84	3.26
3	*5690.00	114.2 PK			1.62 H	143	109.29	4.91
4	*5690.00	103.1 AV			1.62 H	143	98.19	4.91
5	#5850.00	66.9 PK	74.0	-7.1	2.46 H	122	61.72	5.18
6	#5850.00	52.7 AV	54.0	-1.3	2.46 H	122	47.52	5.18
7	#5860.00	65.3 PK	74.0	-8.7	1.81 H	112	60.09	5.21
8	#5860.00	53.1 AV	54.0	-0.9	1.81 H	112	47.89	5.21
9	11380.00	58.0 PK	74.0	-16.0	2.00 H	143	47.50	10.50
10	11380.00	44.5 AV	54.0	-9.5	2.00 H	143	34.00	10.50
11	#17070.00	57.1 PK	74.0	-16.9	1.76 H	88	40.15	16.95
12	#17070.00	45.9 AV	54.0	-8.1	1.76 H	88	28.95	16.95

ANTENNA POLARITY & TEST DISTANCE: VERTICAL AT 3 M

NO.	FREQ. (MHz)	EMISSION LEVEL (dBuV/m)	LIMIT (dBuV/m)	MARGIN (dB)	ANTENNA HEIGHT (m)	TABLE ANGLE (Degree)	RAW VALUE (dBuV)	CORRECTION FACTOR (dB/m)
1	5057.00	49.5 PK	74.0	-24.5	1.11 V	121	46.24	3.26
2	5057.00	46.4 AV	54.0	-7.6	1.11 V	121	43.14	3.26
3	*5690.00	111.3 PK			1.55 V	122	106.39	4.91
4	*5690.00	99.6 AV			1.55 V	122	94.69	4.91
5	#5850.00	59.9 PK	74.0	-14.1	1.20 V	211	54.72	5.18
6	#5850.00	49.0 AV	54.0	-5.0	1.20 V	211	43.82	5.18
7	#5860.00	58.3 PK	74.0	-15.7	1.42 V	112	53.09	5.21
8	#5860.00	49.7 AV	54.0	-4.3	1.42 V	112	44.49	5.21
9	11380.00	57.7 PK	74.0	-16.3	1.50 V	143	47.20	10.50
10	11380.00	44.2 AV	54.0	-9.8	1.50 V	143	33.70	10.50
11	#17070.00	63.8 PK	74.0	-10.2	1.09 V	316	46.85	16.95
12	#17070.00	51.6 AV	54.0	-2.4	1.09 V	316	34.65	16.95

REMARKS:

- Emission Level(dBuV/m) = Raw Value(dBuV) + Correction Factor(dB/m)
- Correction Factor(dB/m) = Antenna Factor(dB/m) + Cable Factor(dB) – Pre-Amplifier Factor(dB)
- The other emission levels were very low against the limit.
- Margin value = Emission Level – Limit value
- " * ": Fundamental frequency.
- " # ": The radiated frequency is out of the restricted band.

BELOW 1GHZ WORST-CASE DATA

802.11ac (VHT40)

CHANNEL	TX Channel 134	DETECTOR FUNCTION	Quasi-Peak (QP)
FREQUENCY RANGE	Below 1GHz		

ANTENNA POLARITY & TEST DISTANCE: HORIZONTAL AT 3 M

NO.	FREQ. (MHz)	EMISSION LEVEL (dBuV/m)	LIMIT (dBuV/m)	MARGIN (dB)	ANTENNA HEIGHT (m)	TABLE ANGLE (Degree)	RAW VALUE (dBuV)	CORRECTION FACTOR (dB/m)
1	132.25	36.8 QP	43.5	-6.7	1.40 H	298	50.74	-13.96
2	249.82	41.3 QP	46.0	-4.7	1.50 H	200	55.21	-13.91
3	281.60	41.4 QP	46.0	-4.6	1.35 H	125	53.98	-12.56
4	500.20	42.2 QP	46.0	-3.8	1.04 H	120	49.40	-7.18
5	749.60	40.3 QP	46.0	-5.7	1.10 H	240	42.28	-2.00
6	800.34	38.2 QP	46.0	-7.9	1.54 H	300	39.60	-1.45

ANTENNA POLARITY & TEST DISTANCE: VERTICAL AT 3 M

NO.	FREQ. (MHz)	EMISSION LEVEL (dBuV/m)	LIMIT (dBuV/m)	MARGIN (dB)	ANTENNA HEIGHT (m)	TABLE ANGLE (Degree)	RAW VALUE (dBuV)	CORRECTION FACTOR (dB/m)
1	89.62	36.8 QP	43.5	-6.7	1.20 V	167	55.75	-18.97
2	133.10	37.0 QP	43.5	-6.5	1.30 V	200	50.87	-13.87
3	167.10	37.2 QP	43.5	-6.3	1.28 V	300	50.49	-13.31
4	199.91	36.3 QP	43.5	-7.2	1.20 V	160	52.36	-16.04
5	249.70	41.6 QP	46.0	-4.4	1.30 V	114	55.53	-13.91
6	282.40	42.3 QP	46.0	-3.7	1.60 V	72	54.87	-12.54

REMARKS:

1. Emission Level(dBuV/m) = Raw Value(dBuV) + Correction Factor(dB/m)
2. Correction Factor(dB/m) = Antenna Factor(dB/m) + Cable Factor(dB) – Pre-Amplifier Factor(dB)
3. The other emission levels were very low against the limit.
4. Margin value = Emission Level – Limit value

Beamforming MODE
ABOVE 1GHz DATA
802.11ac (VHT20)

CHANNEL	TX Channel 52	DETECTOR FUNCTION	Peak (PK)
FREQUENCY RANGE	1GHz ~ 40GHz		Average (AV)

ANTENNA POLARITY & TEST DISTANCE: HORIZONTAL AT 3 M

NO.	FREQ. (MHz)	EMISSION LEVEL (dBuV/m)	LIMIT (dBuV/m)	MARGIN (dB)	ANTENNA HEIGHT (m)	TABLE ANGLE (Degree)	RAW VALUE (dBuV)	CORRECTION FACTOR (dB/m)
1	5101.00	57.2 PK	74.0	-16.8	1.67 H	168	53.79	3.41
2	5101.00	47.2 AV	54.0	-6.8	1.67 H	168	43.79	3.41
3	*5260.00	114.6 PK			1.80 H	127	110.74	3.86
4	*5260.00	104.6 AV			1.80 H	127	100.74	3.86
5	5411.00	63.6 PK	74.0	-10.4	1.62 H	144	59.28	4.32
6	5411.00	53.6 AV	54.0	-0.4	1.62 H	144	49.28	4.32
7	#10520.00	59.1 PK	74.0	-14.9	1.80 H	111	49.38	9.72
8	#10520.00	48.2 AV	54.0	-5.8	1.80 H	111	38.48	9.72
9	15780.00	65.2 PK	74.0	-8.8	1.72 H	174	50.98	14.22
10	15780.00	51.5 AV	54.0	-2.5	1.72 H	174	37.28	14.22

ANTENNA POLARITY & TEST DISTANCE: VERTICAL AT 3 M

NO.	FREQ. (MHz)	EMISSION LEVEL (dBuV/m)	LIMIT (dBuV/m)	MARGIN (dB)	ANTENNA HEIGHT (m)	TABLE ANGLE (Degree)	RAW VALUE (dBuV)	CORRECTION FACTOR (dB/m)
1	5101.00	56.9 PK	74.0	-17.1	1.77 V	244	53.49	3.41
2	5101.00	46.4 AV	54.0	-7.6	1.77 V	244	42.99	3.41
3	*5260.00	111.2 PK			1.64 V	102	107.34	3.86
4	*5260.00	101.9 AV			1.64 V	102	98.04	3.86
5	5411.00	57.3 PK	74.0	-16.7	1.73 V	264	52.98	4.32
6	5411.00	46.9 AV	54.0	-7.1	1.73 V	264	42.58	4.32
7	#10520.00	56.6 PK	74.0	-17.4	2.11 V	310	46.88	9.72
8	#10520.00	45.1 AV	54.0	-8.9	2.11 V	310	35.38	9.72
9	15780.00	67.4 PK	74.0	-6.6	1.84 V	330	53.18	14.22
10	15780.00	52.6 AV	54.0	-1.4	1.84 V	330	38.38	14.22

REMARKS:

1. Emission Level(dBuV/m) = Raw Value(dBuV) + Correction Factor(dB/m)
2. Correction Factor(dB/m) = Antenna Factor(dB/m) + Cable Factor(dB) – Pre-Amplifier Factor(dB)
3. The other emission levels were very low against the limit.
4. Margin value = Emission Level – Limit value
5. " * ": Fundamental frequency.
6. " # ": The radiated frequency is out of the restricted band.



CHANNEL	TX Channel 60	DETECTOR FUNCTION	Peak (PK)
FREQUENCY RANGE	1GHz ~ 40GHz		Average (AV)

ANTENNA POLARITY & TEST DISTANCE: HORIZONTAL AT 3 M

NO.	FREQ. (MHz)	EMISSION LEVEL (dBuV/m)	LIMIT (dBuV/m)	MARGIN (dB)	ANTENNA HEIGHT (m)	TABLE ANGLE (Degree)	RAW VALUE (dBuV)	CORRECTION FACTOR (dB/m)
1	*5300.00	115.8 PK			1.85 H	117	111.92	3.88
2	*5300.00	106.5 AV			1.85 H	117	102.62	3.88
3	5453.00	63.8 PK	74.0	-10.2	1.80 H	161	59.47	4.33
4	5453.00	53.8 AV	54.0	-0.2	1.80 H	161	49.47	4.33
5	10600.00	58.5 PK	74.0	-15.5	1.56 H	131	48.47	10.03
6	10600.00	47.3 AV	54.0	-6.7	1.56 H	131	37.27	10.03
7	15900.00	64.5 PK	74.0	-9.5	1.67 H	203	49.96	14.54
8	15900.00	52.2 AV	54.0	-1.8	1.67 H	203	37.66	14.54

ANTENNA POLARITY & TEST DISTANCE: VERTICAL AT 3 M

NO.	FREQ. (MHz)	EMISSION LEVEL (dBuV/m)	LIMIT (dBuV/m)	MARGIN (dB)	ANTENNA HEIGHT (m)	TABLE ANGLE (Degree)	RAW VALUE (dBuV)	CORRECTION FACTOR (dB/m)
1	*5300.00	112.6 PK			1.49 V	128	108.72	3.88
2	*5300.00	103.0 AV			1.49 V	128	99.12	3.88
3	5453.00	52.9 PK	74.0	-21.1	1.92 V	36	48.57	4.33
4	5453.00	43.5 AV	54.0	-10.5	1.92 V	36	39.17	4.33
5	10600.00	57.5 PK	74.0	-16.5	2.02 V	315	47.47	10.03
6	10600.00	46.2 AV	54.0	-7.8	2.02 V	315	36.17	10.03
7	15900.00	68.4 PK	74.0	-5.6	1.96 V	283	53.86	14.54
8	15900.00	52.3 AV	54.0	-1.7	1.96 V	283	37.76	14.54

REMARKS:

1. Emission Level(dBuV/m) = Raw Value(dBuV) + Correction Factor(dB/m)
2. Correction Factor(dB/m) = Antenna Factor(dB/m) + Cable Factor(dB) – Pre-Amplifier Factor(dB)
3. The other emission levels were very low against the limit.
4. Margin value = Emission Level – Limit value
5. " * ": Fundamental frequency.



CHANNEL	TX Channel 64	DETECTOR FUNCTION	Peak (PK)
FREQUENCY RANGE	1GHz ~ 40GHz		Average (AV)

ANTENNA POLARITY & TEST DISTANCE: HORIZONTAL AT 3 M

NO.	FREQ. (MHz)	EMISSION LEVEL (dBuV/m)	LIMIT (dBuV/m)	MARGIN (dB)	ANTENNA HEIGHT (m)	TABLE ANGLE (Degree)	RAW VALUE (dBuV)	CORRECTION FACTOR (dB/m)
1	*5320.00	117.3 PK			1.85 H	125	113.33	3.97
2	*5320.00	107.7 AV			1.85 H	125	103.73	3.97
3	5350.00	71.8 PK	74.0	-2.2	2.09 H	183	67.72	4.08
4	5350.00	53.6 AV	54.0	-0.4	2.09 H	183	49.52	4.08
5	10640.00	56.7 PK	74.0	-17.3	1.27 H	13	46.67	10.03
6	10640.00	44.0 AV	54.0	-10.0	1.27 H	13	33.97	10.03
7	15960.00	67.2 PK	74.0	-6.8	1.07 H	40	52.68	14.52
8	15960.00	49.8 AV	54.0	-4.2	1.07 H	40	35.28	14.52

ANTENNA POLARITY & TEST DISTANCE: VERTICAL AT 3 M

NO.	FREQ. (MHz)	EMISSION LEVEL (dBuV/m)	LIMIT (dBuV/m)	MARGIN (dB)	ANTENNA HEIGHT (m)	TABLE ANGLE (Degree)	RAW VALUE (dBuV)	CORRECTION FACTOR (dB/m)
1	*5320.00	113.5 PK			1.59 V	120	109.53	3.97
2	*5320.00	104.1 AV			1.59 V	120	100.13	3.97
3	5350.00	58.5 PK	74.0	-15.5	2.20 V	298	54.42	4.08
4	5350.00	51.6 AV	54.0	-2.4	2.20 V	298	47.52	4.08
5	10640.00	57.2 PK	74.0	-16.8	1.84 V	291	47.17	10.03
6	10640.00	45.9 AV	54.0	-8.1	1.84 V	291	35.87	10.03
7	15960.00	62.4 PK	74.0	-11.6	1.08 V	315	47.88	14.52
8	15960.00	50.9 AV	54.0	-3.1	1.08 V	315	36.38	14.52

REMARKS:

1. Emission Level(dBuV/m) = Raw Value(dBuV) + Correction Factor(dB/m)
2. Correction Factor(dB/m) = Antenna Factor(dB/m) + Cable Factor(dB) – Pre-Amplifier Factor(dB)
3. The other emission levels were very low against the limit.
4. Margin value = Emission Level – Limit value
5. " * ": Fundamental frequency.

CHANNEL	TX Channel 100	DETECTOR FUNCTION	Peak (PK)
FREQUENCY RANGE	1GHz ~ 40GHz		Average (AV)

ANTENNA POLARITY & TEST DISTANCE: HORIZONTAL AT 3 M

NO.	FREQ. (MHz)	EMISSION LEVEL (dBuV/m)	LIMIT (dBuV/m)	MARGIN (dB)	ANTENNA HEIGHT (m)	TABLE ANGLE (Degree)	RAW VALUE (dBuV)	CORRECTION FACTOR (dB/m)
1	#5348.00	61.2 PK	74.0	-12.8	1.84 H	179	57.12	4.08
2	#5348.00	52.2 AV	54.0	-1.8	1.84 H	179	48.12	4.08
3	#5470.00	70.1 PK	74.0	-3.9	2.01 H	161	65.75	4.35
4	#5470.00	53.7 AV	54.0	-0.3	2.01 H	161	49.35	4.35
5	*5500.00	118.9 PK			1.77 H	126	114.54	4.36
6	*5500.00	108.5 AV			1.77 H	126	104.14	4.36
7	11000.00	56.2 PK	74.0	-17.8	1.02 H	6	45.92	10.28
8	11000.00	43.6 AV	54.0	-10.4	1.02 H	6	33.32	10.28
9	#16500.00	66.9 PK	74.0	-7.1	1.04 H	8	50.09	16.81
10	#16500.00	50.2 AV	54.0	-3.8	1.04 H	8	33.39	16.81

ANTENNA POLARITY & TEST DISTANCE: VERTICAL AT 3 M

NO.	FREQ. (MHz)	EMISSION LEVEL (dBuV/m)	LIMIT (dBuV/m)	MARGIN (dB)	ANTENNA HEIGHT (m)	TABLE ANGLE (Degree)	RAW VALUE (dBuV)	CORRECTION FACTOR (dB/m)
1	#5348.00	56.7 PK	74.0	-17.3	1.81 V	157	52.62	4.08
2	#5348.00	49.0 AV	54.0	-5.0	1.81 V	157	44.92	4.08
3	#5470.00	67.9 PK	74.0	-6.1	1.89 V	124	63.55	4.35
4	#5470.00	50.7 AV	54.0	-3.3	1.89 V	124	46.35	4.35
5	*5500.00	113.8 PK			1.78 V	143	109.44	4.36
6	*5500.00	104.6 AV			1.78 V	143	100.24	4.36
7	11000.00	57.7 PK	74.0	-16.3	1.89 V	289	47.42	10.28
8	11000.00	46.5 AV	54.0	-7.5	1.89 V	289	36.22	10.28
9	#16500.00	63.1 PK	74.0	-10.9	1.05 V	302	46.29	16.81
10	#16500.00	51.8 AV	54.0	-2.2	1.05 V	302	34.99	16.81

REMARKS:

- Emission Level(dBuV/m) = Raw Value(dBuV) + Correction Factor(dB/m)
- Correction Factor(dB/m) = Antenna Factor(dB/m) + Cable Factor(dB) – Pre-Amplifier Factor(dB)
- The other emission levels were very low against the limit.
- Margin value = Emission Level – Limit value
- " * ": Fundamental frequency.
- " # ": The radiated frequency is out of the restricted band.

CHANNEL	TX Channel 120	DETECTOR FUNCTION	Peak (PK)
FREQUENCY RANGE	1GHz ~ 40GHz		Average (AV)

ANTENNA POLARITY & TEST DISTANCE: HORIZONTAL AT 3 M

NO.	FREQ. (MHz)	EMISSION LEVEL (dBuV/m)	LIMIT (dBuV/m)	MARGIN (dB)	ANTENNA HEIGHT (m)	TABLE ANGLE (Degree)	RAW VALUE (dBuV)	CORRECTION FACTOR (dB/m)
1	5441.00	65.8 PK	74.0	-8.2	1.95 H	141	61.48	4.32
2	5441.00	53.9 AV	54.0	-0.1	1.95 H	141	49.58	4.32
3	*5600.00	117.8 PK			1.50 H	56	112.94	4.86
4	*5600.00	107.8 AV			1.50 H	56	102.94	4.86
5	11200.00	56.5 PK	74.0	-17.5	1.00 H	43	46.05	10.45
6	11200.00	43.7 AV	54.0	-10.3	1.00 H	43	33.25	10.45
7	#16800.00	67.0 PK	74.0	-7.0	1.00 H	31	49.88	17.12
8	#16800.00	49.9 AV	54.0	-4.1	1.00 H	31	32.78	17.12

ANTENNA POLARITY & TEST DISTANCE: VERTICAL AT 3 M

NO.	FREQ. (MHz)	EMISSION LEVEL (dBuV/m)	LIMIT (dBuV/m)	MARGIN (dB)	ANTENNA HEIGHT (m)	TABLE ANGLE (Degree)	RAW VALUE (dBuV)	CORRECTION FACTOR (dB/m)
1	5441.00	67.6 PK	74.0	-6.4	1.99 V	130	63.28	4.32
2	5441.00	50.1 AV	54.0	-3.9	1.99 V	130	45.78	4.32
3	*5600.00	113.6 PK			1.68 V	218	108.74	4.86
4	*5600.00	103.1 AV			1.68 V	218	98.24	4.86
5	11200.00	57.5 PK	74.0	-16.5	1.95 V	305	47.05	10.45
6	11200.00	46.5 AV	54.0	-7.5	1.95 V	305	36.05	10.45
7	#16800.00	62.7 PK	74.0	-11.3	1.47 V	340	45.58	17.12
8	#16800.00	51.6 AV	54.0	-2.4	1.47 V	340	34.48	17.12

REMARKS:

1. Emission Level(dBuV/m) = Raw Value(dBuV) + Correction Factor(dB/m)
2. Correction Factor(dB/m) = Antenna Factor(dB/m) + Cable Factor(dB) – Pre-Amplifier Factor(dB)
3. The other emission levels were very low against the limit.
4. Margin value = Emission Level – Limit value
5. " * ": Fundamental frequency.
6. " # ": The radiated frequency is out of the restricted band.



CHANNEL	TX Channel 140	DETECTOR FUNCTION	Peak (PK)
FREQUENCY RANGE	1GHz ~ 40GHz		Average (AV)

ANTENNA POLARITY & TEST DISTANCE: HORIZONTAL AT 3 M

NO.	FREQ. (MHz)	EMISSION LEVEL (dBuV/m)	LIMIT (dBuV/m)	MARGIN (dB)	ANTENNA HEIGHT (m)	TABLE ANGLE (Degree)	RAW VALUE (dBuV)	CORRECTION FACTOR (dB/m)
1	*5700.00	116.5 PK			1.84 H	116	111.58	4.92
2	*5700.00	106.2 AV			1.84 H	116	101.28	4.92
3	#5725.00	73.7 PK	74.0	-0.3	2.10 H	152	68.74	4.96
4	#5725.00	52.3 AV	54.0	-1.7	2.10 H	152	47.34	4.96
5	11400.00	58.4 PK	74.0	-15.6	1.52 H	133	47.95	10.45
6	11400.00	47.2 AV	54.0	-6.8	1.52 H	133	36.75	10.45
7	#17100.00	62.4 PK	74.0	-11.6	1.63 H	197	45.32	17.08
8	#17100.00	50.7 AV	54.0	-3.3	1.63 H	197	33.62	17.08

ANTENNA POLARITY & TEST DISTANCE: VERTICAL AT 3 M

NO.	FREQ. (MHz)	EMISSION LEVEL (dBuV/m)	LIMIT (dBuV/m)	MARGIN (dB)	ANTENNA HEIGHT (m)	TABLE ANGLE (Degree)	RAW VALUE (dBuV)	CORRECTION FACTOR (dB/m)
1	*5700.00	112.8 PK			1.45 V	183	107.88	4.92
2	*5700.00	103.1 AV			1.45 V	183	98.18	4.92
3	#5725.00	61.7 PK	74.0	-12.3	2.05 V	28	56.74	4.96
4	#5725.00	52.1 AV	54.0	-1.9	2.05 V	28	47.14	4.96
5	11400.00	56.9 PK	74.0	-17.1	2.01 V	327	46.45	10.45
6	11400.00	45.6 AV	54.0	-8.4	2.01 V	327	35.15	10.45
7	#17100.00	67.2 PK	74.0	-6.8	1.93 V	319	50.12	17.08
8	#17100.00	51.4 AV	54.0	-2.6	1.93 V	319	34.32	17.08

REMARKS:

1. Emission Level(dBuV/m) = Raw Value(dBuV) + Correction Factor(dB/m)
2. Correction Factor(dB/m) = Antenna Factor(dB/m) + Cable Factor(dB) – Pre-Amplifier Factor(dB)
3. The other emission levels were very low against the limit.
4. Margin value = Emission Level – Limit value
5. " * ": Fundamental frequency.
6. " # ": The radiated frequency is out of the restricted band.

CHANNEL	TX Channel 144	DETECTOR FUNCTION	Peak (PK)
FREQUENCY RANGE	1GHz ~ 40GHz		Average (AV)

ANTENNA POLARITY & TEST DISTANCE: HORIZONTAL AT 3 M

NO.	FREQ. (MHz)	EMISSION LEVEL (dBuV/m)	LIMIT (dBuV/m)	MARGIN (dB)	ANTENNA HEIGHT (m)	TABLE ANGLE (Degree)	RAW VALUE (dBuV)	CORRECTION FACTOR (dB/m)
1	*5720.00	119.9 PK			1.70 H	63	114.95	4.95
2	*5720.00	108.8 AV			1.70 H	63	103.85	4.95
3	#5850.00	56.5 PK	68.2	-11.7	1.83 H	121	51.32	5.18
4	#5888.00	67.7 PK	68.2	-0.5	2.04 H	61	62.41	5.29
5	11440.00	60.1 PK	74.0	-13.9	1.68 H	113	49.58	10.52
6	11440.00	48.5 AV	54.0	-5.5	1.68 H	113	37.98	10.52
7	#17160.00	62.1 PK	68.2	-6.1	1.64 H	195	44.44	17.66

ANTENNA POLARITY & TEST DISTANCE: VERTICAL AT 3 M

NO.	FREQ. (MHz)	EMISSION LEVEL (dBuV/m)	LIMIT (dBuV/m)	MARGIN (dB)	ANTENNA HEIGHT (m)	TABLE ANGLE (Degree)	RAW VALUE (dBuV)	CORRECTION FACTOR (dB/m)
1	*5720.00	114.3 PK			1.55 V	170	109.35	4.95
2	*5720.00	105.9 AV			1.55 V	170	100.95	4.95
3	#5850.00	52.2 PK	68.2	-16.0	1.98 V	88	47.02	5.18
4	#5888.00	63.6 PK	68.2	-4.6	1.17 V	144	58.31	5.29
5	11440.00	56.9 PK	74.0	-17.1	1.93 V	308	46.38	10.52
6	11440.00	46.1 AV	54.0	-7.9	1.93 V	308	35.58	10.52
7	#17160.00	66.9 PK	68.2	-1.3	1.68 V	327	49.24	17.66

REMARKS:

1. Emission Level(dBuV/m) = Raw Value(dBuV) + Correction Factor(dB/m)
2. Correction Factor(dB/m) = Antenna Factor(dB/m) + Cable Factor(dB) – Pre-Amplifier Factor(dB)
3. The other emission levels were very low against the limit.
4. Margin value = Emission Level – Limit value
5. " * ": Fundamental frequency.
6. " # ": The radiated frequency is out of the restricted band.

802.11ac (VHT40)

CHANNEL	TX Channel 54	DETECTOR FUNCTION	Peak (PK)
FREQUENCY RANGE	1GHz ~ 40GHz		Average (AV)

ANTENNA POLARITY & TEST DISTANCE: HORIZONTAL AT 3 M

NO.	FREQ. (MHz)	EMISSION LEVEL (dBuV/m)	LIMIT (dBuV/m)	MARGIN (dB)	ANTENNA HEIGHT (m)	TABLE ANGLE (Degree)	RAW VALUE (dBuV)	CORRECTION FACTOR (dB/m)
1	5106.00	55.7 PK	74.0	-18.3	1.71 H	147	52.27	3.43
2	5106.00	46.1 AV	54.0	-7.9	1.71 H	147	42.67	3.43
3	*5270.00	112.1 PK			1.81 H	127	108.22	3.88
4	*5270.00	103.7 AV			1.81 H	127	99.82	3.88
5	5424.00	63.5 PK	74.0	-10.5	1.96 H	131	59.18	4.32
6	5424.00	53.9 AV	54.0	-0.1	1.96 H	131	49.58	4.32
7	#5709.00	64.7 PK	68.2	-3.5	1.69 H	112	59.77	4.93
8	#10540.00	58.7 PK	68.2	-9.5	1.61 H	114	48.91	9.79
9	15810.00	63.3 PK	74.0	-10.7	1.71 H	215	49.02	14.28
10	15810.00	51.3 AV	54.0	-2.7	1.71 H	215	37.02	14.28

ANTENNA POLARITY & TEST DISTANCE: VERTICAL AT 3 M

NO.	FREQ. (MHz)	EMISSION LEVEL (dBuV/m)	LIMIT (dBuV/m)	MARGIN (dB)	ANTENNA HEIGHT (m)	TABLE ANGLE (Degree)	RAW VALUE (dBuV)	CORRECTION FACTOR (dB/m)
1	5106.00	51.8 PK	74.0	-22.2	1.77 V	58	48.37	3.43
2	5106.00	42.2 AV	54.0	-11.8	1.77 V	58	38.77	3.43
3	*5270.00	108.3 PK			1.61 V	205	104.42	3.88
4	*5270.00	100.8 AV			1.61 V	205	96.92	3.88
5	5424.00	65.9 PK	74.0	-8.1	2.06 V	305	61.58	4.32
6	5424.00	48.1 AV	54.0	-5.9	2.06 V	305	43.78	4.32
7	#5709.00	54.8 PK	68.2	-13.4	2.04 V	39	49.87	4.93
8	#10540.00	56.4 PK	68.2	-11.8	2.10 V	337	46.61	9.79
9	15810.00	67.4 PK	74.0	-6.6	1.82 V	298	53.12	14.28
10	15810.00	51.8 AV	54.0	-2.2	1.82 V	298	37.52	14.28

REMARKS:

1. Emission Level(dBuV/m) = Raw Value(dBuV) + Correction Factor(dB/m)
2. Correction Factor(dB/m) = Antenna Factor(dB/m) + Cable Factor(dB) – Pre-Amplifier Factor(dB)
3. The other emission levels were very low against the limit.
4. Margin value = Emission Level – Limit value
5. " * ": Fundamental frequency.
6. " # ": The radiated frequency is out of the restricted band.

CHANNEL	TX Channel 62	DETECTOR FUNCTION	Peak (PK)
FREQUENCY RANGE	1GHz ~ 40GHz		Average (AV)

ANTENNA POLARITY & TEST DISTANCE: HORIZONTAL AT 3 M

NO.	FREQ. (MHz)	EMISSION LEVEL (dBuV/m)	LIMIT (dBuV/m)	MARGIN (dB)	ANTENNA HEIGHT (m)	TABLE ANGLE (Degree)	RAW VALUE (dBuV)	CORRECTION FACTOR (dB/m)
1	*5310.00	109.6 PK			1.82 H	132	105.68	3.92
2	*5310.00	100.9 AV			1.82 H	132	96.98	3.92
3	5350.00	65.9 PK	74.0	-8.1	1.79 H	132	61.82	4.08
4	5350.00	53.8 AV	54.0	-0.2	1.79 H	132	49.72	4.08
5	#5752.00	64.6 PK	68.2	-3.6	1.66 H	110	59.61	4.99
6	10620.00	58.0 PK	74.0	-16.0	1.20 H	17	47.96	10.04
7	10620.00	44.9 AV	54.0	-9.1	1.20 H	17	34.86	10.04
8	15930.00	66.7 PK	74.0	-7.3	1.03 H	7	52.17	14.53
9	15930.00	49.3 AV	54.0	-4.7	1.03 H	7	34.77	14.53

ANTENNA POLARITY & TEST DISTANCE: VERTICAL AT 3 M

NO.	FREQ. (MHz)	EMISSION LEVEL (dBuV/m)	LIMIT (dBuV/m)	MARGIN (dB)	ANTENNA HEIGHT (m)	TABLE ANGLE (Degree)	RAW VALUE (dBuV)	CORRECTION FACTOR (dB/m)
1	*5310.00	105.9 PK			1.95 V	196	101.98	3.92
2	*5310.00	98.1 AV			1.95 V	196	94.18	3.92
3	5350.00	58.1 PK	74.0	-15.9	2.24 V	303	54.02	4.08
4	5350.00	51.5 AV	54.0	-2.5	2.24 V	303	47.42	4.08
5	#5752.00	60.5 PK	68.2	-7.7	1.53 V	310	55.51	4.99
6	10620.00	56.2 PK	74.0	-17.8	1.81 V	301	46.16	10.04
7	10620.00	45.0 AV	54.0	-9.0	1.81 V	301	34.96	10.04
8	15930.00	63.6 PK	74.0	-10.4	1.11 V	316	49.07	14.53
9	15930.00	52.0 AV	54.0	-2.0	1.11 V	316	37.47	14.53

REMARKS:

1. Emission Level(dBuV/m) = Raw Value(dBuV) + Correction Factor(dB/m)
2. Correction Factor(dB/m) = Antenna Factor(dB/m) + Cable Factor(dB) – Pre-Amplifier Factor(dB)
3. The other emission levels were very low against the limit.
4. Margin value = Emission Level – Limit value
5. " * ": Fundamental frequency.
6. " # ": The radiated frequency is out of the restricted band.

CHANNEL	TX Channel 102	DETECTOR FUNCTION	Peak (PK)
FREQUENCY RANGE	1GHz ~ 40GHz		Average (AV)

ANTENNA POLARITY & TEST DISTANCE: HORIZONTAL AT 3 M

NO.	FREQ. (MHz)	EMISSION LEVEL (dBuV/m)	LIMIT (dBuV/m)	MARGIN (dB)	ANTENNA HEIGHT (m)	TABLE ANGLE (Degree)	RAW VALUE (dBuV)	CORRECTION FACTOR (dB/m)
1	#5470.00	67.9 PK	74.0	-6.1	1.66 H	137	63.55	4.35
2	#5470.00	53.9 AV	54.0	-0.1	1.66 H	137	49.55	4.35
3	*5510.00	111.2 PK			1.81 H	153	106.79	4.41
4	*5510.00	102.8 AV			1.81 H	153	98.39	4.41
5	11020.00	56.5 PK	74.0	-17.5	1.01 H	23	46.19	10.31
6	11020.00	43.6 AV	54.0	-10.4	1.01 H	23	33.29	10.31
7	#16530.00	66.7 PK	74.0	-7.3	1.06 H	26	49.91	16.79
8	#16530.00	50.3 AV	54.0	-3.7	1.06 H	26	33.51	16.79

ANTENNA POLARITY & TEST DISTANCE: VERTICAL AT 3 M

NO.	FREQ. (MHz)	EMISSION LEVEL (dBuV/m)	LIMIT (dBuV/m)	MARGIN (dB)	ANTENNA HEIGHT (m)	TABLE ANGLE (Degree)	RAW VALUE (dBuV)	CORRECTION FACTOR (dB/m)
1	#5470.00	67.8 PK	74.0	-6.2	1.85 V	117	63.45	4.35
2	#5470.00	48.7 AV	54.0	-5.3	1.85 V	117	44.35	4.35
3	*5510.00	106.2 PK			2.34 V	222	101.79	4.41
4	*5510.00	99.9 AV			2.34 V	222	95.49	4.41
5	11020.00	58.6 PK	74.0	-15.4	1.94 V	304	48.29	10.31
6	11020.00	47.2 AV	54.0	-6.8	1.94 V	304	36.89	10.31
7	#16530.00	63.7 PK	74.0	-10.3	1.16 V	309	46.91	16.79
8	#16530.00	52.3 AV	54.0	-1.7	1.16 V	309	35.51	16.79

REMARKS:

1. Emission Level(dBuV/m) = Raw Value(dBuV) + Correction Factor(dB/m)
2. Correction Factor(dB/m) = Antenna Factor(dB/m) + Cable Factor(dB) – Pre-Amplifier Factor(dB)
3. The other emission levels were very low against the limit.
4. Margin value = Emission Level – Limit value
5. " * ": Fundamental frequency.
6. " # ": The radiated frequency is out of the restricted band.

CHANNEL	TX Channel 118	DETECTOR FUNCTION	Peak (PK)
FREQUENCY RANGE	1GHz ~ 40GHz		Average (AV)

ANTENNA POLARITY & TEST DISTANCE: HORIZONTAL AT 3 M

NO.	FREQ. (MHz)	EMISSION LEVEL (dBuV/m)	LIMIT (dBuV/m)	MARGIN (dB)	ANTENNA HEIGHT (m)	TABLE ANGLE (Degree)	RAW VALUE (dBuV)	CORRECTION FACTOR (dB/m)
1	5426.00	63.4 PK	74.0	-10.6	1.77 H	131	59.09	4.31
2	5426.00	53.8 AV	54.0	-0.2	1.77 H	131	49.49	4.31
3	*5590.00	113.7 PK			1.77 H	132	108.89	4.81
4	*5590.00	105.5 AV			1.77 H	132	100.69	4.81
5	11180.00	57.0 PK	74.0	-17.0	1.77 H	108	46.55	10.45
6	11180.00	44.4 AV	54.0	-9.6	1.77 H	108	33.95	10.45
7	#16770.00	57.3 PK	74.0	-16.7	1.72 H	103	40.24	17.06
8	#16770.00	44.9 AV	54.0	-9.1	1.72 H	103	27.84	17.06

ANTENNA POLARITY & TEST DISTANCE: VERTICAL AT 3 M

NO.	FREQ. (MHz)	EMISSION LEVEL (dBuV/m)	LIMIT (dBuV/m)	MARGIN (dB)	ANTENNA HEIGHT (m)	TABLE ANGLE (Degree)	RAW VALUE (dBuV)	CORRECTION FACTOR (dB/m)
1	5426.00	60.7 PK	74.0	-13.3	2.03 V	202	56.39	4.31
2	5426.00	50.1 AV	54.0	-3.9	2.03 V	202	45.79	4.31
3	*5590.00	111.3 PK			1.83 V	207	106.49	4.81
4	*5590.00	103.7 AV			1.83 V	207	98.89	4.81
5	11180.00	60.5 PK	74.0	-13.5	1.90 V	260	50.05	10.45
6	11180.00	48.1 AV	54.0	-5.9	1.90 V	260	37.65	10.45
7	#16770.00	63.8 PK	74.0	-10.2	1.07 V	300	46.74	17.06
8	#16770.00	52.5 AV	54.0	-1.5	1.07 V	300	35.44	17.06

REMARKS:

1. Emission Level(dBuV/m) = Raw Value(dBuV) + Correction Factor(dB/m)
2. Correction Factor(dB/m) = Antenna Factor(dB/m) + Cable Factor(dB) – Pre-Amplifier Factor(dB)
3. The other emission levels were very low against the limit.
4. Margin value = Emission Level – Limit value
5. " * ": Fundamental frequency.
6. " # ": The radiated frequency is out of the restricted band.

CHANNEL	TX Channel 134	DETECTOR FUNCTION	Peak (PK)
FREQUENCY RANGE	1GHz ~ 40GHz		Average (AV)

ANTENNA POLARITY & TEST DISTANCE: HORIZONTAL AT 3 M

NO.	FREQ. (MHz)	EMISSION LEVEL (dBuV/m)	LIMIT (dBuV/m)	MARGIN (dB)	ANTENNA HEIGHT (m)	TABLE ANGLE (Degree)	RAW VALUE (dBuV)	CORRECTION FACTOR (dB/m)
1	*5670.00	116.8 PK			1.75 H	132	111.90	4.90
2	*5670.00	108.1 AV			1.75 H	132	103.20	4.90
3	#5725.00	67.9 PK	74.0	-6.1	1.31 H	131	62.94	4.96
4	#5725.00	53.2 AV	54.0	-0.8	1.31 H	131	48.24	4.96
5	11340.00	56.6 PK	74.0	-17.4	1.81 H	113	46.03	10.57
6	11340.00	44.5 AV	54.0	-9.5	1.81 H	113	33.93	10.57
7	#17010.00	58.3 PK	74.0	-15.7	1.64 H	117	41.60	16.70
8	#17010.00	45.2 AV	54.0	-8.8	1.64 H	117	28.50	16.70

ANTENNA POLARITY & TEST DISTANCE: VERTICAL AT 3 M

NO.	FREQ. (MHz)	EMISSION LEVEL (dBuV/m)	LIMIT (dBuV/m)	MARGIN (dB)	ANTENNA HEIGHT (m)	TABLE ANGLE (Degree)	RAW VALUE (dBuV)	CORRECTION FACTOR (dB/m)
1	*5670.00	111.1 PK			1.78 V	217	106.20	4.90
2	*5670.00	102.8 AV			1.78 V	217	97.90	4.90
3	#5725.00	68.2 PK	74.0	-5.8	1.20 V	326	63.24	4.96
4	#5725.00	50.4 AV	54.0	-3.6	1.20 V	326	45.44	4.96
5	11340.00	60.9 PK	74.0	-13.1	1.79 V	247	50.33	10.57
6	11340.00	48.5 AV	54.0	-5.5	1.79 V	247	37.93	10.57
7	#17010.00	63.7 PK	74.0	-10.3	1.00 V	333	47.00	16.70
8	#17010.00	51.9 AV	54.0	-2.1	1.00 V	333	35.20	16.70

REMARKS:

1. Emission Level(dBuV/m) = Raw Value(dBuV) + Correction Factor(dB/m)
2. Correction Factor(dB/m) = Antenna Factor(dB/m) + Cable Factor(dB) – Pre-Amplifier Factor(dB)
3. The other emission levels were very low against the limit.
4. Margin value = Emission Level – Limit value
5. " * ": Fundamental frequency.
6. " # ": The radiated frequency is out of the restricted band.

CHANNEL	TX Channel 142	DETECTOR FUNCTION	Peak (PK)
FREQUENCY RANGE	1GHz ~ 40GHz		Average (AV)

ANTENNA POLARITY & TEST DISTANCE: HORIZONTAL AT 3 M

NO.	FREQ. (MHz)	EMISSION LEVEL (dBuV/m)	LIMIT (dBuV/m)	MARGIN (dB)	ANTENNA HEIGHT (m)	TABLE ANGLE (Degree)	RAW VALUE (dBuV)	CORRECTION FACTOR (dB/m)
1	*5710.00	119.3 PK			1.65 H	179	114.37	4.93
2	*5710.00	110.3 AV			1.65 H	179	105.37	4.93
3	#5850.00	61.3 PK	74.0	-12.7	1.89 H	113	56.12	5.18
4	#5850.00	50.9 AV	54.0	-3.1	1.89 H	113	45.72	5.18
5	11420.00	56.5 PK	74.0	-17.5	1.57 H	112	46.02	10.48
6	11420.00	44.3 AV	54.0	-9.7	1.57 H	112	33.82	10.48
7	#17130.00	58.5 PK	74.0	-15.5	1.60 H	213	41.13	17.37
8	#17130.00	46.5 AV	54.0	-7.5	1.60 H	213	29.13	17.37

ANTENNA POLARITY & TEST DISTANCE: VERTICAL AT 3 M

NO.	FREQ. (MHz)	EMISSION LEVEL (dBuV/m)	LIMIT (dBuV/m)	MARGIN (dB)	ANTENNA HEIGHT (m)	TABLE ANGLE (Degree)	RAW VALUE (dBuV)	CORRECTION FACTOR (dB/m)
1	*5710.00	115.8 PK			1.87 V	199	110.87	4.93
2	*5710.00	106.9 AV			1.87 V	199	101.97	4.93
3	#5850.00	56.8 PK	74.0	-17.2	1.65 V	320	51.62	5.18
4	#5850.00	48.9 AV	54.0	-5.1	1.65 V	320	43.72	5.18
5	11420.00	60.8 PK	74.0	-13.2	1.75 V	221	50.32	10.48
6	11420.00	48.5 AV	54.0	-5.5	1.75 V	221	38.02	10.48
7	#17130.00	64.0 PK	74.0	-10.0	1.78 V	223	46.63	17.37
8	#17130.00	52.7 AV	54.0	-1.3	1.78 V	223	35.33	17.37

REMARKS:

1. Emission Level(dBuV/m) = Raw Value(dBuV) + Correction Factor(dB/m)
2. Correction Factor(dB/m) = Antenna Factor(dB/m) + Cable Factor(dB) – Pre-Amplifier Factor(dB)
3. The other emission levels were very low against the limit.
4. Margin value = Emission Level – Limit value
5. " * ": Fundamental frequency.
6. " # ": The radiated frequency is out of the restricted band.

802.11ac (VHT80)

CHANNEL	TX Channel 58	DETECTOR FUNCTION	Peak (PK)
FREQUENCY RANGE	1GHz ~ 40GHz		Average (AV)

ANTENNA POLARITY & TEST DISTANCE: HORIZONTAL AT 3 M

NO.	FREQ. (MHz)	EMISSION LEVEL (dBuV/m)	LIMIT (dBuV/m)	MARGIN (dB)	ANTENNA HEIGHT (m)	TABLE ANGLE (Degree)	RAW VALUE (dBuV)	CORRECTION FACTOR (dB/m)
1	4999.00	52.2 PK	74.0	-21.8	1.72 H	93	49.15	3.05
2	4999.00	43.5 AV	54.0	-10.5	1.72 H	93	40.45	3.05
3	*5290.00	106.1 PK			1.98 H	131	102.21	3.89
4	*5290.00	95.2 AV			1.98 H	131	91.31	3.89
5	5350.00	70.5 PK	74.0	-3.5	1.72 H	132	66.42	4.08
6	5350.00	53.9 AV	54.0	-0.1	1.72 H	132	49.82	4.08
7	#5877.00	60.2 PK	68.2	-8.0	1.53 H	113	54.95	5.25
8	#10580.00	55.8 PK	68.2	-12.4	1.92 H	109	45.85	9.95
9	15870.00	55.1 PK	74.0	-18.9	1.76 H	42	40.65	14.45
10	15870.00	43.8 AV	54.0	-10.2	1.76 H	42	29.35	14.45

ANTENNA POLARITY & TEST DISTANCE: VERTICAL AT 3 M

NO.	FREQ. (MHz)	EMISSION LEVEL (dBuV/m)	LIMIT (dBuV/m)	MARGIN (dB)	ANTENNA HEIGHT (m)	TABLE ANGLE (Degree)	RAW VALUE (dBuV)	CORRECTION FACTOR (dB/m)
1	4999.00	51.1 PK	74.0	-22.9	1.86 V	111	48.05	3.05
2	4999.00	40.9 AV	54.0	-13.1	1.86 V	111	37.85	3.05
3	*5290.00	101.6 PK			1.90 V	15	97.71	3.89
4	*5290.00	90.9 AV			1.90 V	15	87.01	3.89
5	5350.00	62.8 PK	74.0	-11.2	2.04 V	360	58.72	4.08
6	5350.00	49.0 AV	54.0	-5.0	2.04 V	360	44.92	4.08
7	#5877.00	58.6 PK	68.2	-9.6	1.97 V	106	53.35	5.25
8	#10580.00	56.4 PK	68.2	-11.8	1.44 V	136	46.45	9.95
9	15870.00	63.3 PK	74.0	-10.7	1.13 V	296	48.85	14.45
10	15870.00	51.4 AV	54.0	-2.6	1.13 V	296	36.95	14.45

REMARKS:

1. Emission Level(dBuV/m) = Raw Value(dBuV) + Correction Factor(dB/m)
2. Correction Factor(dB/m) = Antenna Factor(dB/m) + Cable Factor(dB) – Pre-Amplifier Factor(dB)
3. The other emission levels were very low against the limit.
4. Margin value = Emission Level – Limit value
5. " * ": Fundamental frequency.
6. " # ": The radiated frequency is out of the restricted band.



CHANNEL	TX Channel 106	DETECTOR FUNCTION	Peak (PK)
FREQUENCY RANGE	1GHz ~ 40GHz		Average (AV)

ANTENNA POLARITY & TEST DISTANCE: HORIZONTAL AT 3 M

NO.	FREQ. (MHz)	EMISSION LEVEL (dBuV/m)	LIMIT (dBuV/m)	MARGIN (dB)	ANTENNA HEIGHT (m)	TABLE ANGLE (Degree)	RAW VALUE (dBuV)	CORRECTION FACTOR (dB/m)
1	#5470.00	72.7 PK	74.0	-1.3	1.71 H	133	68.35	4.35
2	#5470.00	53.6 AV	54.0	-0.4	1.71 H	133	49.25	4.35
3	*5530.00	105.3 PK			1.80 H	132	100.78	4.52
4	*5530.00	94.6 AV			1.80 H	132	90.08	4.52
5	11060.00	57.6 PK	74.0	-16.4	2.01 H	130	47.22	10.38
6	11060.00	44.4 AV	54.0	-9.6	2.01 H	130	34.02	10.38
7	#16590.00	56.1 PK	74.0	-17.9	1.79 H	79	39.35	16.75
8	#16590.00	44.9 AV	54.0	-9.1	1.79 H	79	28.15	16.75

ANTENNA POLARITY & TEST DISTANCE: VERTICAL AT 3 M

NO.	FREQ. (MHz)	EMISSION LEVEL (dBuV/m)	LIMIT (dBuV/m)	MARGIN (dB)	ANTENNA HEIGHT (m)	TABLE ANGLE (Degree)	RAW VALUE (dBuV)	CORRECTION FACTOR (dB/m)
1	#5470.00	66.1 PK	74.0	-7.9	1.01 V	219	61.75	4.35
2	#5470.00	49.8 AV	54.0	-4.2	1.01 V	219	45.45	4.35
3	*5530.00	103.2 PK			1.83 V	118	98.68	4.52
4	*5530.00	92.1 AV			1.83 V	118	87.58	4.52
5	11060.00	57.3 PK	74.0	-16.7	1.43 V	127	46.92	10.38
6	11060.00	44.3 AV	54.0	-9.7	1.43 V	127	33.92	10.38
7	#16590.00	62.9 PK	74.0	-11.1	1.14 V	316	46.15	16.75
8	#16590.00	51.0 AV	54.0	-3.0	1.14 V	316	34.25	16.75

REMARKS:

1. Emission Level(dBuV/m) = Raw Value(dBuV) + Correction Factor(dB/m)
2. Correction Factor(dB/m) = Antenna Factor(dB/m) + Cable Factor(dB) – Pre-Amplifier Factor(dB)
3. The other emission levels were very low against the limit.
4. Margin value = Emission Level – Limit value
5. " * ": Fundamental frequency.
6. " # ": The radiated frequency is out of the restricted band.

CHANNEL	TX Channel 122	DETECTOR FUNCTION	Peak (PK)
FREQUENCY RANGE	1GHz ~ 40GHz		Average (AV)

ANTENNA POLARITY & TEST DISTANCE: HORIZONTAL AT 3 M

NO.	FREQ. (MHz)	EMISSION LEVEL (dBuV/m)	LIMIT (dBuV/m)	MARGIN (dB)	ANTENNA HEIGHT (m)	TABLE ANGLE (Degree)	RAW VALUE (dBuV)	CORRECTION FACTOR (dB/m)
1	*5610.00	113.2 PK			1.69 H	146	108.33	4.87
2	*5610.00	102.1 AV			1.69 H	146	97.23	4.87
3	#5725.00	68.6 PK	74.0	-5.4	1.85 H	145	63.64	4.96
4	#5725.00	53.6 AV	54.0	-0.4	1.85 H	145	48.64	4.96
5	11220.00	58.2 PK	74.0	-15.8	1.93 H	133	47.71	10.49
6	11220.00	44.5 AV	54.0	-9.5	1.93 H	133	34.01	10.49
7	#16830.00	56.0 PK	74.0	-18.0	1.69 H	60	38.96	17.04
8	#16830.00	44.5 AV	54.0	-9.5	1.69 H	60	27.46	17.04

ANTENNA POLARITY & TEST DISTANCE: VERTICAL AT 3 M

NO.	FREQ. (MHz)	EMISSION LEVEL (dBuV/m)	LIMIT (dBuV/m)	MARGIN (dB)	ANTENNA HEIGHT (m)	TABLE ANGLE (Degree)	RAW VALUE (dBuV)	CORRECTION FACTOR (dB/m)
1	*5610.00	109.3 PK			1.83 V	224	104.43	4.87
2	*5610.00	97.6 AV			1.83 V	224	92.73	4.87
3	#5725.00	59.5 PK	74.0	-14.5	1.57 V	206	54.54	4.96
4	#5725.00	49.5 AV	54.0	-4.5	1.57 V	206	44.54	4.96
5	11220.00	56.1 PK	74.0	-17.9	1.48 V	144	45.61	10.49
6	11220.00	43.5 AV	54.0	-10.5	1.48 V	144	33.01	10.49
7	#16830.00	62.6 PK	74.0	-11.4	1.07 V	297	45.56	17.04
8	#16830.00	50.4 AV	54.0	-3.6	1.07 V	297	33.36	17.04

REMARKS:

- Emission Level(dBuV/m) = Raw Value(dBuV) + Correction Factor(dB/m)
- Correction Factor(dB/m) = Antenna Factor(dB/m) + Cable Factor(dB) – Pre-Amplifier Factor(dB)
- The other emission levels were very low against the limit.
- Margin value = Emission Level – Limit value
- " * ": Fundamental frequency.
- " # ": The radiated frequency is out of the restricted band.

CHANNEL	TX Channel 138	DETECTOR FUNCTION	Peak (PK)
FREQUENCY RANGE	1GHz ~ 40GHz		Average (AV)

ANTENNA POLARITY & TEST DISTANCE: HORIZONTAL AT 3 M

NO.	FREQ. (MHz)	EMISSION LEVEL (dBuV/m)	LIMIT (dBuV/m)	MARGIN (dB)	ANTENNA HEIGHT (m)	TABLE ANGLE (Degree)	RAW VALUE (dBuV)	CORRECTION FACTOR (dB/m)
1	*5690.00	115.9 PK			1.83 H	119	110.99	4.91
2	*5690.00	104.6 AV			1.83 H	119	99.69	4.91
3	#5850.00	69.3 PK	74.0	-4.7	1.26 H	118	64.12	5.18
4	#5850.00	53.9 AV	54.0	-0.1	1.26 H	118	48.72	5.18
5	11380.00	57.9 PK	74.0	-16.1	1.98 H	151	47.40	10.50
6	11380.00	44.4 AV	54.0	-9.6	1.98 H	151	33.90	10.50
7	#17070.00	57.2 PK	74.0	-16.8	1.70 H	74	40.25	16.95
8	#17070.00	46.0 AV	54.0	-8.0	1.70 H	74	29.05	16.95

ANTENNA POLARITY & TEST DISTANCE: VERTICAL AT 3 M

NO.	FREQ. (MHz)	EMISSION LEVEL (dBuV/m)	LIMIT (dBuV/m)	MARGIN (dB)	ANTENNA HEIGHT (m)	TABLE ANGLE (Degree)	RAW VALUE (dBuV)	CORRECTION FACTOR (dB/m)
1	*5690.00	111.2 PK			1.54 V	116	106.29	4.91
2	*5690.00	99.3 AV			1.54 V	116	94.39	4.91
3	#5850.00	60.3 PK	74.0	-13.7	1.26 V	215	55.12	5.18
4	#5850.00	49.4 AV	54.0	-4.6	1.26 V	215	44.22	5.18
5	11380.00	57.5 PK	74.0	-16.5	1.46 V	131	47.00	10.50
6	11380.00	44.0 AV	54.0	-10.0	1.46 V	131	33.50	10.50
7	#17070.00	64.1 PK	74.0	-9.9	1.12 V	312	47.15	16.95
8	#17070.00	51.7 AV	54.0	-2.3	1.12 V	312	34.75	16.95

REMARKS:

1. Emission Level(dBuV/m) = Raw Value(dBuV) + Correction Factor(dB/m)
2. Correction Factor(dB/m) = Antenna Factor(dB/m) + Cable Factor(dB) – Pre-Amplifier Factor(dB)
3. The other emission levels were very low against the limit.
4. Margin value = Emission Level – Limit value
5. " * ": Fundamental frequency.
6. " # ": The radiated frequency is out of the restricted band.

4.2 Conducted Emission Measurement

4.2.1 Limits of Conducted Emission Measurement

Frequency (MHz)	Conducted Limit (dBuV)	
	Quasi-peak	Average
0.15 - 0.5	66 - 56	56 - 46
0.50 - 5.0	56	46
5.0 - 30.0	60	50

Note: 1. The lower limit shall apply at the transition frequencies.

2. The limit decreases in line with the logarithm of the frequency in the range of 0.15 to 0.50MHz.

4.2.2 Test Instruments

DESCRIPTION & MANUFACTURER	MODEL NO.	SERIAL NO.	CALIBRATED DATE	CALIBRATED UNTIL
Test Receiver ROHDE & SCHWARZ	ESCS 30	100375	Apr. 29, 2014	Apr. 28, 2015
Line-Impedance Stabilization Network (for EUT) SCHWARZBECK	NSLK-8127	8127-522	Sep. 15, 2014	Sep. 14, 2015
Line-Impedance Stabilization Network (for Peripheral) ROHDE & SCHWARZ	ENV216	100071	Nov. 10, 2014	Nov. 09, 2015
RF Cable (JYEBAO)	5D-FB	COCCAB-001	Mar. 09, 2015	Mar. 08, 2016
50 ohms Terminator	N/A	EMC-03	Sep. 22, 2014	Sep. 21, 2015
50 ohms Terminator	N/A	EMC-02	Sep. 30, 2014	Sep. 29, 2015
Software ADT	BV ADT_Cond_V7.3.7. 3	NA	NA	NA

Note:

1. The calibration interval of the above test instruments is 12 months and the calibrations are traceable to NML/ROC and NIST/USA.
2. The test was performed in Shielded Room No. C.
- 3 The VCCI Con C Registration No. is C-3611.
- 4 Tested Date: Mar. 11, 2015

4.2.3 Test Procedures

- a. The EUT was placed 0.4 meters from the conducting wall of the shielded room with EUT being connected to the power mains through a line impedance stabilization network (LISN). Other support units were connected to the power mains through another LISN. The two LISNs provide 50 ohm/ 50uH of coupling impedance for the measuring instrument.
- b. Both lines of the power mains connected to the EUT were checked for maximum conducted interference.
- c. The frequency range from 150kHz to 30MHz was searched. Emission levels under (Limit - 20dB) was not recorded.

NOTE: The resolution bandwidth and video bandwidth of test receiver is 9kHz for quasi-peak detection (QP) and average detection (AV) at frequency 0.15MHz-30MHz.

4.2.4 Deviation from Test Standard

No deviation.

4.2.5 Test Setup

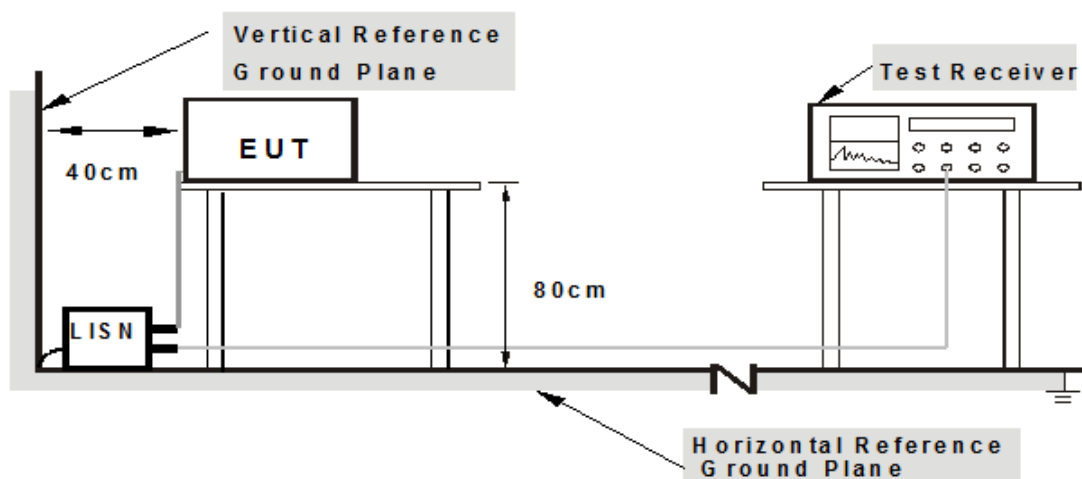

Note: 1. Support units were connected to second LISN.

For the actual test configuration, please refer to the attached file (Test Setup Photo).

4.2.6 EUT Operating Conditions

Same as 4.1.6.

4.2.7 Test Results

Phase	Line (L)	Detector Function	Quasi-Peak (QP) / Average (AV)
-------	----------	-------------------	--------------------------------

No	Freq. [MHz]	Corr.	Reading Value		Emission Level		Limit		Margin	
		Factor	[dB (uV)]		[dB (uV)]		[dB (uV)]		(dB)	
	(dB)	Q.P.	AV.	Q.P.	AV.	Q.P.	AV.	Q.P.	AV.	
1	0.16492	0.07	42.98	30.70	43.05	30.77	65.21	55.21	-22.17	-24.45
2	0.26038	0.08	31.05	24.33	31.13	24.41	61.42	51.42	-30.29	-27.01
3	0.45956	0.09	33.20	24.87	33.29	24.96	56.70	46.70	-23.41	-21.74
4	0.78332	0.12	24.75	17.81	24.87	17.93	56.00	46.00	-31.13	-28.07
5	15.29345	0.59	20.05	18.14	20.64	18.73	60.00	50.00	-39.36	-31.27
6	25.99701	0.82	21.61	16.77	22.43	17.59	60.00	50.00	-37.57	-32.41

REMARKS:

1. Q.P. and AV. are abbreviations of quasi-peak and average individually.
2. The emission levels of other frequencies were very low against the limit.
3. Margin value = Emission level - Limit value
4. Correction factor = Insertion loss + Cable loss
5. Emission Level = Correction Factor + Reading Value

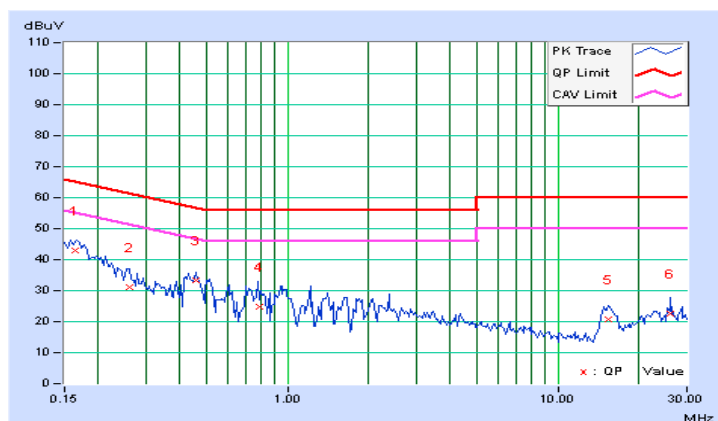

Phase	Neutral (N)	Detector Function	Quasi-Peak (QP) / Average (AV)
-------	-------------	-------------------	--------------------------------

No	Freq. [MHz]	Corr.	Reading Value		Emission Level		Limit		Margin	
		Factor	[dB (uV)]		[dB (uV)]		[dB (uV)]		(dB)	
	(dB)	Q.P.	AV.	Q.P.	AV.	Q.P.	AV.	Q.P.	AV.	
1	0.16212	0.06	40.93	24.60	40.99	24.66	65.35	55.35	-24.36	-30.69
2	0.19271	0.06	34.51	12.19	34.57	12.25	63.92	53.92	-29.35	-41.67
3	0.42687	0.09	34.30	30.53	34.39	30.62	57.31	47.31	-22.92	-16.69
4	0.77069	0.11	27.55	22.37	27.66	22.48	56.00	46.00	-28.34	-23.52
5	1.41847	0.15	28.52	21.47	28.67	21.62	56.00	46.00	-27.33	-24.38
6	15.83634	0.63	21.57	15.18	22.20	15.81	60.00	50.00	-37.80	-34.19

REMARKS:

1. Q.P. and AV. are abbreviations of quasi-peak and average individually.
2. The emission levels of other frequencies were very low against the limit.
3. Margin value = Emission level - Limit value
4. Correction factor = Insertion loss + Cable loss
5. Emission Level = Correction Factor + Reading Value.

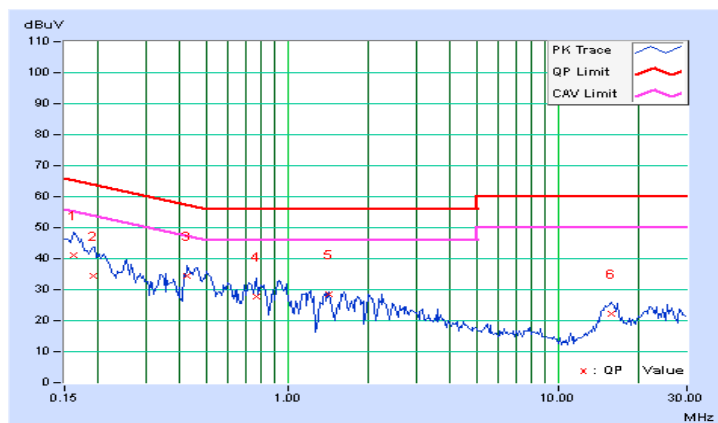

4.3 Transmit Power Measurement

4.3.1 Limits of Transmit Power Measurement

Operation Band	EUT Category		LIMIT
U-NII-1		Outdoor Access Point	1 Watt (30 dBm) (Max. e.i.r.p \leq 125mW(21 dBm) at any elevation angle above 30 degrees as measured from the horizon)
		Fixed point-to-point Access Point	1 Watt (30 dBm)
		Indoor Access Point	1 Watt (30 dBm)
		Mobile and Portable client device	250mW (24 dBm)
U-NII-2A		√	250mW (24 dBm) or 11 dBm+10 log B*
U-NII-2C		√	250mW (24 dBm) or 11 dBm+10 log B*
U-NII-3		√	1 Watt (30 dBm)

*B is the 26 dB emission bandwidth in megahertz

Per KDB 662911 D01 Multiple Transmitter Output Method of conducted output power measurement on IEEE 802.11 devices,

Array Gain = 0 dB (i.e., no array gain) for NANT \leq 4;

Array Gain = 0 dB (i.e., no array gain) for channel widths \geq 40 MHz for any NANT;

Array Gain = 5 log(NANT/NSS) dB or 3 dB, whichever is less for 20-MHz channel widths with NANT \geq 5.

For power measurements on all other devices: Array Gain = 10 log(NANT/NSS) dB.

4.3.2 Test Setup

FOR POWER OUTPUT MEASUREMENT

For channel straddling 5725MHz:

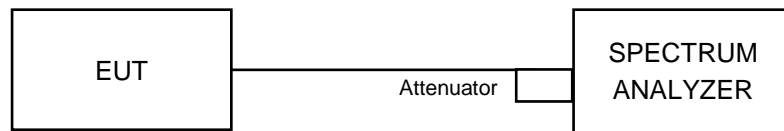

For other channels:

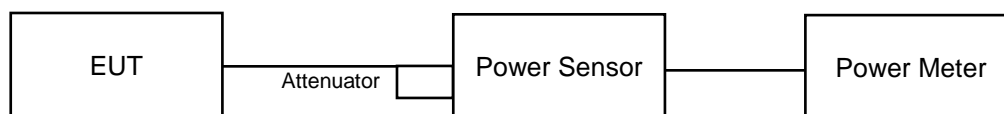

FOR 26dB OCCUPIED BANDWIDTH

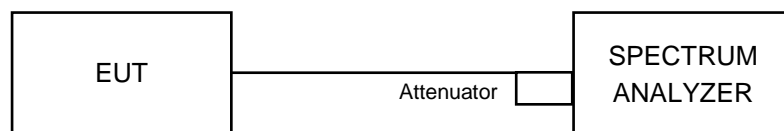

4.3.3 Test Instruments

Refer to section 4.1.2 to get information of above instrument.

4.3.4 Test Procedure

For POWER OUTPUT MEASUREMENT:

For channel straddling 5725MHz:

Follow FCC KDB 789033 UNII test procedure:

802.11ac (VHT40), 802.11ac (VHT80)

Method SA-2

1. Set span to encompass the emission bandwidth (EBW) of the signal.
2. Set RBW =1MHz.
3. Set the VBW $\geq 3 \times$ RBW.
4. Number of points in sweep ≥ 2 Span / RBW.
5. Sweep time = auto.
6. Detector = RMS.
7. Trace average at least 100 traces in power averaging mode
8. Compute power by integrating the spectrum across the 26 dB EBW of the signal.
9. Duty factor need added to measured value (duty cycle < 98 percent).

Other Modulation mode

Method SA-1

1. Set span to encompass the entire emission bandwidth (EBW) of the signal.
2. Set RBW =1MHz.
3. Set the VBW $\geq 3 \times$ RBW.
4. Number of points in sweep ≥ 2 Span / RBW.
5. Sweep time = auto.
6. Set trigger to free run (duty cycle ≥ 98 percent) ; Set video trigger (duty cycle < 98 percent)
7. Detector = RMS.
8. Trace average at least 100 traces in power averaging mode
9. Compute power by integrating the spectrum across the 26 dB EBW of the signal.

For other channels:

Method PM is used to perform output power measurement, trigger and gating function of wide band power meter is enabled to measure max output power of TX on burst. Duty factor is not added to measured value.

FOR 26dB OCCUPIED BANDWIDTH

1. Set RBW = approximately 1% of the emission bandwidth.
2. Set the VBW > RBW.
3. Detector = Peak.
4. Trace mode = max hold.
5. Measure the maximum width of the emission that is 26 dB down from the peak of the emission. Compare this with the RBW setting of the analyzer. Readjust RBW and repeat measurement as needed until the RBW/EBW ratio is approximately 1%.

4.3.5 Deviation from Test Standard

No deviation.

4.3.6 EUT Operating Conditions

The software provided by client to enable the EUT under transmission condition continuously at lowest, middle and highest channel frequencies individually.

4.3.7 Test Result

CDD MODE

802.11a

OUTPUT POWER:

Chan.	Chan. Freq. (MHz)	Average Power (dBm)			Total Power (mW)	Total Power (dBm)	Limit (dBm)	Pass / Fail
		Chain 0	Chain 1	Chain 2				
52	5260	16.36	15.76	15.97	120.458	20.81	24	Pass
60	5300	16.02	15.90	16.10	119.637	20.78	24	Pass
64	5320	16.36	15.52	15.90	117.801	20.71	24	Pass
100	5500	15.67	16.90	15.46	121.032	20.83	24	Pass
120	5600	16.81	15.93	15.20	120.26	20.80	24	Pass
140	5700	16.23	16.10	15.28	116.443	20.66	24	Pass
144 (UNII-2c Band)	5720	12.55	11.85	11.69	48.057	16.82	22.8	Pass
144 (UNII-3 Band)	5720	6.24	4.73	5.75	10.937	10.39	30	Pass

26dB BANDWIDTH:

Channel	Frequency (MHz)	26dBc Bandwidth (MHz)		
		Chain 0	Chain 1	Chain 2
52	5260	20.52	20.34	20.44
60	5300	20.48	20.35	20.52
64	5320	20.43	20.48	20.50
100	5500	20.76	20.41	20.41
120	5600	20.46	20.26	20.75
140	5700	20.36	20.38	20.85
144 (UNII-2c Band)	5720	15.27	15.16	15.46

Note: For FCC output power limitation is determined based on 26dB bandwidth.



Power Limit = $11\text{dBm} + 10\log B$ < U-NII-2A, U-NII-2C >			
Channel Number	Freq.(MHz)	Min. B(MHz)	Determined Conducted Limit (dBm)
52	5260	20.34	24.08 > 24
60	5300	20.35	24.08 > 24
64	5320	20.43	24.1 > 24
100	5500	20.41	24.09 > 24
120	5600	20.26	24.06 > 24
140	5700	20.36	24.08 > 24
144 (UNII-2c Band)	5720	15.16	22.8 < 24

802.11ac (VHT20)
OUTPUT POWER:

Chan.	Chan. Freq. (MHz)	Average Power (dBm)			Total Power (mW)	Total Power (dBm)	Limit (dBm)	Pass / Fail
		Chain 0	Chain 1	Chain 2				
52	5260	16.31	15.48	16.12	119	20.76	24	Pass
60	5300	16.47	15.21	15.63	114.109	20.57	24	Pass
64	5320	16.43	15.51	16.30	122.175	20.87	24	Pass
100	5500	16.88	16.11	15.01	121.281	20.84	24	Pass
120	5600	16.31	16.17	14.60	112.996	20.53	24	Pass
140	5700	16.70	16.22	14.82	118.992	20.76	24	Pass
144 (UNII-2c Band)	5720	12.23	12.04	13.34	54.284	17.35	22.83	Pass
144 (UNII-3 Band)	5720	16.31	15.48	16.12	13.653	11.35	30	Pass

26dB BANDWIDTH:

Channel	Frequency (MHz)	26dBc Bandwidth (MHz)		
		Chain 0	Chain 1	Chain 2
52	5260	20.80	20.65	20.76
60	5300	20.89	20.63	20.83
64	5320	20.71	20.82	20.69
100	5500	20.80	20.55	20.86
120	5600	20.88	20.46	20.70
140	5700	20.74	20.48	21.23
144 (UNII-2c Band)	5720	15.51	15.26	15.41

Note: For FCC output power limitation is determined based on 26dB bandwidth.

Power Limit = 11dBm + 10logB < U-NII-2A, U-NII-2C >			
Channel Number	Freq.(MHz)	Min. B(MHz)	Determined Conducted Limit (dBm)
52	5260	20.65	24.14 > 24
60	5300	20.63	24.14 > 24
64	5320	20.69	24.15 > 24
100	5500	20.55	24.12 > 24
120	5600	20.46	24.1 > 24
140	5700	20.48	24.11 > 24
144 (UNII-2c Band)	5720	15.26	22.83 < 24

802.11ac (VHT40)
OUTPUT POWER:

Chan.	Chan. Freq. (MHz)	Average Power (dBm)			Total Power (mW)	Total Power (dBm)	Limit (dBm)	Pass / Fail
		Chain 0	Chain 1	Chain 2				
54	5270	19.09	18.99	18.66	233.797	23.69	24	Pass
62	5310	16.99	15.79	16.38	131.385	21.19	24	Pass
102	5510	18.26	17.50	16.78	170.865	22.33	24	Pass
118	5590	19.76	18.93	18.34	241.021	23.82	24	Pass
134	5670	19.67	18.97	18.46	241.715	23.83	24	Pass
142 (UNII-2c Band)	5710	15.58	15.30	14.35	100.26	20.01	24	Pass
142 (UNII-3 Band)	5710	5.24	4.40	3.90	8.815	9.45	30	Pass

26dB BANDWIDTH:

Channel	Frequency (MHz)	26dBc Bandwidth (MHz)		
		Chain 0	Chain 1	Chain 2
54	5270	41.62	41.41	41.19
62	5310	41.27	41.03	41.39
102	5510	41.21	41.11	41.57
118	5590	43.80	41.79	41.53
134	5670	42.52	47.84	41.37
142 (UNII-2c Band)	5710	36.82	40.64	35.81

Note: For FCC output power limitation is determined based on 26dB bandwidth.

Power Limit = 11dBm + 10logB < U-NII-2A, U-NII-2C >			
Channel Number	Freq.(MHz)	Min. B(MHz)	Determined Conducted Limit (dBm)
54	5270	41.19	27.14 > 24
62	5310	41.03	27.13 > 24
102	5510	41.11	27.13 > 24
118	5590	41.53	27.18 > 24
134	5670	41.37	27.16 > 24
142 (UNII-2c Band)	5710	35.81	26.54 > 24

802.11ac (VHT80)
OUTPUT POWER:

Chan.	Chan. Freq. (MHz)	Average Power (dBm)			Total Power (mW)	Total Power (dBm)	Limit (dBm)	Pass / Fail
		Chain 0	Chain 1	Chain 2				
58	5290	16.78	16.37	16.81	138.967	21.43	24	Pass
106	5530	17.81	17.54	16.81	165.122	22.18	24	Pass
122	5610	19.31	18.91	18.82	239.322	23.79	24	Pass
138 (UNII-2c Band)	5690	15.50	14.64	16.83	120.366	20.81	24	Pass
138 (UNII-3 Band)	5690	1.33	0.15	2.83	4.602	6.63	30	Pass

26dB BANDWIDTH:

Channel	Frequency (MHz)	26dBc Bandwidth (MHz)		
		Chain 0	Chain 1	Chain 2
58	5290	82.96	82.74	83.06
106	5530	82.88	82.01	82.80
122	5610	83.78	82.79	83.18
138 (UNII-2c Band)	5690	76.33	76.17	76.55

Note: For FCC output power limitation is determined based on 26dB bandwidth.

Power Limit = 11dBm + 10logB < U-NII-2A, U-NII-2C >			
Channel Number	Freq.(MHz)	Min. B(MHz)	Determined Conducted Limit (dBm)
58	5290	82.74	30.17 > 24
106	5530	82.01	30.13 > 24
122	5610	82.79	30.17 > 24
138 (UNII-2c Band)	5690	76.17	29.81 > 24

SPECTRUM PLOT OF WORST VALUE

802.11a – Chain (1): CH 144 (UNII-2c Band)

802.11ac (VHT20) – Chain (1): CH 144 (UNII-2c Band)

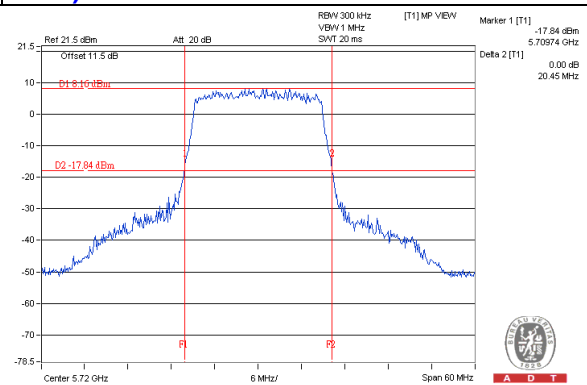
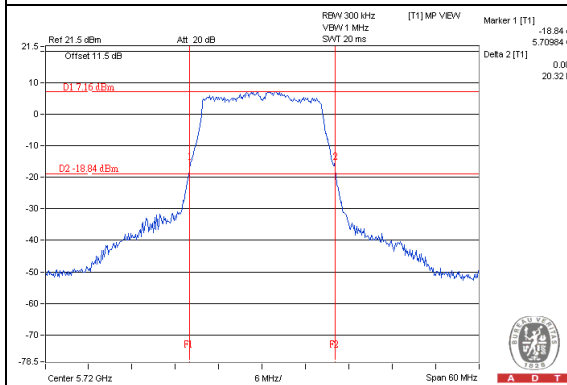

802.11ac (VHT40) – Chain (2): CH 142 (UNII-2c Band)

802.11ac (VHT80) – Chain (1): CH 138 (UNII-2c Band)

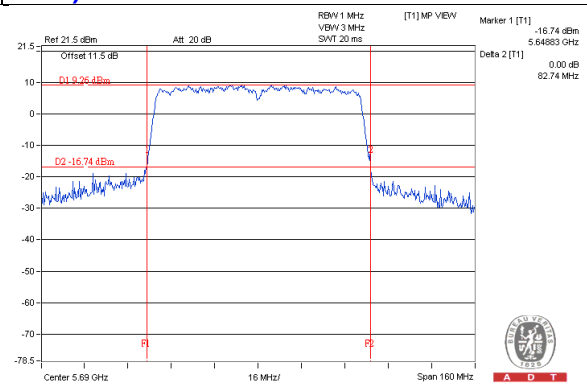
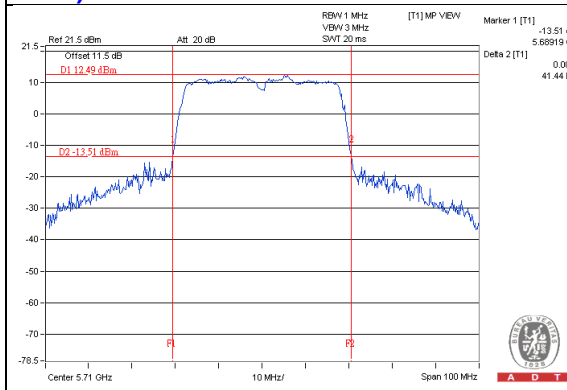

NOTE:

1. For CH144 (UNII-2c Band) = 5725 MHz - Marker 1
2. For CH142 (UNII-2c Band) = 5725 MHz - Marker 1
3. For CH138 (UNII-2c Band) = 5725 MHz - Marker 1

Beamforming MODE
802.11ac (VHT20)
OUTPUT POWER:

Chan.	Chan. Freq. (MHz)	Average Power (dBm)			Total Power (mW)	Total Power (dBm)	Limit (dBm)	Pass / Fail
		Chain 0	Chain 1	Chain 2				
52	5260	16.31	15.48	16.12	119	20.76	20.88	Pass
60	5300	16.47	15.21	15.63	114.109	20.57	20.88	Pass
64	5320	16.43	15.51	16.30	122.175	20.87	20.88	Pass
100	5500	16.88	16.11	15.01	121.281	20.84	20.88	Pass
120	5600	16.31	16.17	14.60	112.996	20.53	20.88	Pass
140	5700	16.70	16.22	14.82	118.992	20.76	20.88	Pass
144 (UNII-2c Band)	5720	12.23	12.04	13.34	54.284	17.35	19.71	Pass
144 (UNII-3 Band)	5720	6.40	5.79	7.40	13.653	11.35	26.88	Pass

NOTE:

Directional gain = $10 \log[(10^{G1/20} + 10^{G2/20} + 10^{G3/20})^2 / 3] = 9.12\text{dBi} > 6\text{dBi}$, therefore the limit needs to reduce, so the power limit shall be reduced to "Determined Conducted Limit-(9.12-6)"

26dB BANDWIDTH:

Channel	Frequency (MHz)	26dBc Bandwidth (MHz)		
		Chain 0	Chain 1	Chain 2
52	5260	20.80	20.65	20.76
60	5300	20.89	20.63	20.83
64	5320	20.71	20.82	20.69
100	5500	20.80	20.55	20.86
120	5600	20.88	20.46	20.70
140	5700	20.74	20.48	21.23
144 (UNII-2c Band)	5720	15.51	15.26	15.41

Note: For FCC output power limitation is determined based on 26dB bandwidth.



Power Limit = 11dBm + 10logB < U-NII-2A, U-NII-2C >			
Channel Number	Freq.(MHz)	Min. B(MHz)	Determined Conducted Limit (dBm)
52	5260	20.65	24.14 > 24
60	5300	20.63	24.14 > 24
64	5320	20.69	24.15 > 24
100	5500	20.55	24.12 > 24
120	5600	20.46	24.1 > 24
140	5700	20.48	24.11 > 24
144 (UNII-2c Band)	5720	15.26	22.83 < 24

802.11ac (VHT40)
OUTPUT POWER:

Chan.	Chan. Freq. (MHz)	Average Power (dBm)			Total Power (mW)	Total Power (dBm)	Limit (dBm)	Pass / Fail
		Chain 0	Chain 1	Chain 2				
54	5270	15.53	14.94	15.87	105.553	20.23	20.88	Pass
62	5310	12.53	10.85	12.62	48.349	16.84	20.88	Pass
102	5510	13.01	14.45	15.57	83.918	19.24	20.88	Pass
118	5590	14.07	16.25	16.50	112.365	20.51	20.88	Pass
134	5670	14.56	16.48	16.83	121.234	20.84	20.88	Pass
142 (UNII-2c Band)	5710	12.50	13.10	12.66	58.402	17.66	20.88	Pass
142 (UNII-3 Band)	5710	2.03	2.23	2.07	5.029	7.01	26.88	Pass

NOTE:

Directional gain = $10 \log[(10^{G1/20} + 10^{G2/20} + 10^{G3/20})^2 / 3] = 9.12\text{dBi} > 6\text{dBi}$, therefore the limit needs to reduce, so the power limit shall be reduced to "Determined Conducted Limit-(9.12-6)"

26dB BANDWIDTH:

Channel	Frequency (MHz)	26dBc Bandwidth (MHz)		
		Chain 0	Chain 1	Chain 2
54	5270	41.47	41.04	41.77
62	5310	41.72	41.01	41.52
102	5510	41.37	43.37	41.40
118	5590	41.40	41.10	41.60
134	5670	41.18	40.94	41.52
142 (UNII-2c Band)	5710	35.78	35.60	35.97

Note: For FCC output power limitation is determined based on 26dB bandwidth.

Power Limit = 11dBm + 10logB < U-NII-2A, U-NII-2C >			
Channel Number	Freq.(MHz)	Min. B(MHz)	Determined Conducted Limit (dBm)
54	5270	41.04	27.13 > 24
62	5310	41.01	27.12 > 24
102	5510	41.37	27.16 > 24
118	5590	41.10	27.13 > 24
134	5670	40.94	27.12 > 24
142 (UNII-2c Band)	5710	35.60	26.51 > 24

802.11ac (VHT80)
OUTPUT POWER:

Chan.	Chan. Freq. (MHz)	Average Power (dBm)			Total Power (mW)	Total Power (dBm)	Limit (dBm)	Pass / Fail
		Chain 0	Chain 1	Chain 2				
58	5290	12.48	10.27	12.38	45.64	16.59	20.88	Pass
106	5530	12.36	12.95	14.78	67.004	18.26	20.88	Pass
122	5610	14.66	16.59	16.65	121.084	20.83	20.88	Pass
138 (UNII-2c Band)	5690	12.12	11.65	11.37	47.624	16.78	20.88	Pass
138 (UNII-3 Band)	5690	-2.10	-2.41	-2.72	1.8413	2.65	26.88	Pass

NOTE:

Directional gain = $10 \log[10^{G1/20} + 10^{G2/20} + 10^{G3/20}]^2 / 3] = 9.12\text{dBi} > 6\text{dBi}$, therefore the limit needs to reduce, so the power limit shall be reduced to "Determined Conducted Limit-(9.12-6)"

26dB BANDWIDTH:

Channel	Frequency (MHz)	26dBc Bandwidth (MHz)		
		Chain 0	Chain 1	Chain 2
58	5290	82.67	82.49	82.98
106	5530	82.82	82.67	82.94
122	5610	82.79	82.99	82.96
138 (UNII-2c Band)	5690	76.71	76.63	76.65

Note: For FCC output power limitation is determined based on 26dB bandwidth.

Power Limit = $11\text{dBm} + 10\log B < \text{U-NII-2A, U-NII-2C} >$			
Channel Number	Freq.(MHz)	Min. B(MHz)	Determined Conducted Limit (dBm)
58	5290	82.49	30.16 > 24
106	5530	82.67	30.17 > 24
122	5610	82.79	30.17 > 24
138 (UNII-2c Band)	5690	76.63	29.84 > 24

SPECTRUM PLOT OF WORST VALUE

802.11ac (VHT20) – Chain (1): CH 144 (UNII-2c Band)

802.11ac (VHT40) – Chain (1): CH 142 (UNII-2c Band)

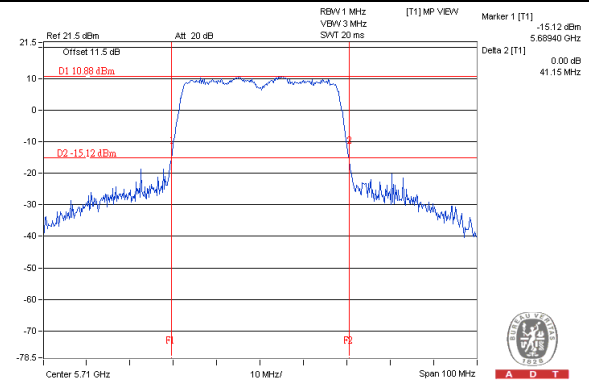
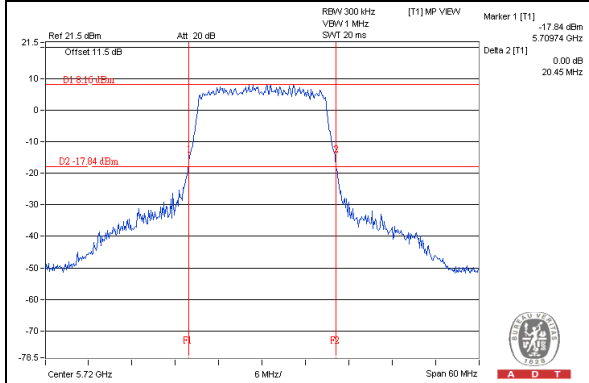

802.11ac (VHT80) – Chain (1): CH 138 (UNII-2c Band)



NOTE:

1. For CH144 (UNII-2c Band) = 5725 MHz - Marker 1
2. For CH142 (UNII-2c Band) = 5725 MHz - Marker 1
3. For CH138 (UNII-2c Band) = 5725 MHz - Marker 1

4.4 Peak Power Spectral Density Measurement

4.4.1 Limits of Peak Power Spectral Density Measurement

Operation Band	EUT Category		LIMIT
U-NII-1		Outdoor Access Point	17dBm/ MHz
		Fixed point-to-point Access Point	
		Indoor Access Point	
		Mobile and Portable client device	11dBm/ MHz
U-NII-2A	√		11dBm/ MHz
U-NII-2C	√		11dBm/ MHz
U-NII-3	√		30dBm/ MHz

4.4.2 Test Setup

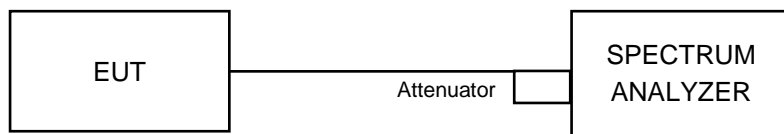

4.4.3 Test Instruments

Refer to section 4.1.2 to get information of above instrument.

4.4.4 Test Procedures

※For U-NII-1, U-NII-2A & U-NII-2C:

1. Set span to encompass the entire emission bandwidth (EBW) of the signal.
2. Set RBW = 1 MHz, Set VBW \geq 3 MHz, Detector = RMS
3. Sweep time = auto, trigger set to “free run”.
4. Trace average at least 100 traces in power averaging mode.
5. Record the max value and for duty cycle of test signal is < 98% add 10 log (1/duty cycle)

※For U-NII-3:

1. Set span to encompass the entire emission bandwidth (EBW) of the signal.
2. Set RBW = 300 kHz, Set VBW \geq 1 MHz, Detector = RMS
3. Use the peak marker function to determine the maximum power level in any 300 kHz band segment within the fundamental EBW.
4. Scale the observed power level to an equivalent value in 500 kHz by adjusting (reducing) the measured power by a bandwidth correction factor (BWCF) where $BWCF = 10\log(500 \text{ kHz}/300\text{kHz})$
5. Sweep time = auto, trigger set to “free run”.
6. Trace average at least 100 traces in power averaging mode.
7. Record the max value and for duty cycle of test signal is < 98% add 10 log (1/duty cycle)

4.4.5 Deviation from Test Standard

No deviation.

4.4.6 EUT Operating Conditions

Same as Item 4.3.6.

4.4.7 Test Results

CDD MODE

For U-NII-2A, U-NII-2C Band

802.11a

Chan.	Chan. Freq. (MHz)	PSD (dBm)			Total Power Density (dBm)	MAX. Limit (dBm)	Pass / Fail
		Chain 0	Chain 1	Chain 2			
52	5260	2.57	1.98	3.74	7.60	7.88	Pass
60	5300	2.73	2.11	3.45	7.57	7.88	Pass
64	5320	2.62	2.28	3.42	7.57	7.88	Pass
100	5500	2.80	2.94	3.14	7.73	7.88	Pass
120	5600	3.50	2.88	2.28	7.69	7.88	Pass
140	5700	3.21	2.69	2.28	7.51	7.88	Pass
144 (UNII-2c Band)	5720	3.33	2.62	2.28	7.54	7.88	Pass

NOTE: 1. Method a) of power density measurement of KDB 662911 is using for calculating total power density. Total power density is summing entire spectra across corresponding frequency bins on the various outputs by computer.

2. Directional gain = $10 \log[(10^{G1/20} + 10^{G2/20} + 10^{G3/20})^2 / 3] = 9.12\text{dBi} > 6\text{dBi}$, so the power density limit shall be reduced to $11-(9.12-6) = 7.88\text{dBm}$.

802.11ac (VHT20)

Chan.	Chan. Freq. (MHz)	PSD (dBm)			Total Power Density (dBm)	MAX. Limit (dBm)	Pass / Fail
		Chain 0	Chain 1	Chain 2			
52	5260	2.16	2.40	3.26	7.40	7.88	Pass
60	5300	2.37	2.24	3.37	7.46	7.88	Pass
64	5320	2.60	2.37	3.37	7.57	7.88	Pass
100	5500	3.47	2.46	3.25	7.85	7.88	Pass
120	5600	3.07	2.40	3.18	7.67	7.88	Pass
140	5700	2.93	2.06	4.03	7.85	7.88	Pass
144 (UNII-2c Band)	5720	2.83	2.02	3.97	7.79	7.88	Pass

NOTE: 1. Method a) of power density measurement of KDB 662911 is using for calculating total power density. Total power density is summing entire spectra across corresponding frequency bins on the various outputs by computer.

2. Directional gain = $10 \log[(10^{G1/20} + 10^{G2/20} + 10^{G3/20})^2 / 3] = 9.12\text{dBi} > 6\text{dBi}$, so the power density limit shall be reduced to $11-(9.12-6) = 7.88\text{dBm}$.

802.11ac (VHT40)

Chan.	Chan. Freq. (MHz)	PSD W/O Duty Factor (dBm)			Duty Factor (dB)	Total PSD With Duty Factor (dBm)	MAX. Limit (dBm)	Pass / Fail
		Chain 0	Chain 1	Chain 2				
54	5270	1.69	2.19	2.68	0.13	7.11	7.88	Pass
62	5310	-0.46	-0.82	0.23	0.13	4.58	7.88	Pass
102	5510	1.14	0.50	2.11	0.13	6.20	7.88	Pass
118	5590	2.80	2.54	1.77	0.13	7.30	7.88	Pass
134	5670	2.47	2.21	1.14	0.13	6.88	7.88	Pass
142 (UNII-2c Band)	5710	2.50	2.40	1.19	0.13	6.97	7.88	Pass

- NOTE:** 1. Method a) of power density measurement of KDB 662911 is using for calculating total power density. Total power density is summing entire spectra across corresponding frequency bins on the various outputs by computer.
2. Directional gain = $10 \log[(10^{G1/20} + 10^{G2/20} + 10^{G3/20})^2 / 3] = 9.12\text{dBi} > 6\text{dBi}$, so the power density limit shall be reduced to $11-(9.12-6) = 7.88\text{dBm}$.
3. Refer to section 3.3 for duty cycle spectrum plot.

802.11ac (VHT80)

Chan.	Chan. Freq. (MHz)	PSD W/O Duty Factor (dBm)			Duty Factor (dB)	Total PSD With Duty Factor (dBm)	MAX. Limit (dBm)	Pass / Fail
		Chain 0	Chain 1	Chain 2				
58	5290	-3.14	-3.45	-2.33	0.28	2.11	7.88	Pass
106	5530	-2.19	-2.88	-1.20	0.28	3.02	7.88	Pass
122	5610	-0.95	-2.18	0.44	0.28	4.29	7.88	Pass
138 (UNII-2c Band)	5690	-0.90	-2.25	0.69	0.28	4.40	7.88	Pass

- NOTE:** 1. Method a) of power density measurement of KDB 662911 is using for calculating total power density. Total power density is summing entire spectra across corresponding frequency bins on the various outputs by computer.
2. Directional gain = $10 \log[(10^{G1/20} + 10^{G2/20} + 10^{G3/20})^2 / 3] = 9.12\text{dBi} > 6\text{dBi}$, so the power density limit shall be reduced to $11-(9.12-6) = 7.88\text{dBm}$.
3. Refer to section 3.3 for duty cycle spectrum plot.

SPECTRUM PLOT OF WORST VALUE

802.11a – Chain (2): CH 52

802.11ac (VHT20) – Chain (2): CH 140

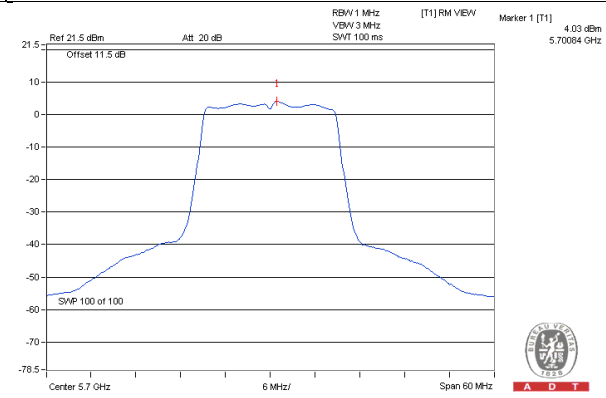
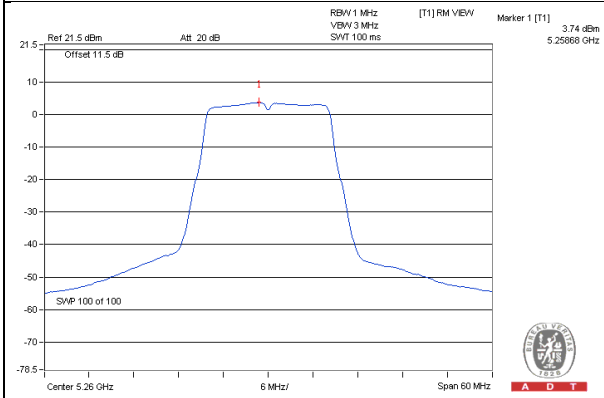

802.11ac (VHT40) – Chain (0): CH 118

802.11ac (VHT80) – Chain (2): CH 138 (UNII-2c Band)

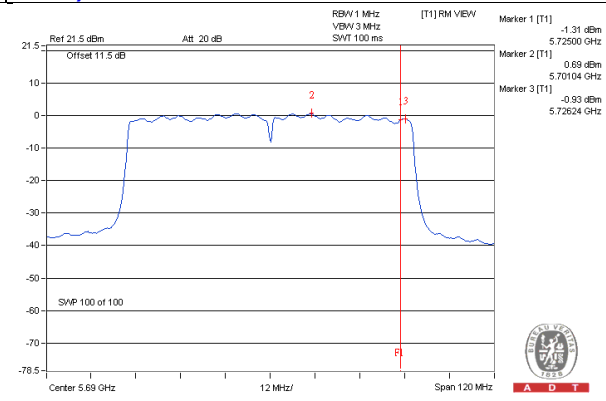
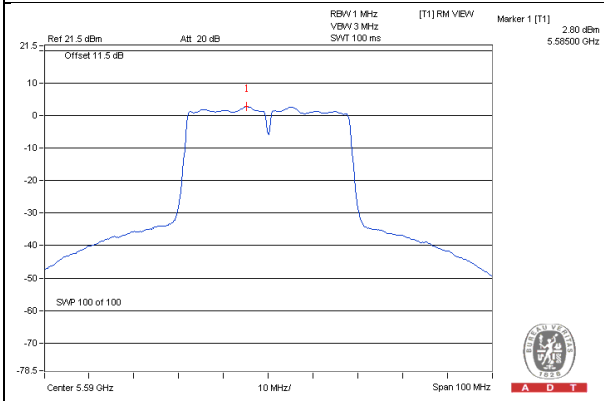

For U-NII-3 Band
802.11a

TX Chain	Channel	Frequency (MHz)	PSD (dBm/300kHz)	PSD (dBm/500kHz)	10 log (N=3) dB	Total PSD (dBm/500kHz)	Limit (dBm/500kHz)	Pass /Fail
0	144 (UNII-3 Band)	5720	-6.13	-3.91	4.77	0.86	26.88	Pass
1	144 (UNII-3 Band)	5720	-7.61	-5.39	4.77	-0.62	26.88	Pass
2	144 (UNII-3 Band)	5720	-6.99	-4.77	4.77	0.00	26.88	Pass

NOTE: 1. Method a) of power density measurement of KDB 662911 is using for calculating total power density. Total power density is summing entire spectra across corresponding frequency bins on the various outputs by computer.

2. Directional gain = $10 \log[(10^{G1/20} + 10^{G2/20} + 10^{G3/20})^2 / 3] = 9.12\text{dBi} > 6\text{dBi}$, so the power density limit shall be reduced to $30-(9.12-6) = 26.88\text{dBm}$.

802.11ac (VHT20)

TX Chain	Channel	Frequency (MHz)	PSD (dBm/300kHz)	PSD (dBm/500kHz)	10 log (N=3) dB	Total PSD (dBm/500kHz)	Limit (dBm/500kHz)	Pass /Fail
0	144 (UNII-3 Band)	5720	-6.35	-4.13	4.77	0.64	26.88	Pass
1	144 (UNII-3 Band)	5720	-6.14	-3.92	4.77	0.85	26.88	Pass
2	144 (UNII-3 Band)	5720	-5.22	-3.00	4.77	1.77	26.88	Pass

NOTE: 1. Method a) of power density measurement of KDB 662911 is using for calculating total power density. Total power density is summing entire spectra across corresponding frequency bins on the various outputs by computer.

2. Directional gain = $10 \log[(10^{G1/20} + 10^{G2/20} + 10^{G3/20})^2 / 3] = 9.12\text{dBi} > 6\text{dBi}$, so the power density limit shall be reduced to $30-(9.12-6) = 26.88\text{dBm}$.

802.11ac (VHT40)

TX chain	Chan.	Chan. Freq. (MHz)	PSD W/O Duty Factor		10 log (N=3) dB	Duty Factor (dB)	Total PSD With Duty Factor (dBm/500kHz)	Limit (dBm/500kHz)	Pass /Fail
			(dBm/300kHz)	(dBm/500kHz)					
0	142 (UNII-3 Band)	5710	-6.60	-4.38	4.77	0.13	0.52	26.88	Pass
1	142 (UNII-3 Band)	5710	-6.68	-4.46	4.77	0.13	0.44	26.88	Pass
2	142 (UNII-3 Band)	5710	-8.03	-5.81	4.77	0.13	-0.91	26.88	Pass

NOTE: 1. Method a) of power density measurement of KDB 662911 is using for calculating total power density. Total power density is summing entire spectra across corresponding frequency bins on the various outputs by computer.

2. Directional gain = $10 \log[(10^{G1/20} + 10^{G2/20} + 10^{G3/20})^2 / 3] = 9.12\text{dBi} > 6\text{dBi}$, so the power density limit shall be reduced to $30-(9.12-6) = 26.88\text{dBm}$.

3. Refer to section 3.3 for duty cycle spectrum plot.

802.11ac (VHT80)

TX chain	Chan.	Chan. Freq. (MHz)	PSD W/O Duty Factor		10 log (N=3) dB	Duty Factor (dB)	Total PSD With Duty Factor (dBm/500kHz)	Limit (dBm/500kHz)	Pass /Fail
			(dBm/300kHz)	(dBm/500kHz)					
0	138 (UNII-3 Band)	5690	-10.74	-8.52	4.77	0.28	-3.47	26.88	Pass
1	138 (UNII-3 Band)	5690	-11.64	-9.42	4.77	0.28	-4.37	26.88	Pass
2	138 (UNII-3 Band)	5690	-9.74	-7.52	4.77	0.28	-2.47	26.88	Pass

NOTE: 1. Method a) of power density measurement of KDB 662911 is using for calculating total power density. Total power density is summing entire spectra across corresponding frequency bins on the various outputs by computer.

2. Directional gain = $10 \log[(10^{G1/20} + 10^{G2/20} + 10^{G3/20})^2 / 3] = 9.12\text{dBi} > 6\text{dBi}$, so the power density limit shall be reduced to $30-(9.12-6) = 26.88\text{dBm}$.

3. Refer to section 3.3 for duty cycle spectrum plot.

SPECTRUM PLOT OF WORST VALUE

802.11a – Chain (0): CH 144 (UNII-3 Band)

802.11ac (VHT20) – Chain (2): CH 144 (UNII-3 Band)

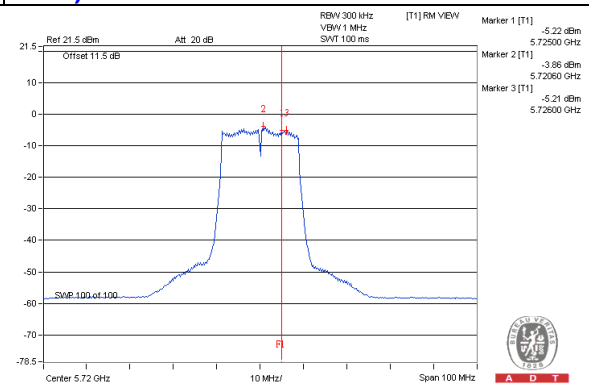
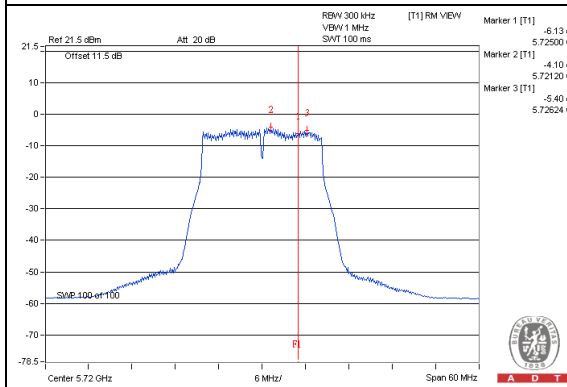

802.11ac (VHT40) – Chain (0): CH 142 (UNII-3 Band)

802.11ac (VHT80) – Chain (2): CH 138 (UNII-3 Band)

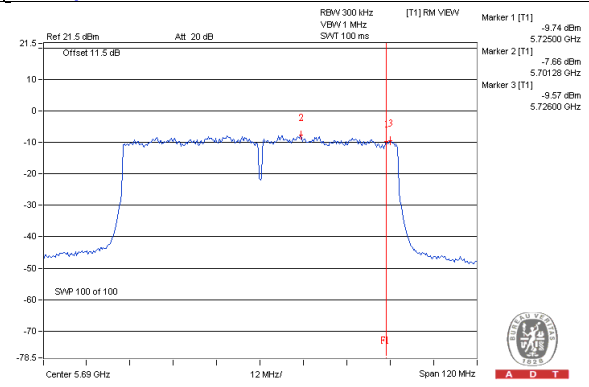
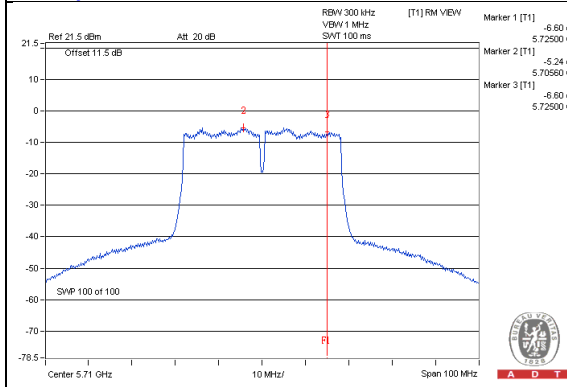

Beamforming MODE
For U-NII-2A, U-NII-2C Band
802.11ac (VHT20)

Chan.	Chan. Freq. (MHz)	PSD (dBm)			Total Power Density (dBm)	MAX. Limit (dBm)	Pass / Fail
		Chain 0	Chain 1	Chain 2			
52	5260	2.16	2.40	3.26	7.40	7.88	Pass
60	5300	2.37	2.24	3.37	7.46	7.88	Pass
64	5320	2.60	2.37	3.37	7.57	7.88	Pass
100	5500	3.47	2.46	3.25	7.85	7.88	Pass
120	5600	3.07	2.40	3.18	7.67	7.88	Pass
140	5700	2.93	2.06	4.03	7.85	7.88	Pass
144 (UNII-2c Band)	5720	2.83	2.02	3.97	7.79	7.88	Pass

- NOTE:** 1. Method a) of power density measurement of KDB 662911 is using for calculating total power density. Total power density is summing entire spectra across corresponding frequency bins on the various outputs by computer.
2. Directional gain = $10 \log[(10^{G1/20} + 10^{G2/20} + 10^{G3/20})^2 / 3] = 9.12\text{dBi} > 6\text{dBi}$, so the power density limit shall be reduced to $11-(9.12-6) = 7.88\text{dBm}$.

802.11ac (VHT40)

Chan.	Chan. Freq. (MHz)	PSD W/O Duty Factor (dBm)			Duty Factor (dB)	Total PSD With Duty Factor (dBm)	MAX. Limit (dBm)	Pass / Fail
		Chain 0	Chain 1	Chain 2				
54	5270	-1.48	-2.04	-0.33	0.13	3.68	7.88	Pass
62	5310	-4.03	-5.43	-3.07	0.13	0.83	7.88	Pass
102	5510	-1.16	-0.99	-1.92	0.13	3.57	7.88	Pass
118	5590	-0.43	-1.07	-1.56	0.13	3.91	7.88	Pass
134	5670	-0.91	-0.12	-0.95	0.13	4.26	7.88	Pass
142 (UNII-2c Band)	5710	-0.69	0.06	-0.90	0.13	4.41	7.88	Pass

- NOTE:** 1. Method a) of power density measurement of KDB 662911 is using for calculating total power density. Total power density is summing entire spectra across corresponding frequency bins on the various outputs by computer.
2. Directional gain = $10 \log[(10^{G1/20} + 10^{G2/20} + 10^{G3/20})^2 / 3] = 9.12\text{dBi} > 6\text{dBi}$, so the power density limit shall be reduced to $11-(9.12-6) = 7.88\text{dBm}$.
3. Refer to section 3.3 for duty cycle spectrum plot.

802.11ac (VHT80)

Chan.	Chan. Freq. (MHz)	PSD W/O Duty Factor (dBm)			Duty Factor (dB)	Total PSD With Duty Factor (dBm)	MAX. Limit (dBm)	Pass / Fail
		Chain 0	Chain 1	Chain 2				
58	5290	-8.05	-8.88	-7.28	0.28	-2.97	7.88	Pass
106	5530	-5.22	-6.66	-6.59	0.28	-1.05	7.88	Pass
122	5610	-4.14	-4.54	-3.96	0.28	0.85	7.88	Pass
138 (UNII-2c Band)	5690	-4.30	-4.62	-5.05	0.28	0.41	7.88	Pass

- NOTE:** 1. Method a) of power density measurement of KDB 662911 is using for calculating total power density. Total power density is summing entire spectra across corresponding frequency bins on the various outputs by computer.
2. Directional gain = $10 \log[(10^{G1/20} + 10^{G2/20} + 10^{G3/20})^2 / 3] = 9.12\text{dBi} > 6\text{dBi}$, so the power density limit shall be reduced to $11-(9.12-6) = 7.88\text{dBm}$.
3. Refer to section 3.3 for duty cycle spectrum plot.

SPECTRUM PLOT OF WORST VALUE

802.11ac (VHT20) – Chain (2): CH 140

802.11ac (VHT40) – Chain (1): CH 142 (UNII-2c Band)

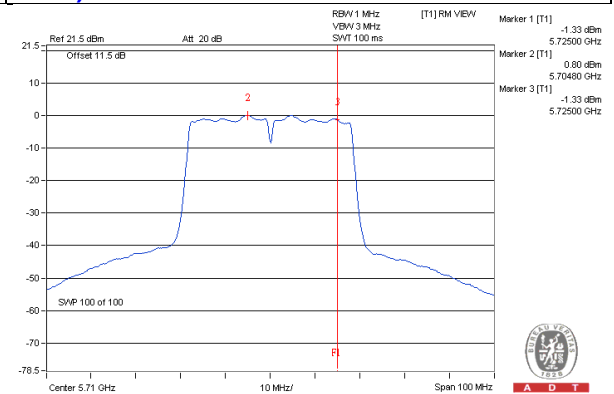
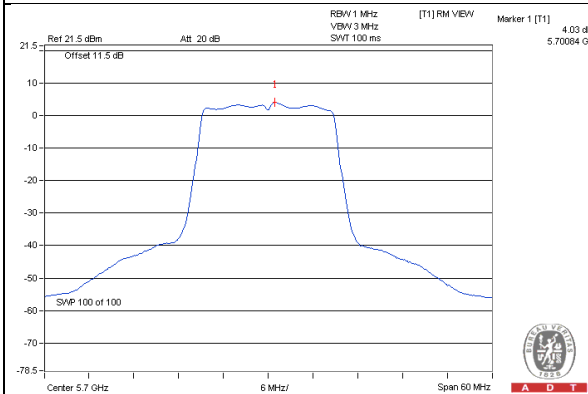

802.11ac (VHT80) – Chain (2): CH 122

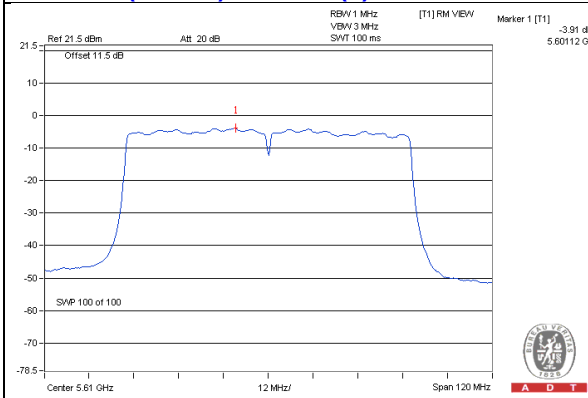

For U-NII-3 Band
802.11ac (VHT20)

TX Chain	Channel	Frequency (MHz)	PSD (dBm/300kHz)	PSD (dBm/500kHz)	10 log (N=3) dB	Total PSD (dBm/500kHz)	Limit (dBm/500kHz)	Pass /Fail
0	144 (UNII-3 Band)	5720	-6.35	-4.13	4.77	0.64	26.88	Pass
1	144 (UNII-3 Band)	5720	-6.14	-3.92	4.77	0.85	26.88	Pass
2	144 (UNII-3 Band)	5720	-5.22	-3.00	4.77	1.77	26.88	Pass

NOTE: 1. Method a) of power density measurement of KDB 662911 is using for calculating total power density. Total power density is summing entire spectra across corresponding frequency bins on the various outputs by computer.

2. Directional gain = $10 \log[(10^{G1/20} + 10^{G2/20} + 10^{G3/20})^2 / 3] = 9.12\text{dBi} > 6\text{dBi}$, so the power density limit shall be reduced to $30-(9.12-6) = 26.88\text{dBm}$.

802.11ac (VHT40)

TX chain	Chan.	Chan. Freq. (MHz)	PSD W/O Duty Factor		10 log (N=3) dB	Duty Factor (dB)	Total PSD With Duty Factor (dBm/500kHz)	Limit (dBm/500kHz)	Pass /Fail
			(dBm/300kHz)	(dBm/500kHz)					
0	142 (UNII-3 Band)	5710	-9.89	-7.67	4.77	0.13	-2.77	26.88	Pass
1	142 (UNII-3 Band)	5710	-8.94	-6.72	4.77	0.13	-1.82	26.88	Pass
2	142 (UNII-3 Band)	5710	-10.45	-8.23	4.77	0.13	-3.33	26.88	Pass

NOTE: 1. Method a) of power density measurement of KDB 662911 is using for calculating total power density. Total power density is summing entire spectra across corresponding frequency bins on the various outputs by computer.

2. Directional gain = $10 \log[(10^{G1/20} + 10^{G2/20} + 10^{G3/20})^2 / 3] = 9.12\text{dBi} > 6\text{dBi}$, so the power density limit shall be reduced to $30-(9.12-6) = 26.88\text{dBm}$.

3. Refer to section 3.3 for duty cycle spectrum plot.

802.11ac (VHT80)

TX chain	Chan.	Chan. Freq. (MHz)	PSD W/O Duty Factor		10 log (N=3) dB	Duty Factor (dB)	Total PSD With Duty Factor (dBm/500kHz)	Limit (dBm/500kHz)	Pass /Fail
			(dBm/300kHz)	(dBm/500kHz)					
0	138 (UNII-3 Band)	5690	-14.09	-11.87	4.77	0.28	-6.82	26.88	Pass
1	138 (UNII-3 Band)	5690	-14.36	-12.14	4.77	0.28	-7.09	26.88	Pass
2	138 (UNII-3 Band)	5690	-15.16	-12.94	4.77	0.28	-7.89	26.88	Pass

- NOTE:**
- Method a) of power density measurement of KDB 662911 is using for calculating total power density. Total power density is summing entire spectra across corresponding frequency bins on the various outputs by computer.
 - Directional gain = $10 \log[(10^{G1/20} + 10^{G2/20} + 10^{G3/20})^2 / 3] = 9.12\text{dBi} > 6\text{dBi}$, so the power density limit shall be reduced to $30 - (9.12 - 6) = 26.88\text{dBm}$.
 - Refer to section 3.3 for duty cycle spectrum plot.

SPECTRUM PLOT OF WORST VALUE

802.11ac (VHT20) – Chain (2): CH 144 (UNII-3 Band) **802.11ac (VHT40) – Chain (1): CH 142 (UNII-3 Band)**

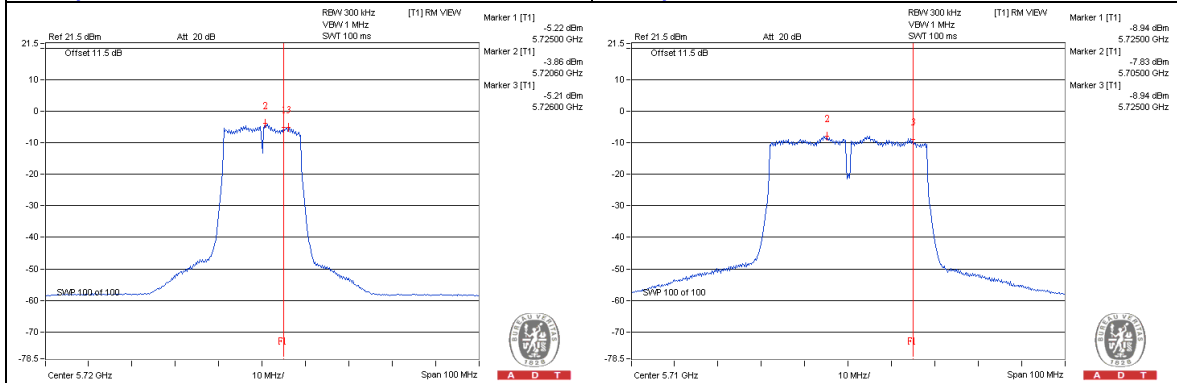

802.11ac (VHT80) – Chain (0): CH 138 (UNII-3 Band)

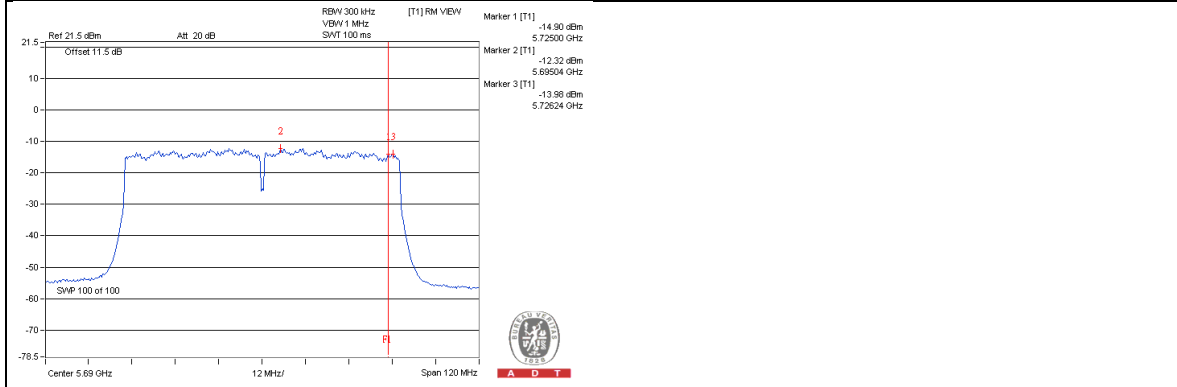

4.5 Frequency Stability

4.5.1 Limits of Frequency Stability Measurement

The frequency of the carrier signal shall be maintained within band of operation

4.5.2 Test Setup

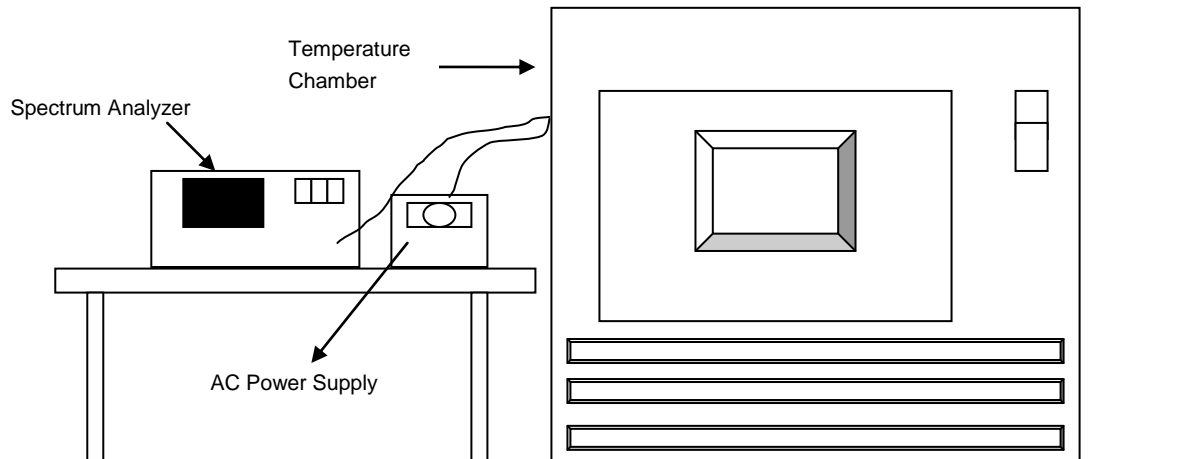

4.5.3 Test Instruments

Refer to section 4.1.2 to get information of above instrument.

4.5.4 Test Procedure

1. The EUT was placed inside the environmental test chamber and powered by nominal AC voltage.
2. Turn the EUT on and couple its output to a spectrum analyzer.
3. Turn the EUT off and set the chamber to the highest temperature specified.
4. Allow sufficient time (approximately 30 min) for the temperature of the chamber to stabilize, turn the EUT on and measure the operating frequency after 2, 5, and 10 minutes.
5. Repeat step 2 and 3 with the temperature chamber set to the lowest temperature.
6. The test chamber was allowed to stabilize at +20 degree C for a minimum of 30 minutes. The supply voltage was then adjusted on the EUT from 85% to 115% and the frequency record.

4.5.5 Deviation from Test Standard

No deviation.

4.5.6 EUT Operating Condition

Set the EUT transmit at un-modulation mode to test frequency stability.

4.5.7 Test Results

FREQUENCY STABILITY VERSUS TEMP.									
OPERATING FREQUENCY: 5320MHz									
TEMP. (°C)	POWER SUPPLY (Vac)	0 MINUTE		2 MINUTE		5 MINUTE		10 MINUTE	
		Measured Frequency (MHz)	Frequency Drift (%)	Measured Frequency (MHz)	Frequency Drift (%)	Measured Frequency (MHz)	Frequency Drift (%)	Measured Frequency (MHz)	Frequency Drift (%)
50	120	5319.9869	-0.00025	5319.9855	-0.00027	5319.9866	-0.00025	5319.9858	-0.00027
40	120	5319.9999	0.00000	5320.0021	0.00004	5320.004	0.00008	5320.0041	0.00008
30	120	5320.0063	0.00012	5320.0055	0.00010	5320.0096	0.00018	5320.009	0.00017
20	120	5319.975	-0.00047	5319.9753	-0.00046	5319.9759	-0.00045	5319.9777	-0.00042
10	120	5320.0009	0.00002	5320.0045	0.00008	5320.0043	0.00008	5320.0039	0.00007
0	120	5320.0056	0.00011	5320.0024	0.00005	5320.0014	0.00003	5320.0038	0.00007
-10	120	5320.0106	0.00020	5320.0108	0.00020	5320.009	0.00017	5320.0085	0.00016
-20	120	5319.9841	-0.00030	5319.984	-0.00030	5319.9839	-0.00030	5319.9877	-0.00023
-30	120	5319.9959	-0.00008	5319.9993	-0.00001	5319.9994	-0.00001	5319.9984	-0.00003

FREQUENCY STABILITY VERSUS TEMP.									
OPERATING FREQUENCY: 5320MHz									
TEMP. (°C)	POWER SUPPLY (Vac)	0 MINUTE		2 MINUTE		5 MINUTE		10 MINUTE	
		Measured Frequency (MHz)	Frequency Drift (%)	Measured Frequency (MHz)	Frequency Drift (%)	Measured Frequency (MHz)	Frequency Drift (%)	Measured Frequency (MHz)	Frequency Drift (%)
20	138	5319.9752	-0.00047	5319.9761	-0.00045	5319.9758	-0.00045	5319.9774	-0.00042
	120	5319.975	-0.00047	5319.9753	-0.00046	5319.9759	-0.00045	5319.9777	-0.00042
	102	5319.9751	-0.00047	5319.9758	-0.00045	5319.9763	-0.00045	5319.9785	-0.00040

4.6 6dB Bandwidth Measurement

4.6.1 Limits of 6dB Bandwidth Measurement

The minimum of 6dB Bandwidth Measurement is 0.5MHz.

4.6.2 Test Setup

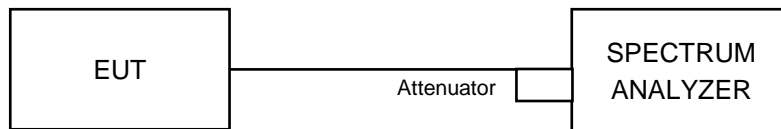

4.6.3 Test Instruments

Refer to section 4.1.2 to get information of above instrument.

4.6.4 Test Procedure

- a. Set resolution bandwidth (RBW) = 100kHz
- b. Set the video bandwidth (VBW) $\geq 3 \times$ RBW, Detector = Peak.
- c. Trace mode = max hold.
- d. Sweep = auto couple.
- e. Measure the maximum width of the emission that is constrained by the frequencies associated with the two amplitude points (upper and lower) that are attenuated by 6 dB relative to the maximum level measured in the fundamental emission

4.6.5 Deviation from Test Standard

No deviation.

4.6.6 EUT Operating Condition

The software provided by client to enable the EUT under transmission condition continuously at lowest, middle and highest channel frequencies individually.

4.6.7 Test Results

CDD MODE

802.11a

Channel	Frequency (MHz)	6dB Bandwidth (MHz)			Minimum Limit (MHz)	Pass / Fail
		Chain 0	Chain 1	Chain 2		
144 (UNII-3 Band)	5720	3.11	3.16	3.76	0.5	Pass

802.11ac (VHT20)

Channel	Frequency (MHz)	6dB Bandwidth (MHz)			Minimum Limit (MHz)	Pass / Fail
		Chain 0	Chain 1	Chain 2		
144 (UNII-3 Band)	5720	3.77	3.80	3.51	0.5	Pass

802.11ac (VHT40)

Channel	Frequency (MHz)	6dB Bandwidth (MHz)			Minimum Limit (MHz)	Pass / Fail
		Chain 0	Chain 1	Chain 2		
142 (UNII-3 Band)	5710	2.70	3.23	2.97	0.5	Pass

802.11ac (VHT80)

Channel	Frequency (MHz)	6dB Bandwidth (MHz)			Minimum Limit (MHz)	Pass / Fail
		Chain 0	Chain 1	Chain 2		
138 (UNII-3 Band)	5690	2.74	2.75	2.74	0.5	Pass

SPECTRUM PLOT OF WORST VALUE

802.11a – Chain (0): CH 144 (UNII-3 Band)

802.11ac (VHT20) – Chain (2): CH 144 (UNII-3 Band)

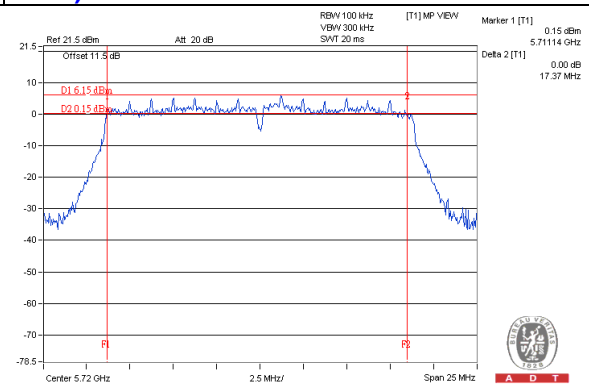
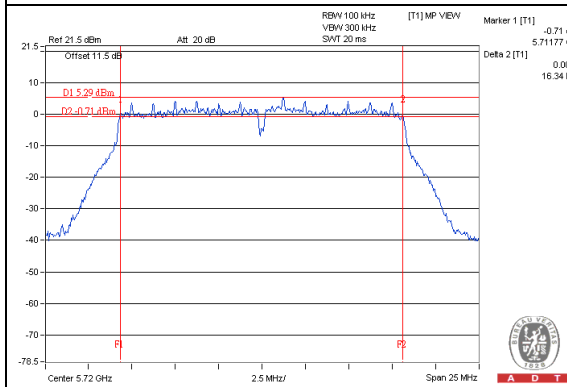

802.11ac (VHT40) – Chain (0): CH 142 (UNII-3 Band)

802.11ac (VHT80) – Chain (0): CH 138 (UNII-3 Band)

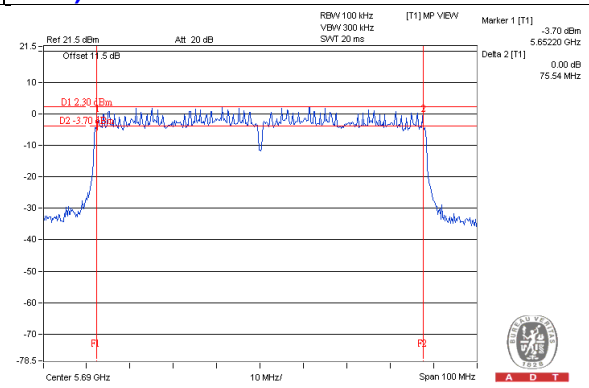
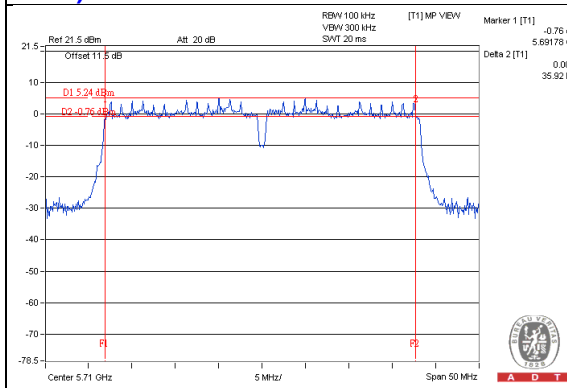

NOTE:

The 6dB bandwidth above 5725MHz = Marker 1 + Delta 2 - 5725MHz

Beamforming MODE
802.11ac (VHT20)

Channel	Frequency (MHz)	6dB Bandwidth (MHz)			Minimum Limit (MHz)	Pass / Fail
		Chain 0	Chain 1	Chain 2		
144 (UNII-3 Band)	5720	3.77	3.80	3.51	0.5	Pass

802.11ac (VHT40)

Channel	Frequency (MHz)	6dB Bandwidth (MHz)			Minimum Limit (MHz)	Pass / Fail
		Chain 0	Chain 1	Chain 2		
142 (UNII-3 Band)	5710	2.94	3.23	3.16	0.5	Pass

802.11ac (VHT80)

Channel	Frequency (MHz)	6dB Bandwidth (MHz)			Minimum Limit (MHz)	Pass / Fail
		Chain 0	Chain 1	Chain 2		
138 (UNII-3 Band)	5690	2.74	2.77	2.74	0.5	Pass

SPECTRUM PLOT OF WORST VALUE

802.11ac (VHT20) – Chain (2): CH 144 (UNII-3 Band)

802.11ac (VHT40) – Chain (0): CH 142 (UNII-3 Band)

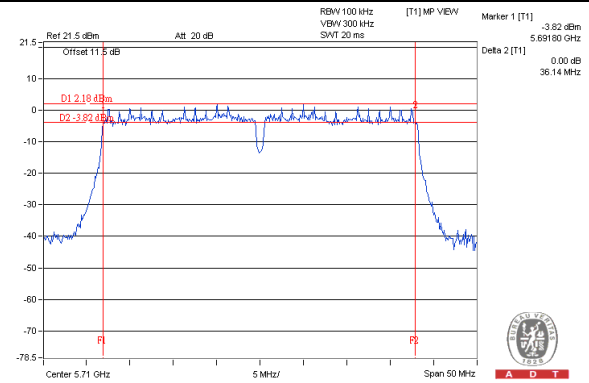
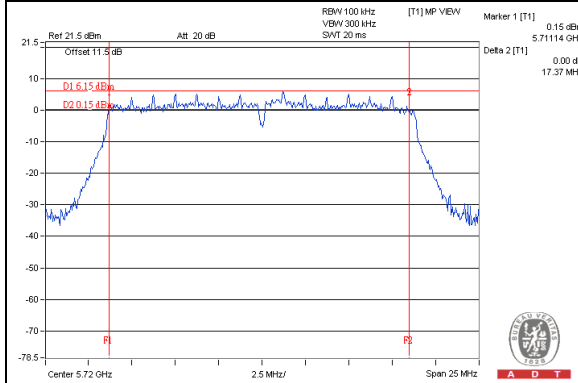

802.11ac (VHT80) – Chain (2): CH 138 (UNII-3 Band)

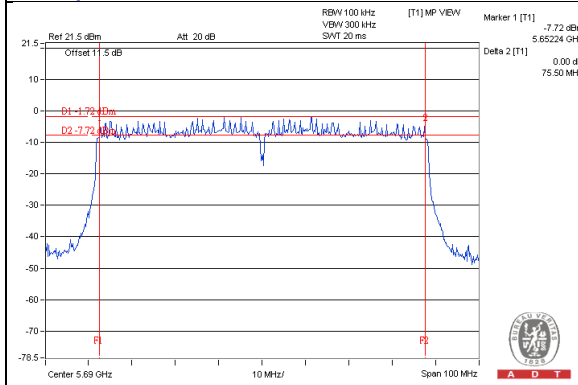

NOTE:

The 6dB bandwidth above 5725MHz = Marker 1 + Delta 2 - 5725MHz

5 Pictures of Test Arrangements

Please refer to the attached file (Test Setup Photo).



A D T

Appendix – Information on the Testing Laboratories

We, Bureau Veritas Consumer Products Services (H.K.) Ltd., Taoyuan Branch, were founded in 1988 to provide our best service in EMC, Radio, Telecom and Safety consultation. Our laboratories are accredited and approved according to ISO/IEC 17025.

If you have any comments, please feel free to contact us at the following:

Linko EMC/RF Lab

Tel: 886-2-26052180

Fax: 886-2-26051924

Hsin Chu EMC/RF Lab/Telecom Lab

Tel: 886-3-5935343

Fax: 886-3-5935342

Hwa Ya EMC/RF/Safety

Tel: 886-3-3183232

Fax: 886-3-3270892

Email: service.adt@tw.bureauveritas.com

Web Site: www.bureauveritas-adt.com

The address and road map of all our labs can be found in our web site also.

--- END ---