



Excellence in Compliance Testing

Certification Test Report

**FCC ID: UID2402GCT
IC: 6670A-2402GCT**

**FCC Rule Part: 15.247
IC Radio Standards Specification: RSS-210**

ACS Report Number: 12-0437.W06.1A

**Manufacturer: Arris International, Inc.
Model: MG2402G/CT**

**Test Begin Date: April 11, 2013
Test End Date: April 17, 2013**

Report Issue Date: May15, 2013



FOR THE SCOPE OF ACCREDITATION UNDER LAB Code 200612-0

This report must not be used by the client to claim product certification, approval, or endorsement by NVLAP, NIST, or any agency of the Federal Government.

Reviewed by:

**Kirby Munroe
Director, Wireless Certifications
ACS, Inc.**

This test report shall not be reproduced except in full. This report may be reproduced in part with prior written consent of ACS, Inc. The results contained in this report are representative of the sample(s) submitted for evaluation.

This report contains 24 pages

TABLE OF CONTENTS

1	GENERAL	3
1.1	PURPOSE.....	3
1.2	PRODUCT DESCRIPTION.....	3
1.3	TEST METHODOLOGY AND CONSIDERATIONS	3
2	TEST FACILITIES	4
2.1	LOCATION	4
2.2	LABORATORY ACCREDITATIONS/RECOGNITIONS/CERTIFICATIONS	4
2.3	RADIATED EMISSIONS TEST SITE DESCRIPTION	5
2.3.1	<i>Semi-Anechoic Chamber Test Site</i>	5
2.3.2	<i>Open Area Tests Site (OATS)</i>	6
2.4	CONDUCTED EMISSIONS TEST SITE DESCRIPTION	7
3	APPLICABLE STANDARD REFERENCES	7
4	LIST OF TEST EQUIPMENT	8
5	SUPPORT EQUIPMENT	9
6	EQUIPMENT UNDER TEST SETUP BLOCK DIAGRAM	9
7	SUMMARY OF TESTS	10
7.1	ANTENNA REQUIREMENT – FCC: SECTION 15.203	10
7.2	POWER LINE CONDUCTED EMISSIONS – FCC: SECTION 15.207, IC: RSS-GEN 7.2.4.....	10
7.2.1	<i>Measurement Procedure</i>	10
7.2.2	<i>Measurement Results</i>	10
7.3	6dB /99% BANDWIDTH – FCC: SECTION 15.247(A)(2), IC: RSS-210 A8.2(A).....	11
7.3.1	<i>Measurement Procedure</i>	11
7.3.2	<i>Measurement Results</i>	11
7.4	FUNDAMENTAL EMISSION OUTPUT POWER – FCC: SECTION 15.247(B)(3), IC: RSS-210 A8.4(4).14	
7.4.1	<i>Measurement Procedure</i>	14
7.4.2	<i>Measurement Results</i>	14
7.5	EMISSION LEVELS – FCC: SECTION 15.247(D), 15.205 IC: RSS-210 2.2, A8.5	15
7.5.1	<i>Emissions into Non-restricted Frequency Bands</i>	15
7.5.1.1	<i>Measurement Procedure</i>	15
7.5.1.2	<i>Measurement Results</i>	15
7.5.2	<i>Emissions into Restricted Frequency Bands</i>	20
7.5.2.1	<i>Measurement Procedure</i>	20
7.5.2.2	<i>Duty Cycle Correction</i>	20
7.5.2.3	<i>Measurement Results</i>	21
7.5.2.4	<i>Sample Calculation</i> :	21
7.6	MAXIMUM POWER SPECTRAL DENSITY IN THE FUNDAMENTAL EMISSION – FCC: SECTION 15.247(E) IC: RSS-210 A8.2(B).....	22
7.6.1	<i>Measurement Procedure</i>	22
7.6.2	<i>Measurement Results</i>	22
8	CONCLUSION	23

1 GENERAL

1.1 Purpose

The purpose of this report is to demonstrate compliance with Part 15 Subpart C of the FCC's Code of Federal Regulations and Industry Canada's Radio Standards Specification RSS-210.

1.2 Product Description

The ARRIS Media Gateway, model MG2402 Provides a single point, triple play device to manage all content coming into the home as well as distribution of all content throughout the home.

Technical Information:

Band of Operation: 2405 – 2480 MHz
Number of Channels: 16
Modulation Format: O-QPSK
Inputs / Outputs: 2 (Tx Diversity)
Antenna Type/Gain: Printed Inverted F (PIFA), 3 dBi
Operating Voltage: 120 VAC

Manufacturer Information:

ARRIS International, Inc.
3871 Lakefield Dr.
Suwanee, GA 30024

Test Sample Serial Number: CCDBND474400169, D3VBND6B6700525 (AC Line Conducted)

Test Sample Condition: The test samples were provided in good working order with no visible defects.

1.3 Test Methodology and Considerations

For radiated emissions, including band edge, the EUT were evaluated in a configuration representative of final installation. The EUT and peripherals / accessories were configured to product worst case results.

The EUT provides (2) RF outputs for transmit diversity. Each RF output was evaluated in full and results presented in this report.

2 TEST FACILITIES

2.1 Location

The radiated and conducted emissions test sites are located at the following address:

Advanced Compliance Solutions
5015 B.U. Bowman Drive
Buford, GA 30518
Phone: (770) 831-8048
Fax: (770) 831-8598

2.2 Laboratory Accreditations/Recognitions/Certifications

ACS is accredited to ISO/IEC 17025 by the National Institute of Standards and Technology under their National Voluntary Laboratory Accreditation Program (NVLAP), Lab Code 200612-0. Unless otherwise specified, all tests methods described within this report are covered under the ISO/IEC 17025 scope of accreditation.

The Semi-Anechoic Chamber Test Site, Open Area Test Site (OATS) and Conducted Emissions Site have been fully described, submitted to, and accepted by the FCC, Industry Canada and the Japanese Voluntary Control Council for Interference by information technology equipment.

FCC Registration Number: 511277

Industry Canada Lab Code: IC 4175A-1

VCCI Member Number: 1831

- VCCI OATS Registration Number R-1526
- VCCI Conducted Emissions Site Registration Number: C-1608

2.3 Radiated Emissions Test Site Description

2.3.1 Semi-Anechoic Chamber Test Site

The Semi-Anechoic Chamber Test Site consists of a 20' x 30' x 18' shielded enclosure. The chamber is lined with Toyo Ferrite Grid Absorber, model number FFG-1000. The ferrite tile grid is 101 x 101 x 19mm thick and weighs approximately 550 grams. These tiles are mounted on steel panels and installed directly on the inner walls of the chamber.

The turntable is 150cm in diameter and is located 160cm from the back wall of the chamber. The chamber is grounded via 1 - 8' copper ground rod, installed at the center of the back wall, it is bound to the ground plane using 3/4" stainless steel braided cable.

The turntable is all steel, flush mounted table installed in an all steel frame. The table is remotely operated from inside the control room located 25' from the range. The turntable is electrically bonded to the surrounding ground plane via steel fingers installed on the edge of the turn table. The steel fingers make constant contact with the ground plane during operation.

Behind the turntable is a 3' x 6' x 4' deep shielded pit used for support equipment if necessary. The pit is equipped with 1 - 4" PVC chases from the turntable to the pit that allow for cabling to the EUT if necessary. The underside of the turntable can be accessed from the pit so cables can be supplied to the EUT from the pit.

A diagram of the Semi-Anechoic Chamber Test Site is shown in Figure 2.3-1 below:

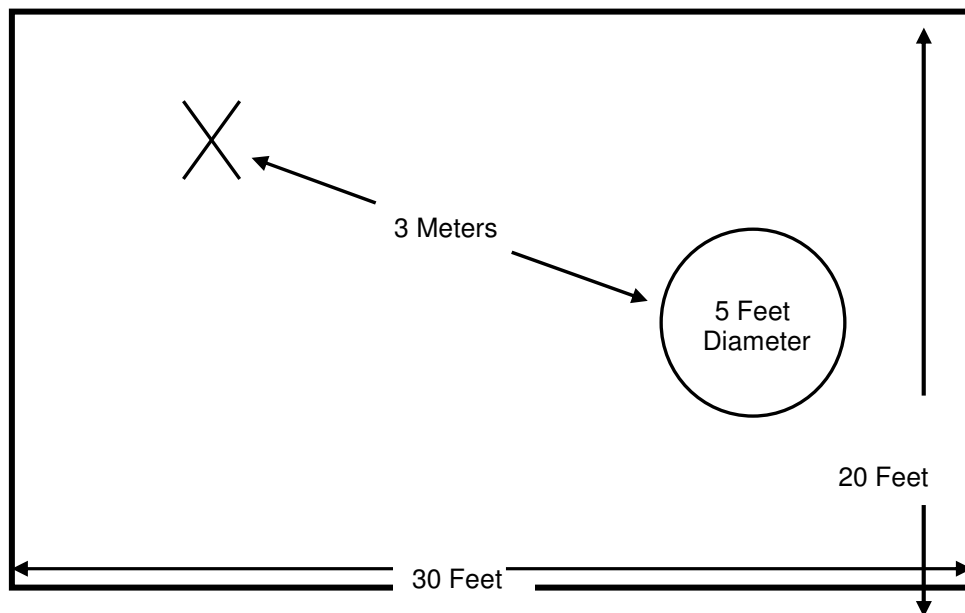

Figure 2.3-1: Semi-Anechoic Chamber Test Site

2.3.2 Open Area Tests Site (OATS)

The open area test site consists of a 40' x 66' concrete pad covered with a perforated electro-plated galvanized sheet metal. The perforations in the sheet metal are 1/8" holes that are staggered every 3/16". The individual sheets are placed to overlap each other by 1/4" and are riveted together to provide a continuous seam. Rivets are spaced every 3" in a 3 x 20 meter perimeter around the antenna mast and EUT area. Rivets in the remaining area are spaced as necessary to properly secure the ground plane and maintain the electrical continuity.

The entire ground plane extends 12' beyond the turntable edge and 16' beyond the antenna mast when set to a 10 meter measurement distance. The ground plane is grounded via 4 - 8' copper ground rods, each installed at a corner of the ground plane and bound to the ground plane using 3/4" stainless steel braided cable.

The turntable is an all aluminum 10' flush mounted table installed in an all aluminum frame. The table is remotely operated from inside the control room located 40' from the range. The turntable is electrically bonded to the surrounding ground plane via steel fingers installed on the edge of the turn table. The steel fingers make constant contact with the ground plane during operation.

Adjacent to the turntable is a 7' x 7' square and 4' deep concrete pit used for support equipment if necessary. The pit is equipped with 5 - 4" PVC chases from the pit to the control room that allow for cabling to the EUT if necessary. The underside of the turntable can be accessed from the pit so cables can be supplied to the EUT from the pit. The pit is covered with 2 sheets of 1/4" diamond style re-enforced steel sheets. The sheets are painted to match the perforated steel ground plane; however the underside edges have been masked off to maintain the electrical continuity of the ground plane. All reflecting objects are located outside of the ellipse defined in ANSI C63.4.

A diagram of the Open Area Test Site is shown in Figure 2.3-2 below:

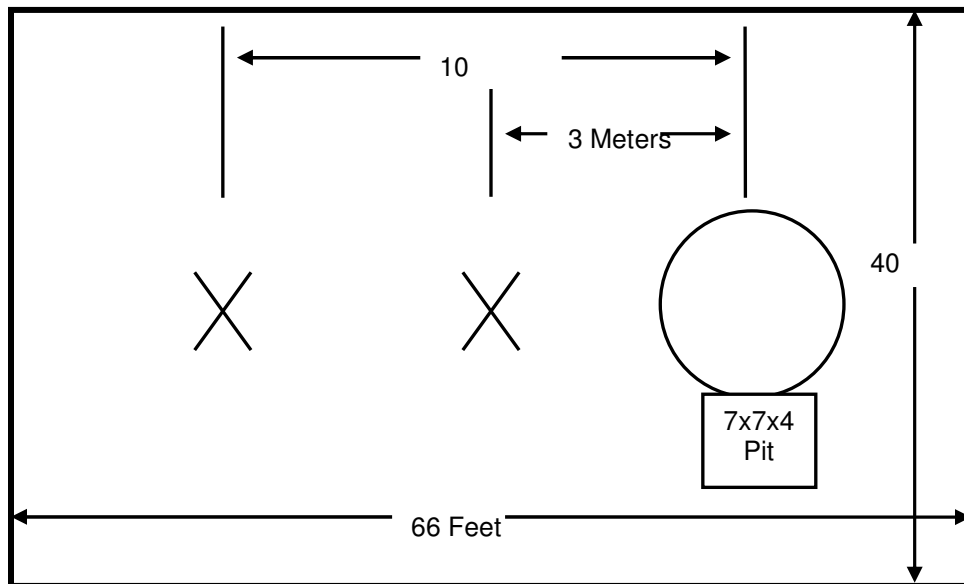

Figure 2.3-2: Open Area Test Site

2.4 Conducted Emissions Test Site Description

The AC mains conducted EMI site is located in the main EMC lab. It consists of an 8' x 8' solid aluminum horizontal ground reference plane (GRP) bonded every 3" to an 8' X 8' vertical ground plane.

The site is of sufficient size to test table top and floor standing equipment in accordance with section 6.1.4 of ANSI C63.4.

A diagram of the room is shown below in figure 4.1.3-1:

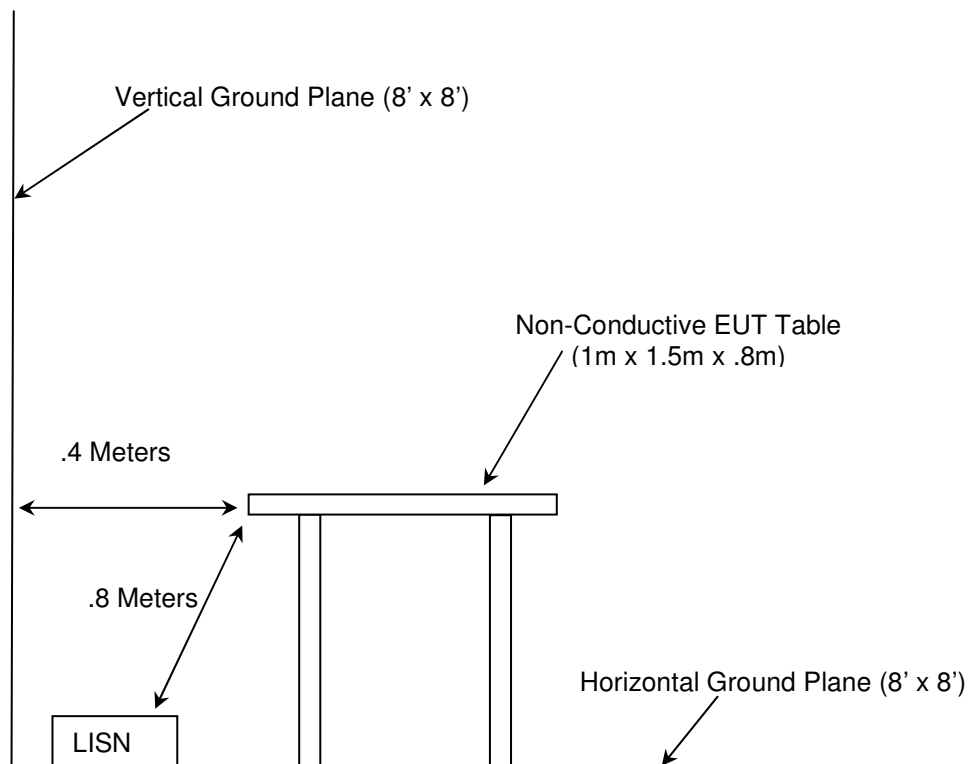

Figure 2.4-1: AC Mains Conducted EMI Site

3 APPLICABLE STANDARD REFERENCES

The following standards were used:

- ❖ ANSI C63.4-2003: Method of Measurements of Radio-Noise Emissions from Low-Voltage Electrical and Electronic Equipment in the 9KHz to 40GHz
- ❖ ANSI C63.10-2009: American National Standard for Testing Unlicensed Wireless Devices
- ❖ US Code of Federal Regulations (CFR): Title 47, Part 2, Subpart J: Equipment Authorization Procedures, 2013
- ❖ US Code of Federal Regulations (CFR): Title 47, Part 15, Subpart C: Radio Frequency Devices, Intentional Radiators, 2013
- ❖ FCC KDB 558074 D01 DTS Meas Guidance v03r01 - Guidance for Performing Compliance Measurements on Digital Transmission Systems (DTS) Operating Under §15.247, April 9, 2013
- ❖ Industry Canada Radio Standards Specification: RSS-210 - Low-power License-exempt Radiocommunication Devices (All Frequency Bands): Category I Equipment, Issue 8, Dec 2010
- ❖ Industry Canada Radio Standards Specification: RSS-GEN – General Requirements and Information for the Certification of Radiocommunication Equipment, Issue 3, Dec 2010.

4 LIST OF TEST EQUIPMENT

The calibration interval of test equipment is annually or the manufacturer's recommendations. Where the calibration interval deviates from the annual cycle based on the instrument manufacturer's recommendations, it shall be stated below.

Table 4-1: Test Equipment

AssetID	Manufacturer	Model #	Equipment Type	Serial #	Last Calibration Date	Calibration Due Date
1	Rohde & Schwarz	ESMI - Display	Spectrum Analyzers	833771/007	8/2/2012	8/2/2014
2	Rohde & Schwarz	ESMI-Receiver	Spectrum Analyzers	839587/003	8/2/2012	8/2/2014
30	Spectrum Technologies	DRH-0118	Antennas	970102	4/27/2011	4/27/2013
40	EMCO	3104	Antennas	3211	2/14/2013	2/14/2015
153	EMCO	3825/2	LISN	9411-2268	7/31/2012	7/31/2014
167	ACS	Chamber EMI Cable Set	Cable Set	167	12/17/2012	12/17/2013
168	Hewlett Packard	11947A	Attenuators	44829	2/1/2013	2/1/2014
267	Agilent	N1911A	Meters	MY45100129	1/23/2012	1/23/2014
268	Agilent	N1921A	Sensors	MY45240184	1/17/2012	1/17/2014
283	Rohde & Schwarz	FSP40	Spectrum Analyzers	1000033	8/1/2012	8/1/2013
291	Florida RF Cables	SMRE-200W-12.0-SMRE	Cables	None	11/20/2012	11/20/2013
292	Florida RF Cables	SMR-290AW-480.0-SMR	Cables	None	3/26/2013	3/26/2014
321	Hewlett Packard	HPC 8447D	Amplifiers	1937A02809	8/27/2012	8/27/2013
324	ACS	Belden	Cables	8214	6/26/2012	6/26/2013
334	Rohde&Schwarz	3160-09	Antennas	49404	11/4/2010	NCR
335	Suhner	SF-102A	Cables	882/2A	8/2/2012	8/2/2013
338	Hewlett Packard	8449B	Amplifiers	3008A01111	8/2/2012	8/2/2013
340	Aeroflex/Weinschel	AS-20	Attenuators	7136	8/2/2012	8/2/2013
345	Suhner Sucoflex	102A	Cables	1077/2A	8/2/2012	8/2/2013
412	Electro Metrics	LPA-25	Antennas	1241	7/27/2012	7/27/2014
422	Florida RF	SMS-200AW-72.0-SMR	Cables	805	11/20/2012	11/20/2013
432	Microwave Circuits	H3G020G4	Filters	264066	7/2/2012	7/2/2013
RE90	Agilent	E7404A	Analyzers	US40240143	11/28/2012	11/28/2013

5 SUPPORT EQUIPMENT

Table 5-1: Support Equipment

Item	Equipment Type	Manufacturer	Model Number	Serial Number
1	DC Power Supply	Delta Electronics	ADP-66AR A	GPGD2CP008N
2	Laptop Computer	Sony	PCG-21212L	27518031 3006140
3	Laptop Power Supply	Sony	PA-1400-08SY	148739111 0773389
4	Telephone	Thomson Inc.	29267GE3-B	66691242
5	eSATA Hard Drive	Western Digital	WD10000F032	WCAV5A236893
6	Hard Drive Power Supply	Asian Power Devices, Inc.	WA-18G12U	Y45721021002263 6600
7	USB Flash Drive	Hewlett Packard	V100W	N/A
8	Data Gateway	Arris	D5 UEQ	N/A

6 EQUIPMENT UNDER TEST SETUP BLOCK DIAGRAM

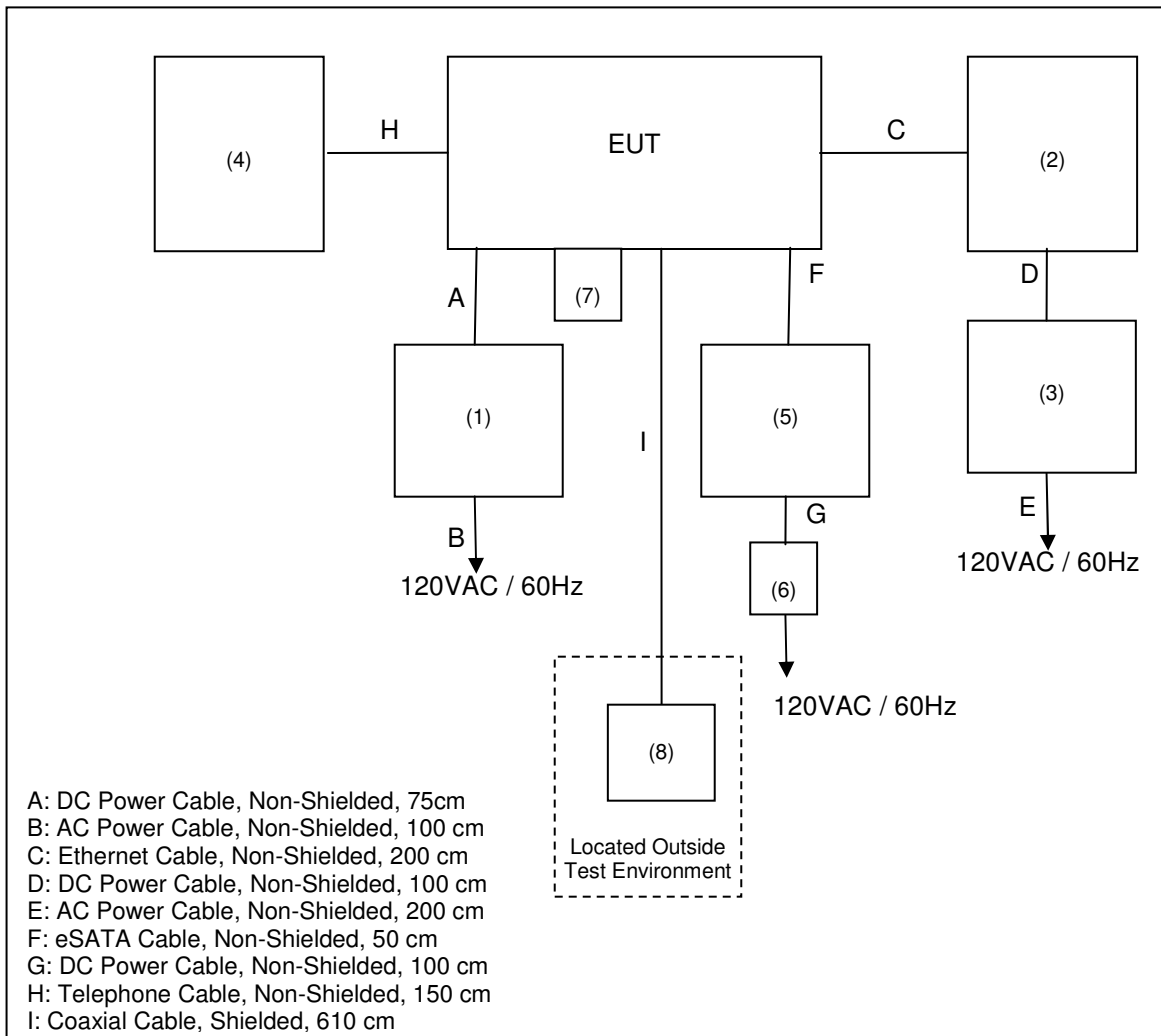

Figure 6-1: EUT Test Setup

7 SUMMARY OF TESTS

Along with the tabular data shown below, plots were taken of all signals deemed important enough to document.

7.1 Antenna Requirement – FCC: Section 15.203

The EUT utilizes integral printed inverted F type antennas which cannot be removed thus satisfying Part 15.203. The gain of the antenna is 3dBi.

7.2 Power Line Conducted Emissions – FCC: Section 15.207, IC: RSS-Gen 7.2.4

7.2.1 Measurement Procedure

ANSI C63.4 sections 6 and 7 were the guiding documents for this evaluation. Conducted emissions were performed from 150kHz to 30MHz with the spectrum analyzer's resolution bandwidth set to 9kHz and the video bandwidth set to 30kHz. The calculation for the conducted emissions is as follows:

Corrected Reading = Analyzer Reading + LISN Loss + Cable Loss

Margin = Applicable Limit - Corrected Reading

7.2.2 Measurement Results

Results of the test are shown below in Table 7.2.2-1.

Table 7.2.2-1: Conducted EMI Results

Frequency (MHz)	Uncorrected Reading (dBuV)		Total Correction Factor (dB)	Corrected Level (dBuV)		Limit (dBuV)		Margin (dB)	
	Quasi-Peak	Average		Quasi-Peak	Average	Quasi-Peak	Average	Quasi-Peak	Average
Line 1									
0.152897	30.279	11.018	10.03	40.30	21.04	65.92	55.92	25.6	34.9
0.185656	36.563	29.091	9.94	46.51	39.03	64.98	54.98	18.5	15.9
0.5176	24.522	19.518	9.99	34.51	29.51	56.00	46.00	21.5	16.5
0.637638	31.321	27.041	9.95	41.27	36.99	56.00	46.00	14.7	9.0
0.732356	28.887	23.386	9.92	38.81	33.30	56.00	46.00	17.2	12.7
12.9972	21.351	15.129	10.40	31.75	25.53	60.00	50.00	28.3	24.5
Line 2									
0.190844	37.766	31.943	9.93	47.70	41.87	64.83	54.83	17.1	13.0
0.339544	20.806	6.389	9.99	30.80	16.38	60.58	50.58	29.8	34.2
0.5049	23.328	18.879	9.99	33.32	28.87	56.00	46.00	22.7	17.1
0.615831	30.879	25.853	9.97	40.85	35.83	56.00	46.00	15.1	10.2
0.711769	30.437	25.093	9.90	40.33	34.99	56.00	46.00	15.7	11.0
12.0643	21.64	15.069	10.36	32.00	25.43	60.00	50.00	28.0	24.6

7.3 6dB / 99% Bandwidth – FCC: Section 15.247(a)(2), IC: RSS-210 A8.2(a)

7.3.1 Measurement Procedure

The 6dB bandwidth was measured in accordance with the FCC KDB 558074 D01 DTS Meas Guidance v03r01. The Resolution Bandwidth (RBW) of the spectrum analyzer was set to 100 kHz. The Video Bandwidth (VBW) was set to ≥ 3 times the RBW. The trace was set to max hold with a peak detector active. The ndB down function of the spectrum analyzer was utilized to determine the 6 dB bandwidth of the emission.

The occupied bandwidth measurement function of the spectrum analyzer was used to measure the 99% bandwidth. The span of the analyzer was set to capture all products of the modulation process, including the emission sidebands. The resolution bandwidth was set to as close to 1% of the selected span as is possible without being below 1%. The video bandwidth was set to 3 times the resolution bandwidth. A sampling detector was used.

7.3.2 Measurement Results

Results are shown below in tables 7.3.2-1 to 7.3.2-2 and figures 7.3.2-1 to 7.3.2-12:

Table 7.3.2-1: 6dB / 99% Bandwidth – ANT 0

Frequency [MHz]	6dB Bandwidth [MHz]	99% Bandwidth [MHz]
2405	1.62	2.38
2440	1.62	2.40
2480	1.62	2.40

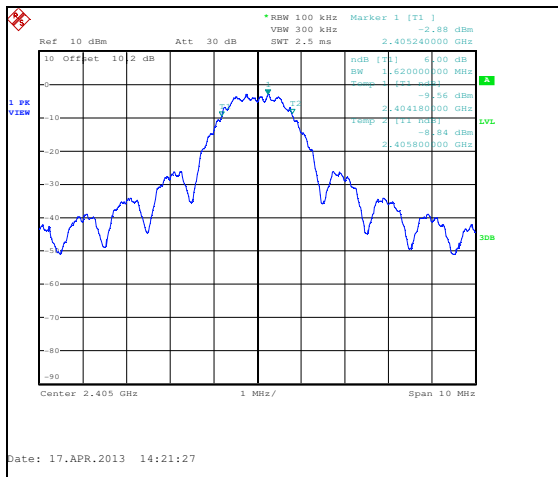

Figure 7.3.2-1: 6dB Bandwidth – 2405 MHz - ANT 0

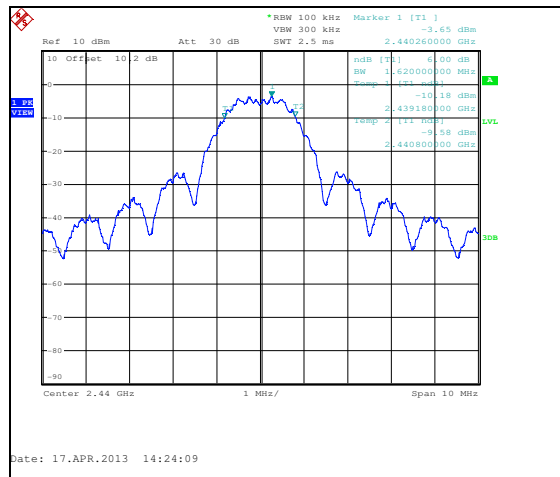

Figure 7.3.2-2: 6dB Bandwidth – 2440 MHz - ANT 0

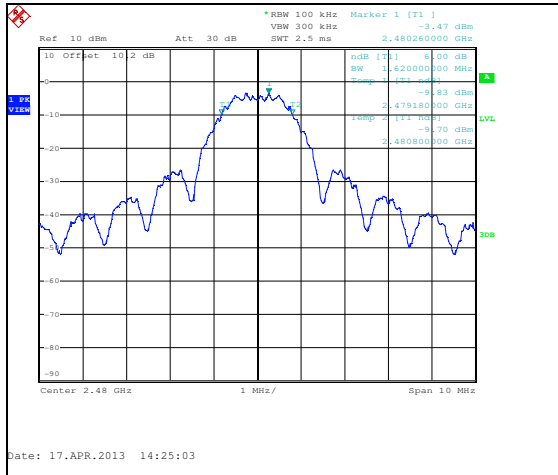

Figure 7.3.2-3: 6dB Bandwidth – 2480 MHz – ANT 0

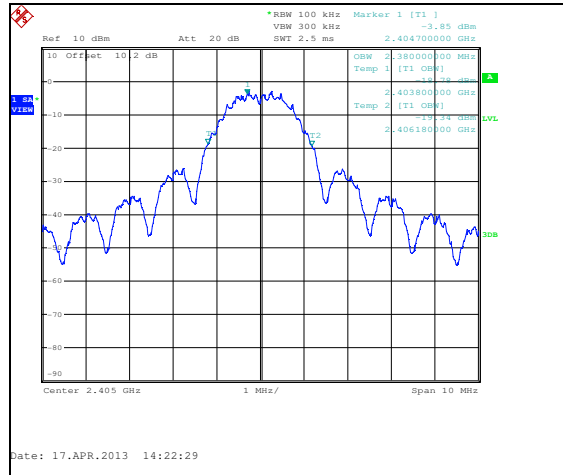

Figure 7.3.2-4: 99% Bandwidth – 2405 MHz – ANT 0

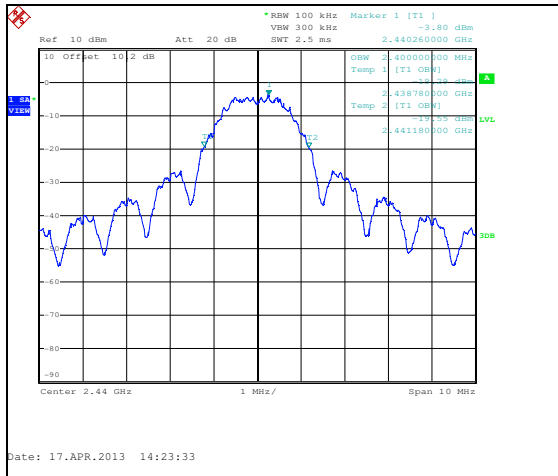

Figure 7.3.2-5: 99% Bandwidth – 2440 MHz – ANT 0

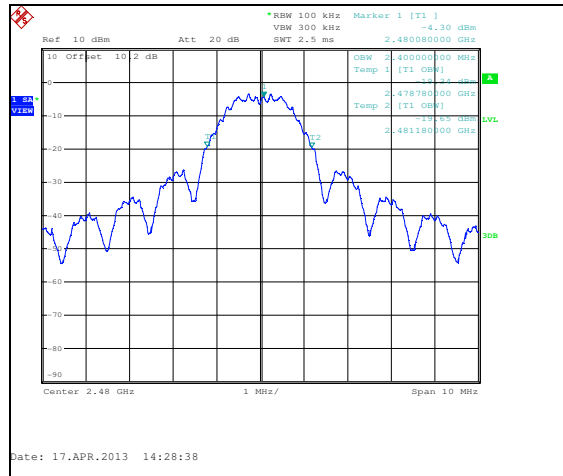

Figure 7.3.2-6: 99% Bandwidth – 2480 MHz – ANT 0

Table 7.3.2-2: 6dB / 99% Bandwidth – ANT 1

Frequency [MHz]	6dB Bandwidth [MHz]	99% Bandwidth [MHz]
2405	1.62	2.40
2440	1.62	2.40
2480	1.60	2.40

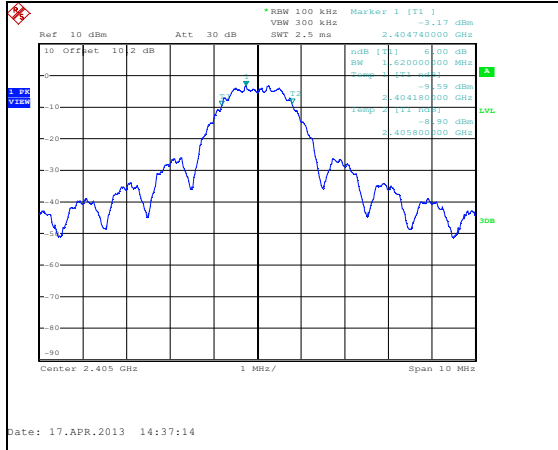

Figure 7.3.2-7: 6dB Bandwidth – 2405 MHz - ANT 1

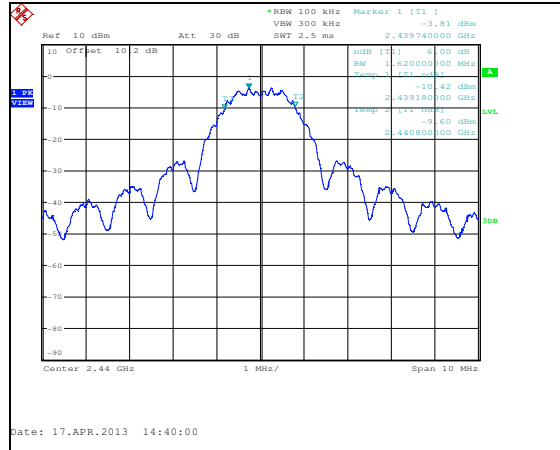

Figure 7.3.2-8: 6dB Bandwidth – 2440 MHz - ANT 1

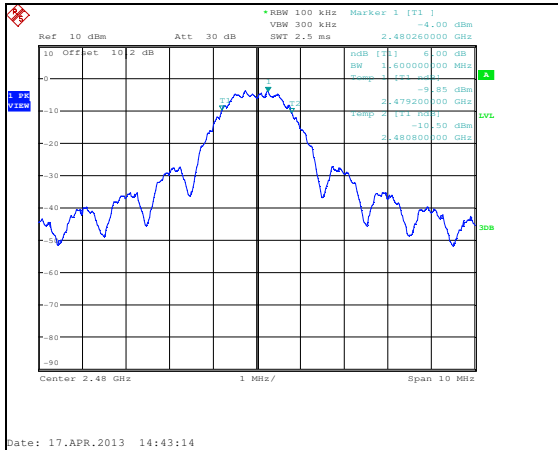

Figure 7.3.2-9: 6dB Bandwidth – 2480 MHz - ANT 1

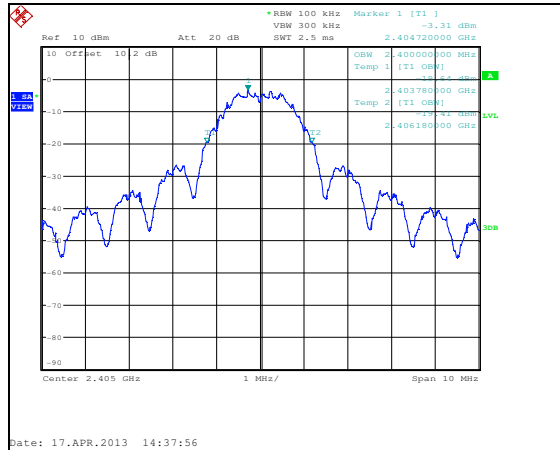

Figure 7.3.2-10: 99% Bandwidth – 2405 MHz - ANT 1

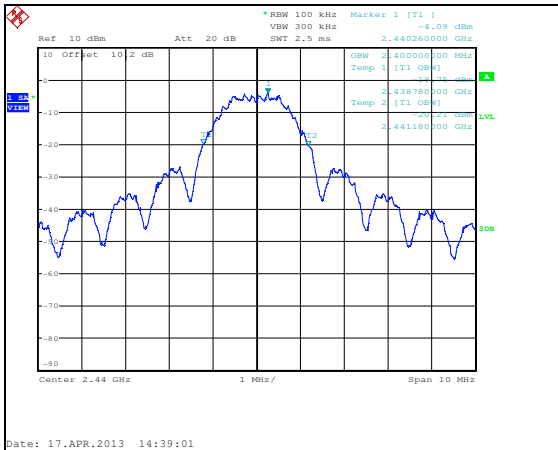

Figure 7.3.2-11: 99% Bandwidth – 2440 MHz - ANT 1

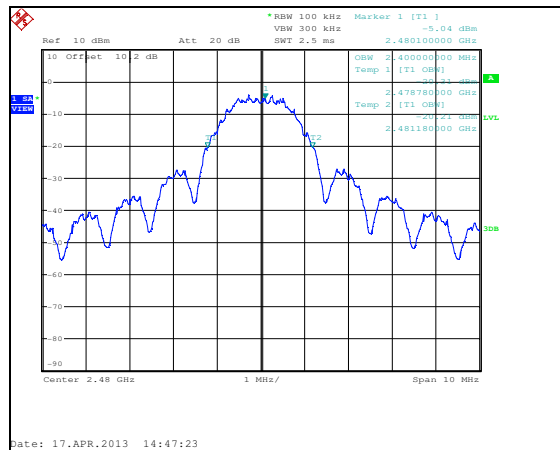

Figure 7.3.2-12: 99% Bandwidth – 2480 MHz - ANT 1

7.4 Fundamental Emission Output Power – FCC: Section 15.247(b)(3), IC: RSS-210 A8.4(4)**7.4.1 Measurement Procedure**

The maximum peak conducted output power was measured in accordance with FCC KDB 558074 D01 DTS Meas Guidance v03r01 utilizing the PKPM1 Peak power meter method. The RF output of the equipment under test was directly connected to the input of the peak power meter applying suitable attenuation.

7.4.2 Measurement Results

Results are shown below in Tables 7.4.2-1 to 7.4.2-2.

Table 7.4.2-1: Maximum Peak Conducted Output Power – ANT 0

Frequency (MHz)	Output Power (dBm)
2405	0.68
2440	0.17
2480	0.24

Table 7.4.2-2: Maximum Peak Conducted Output Power – ANT 1

Frequency (MHz)	Output Power (dBm)
2405	0.42
2440	-0.09
2480	-0.31

7.5 Emission Levels – FCC: Section 15.247(d), 15.205 IC: RSS-210 2.2, A8.5

7.5.1 Emissions into Non-restricted Frequency Bands

7.5.1.1 Measurement Procedure

The unwanted emissions into non-restricted bands were measured conducted in accordance with FCC KDB 558074 D01 DTS Meas Guidance v03r01. The RF output of the equipment under test was directly connected to the input of the spectrum analyzer applying suitable attenuation. The Resolution Bandwidth (RBW) of the spectrum analyzer was set to 100 kHz. The Video Bandwidth (VBW) was set to ≥ 300 kHz. Span was set to 1.5 times the DTS bandwidth. The trace was set to max hold with a peak detector active. The resulting spectrum analyzer peak level was used to determine the reference level with respect to the 20 dBc limit. The spectrum span was then adjusted for the measurement of spurious emissions from 30MHz to 25GHz, 10 times the highest fundamental frequency.

Note that the channel found to contain the maximum PSD level was be used to establish the reference level for all channels.

Band-edge compliance was determined using the conducted marker-delta method in which the radio frequency power that is produced by the EUT is at least 20 dB below that in the 100 kHz bandwidth within the band that contains the highest level of desired power.

7.5.1.2 Measurement Results

RF Conducted Emissions are displayed in Figures 7.5.1.2-1 through 7.5.1.2-2.

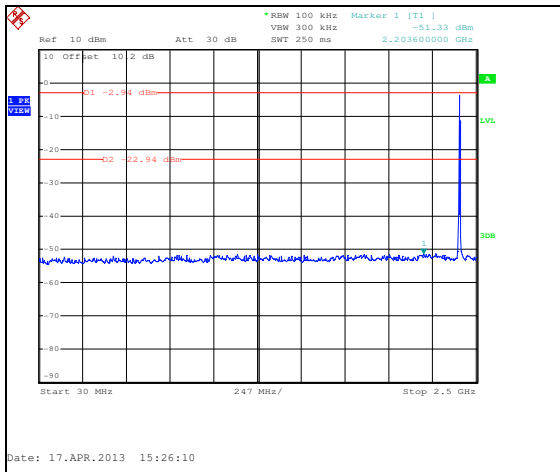

Figure 7.5.1.2-1: 30 MHz – 2.5 GHz – 2405 MHz – ANT 0

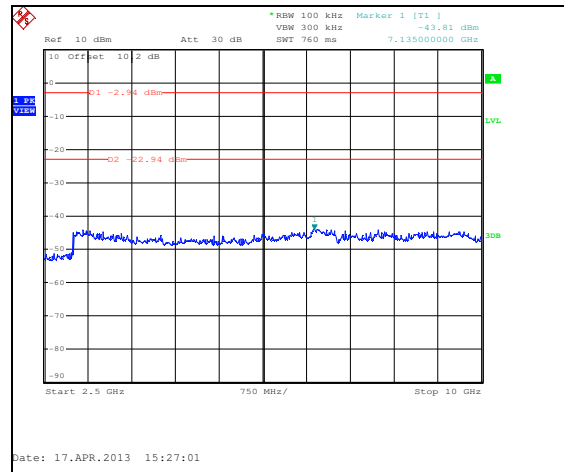

Figure 7.5.1.2-2: 2.5 GHz – 10 GHz – 2405 MHz – ANT 0

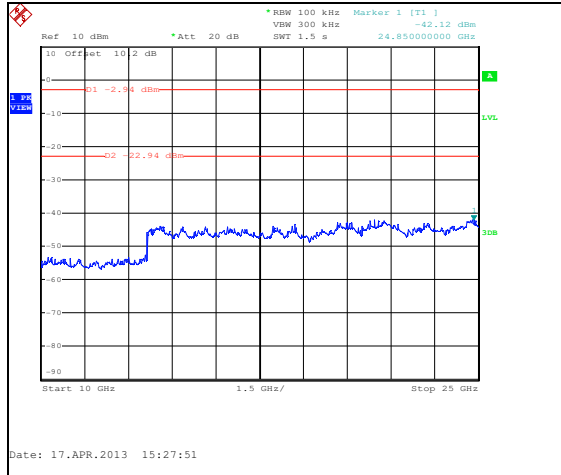

Figure 7.5.1.2-3: 10 GHz – 25 GHz – 2405 MHz – ANT 0

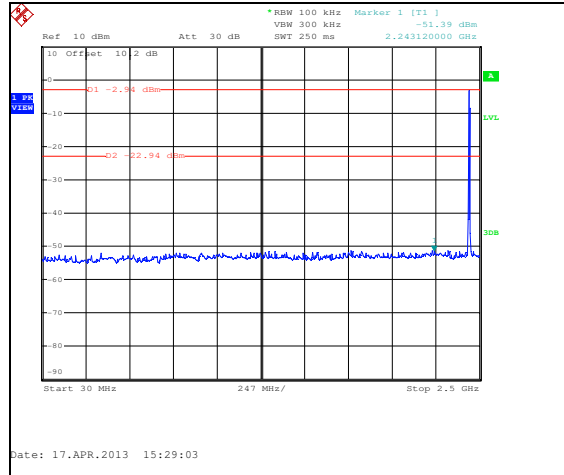

Figure 7.5.1.2-4: 30 MHz – 2.5 GHz – 2440 MHz – ANT 0

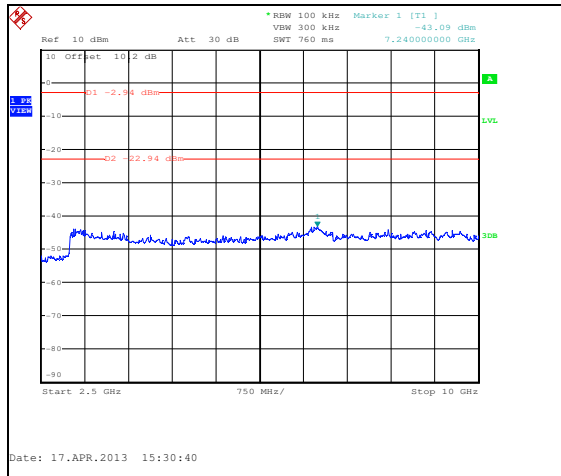

Figure 7.5.1.2-5: 2.5 GHz – 10 GHz – 2440 MHz – ANT 0

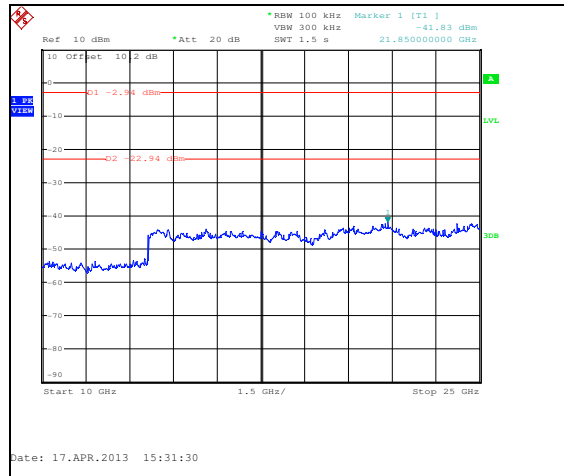

Figure 7.5.1.2-6: 10 GHz – 25 GHz – 2440 MHz – ANT 0

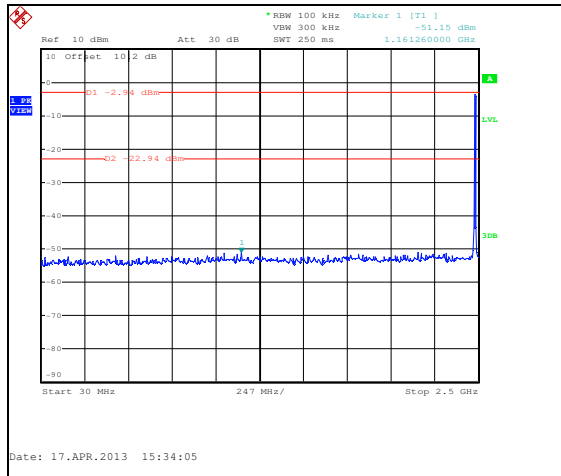

Figure 7.5.1.2-7: 30 MHz – 2.5 GHz – 2480 MHz – ANT 0

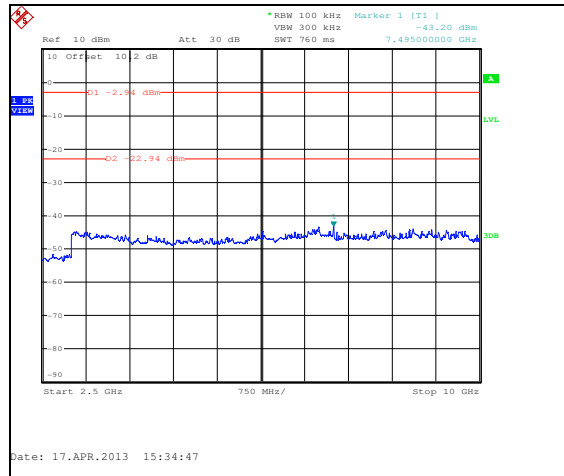

Figure 7.5.1.2-8: 2.5 GHz – 10 GHz – 2480 MHz – ANT 0

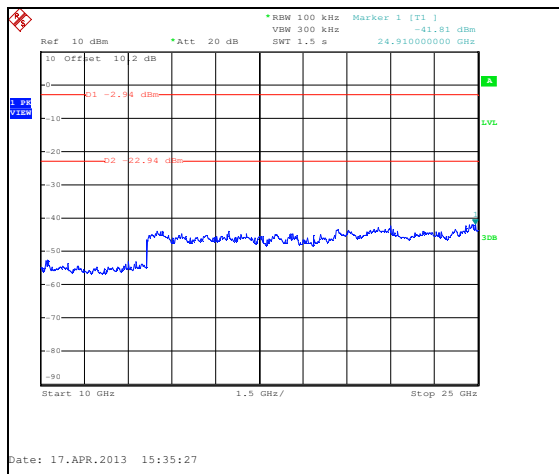

Figure 7.5.1.2-9: 10 GHz – 25 GHz – 2480 MHz – ANT 0

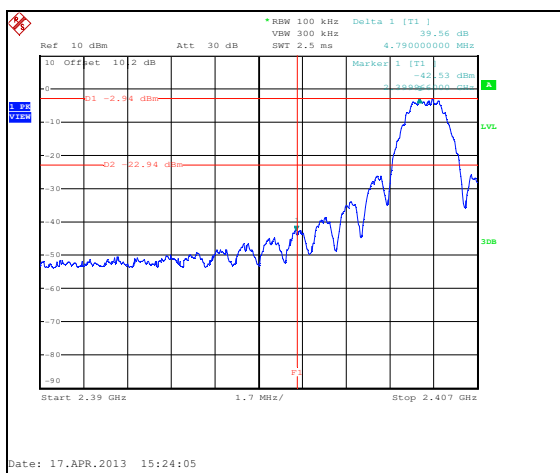

Figure 7.5.1.2-10: Lower Band-edge - 2405 MHz – ANT 0

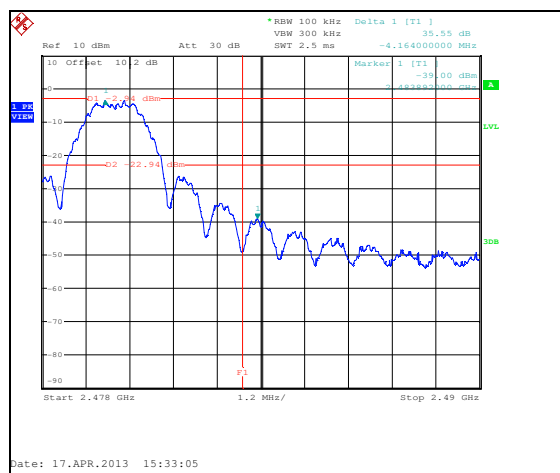

Figure 7.5.1.2-11: Upper Band-edge - 2480 MHz – ANT 0

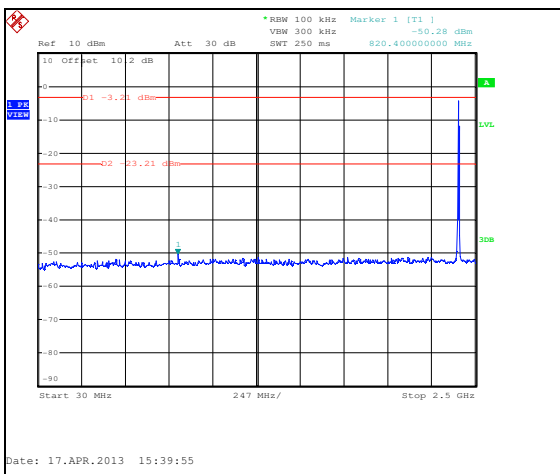

Figure 7.5.1.2-12: 30 MHz – 2.5 GHz – 2405 MHz – ANT 1

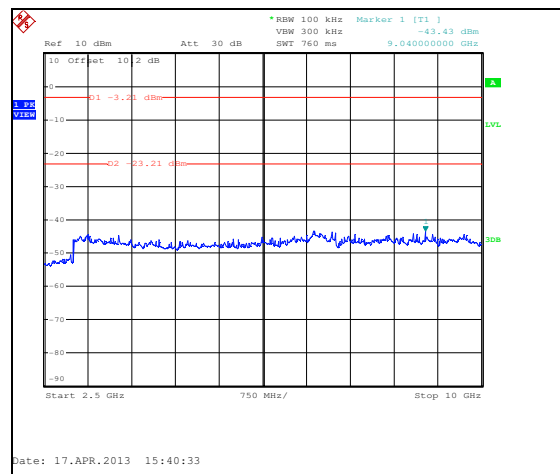

Figure 7.5.1.2-13: 2.5 GHz – 10 GHz – 2405 MHz – ANT 1

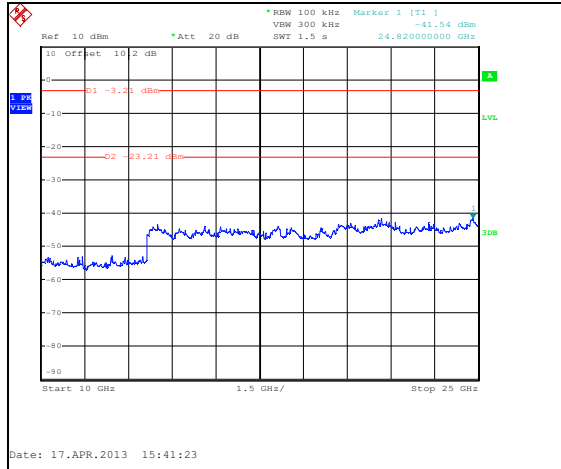

Figure 7.5.1.2-14: 10 GHz – 25 GHz – 2405 MHz – ANT 1

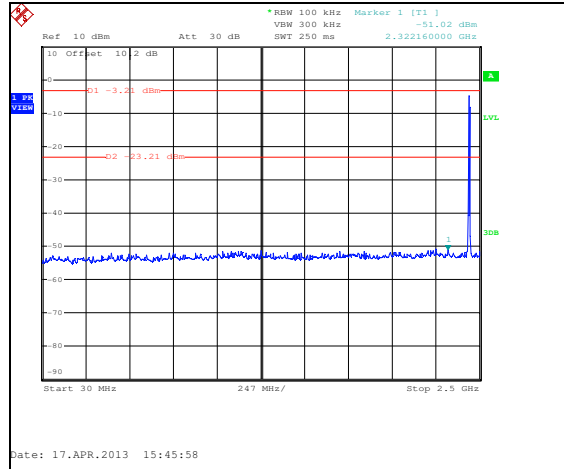

Figure 7.5.1.2-15: 30 MHz – 2.5 GHz – 2440 MHz – ANT 1

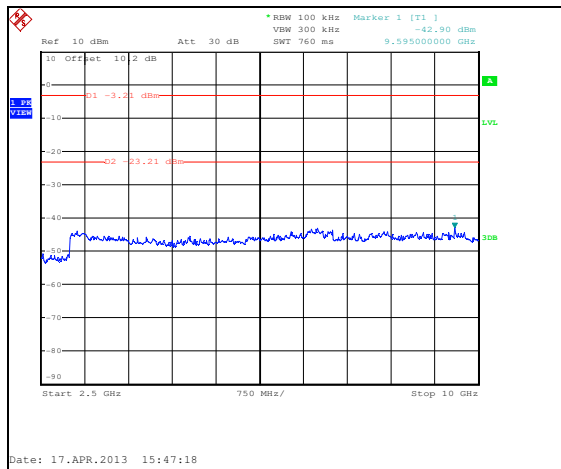

Figure 7.5.1.2-16: 2.5 GHz – 10 GHz – 2440 MHz – ANT 1

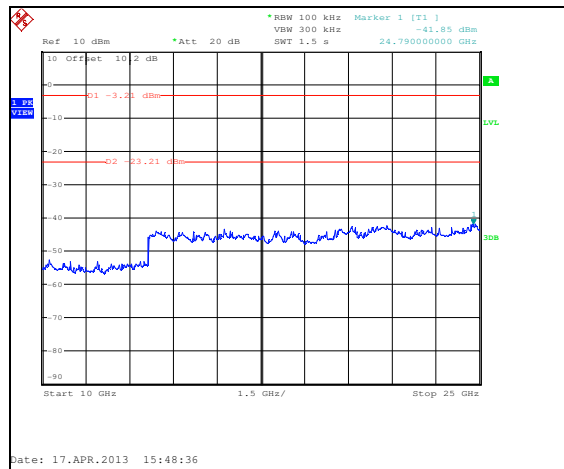

Figure 7.5.1.2-17: 10 GHz – 25 GHz – 2440 MHz – ANT 1

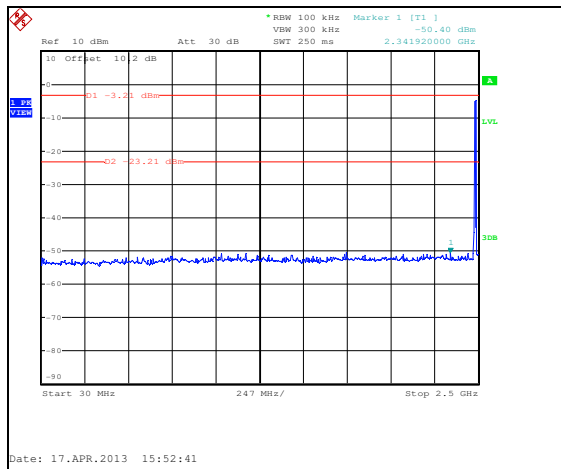

Figure 7.5.1.2-18: 30 MHz – 2.5 GHz – 2480 MHz – ANT 1

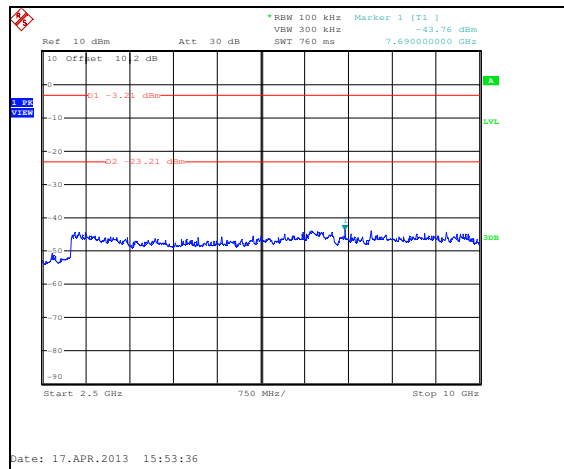

Figure 7.5.1.2-19: 2.5 GHz – 10 GHz – 2480 MHz – ANT 1

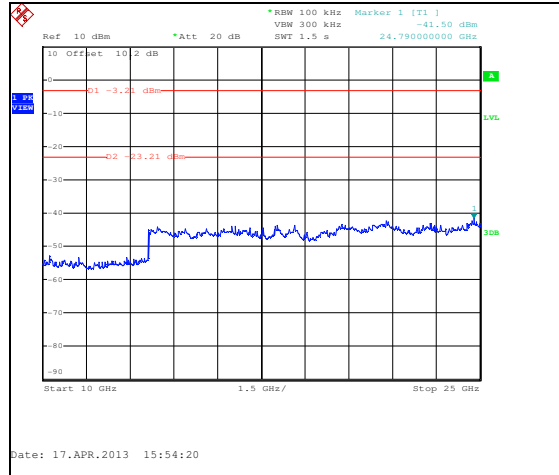

Figure 7.5.1.2-20: 10 GHz – 25 GHz – 2480 MHz – ANT 1

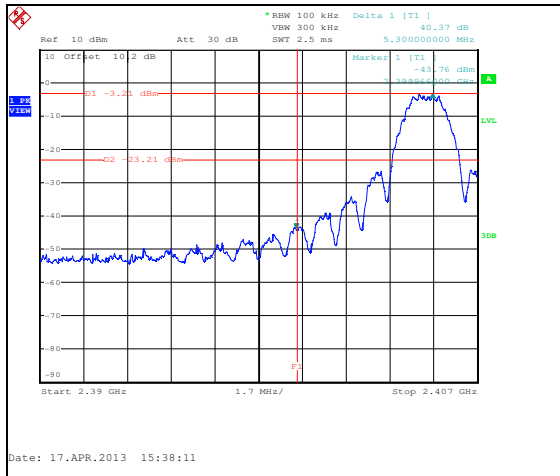

Figure 7.5.1.2-21: Lower Band-edge - 2405 MHz – ANT 1

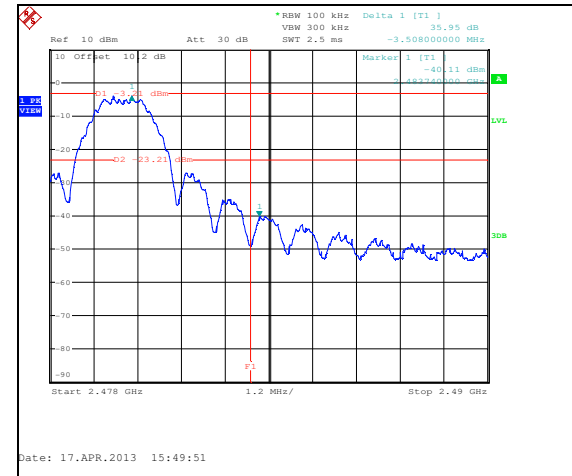

Figure 7.5.1.2-22: Upper Band-edge - 2480 MHz – ANT 1

7.5.2 Emissions into Restricted Frequency Bands

7.5.2.1 Measurement Procedure

The unwanted emissions into restricted bands were measured radiated over the frequency range of 30MHz to 25GHz, 10 times the highest fundamental frequency.

The EUT was rotated through 360° and the receive antenna height was varied from 1m to 4m so that the maximum radiated emissions level would be detected. For frequencies below 1000MHz, quasi-peak measurements were made using a resolution bandwidth RBW of 120 kHz and a video bandwidth VBW of 300 kHz. For frequencies above 1000MHz, peak and average measurements were made with RBW and VBW of 1 MHz and 3 MHz respectively. The average emissions were further corrected by applying the duty cycle correction of the EUT for comparison to the average limit.

Each emission found to be in a restricted band as defined by section 15.205, including any emission at the operational band-edge, was compared to the radiated emission limits as defined in section 15.209.

7.5.2.2 Duty Cycle Correction

For average radiated measurements, using a 34% duty cycle, the measured level was reduced by a factor 9.37dB. The duty cycle correction factor is determined using the formula: $20\log(34/100) = -9.37\text{dB}$.

A detailed analysis of the duty cycle timing is provided in the Theory of Operation accompanying the application for certification.

7.5.2.3 Measurement Results

Radiated spurious emissions found in the band of 30MHz to 25GHz are reported in the tables 7.5.2.3-1 to 7.5.2.3-2 below.

Table 7.5.2.3-1: Radiated Spurious Emissions Tabulated Data – ANT 0

Frequency (MHz)	Level (dBuV)		Antenna Polarity (H/V)	Correction Factors (dB)	Corrected Level (dBuV/m)		Limit (dBuV/m)		Margin (dB)	
	pk	Qpk/Avg			pk	Qpk/Avg	pk	Qpk/Avg	pk	Qpk/Avg
2405 MHz										
2405*	101.87	96.01	H	-5.35	96.52	81.29	-----	-----	-----	-----
2405*	99.11	93.04	V	-5.35	93.76	78.32	-----	-----	-----	-----
2440 MHz										
2440*	103.27	97.33	H	-5.19	98.08	82.77	-----	-----	-----	-----
2440*	105.43	99.01	V	-5.19	100.24	84.45	-----	-----	-----	-----
2480 MHz										
2480*	101.62	95.81	H	-5.01	96.61	81.43	-----	-----	-----	-----
2480*	103.48	97.61	V	-5.01	98.47	83.23	-----	-----	-----	-----
2483.5	69.74	60.04	H	-5.00	64.74	45.67	74.0	54.0	9.3	8.3
2483.5	71.24	61.51	V	-5.00	66.24	47.14	74.0	54.0	7.8	6.9

* Fundamental emission and not subject to emission limits. Reference only.

Table 7.5.2.3-2: Radiated Spurious Emissions Tabulated Data – ANT 1

Frequency (MHz)	Level (dBuV)		Antenna Polarity (H/V)	Correction Factors (dB)	Corrected Level (dBuV/m)		Limit (dBuV/m)		Margin (dB)	
	pk	Qpk/Avg			pk	Qpk/Avg	pk	Qpk/Avg	pk	Qpk/Avg
2405 MHz										
2405*	99.29	93.47	H	-5.35	93.94	78.75	-----	-----	-----	-----
2405*	98.35	92.49	V	-5.35	93.00	77.77	-----	-----	-----	-----
2440 MHz										
2440*	100.05	94.10	H	-5.19	94.86	79.54	-----	-----	-----	-----
2440*	102.56	95.96	V	-5.19	97.37	81.40	-----	-----	-----	-----
2480 MHz										
2480*	96.18	89.93	H	-5.01	91.17	75.55	-----	-----	-----	-----
2480*	101.82	95.76	V	-5.01	96.81	81.38	-----	-----	-----	-----
2483.5	64.26	54.63	H	-5.00	59.26	40.26	74.0	54.0	14.7	13.7
2483.5	70.07	60.47	V	-5.00	65.07	46.10	74.0	54.0	8.9	7.9

* Fundamental emission and not subject to emission limits. Reference only.

7.5.2.4 Sample Calculation:

$$R_C = R_U + CF_T$$

Where:

- CF_T = Total Correction Factor (AF+CA+AG)-DC (Average Measurements Only)
- R_U = Uncorrected Reading
- R_C = Corrected Level
- AF = Antenna Factor
- CA = Cable Attenuation
- AG = Amplifier Gain
- DC = Duty Cycle Correction Factor

Example Calculation: Peak

Corrected Level: 69.74 - 5.00 = 64.74dBuV/m

Margin: 74dBuV/m – 64.74dBuV/m = 9.3dB

Example Calculation: Average

Corrected Level: 60.04 - 5.00 - 9.37 = 45.67dBuV

Margin: 54dBuV – 45.67dBuV = 8.3dB

7.6 Maximum Power Spectral Density in the Fundamental Emission – FCC: Section 15.247(e) IC: RSS-210 A8.2(b)

7.6.1 Measurement Procedure

The power spectral density was measured in accordance with the FCC KDB 558074 D01 DTS Meas Guidance v03r01 utilizing the PKPSD (peak PSD) method. The RF output of the equipment under test was directly connected to the input of the spectrum analyzer applying suitable attenuation. The Resolution Bandwidth (RBW) of the spectrum analyzer was set to 3 kHz. The Video Bandwidth (VBW) was set to 10 kHz. Span was set to 1.5 times the DTS bandwidth. The trace was set to max hold with a peak detector active.

7.6.2 Measurement Results

Results are shown below in tables 7.6.2-1 to 7.6.2-2 and figures 7.6.2-1 to 7.6.2-6.

Table 7.6.2-1: Peak Power Spectral Density – ANT 0

Frequency (MHz)	PSD Level (dBm)
2405	-14.12
2440	-15.51
2480	-15.05

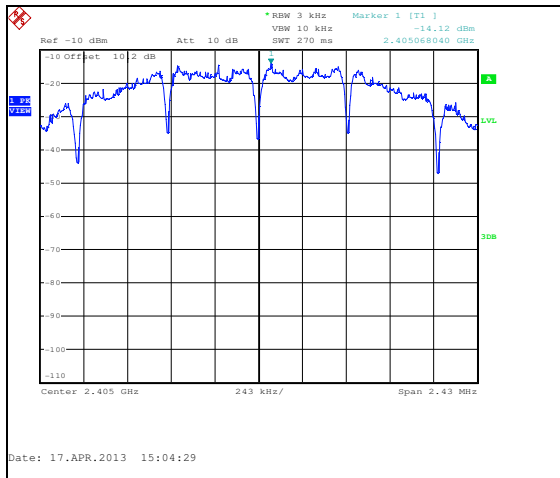

Figure 7.6.2-1: PSD Plot – 2405 MHz

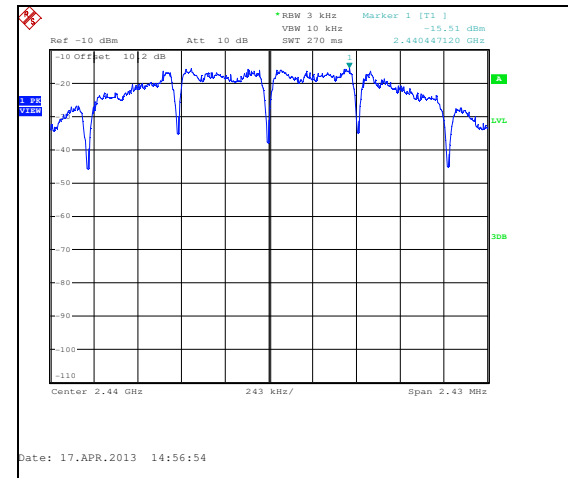

Figure 7.6.2-2: PSD Plot – 2440 MHz

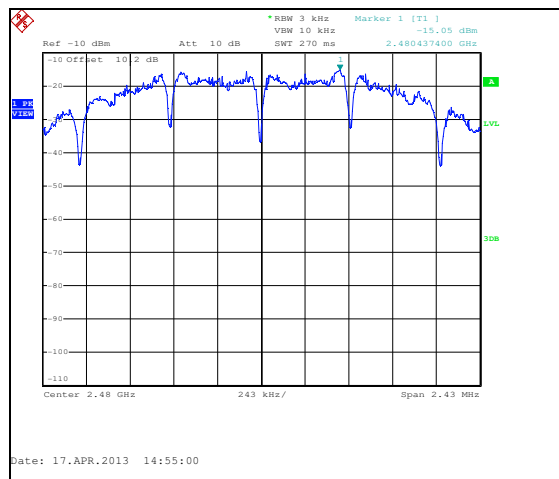

Figure 7.6.2-3: PSD Plot – 2480 MHz

Table 7.6.2-2: Peak Power Spectral Density – ANT 1

Frequency (MHz)	PSD Level (dBm)
2405	-14.90
2440	-15.37
2480	-15.54

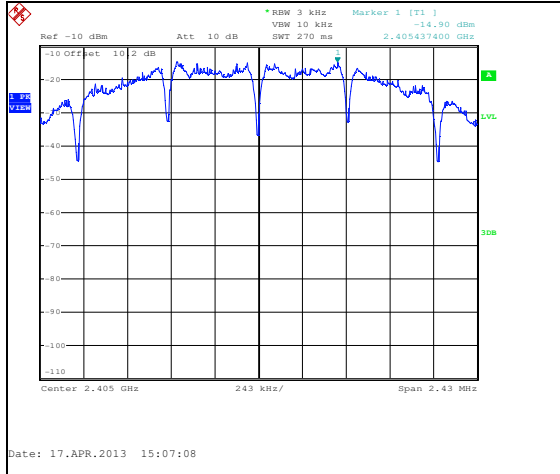

Figure 7.6.2-4: PSD Plot – 2405 MHz

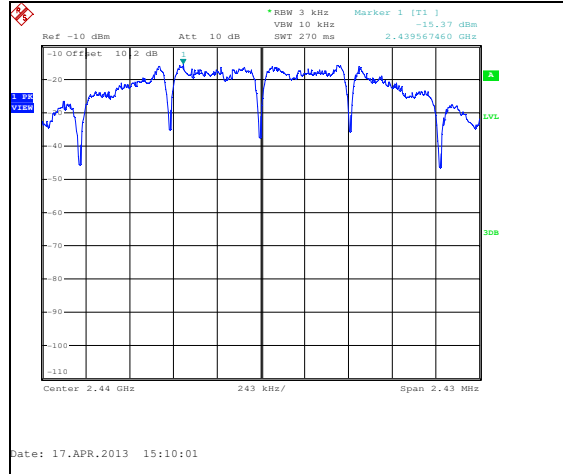

Figure 7.6.2-5: PSD Plot – 2440 MHz

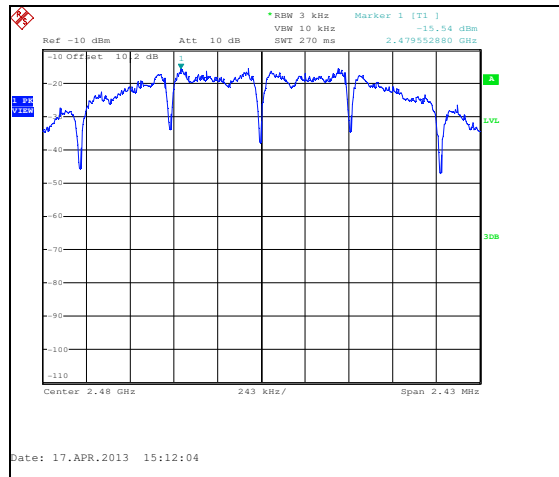

Figure 7.6.2-6: PSD Plot – 2480 MHz

8 CONCLUSION

In the opinion of ACS, Inc. the MG2402G/CT, manufactured by Arris International, Inc. meets the requirements of FCC Part 15 subpart C and Industry Canada's Radio Standards Specification RSS-210.

END REPORT