

**COMPLIANCE WORLDWIDE INC.
TEST REPORT 265-13R2**

In Accordance with the Requirements of
Industry Canada RSS 213, Issue 2, December 2005
2 GHz License-exempt Personal Communications Service Devices (LE-PCS)

Federal Communications Commission 47 CFR Part 15, Subpart D
Technical Requirements for
Unlicensed Personal Communication Systems (UPCS)

Issued to

**ARRIS International, Inc.
3871 Lakefield Drive, Suite 300
Suwanee, GA 30024**

For the

MG2402G/CT

**FCC ID: UID2402GCT
IC: 6670A-2402GCT**

**Report Issued on April 29, 2013
Revision R2 Issued on June 17, 2013**

Tested by

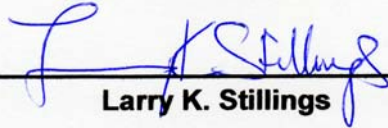

Larry K. Stillings

Reviewed By



Brian F. Breault

This test report shall not be reproduced, except in full, without written permission from Compliance Worldwide, Inc.

Table of Contents

1. Scope.....	3
2. Product Details.....	3
2.1. Manufacturer.....	3
2.2. Model Number.....	3
2.3. Serial Number.....	3
2.4. Description.....	3
2.5. Power Source.....	3
2.6. Hardware Revision.....	3
2.7. Software Revision.....	3
2.8. Modulation Type.....	3
2.9. Operating Frequency.....	3
2.10. Emission Designator.....	3
2.11. EMC Modifications.....	3
3. Product Configuration.....	3
3.1. Cables.....	3
3.2. EUT Hardware.....	4
3.3. Support Equipment.....	4
3.4. EUT Diagram.....	4
3.5. EUT Channels & Frequencies.....	5
4. Measurements Parameters.....	6
4.1. Measurement Equipment Used to Perform Test.....	6
4.2. Measurement & Equipment Setup.....	7
4.3. Measurement Procedure.....	7
4.4. Measurement Uncertainty.....	7
5. Measurement Summary.....	8
6. Measurement Data.....	9
6.1. Antenna Gain.....	9
6.2. Type of Modulation and Access Protocol.....	9
6.3. Peak Transmit Power.....	10
6.4. Emission Bandwidth.....	14
6.5. Spurious Emissions at the antenna terminals.....	19
6.6. Radiated Spurious Emissions (Harmonics).....	30
6.7. Power Spectral Density.....	33
6.8. Conducted Emissions.....	38
6.9. Frequency Stability.....	41
6.10. Transmitter Spurious Emissions.....	43
6.11. Specific Requirements to UPCS Devices.....	47
6.12. Public Exposure to Radio Frequency Energy Levels.....	69
7. Test Images.....	71
8. Test Site Description.....	79

1. Scope

This test report certifies that the Set top Box model MG2402G/CT, as tested, meets the FCC Part 15, Subpart D and Industry Canada RSS 213 requirements. The scope of this test report is limited to the test sample provided by the client, only in as much as that sample represents other production units. If any significant changes are made to the unit, the changes shall be evaluated and a retest may be required. Revision R1 updates the test report per TCB findings letter. Revision R2 updates the radiated and conducted emissions data, and updates the Least Interfered Channel data and documentation in Section 6.11.7

2. Product Details

- 2.1. **Manufacturer:** ARRIS Group, Inc.
- 2.2. **Model Numbers:** MG2402G/CT
- 2.3. **Serial Number:** HSF 120936209999920-60B35ZM10B01P (antenna port conducted)
- 2.4. **Description:** The MG2402G/CT provides a DECT interface so remote handsets can be used in a VoIP configuration over the coaxial cable provider's network.
- 2.5. **Power Source:** 12 VDC to 120 VAC via External Power Supply
- 2.6. **Hardware Revision:** V 8.0.40
- 2.7. **Software Revision:** 3.28
- 2.8. **Modulation Type:** GFSK
- 2.9. **Operating Frequencies:** 1921.536 -1928.448 MHz
- 2.10. **Emission Designator:** 1M49F7E (FCC), 1M20F7E (IC)
- 2.11. **EMC Modifications:** None

3. Product Configuration

3.1. Cables

Cable Type	Length	Shield	From	To
Ethernet x4 Ports	2 M	No	EUT	1 – Vostro Laptop, 3 Unterminated
Telephone Cables x2	2 M	No	EUT	1 – Telephone, 1 Unterminated
eSATA Cable	2 M	Yes	EUT	1 – External Sata Drive
USB Cable x2	2 M	Yes	EUT	1 – USB Flash Drive, 1 Unterminated
Coaxial Cable	2 M	Yes	EUT	75 ohm termination
Power Cable	2 M + 1M	No	EUT	12 VDC Power Supply

3. Product Configuration (continued)

3.2. EUT Hardware

Device	Manufacturer	Model	Serial No.	Comment
DECT Radio Device	ARRIS Group	MG2402G/CT	Pre Production	
12 VDC External Power Supply	Delta Electronics	ADP-66AR A	No 9	

3.3. Support Equipment

Manufacturer	Model/Part #	Input Voltage	Input Freq	Description/Function
Dell	Latitude D620	120V	60	Software Control via Serial Port
Dell	Vostro	120V	60	Ethernet Cable Config / Control
Emerson	EM-2115RW	N/A	N/A	Telephone
Kanguru	QS2	120V	60	eSata External Harddrive
Verbatim	4 GB	N/A	N/A	USB Flash Drive

3.4 EUT Diagram

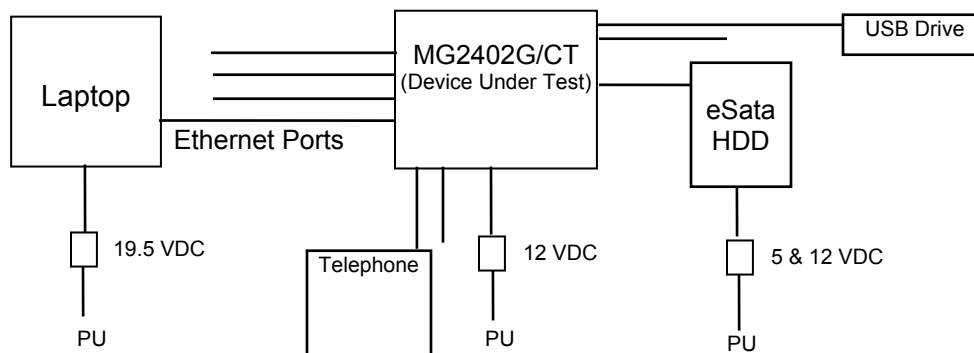

3. Product Configuration (continued)

3.5 EUT Channels & Frequencies

Channel Plan	Channel	Frequency (MHz)	
Band Edge		1930.000	Note: The channel numbers count down vs. frequency
Measure	0	1928.448	
	1	1926.720	
Measure	2	1924.992	
	3	1923.264	
Measure	4	1921.536	
Band Edge		1920.000	

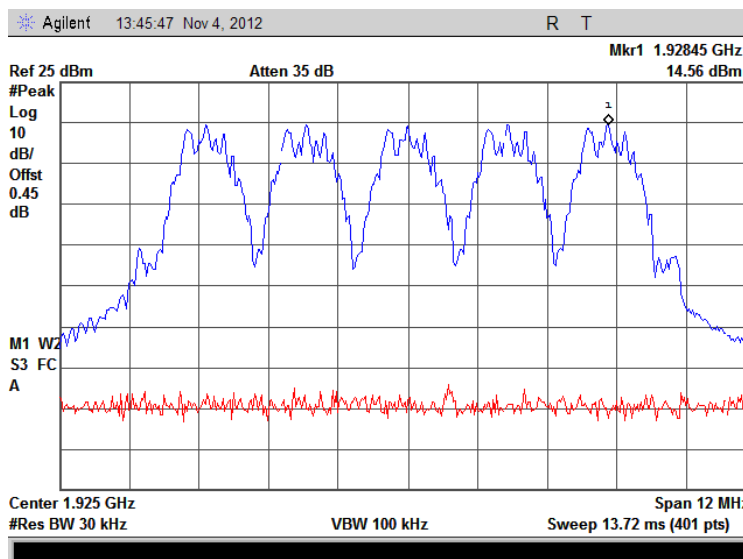

4. Measurements Parameters

4.1. Measurement Equipment Used to Perform Test

Device	Manufacturer	Model No.	Serial No.	Cal Due
Spectrum Analyzer 20 Hz to 40 GHz	Rohde & Schwarz	FSV40	100899	5/26/2013
Spectrum Analyzer 100Hz to 26.5 GHz	Agilent Technologies	E7405A	MY45115430	5/11/2013
EMI Receiver 9 kHz to 6.5 GHz	Hewlett Packard	8546A	3650A00360	6/13/2014
Microwave Preamp 2 to 50 GHz	Hewlett Packard	83050A	3331A00404	6/6/2013
Loop Antenna 9 kHz to 30 MHz	EMCO	6512	9309-1139	8/28/2014
Bilog Antenna 30 to 2000 MHz	Com-Power	AC-220	25509	8/20/2013
Horn Antenna 1 to 18 GHz	ETS-Lindgren	3117	00143292	1/14/2015
Horn Antenna 18 to 40 GHz	Com-Power	AH-840	03075	8/27/2014
High Pass Filter 2.5 to 20 GHz	Micro-Tronics	HPM50110	070	06/25/2013
DMM / Temperature	Fluke	187	79690058	2/21/2014
Barometer	Control Company	4195	Cal ID# 236	2/25/2015
Thermal Chamber	Associated Testing Labs	SLHU-1-CRLC	N/A	CNR
Directional Coupler 1.7 – 26.5 GHz	Narda Microwave	4227-16	03034	11/01/2013
Digital Radio Communication Tester	Rohde & Schwarz	CTS65	829877/006	11/02/2013
RF Signal Generator 9 kHz to 3.2 GHz	Hewlett Packard	8648C	3642U01557	12/5/2013
RF Signal Generator 5 kHz to 6.4 GHz	Rohde & Schwarz	SMIQ06B	100090	2/22/2015
Modulation Generator	Rohde & Schwarz	AMIQ04	100540	CBU
DC Source 0-60 Volts, 0-3 Amps	Hewlett Packard	6296A	7M0599	2/22/2014
Power Splitter Resistive DC – 4.2 GHz	RF Bay	PSC-2R-42	14110124	01/14/2014
Power Splitter Resistive DC – 4.2 GHz	RF Bay	PSC-2R-42	14110125	01/14/2014
Power Splitter Resistive DC – 4.2 GHz	RF Bay	PSC-2R-42	14110126	01/14/2014
LISN 9 kHz to 30 MHz	EMCO	3825/2	9109-1860	7/2/2013

4. Measurements Parameters (continued)

4.2. Measurement & Equipment Setup

Test Date: 4/19/2013, 4/20/2013, 4/22/2013,
4/23/2013, 6/10/2013, 6/13/2013,
6/17/2013

Test Engineer: Larry Stillings

Normal Site Temperature (15 – 35 °C): 21.6 °C

Relative Humidity (20 – 75 %RH): 35 %

Frequency Range: 150 kHz to 19.3 GHz

Measurement Distance: 3 Meters or 1 Meter as necessary

EMI Receiver IF Bandwidth: 9 kHz – 150 kHz to 30 MHz
120 kHz - 30 MHz to 1000 MHz
1 MHz - Above 1000 MHz

EMI Receiver Avg Bandwidth: 30 kHz – 150 kHz to 30 MHz
300 kHz - 30 MHz to 1000 MHz
3 MHz - Above 1000 MHz

Detector Function: Peak, Quasi-Peak, EMI Average
and RMS Average

4.3. Measurement Procedure

Test measurements were made in accordance FCC Part 15.315, 15.317, 15.319, 15.323, IC RSS-213 Issue 2, and ANSI C63.17:2006.

The test methods used to generate the data is this test report is in accordance with ANSI C63.17:2006, American National Standard Methods of Measurement of the Electromagnetic and Operational Compatibility of Unlicensed Personal Communications Services (UPCS) Devices.

4.4. Measurement Uncertainty

The following uncertainties are expressed for an expansion/coverage factor of K=2.

RF Frequency (out of band)	$\pm 1 \times 10^{-8}$
Radiated Emission of Transmitter to 20 GHz	± 4.55 dB
Radiated Emission of Receiver	± 4.55 dB
Temperature	$\pm 0.91^{\circ}$ C
Humidity	$\pm 5\%$

5. Measurements Summary

Test Requirement	FCC Rule Requirement	IC Rule Requirement	Test Report Section	Result	Comment
Antenna Requirement	15.317 15.203	RSS-GEN 7.1.4	6.1	Compliant	Equipment uses an PCB Mounted Ant
Antenna Gain	15.319 (e)	RSS 213 4.1 (e)	6.1	Compliant	0.5 dBi Peak
Type of Modulation and Access Protocol	15.319 (b) 15.307	RSS-213 6.1	6.2	Compliant	Device uses GFSK Digital Modulation
Peak Transmit Power	15.319 (c)	RSS-213 6.5	6.3	Compliant	
Emission Bandwidth Occupied Bandwidth	15.323 (a)	RSS-213 6.4	6.4	Compliant	
Spurious Conducted Emissions – Antenna Port	15.323 (d) 15.319 (g)	RSS-213 6.7	6.5	Compliant	
Spurious Radiated Emissions for integral antennas	15.323 (d) 15.319 (g) 15.209	RSS-213 6.7	6.6	Compliant	
Power Spectral Density	15.319 (d)	RSS-213 6.6	6.7	Compliant	
Conducted Emissions	15.315 15.207	RSS-213 6.3 RSS-GEN	6.8	Compliant	
Frequency Stability	15.323 (f)	RSS-213 6.2	6.9	Compliant	
Transmitter Spurious Emissions	15.323 (d) 15.209	RSS-213 6.7	6.10	Compliant	
Specific Requirements for UPCS	15.323 (c) 15.323 (e)	RSS-213 4.3.4 RSS-213 6.1	6.11	Compliant	
Radio Frequency Exposure	15.319 (i) 2.1091 FCC OET Bulletin 65	RSS-GEN 5.5 RSS-102	6.12	Compliant	

6. Measurement Data

6.1. Antenna Requirement (15.317, 15.203, RSS-GEN Section 7.1.4)

Requirement: An intentional radiator shall be designed to ensure that no antenna other than that furnished by the responsible party shall be used with the device. The use of a permanently attached antenna or of an antenna that uses a unique coupling to the intentional radiator shall be considered sufficient to comply. Further, this requirement does not apply to intentional radiators that must be professionally installed, such as perimeter protection systems and some field disturbance sensors, or to other intentional radiators which, in accordance with § 15.31(d), must be measured at the installation site. However, the installer shall be responsible for ensuring that the proper antenna is employed so that the limits in this part are not exceeded.

Result: The EUT incorporates two PCB mounted antennas for antenna diversity.

6.1.1 Antenna Gain (15.319 (e), RSS-213 Section 4.1(e))

Requirement: The peak transmit power shall be reduced by the amounts in decibels that the maximum directional gain of the antenna exceeds 3 dBi

Result: Compliant, the EUT uses two PCB Mount antennas for antenna diversity with a gain of 0.5 dBi peak each.

6.2 Type of Modulation and Access Protocol (15.319 (b), 15.307, RSS-213 Sect 4.1(e))

Requirement: UTAM, Inc. is designated to coordinate and manage the transition of the 1910–1930 MHz band from the Private Operational-Fixed Microwave Service (OFS) operating under part 101 of this chapter to unlicensed PCS operations.

Result: A letter from UTAM to ARRIS Group, Inc. will be provided as part of the submittal.

Requirement: Equipment certified under this standard shall use digital modulation.

Result: The product uses GFSK digital modulation.

6. Measurement Data

6.3. Peak Transmit Power (15.319 (c), RSS-213 Sec 6.5, ANSI C63.17 Sec 6.1.2)

Requirement: Peak transmit power shall not exceed 100 microwatts multiplied by the square root of the emission bandwidth in Hertz. Peak transmit power must be measured over any interval of continuous transmission using instrumentation calibrated in terms of an RMS equivalent voltage.

Peak power shall not exceed 100 microwatts multiplied by the square root of the occupied bandwidth in hertz.

EBW = 1487000 Hz, OBW = 1203700 Hz

$P_{max} = 100 \mu W * (EBW)^{1/2} = 100 \mu W * (1487000)^{1/2} = 121.94 mW = 20.86 dBm$

$P_{max} = 100 \mu W * (OBW)^{1/2} = 100 \mu W * (1203700)^{1/2} = 109.71 mW = 20.40 dBm$

ANT0 Channel	Channel Frequency	Peak Power	Requirement	Peak Power
	MHz	dBm	FCC = 20.86 dBm, IC = 20.40 dBm	Watts
TX4	1921.536	18.97	Compliant	0.079
TX2	1924.992	19.00	Compliant	0.079
TX0	1928.448	19.02	Compliant	0.080

ANT1 Channel	Channel Frequency	Peak Power	Requirement	Peak Power
	MHz	dBm	FCC = 20.86 dBm, IC = 20.40 dBm	Watts
TX4	1921.536	19.83	Compliant	0.096
TX2	1924.992	19.83	Compliant	0.096
TX0	1928.448	19.82	Compliant	0.096

Test Equipment Setup: EUT is configured to transmit a modulated signal in burst mode on the lowest, middle and highest channels. EUT is connected to the spectrum analyzer via on board u.fl connector and adapter cable. The spectrum analyzer is configured / triggered to capture a single peak pulse using a 3 MHz RBW. Cable loss is accounted for within the analyzer. Marker is moved to the highest peak of the pulse.

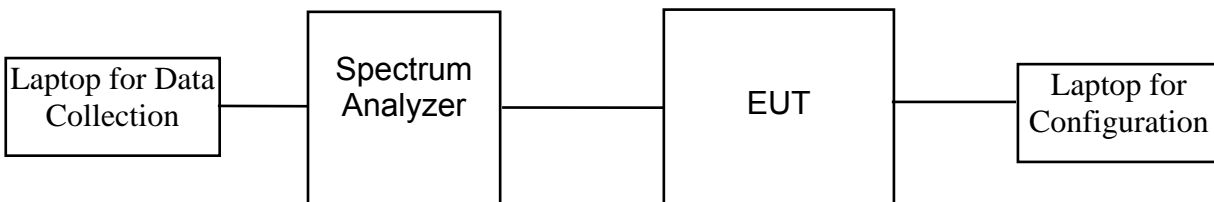

6. Measurement Data

6.3. Peak Transmit Power (15.319 (c), RSS-213 Sec 6.5, ANSI C63.17 Sec 6.1.2)

Channel 0 – ANT0

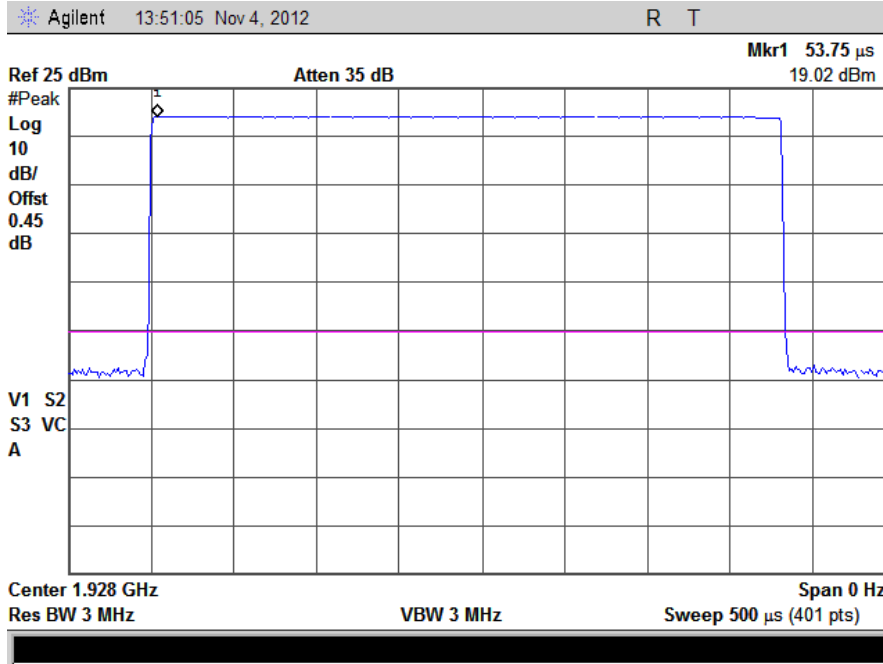

Channel 2 – ANT0

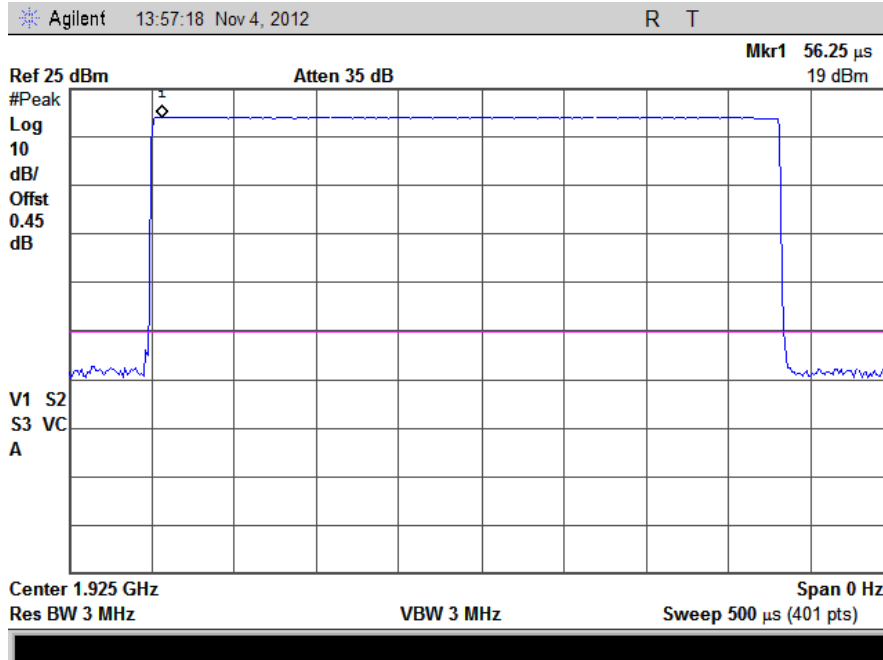

6. Measurement Data

6.3. Peak Transmit Power (15.319 (c), RSS-213 Sec 6.5, ANSI C63.17 Sec 6.1.2)

Channel 4 – ANT0

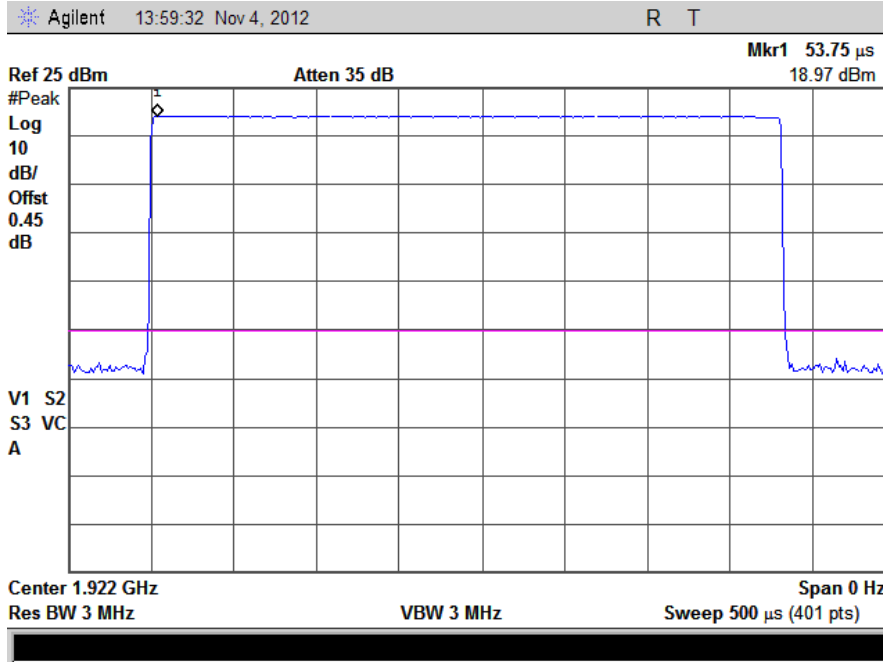

Channel 0 – ANT1

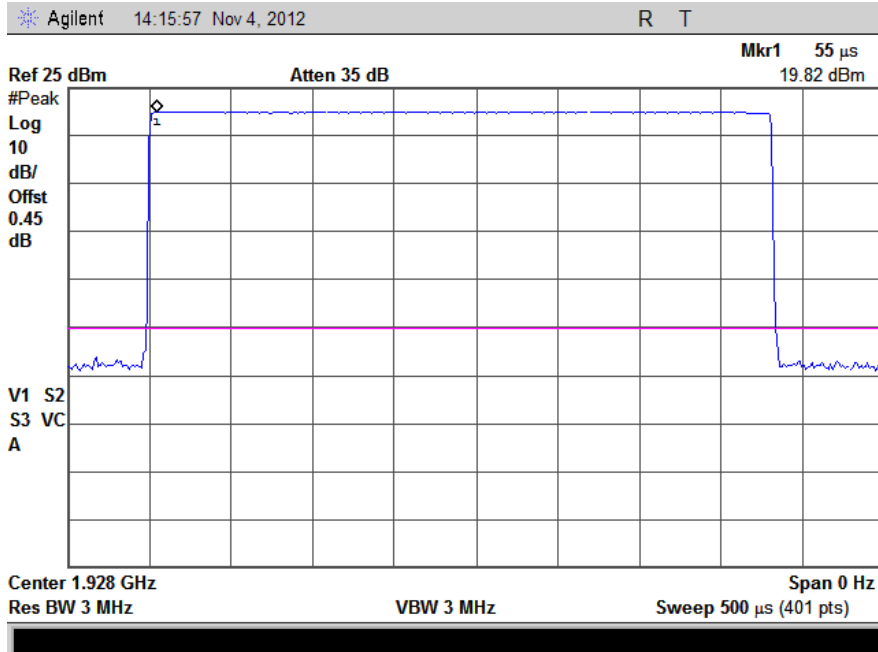

6. Measurement Data

6.3. Peak Transmit Power (15.319 (c), RSS-213 Sec 6.5, ANSI C63.17 Sec 6.1.2)

Channel 2 – ANT1

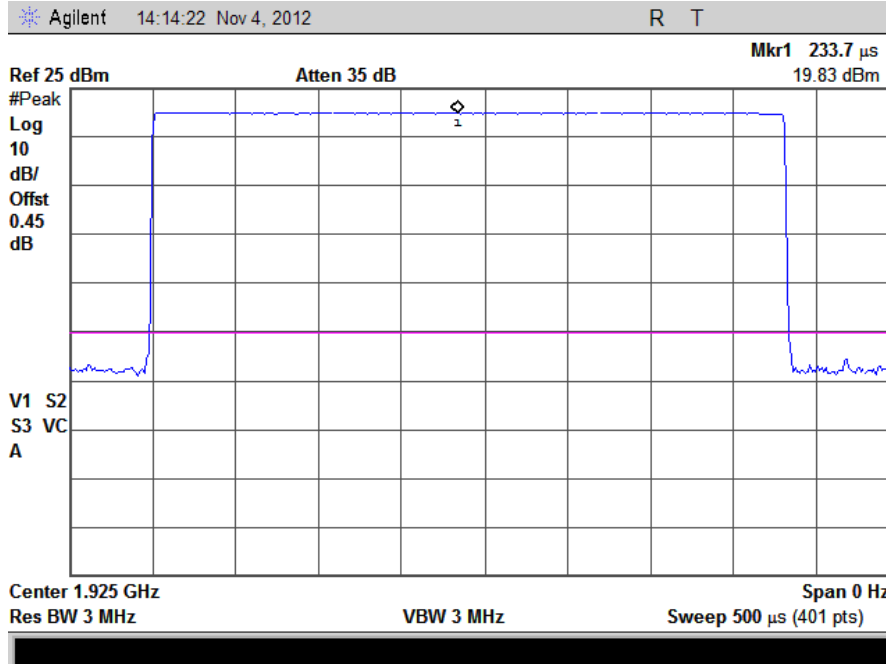

Channel 4 – ANT1

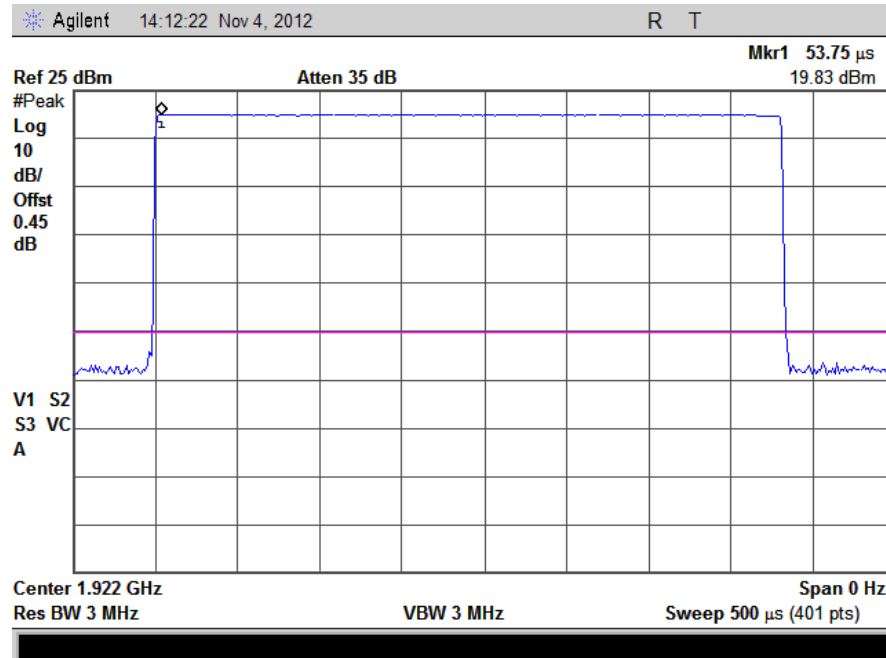

6. Measurement Data

6.4. Emission Bandwidth (15.323 (a), RSS-213 Section 6.4, ANSI C63.17 Sec 6.1.3)

Requirement: Operation shall be contained within the 1920–1930 MHz band. The emission bandwidth shall be less than 2.5 MHz. The power level shall be as specified in § 15.319 (c), but in no event shall the emission bandwidth be less than 50 kHz.

Test Equipment Setup: EUT is configured to transmit a modulated signal in burst mode on the lowest, middle and highest channels. The EUT is connected to the spectrum analyzer via on board u.fl connector and adapter cable. The spectrum analyzer is configured with a 30 kHz RBW over a 3 MHz Span. Cable loss is accounted for within the analyzer. Using the occupied BW function of the spectrum analyzer, the 26 dB and 99% Power bandwidths are recorded, allowing sufficient time for the analyzer’s max hold function to capture any transient effects associated with the burst edges.

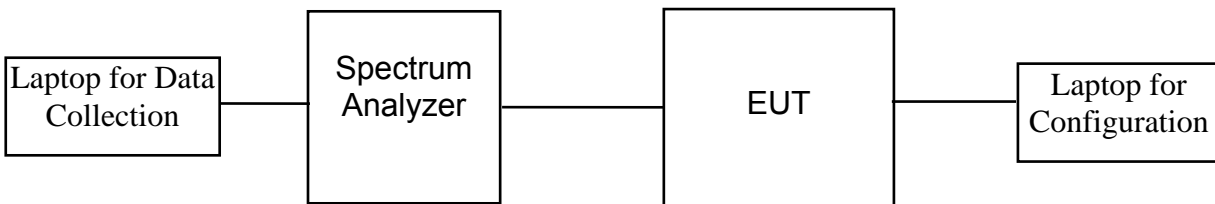

6.4.1. Measurement Data – 26 dB Emission Bandwidth (EBW)

ANT0 Channel	Channel Frequency	Emission Bandwidth	Requirement
	MHz	MHz	50 kHz < EBW < 2.5 MHz
TX4	1921.536	1.487	Compliant
TX2	1924.992	1.486	Compliant
TX0	1928.448	1.484	Compliant

ANT1 Channel	Channel Frequency	Emission Bandwidth	Requirement
	MHz	MHz	50 kHz < EBW < 2.5 MHz
TX4	1921.536	1.486	Compliant
TX2	1924.992	1.485	Compliant
TX0	1928.448	1.486	Compliant

6. Measurement Data

6.4. Emission Bandwidth (15.323 (a), RSS-213 Sec 6.4, ANSI C63.17 Sec 6.1.3) cont

6.4.2. Measurement Data – 99% Occupied Bandwidth (OBW)

ANT0 Channel	Channel Frequency	Occupied Bandwidth	Requirement
	MHz	MHz	50 kHz < OBW < 2.5 MHz
TX4	1921.536	1.1970	Compliant
TX2	1924.992	1.2037	Compliant
TX0	1928.448	1.1960	Compliant

ANT1 Channel	Channel Frequency	Occupied Bandwidth	Requirement
	MHz	MHz	50 kHz < OBW < 2.5 MHz
TX4	1921.536	1.1968	Compliant
TX2	1924.992	1.2033	Compliant
TX0	1928.448	1.2005	Compliant

Note: Please see the next pages for plots of measurements

6. Measurement Data (continued)

6.4. Emission Bandwidth (15.323 (a), RSS-213 Sec 6.4, ANSI C63.17 Sec 6.1.3) (cont)

6.4.3. Measurement Plot – TX0 – ANT0

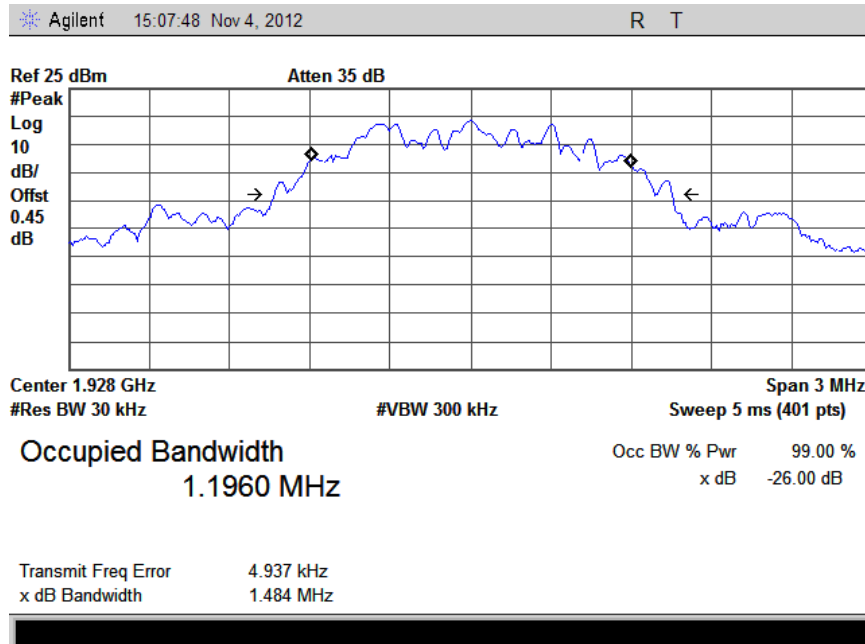

6.4.4. Measurement Plot – TX2 – ANT0

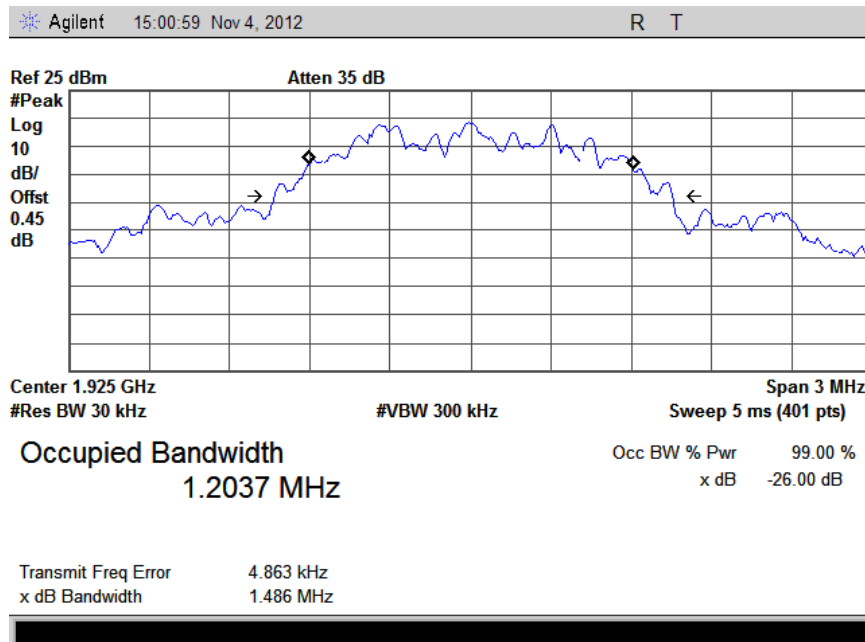

6. Measurement Data (continued)

6.4. Emission Bandwidth (15.323 (a), RSS-213 Sec 6.4, ANSI C63.17 Sec 6.1.3) (cont)

6.4.5. Measurement Plot – TX4- ANT0

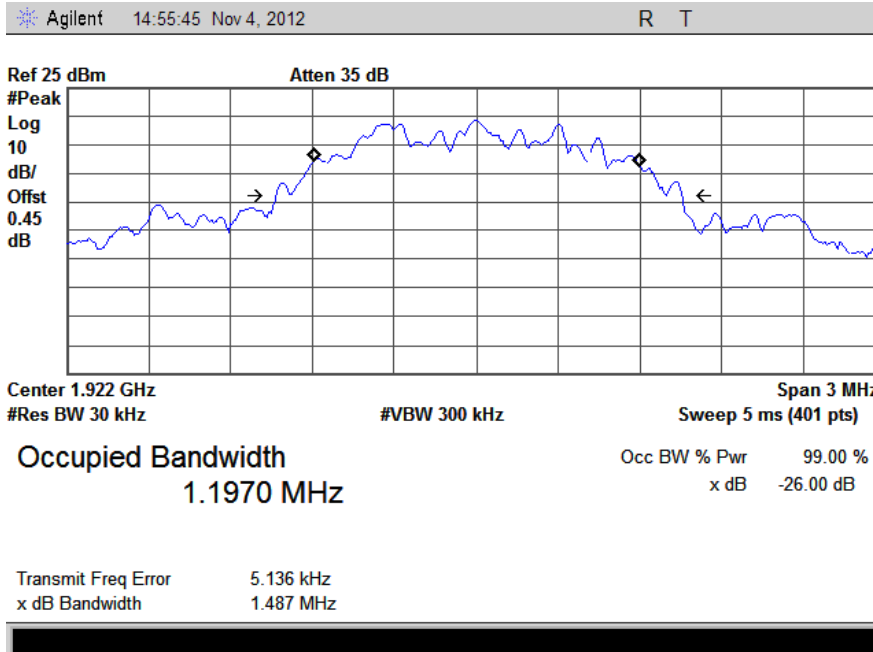

6.4.6. Measurement Plot – TX0- ANT1

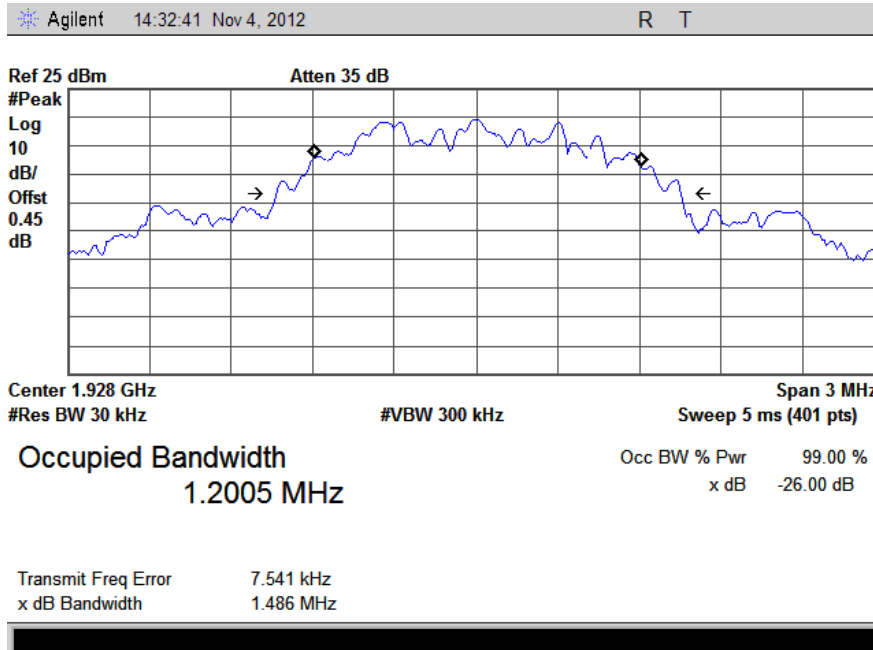

6. Measurement Data (continued)

6.4. Emission Bandwidth (15.323 (a), RSS-213 Sec 6.4, ANSI C63.17 Sec 6.1.3) (cont)

6.4.7. Measurement Plot – TX2 - ANT1

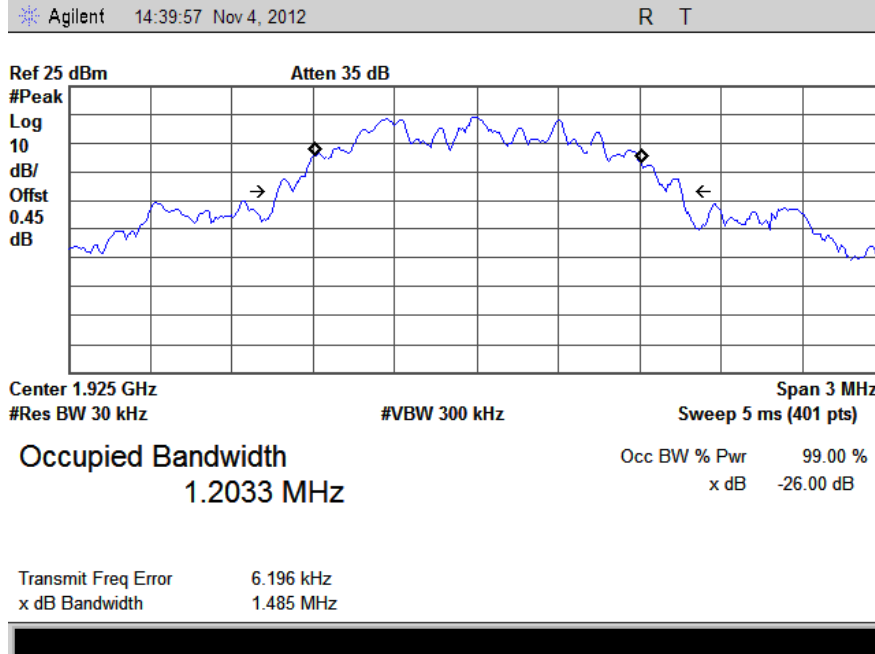

6.4.8. Measurement Plot – TX4 - ANT1

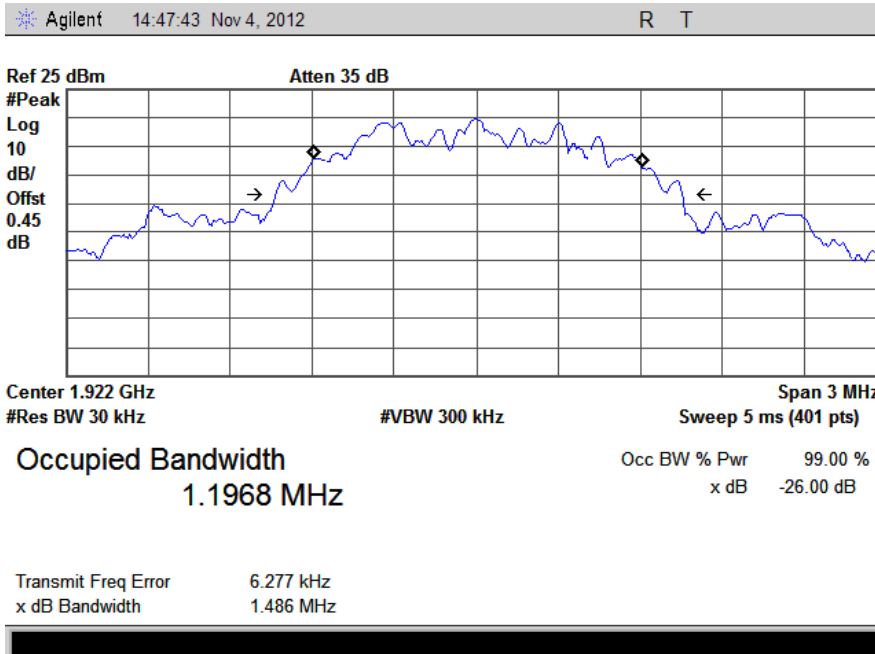

6. Measurement Data (continued)

6.5 Spurious Emissions at the antenna terminals (15.323 (d), RSS-213 6.7.2, ANSI C63.17 Sec 6.1.6)

Requirement: Emissions inside the sub-band must comply with the following emission mask: In the bands between 1B and 2B measured from the center of the emission bandwidth the total power emitted by the device shall be at least; 30 dB below the transmit power permitted for that device; in the bands between 2B and 3B measured from the center of the emission bandwidth the total power emitted by an intentional radiator shall be at least 50 dB below the transmit power permitted for that radiator; in the bands between 3B and the subband edge the total power emitted by an intentional radiator in the measurement bandwidth shall be at least 60 dB below the transmit power permitted for that radiator.

- 30 dB between the frequencies 1B and 2B measured from the centre of the occupied bandwidth;
- 50 dB between the frequencies 2B and 3B measured from the centre of the occupied bandwidth; and
- 60 dB between the frequencies 3B and band edge, where B is the occupied bandwidth in hertz.

Test Equipment Setup: EUT is configured to transmit a modulated signal in burst mode on the lowest, middle and highest channels. The EUT is connected to the spectrum analyzer via on board u.fl connector and adapter cable. The spectrum analyzer is configured with a 30 kHz RBW over a 10 MHz Span. Cable loss is accounted for within the analyzer. Using the mask defined above and allowing sufficient time for the analyzer's max hold function to capture any transient effects associated with the burst edges.

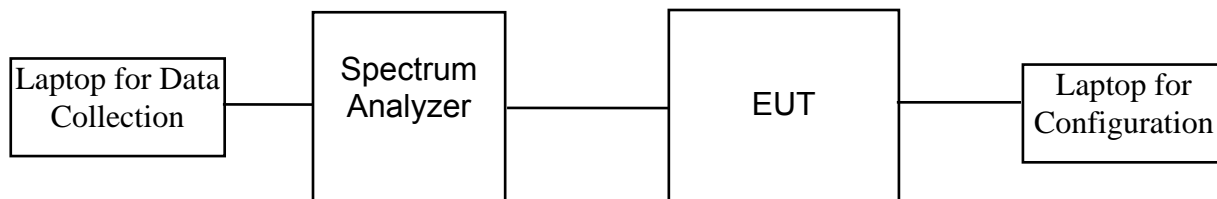

6. Measurement Data (continued)

6.5 Spurious Emissions at the antenna terminals (15.323 (d), RSS-213 6.7.2)) (cont)

6.5.1 Low Channel – In Band – ANT0

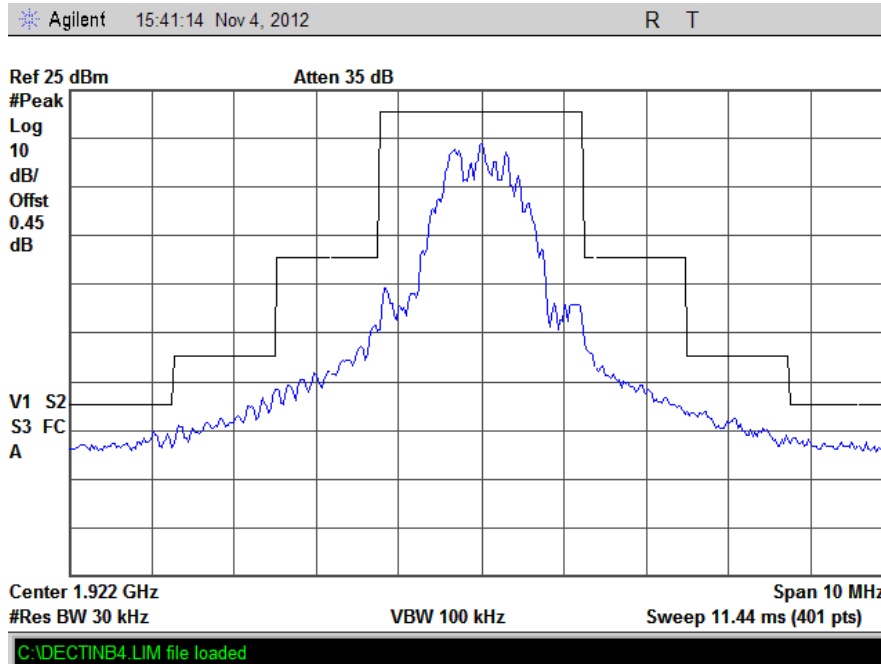

6.5.2 Mid Channel – In Band – ANT0

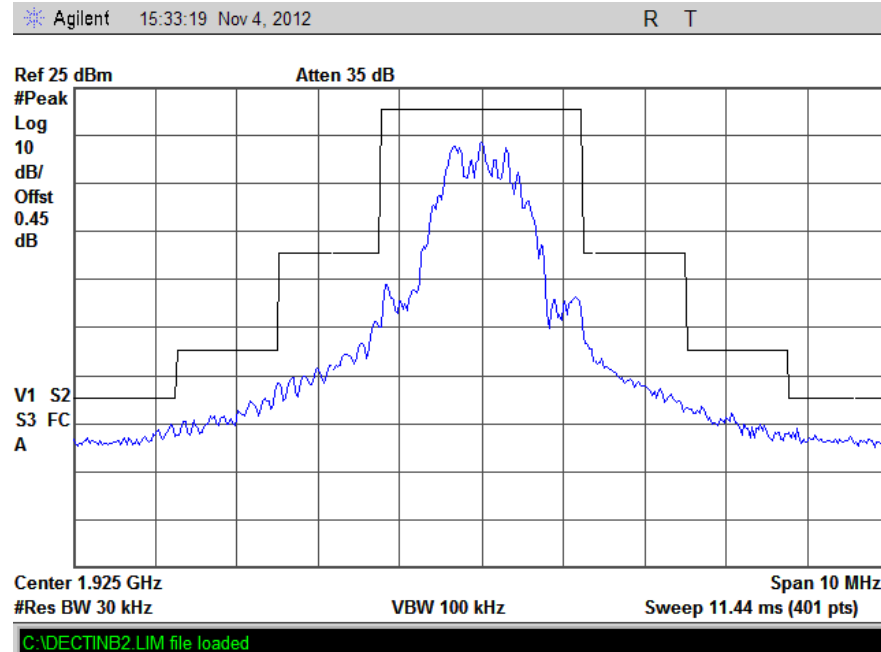

6. Measurement Data (continued)

6.5 Spurious Emissions at the antenna terminals (15.323 (d), RSS-213 6.7.2)) (cont)

6.5.3 High Channel – In Band – ANT0

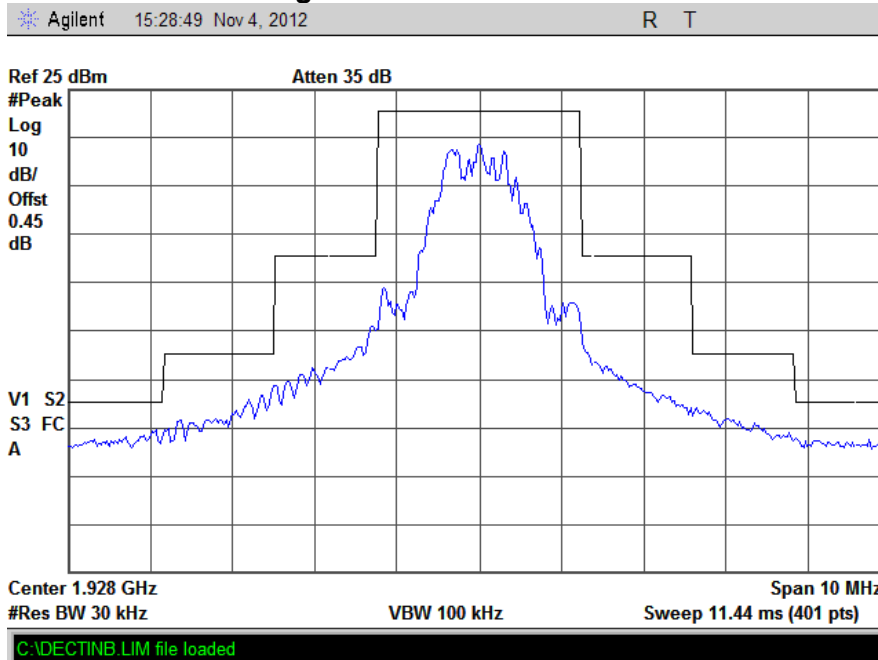

6.5.4 Low Channel – In Band – ANT1

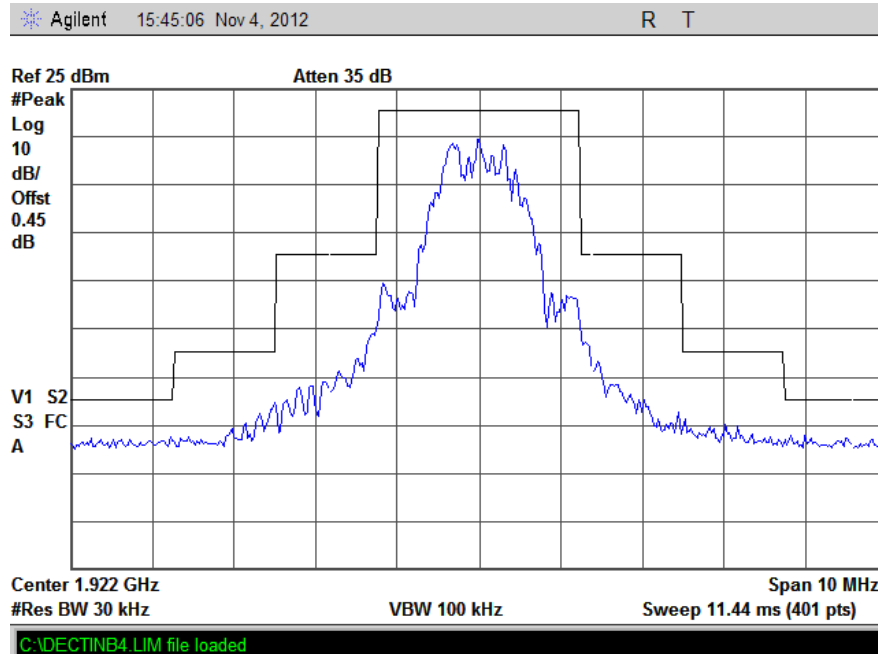

6. Measurement Data (continued)

6.5 Spurious Emissions at the antenna terminals (15.323 (d), RSS-213 6.7.2)) (cont)

6.5.5 Mid Channel – In Band – ANT1

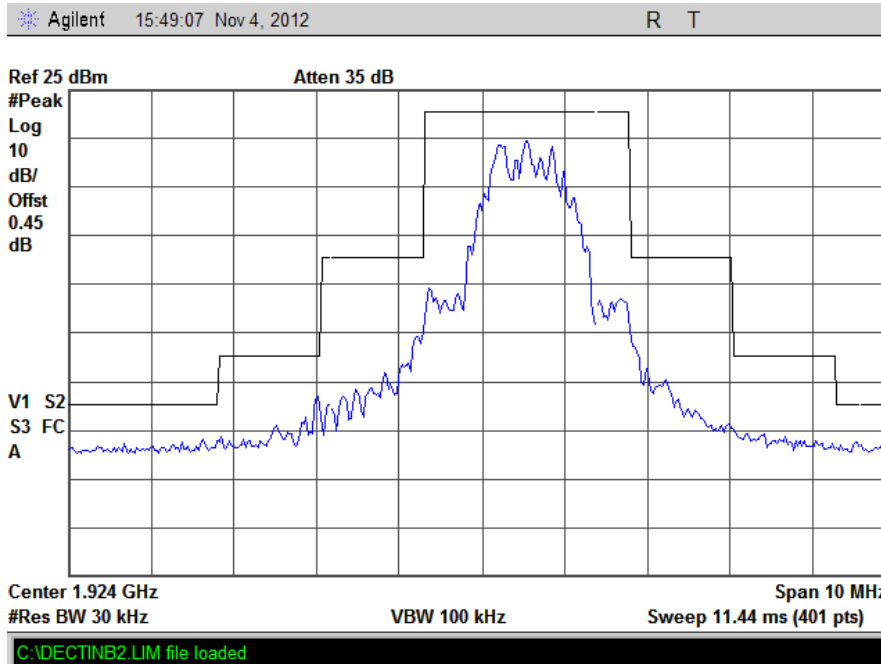

6.5.6 High Channel – In Band – ANT1

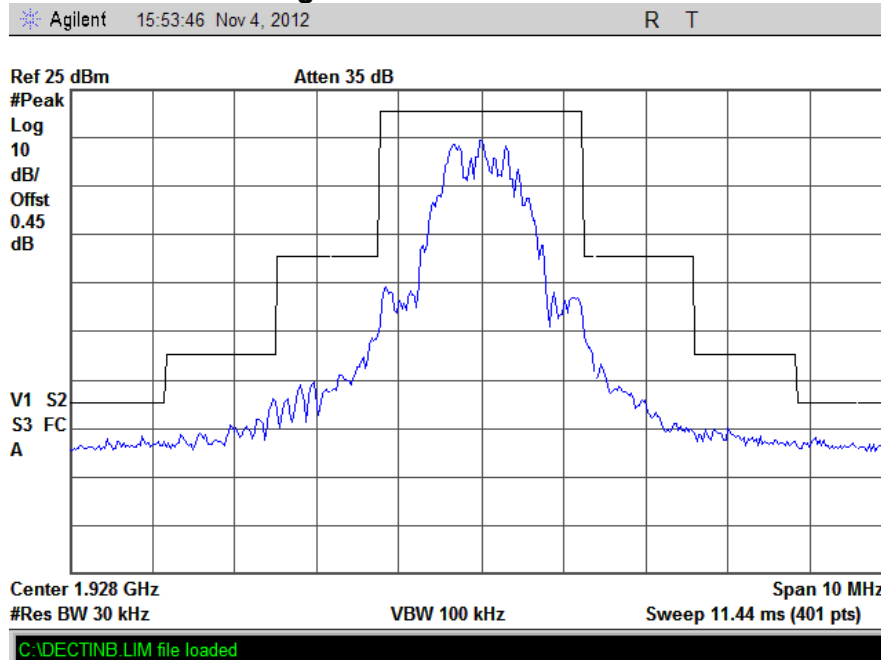

6. Measurement Data (continued)

6.5 Spurious Emissions at the antenna terminals (15.323 (d), RSS-213 6.7.1) (cont)

Requirement: Emissions outside the sub-band shall be attenuated below a reference power of 112 milliwatts as follows: 30 dB between the sub-band and 1.25 MHz above or below the sub-band; 50 dB between 1.25 and 2.5 MHz above or below the sub-band; and 60 dB at 2.5 MHz or greater above or below the sub-band.

Per ANSI C63.17-2006 Clause 6.1.6.2 the emissions in the region 2.5 MHz or greater above and below the limit can either meet the requirements outlined below **or** be made as a radiated emissions test and not exceed the limits of section 15.209.

Emissions outside the 1920-1930 MHz band shall be attenuated below a reference power of 112 milliwatts (-9.5 dBW) by at least:

- 30 dB between the band edges and 1.25 MHz above and below the band edges;
- 50 dB between 1.25 MHz and 2.5 MHz above or below the band edges; and
- 60 dB at 2.5 MHz or greater above or below the band edges.

Test Equipment Setup: EUT is configured to transmit a modulated signal in burst mode on the lowest, middle and highest channels. The EUT is connected to the spectrum analyzer via on board u.fl connector and adapter cable. The spectrum analyzer is configured with a 30 kHz RBW over the range of 30 MHz to 19.3 GHz, zooming in on the bandedges. Cable loss is accounted for within the analyzer. Using the mask defined above and allowing sufficient time for the analyzer's max hold function to capture any data associated with the device.

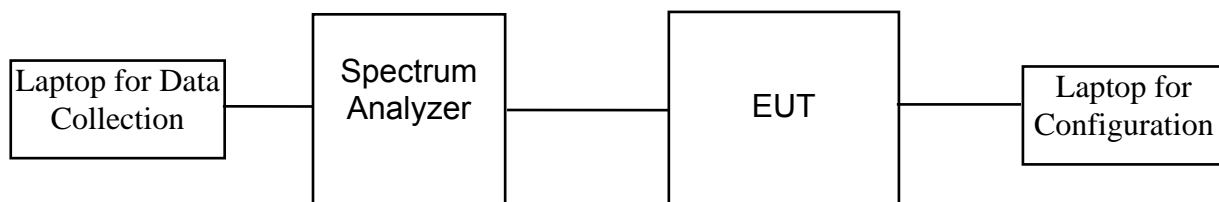

6. Measurement Data (continued)

6.5 Spurious Emissions at the antenna terminals (15.323 (d), RSS-213 6.7.1) (cont)

6.5.4 Low Channel – Out of Band 30 MHz – 1.915 GHz

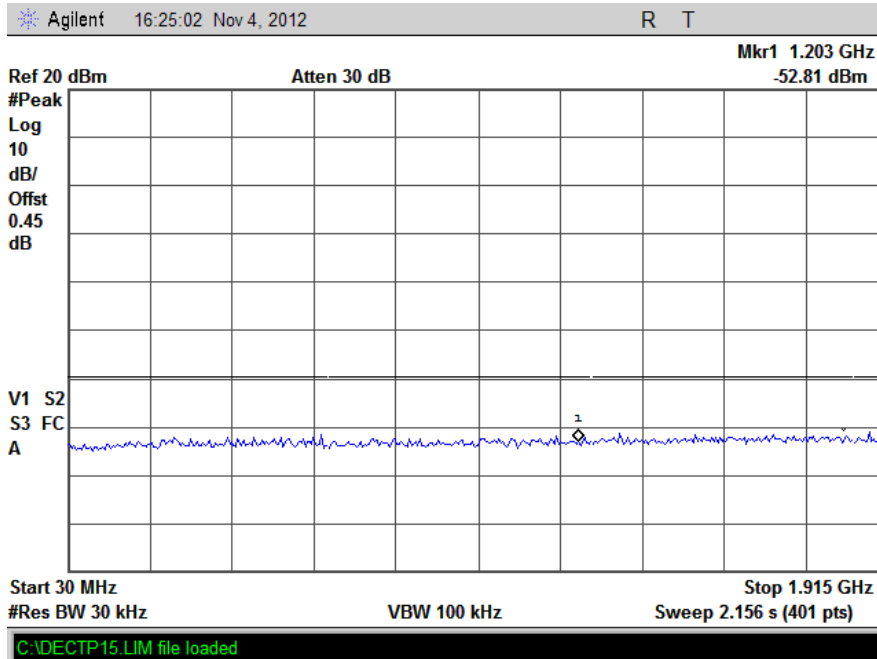

6.5.5 Low Channel – Out of Band 1.915 – 1.920 GHz

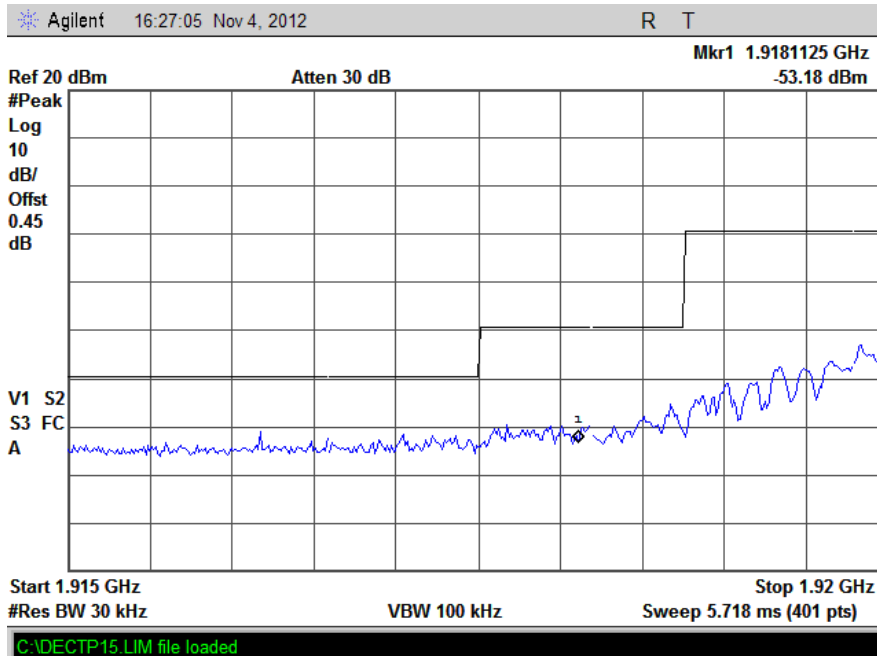

6. Measurement Data (continued)

6.5 Spurious Emissions at the antenna terminals (15.323 (d), RSS-213 6.7.1) (cont)

6.5.6 Low Channel Out of Band 1.930 – 1.935 GHz

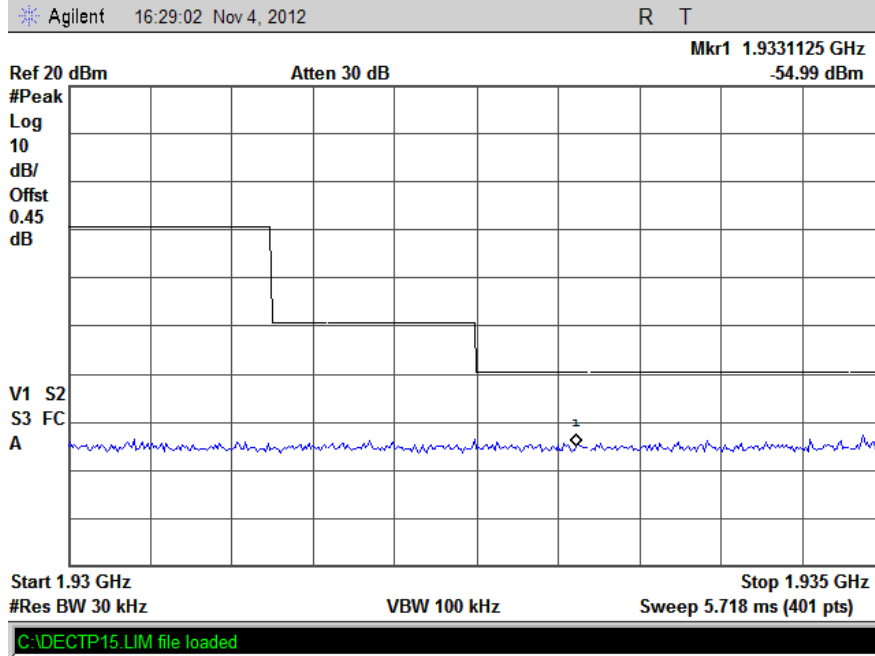

6.5.7 Low Channel Out of Band 1.935 – 19.3 GHz

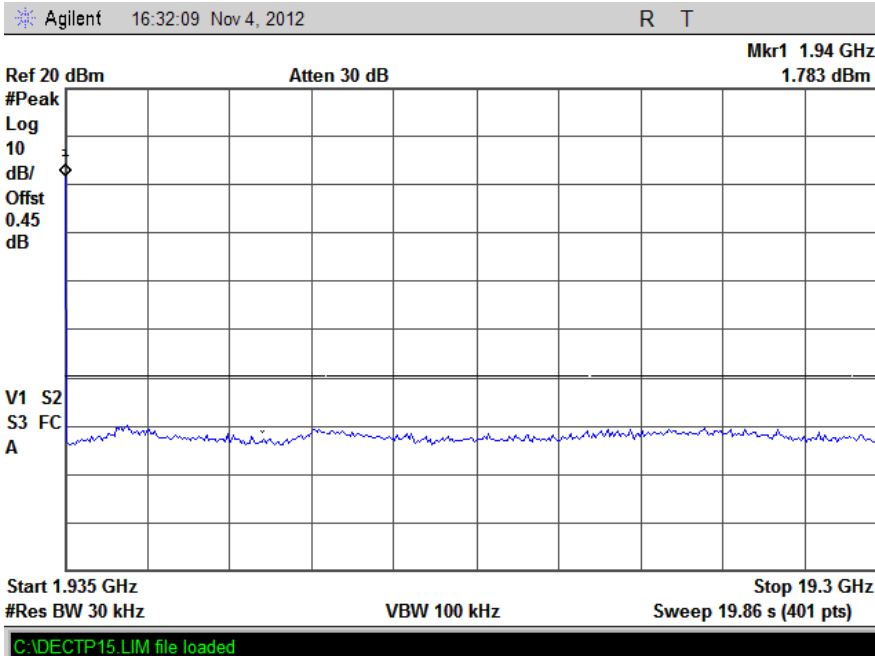

6. Measurement Data (continued)

6.5 Spurious Emissions at the antenna terminals (15.323 (d), RSS-213 6.7.1) (cont)

6.5.8 Mid Channel Out of Band 30 MHz – 1.915 GHz

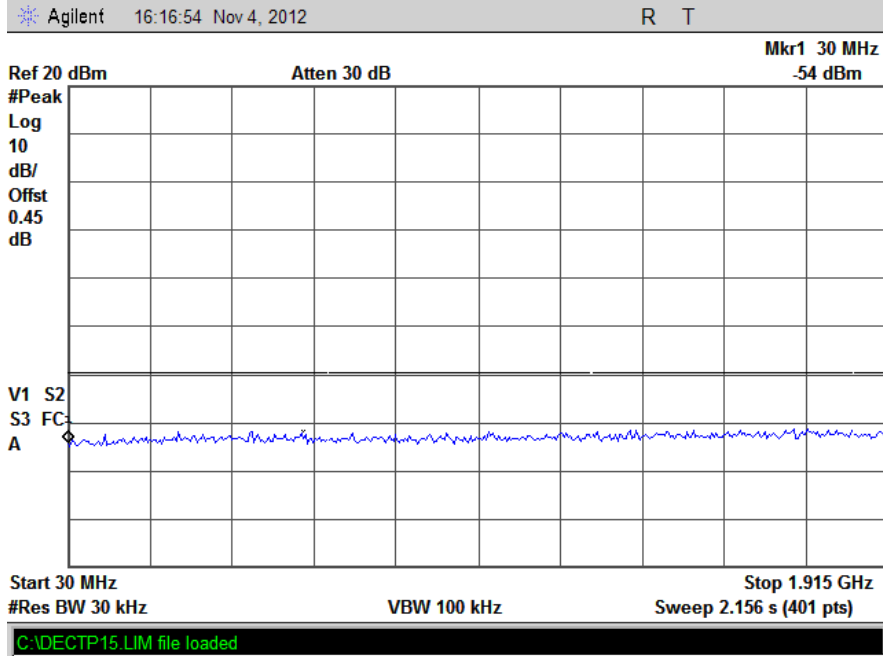

6.5.9 Mid Channel Out of Band 1.915 – 1.920 GHz

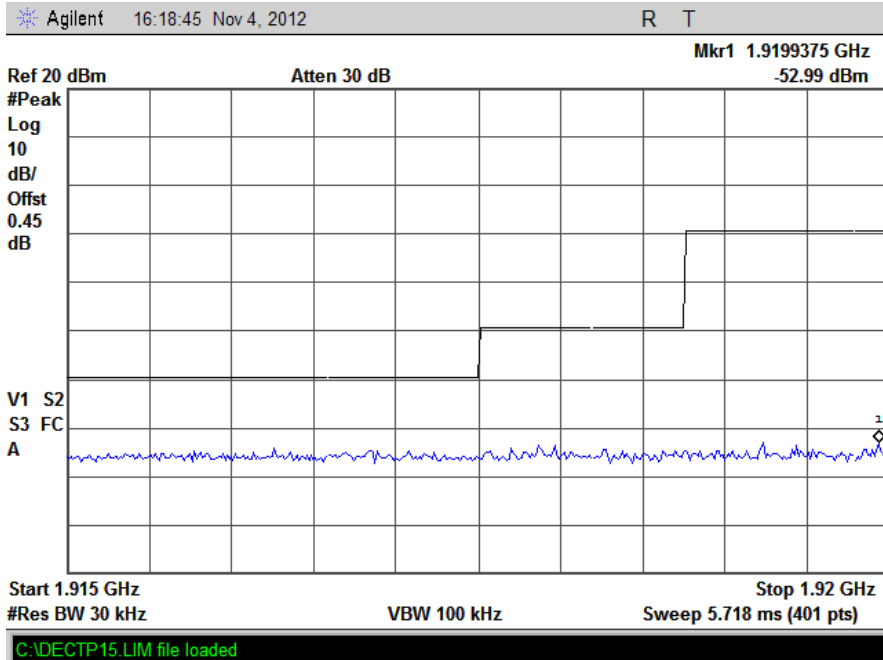

6. Measurement Data (continued)

6.5 Spurious Emissions at the antenna terminals (15.323 (d), RSS-213 6.7.1) (cont)

6.5.10 Mid Channel Out of Band 1.930 – 1.935 GHz

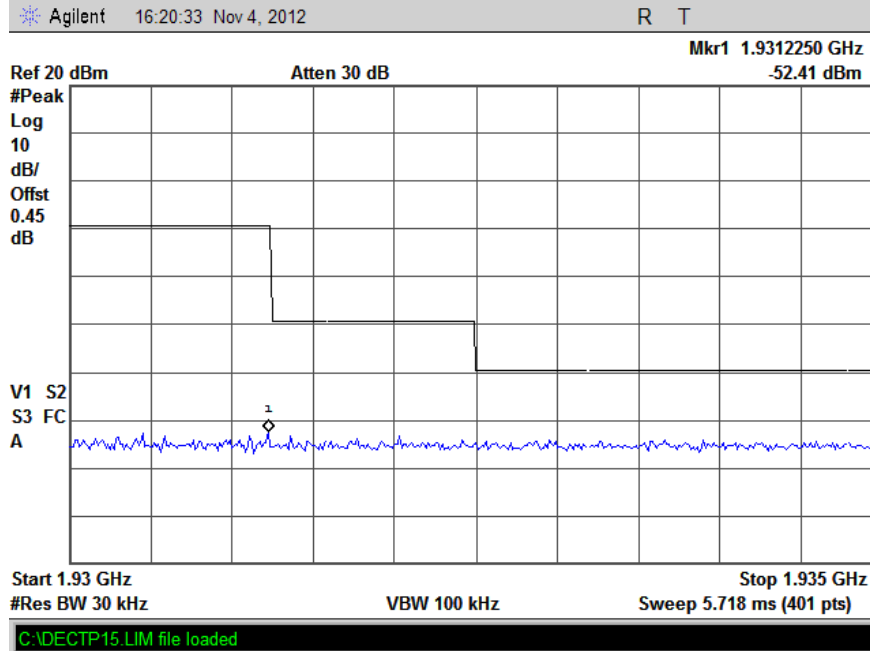

6.5.11 Mid Channel Out of Band 1.935 – 19.3 GHz

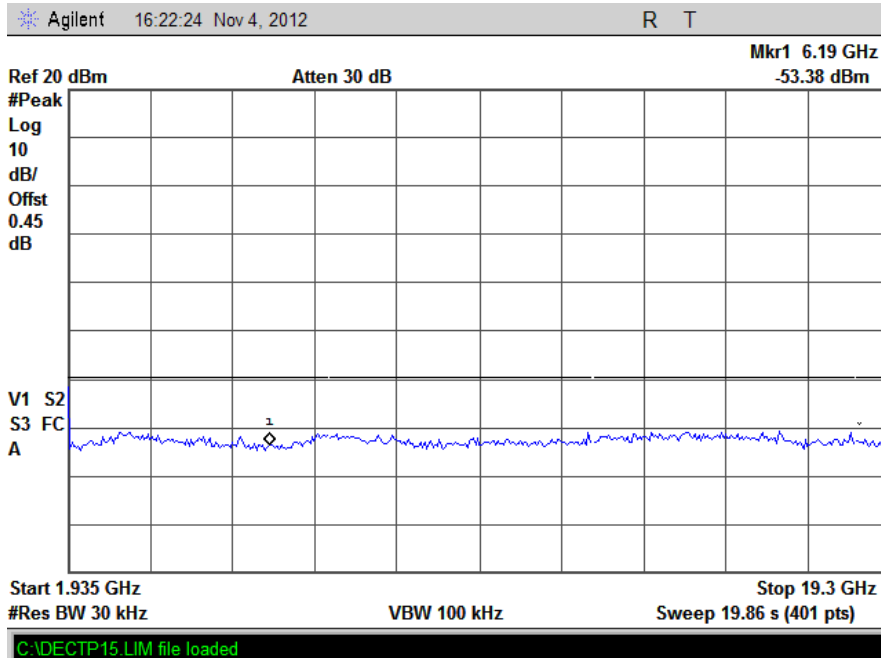

6. Measurement Data (continued)

6.5 Spurious Emissions at the antenna terminals (15.323 (d), RSS-213 6.7.1) (cont)

6.5.12 High Channel Out of Band 30 MHz – 1.915 GHz

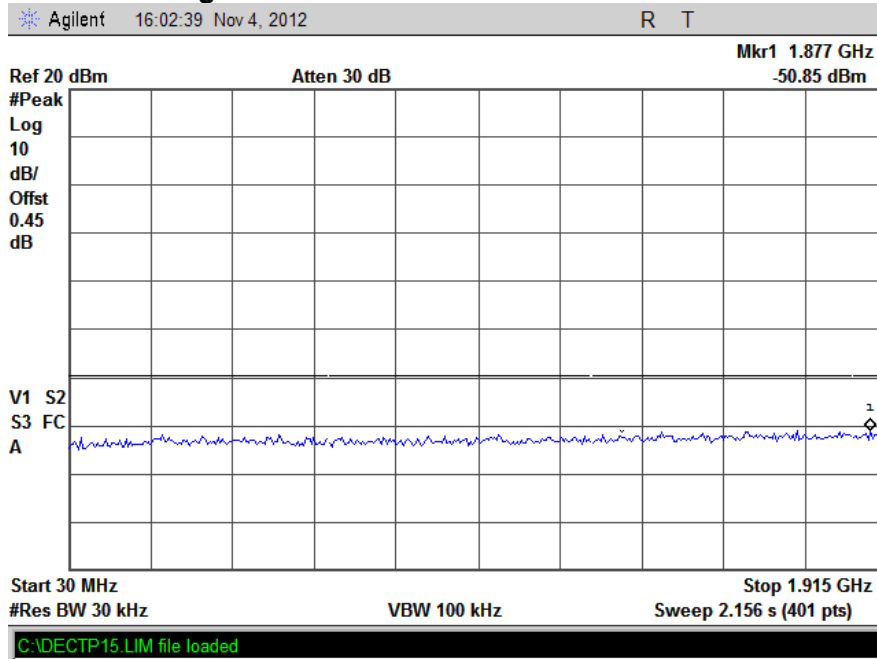

6.5.13 High Channel Out of Band 1.915 – 1.920 GHz

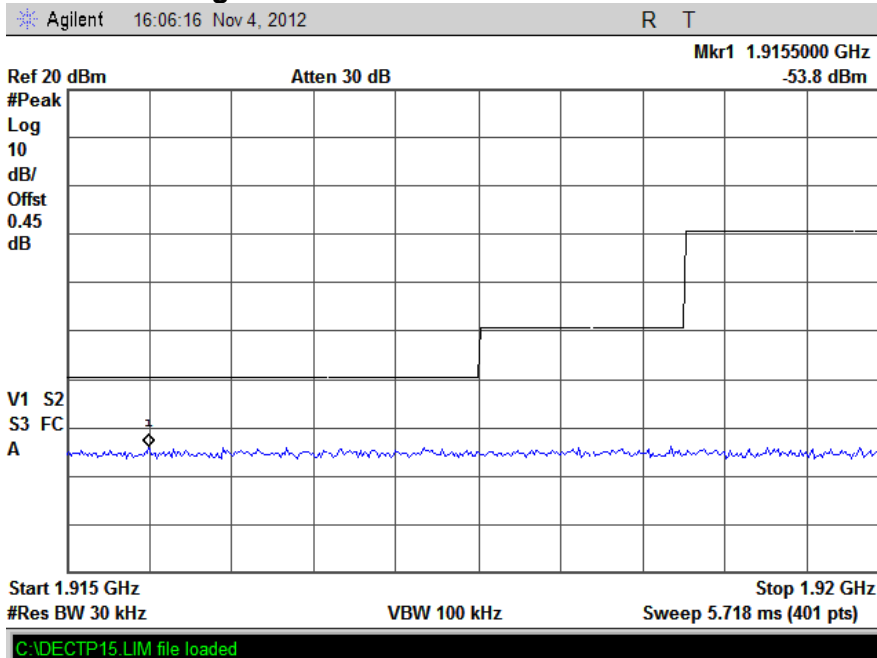

6. Measurement Data (continued)

6.5 Spurious Emissions at the antenna terminals (15.323 (d), RSS-213 6.7.1) (cont)

6.5.14 High Channel Out of Band 1.930 – 1.935 GHz

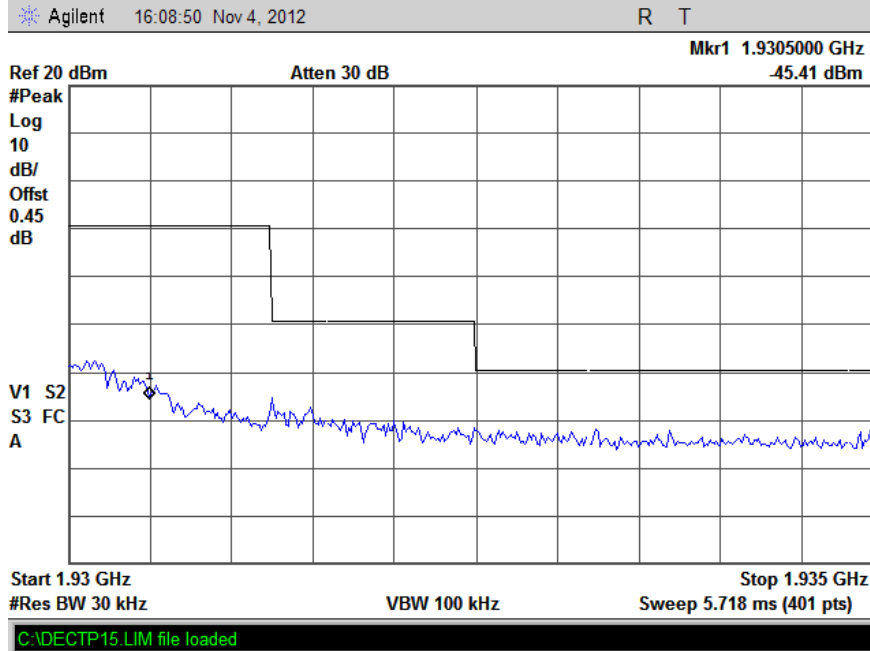

6.5.15 High Channel Out of Band 1.935 – 19.3 GHz

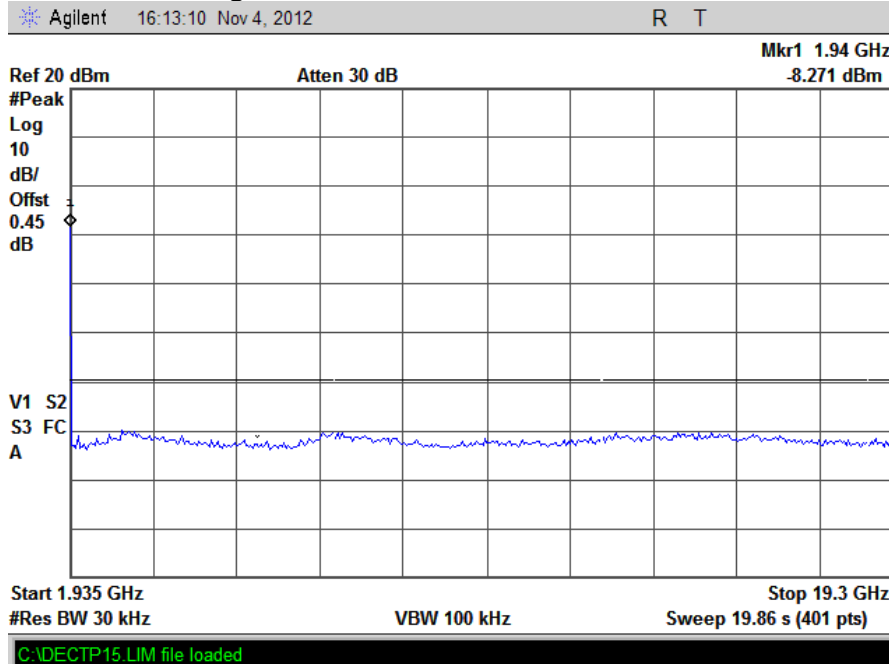

6. Measurement Data

6.6. Radiated Spurious Emissions (Harmonics)

Regulatory Limit: FCC Part 15.323(d), 15.209, IC RSS-213 6.7, RSS-GEN

Frequency Range (GHz)	Limits (dBµV/m)	
	Peak	Average
1.0 to 19.3	74	54

6.6.1. Measurement Equipment Used to Perform Test

Device	Manufacturer	Model No.	Serial No.	Cal Due
Horn Antenna 1-18	EMCO	3117	00143292	1/14/2015
Horn Antenna 18-40	Com Power	AH-840	03075	8/27/2014
Spectrum Analyzer	Agilent Tech	E7405A	MY45115430	5/11/2013
Preamplifier 2 – 50	Hewlett Packard	83050A	3331A00404	6/6/2013
2.5 GHz HP Filter	Micro-Tronics	HPM50110	070	06/25/2013
Manufacturer	Software Description		Title/Model #	Rev.
Compliance Worldwide	Test Report Generation Software		Test Report Generator	1.0

6.6.2. Measurement & Equipment Setup

Test Date: April 22nd, 23rd, 2013
 Test Engineer: Cody Merry
 Site Temperature (°C): 21.6
 Relative Humidity (%RH): 35
 Frequency Range: 1.0 GHz to 19.3 GHz
 EMI Receiver IF Bandwidth: 1 MHz
 EMI Receiver Avg Bandwidth: 3 MHz
 Detector Functions: Peak, Average

6.6.3. Test Procedure

Test measurements were made in accordance with ANSI C63.4-2003, Standard Methods of Measurement of Radio Noise Emissions from Low-Voltage Electrical and Electronics Equipment in the Range of 9 kHz to 40 GHz.

6. Measurement Data (continued)

6.6 Spurious Emissions for integral antennas (15.323 (d), 15.209, RSS-213 6.7.1) (cont)

Low Channel

Frequency (MHz)	Amplitude (dBµV/m)		Peak Limit	Peak Margin (dB)	Average Limit	Average Margin (dB)	Ant Pol	Ant Ht	TT Pos	Result
	Peak	Avg					H/V	cm	Deg	
3843	53.06	47.63	74	-20.94	54	-6.37	V	100	290	Compliant
5765	52.78	45.90	74	-21.22	54	-8.10	V	100	86	Compliant
7686	57.29	36.53	74	-16.71	54	-17.47	V	217	278	Compliant
9608	57.50	51.47	74	-16.50	54	-2.53	V	101	327	Compliant
11529	53.96	41.60	74	-20.04	54	-12.40	V	102	0	Compliant
13451	59.08	50.70	74	-14.92	54	-3.30	V	100	241	Compliant
15372	58.11	46.60	74	-15.89	54	-7.40	V	105	360	Compliant
17294	60.56	48.30	74	-13.44	54	-5.70	V	101	0	Compliant
19215	57.58	43.75	74	-16.42	54	-10.25	V	101	360	Compliant

Mid Channel

Frequency (MHz)	Amplitude (dBµV/m)		Peak Limit	Peak Margin (dB)	Average Limit	Average Margin (dB)	Ant Pol	Ant Ht	TT Pos	Result
	Peak	Avg					H/V	cm	Deg	
3850	53.89	49.60	74	-20.11	54	-4.40	V	100	328	Compliant
5775	52.47	46.30	74	-21.53	54	-7.70	V	102	88	Compliant
7700	56.74	36.74	74	-17.26	54	-17.26	V	149	278	Compliant
9625	58.20	53.20	74	-15.80	54	-0.80	V	115	247	Compliant
11550	53.40	41.60	74	-20.60	54	-12.40	V	102	0	Compliant
13475	58.85	49.95	74	-15.15	54	-4.05	V	113	248	Compliant
15400	58.49	46.53	74	-15.51	54	-7.47	V	103	0	Compliant
17325	60.40	48.18	74	-13.60	54	-5.82	V	108	360	Compliant
19250	56.80	44.00	74	-17.20	54	-10.00	V	101	360	Compliant

High Channel

Frequency (MHz)	Amplitude (dBµV/m)		Peak Limit	Peak Margin (dB)	Average Limit	Average Margin (dB)	Ant Pol	Ant Ht	TT Pos	Result
	Peak	Avg					H/V	cm	Deg	
3857	53.81	49.30	74	-20.19	54	-4.70	V	106	300	Compliant
5785	53.85	46.24	74	-20.15	54	-7.76	V	100	87	Compliant
7714	56.18	36.69	74	-17.82	54	-17.31	V	147	276	Compliant
9642	58.56	53.20	74	-15.44	54	-0.80	V	141	255	Compliant
11571	53.78	41.90	74	-20.22	54	-12.10	V	109	0	Compliant
13499	60.07	50.80	74	-13.93	54	-3.20	V	108	360	Compliant
15428	59.64	46.80	74	-14.36	54	-7.20	V	104	0	Compliant
17356	59.90	48.30	74	-14.10	54	-5.70	V	100	360	Compliant
19284	56.27	43.95	74	-17.73	54	-10.05	V	100	0	Compliant

¹ Correction factors are included in measurement values

6. Measurement Data (continued)

6.6 Spurious Emissions for integral antennas (15.323 (d), 15.209, RSS-213 6.7.1) (cont)

Low Channel

Frequency (MHz)	Amplitude (dBµV/m)		Peak Limit	Peak Margin (dB)	Average Limit	Average Margin (dB)	Ant Pol	Ant Ht	TT Pos	Result
	Peak	Avg					H/V	cm	Deg	
3843	52.09	46.56	74	-21.91	54	-7.44	H	204	323	Compliant
5765	53.43	46.93	74	-20.57	54	-7.07	H	114	67.1	Compliant
7686	56.09	36.50	74	-17.91	54	-17.50	H	117	318	Compliant
9608	56.05	47.74	74	-17.95	54	-6.26	H	114	345	Compliant
11529	53.11	41.70	74	-20.89	54	-12.30	H	105	0	Compliant
13451	59.11	49.45	74	-14.89	54	-4.55	H	101	153	Compliant
15372	61.33	46.80	74	-12.67	54	-7.20	H	112	360	Compliant
17294	61.19	48.87	74	-12.81	54	-5.13	H	108	360	Compliant
19215	57.60	43.80	74	-16.40	54	-10.20	H	101	360	Compliant

Mid Channel

Frequency (MHz)	Amplitude (dBµV/m)		Peak Limit	Peak Margin (dB)	Average Limit	Average Margin (dB)	Ant Pol	Ant Ht	TT Pos	Result
	Peak	Avg					H/V	cm	Deg	
3850	51.98	46.55	74	-22.02	54	-7.45	H	136	230	Compliant
5775	53.15	45.80	74	-20.85	54	-8.20	H	145	51	Compliant
7700	55.68	36.52	74	-18.32	54	-17.48	H	149	320	Compliant
9625	57.01	50.50	74	-16.99	54	-3.50	H	155	58	Compliant
11550	53.25	41.75	74	-20.75	54	-12.25	H	108	359	Compliant
13475	59.44	51.21	74	-14.56	54	-2.79	H	102	142	Compliant
15400	59.33	46.74	74	-14.67	54	-7.26	H	100	360	Compliant
17325	61.37	48.47	74	-12.63	54	-5.53	H	100	0	Compliant
19250	56.63	44.00	74	-17.37	54	-10.00	H	103	0	Compliant

High Channel

Frequency (MHz)	Amplitude (dBµV/m)		Peak Limit	Peak Margin (dB)	Average Limit	Average Margin (dB)	Ant Pol	Ant Ht	TT Pos	Result
	Peak	Avg					H/V	cm	Deg	
3857	52.36	46.00	74	-21.64	54	-8.00	H	197	321	Compliant
5785	53.82	46.40	74	-20.18	54	-7.60	H	169	106	Compliant
7714	56.02	36.61	74	-17.98	54	-17.39	H	181	310	Compliant
9642	58.22	52.48	74	-15.78	54	-1.52	H	194	315	Compliant
11571	53.64	41.90	74	-20.36	54	-12.10	H	105	0	Compliant
13499	59.60	50.91	74	-14.40	54	-3.09	H	104	142	Compliant
15428	59.10	46.90	74	-14.90	54	-7.10	H	100	360	Compliant
17356	60.57	48.50	74	-13.43	54	-5.50	H	104	0	Compliant
19284	56.55	44.00	74	-17.45	54	-10.00	H	100	353	Compliant

¹ Correction factors are included in measurement values

6. Measurement Data

6.7. Power Spectral Density (15.319 (d), RSS-213 Sec 6.6, ANSI C63.17 Sec 6.1.5)

Requirement: FCC: Power spectral density shall not exceed 3 milliwatts in any 3 kHz bandwidth as measured with a spectrum analyzer having a resolution bandwidth of 3 kHz.

IC: The peak-hold power spectral density shall not exceed 12 milliwatts per any 3 kHz bandwidth.

As an alternative to the peak-hold power spectral density, the time-averaged power spectral density may be measured and it shall not exceed 3 milliwatts per any 3 kHz bandwidth.

Test Equipment Setup: EUT is configured to transmit a modulated signal in burst mode on the lowest, middle and highest channels. The EUT is connected to the spectrum analyzer via on board u.fl connector and adapter cable. The spectrum analyzer is configured with a 3 kHz RBW and the maximum frequency over the bandwidth of the signal is determined. The analyzer is then placed in zero span at that frequency and a 100 averages using the sample detector is recorded. Cable loss is accounted for within the analyzer.

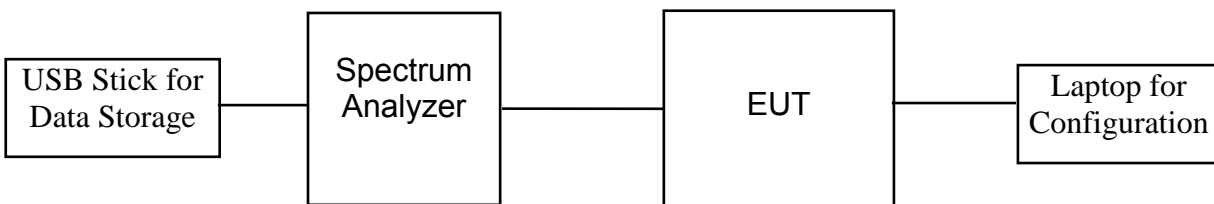

6. Measurement Data

6.7. Power Spectral Density (15.319 (d), RSS-213 Sec 6.6, ANSI C63.17 Sec 6.1.5)

6.7.1. Measurement Data – Average Power Spectral Density (PSD)

ANT0 Channel	Channel Frequency	Actual Measured Frequency	Power Spectral Density	Limit	Limit	Result
	MHz	MHz	dBm / 3kHz	dBm / 3kHz	mW / 3kHz	
TX4	1921.536	1921.536	-2.20	4.77	3.00	Compliant
TX2	1924.992	1924.992	-2.24	4.77	3.00	Compliant
TX0	1928.448	1928.448	-3.98	4.77	3.00	Compliant

ANT1 Channel	Channel Frequency	Actual Measured Frequency	Power Spectral Density	Limit	Limit	Result
	MHz	MHz	dBm / 3kHz	dBm / 3kHz	mW / 3kHz	
TX4	1921.536	1921.536	-1.30	4.77	3.00	Compliant
TX2	1924.992	1924.992	-1.21	4.77	3.00	Compliant
TX0	1928.448	1928.448	-0.89	4.77	3.00	Compliant

Note: Please see the next pages for plots of measurements

6. Measurement Data

6.7. Power Spectral Density (15.319 (d)), RSS-213 Sec 6.6 (cont)

6.7.2 Low Channel PSD – ANT0

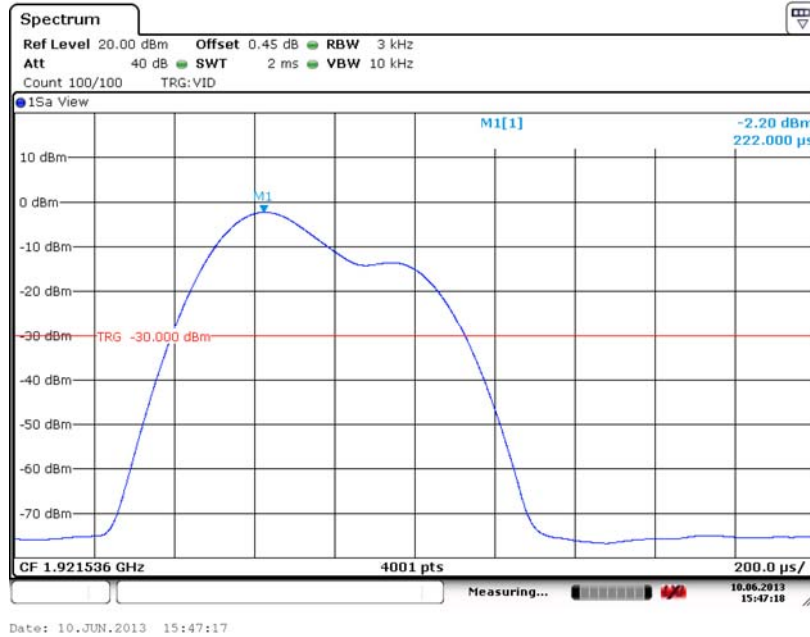

6.7.3 Mid Channel PSD – ANT0

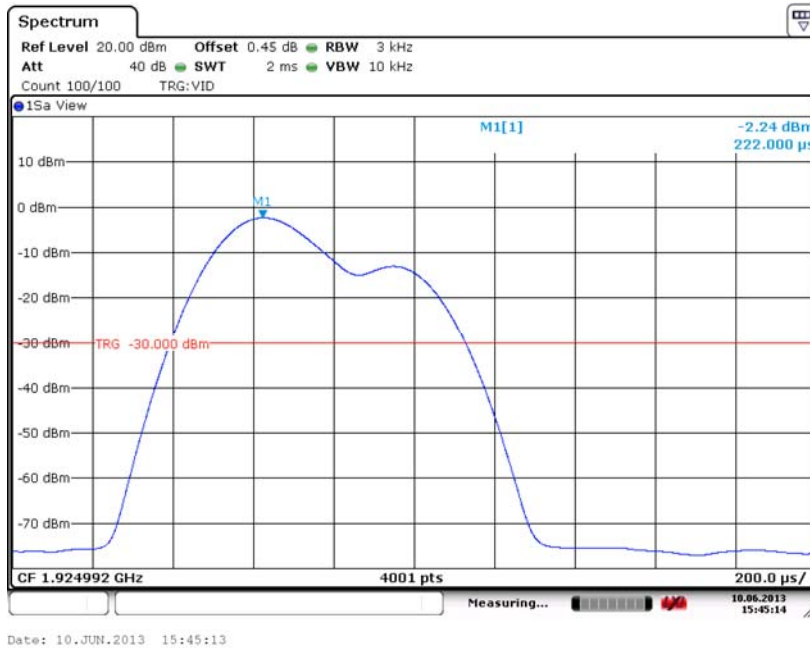

6. Measurement Data

6.7. Power Spectral Density (15.319 (d)), RSS-213 Sec 6.6 (cont)

6.7.4 High Channel PSD – ANT0



Date: 10.JUN.2013 15:18:24

6.7.5 Low Channel PSD – ANT1

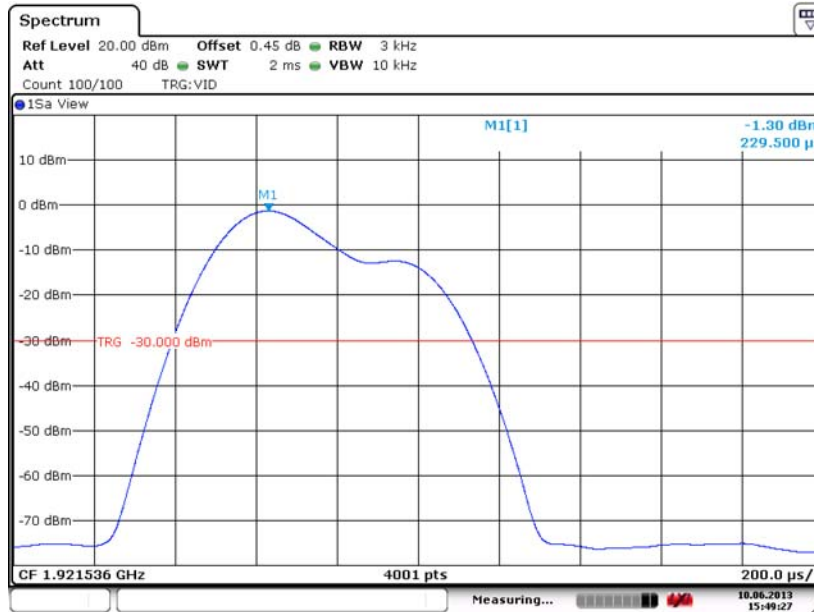

Date: 10.JUN.2013 15:49:26

6. Measurement Data

6.7. Power Spectral Density (15.319 (d)), RSS-213 Sec 6.6 (cont)

6.7.6 Mid Channel PSD – ANT1



Date: 10.JUN.2013 15:42:51

6.7.7 High Channel PSD – ANT1

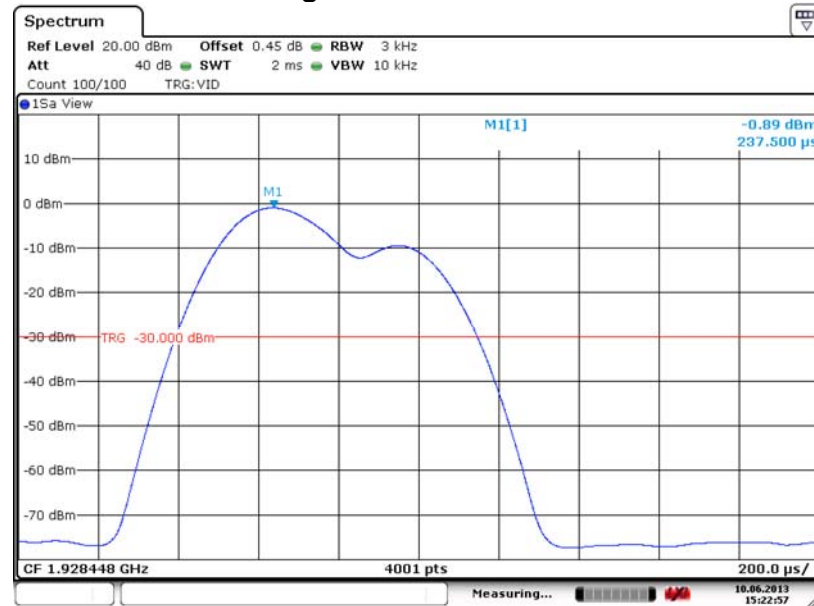

Date: 10.JUN.2013 15:22:56

6. Measurement Data

6.8. Conducted Emissions

Regulatory Limit: FCC Part 15.315, 15.207, IC RSS-213 6.3, RSS-GEN

Frequency Range (MHz)	Limits (dBµV)	
	Quasi-Peak	Average
0.15 to 0.50	66 to 56*	56 to 46*
0.50 to 5.0	56	46
5.0 to 30.0	60	50

* Decreases with the logarithm of the frequency.

6.8.1. Measurement Equipment Used to Perform Test

Device	Manufacturer	Model No.	Serial No.	Cal Due
LISN	EMCO	3825/2	9109-1860	7/2/2013
EMI Receiver	Hewlett Packard	8546A	3330A00115	6/13/2014
Manufacturer	Software Description		Title/Model #	Rev.
Compliance Worldwide	Test Report Generation Software		Test Report Generator	1.0

6.8.2. Measurement & Equipment Setup

Test Date: 06/7/2013
 Test Engineer: Cody Merry
 Site Temperature (°C): 21
 Relative Humidity (%RH): 37
 Frequency Range: 0.15 MHz to 30 MHz
 EMI Receiver IF Bandwidth: 9 kHz
 EMI Receiver Avg Bandwidth: 30 kHz
 Detector Functions: Peak, Quasi-Peak & Average

6.8.3. Test Procedure

Test measurements were made in accordance with ANSI C63.4-2003, Standard Methods of Measurement of Radio Noise Emissions from Low-Voltage Electrical and Electronics Equipment in the Range of 9 kHz to 40 GHz.

6. Measurement Data

6.8.4. 120 Volts, 60 Hz Phase

Test No.: 265-13, 120 Volts, 60 Hz Phase

FCC, Class B

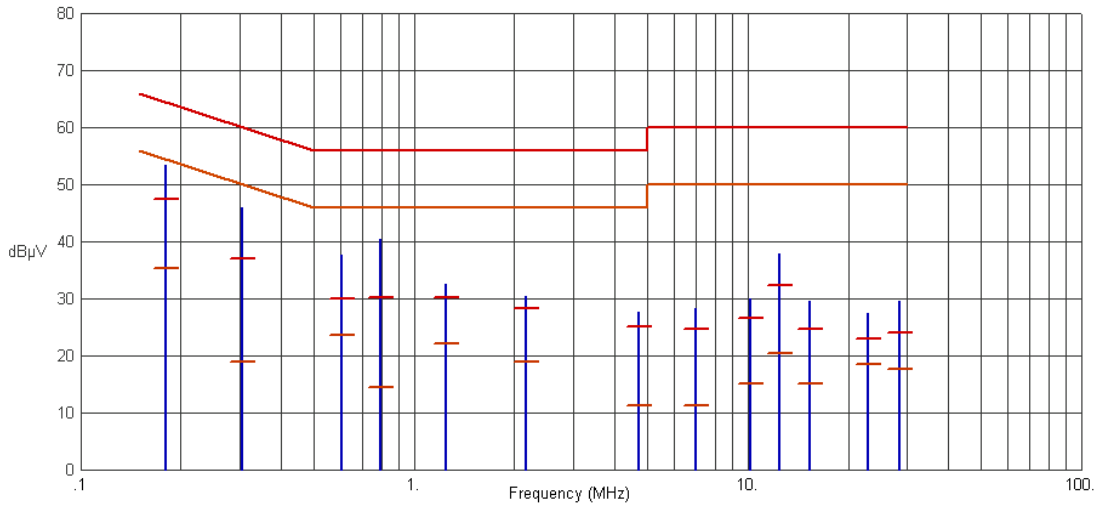

Frequency (MHz)	Pk Amp (dBµV)	QP Amp (dBµV)	QP Limit (dBµV)	QP Margin (dB)	Avg Amp (dBµV)	Avg Limit (dBµV)	Avg Margin (dB)	Comments
.1797	53.45	47.35	64.50	-17.15	35.35	54.50	-19.15	
.3047	45.92	36.94	60.11	-23.17	18.88	50.11	-31.23	
.6064	37.73	30.04	56.00	-25.96	23.59	46.00	-22.41	
.7968	40.32	30.19	56.00	-25.81	14.42	46.00	-31.58	
1.2507	32.47	30.23	56.00	-25.77	22.13	46.00	-23.87	
2.1655	30.43	28.35	56.00	-27.65	18.86	46.00	-27.14	
4.7325	27.71	25.12	56.00	-30.88	11.19	46.00	-34.81	
7.0124	28.28	24.55	60.00	-35.45	11.19	50.00	-38.81	
10.1761	29.86	26.52	60.00	-33.48	15.04	50.00	-34.96	
12.5129	37.95	32.26	60.00	-27.74	20.45	50.00	-29.55	
15.3486	29.54	24.65	60.00	-35.35	15.05	50.00	-34.95	
22.9024	27.40	22.91	60.00	-37.09	18.49	50.00	-31.51	
28.6521	29.48	23.95	60.00	-36.05	17.70	50.00	-32.30	

6. Measurement Data

6.8.5. 120 Volts, 60 Hz Neutral

Test No.: 265-13, 120 Volts, 60 Hz Neutral

FCC, Class B

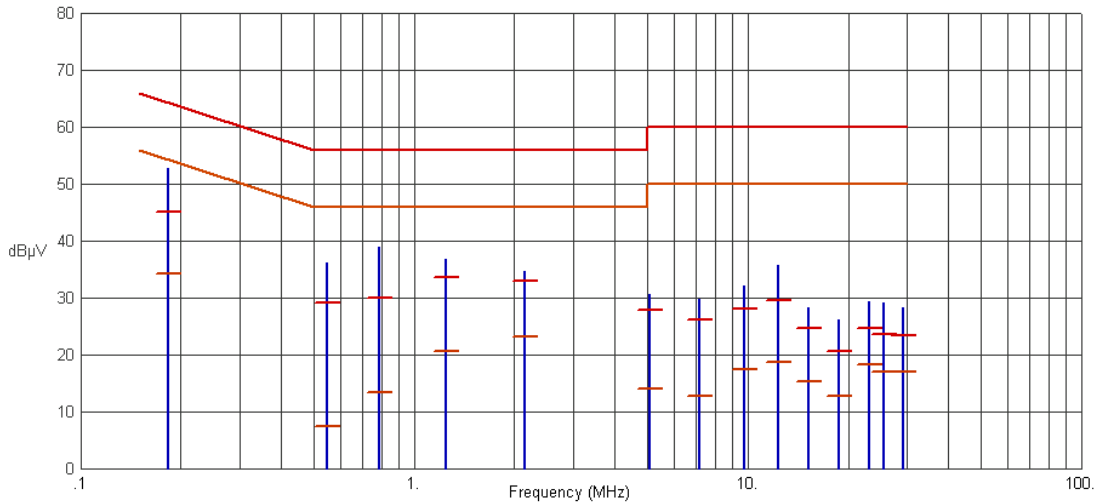

Frequency (MHz)	Pk Amp (dBµV)	QP Amp (dBµV)	QP Limit (dBµV)	QP Margin (dB)	Avg Amp (dBµV)	Avg Limit (dBµV)	Avg Margin (dB)	Comments
.1841	52.74	45.01	64.30	-19.29	34.26	54.30	-20.04	
.5508	36.15	29.15	56.00	-26.85	7.38	46.00	-38.62	
.7896	38.95	29.86	56.00	-26.14	13.41	46.00	-32.59	
1.2482	36.79	33.57	56.00	-22.43	20.63	46.00	-25.37	
2.1419	34.68	33.05	56.00	-22.95	23.15	46.00	-22.85	
5.0719	30.61	27.80	60.00	-32.20	13.87	50.00	-36.13	
7.1839	29.79	26.03	60.00	-33.97	12.69	50.00	-37.31	
9.7458	32.07	28.10	60.00	-31.90	17.45	50.00	-32.55	
12.3752	35.79	29.60	60.00	-30.40	18.75	50.00	-31.25	
15.2609	28.27	24.73	60.00	-35.27	15.21	50.00	-34.79	
18.8246	26.20	20.54	60.00	-39.46	12.70	50.00	-37.30	
23.1692	29.32	24.63	60.00	-35.37	18.19	50.00	-31.81	
25.5420	29.11	23.55	60.00	-36.45	16.97	50.00	-33.03	
29.1997	28.21	23.32	60.00	-36.68	16.97	50.00	-33.03	

6. Measurement Data (continued)

6.9 Carrier Frequency Stability (15.323 (f), IC RSS-213 6.2, ANSI C63.17 Sec 6.2.1)

Requirement: The frequency stability of the carrier frequency of the intentional radiator shall be maintained within 10 ppm over 1 hour or the interval between channel access monitoring, whichever is shorter. This translates to a frequency drift of 19.2 kHz for a 1920 MHz carrier.

The frequency stability shall be maintained over a temperature variation of -20° to +50 °C at normal supply voltage, and over a variation in the primary supply voltage of 85 percent to 115 percent of the rated supply voltage at a temperature of 20 °C. For equipment that is capable only of operating from a battery, the frequency stability tests shall be performed using a new battery without any further requirement to vary supply voltage.

Test Equipment Setup: EUT is connected to the CTS65 test set using a special operational mode of the EUT (TBR6 mode) on one of the channels (frequencies). The RF Modulation function of the test set is used for this measurement. The test set is configured to perform the measurement over 100 bursts (approximate frame period x 100). The frequency offset measured in kHz is compared against the equivalent of 10 ppm or 19.2 kHz.

The measurement is performed over 1 hour and a laptop is used to capture the data approximately once per second from the test set via its serial port. The peak to peak difference was recorded and the mean value and deviation in kHz (ppm) calculated.

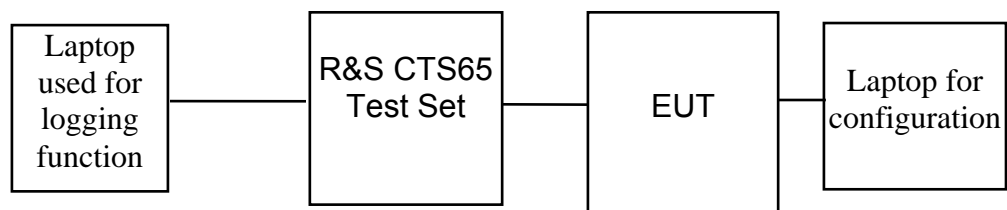

6. Measurement Data (continued)

6.9 Carrier Frequency Stability (15.323 (f), IC RSS-213 6.2, ANSI C63.17 Sec 6.2.1) cont.

Channel	Channel Frequency	Voltage	Temperature	Measured Frequency Offset	Limit (+/-)	Limit (+/-)	Result
	MHz	VAC	Degrees C	kHz	kHz	ppm	
TX0	1928.448	120.00	20	+6.00	19.2	10.0	Compliant
TX0	1928.448	102.00	20	+6.00	19.2	10.0	Compliant
TX0	1928.448	138.00	20	+6.00	19.2	10.0	Compliant
TX0	1928.448	120.00	-20	+1.00	19.2	10.0	Compliant
TX0	1928.448	120.00	+50	+3.00	19.2	10.0	Compliant

6.9.1 Timing 120 VAC, 20 degrees C

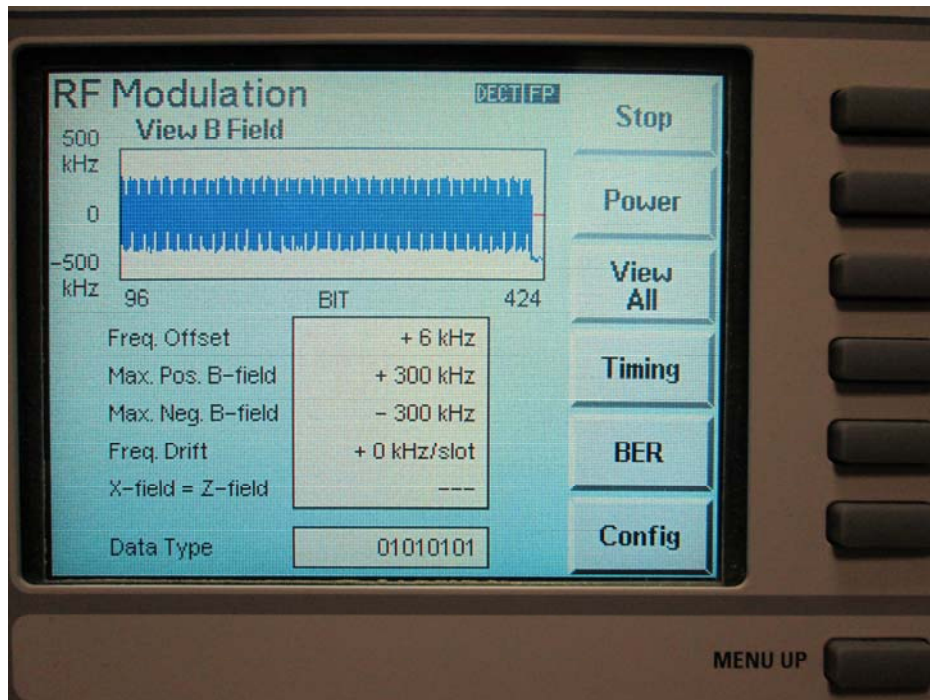

6. Measurement Data (continued)

6.10 Transmitter Spurious Radiated Emissions (FCC Part 15.209, RSS 213 6.7)

6.10.1. Regulatory Limit: FCC Part 15.209, IC RSS-GEN, Class B, Quasi-Peak

Frequency Range (MHz)	Distance (Meters)	Limit (dBµV/m)
0.009 to 0.490	3	128.5 to 93.8
0.490 to 1.705	3	73.8 to 63.0
1.705 to 30	3	69.5
30 to 88	3	40.0
88 to 216	3	43.5
216 to 960	3	46.0
960 to 1000	3	54.0

6.10.2. Measurement Equipment Used to Perform Test

Device	Manufacturer	Model No.	Serial No.	Cal Due
Loop Antenna	EMCO	6512	9309-1139	8/28/2014
Biconilog Antenna	Com-Power	AC220	25509	8/20/2013
EMI Receiver	Hewlett Packard	8546A	3330A00115	6/13/2014

6.10.3. Measurement & Equipment Setup

Test Date: 6/7/2013, 6/10/2013
 Test Engineer: Cody Merry
 Site Temperature (°C): 21
 Relative Humidity (%RH): 37
 Frequency Range: 150 kHz to 1 GHz
 Measurement Distance: 3 Meters
 EMI Receiver IF Bandwidth: 9 kHz, 120 kHz
 EMI Receiver Avg Bandwidth: 30 kHz, 300 kHz
 Detector Functions: Peak and Quasi-Peak.
 Antenna Height: 1 to 4 meters

6.10.4. Test Procedure

Test measurements were made in accordance with ANSI C63.4-2003, Standard Methods of Measurement of Radio Noise Emissions from Low-Voltage Electrical and Electronics Equipment in the Range of 9 kHz to 40 GHz.

6. Measurement Data (continued)

6.10. Radiated Emissions (12 MHz to 30 MHz) Test Results

6.10.5. Antenna Parallel to the Device Under Test



265-13 ARRIS MQ2402 PARALLEL

ACTV DET: PEAK
MEAS DET: PEAK
MKR 14.07 MHz
38.30 dBμV

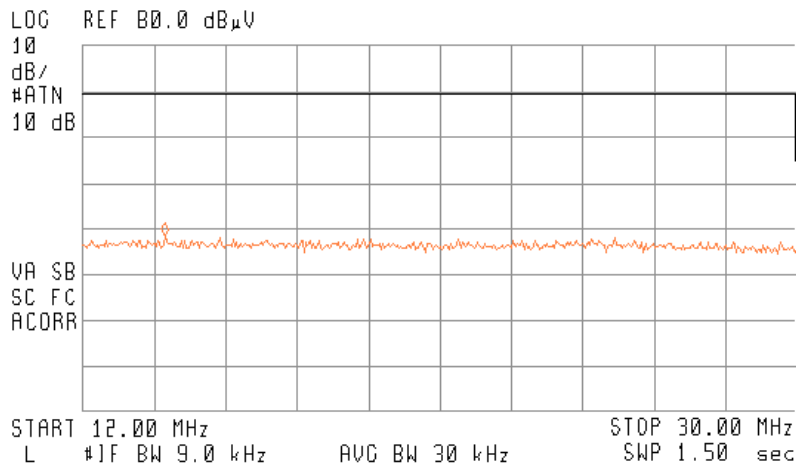

6.10.6. Antenna Perpendicular to the Device Under Test



265-13 ARRIS MQ2402 PERPENDICULAR

ACTV DET: PEAK
MEAS DET: PEAK
MKR 12.54 MHz
39.15 dBμV

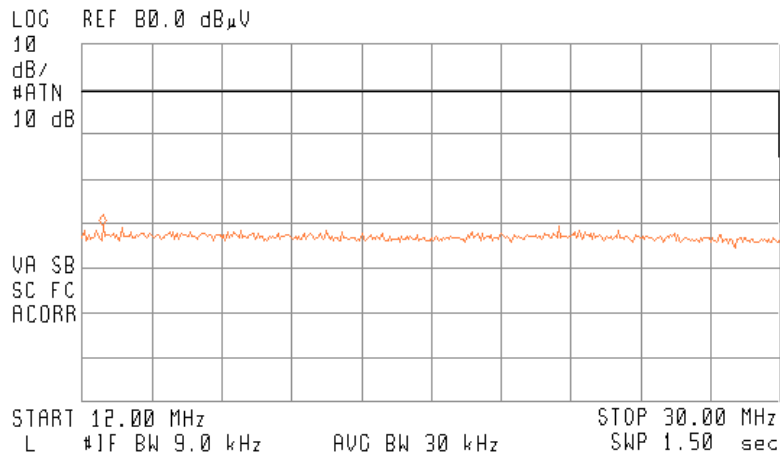

6. Measurement Data (continued)

6.10. Radiated Emissions (30 MHz to 1 GHz) Test Results

6.10.7. Horizontal Polarity

Test No.: 265-13, Radiated Emissions - Horizontal Polarity

FCC, Class B

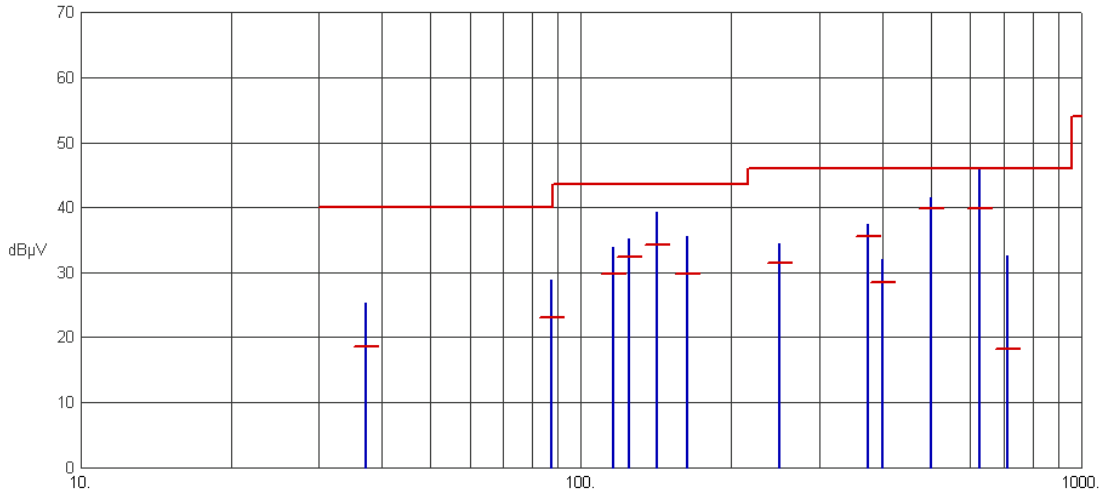

Frequency (MHz)	Pk Amp (dBµV/m)	QP Amp (dBµV/m)	QP Limit (dBµV/m)	Margin (dB)	Ant Ht (cm)	Table (Deg)	Comments
37.1977	25.35	18.55	40.00	-21.45	N/A	N/A	
87.4518	28.83	23.08	40.00	-16.92	N/A	N/A	
116.1875	33.94	29.74	43.50	-13.76	N/A	N/A	
124.9797	35.22	32.33	43.50	-11.17	N/A	N/A	
142.3726	39.34	34.29	43.50	-9.21	N/A	N/A	
163.3096	35.60	29.81	43.50	-13.69	N/A	N/A	
249.9950	34.35	31.52	46.00	-14.48	N/A	N/A	
374.9881	37.41	35.54	46.00	-10.46	N/A	N/A	
399.9931	32.03	28.47	46.00	-17.53	N/A	N/A	
499.9979	41.45	39.79	46.00	-6.21	N/A	N/A	
624.9822	45.84	39.91	46.00	-6.09	N/A	N/A	
710.6422	32.51	18.27	46.00	-27.73	N/A	N/A	

6. Measurement Data (continued)

6.10 Radiated Emissions (30 MHz to 1 GHz) Test Results (continued)

6.10.8. Vertical Polarity

Test No.: 265-13, Radiated Emissions - Vertical Polarity

FCC, Class B

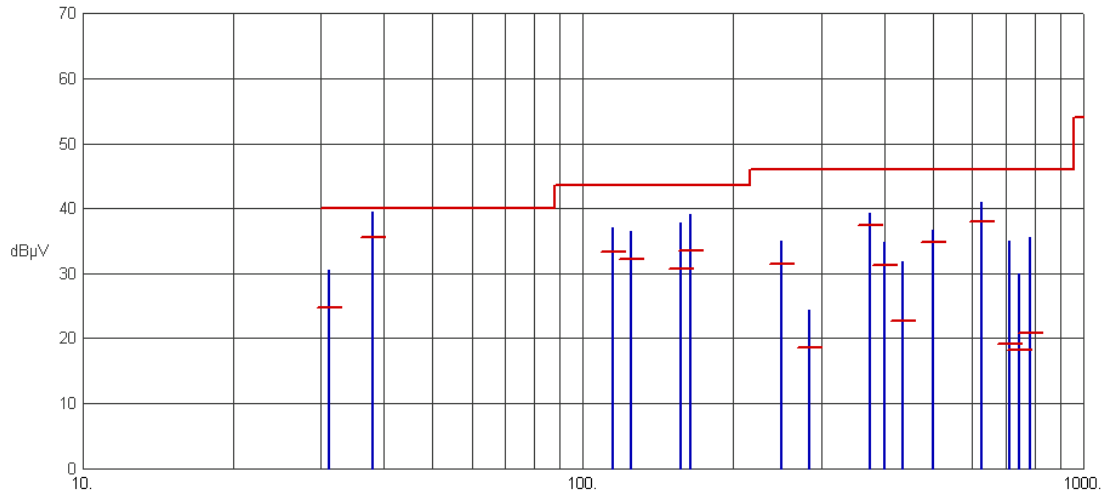

Frequency (MHz)	Pk Amp (dBµV/m)	QP Amp (dBµV/m)	QP Limit (dBµV/m)	Margin (dB)	Ant Ht (cm)	Table (Deg)	Comments
31.1547	30.58	24.74	40.00	-15.26	N/A	N/A	
37.9679	39.40	35.49	40.00	-4.51	N/A	N/A	
115.0877	37.12	33.36	43.50	-10.14	N/A	N/A	
124.9868	36.43	32.23	43.50	-11.27	N/A	N/A	
157.3802	37.83	30.76	43.50	-12.74	N/A	N/A	
163.7327	39.09	33.53	43.50	-9.97	N/A	N/A	
249.9959	35.03	31.40	46.00	-14.60	N/A	N/A	
283.5072	24.29	18.50	46.00	-27.50	N/A	N/A	
374.9921	39.28	37.32	46.00	-8.68	N/A	N/A	
400.0082	34.86	31.32	46.00	-14.68	N/A	N/A	
436.3264	31.81	22.62	46.00	-23.38	N/A	N/A	
499.9860	36.75	34.73	46.00	-11.27	N/A	N/A	
624.9862	40.93	37.98	46.00	-8.02	N/A	N/A	
713.7266	35.00	19.18	46.00	-26.82	N/A	N/A	
745.3087	29.92	18.22	46.00	-27.78	N/A	N/A	
785.0416	35.50	20.74	46.00	-25.26	N/A	N/A	

6.10.9. Above 1 GHz

Note: There were not measurable emissions above 1 GHz other than the harmonics documented in Section 6.6.

6. Measurement Data (continued)

6.11 Specific Requirements to UPCS Devices (15.323 (e), RSS-213 4.3.4 (c), ANSI C63.17 Section 6.2.2 Frame Repetition-Stability and ANSI C63.17 Section 6.2.3 Frame Period and Jitter)

Requirement: The frame period (a set of consecutive time slots in which the position of each time slot can be identified by reference to a synchronizing source) of an intentional radiator operating in this sub-band shall be 20 milliseconds/X where X is a positive whole number.

Each device that implements time division for the purpose of maintaining a duplex connection on a given frequency carrier shall maintain a frame repetition rate with a frequency stability of at least 50 parts per millions (ppm). Each device which further divides access in time in order to support multiple communication links on a given frequency carrier shall maintain a frame repetition rate with a frequency stability of at least 10 ppm.

The jitter (time-related, abrupt, spurious variations in the duration of the frame interval) introduced at the two ends of such a communication link shall not exceed 25 microseconds for any two consecutive transmissions.

The Frame Repetition Stability which is measured is 3 times the standard deviation.

Test Equipment Setup: EUT is connected to the CTS65 test set using a special operational mode of the EUT (TBR6 mode) on one of the channels (frequencies). The CTS65 test set serves as the companion device for the EUT. The Timing function of the test set is used for this measurement. The test set is configured to perform the measurement over 1000 bursts. The data is captured approximately once every 10 seconds via the laptop for 1000 seconds.

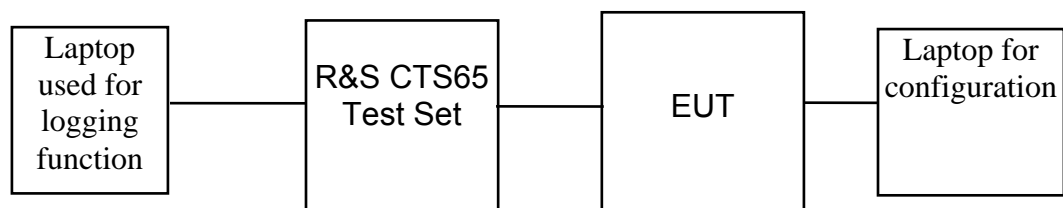

6. Measurement Data (continued)

6.11 Specific Requirements to UPCS Devices (15.323 (e), RSS-213 4.3.4 (c), ANSI C63.17 Section 6.2.2 Frame Repetition-Stability and ANSI C63.17 Section 6.2.3 Frame Period and Jitter) (cont)

Frame Repetition Stability (ppm)	Limit (ppm)	Standard Deviation (ppm)	Result
0.45	10.00	0.15	Compliant

Maximum Positive Jitter (µS)	Maximum Negative Jitter (µS)	Frame Period (mS)	3xStandard Deviation of Jitter (µS)	Limit	Result
0.00	-0.00	10.000	0.000	25 µS	Compliant

6.11.1 Time Accuracy & Maximum Jitter (cont)

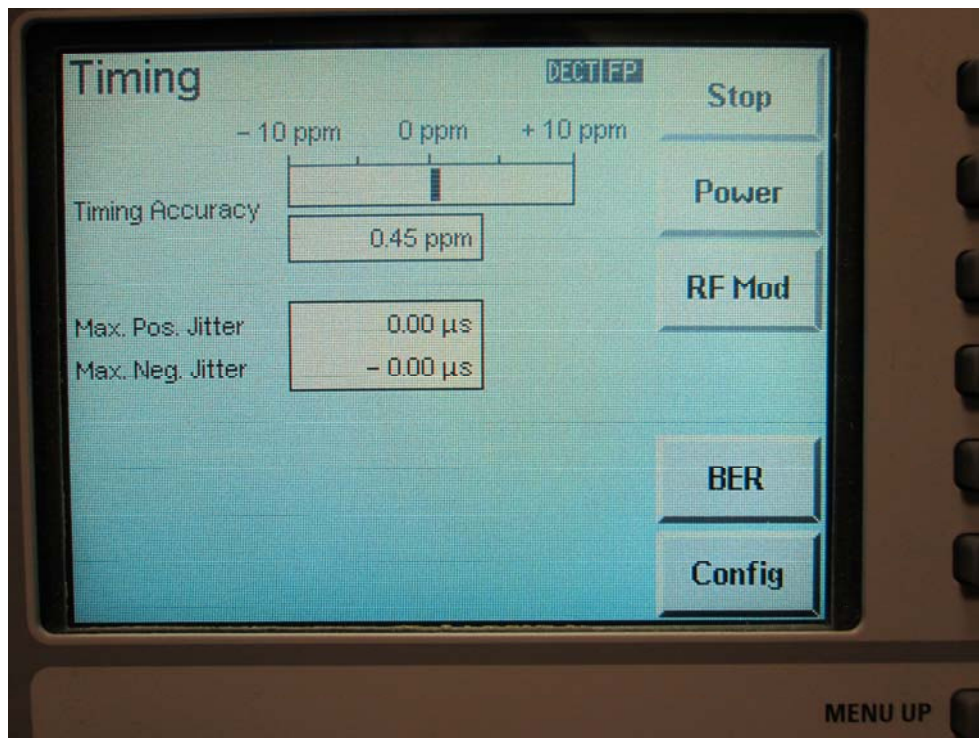

Note: The tester is configured for 1000 bursts of analysis (its maximum) and then monitored for a minimum of 1000 seconds recording the maximum and minimum values of jitter to satisfy the measurement requirement over 100,000 frames.

6. Measurement Data (continued)

6.11 Specific Requirements to UPCS Devices (15.323 (e), RSS-213 4.3.4) (cont)

6.11.2 Automatic Discontinuation of Transmission (15.319 (f), RSS-213 4.3.4 (a))

Requirement: Devices shall automatically discontinue transmission in case of either absence of information to transmit or operational failure. This is not intended to preclude transmission of control and signaling information or use of repetitive codes used by certain digital technologies to complete frame or burst intervals.

Result: Compliant

Evaluation	Result
Test according to a)	Compliant
Assessment of manufacturer declaration	-- --

a) The tests are done after establishment of a connection to counter part.

	Test case	Reaction of EUT	Result
1	Switch – off counterpart	B	Compliant
2	Hook-on by counterpart	--	--
3	Switch- off by EUT	A	Compliant
4	Hook -on on EUT side	--	--
5	Remove power from EUT	A	Compliant
6	Remove power from counterpart	B	Compliant

A – Connection break down, cease of transmit

B – Connection break down, EUT transmits signaling information

C – Connection break down, counter part transmits signaling information

6. Measurement Data (continued)

6.11 Specific Requirements to UPCS Devices (cont)

6.11.3 Monitoring Time (15.323(c) (1), RSS-213 4.3.4 (b) (1), ANSI C63.17 Sec 7.3.4

Requirement: Devices must incorporate a mechanism for monitoring the time and spectrum windows that their transmission is intended to occupy. The following criteria must be met:

Immediately prior to initiating a transmission, devices must monitor the combined time and spectrum window, which they intend to use, to verify if the channel is free, for at least 10 milliseconds for systems designed to use a 10 ms or shorter frame period, or at least 20 ms for systems designed to use a 20 ms frame period.

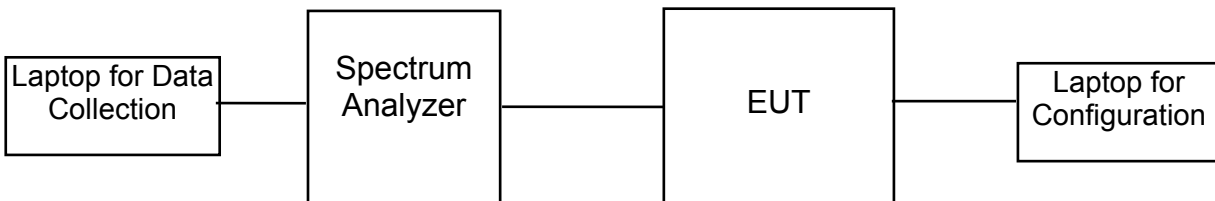

6.11.3.1 Measurement of Frame Period

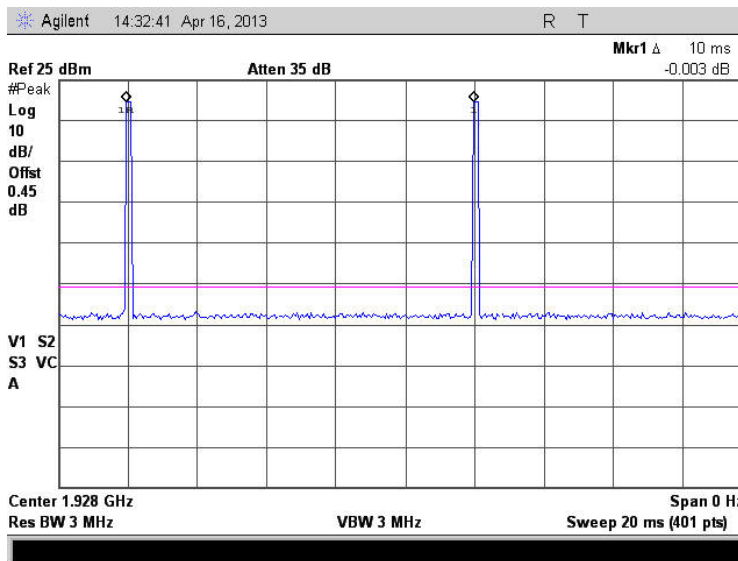

Result: Compliant, plot is used to demonstrate this is a 10 mS or shorter system. This requirement is covered by the results of the LIC test performed in Section 6.11.7 of this report.

6. Measurement Data (continued)

6.11 Specific Requirements to UPCS Devices (cont)

6.11.3 Monitoring Time (15.323(c) (1), RSS-213 4.3.4 (b) (1), C63.17 Sec 7.3.4 (cont)

6.11.3.2 Measurement of Nominal Burst Length (Frame Width)

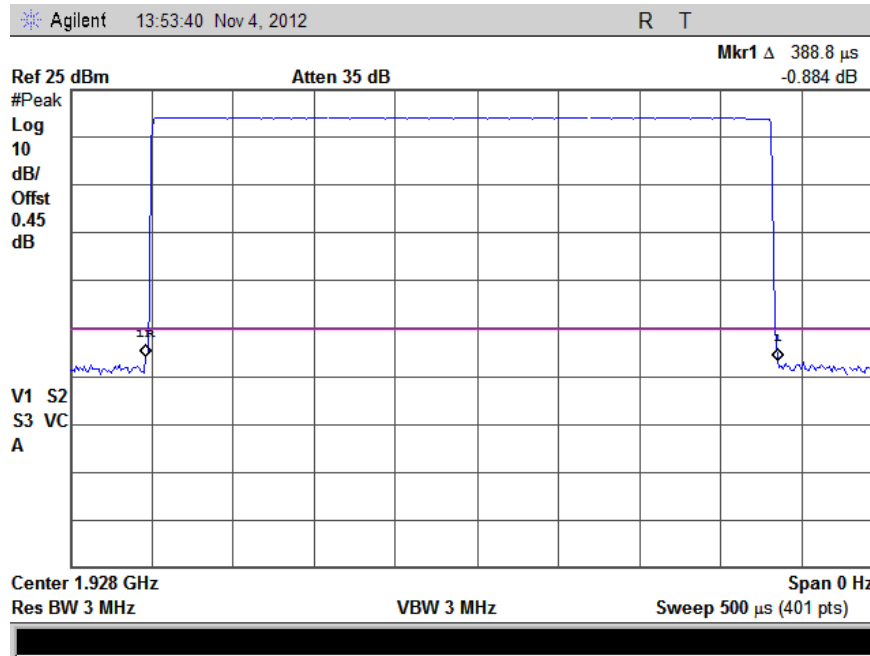

Result: Compliant, plot is for reference only, requirement covered via the LIC tests performed in Section 6.11.7 of this report.

6. Measurement Data (continued)**6.11 Specific Requirements to UPCS Devices (cont)****6.11.4 Lower Monitoring Threshold (15.323 (c) (2), RSS-213 4.3.4 (b) (2),
ANSI C63.17 Sec 7.3.2)**

Requirement: The monitoring threshold must not be more than 30 dB above the thermal noise power (KTB) of a bandwidth equivalent to the occupied bandwidth of the device.

For EUTs which support least interfered channel procedure (LIC), it is not necessary to measure the lower threshold under rule parts 15.323 (c) (2) and 4.3.4 (b) (2).

These are automatically met by the LIC procedure in clauses 15.323 (c) (5) and 4.3.4 (b) (5).

Result: The Lower Threshold is only applicable for systems which have defined less than 40 duplex system access channels. The EUT implements 5 channels as shown on page 5 of the test report. Each channel is made up of 12 timeslots for the Fixed Part (EUT) and 12 timeslots for the portable parts as documented in the manufacturers declaration.

Therefore the EUT uses 60 TDMA Duplex Channels and meets this requirement via the LIC tests performed in Section 6.11.7 of this report.

6. Measurement Data (continued)

6.11 Specific Requirements to UPCS Devices (cont)

6.11.5 Maximum Transmit Period (15.323 (c) (3), RSS-213 4.3.4 (b) (3), ANSI C63.17 Section 8.2.2)

Requirement: If no signal above the threshold level is detected, transmission may commence and continue with the same bandwidth in the monitored time and spectrum windows without further monitoring. Occupation of the same combined time and spectrum windows by a device or group of cooperating devices, continuously over a period of time longer than 8 hours is not permitted without repeating the access criteria.

Test Equipment Setup: The EUT is connected to the test set via a combiner and placed in TBR6 mode. The spectrum analyzer is configured to monitor and record in a single sweep the established connection, and the repeating of the access criteria.

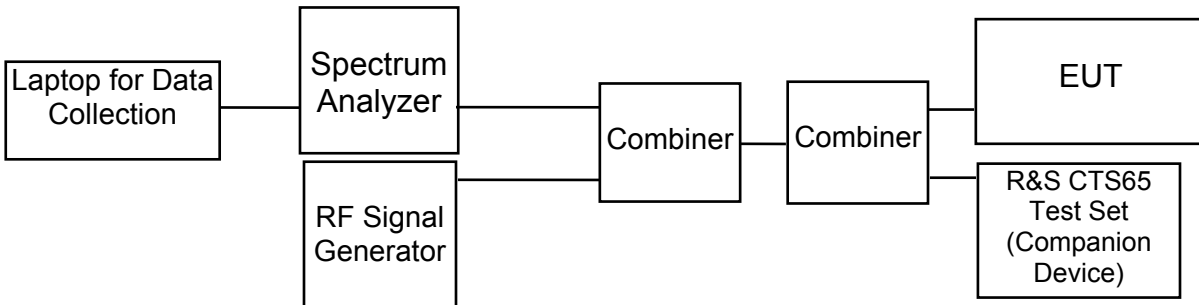

Requirement	Time	Limit	Result
Maximum Transmission Time 8.2.2	1.26 Secs	8 Hours	Compliant

Result: Compliant

6. Measurement Data (continued)

6.11 Specific Requirements to UPCS Devices (cont)

6.11.5 Maximum Transmit Period (15.323 (c) (3), RSS-213 4.3.4 (b) (3),
ANSI C63.17 Section 8.2.2)

6.11.5.1 Plot of Maximum Transmit Period – 1.26 Seconds

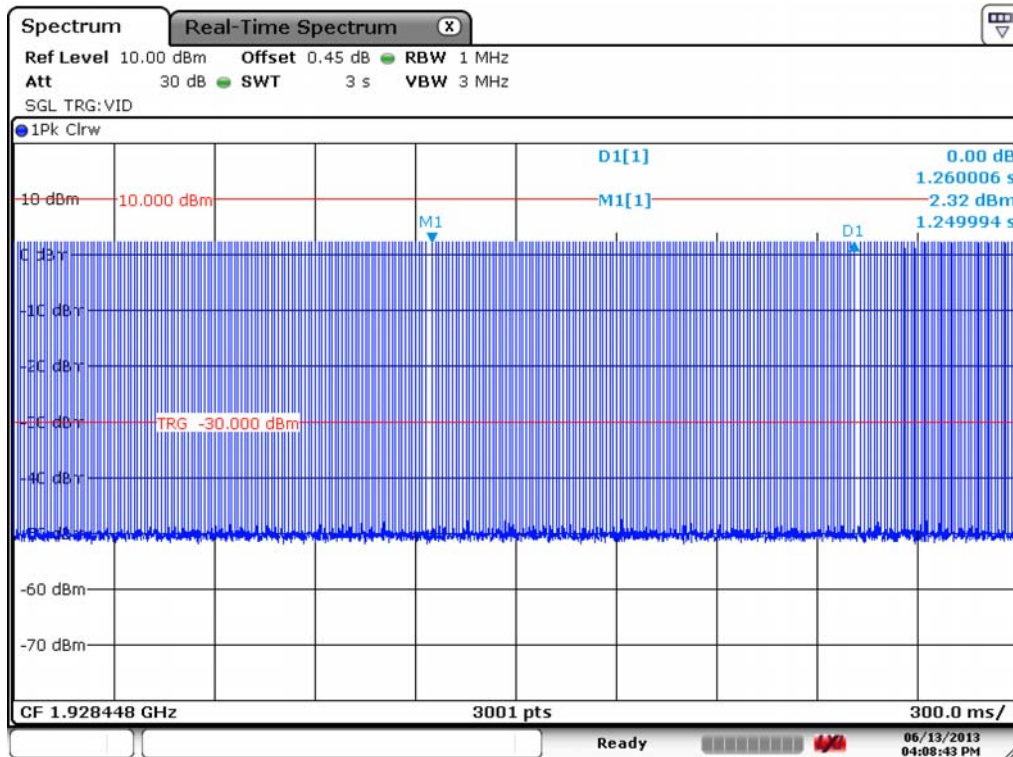

Date: 13.JUN.2013 16:08:44

6. Measurement Data (continued)

6.11 Specific Requirements to UPCS Devices (cont)

6.11.6 System Acknowledgement (15.323(c) (4), RSS-213 4.3.4 (b) (4)

Requirement: Once access to specific combined time and spectrum windows is obtained, an acknowledgement from a system participant must be received by the initiating transmitter within one second or transmission must cease. Periodic acknowledgements must be received at least every 30 seconds or transmission must cease. Channels used exclusively for control and signaling information may transmit continuously for 30 seconds without receiving an acknowledgement, at which time the access criteria must be repeated.

Connection acknowledgements are tested according to ANSI 63.17-2006 subclause 8.2.1.

Unacknowledged transmission following ANSI C63.17 Section 8.1.1 is performed.

Result: Access criteria test interval per ANSCI 63.17 Section 8.1.2 Access criteria functional test is performed via the LIC test documented in Section 6.11.7 of this report.

ANSI C63.17 Section 8.1.3 Access criteria functional test is not applicable because option FCC 15.323 (c) (6) / RSS-213 4.3.4 (b) (6) is not implemented.

Test Equipment Setup: The EUT is powered up without a companion device present. The transmission time without an acknowledgement is recorded and plotted via the spectrum analyzer.

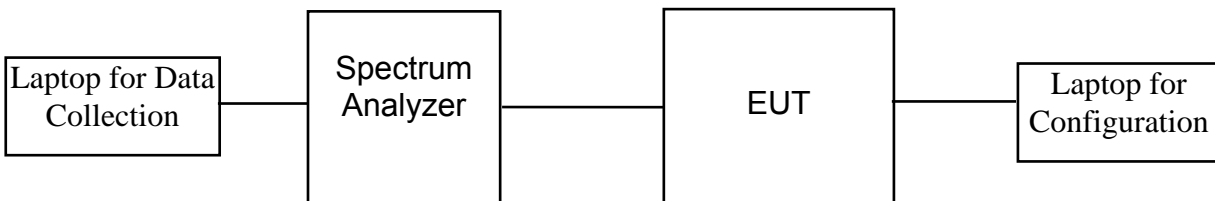

Requirement	Time	Limit	Result
Access Criteria test interval 8.1.1	~ 21 secs	<=30 secs	Compliant

Result: Compliant, the test was repeated 5 times and the worst case time is documented.

6. Measurement Data (continued)

6.11 Specific Requirements to UPCS Devices (cont)

6.11.6 System Acknowledgement (15.323(c) (4), RSS-213 4.3.4 (b) (4)

6.11.6.1 Plot of Unacknowledged Transmission

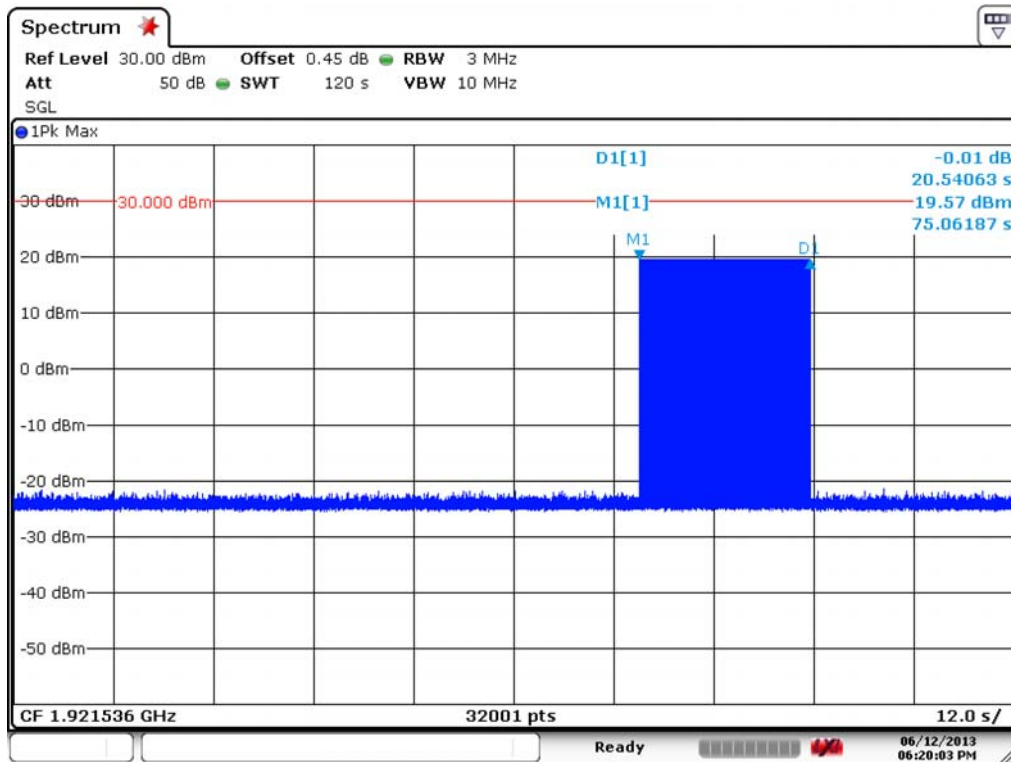

Date: 12.JUN.2013 18:20:02

6. Measurement Data (continued)

6.11 Specific Requirements to UPCS Devices (cont)

6.11.7 Least Interfered Channel (LIC) Selection (15.323(c) (5))

Requirement: If access to spectrum is not available as determined by the above, and a minimum of 20 duplex system access channels are defined for the system, the time and spectrum windows with the lowest power level may be accessed.

A device utilizing the provisions of this paragraph (5) must have monitored all access channels defined for its system within the last 10 seconds and must verify, within the 20 milliseconds (40 milliseconds for devices designed to use a 20 millisecond frame period) immediately preceding actual channel access, that the detected power of the selected time and spectrum windows is no higher than the previously detected value.

The power measurement resolution bandwidth for this comparison must be accurate to within 6 dB.

No device or group of cooperating devices located within 1 meter of each other shall during any frame period occupy more than 6 MHz of aggregate bandwidth, or alternatively, more than one third of the time and spectrum windows defined by the system.

Result: Compliant, each device occupies would occupy 1.487 MHz of spectrum and the maximum number of devices that may be used is 4 totaling 5.95 MHz of aggregate bandwidth.

Upper Threshold: $TU \leq -174 + 10 \log_{10} B + Mu + Pmax - Peut$ (dBm)

B = Emission Bandwidth in Hz

P = Peak Transmit Power (dBm)

$Pmax = 5 \log_{10} B - 10$ dBm

Calculated Thresholds:

	dBm
TL: Lower Threshold	N/A
TU: Upper Threshold	-61.25

Limits:

Limits	
	$TLR < TL + UM = N/A + 6.0 = N/A$ dBm
	$TUR < TU + UM = -61.25 + 6.0 = -55.25$ dBm

6. Measurement Data (continued)

6.11 Specific Requirements to UPCS Devices (cont)

6.11.7 Least Interfered Channel (LIC) Selection (RSS-213 4.3.4 (b) (5))

Requirement: If access to spectrum is not available as determined by the above, and a minimum of 40 duplex system access channels are defined for the system, the time and spectrum windows with a power level below a monitoring threshold of 50 dB above the thermal noise power determined for the occupied bandwidth may be accessed.

A device utilizing the provisions of this paragraph (5) must have monitored all access channels defined for its system within the last 10 seconds and must verify, within the 20 milliseconds (40 milliseconds for devices designed to use a 20 millisecond frame period) immediately preceding actual channel access, that the detected power of the selected time and spectrum windows is no higher than the previously detected value.

The power measurement resolution bandwidth for this comparison must be accurate to within 6 dB.

No device or group of cooperating devices located within 1 meter of each other shall during any frame period occupy more than 6 MHz of aggregate bandwidth, or alternatively, more than one third of the time and spectrum windows defined by the system.

Result: Compliant, each device could occupy 1.487 MHz of spectrum and the maximum number of devices that may be used is 4 totaling 5.95 MHz of aggregate bandwidth.

Upper Threshold: $TU \leq -174 + 10 \log_{10} B + \mu + P_{max} - P_{eut}$ (dBm)

B = Emission Bandwidth in Hz

P = Peak Transmit Power (dBm)

$P_{max} = 5 \log_{10} B - 10$ dBm

Calculated Thresholds:

	dBm
TL: Lower Threshold	N/A
TU: Upper Threshold	-61.25

Limits:

Limits	$TLR < TL + UM = N/A + 6.0 = N/A$
	$TUR < TU + UM = -61.25 + 6.0 = -55.25$ dBm

6. Measurement Data (continued)

6.11 Specific Requirements to UPCS Devices (cont)

6.11.7 (LIC) Selection (15.323 (c) (5), RSS-213 4.3.4 (b) (5), ANSI C63.17 Sec 7.3.3) (cont)

Test Equipment Setup: The EUT is configured to establish a connection with a companion device. Using a multi carrier RF signal generator interference is created on each of the channels at the Upper Threshold (-55.25 dBm) with one of the channels 6 dB lower then the other four channels. The EUT shall demonstrate the channel move function to the available channel as shown in Plots 6.11.7.1 to 6.11.7.5. Black trace shows the level of the multi-interference signal generator.

The EUT shall be able to distinguish between two low channels, and pick the lower of the two channels (least interfered), this is shown in plot 6.11.7.6.

The other test were performed per ANSI C63.17 Clause 7.3.3 and documented in the table below.

Each of the tests requires terminating the connection, re-establishing the connection and repeating the test 5 times.

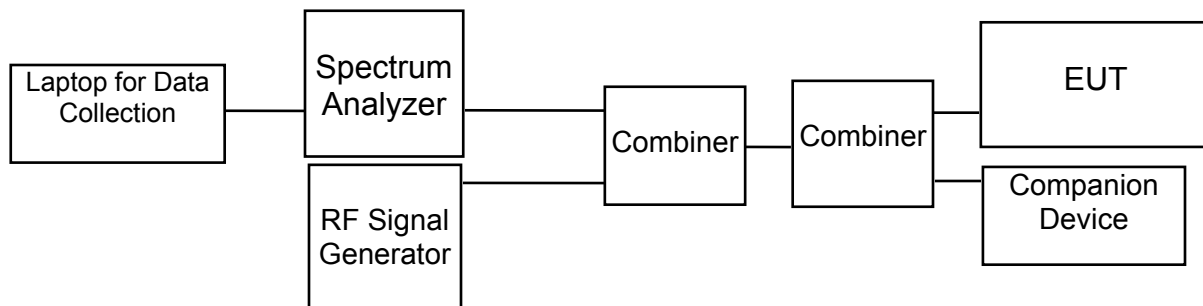

Result: Compliant

ANSI C63.17 clause 7.3.3 reference	Observation	Result
a) Uniform Interference except f1 & f2	Transmission always moves to lowest interfered channel f1	Compliant
b) f1 TL + 13 dB, f2 TL + 6 dB	Transmission always on f2	Compliant
c) f1 TL + 6 dB, f2 TL + 13 dB	Transmission always on f1	Compliant
d) f1 TL + 7 dB, f2 TL	Transmission always on f2	Compliant
e) f1 TL, f2 at TL + 7 dB	Transmission always on f1	Compliant

6. Measurement Data (continued)

6.11 Specific Requirements to UPCS Devices (cont)

6.11.7 (LIC) Selection (15.323(c) (5), RSS-213 4.3.4 (b) (5) (cont)

6.11.7.1 Plot Showing Least Interfered Channel Transmission on Channel 4

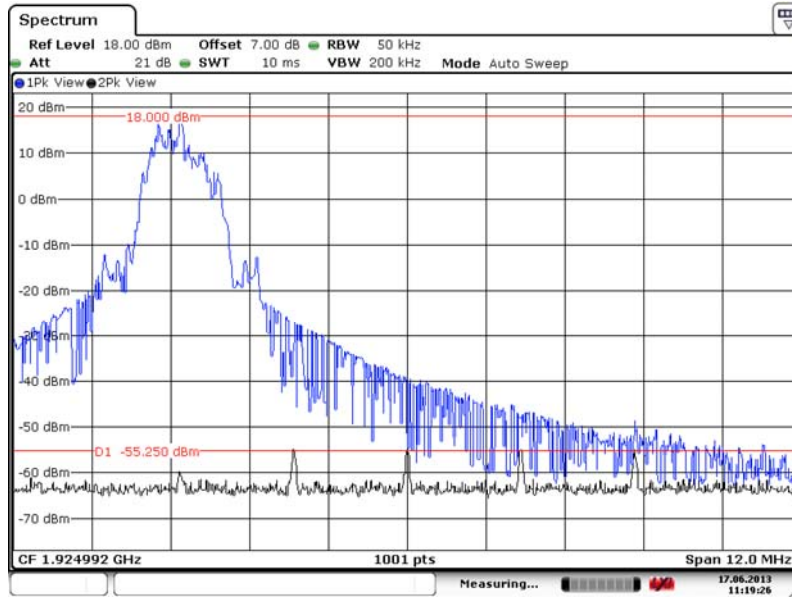

Date: 17.JUN.2013 11:19:26

6.11.7.2 Plot demonstrating moving from Channel 4 to Channel 3



Date: 17.JUN.2013 11:26:22

6. Measurement Data (continued)

6.11 Specific Requirements to UPCS Devices (cont)

6.11.7 (LIC) Selection (15.323(c) (5), RSS-213 4.3.4 (b) (5) (cont)

6.11.7.3 Plot Demonstrating Moving from Channel 4 to Channel 2



6.11.7.4 Plot Demonstrating Moving from Channel 4 to Channel 1

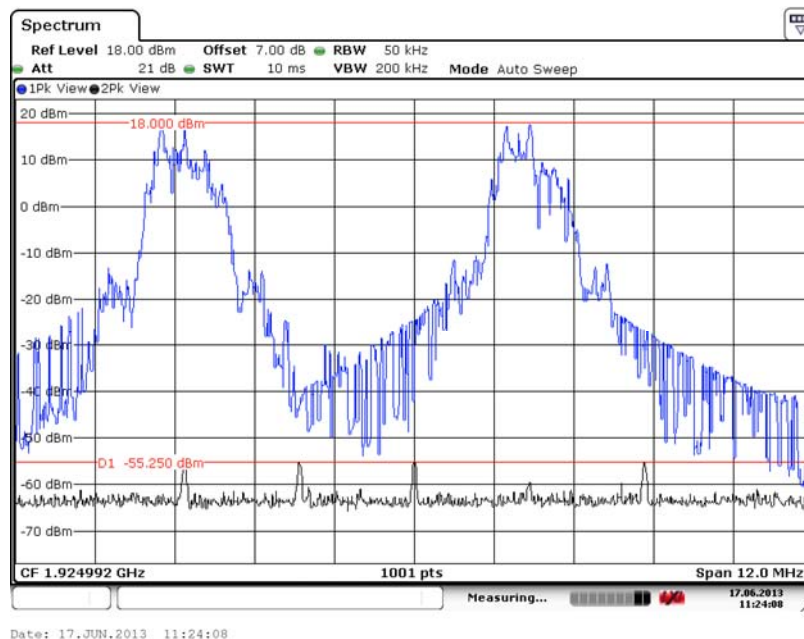

6. Measurement Data (continued)

6.11 Specific Requirements to UPCS Devices (cont)

6.11.7 (LIC) Selection (15.323(c) (5), RSS-213 4.3.4 (b) (5) (cont)

6.11.7.5 Plot Demonstrating Moving from Channel 4 to Channel 0

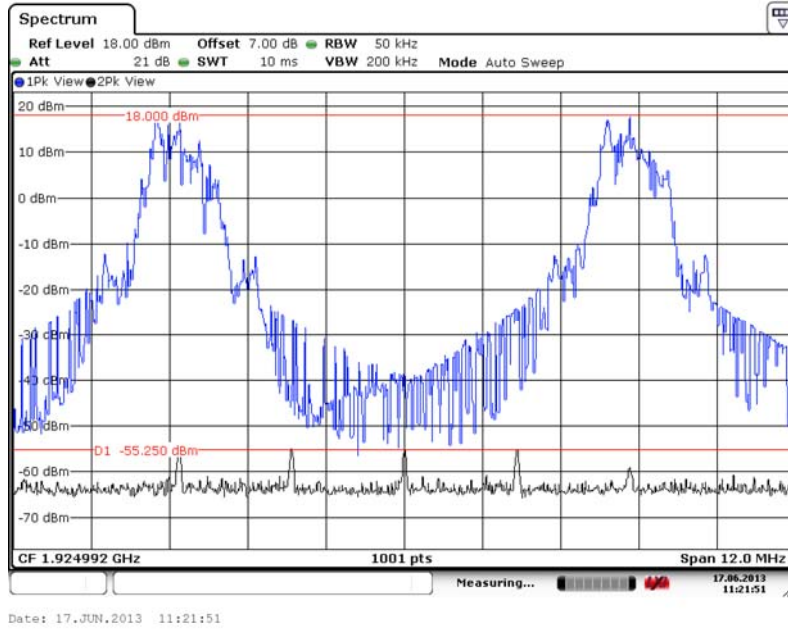

6.11.7.6 Plot demonstrating when Ch 4 is lower then Ch 2, EUT Transmits on Ch 4

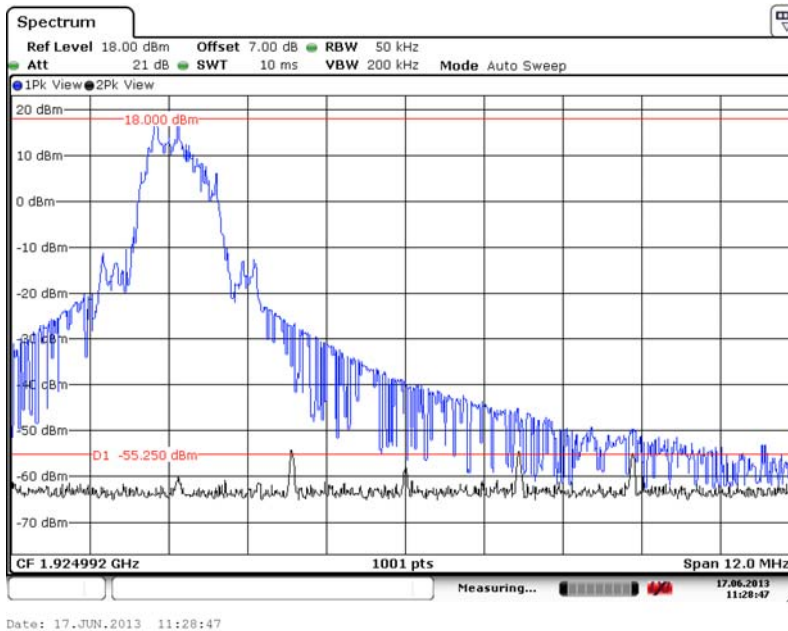

6. Measurement Data (continued)

6.11 Specific Requirements to UPCS Devices (cont)

6.11.7 (LIC) Selection (15.323(c) (5), RSS-213 4.3.4 (b) (5), ANSI 63.17 Sec 7.3.2 (b)

Requirement: By a multi-carrier interference generator, apply to the EUT uniform CW interference on all system carriers each at level $TU + UM + 10$ dB. Lower the interference uniformly on all carriers until the EUT can transmit. If the EUT first transmits at a per-carrier interference level greater than $TU + UM$, the EUT fails the test.

TU = -61.25 dBm
UM = 6 dBm
TUR = -55.25 dBm

Result: Compliant the EUT starts transmitting at -57.01 dBm

6.11.7.7 Upper Threshold Measurement for EUTs that implement LIC procedure

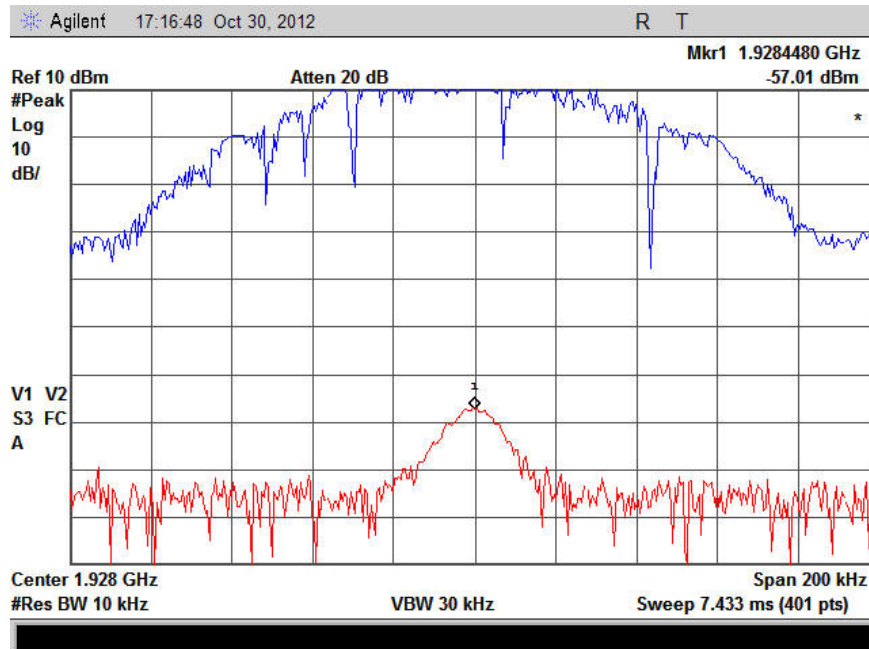

6. Measurement Data (continued)

6.11 Specific Requirements to UPCS Devices (cont)

6.11.7 (LIC) Selection (15.323(c) (5), RSS-213 4.3.4 (b) (5), ANSI 63.17 Sec 7.3.4

Requirement: The EUT shall make its channel selection decision based upon a recent power level reading using the procedure documented in ANSI C63.17:2006 Section 7.3.4.

Test Equipment Setup:

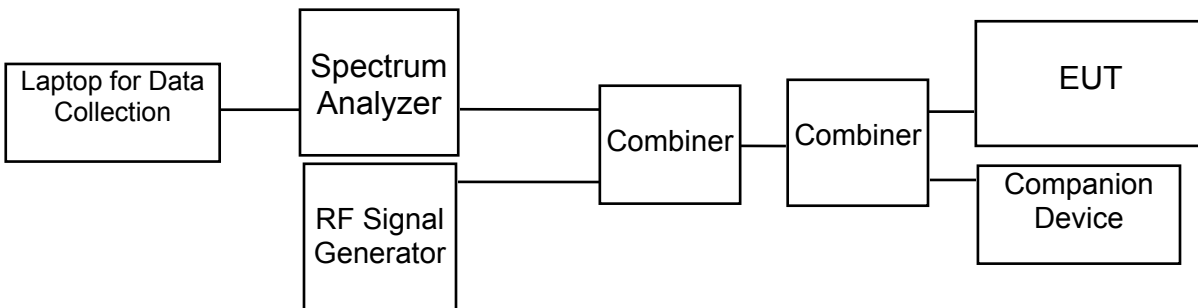

Result: Compliant

ANSI C63.17 clause 7.3.4 reference	Observation	Result
b) EUT Shall Not Transmit on f1	EUT transmits on f2	Compliant
d) EUT Shall Not Transmit on f2	EUT transmits on f1	Compliant

6. Measurement Data (continued)

6.11 Specific Requirements to UPCS Devices (cont)

6.11.8 Random waiting (15.323(c) (6), RSS-213 4.3.4 (b) (6))

Requirement: If the selected combined time and spectrum windows are unavailable, the device may either monitor and select different windows or seek to use the same windows after waiting an amount of time, randomly chosen from a uniform random distribution between 10 and 150 milliseconds, commencing from the time when the channel becomes available.

Result: Compliant, this feature is not implemented in the EUT.

6. Measurement Data (continued)

6.11 Specific Requirements to UPCS Devices (cont)

6.11.9 Monitoring Bandwidth (15.323(c) (7), RSS-213 4.3.4 (b) (7))

Requirement: The monitoring system bandwidth must be equal to or greater than the occupied bandwidth of the intended transmission.

Note: Testing of the monitoring system bandwidth is not required if the designed bandwidth from the manufacturer is available and given in the test report.

The monitor shall have a maximum reaction time less than $50\sqrt{1.25 / \text{occupied bandwidth in MHz}}$ microseconds for signals at the applicable threshold level but shall not be required to be less than 50 microseconds.

If a signal is detected that is 6 dB or more above the threshold level, the maximum reaction time shall be $35\sqrt{1.25 / \text{occupied bandwidth in MHz}}$ microseconds but shall not be required to be less than 35 microseconds.

Test Equipment Setup: Using a multi carrier RF signal generator in conjunction with a pulse modulation generator, interference is generated on all 5 modulated carrier frequencies using 35 μ S and 50 μ S pulsed signals. The EUT shall not connect in the presence of these signals.

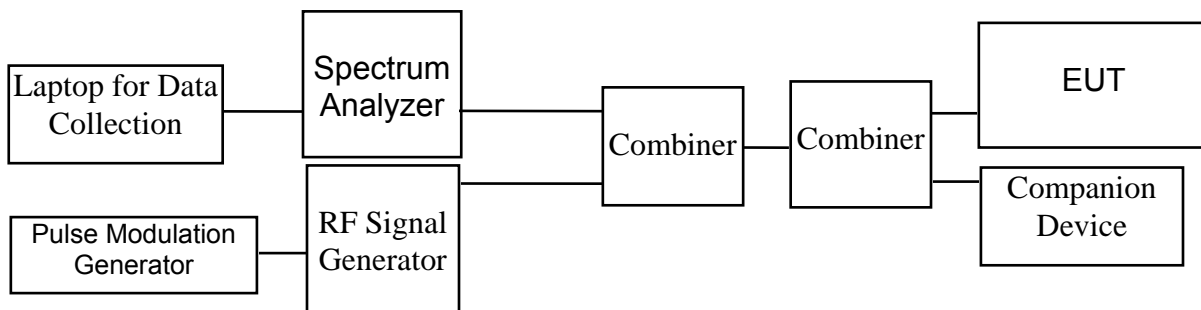

Pulse Width	Connection
50 μ S or $50 * \text{SQRT}(1.25/B) \mu$ S	no
35 μ S or $35 * \text{SQRT}(1.25/B) \mu$ S	no

Result: Compliant, the EUT does not connect in the presence of 35 μ S and/or 50 μ S pulsed modulated carriers.

6. Measurement Data (continued)**6.11 Specific Requirements to UPCS Devices (cont)****6.11.10 Monitoring Antenna (15.323(c) (8), RSS-213 4.3.4 (b) (8)**

Requirement: The monitoring system shall use the same antenna used for transmission, or an antenna that yields equivalent reception at that location.

Note: A monitoring antenna of the same model (and manufacturer) as the transmitting antenna is considered equivalent. An antenna not of the same model but of the same type (e.g. both are horn antennas of different manufacturers) is considered equivalent if the main beam antenna gains are within 3 dB of each other. Both antennas are to be installed to point at the same general coverage area.

Result: Compliant, the device uses the same antenna.

6.11.11 Monitoring Threshold Relaxation (15.323(c) (9), RSS-213 4.3.4 (b) (9)

Requirement: Devices that have a power output lower than the maximum permitted under this standard may increase their detection threshold by 1 dB for each 1 dB that the transmitter power is below the maximum permitted.

Result: Compliant, requirement is covered by LIC test in 15.323 (b) (5) / 4.3.4 (b)(5).

6.11.12 Duplex Connections (15.323(c) (10), RSS-213 4.3.4 (b) (10)

Requirement: A device initiating a communication (hereafter called an initiating device) may attempt to establish a duplex connection by monitoring both its intended transmit and receive time and spectrum windows. If both the intended transmit and receive time and spectrum windows meet the access criteria, then the initiating device can initiate a transmission in the intended transmit time and spectrum window. If the power detected by the responding device can be decoded as a duplex connection signal from the initiating device, then the responding device may immediately begin transmitting on the receive time and spectrum window monitored by the initiating device.

Result: Compliant, EUT does not support Duplex Connections.

6. Measurement Data (continued)**6.11 Specific Requirements to UPCS Devices (cont)****6.11.13 Alternative monitoring interval for co-located devices
(15.323(c) (11), RSS-213 4.3.4 (b) (11))**

Requirement: An initiating device that is prevented from monitoring during its intended transmit window due to monitoring system blocking from the transmissions of a co-located (within one meter) transmitter of the same system, may monitor the portions of the time and spectrum windows in which they intend to receive over a period of at least 10 milliseconds.

The monitored time and spectrum window must total at least 50 percent of the 10 millisecond frame interval and the monitored spectrum must be within 1.25 MHz of the centre frequency of channel(s) already occupied by that device or co-located co-operating devices.

If the access criteria is met for the intended receive time and spectrum window under the above conditions, then transmission in the intended transmit window by the initiating device may commence.

Result: Compliant, devices are not co-located within 1 meter.

6.11.14 Fair Access (15.323(c) (12), RSS-213 4.3.4 (b) (12))

Requirement: The provisions of Part 15.323 (c) (10) or (c) (11) and/or RSS-213 4.3.4 (b) (10) or (11) shall not be used to extend the range of spectrum occupied over space or time for the purpose of denying fair access to spectrum to other devices.

Result: Compliant, EUT does not operate in a mode that denies fair access.

6. Measurement Data (continued)

6.12. Public Exposure to Radio Frequency Energy Levels (1.1307 (b)(1))

RSS-GEN 5.5, RSS 102

6.12.1. MPE Power Density Table

Channel	MPE Distance (cm)	DUT Output Power (dBm)	DUT Antenna Gain (dBi)	Power Density		Limit (mW/cm2)	Result
				(mW/cm2)	(W/m2)		
ANT0	(1)	(2)	(3)	(4)		(5)	
TX4	20	18.97	0.50	0.018	0.176	1	Compliant
TX2	20	19.00	0.50	0.018	0.177	1	Compliant
TX0	20	19.02	0.50	0.018	0.178	1	Compliant
ANT1							
TX4	20	19.83	0.50	0.021	0.215	1	Compliant
TX2	20	19.83	0.50	0.021	0.215	1	Compliant
TX0	20	19.82	0.50	0.021	0.214	1	Compliant

$$PD = \frac{OP + AG}{(4 \times \pi \times d^2)}$$

PD = Power Density
 OP = DUT Output Power (dBm)
 AG = Antenna Gain (dBi)
 D = MPE Distance

1. Reference CFR 2.1093(b): For purposes of this section, a portable device is defined as a transmitting device designed to be used so that the radiating structure(s) of the device is/are within 20 centimeters of the body of the user.
2. Section 6.3 of this test report.
3. Data supplied by the client.
4. Power density is calculated from conducted power output measurement and antenna gain.
5. Reference CFR 1.1310, Table 1: Limits for Maximum Permissible Exposure (MPE), Section (B): Limits for General Population/Uncontrolled Exposure.

6. Measurement Data (continued)

6.12. Public Exposure to Radio Frequency Energy Levels (1.1307 (b)(1))

RSS-GEN 5.5, RSS 102 (cont.)

6.12.2. MPE Time Averaged Power Table

Channel	Frequency	DUT Output Power	DUT Antenna Gain	Calculated Output Power	Time Averaged Power	Limit	Result
	(MHz)	(dBm)	(dBi)	(mW)	(mW)	(mW)	
TX4	1921.536	18.97	0.50	88.51	3.44	100.00	Compliant
TX2	1924.992	19.00	0.50	89.13	3.47	100.00	Compliant
TX0	1928.448	19.02	0.50	89.54	3.48	100.00	Compliant
TX4	1921.536	19.83	0.50	107.89	4.19	100.00	Compliant
TX2	1924.992	19.83	0.50	107.89	4.19	100.00	Compliant
TX0	1928.448	19.82	0.50	107.65	4.19	100.00	Compliant

NOTE: Although the peak power is over the general exposure limit, the time averaged power is very small for DECT technology. In this case a nominal frame width of 388.8 μ S repeating every 10 mS, and therefore is compliant with the general exposure requirements defined in RSS-102 Section 2.5.1.

The reduction in power is calculated by $10 * \text{LOG} (0.3888 / 10)$ or -14.10 dB

RSS-102 Section 2.5, 2.5.1 & 2.5.2 Requirements:

2.5 - All transmitters are exempt from routine SAR and RF exposure evaluations provided that output power complies with the power levels of sections 2.5.1 or 2.5.2. If the equipment under test (EUT) meets the requirements of sections 2.5.1 or 2.5.2, applicants are only required to submit a properly signed declaration of compliance (see Annex C).

2.5.1 - SAR evaluation is required if the separation distance between the user and the radiating element of the device is less than or equal to 20 cm, except when the device operates as follows:

- above 1 GHz and up to 2.2 GHz inclusively, and with output power (i.e. the higher of the conducted or radiated (e.i.r.p.) source-based, time-averaged output power) that is less than or equal to 100 mW for general public use and 500 mW for controlled use

2.5.2 - RF exposure evaluation is required if the separation distance between the user and the device's radiating element is greater than 20 cm, except when the device operates as follows:

- at or above 1.5 GHz and the maximum e.i.r.p. of the device is equal to or less than 5 W.

7. Test Images

7.1. Radiated Emissions – Front 150 kHz to 1 GHz



7. Test Images

7.2. Radiated Emissions – Rear Below 30 MHz

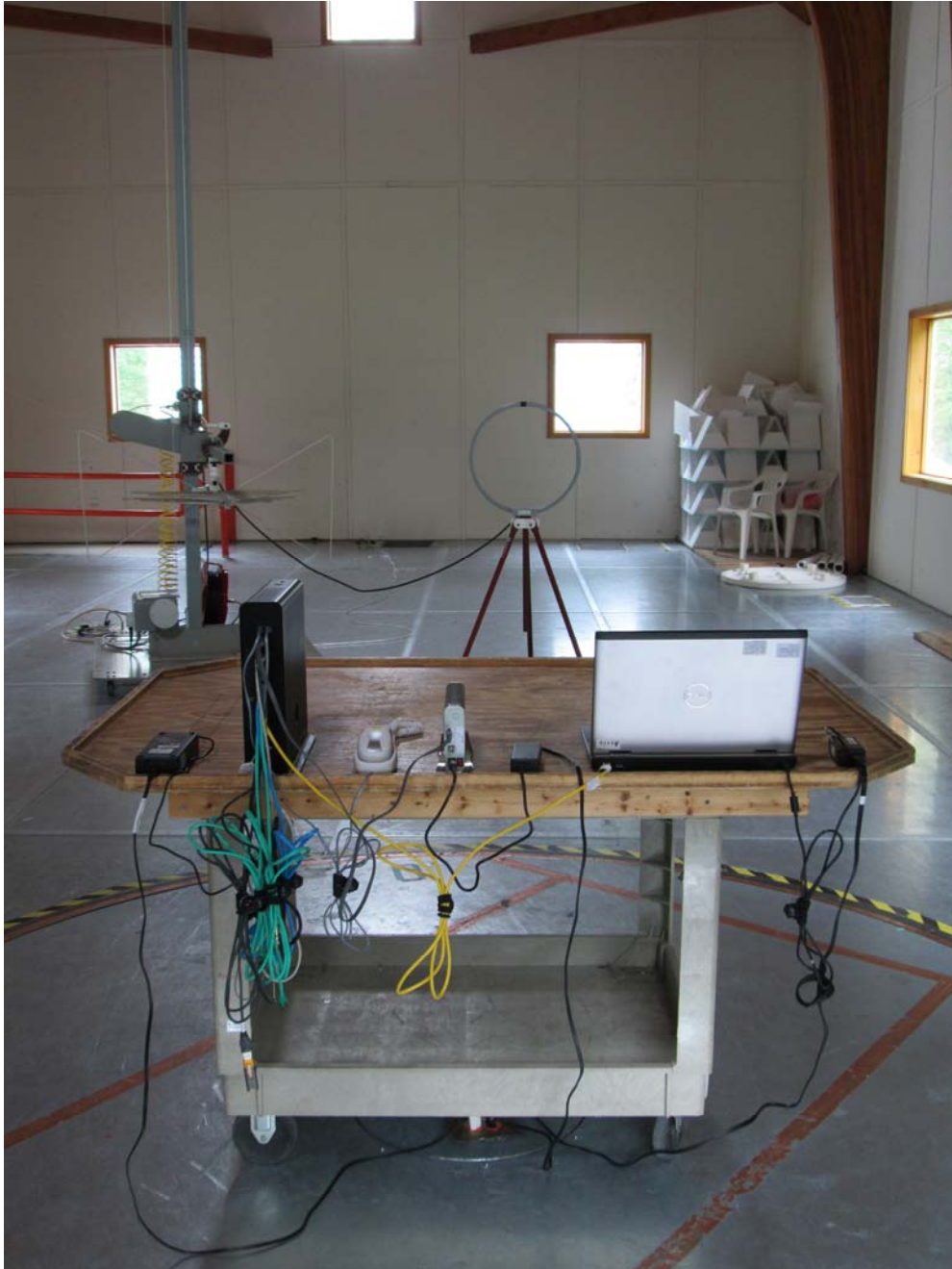

7. Test Images

7.3. Radiated Emissions – Rear 30 MHz to 1 GHz



7. Test Images

7.4. Radiated Emissions – Front Above 1 GHz



7. Test Images

7.5. Radiated Emissions – Rear 1 to 18 GHz



7. Test Images

7.6. Radiated Emissions – Rear 18 to 40 GHz



7. Test Images

7.7. Conducted Emissions (Front)



7. Test Images

7.8. Conducted Emissions (Rear)

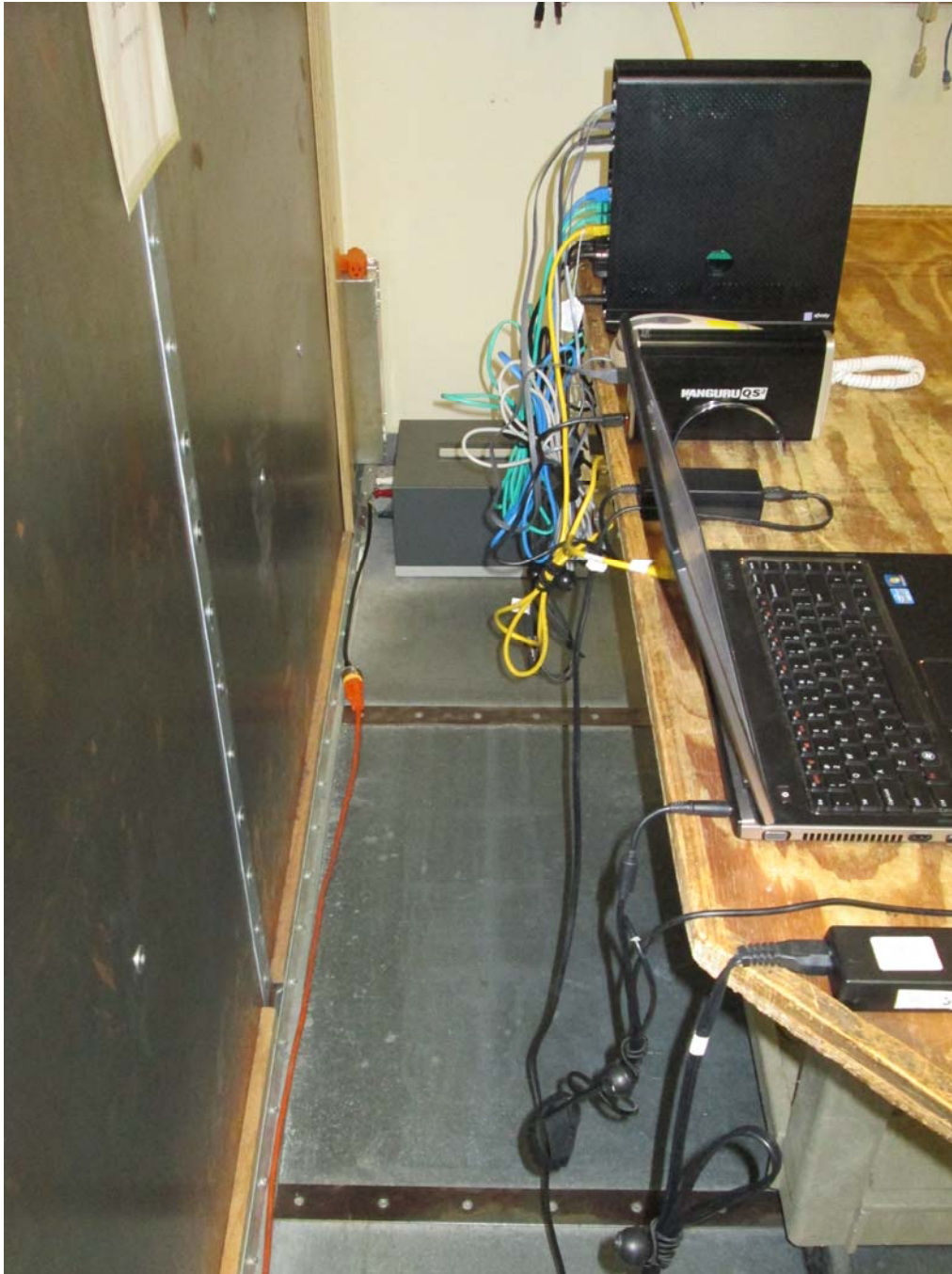

8. Test Site Description

Compliance Worldwide is located at 357 Main Street in Sandown, New Hampshire. The test sites at Compliance Worldwide are used for conducted and radiated emissions testing in accordance with Federal Communications Commission (FCC) and Industry Canada standards. A description of the test sites is on file with the FCC (registration number **96392**) and Industry Canada (file number **IC 3023A-1**).

The radiated emissions test site is a 3 and 10 meter enclosed open area test site (OATS). Personnel, support equipment and test equipment are located in the basement beneath the OATS ground plane.

The conducted emissions site consists of a 10' x 9' ground plane with an 8' x 9' Vertical Plane that is bonded at the seams.

Both sites are designed to test products or systems 1.5 meter W x 1.5 meter L x 2.0 meter H, floor standing or table top.