

DFS Test Report

Report No.: RFBHQC-WTW-P20110629-3

FCC ID: UID-G36

Test Model: G36

Series Model: G34

Received Date: Nov. 19, 2020

Test Date: Dec. 23 to 31, 2020

Issued Date: Jan. 13, 2021

Applicant: ARRIS

Address: 3871 Lakefield Drive Suite 300 SUWANEE, GA 30024

Issued By: Bureau Veritas Consumer Products Services (H.K.) Ltd., Taoyuan Branch
Hsin Chu Laboratory

Lab Address: E-2, No.1, Li Hsin 1st Road, Hsinchu Science Park, Hsinchu City 300,
Taiwan

Test Location: E-2, No.1, Li Hsin 1st Road, Hsinchu Science Park, Hsinchu City 300,
Taiwan

**FCC Registration /
Designation Number:** 723255 / TW2022



This report is for your exclusive use. Any copying or replication of this report to or for any other person or entity, or use of our name or trademark, is permitted only with our prior written permission. This report sets forth our findings solely with respect to the test samples identified herein. The results set forth in this report are not indicative or representative of the quality or characteristics of the lot from which a test sample was taken or any similar or identical product unless specifically and expressly noted. Our report includes all of the tests requested by you and the results thereof based upon the information that you provided to us. You have 60 days from date of issuance of this report to notify us of any material error or omission caused by our negligence, provided, however, that such notice shall be in writing and shall specifically address the issue you wish to raise. A failure to raise such issue within the prescribed time shall constitute your unqualified acceptance of the completeness of this report, the tests conducted and the correctness of the report contents. Unless specific mention, the uncertainty of measurement has been explicitly taken into account to declare the compliance or non-compliance to the specification.

Table of Contents

Release Control Record	3
1 Certificate of Conformity	4
2 EUT Information	5
2.1 Operating Frequency Bands and Mode of EUT	5
2.2 EUT Software and Firmware Version	5
2.3 Description of Available Antennas to the EUT	6
2.4 EUT Maximum and Minimum Conducted Power	7
2.5 EUT Maximum and Minimum EIRP Power	7
2.6 Transmit Power Control (TPC)	8
2.7 Statement of Manufacturer	8
3. U-NII DFS Rule Requirements	9
3.1 Working Modes and Required Test Items	9
3.2 Test Limits and Radar Signal Parameters	10
4. Test & Support Equipment List	13
4.1 Test Instruments	13
4.2 Description of Support Units	13
5. Test Procedure	14
5.1 DFS Measurement System	14
5.2 Calibration of DFS Detection Threshold Level	15
5.3 Deviation from Test Standard	15
5.4 Radiated Test Setup Configuration	16
6. Test Results	17
6.1 Summary of Test Results	17
6.2 Test Results	18
6.2.1 Test Mode: Device Operating in Master Mode	18
6.2.2 U-NII Detection Bandwidth	23
6.2.3 Channel Availability Check Time	33
6.2.4 Channel Closing Transmission and Channel Move Time	35
6.2.5 Non- Occupancy Period	70
7. Information of the Testing Laboratories	72
APPENDIX-A	73

Release Control Record

Issue No.	Description	Date Issued
RFBHQC-WTW-P20110629-3	Original release.	Jan. 13, 2021

1 Certificate of Conformity

Product: DOCSIS 3.1 Wireless Cable Modem

Brand: ARRIS

Test Model: G36

Series Model: G34

Sample Status: Engineering sample

Applicant: ARRIS

Test Date: Dec. 23 to 31, 2020

Standards: FCC Part 15, Subpart E (Section 15.407)

References Test Guidance: KDB 905462 D02 UNII DFS Compliance Procedures New Rules v02

The above equipment has been tested by **Bureau Veritas Consumer Products Services (H.K.) Ltd., Taoyuan Branch**, and found compliance with the requirement of the above standards. The test record, data evaluation & Equipment Under Test (EUT) configurations represented herein are true and accurate accounts of the measurements of the sample's EMC characteristics under the conditions specified in this report.

Prepared by : Joyce Kuo , **Date:** Jan. 13, 2021
Joyce Kuo / Specialist

Approved by : Clark Lin , **Date:** Jan. 13, 2021
Clark Lin / Technical Manager

2 EUT Information

2.1 Operating Frequency Bands and Mode of EUT

Table 1: Operating Frequency Bands and Mode of EUT

Operational Mode	Operating Frequency Range	
	5250~5350MHz	5470~5725MHz
Master	✓	✓

2.2 EUT Software and Firmware Version

Table 2: The EUT Software/Firmware Version

No.	Product	Model No.	Software/Firmware Version
1	DOCSIS 3.1 Wireless Cable Modem	G36	01.04.017.NCS

2.3 Description of Available Antennas to the EUT

Table 3: Antenna List

Antenna NO.	RF Chain NO	Brand	Antenna Net Gain(dBi)	Frequency range	Antenna Type	Connector Type	Cable Length
ANT1	Chain0	2G	2.82	2.4~2.4835GHz	Dipole	i-pex(MHF)	40mm
		5G	3.88	5.15~5.25GHz			
			3.88	5.25~5.35GHz			
			4.3	5.47~5.725GHz			
			4.42	5.725~5.85GHz			
ANT2	Chain1	2G	2.84	2.4~2.4835GHz	Dipole	i-pex(MHF)	130mm
		5G	3.85	5.15~5.25GHz			
			4.33	5.25~5.35GHz			
			4.3	5.47~5.725GHz			
			4.38	5.725~5.85GHz			

*The above Antenna information is declared by manufacturer and for more detailed features description, please refer to the manufacturer's specifications, the laboratory shall not be held responsible.

2.4 EUT Maximum and Minimum Conducted Power

Table 4: The Measured Conducted Output Power

CDD Mode

Frequency Band (MHz)	MAX. Power		MIN. Power	
	Output Power (mW)	Output Power (dBm)	Output Power (mW)	Output Power (dBm)
5250~5350	246.604	23.92	61.944	17.92
5470~5725	233.538	23.68	58.614	17.68

Beamforming Mode

Frequency Band (MHz)	MAX. Power		MIN. Power	
	Output Power (mW)	Output Power (dBm)	Output Power (mW)	Output Power (dBm)
5250~5350	187.849	22.74	47.206	16.74
5470~5725	176.12	22.46	44.259	16.46

2.5 EUT Maximum and Minimum EIRP Power

Table 5: The EIRP Output Power List

CDD Mode

Frequency Band (MHz)	MAX. EIRP Power		MIN. EIRP Power	
	Output Power (mW)	Output Power (dBm)	Output Power (mW)	Output Power (dBm)
5250~5350	668.344	28.25	167.880	22.25
5470~5725	628.058	27.98	157.761	21.98

Beamforming Mode

Frequency Band (MHz)	MAX. EIRP Power		MIN. EIRP Power	
	Output Power (mW)	Output Power (dBm)	Output Power (mW)	Output Power (dBm)
5250~5350	968.278	29.86	243.22	23.86
5470~5725	948.418	29.77	238.232	23.77

2.6 Transmit Power Control (TPC)

U-NII devices operating in the 5.25-5.35 GHz band and the 5.47-5.725 GHz band shall employ a TPC mechanism. The U-NII device is required to have the capability to operate at least 6 dB below the mean EIRP value of 30 dBm. A TPC mechanism is not required for systems with an e.i.r.p. of less than 500 mW.

Applicable	EIRP	FCC 15.407 (h)(1)
√	>500mW	The TPC mechanism is required for system with an EIRP of above 500mW
	<500mW	The TPC mechanism is not required for system with an EIRP of less 500mW

The UUT can adjust a transmitter's output power based on the signal level present at the receiver. TPC is auto controlled by software.

2.7 Statement of Manufacturer

Manufacturer statement confirming that information regarding the parameters of the detected Radar Waveforms is not available to the end user.

3. U-NII DFS Rule Requirements

3.1 Working Modes and Required Test Items

The manufacturer shall state whether the UUT is capable of operating as a Master and/or a Client. If the UUT is capable of operating in more than one operating mode then each operating mode shall be tested separately. See tables 6 and 7 for the applicability of DFS requirements for each of the operational modes.

Table 6: Applicability of DFS Requirements Prior to Use a Channel

Requirement	Operational Mode		
	Master	Client without radar detection	Client with radar detection
Non-Occupancy Period	✓	✓ note	✓
DFS Detection Threshold	✓	Not required	✓
Channel Availability Check Time	✓	Not required	Not required
U-NII Detection Bandwidth	✓	Not required	✓

Note: Per KDB 905462 D03 UNII Clients Without Radar Detection New Rules v01r02 section (b)(5/6), If the client moves with the master, the device is considered compliant if nothing appears in the client non-occupancy period test. For devices that shut down (rather than moving channels), no beacons should appear. An analyzer plot that contains a single 30-minute sweep on the original channel.

Table 7: Applicability of DFS Requirements during Normal Operation

Requirement	Operational Mode	
	Master or Client with radar detection	Client without radar detection
DFS Detection Threshold	✓	Not required
Channel Closing Transmission Time	✓	✓
Channel Move Time	✓	✓
U-NII Detection Bandwidth	✓	Not required

Additional requirements for devices with multiple bandwidth modes	Master or Client with radar detection	Client without radar detection
U-NII Detection Bandwidth and Statistical Performance Check	All BW modes must be tested	Not required
Channel Move Time and Channel Closing Transmission Time	Test using widest BW mode available	Test using the widest BW mode available for the link
All other tests	Any single BW mode	Not required

Note: Frequencies selected for statistical performance check (Section 7.8.4) should include several frequencies within the radar detection bandwidth and frequencies near the edge of the radar detection bandwidth. For 802.11 devices it is suggested to select frequencies in each of the bonded 20 MHz channels and the channel center frequency.

3.2 Test Limits and Radar Signal Parameters

Detection Threshold Values

Table 8: DFS Detection Thresholds for Master Devices and Client Devices with Radar Detection

Maximum Transmit Power	Value (See Notes 1, 2, and 3)
EIRP \geq 200 milliwatt	-64 dBm
EIRP < 200 milliwatt and power spectral density < 10 dBm/MHz	-62 dBm
EIRP < 200 milliwatt that do not meet the power spectral density requirement	-64 dBm

Note 1: This is the level at the input of the receiver assuming a 0 dBi receive antenna.
 Note 2: Throughout these test procedures an additional 1 dB has been added to the amplitude of the test transmission waveforms to account for variations in measurement equipment. This will ensure that the test signal is at or above the detection threshold level to trigger a DFS response.
 Note3: EIRP is based on the highest antenna gain. For MIMO devices refer to KDB Publication 662911 D01.

Table 9: DFS Response Requirement Values

Parameter	Value
Non-occupancy period	Minimum 30 minutes
Channel Availability Check Time	60 seconds
Channel Move Time	10 seconds See Note 1.
Channel Closing Transmission Time	200 milliseconds + an aggregate of 60 milliseconds over remaining 10 second period. See Notes 1 and 2.
U-NII Detection Bandwidth	Minimum 100% of the U-NII 99% transmission power bandwidth. See Note 3

Note 1: Channel Move Time and the Channel Closing Transmission Time should be performed with Radar Type 0. The measurement timing begins at the end of the Radar Type 0 burst.
 Note 2: The Channel Closing Transmission Time is comprised of 200 milliseconds starting at the beginning of the Channel Move Time plus any additional intermittent control signals required to facilitate a Channel move (an aggregate of 60 milliseconds) during the remainder of the 10 second period. The aggregate duration of control signals will not count quiet periods in between transmissions.
 Note 3: During the U-NII Detection Bandwidth detection test, radar type 0 should be used. For each frequency step the minimum percentage of detection is 90 percent. Measurements are performed with no data traffic.

Parameters of DFS Test Signals

Step intervals of 0.1 microsecond for Pulse Width, 1 microsecond for PRI, 1 MHz for chirp width and 1 for the number of pulses will be utilized for the random determination of specific test waveforms.

Table 10: Short Pulse Radar Test Waveforms

Radar Type	Pulse Width (μsec)	PRI (μsec)	Number of Pulses	Minimum Percentage of Successful Detection	Minimum Number of Trials
0	1	1428	18	See Note 1	See Note 1
1	1	Test A 15 unique PRI values randomly selected from the list of 23 PRI values	Roundup $\left\{ \begin{array}{l} \left(\frac{1}{360} \right) \cdot \\ \left(\frac{19 \cdot 10^6}{\text{PRI}_{\mu\text{sec}}} \right) \end{array} \right\}$	60%	30
		15 unique PRI values randomly selected within the range of 518~3066 μ sec with a minimum of 1 μ sec, excluding PRI values selected in Test A			
2	1-5	150-230	23-29	60%	30
3	6-10	200-500	16-18	60%	30
4	11-20	200-500	12-16	60%	30
Aggregate (Radar Types 1-4)				80%	120
Note 1: Short Pulse Radar Type 0 should be used for the detection bandwidth test, channel move time, and channel closing time tests.					

Table 11: Long Pulse Radar Test Waveform

Radar Type	Pulse Width (μsec)	Chirp Width (MHz)	PRI (μsec)	Number of Pulses Per Burst	Number of Bursts	Minimum Percentage of Successful Detection	Minimum Number of Trials
5	50-100	5-20	1000-2000	1-3	8-20	80%	30

Three subsets of trials will be performed with a minimum of ten trials per subset. The subset of trials differ in where the Long Pulse Type 5 Signal is tuned in frequency.

- a) the Channel center frequency
- b) tuned frequencies such that 90% of the Long Pulse Type 5 frequency modulation is within the low edge of the UUT Occupied Bandwidth
- c) tuned frequencies such that 90% of the Long Pulse Type 5 frequency modulation is within the high edge of the UUT Occupied Bandwidth

It include 10 trails for every subset, the formula as below,

For subset case 1: the center frequency of the signal generator will remain fixed at the center of the UUT Channel.

For subset case 2: to retain 90% frequency overlap between the radar signal and the UUT Occupied Bandwidth, the center frequency of the signal generator will vary for each of the ten trials in subset case 2. The center frequency of the signal generator for each trial is calculated by:

$$FL+(0.4*Chirp\ Width\ [in\ MHz])$$

For subset case 3: to retain 90% frequency overlap between the radar signal and the UUT Occupied Bandwidth, the center frequency of the signal generator will vary for each of the ten trials in subset case 3. The center frequency of the signal generator for each trial is calculated by:

$$FH-(0.4*Chirp\ Width\ [in\ MHz])$$

Table 12: Frequency Hopping Radar Test Waveform

Radar Type	Pulse Width (μsec)	PRI (μsec)	Pulses per Hop	Hopping Rate (kHz)	Hopping Sequence Length (msec)	Minimum Percentage of Successful Detection	Minimum Number of Trials
6	1	333	9	0.333	300	70%	30

4. Test & Support Equipment List

4.1 Test Instruments

Table 13: Test Instruments List

DESCRIPTION & MANUFACTURER	MODEL NO.	SERIAL NO.	CALIBRATED DATE	CALIBRATED UNTIL
Spectrum Analyzer R&S	ESR	102026	Apr. 22, 2020	Apr. 21, 2021
Vector Signal Generator Agilent	N5182B	MY53052700	July 14, 2020	July 13, 2021
Horn_Antenna FT-RF	HA-07M18G-NF	0000220091110	Nov. 22, 2020	Nov. 21, 2021
DFS Control Box	BV-DFS-CB	002	Dec. 01, 2020	Nov. 30, 2021

- Note:**
1. The test was performed in DFS-2 room.
 2. The calibration interval of the above test instruments is 12 months and the calibrations are traceable to NML/ROC and NIST/USA.
 3. Tested Date: Dec. 23 to 31, 2020

4.2 Description of Support Units

Table 14: Support Unit Information

No.	Product	Brand	Model No.	FCC ID	Spec
1	Intel® Wi-Fi 6 AX200	Intel	AX200NGW	PD9AX200NG	

NOTE: This device was functioned as a Master Slave device during the DFS test.

Table 15: Software/Firmware Information

No.	Product	Model No.	Software/Firmware Version
1	Intel® Wi-Fi 6 AX200	AX200NGW	21.80.2.1

5. Test Procedure

5.1 DFS Measurement System

A complete DFS Measurement System consists of two subsystems: (1) the Radar Signal Generating system and (2) the Traffic Monitoring system. The control PC is necessary for generating the Radar waveforms in Table 10, 11 and 12. The traffic monitoring subsystem is specified to the type of unit under test (UUT).

Radiated Setup Configuration of DFS Measurement System

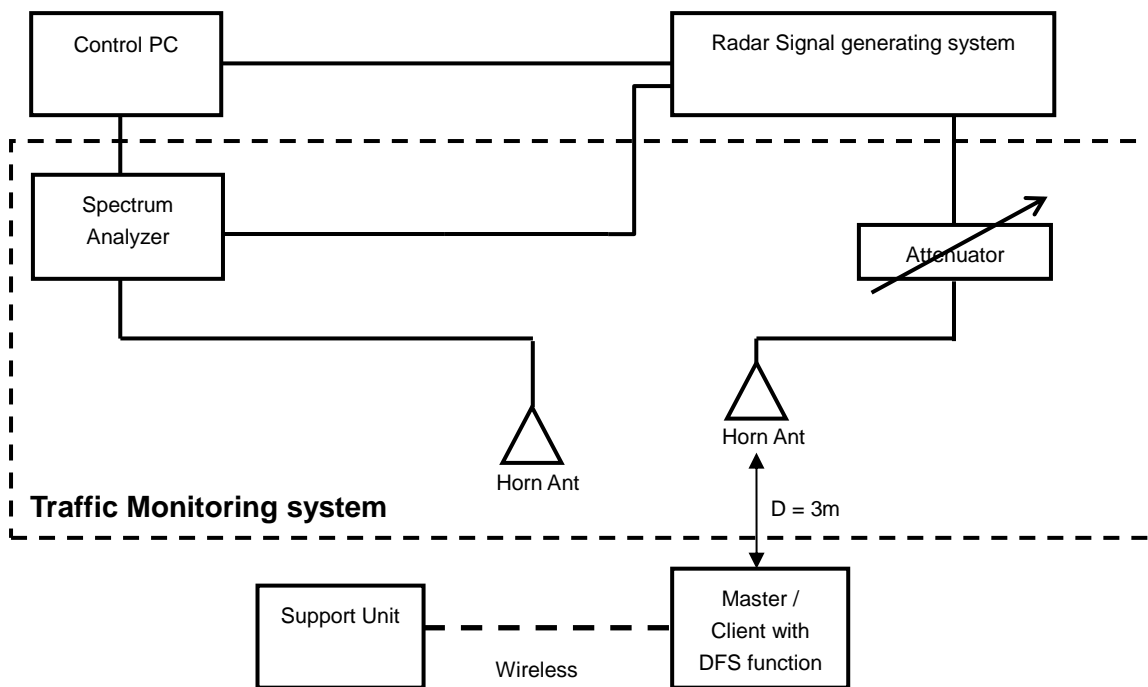

Channel Loading

System testing will be performed with channel-loading using means appropriate to the data types that are used by the unlicensed device. The following requirements apply:

a)	The data file must be of a type that is typical for the device (i.e., MPEG-2, MPEG-4, WAV, MP3, MP4, AVI, etc.) and must generally be transmitting in a streaming mode.	
b)	Software to ping the client is permitted to simulate data transfer but must have random ping intervals.	
c)	Timing plots are required with calculations demonstrating a minimum channel loading of approximately 17% or greater.	✓
d)	Unicast or Multicast protocols are preferable but other protocols may be used. The appropriate protocol used must be described in the test procedures.	

5.2 Calibration of DFS Detection Threshold Level

The measured channel is chosen from the operating channels of the UUT within the 5250-5350MHz or 5470-5725MHz and using the all bandwidth mode available for the link. The radar signal was the same as transmitted channels, and injected into the antenna of AP (master) or Client Device with Radar Detection, measured the channel closing transmission time and channel move time.

Radiated setup configuration of Calibration of DFS Detection Threshold Level

The radar signal generate system is generating waveform pattern of radar types. The amplitude of the radar signal generator system is adjusted to yield a level of -64 dBm as measured on the spectrum analyzer. The interference detection threshold level is lower than -64 dBm hence it provides margin to the limit.

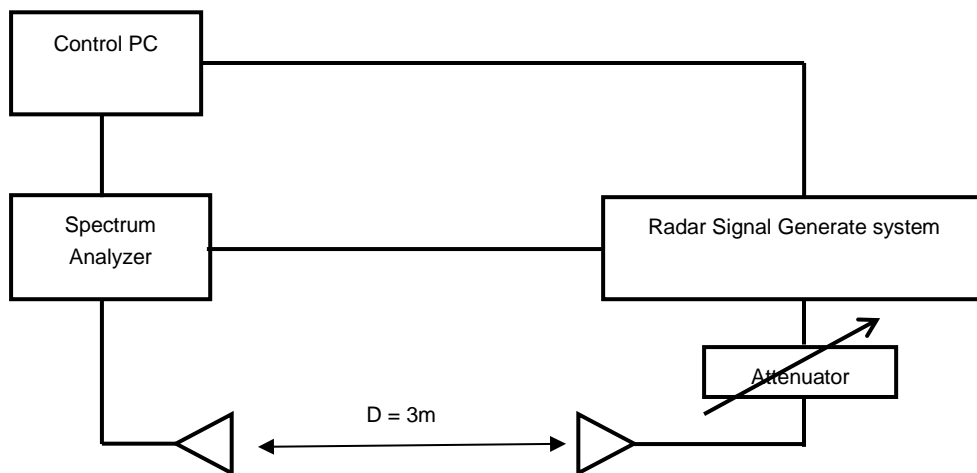

5.3 Deviation from Test Standard

No deviation.

5.4 Radiated Test Setup Configuration

Master mode

The EUT is a U-NII Device operating in Master mode. The radar test signals are injected into the Master Device.

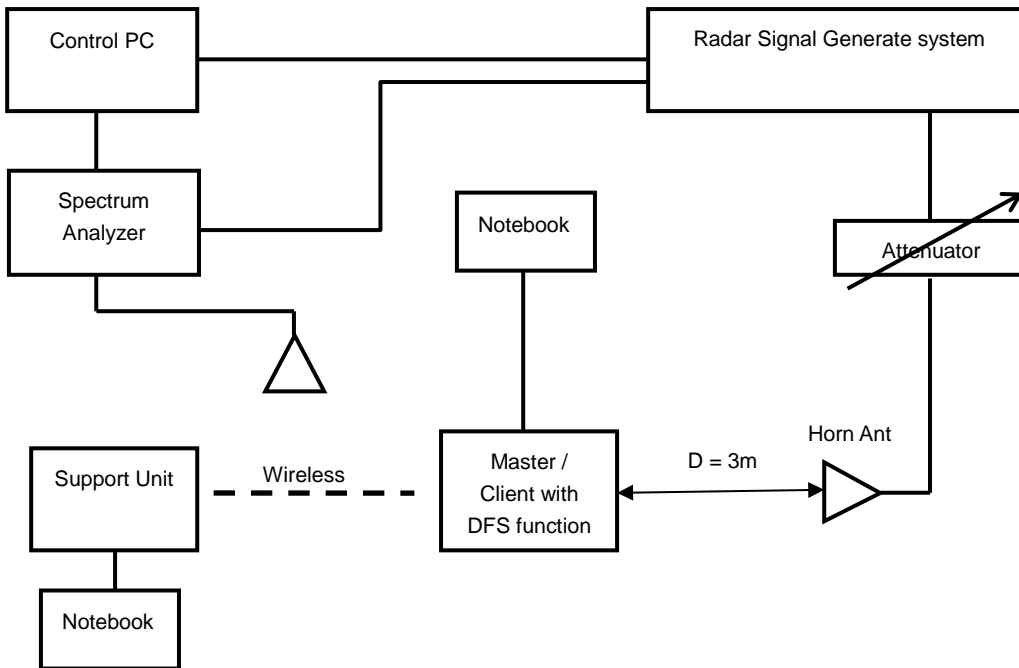

Note: The UUT main beam of the antenna is directly toward the radar emitter during testing.

6. Test Results

6.1 Summary of Test Results

Clause	Test Parameter	Remarks	Pass/Fail
15.407	DFS Detection Threshold	Applicable	Pass
15.407	Channel Availability Check Time	Applicable	Pass
15.407	Channel Move Time	Applicable	Pass
15.407	Channel Closing Transmission Time	Applicable	Pass
15.407	Non- Occupancy Period	Applicable	Pass
15.407	U-NII Detection Bandwidth and Statistical Performance Check	Applicable	Pass

Note:

1. This device does not support "802.11ax Channel Puncturing" function.
2. Determining compliance based on the results of the compliance measurement, not taking into account measurement instrumentation uncertainty.

6.2 Test Results

6.2.1 Test Mode: Device Operating in Master Mode

The radar test waveforms are injected into the Master.
This test was investigated for different bandwidth (20MHz · 40MHz · 80MHz and 160MHz).
The following plots was done on 160MHz as a representative

DFS Detection Threshold

For detection threshold level of -64dBm, the tested level is lower than required level for 1dB, hence it provides margin to the limit.

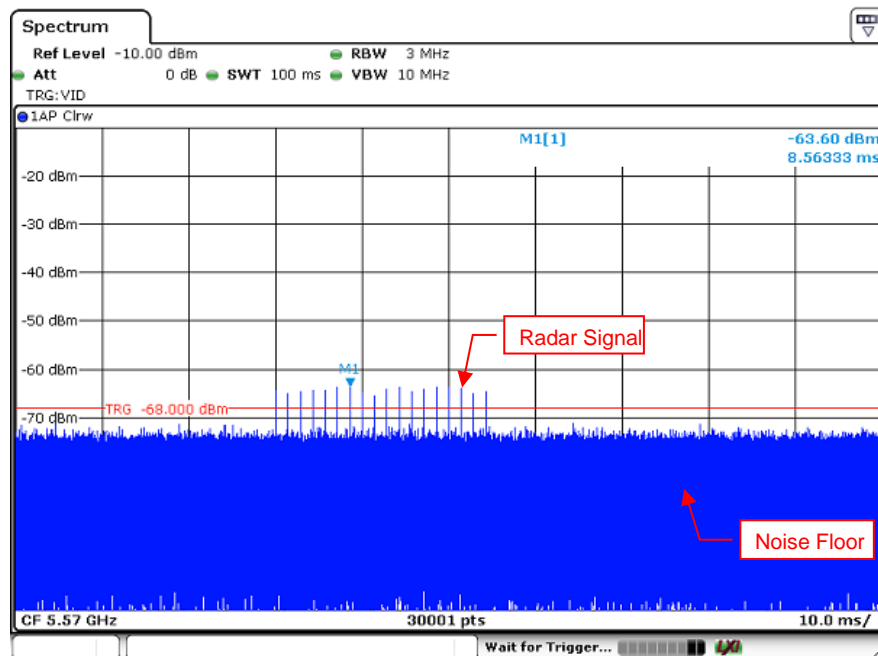

Radar Signal 0

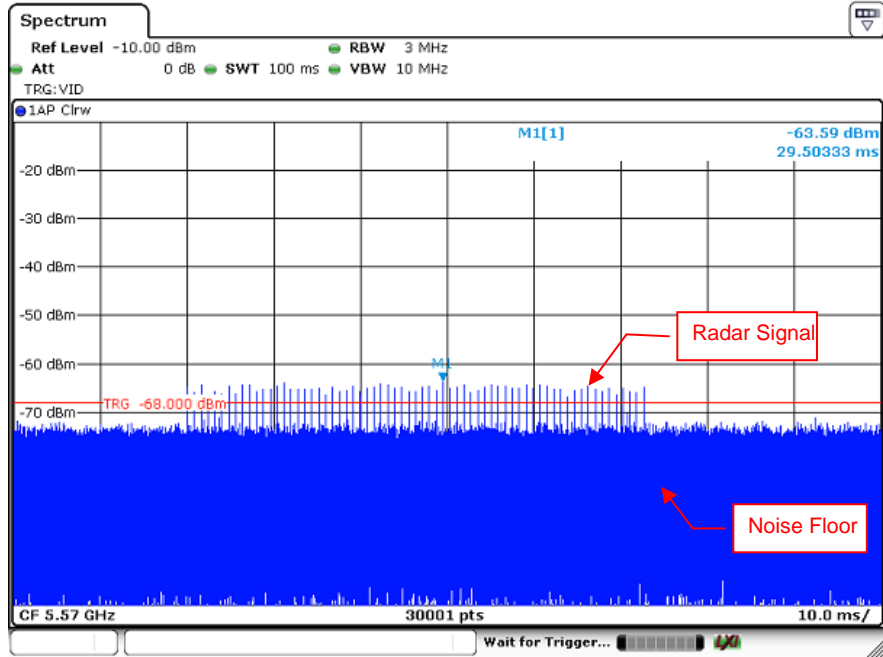

Radar Signal 1 (Test A)

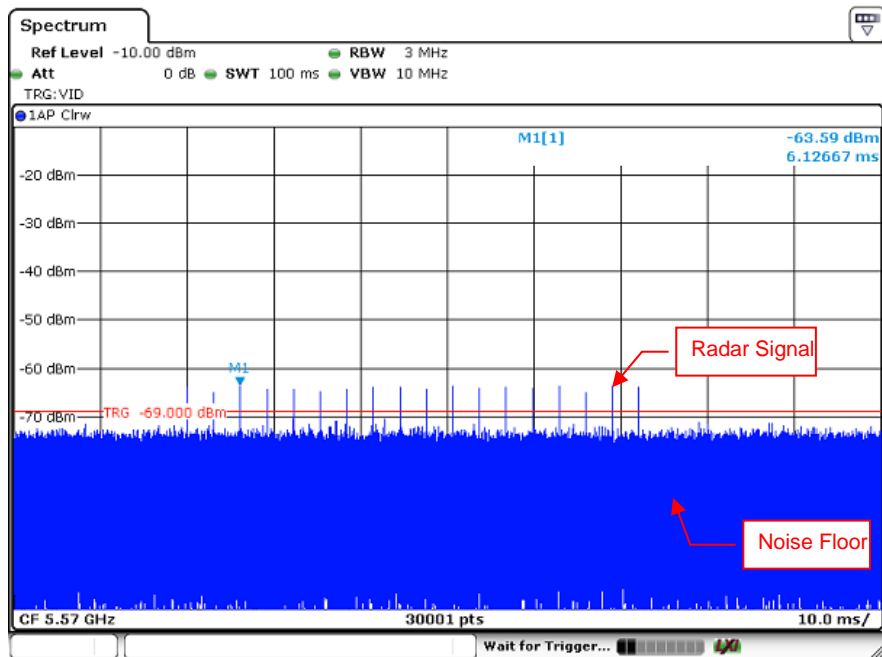

Radar Signal 1 (Test B)

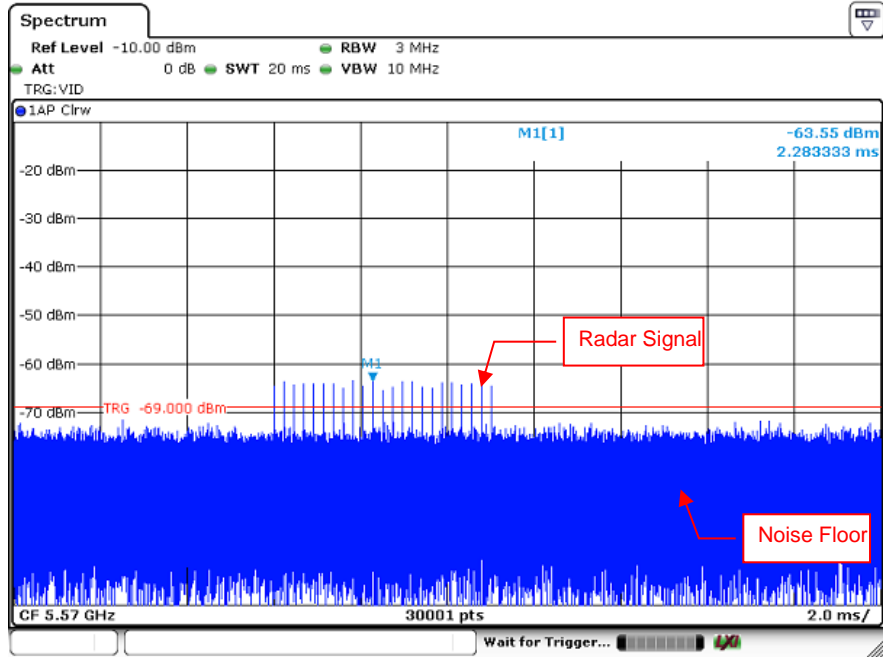

Radar Signal 2

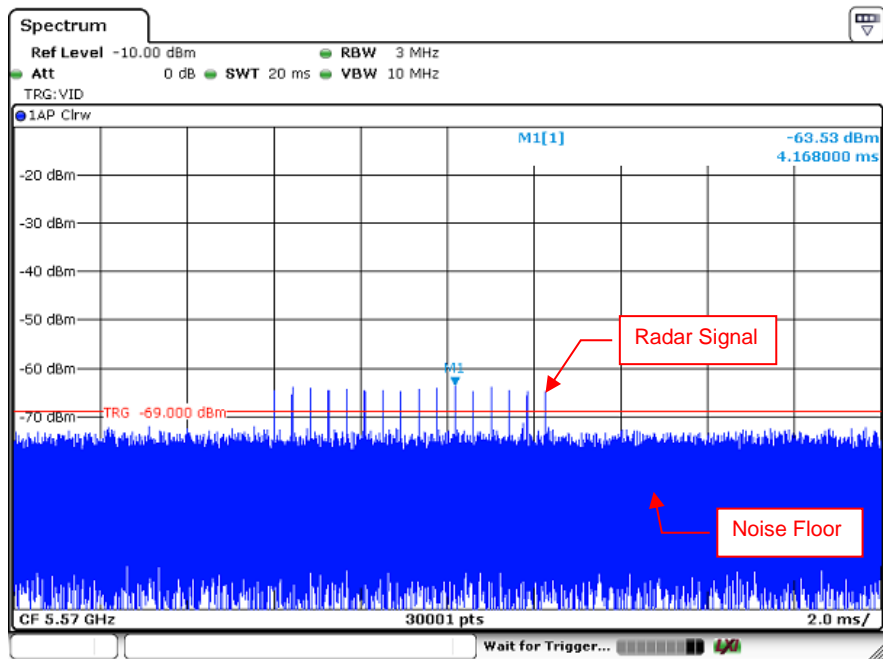

Radar Signal 3

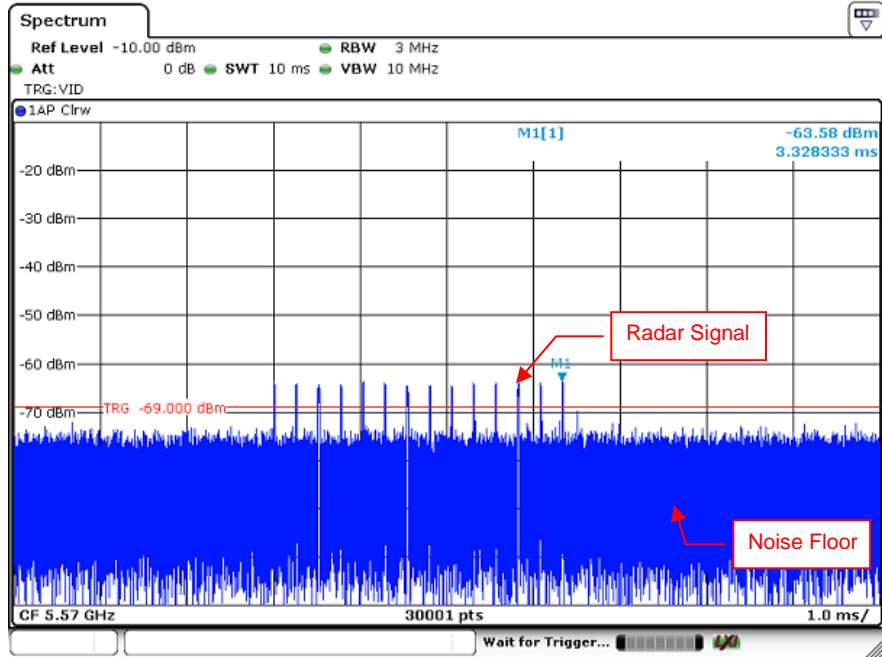

Single Burst of Radar Signal 4

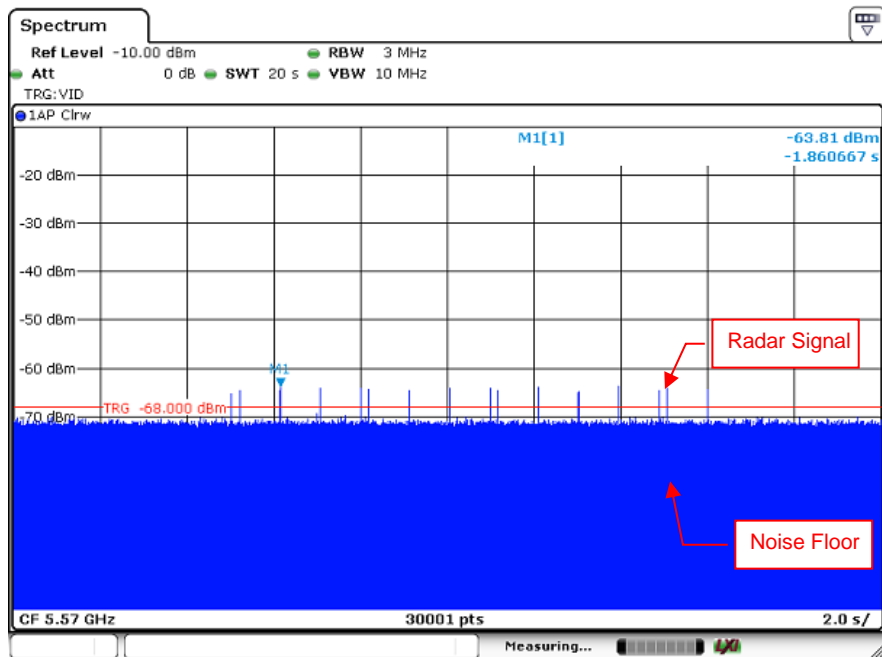

Radar Signal 5

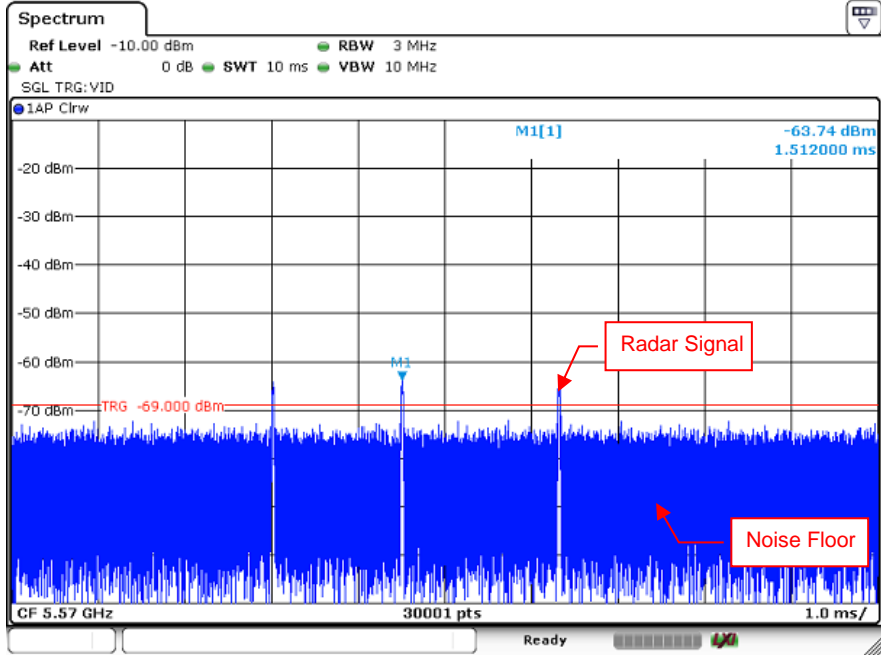

Single Burst of Radar Signal 5

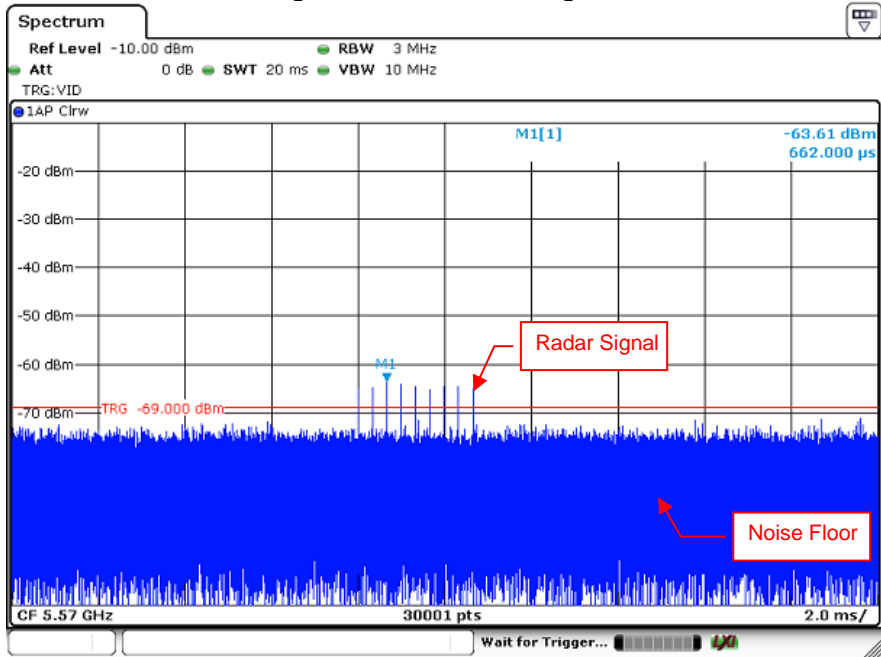

Radar Signal 6

6.2.2 U-NII Detection Bandwidth

802.11ax (HE20)

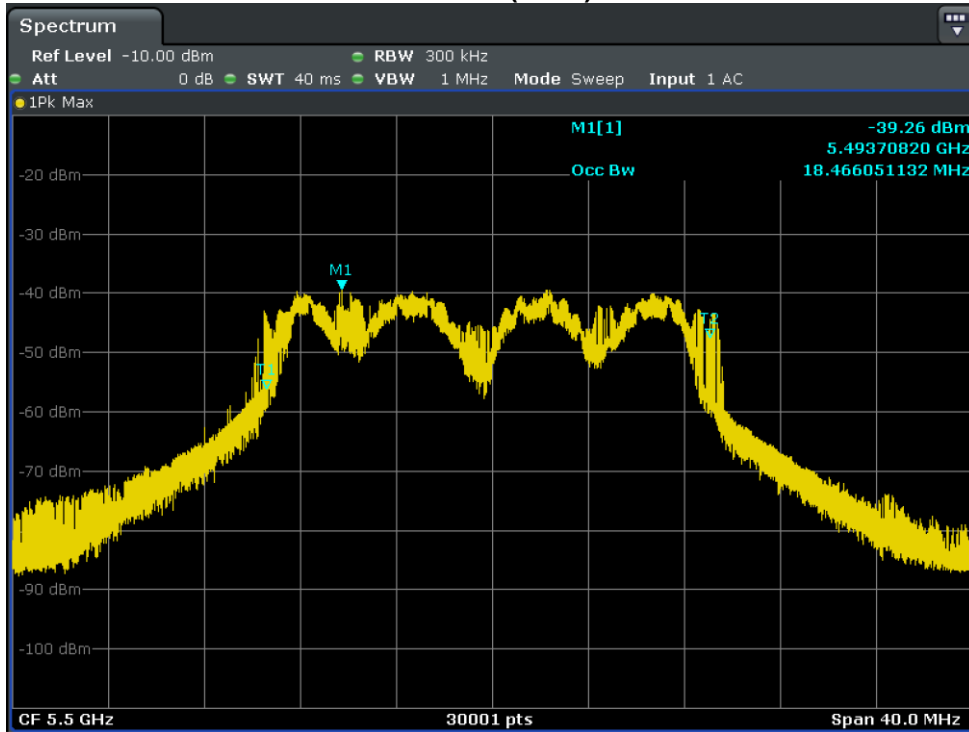

U-NII 99% Channel bandwidth

802.11ax (HE40)

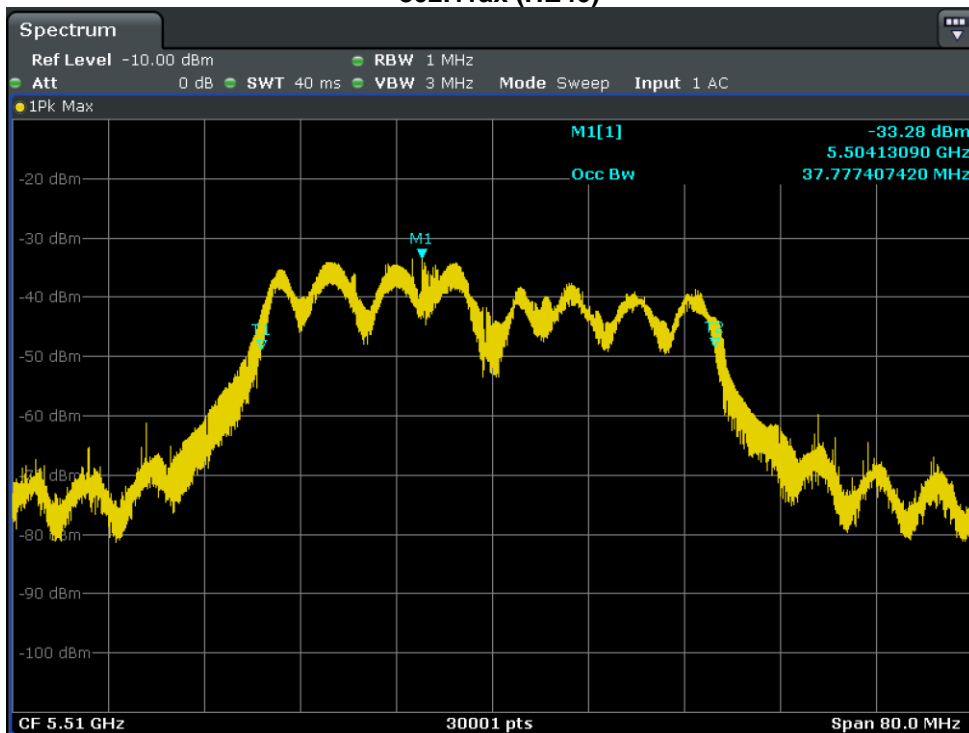

U-NII 99% Channel bandwidth

802.11ax (HE80)

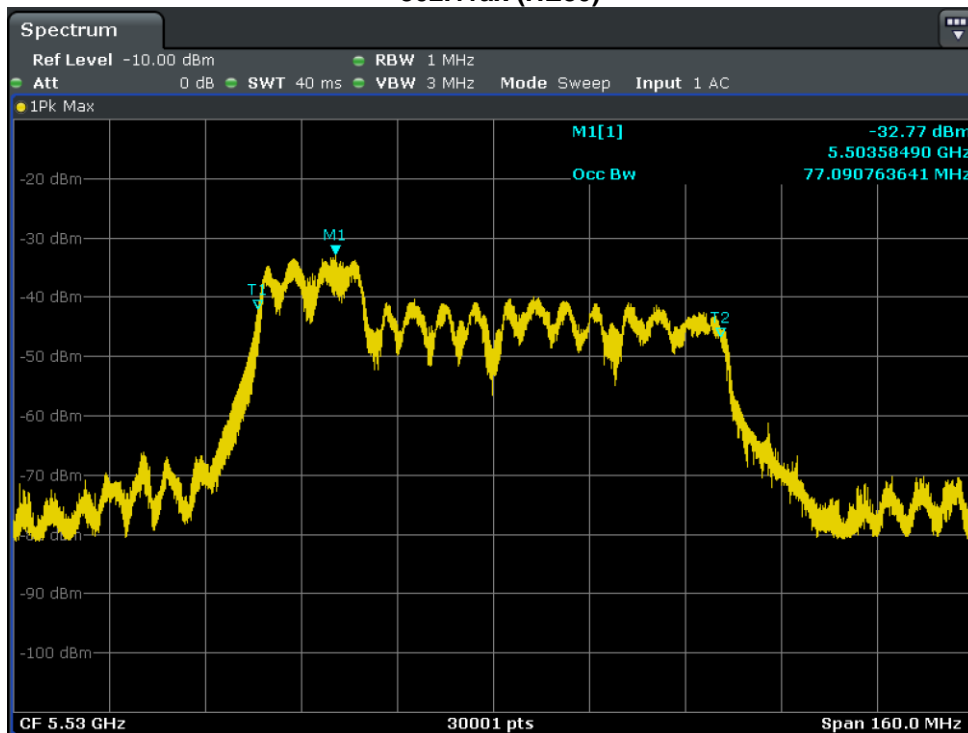

U-NII 99% Channel bandwidth

802.11ax (HE160)

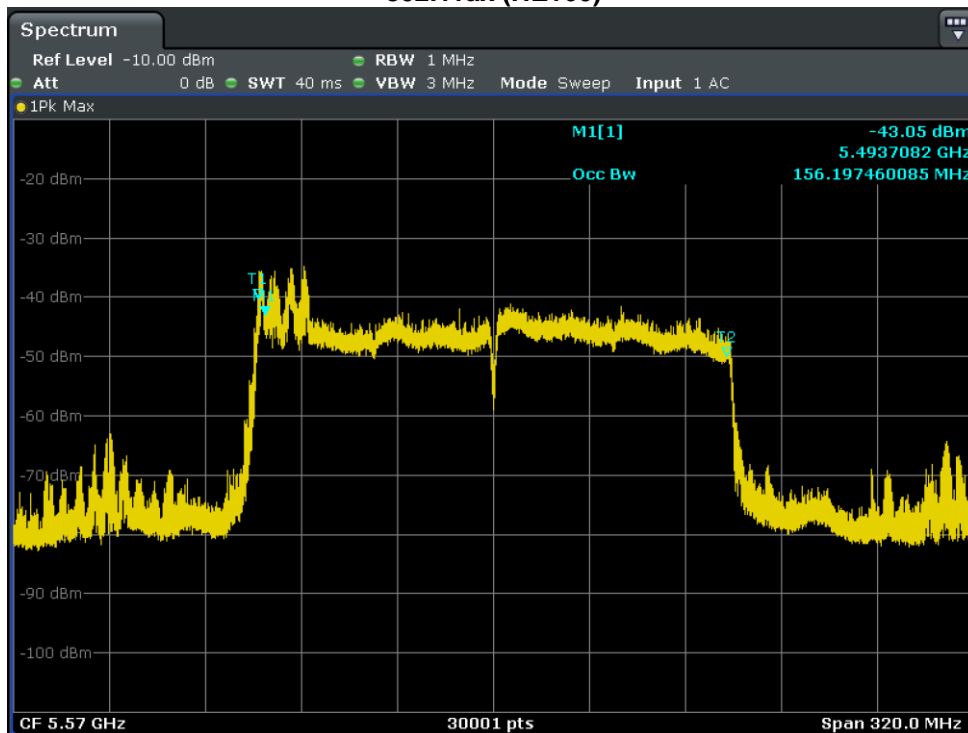

U-NII 99% Channel bandwidth

Detection Bandwidth Test - 802.11ax (HE20)
 Radar Type 0
 EUT Frequency: 5500MHz
 EUT 99% Power bandwidth: 18.466MHz
 Detection bandwidth limit (100% of EUT 99% Power bandwidth): 18.466MHz
 Detection bandwidth (5510(FH) – 5490(FL)) : 20MHz
 Test Result : PASS

Radar Frequency (MHz)	Trial Number / Detection										Detection Rate (%)
	1	2	3	4	5	6	7	8	9	10	
5490(FL)	Yes	Yes	Yes	Yes	Yes	Yes	Yes	Yes	Yes	Yes	100
5491	Yes	Yes	Yes	Yes	Yes	Yes	Yes	Yes	Yes	Yes	100
5492	Yes	Yes	Yes	Yes	Yes	Yes	Yes	Yes	Yes	Yes	100
5493	Yes	Yes	Yes	Yes	Yes	Yes	Yes	Yes	Yes	Yes	100
5494	Yes	Yes	Yes	Yes	Yes	Yes	Yes	Yes	Yes	Yes	100
5495	Yes	Yes	Yes	Yes	Yes	Yes	Yes	Yes	Yes	Yes	100
5496	Yes	Yes	Yes	Yes	Yes	Yes	Yes	Yes	Yes	Yes	100
5497	Yes	Yes	Yes	Yes	Yes	Yes	Yes	Yes	Yes	Yes	100
5498	Yes	Yes	Yes	Yes	Yes	Yes	Yes	Yes	Yes	Yes	100
5499	Yes	Yes	Yes	Yes	Yes	Yes	Yes	Yes	No	Yes	90
5500	Yes	Yes	Yes	Yes	Yes	Yes	Yes	Yes	Yes	Yes	100
5501	Yes	Yes	Yes	Yes	Yes	Yes	Yes	Yes	Yes	Yes	100
5502	Yes	Yes	Yes	Yes	Yes	Yes	Yes	Yes	Yes	Yes	100
5503	Yes	Yes	Yes	Yes	Yes	Yes	Yes	Yes	Yes	Yes	100
5504	Yes	Yes	Yes	Yes	Yes	Yes	Yes	Yes	Yes	Yes	100
5505	Yes	Yes	Yes	Yes	Yes	Yes	Yes	Yes	Yes	Yes	100
5506	Yes	Yes	Yes	Yes	Yes	Yes	Yes	Yes	Yes	Yes	100
5507	Yes	Yes	Yes	Yes	Yes	Yes	Yes	Yes	Yes	Yes	100
5508	Yes	Yes	Yes	Yes	Yes	Yes	Yes	Yes	Yes	Yes	100
5509	Yes	Yes	Yes	Yes	Yes	Yes	Yes	Yes	Yes	Yes	100
5510(FH)	Yes	Yes	Yes	Yes	Yes	Yes	Yes	Yes	Yes	Yes	100



Detection Bandwidth Test - **802.11ax (HE40)**
 Radar Type 0
 EUT Frequency: 5510MHz
 EUT 99% Power bandwidth: 37.777MHz
 Detection bandwidth limit (100% of EUT 99% Power bandwidth): 37.777MHz
 Detection bandwidth (5529(FH) – 5491(FL)) : 38MHz
 Test Result : PASS

Radar Frequency (MHz)	Trial Number / Detection										Detection Rate (%)
	1	2	3	4	5	6	7	8	9	10	
5491(FL)	Yes	Yes	Yes	Yes	Yes	Yes	Yes	Yes	Yes	Yes	100
5492	Yes	Yes	Yes	Yes	Yes	Yes	Yes	Yes	Yes	Yes	100
5493	Yes	Yes	Yes	Yes	Yes	Yes	Yes	Yes	Yes	Yes	100
5494	Yes	Yes	Yes	Yes	Yes	Yes	Yes	Yes	Yes	Yes	100
5495	Yes	Yes	Yes	Yes	Yes	Yes	Yes	Yes	Yes	Yes	100
5496	Yes	Yes	Yes	Yes	Yes	Yes	Yes	Yes	Yes	Yes	100
5497	Yes	Yes	Yes	Yes	Yes	Yes	Yes	Yes	Yes	Yes	100
5498	Yes	Yes	Yes	Yes	Yes	Yes	Yes	Yes	Yes	Yes	100
5499	Yes	Yes	Yes	Yes	Yes	Yes	Yes	Yes	Yes	Yes	100
5500	Yes	Yes	Yes	Yes	Yes	Yes	Yes	Yes	Yes	Yes	100
5501	Yes	Yes	Yes	Yes	Yes	Yes	Yes	Yes	Yes	Yes	100
5502	Yes	Yes	Yes	Yes	Yes	Yes	Yes	Yes	Yes	Yes	100
5503	Yes	Yes	Yes	Yes	Yes	Yes	Yes	Yes	Yes	Yes	100
5504	Yes	Yes	Yes	Yes	Yes	Yes	Yes	Yes	Yes	Yes	100
5505	Yes	Yes	Yes	Yes	Yes	Yes	Yes	Yes	Yes	Yes	100
5506	Yes	Yes	Yes	Yes	Yes	Yes	Yes	Yes	Yes	Yes	100
5507	Yes	Yes	Yes	Yes	Yes	Yes	Yes	Yes	Yes	Yes	100
5508	Yes	Yes	Yes	Yes	Yes	Yes	Yes	Yes	Yes	Yes	100
5509	Yes	Yes	Yes	Yes	Yes	Yes	Yes	Yes	Yes	Yes	100
5510	Yes	Yes	Yes	Yes	Yes	Yes	Yes	Yes	Yes	Yes	100
5511	Yes	Yes	Yes	Yes	Yes	Yes	Yes	Yes	Yes	Yes	100
5512	Yes	Yes	Yes	Yes	Yes	Yes	Yes	Yes	Yes	Yes	100
5513	Yes	Yes	Yes	Yes	Yes	Yes	Yes	Yes	Yes	Yes	100
5514	Yes	Yes	Yes	Yes	Yes	Yes	Yes	Yes	Yes	Yes	100
5515	Yes	Yes	Yes	Yes	Yes	Yes	Yes	Yes	Yes	Yes	100
5516	Yes	Yes	Yes	Yes	Yes	Yes	Yes	Yes	Yes	Yes	100
5517	Yes	Yes	Yes	Yes	Yes	Yes	Yes	Yes	Yes	Yes	100
5518	Yes	Yes	Yes	Yes	Yes	Yes	Yes	Yes	Yes	Yes	100
5519	Yes	Yes	Yes	Yes	Yes	Yes	Yes	Yes	Yes	Yes	100
5520	Yes	Yes	Yes	Yes	Yes	Yes	Yes	Yes	Yes	Yes	100
5521	Yes	Yes	Yes	Yes	Yes	Yes	Yes	Yes	Yes	Yes	100
5522	Yes	Yes	Yes	Yes	Yes	Yes	Yes	Yes	Yes	Yes	100
5523	Yes	Yes	Yes	Yes	Yes	Yes	Yes	Yes	Yes	Yes	100
5524	Yes	Yes	Yes	Yes	Yes	Yes	Yes	Yes	Yes	Yes	100
5525	Yes	Yes	Yes	Yes	Yes	Yes	Yes	Yes	Yes	Yes	100
5526	Yes	Yes	Yes	Yes	Yes	Yes	Yes	Yes	Yes	Yes	100
5527	Yes	Yes	Yes	Yes	Yes	Yes	Yes	Yes	Yes	Yes	100
5528	Yes	Yes	Yes	Yes	Yes	Yes	Yes	Yes	Yes	Yes	100
5529(FH)	Yes	Yes	Yes	Yes	No	Yes	Yes	Yes	Yes	Yes	90

Detection Bandwidth Test - **802.11ax (HE80)**
 Radar Type 0
 EUT Frequency: 5530MHz
 EUT 99% Power bandwidth: 77.09MHz
 Detection bandwidth limit (100% of EUT 99% Power bandwidth): 77.09MHz
 Detection bandwidth (5569(FH) – 5491(FL)) : 78MHz
 Test Result : PASS

Radar Frequency (MHz)	Trial Number / Detection										Detection Rate (%)
	1	2	3	4	5	6	7	8	9	10	
5491(FL)	Yes	Yes	Yes	Yes	Yes	Yes	Yes	Yes	Yes	Yes	100
5492	Yes	Yes	Yes	Yes	Yes	Yes	Yes	Yes	Yes	Yes	100
5493	Yes	Yes	Yes	Yes	Yes	Yes	Yes	Yes	Yes	Yes	100
5494	Yes	Yes	Yes	Yes	Yes	Yes	Yes	Yes	Yes	Yes	100
5495	Yes	Yes	Yes	Yes	Yes	Yes	Yes	Yes	Yes	Yes	100
5496	Yes	Yes	Yes	Yes	Yes	Yes	Yes	Yes	Yes	Yes	100
5497	Yes	Yes	Yes	Yes	Yes	Yes	Yes	Yes	Yes	Yes	100
5498	Yes	Yes	Yes	Yes	Yes	Yes	Yes	Yes	Yes	Yes	100
5499	Yes	Yes	Yes	Yes	Yes	Yes	Yes	Yes	Yes	Yes	100
5500	Yes	Yes	Yes	Yes	Yes	Yes	Yes	Yes	Yes	Yes	100
5501	Yes	Yes	Yes	Yes	Yes	Yes	Yes	Yes	Yes	Yes	100
5502	Yes	Yes	Yes	Yes	Yes	Yes	Yes	Yes	Yes	Yes	100
5503	Yes	Yes	Yes	Yes	Yes	Yes	Yes	Yes	Yes	Yes	100
5504	Yes	Yes	Yes	Yes	Yes	Yes	Yes	Yes	Yes	Yes	100
5505	Yes	Yes	Yes	Yes	Yes	Yes	Yes	Yes	Yes	Yes	100
5506	Yes	Yes	Yes	Yes	Yes	Yes	Yes	Yes	Yes	Yes	100
5507	Yes	Yes	Yes	Yes	Yes	Yes	Yes	Yes	Yes	Yes	100
5508	Yes	Yes	Yes	Yes	Yes	Yes	Yes	Yes	Yes	Yes	100
5509	Yes	Yes	Yes	Yes	Yes	Yes	Yes	Yes	Yes	Yes	100
5510	Yes	Yes	Yes	Yes	Yes	Yes	Yes	Yes	Yes	Yes	100
5511	Yes	Yes	Yes	Yes	Yes	Yes	Yes	Yes	Yes	Yes	100
5512	Yes	Yes	Yes	Yes	Yes	Yes	Yes	Yes	Yes	Yes	100
5513	Yes	Yes	Yes	Yes	Yes	Yes	Yes	Yes	Yes	Yes	100
5514	Yes	Yes	Yes	Yes	Yes	Yes	Yes	Yes	Yes	Yes	100
5515	Yes	Yes	Yes	Yes	Yes	Yes	Yes	Yes	Yes	Yes	100
5516	Yes	Yes	Yes	Yes	Yes	Yes	Yes	Yes	Yes	Yes	100
5517	Yes	Yes	Yes	Yes	Yes	Yes	Yes	Yes	Yes	Yes	100
5518	Yes	Yes	Yes	Yes	Yes	Yes	Yes	Yes	Yes	Yes	100
5519	Yes	Yes	Yes	Yes	Yes	Yes	Yes	Yes	Yes	Yes	100
5520	Yes	Yes	Yes	Yes	Yes	Yes	Yes	Yes	Yes	Yes	100
5521	Yes	Yes	Yes	Yes	Yes	Yes	Yes	Yes	Yes	Yes	100
5522	Yes	Yes	Yes	Yes	Yes	Yes	Yes	Yes	Yes	Yes	100
5523	Yes	Yes	Yes	Yes	Yes	Yes	Yes	Yes	Yes	Yes	100
5524	Yes	Yes	Yes	Yes	Yes	Yes	Yes	Yes	Yes	Yes	100
5525	Yes	Yes	Yes	Yes	Yes	Yes	Yes	Yes	Yes	Yes	100
5526	Yes	Yes	Yes	Yes	Yes	Yes	Yes	Yes	Yes	Yes	100
5527	Yes	Yes	Yes	Yes	Yes	Yes	Yes	Yes	Yes	Yes	100
5528	Yes	Yes	Yes	Yes	Yes	Yes	Yes	Yes	Yes	Yes	100
5529	Yes	Yes	Yes	Yes	Yes	Yes	Yes	Yes	Yes	Yes	100
5530	Yes	Yes	Yes	Yes	Yes	Yes	Yes	Yes	Yes	Yes	100
5531	Yes	Yes	Yes	Yes	Yes	Yes	Yes	Yes	Yes	Yes	100
5532	Yes	Yes	Yes	Yes	Yes	Yes	Yes	Yes	Yes	Yes	100
5533	Yes	Yes	Yes	Yes	Yes	Yes	Yes	Yes	Yes	Yes	100
5534	Yes	Yes	Yes	Yes	Yes	Yes	Yes	Yes	Yes	Yes	100
5535	Yes	Yes	Yes	Yes	Yes	Yes	Yes	Yes	Yes	Yes	100
5536	Yes	Yes	Yes	Yes	Yes	Yes	Yes	Yes	Yes	Yes	100



5537	Yes	Yes	Yes	Yes	Yes	Yes	Yes	Yes	Yes	Yes	100
5538	Yes	Yes	Yes	Yes	Yes	Yes	Yes	Yes	Yes	Yes	100
5539	Yes	Yes	Yes	Yes	Yes	Yes	Yes	Yes	Yes	Yes	100
5540	Yes	Yes	Yes	Yes	Yes	Yes	Yes	Yes	Yes	Yes	100
5541	Yes	Yes	Yes	Yes	Yes	Yes	Yes	Yes	Yes	Yes	100
5542	Yes	Yes	Yes	Yes	Yes	Yes	Yes	Yes	Yes	Yes	100
5543	Yes	Yes	Yes	Yes	Yes	Yes	Yes	Yes	Yes	Yes	100
5544	Yes	No	Yes	Yes	Yes	Yes	Yes	Yes	Yes	Yes	90
5545	Yes	Yes	Yes	Yes	Yes	Yes	Yes	Yes	Yes	Yes	100
5546	Yes	Yes	Yes	Yes	Yes	Yes	Yes	Yes	Yes	Yes	100
5547	Yes	Yes	Yes	Yes	Yes	Yes	Yes	Yes	Yes	Yes	100
5548	Yes	Yes	Yes	Yes	Yes	Yes	Yes	Yes	Yes	Yes	100
5549	Yes	Yes	Yes	Yes	Yes	Yes	Yes	Yes	Yes	Yes	100
5550	Yes	Yes	Yes	Yes	Yes	Yes	Yes	Yes	Yes	Yes	100
5551	Yes	Yes	Yes	Yes	Yes	Yes	Yes	Yes	Yes	Yes	100
5552	Yes	Yes	Yes	Yes	Yes	Yes	Yes	Yes	Yes	Yes	100
5553	Yes	Yes	Yes	Yes	Yes	Yes	Yes	Yes	Yes	Yes	100
5554	Yes	Yes	Yes	Yes	Yes	Yes	Yes	Yes	Yes	Yes	100
5555	Yes	Yes	Yes	Yes	Yes	Yes	Yes	Yes	Yes	Yes	100
5556	Yes	Yes	Yes	Yes	Yes	Yes	Yes	Yes	Yes	Yes	100
5557	Yes	Yes	Yes	Yes	Yes	Yes	Yes	Yes	Yes	Yes	100
5558	Yes	Yes	Yes	Yes	Yes	Yes	Yes	Yes	Yes	Yes	100
5559	Yes	Yes	Yes	Yes	Yes	Yes	Yes	Yes	Yes	Yes	100
5560	Yes	Yes	Yes	Yes	Yes	Yes	Yes	Yes	Yes	Yes	100
5561	Yes	Yes	Yes	Yes	Yes	Yes	Yes	Yes	Yes	Yes	100
5562	Yes	Yes	Yes	Yes	Yes	Yes	Yes	Yes	Yes	Yes	100
5563	Yes	Yes	Yes	Yes	Yes	Yes	Yes	Yes	Yes	Yes	100
5564	Yes	Yes	Yes	Yes	Yes	Yes	Yes	Yes	Yes	Yes	100
5565	Yes	Yes	Yes	Yes	Yes	Yes	Yes	Yes	Yes	Yes	100
5566	Yes	Yes	Yes	Yes	Yes	Yes	Yes	Yes	Yes	Yes	100
5567	Yes	Yes	Yes	Yes	Yes	Yes	Yes	Yes	Yes	Yes	100
5568	Yes	Yes	Yes	Yes	Yes	Yes	Yes	Yes	Yes	Yes	100
5569(FH)	Yes	Yes	Yes	Yes	Yes	Yes	Yes	Yes	No	Yes	90



Detection Bandwidth Test - **802.11ax (HE160)**
 Radar Type 0
 EUT Frequency: 5570MHz
 EUT 99% Power bandwidth: 156.197MHz
 Detection bandwidth limit (100% of EUT 99% Power bandwidth): 156.197MHz
 Detection bandwidth (5649(FH) – 5491(FL)) : 158MHz
 Test Result : PASS

Radar Frequency (MHz)	Trial Number / Detection										Detection Rate (%)
	1	2	3	4	5	6	7	8	9	10	
5491(FL)	Yes	Yes	Yes	Yes	Yes	Yes	Yes	Yes	Yes	Yes	100
5492	Yes	Yes	Yes	Yes	Yes	Yes	Yes	Yes	Yes	Yes	100
5493	Yes	Yes	Yes	Yes	Yes	Yes	Yes	Yes	Yes	Yes	100
5494	Yes	Yes	Yes	Yes	Yes	Yes	Yes	Yes	Yes	Yes	100
5495	Yes	Yes	Yes	Yes	Yes	Yes	Yes	Yes	Yes	Yes	100
5496	Yes	Yes	Yes	Yes	Yes	Yes	Yes	Yes	Yes	Yes	100
5497	Yes	Yes	Yes	Yes	Yes	Yes	Yes	Yes	Yes	Yes	100
5498	Yes	Yes	Yes	Yes	Yes	Yes	Yes	Yes	Yes	Yes	100
5499	Yes	Yes	Yes	Yes	Yes	Yes	Yes	Yes	Yes	Yes	100
5500	Yes	Yes	Yes	Yes	Yes	Yes	Yes	Yes	Yes	Yes	100
5501	Yes	Yes	Yes	Yes	Yes	Yes	Yes	Yes	Yes	Yes	100
5502	Yes	Yes	Yes	Yes	Yes	Yes	Yes	Yes	Yes	Yes	100
5503	Yes	Yes	Yes	Yes	Yes	Yes	Yes	Yes	Yes	Yes	100
5504	Yes	Yes	Yes	Yes	Yes	Yes	Yes	Yes	Yes	Yes	100
5505	Yes	Yes	Yes	Yes	Yes	Yes	Yes	Yes	Yes	Yes	100
5506	Yes	Yes	Yes	Yes	Yes	Yes	Yes	Yes	Yes	Yes	100
5507	Yes	Yes	Yes	Yes	Yes	Yes	Yes	Yes	Yes	Yes	100
5508	Yes	Yes	Yes	Yes	Yes	Yes	Yes	Yes	Yes	Yes	100
5509	Yes	Yes	Yes	Yes	Yes	Yes	Yes	Yes	Yes	Yes	100
5510	Yes	Yes	Yes	Yes	Yes	Yes	Yes	Yes	Yes	Yes	100
5511	Yes	Yes	Yes	Yes	Yes	Yes	Yes	Yes	Yes	Yes	100
5512	Yes	Yes	Yes	Yes	Yes	Yes	Yes	Yes	Yes	Yes	100
5513	Yes	Yes	Yes	Yes	Yes	Yes	Yes	Yes	Yes	Yes	100
5514	Yes	Yes	Yes	Yes	Yes	Yes	Yes	Yes	Yes	Yes	100
5515	Yes	Yes	Yes	Yes	Yes	Yes	Yes	Yes	Yes	Yes	100
5516	Yes	Yes	Yes	Yes	Yes	Yes	Yes	Yes	Yes	Yes	100
5517	Yes	Yes	Yes	Yes	Yes	Yes	Yes	Yes	Yes	Yes	100
5518	Yes	Yes	Yes	Yes	Yes	Yes	Yes	Yes	Yes	Yes	100
5519	Yes	Yes	Yes	Yes	Yes	Yes	Yes	Yes	Yes	Yes	100
5520	Yes	Yes	Yes	Yes	Yes	Yes	Yes	Yes	Yes	Yes	100
5521	Yes	Yes	Yes	Yes	Yes	Yes	Yes	Yes	Yes	Yes	100
5522	Yes	Yes	Yes	Yes	Yes	Yes	Yes	Yes	Yes	Yes	100
5523	Yes	Yes	Yes	Yes	Yes	Yes	Yes	Yes	Yes	Yes	100
5524	Yes	Yes	Yes	Yes	Yes	Yes	Yes	Yes	Yes	Yes	100
5525	Yes	Yes	Yes	Yes	Yes	Yes	Yes	Yes	Yes	Yes	100
5526	Yes	Yes	Yes	Yes	Yes	Yes	Yes	Yes	Yes	Yes	100
5527	Yes	Yes	Yes	Yes	Yes	Yes	Yes	Yes	Yes	Yes	100
5528	Yes	Yes	Yes	Yes	Yes	Yes	Yes	Yes	Yes	Yes	100
5529	Yes	Yes	Yes	Yes	Yes	Yes	Yes	Yes	Yes	Yes	100
5530	Yes	Yes	Yes	Yes	Yes	Yes	Yes	Yes	Yes	Yes	100
5531	Yes	Yes	Yes	Yes	Yes	Yes	Yes	Yes	Yes	Yes	100
5532	Yes	Yes	Yes	Yes	Yes	Yes	Yes	Yes	Yes	Yes	100
5533	Yes	Yes	Yes	Yes	Yes	Yes	Yes	Yes	Yes	Yes	100
5534	Yes	Yes	Yes	Yes	Yes	Yes	Yes	Yes	Yes	Yes	100
5535	Yes	Yes	Yes	Yes	Yes	Yes	Yes	Yes	Yes	Yes	100



5646	Yes	Yes	Yes	Yes	Yes	Yes	Yes	Yes	Yes	Yes	100
5647	Yes	Yes	Yes	Yes	Yes	Yes	Yes	Yes	Yes	Yes	100
5648	Yes	Yes	Yes	Yes	Yes	Yes	Yes	Yes	Yes	Yes	100
5649(FH)	Yes	Yes	Yes	Yes	Yes	Yes	Yes	Yes	Yes	Yes	100

6.2.3 Channel Availability Check Time

If the EUT successfully detected the radar burst, it should be observed as the EUT has no transmissions occurred until the EUT starts transmitting on another channel.

Timing of Radar Signal	Observation	
	EUT	Spectrum Analyzer
Within 1 to 6 second	Detected	No transmissions
Within 54 to 60 second	Detected	No transmissions

Initial Channel Availability Check Time

Channel Availability Check

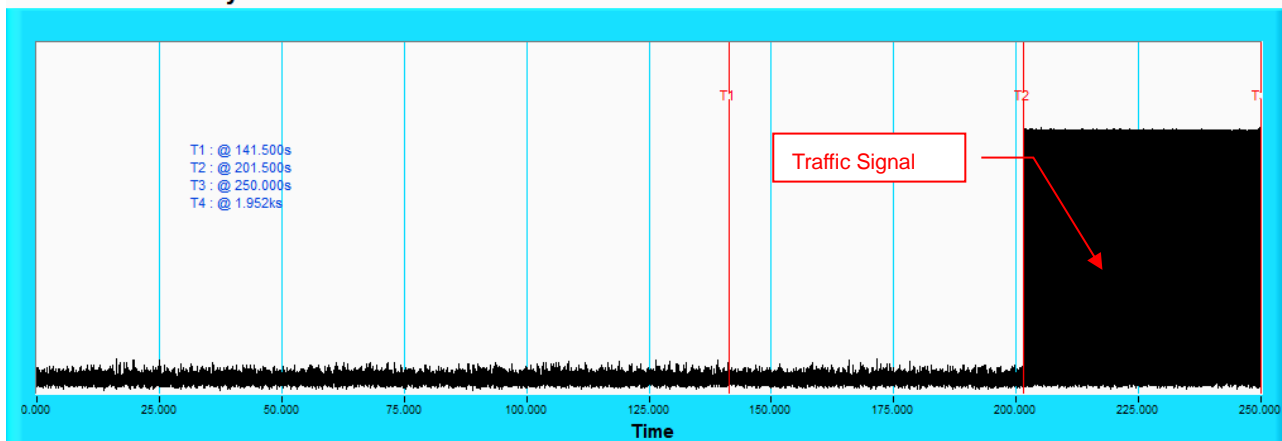

NOTE: T1 denotes the end of power-up time period is 141.5th second. T2 denotes the end of Channel Availability Check time is 201.5th second. Channel Availability Check time is equal to (T2 – T1) 60 seconds.

Radar Burst at the Beginning of the Channel Availability Check Time

Channel Availability Check

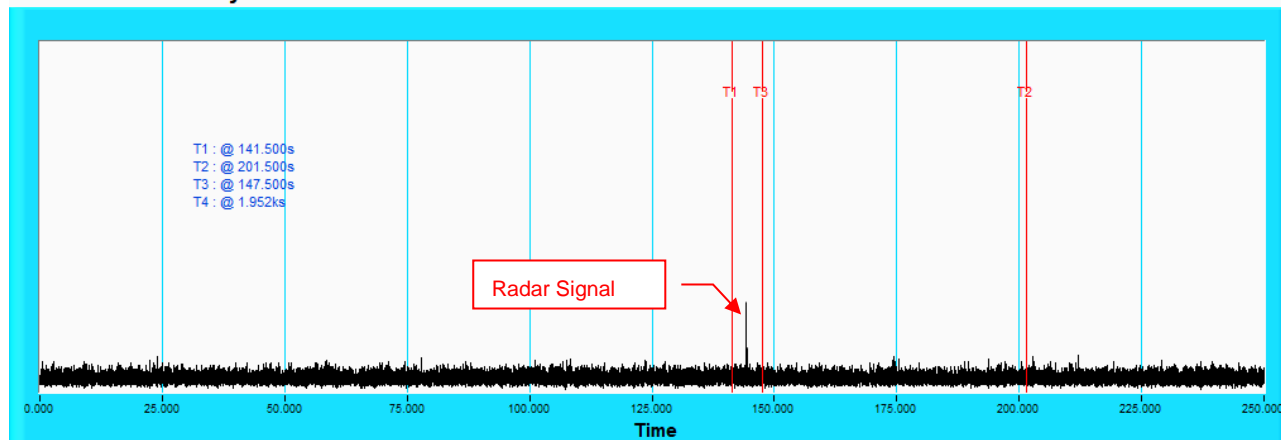

NOTE: T1 denotes the end of power up time period is 141.5th second. T3 denotes 147.5th second and the radar burst was commenced within a 6 second window starting from the end of power-up sequence. T2 denotes the 201.5th second.

Radar Burst at the End of the Channel Availability Check Time

Channel Availability Check

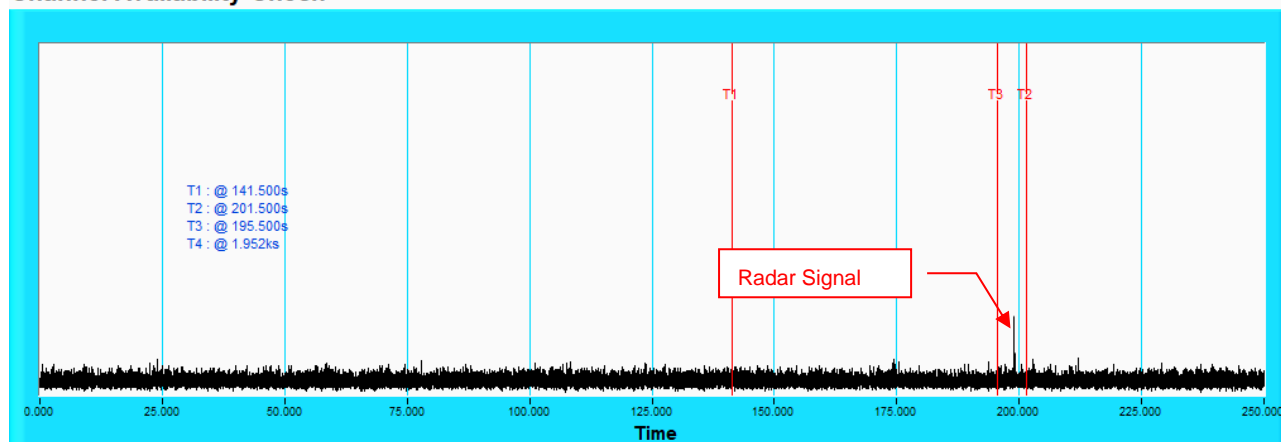

NOTE: T1 denotes the end of power up time period is 141.5th second. T3 denotes 195.5th second and the radar burst was commenced within 54th second to 60th second window starting from the end of power-up sequence. T2 denotes the 201.5th second.

6.2.4 Channel Closing Transmission and Channel Move Time

Wireless Traffic Loading

802.11ax (HE20)

Duty Cycle

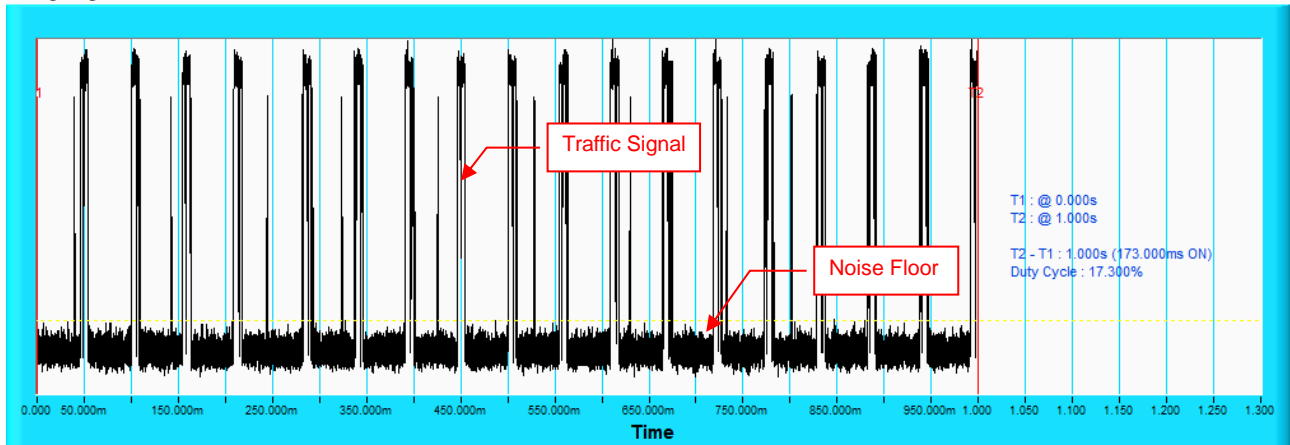

802.11ax (HE40)

Duty Cycle

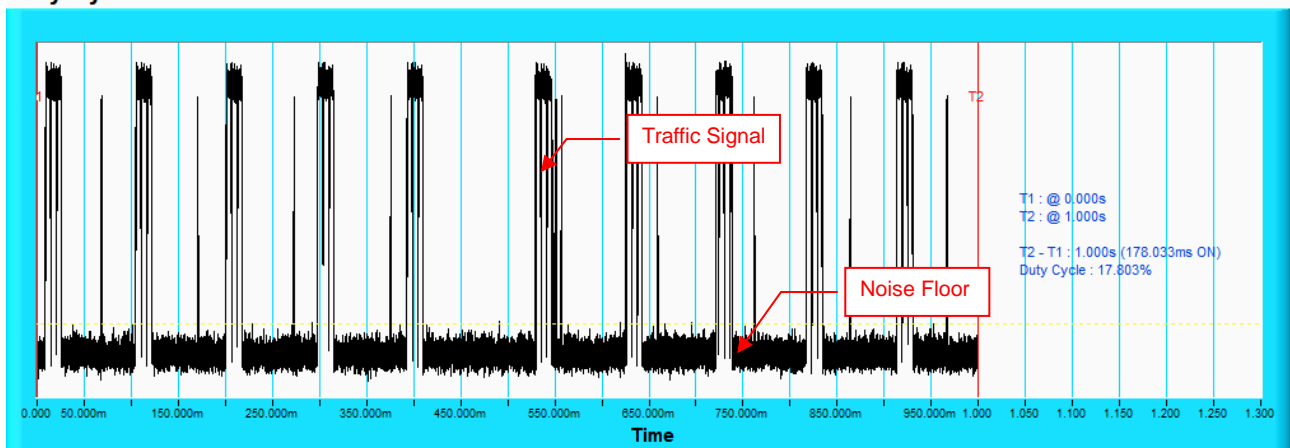

802.11ax (HE80)

Duty Cycle

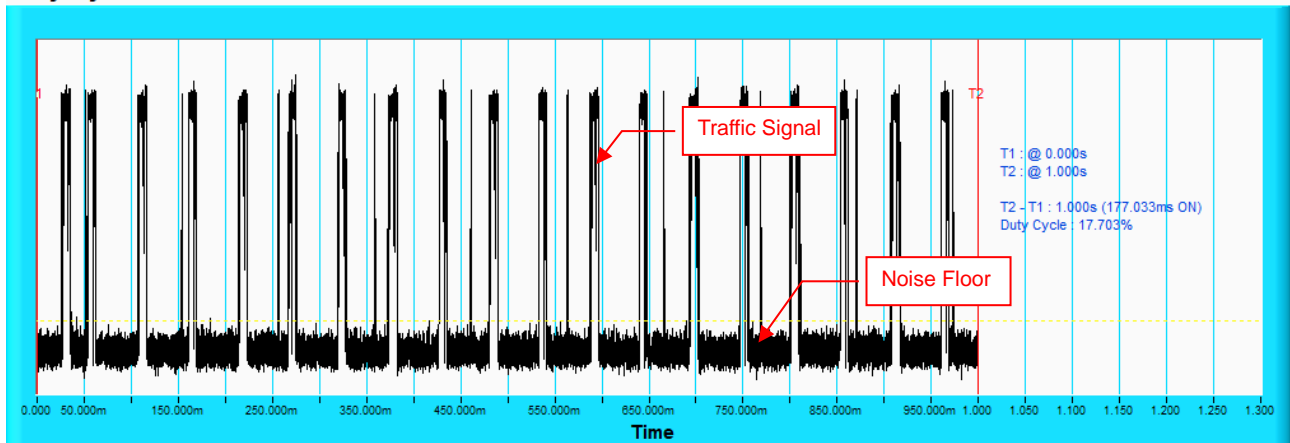



802.11ax (HE160)

Duty Cycle

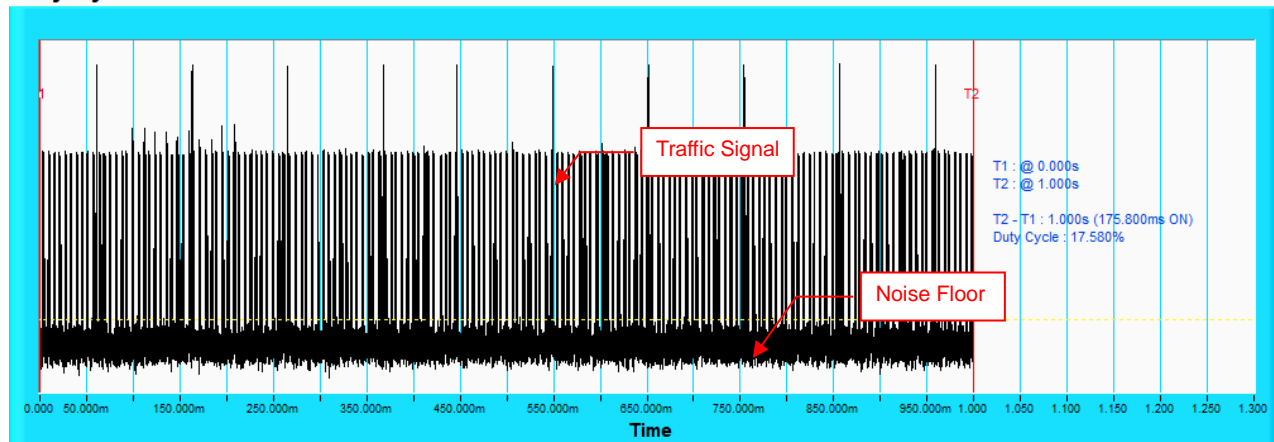

802.11ax (HE20)

Table 1: Short Pulse Radar Test Waveforms

Radar Type	Pulse Width (μsec)	PRI (μsec)	Number of Pulses	Number of Trials(Times)	Percentage of Successful Detection (%)
1	Test A 15 unique PRI values randomly selected from the list of 23 PRI values	Roundup $\left\{ \left(\frac{1}{360} \right) \cdot \left(\frac{19 \cdot 10^6}{\text{PRI}_{\mu\text{sec}}} \right) \right\}$	18	30	90
	15 unique PRI values randomly selected within the range of 518~3066 μsec with a minimum of 1 μsec, excluding PRI values selected in Test A				
2	1-5	150-230	23-29	30	83.3
3	6-10	200-500	16-18	30	76.6
4	11-20	200-500	12-16	30	73.3
Aggregate (Radar Types 1-4)				120	80.8

Table 2: Long Pulse Radar Test Waveform

Radar Type	Pulse Width (μsec)	Chirp Width (MHz)	PRI (μsec)	Number of Pulses per Burst	Number of Bursts	Number of Trials(Times)	Percentage of Successful Detection (%)
5	50-100	5-20	1000-2000	1-3	8-20	30	90

Table 3: Frequency Hopping Radar Test Waveform

Radar Type	Pulse Width (μsec)	PRI (μsec)	Pulses per Hop	Hopping Rate (kHz)	Hopping Sequence Length (msec)	Number of Trials(Times)	Percentage of Successful Detection (%)
6	1	333	9	0.333	300	30	93.3

802.11ax (HE40)

Table 1: Short Pulse Radar Test Waveforms

Radar Type	Pulse Width (μsec)	PRI (μsec)	Number of Pulses	Number of Trials(Times)	Percentage of Successful Detection (%)
1	Test A 15 unique PRI values randomly selected from the list of 23 PRI values	Roundup $\left\{ \left(\frac{1}{360} \right) \cdot \left(\frac{19 \cdot 10^6}{\text{PRI}_{\mu\text{sec}}} \right) \right\}$	18	30	90
	15 unique PRI values randomly selected within the range of 518~3066 μsec with a minimum of 1 μsec, excluding PRI values selected in Test A				
2	1-5	150-230	23-29	30	90
3	6-10	200-500	16-18	30	73.3
4	11-20	200-500	12-16	30	73.3
Aggregate (Radar Types 1-4)				120	81.6

Table 2: Long Pulse Radar Test Waveform

Radar Type	Pulse Width (μsec)	Chirp Width (MHz)	PRI (μsec)	Number of Pulses per Burst	Number of Bursts	Number of Trials(Times)	Percentage of Successful Detection (%)
5	50-100	5-20	1000-2000	1-3	8-20	30	86.6

Table 3: Frequency Hopping Radar Test Waveform

Radar Type	Pulse Width (μsec)	PRI (μsec)	Pulses per Hop	Hopping Rate (kHz)	Hopping Sequence Length (msec)	Number of Trials(Times)	Percentage of Successful Detection (%)
6	1	333	9	0.333	300	30	86.6

802.11ax (HE80)

Table 1: Short Pulse Radar Test Waveforms

Radar Type	Pulse Width (μsec)	PRI (μsec)	Number of Pulses	Number of Trials(Times)	Percentage of Successful Detection (%)
1	Test A 15 unique PRI values randomly selected from the list of 23 PRI values	Roundup $\left\{ \left(\frac{1}{360} \right) \cdot \left(\frac{19 \cdot 10^6}{\text{PRI}_{\mu\text{sec}}} \right) \right\}$	18	30	93.3
	15 unique PRI values randomly selected within the range of 518~3066 μ sec with a minimum of 1 μ sec, excluding PRI values selected in Test A				
2	1-5	150-230	23-29	30	90
3	6-10	200-500	16-18	30	66.6
4	11-20	200-500	12-16	30	80
Aggregate (Radar Types 1-4)				120	82.4

Table 2: Long Pulse Radar Test Waveform

Radar Type	Pulse Width (μsec)	Chirp Width (MHz)	PRI (μsec)	Number of Pulses per Burst	Number of Bursts	Number of Trials(Times)	Percentage of Successful Detection (%)
5	50-100	5-20	1000-2000	1-3	8-20	30	93.3

Table 3: Frequency Hopping Radar Test Waveform

Radar Type	Pulse Width (μsec)	PRI (μsec)	Pulses per Hop	Hopping Rate (kHz)	Hopping Sequence Length (msec)	Number of Trials(Times)	Percentage of Successful Detection (%)
6	1	333	9	0.333	300	30	93.3

802.11ax (HE160)
Table 1: Short Pulse Radar Test Waveforms

Radar Type	Pulse Width (μsec)	PRI (μsec)	Number of Pulses	Number of Trials(Times)	Percentage of Successful Detection (%)
1	Test A 15 unique PRI values randomly selected from the list of 23 PRI values	Roundup $\left\{ \left(\frac{1}{360} \right) \cdot \left(\frac{19 \cdot 10^6}{\text{PRI}_{\mu\text{sec}}} \right) \right\}$	18	30	93.3
	15 unique PRI values randomly selected within the range of 518~3066 μ sec with a minimum of 1 μ sec, excluding PRI values selected in Test A				
2	1-5	150-230	23-29	30	86.6
3	6-10	200-500	16-18	30	70
4	11-20	200-500	12-16	30	76.6
Aggregate (Radar Types 1-4)				120	81.6

Table 2: Long Pulse Radar Test Waveform

Radar Type	Pulse Width (μsec)	Chirp Width (MHz)	PRI (μsec)	Number of Pulses per Burst	Number of Bursts	Number of Trials(Times)	Percentage of Successful Detection (%)
5	50-100	5-20	1000-2000	1-3	8-20	30	80

Table 3: Frequency Hopping Radar Test Waveform

Radar Type	Pulse Width (μsec)	PRI (μsec)	Pulses per Hop	Hopping Rate (kHz)	Hopping Sequence Length (msec)	Number of Trials(Times)	Percentage of Successful Detection (%)
6	1	333	9	0.333	300	30	93.3

802.11ax (HE160)

Radar signal 0

Channel Closing Transmission Time & Channel Move Time

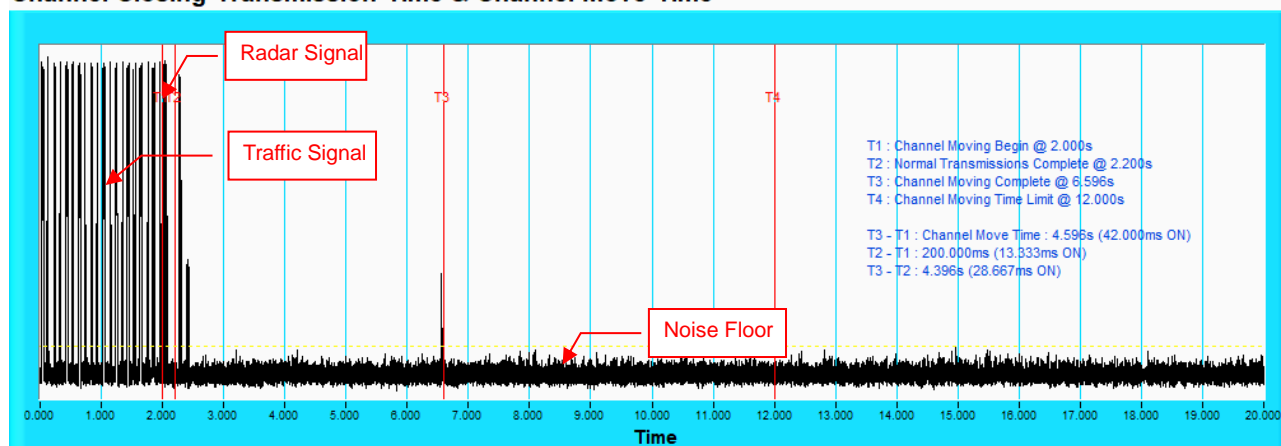

NOTE: T1 denotes the start of Channel Move Time upon the end of the last Radar burst. T2 denotes the data transmission time of 200ms from T1. T3 denotes the end of Channel Move Time. T4 denotes the 10 second from T1 to observe the aggregate duration of transmissions.

Channel Closing Transmission Time & Channel Move Time

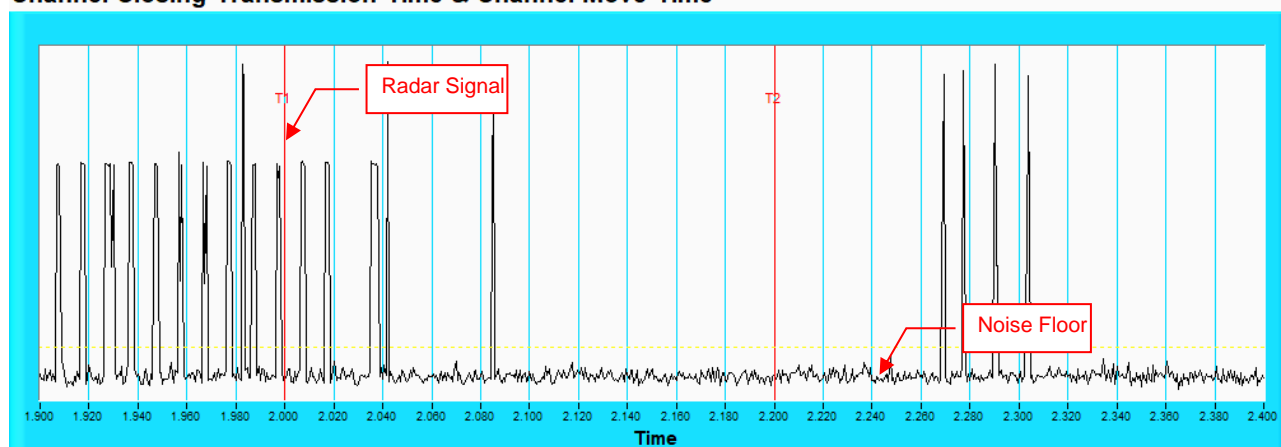

NOTE: Zoom in of the first 500ms after radar signal applied.

Radar signal 1 Channel Closing Transmission Time & Channel Move Time

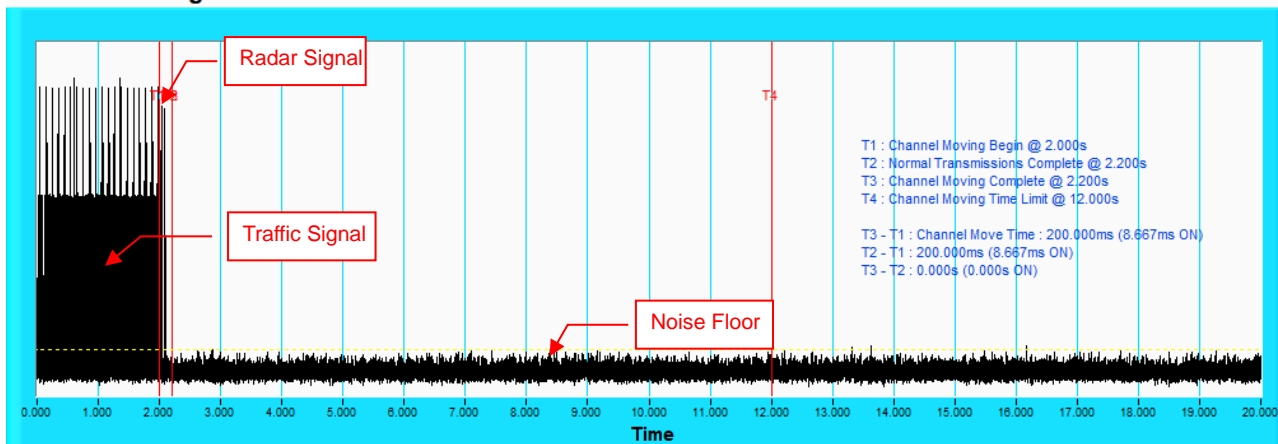

NOTE: T1 denotes the start of Channel Move Time upon the end of the last Radar burst. T2 denotes the data transmission time of 200ms from T1. T3 denotes the end of Channel Move Time. T4 denotes the 10 second from T1 to observe the aggregate duration of transmissions.

Channel Closing Transmission Time & Channel Move Time

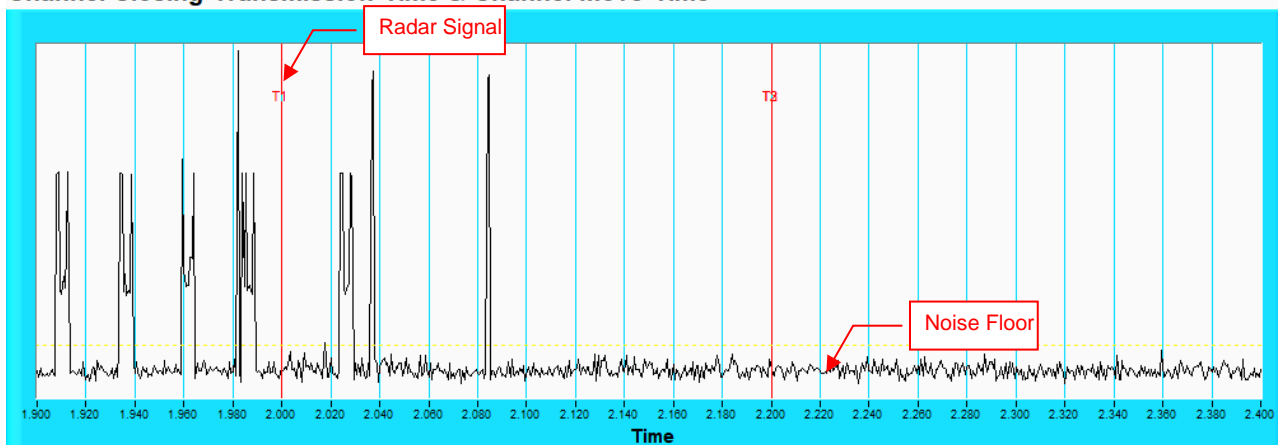

NOTE: Zoom in of the first 500ms after radar signal applied.

Radar signal 2

Channel Closing Transmission Time & Channel Move Time

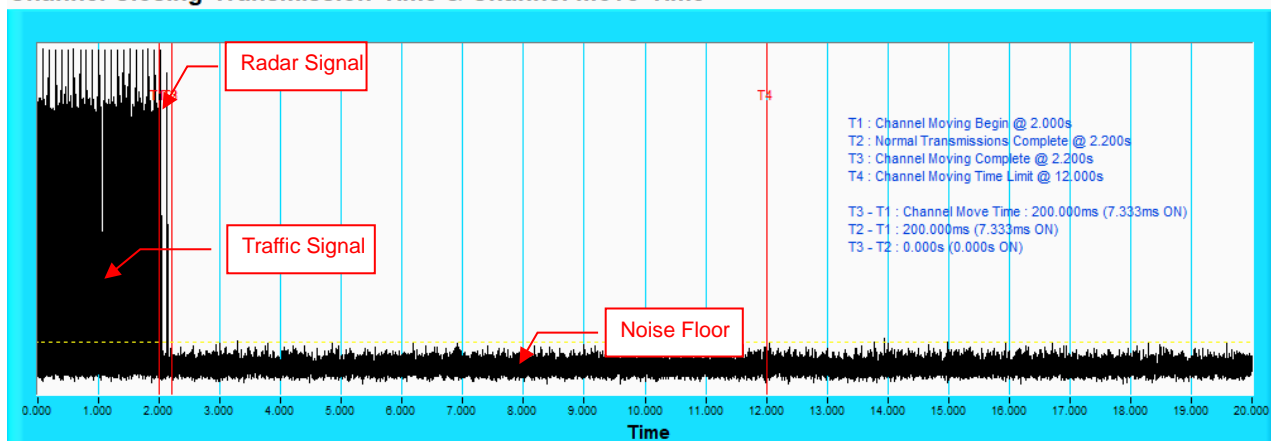

NOTE: T1 denotes the start of Channel Move Time upon the end of the last Radar burst. T2 denotes the data transmission time of 200ms from T1. T3 denotes the end of Channel Move Time. T4 denotes the 10 second from T1 to observe the aggregate duration of transmissions.

Channel Closing Transmission Time & Channel Move Time

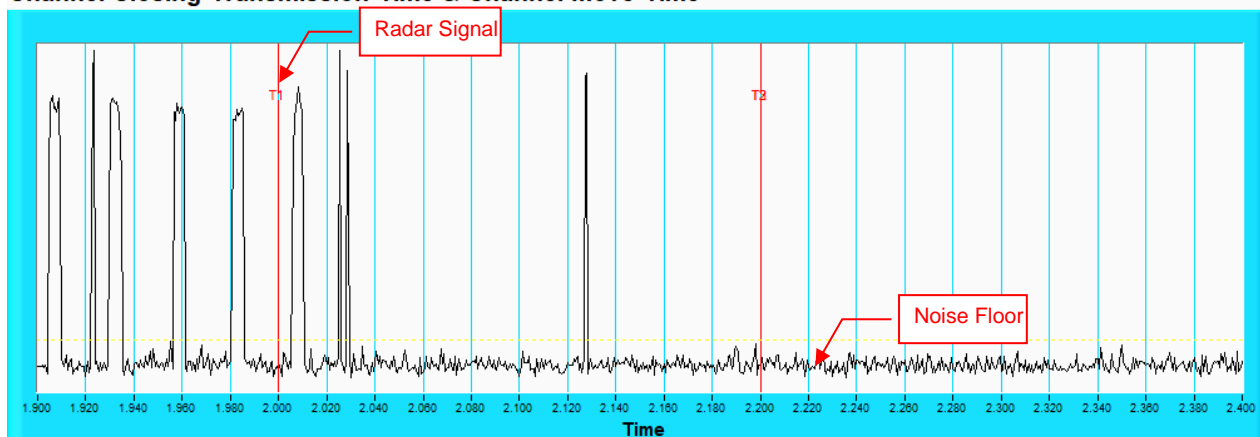

NOTE: Zoom in of the first 500ms after radar signal applied.

Radar signal 3

Channel Closing Transmission Time & Channel Move Time

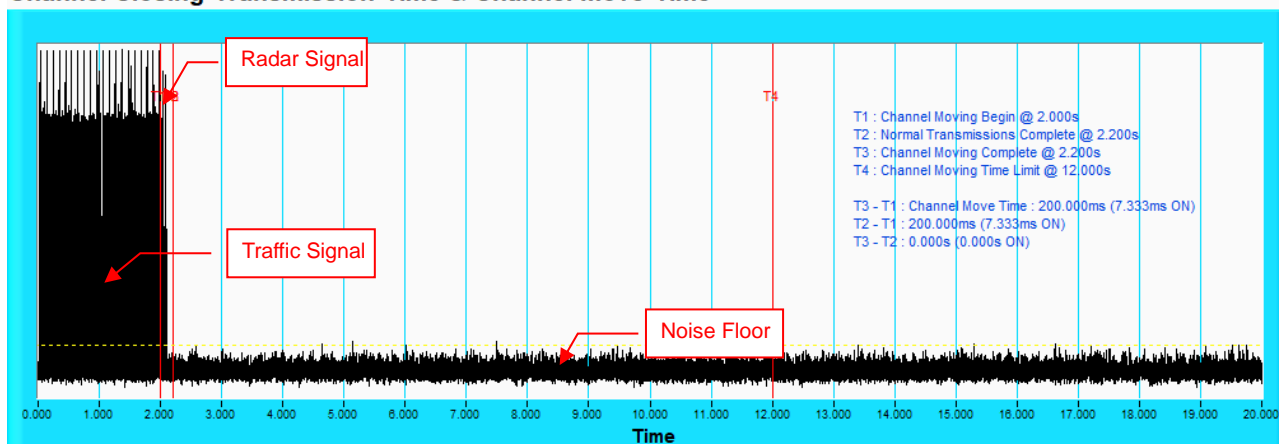

NOTE: T1 denotes the start of Channel Move Time upon the end of the last Radar burst. T2 denotes the data transmission time of 200ms from T1. T3 denotes the end of Channel Move Time. T4 denotes the 10 second from T1 to observe the aggregate duration of transmissions.

Channel Closing Transmission Time & Channel Move Time

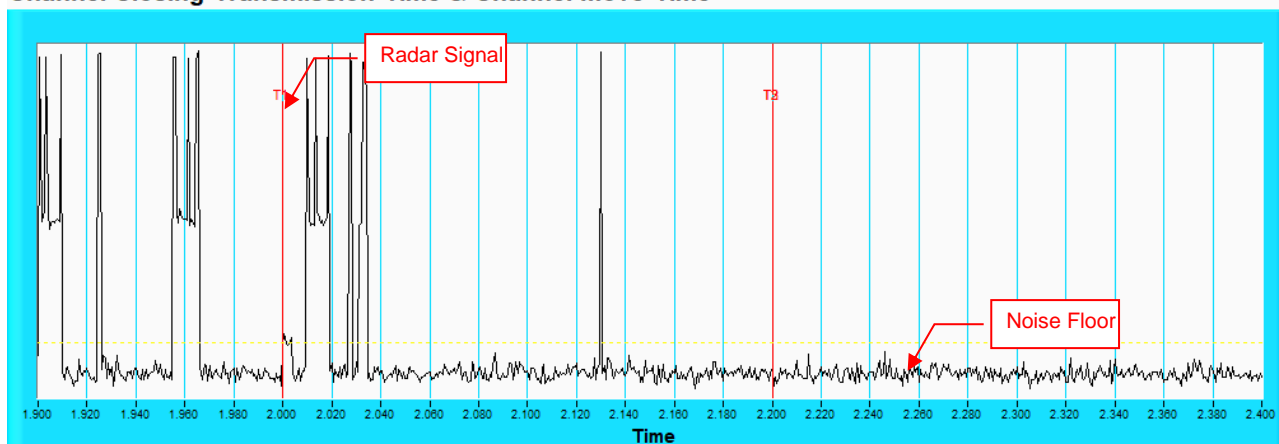

NOTE: Zoom in of the first 500ms after radar signal applied.

Radar signal 4

Channel Closing Transmission Time & Channel Move Time

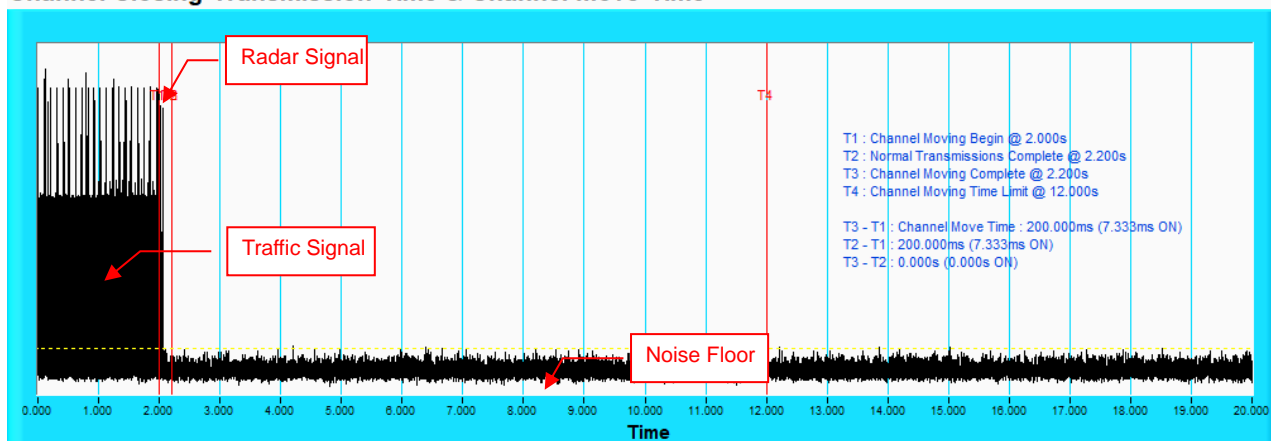

NOTE: T1 denotes the start of Channel Move Time upon the end of the last Radar burst. T2 denotes the data transmission time of 200ms from T1. T3 denotes the end of Channel Move Time. T4 denotes the 10 second from T1 to observe the aggregate duration of transmissions.

Channel Closing Transmission Time & Channel Move Time

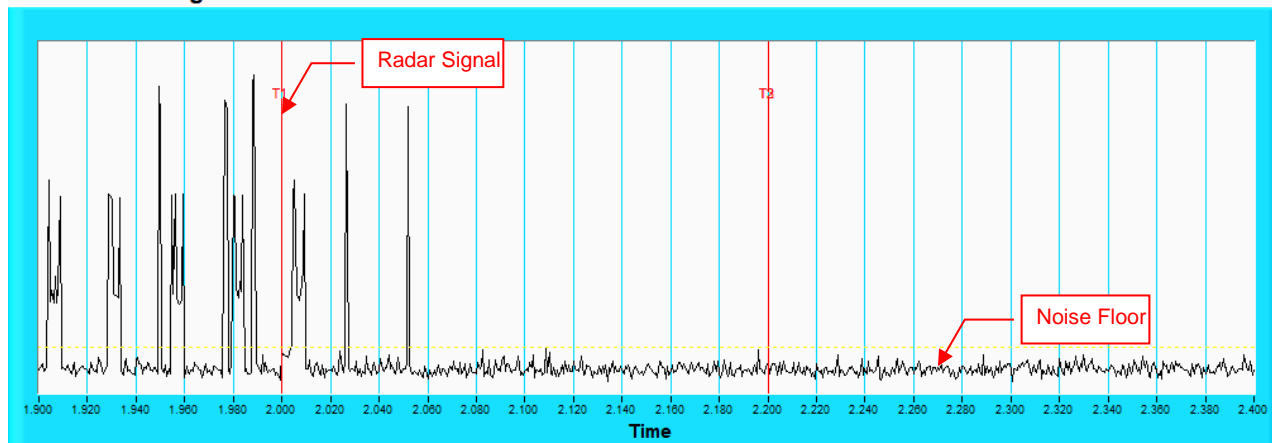

NOTE: Zoom in of the first 500ms after radar signal applied.



802.11ax (HE20)

Type 1 Radar Statistical Performances

Trial #	Test Frequency (MHz)	Pulse Repetition Frequency Number (1 to 23)	Pulse Repetition Frequency (pps)	Pulses per Burst	Pulse Repetition Interval (µsec)	Detection
1	5500	5	1672.2	89	598	Yes
2	5505	21	1089.3	58	918	Yes
3	5497	14	1285.3	68	778	Yes
4	5507	23	326.2	18	3066	Yes
5	5503	10	1432.7	76	698	Yes
6	5499	13	1319.3	70	758	Yes
7	5502	16	1222.5	65	818	Yes
8	5505	15	1253.1	67	798	Yes
9	5492	11	1392.8	74	718	Yes
10	5492	3	1792.1	95	558	Yes
11	5502	22	1066.1	57	938	Yes
12	5498	7	1567.4	83	638	No
13	5499	17	1193.3	63	838	Yes
14	5502	18	1165.6	62	858	Yes
15	5508	9	1474.9	78	678	Yes
16	5504	-	1524.4	81	656	Yes
17	5492	-	749.6	40	1334	No
18	5503	-	1811.6	96	552	Yes
19	5498	-	660.5	35	1514	No
20	5498	-	364.2	20	2746	Yes
21	5505	-	960.6	51	1041	Yes
22	5492	-	344.1	19	2906	Yes
23	5505	-	421.2	23	2374	Yes
24	5508	-	751.3	40	1331	Yes
25	5493	-	513.3	28	1948	Yes
26	5494	-	1026.7	55	974	Yes
27	5508	-	409.3	22	2443	Yes
28	5492	-	557.4	30	1794	Yes
29	5501	-	874.1	47	1144	Yes
30	5500	-	473.5	25	2112	Yes

Detection Rate : 90%

Note. " - " : 15 unique PRI values randomly selected within the range of 518-3066 µsec, with a minimum increment of 1µsec, excluding PRI values selected in Test A

802.11ax (HE20)

Type 2 Radar Statistical Performances					
Trial #	Test Frequency (MHz)	Pulses per Burst	Pulse Width(us)	PRI(us)	Detection
1	5500	28	4.2	228	Yes
2	5501	24	1.6	202	Yes
3	5504	24	1.9	193	Yes
4	5501	29	4.6	189	Yes
5	5503	26	3	167	Yes
6	5499	25	2.6	180	Yes
7	5499	23	1.4	165	Yes
8	5502	29	5	190	Yes
9	5495	23	1.2	168	No
10	5494	26	3	224	No
11	5498	27	3.9	187	No
12	5505	29	5	171	Yes
13	5498	28	4.3	223	Yes
14	5496	26	2.9	216	Yes
15	5495	26	2.9	219	Yes
16	5498	27	3.6	169	No
17	5499	25	2.5	199	Yes
18	5495	26	3	151	Yes
19	5494	25	2.4	198	Yes
20	5505	29	5	207	Yes
21	5501	23	1.5	162	Yes
22	5507	29	5	161	No
23	5508	24	1.8	194	Yes
24	5493	28	4.1	178	Yes
25	5493	24	1.6	170	Yes
26	5496	27	3.4	195	Yes
27	5507	25	2.7	212	Yes
28	5496	24	1.7	196	Yes
29	5502	26	2.8	217	Yes
30	5499	24	1.8	183	Yes
Detection Rate : 83.3%					

802.11ax (HE20)

Type 3 Radar Statistical Performances

Trial #	Test Frequency (MHz)	Pulses per Burst	Pulse Width(us)	PRI(us)	Detection
1	5500	18	9.2	258	Yes
2	5505	16	6.6	493	Yes
3	5494	16	6.9	359	Yes
4	5497	18	9.6	397	No
5	5502	17	8	355	Yes
6	5508	17	7.6	428	No
7	5499	16	6.4	271	Yes
8	5506	18	10	371	No
9	5504	16	6.2	430	No
10	5503	17	8	272	Yes
11	5506	18	8.9	202	Yes
12	5502	18	10	264	Yes
13	5493	18	9.3	207	Yes
14	5500	17	7.9	456	Yes
15	5502	17	7.9	291	No
16	5495	17	8.6	411	Yes
17	5494	17	7.5	368	Yes
18	5505	17	8	241	Yes
19	5505	17	7.4	467	Yes
20	5504	18	10	339	Yes
21	5503	16	6.5	500	Yes
22	5495	18	10	358	No
23	5497	16	6.8	251	Yes
24	5503	18	9.1	230	Yes
25	5506	16	6.6	285	No
26	5508	17	8.4	426	Yes
27	5501	17	7.7	350	Yes
28	5497	16	6.7	434	Yes
29	5496	17	7.8	491	Yes
30	5500	16	6.8	438	Yes
Detection Rate : 76.6%					

802.11ax (HE20)

Type 4 Radar Statistical Performances					
Trial #	Test Frequency (MHz)	Pulses per Burst	Pulse Width(us)	PRI(us)	Detection
1	5500	15	18.1	258	Yes
2	5495	12	12.3	493	Yes
3	5495	13	13.2	359	Yes
4	5491	16	19.1	397	Yes
5	5500	14	15.4	355	Yes
6	5500	14	14.6	428	Yes
7	5492	12	11.9	271	Yes
8	5506	16	19.9	371	Yes
9	5492	12	11.6	430	Yes
10	5502	14	15.4	272	Yes
11	5507	15	17.4	202	Yes
12	5508	16	19.9	264	Yes
13	5493	16	18.4	207	No
14	5498	14	15.3	456	No
15	5500	14	15.3	291	Yes
16	5498	15	16.8	411	Yes
17	5500	13	14.3	368	No
18	5495	14	15.5	241	Yes
19	5506	13	14.2	467	No
20	5500	16	20	339	Yes
21	5499	12	12.2	500	No
22	5508	16	19.9	358	No
23	5508	13	12.9	251	No
24	5496	15	17.9	230	Yes
25	5499	12	12.3	285	Yes
26	5493	15	16.5	426	Yes
27	5500	14	14.8	350	Yes
28	5496	12	12.6	434	Yes
29	5505	14	15.1	491	No
30	5494	13	12.9	438	Yes
Detection Rate : 73.3%					



802.11ax (HE20)

Type 5 Radar Statistical Performances

Trial #	Minimum Chirp Width(MHz)	Chirp Center Frequency(MHz)	Test Signal Name	Detection
1	12	5500	LP_Signal_01	Yes
2	12	5500	LP_Signal_02	Yes
3	10	5500	LP_Signal_03	Yes
4	6	5500	LP_Signal_04	Yes
5	17	5500	LP_Signal_05	Yes
6	18	5500	LP_Signal_06	No
7	7	5500	LP_Signal_07	Yes
8	6	5500	LP_Signal_08	Yes
9	12	5500	LP_Signal_09	Yes
10	13	5500	LP_Signal_10	Yes
11	16	5496	LP_Signal_11	Yes
12	10	5494	LP_Signal_12	Yes
13	6	5492	LP_Signal_13	Yes
14	5	5492	LP_Signal_14	Yes
15	15	5496	LP_Signal_15	Yes
16	6	5492	LP_Signal_16	Yes
17	10	5494	LP_Signal_17	Yes
18	14	5496	LP_Signal_18	Yes
19	11	5494	LP_Signal_19	Yes
20	11	5494	LP_Signal_20	Yes
21	8	5507	LP_Signal_21	Yes
22	15	5504	LP_Signal_22	Yes
23	5	5508	LP_Signal_23	No
24	10	5506	LP_Signal_24	Yes
25	14	5504	LP_Signal_25	No
26	12	5505	LP_Signal_26	Yes
27	17	5503	LP_Signal_27	Yes
28	9	5506	LP_Signal_28	Yes
29	12	5505	LP_Signal_29	Yes
30	11	5506	LP_Signal_30	Yes

Detection Rate : 90%

Note: The Long Pulse Radar pattern shown in Appendix A.1



802.11ax (HE20)

Type 6 Radar Statistical Performances

Trial #	Pulses per Burst	Pulse Width(us)	PRI(us)	Hopping Frequency Sequence Name	Detection
1	9	1	333.3	HOP_FREQ_SEQ_01	Yes
2	9	1	333.3	HOP_FREQ_SEQ_02	Yes
3	9	1	333.3	HOP_FREQ_SEQ_03	Yes
4	9	1	333.3	HOP_FREQ_SEQ_04	Yes
5	9	1	333.3	HOP_FREQ_SEQ_05	Yes
6	9	1	333.3	HOP_FREQ_SEQ_06	Yes
7	9	1	333.3	HOP_FREQ_SEQ_07	Yes
8	9	1	333.3	HOP_FREQ_SEQ_08	Yes
9	9	1	333.3	HOP_FREQ_SEQ_09	Yes
10	9	1	333.3	HOP_FREQ_SEQ_10	Yes
11	9	1	333.3	HOP_FREQ_SEQ_11	Yes
12	9	1	333.3	HOP_FREQ_SEQ_12	Yes
13	9	1	333.3	HOP_FREQ_SEQ_13	Yes
14	9	1	333.3	HOP_FREQ_SEQ_14	Yes
15	9	1	333.3	HOP_FREQ_SEQ_15	Yes
16	9	1	333.3	HOP_FREQ_SEQ_16	Yes
17	9	1	333.3	HOP_FREQ_SEQ_17	Yes
18	9	1	333.3	HOP_FREQ_SEQ_18	Yes
19	9	1	333.3	HOP_FREQ_SEQ_19	Yes
20	9	1	333.3	HOP_FREQ_SEQ_20	Yes
21	9	1	333.3	HOP_FREQ_SEQ_21	No
22	9	1	333.3	HOP_FREQ_SEQ_22	Yes
23	9	1	333.3	HOP_FREQ_SEQ_23	Yes
24	9	1	333.3	HOP_FREQ_SEQ_24	No
25	9	1	333.3	HOP_FREQ_SEQ_25	Yes
26	9	1	333.3	HOP_FREQ_SEQ_26	Yes
27	9	1	333.3	HOP_FREQ_SEQ_27	Yes
28	9	1	333.3	HOP_FREQ_SEQ_28	Yes
29	9	1	333.3	HOP_FREQ_SEQ_29	Yes
30	9	1	333.3	HOP_FREQ_SEQ_30	Yes

Detection Rate : 93.3%

Note: The Frequency Hopping Radar pattern shown in Appendix A.2



802.11ax (HE40)

Type 1 Radar Statistical Performances

Trial #	Test Frequency (MHz)	Pulse Repetition Frequency Number (1 to 23)	Pulse Repetition Frequency (pps)	Pulses per Burst	Pulse Repetition Interval (µsec)	Detection
1	5510	5	1672.2	89	598	Yes
2	5520	21	1089.3	58	918	Yes
3	5500	14	1285.3	68	778	Yes
4	5496	23	326.2	18	3066	Yes
5	5516	10	1432.7	76	698	Yes
6	5523	13	1319.3	70	758	Yes
7	5505	16	1222.5	65	818	Yes
8	5497	15	1253.1	67	798	Yes
9	5492	11	1392.8	74	718	Yes
10	5514	3	1792.1	95	558	Yes
11	5500	22	1066.1	57	938	Yes
12	5520	7	1567.4	83	638	Yes
13	5521	17	1193.3	63	838	Yes
14	5495	18	1165.6	62	858	No
15	5525	9	1474.9	78	678	Yes
16	5495	-	1524.4	81	656	Yes
17	5515	-	749.6	40	1334	Yes
18	5502	-	1811.6	96	552	Yes
19	5527	-	660.5	35	1514	Yes
20	5498	-	364.2	20	2746	Yes
21	5507	-	960.6	51	1041	Yes
22	5520	-	344.1	19	2906	Yes
23	5506	-	421.2	23	2374	Yes
24	5508	-	751.3	40	1331	Yes
25	5522	-	513.3	28	1948	Yes
26	5526	-	1026.7	55	974	Yes
27	5518	-	409.3	22	2443	Yes
28	5513	-	557.4	30	1794	Yes
29	5507	-	874.1	47	1144	No
30	5509	-	473.5	25	2112	No

Detection Rate : 90%

Note. " - " : 15 unique PRI values randomly selected within the range of 518-3066 µsec, with a minimum increment of 1µsec, excluding PRI values selected in Test A



802.11ax (HE40)

Type 2 Radar Statistical Performances

Trial #	Test Frequency (MHz)	Pulses per Burst	Pulse Width(us)	PRI(us)	Detection
1	5510	28	4.2	228	Yes
2	5520	24	1.6	202	Yes
3	5500	24	1.9	193	Yes
4	5493	29	4.6	189	No
5	5518	26	3	167	Yes
6	5523	25	2.6	180	Yes
7	5492	23	1.4	165	No
8	5517	29	5	190	Yes
9	5509	23	1.2	168	Yes
10	5517	26	3	224	Yes
11	5512	27	3.9	187	Yes
12	5509	29	5	171	Yes
13	5513	28	4.3	223	Yes
14	5526	26	2.9	216	Yes
15	5514	26	2.9	219	Yes
16	5507	27	3.6	169	Yes
17	5509	25	2.5	199	Yes
18	5527	26	3	151	Yes
19	5509	25	2.4	198	No
20	5517	29	5	207	Yes
21	5495	23	1.5	162	Yes
22	5492	29	5	161	Yes
23	5504	24	1.8	194	Yes
24	5506	28	4.1	178	Yes
25	5520	24	1.6	170	Yes
26	5508	27	3.4	195	Yes
27	5506	25	2.7	212	Yes
28	5510	24	1.7	196	Yes
29	5526	26	2.8	217	Yes
30	5524	24	1.8	183	Yes

Detection Rate : 90%

802.11ax (HE40)

Type 3 Radar Statistical Performances

Trial #	Test Frequency (MHz)	Pulses per Burst	Pulse Width(us)	PRI(us)	Detection
1	5510	18	9.2	258	Yes
2	5520	16	6.6	493	Yes
3	5500	16	6.9	359	Yes
4	5508	18	9.6	397	No
5	5500	17	8	355	Yes
6	5515	17	7.6	428	No
7	5514	16	6.4	271	Yes
8	5512	18	10	371	Yes
9	5505	16	6.2	430	Yes
10	5526	17	8	272	Yes
11	5526	18	8.9	202	No
12	5496	18	10	264	Yes
13	5519	18	9.3	207	Yes
14	5495	17	7.9	456	Yes
15	5508	17	7.9	291	Yes
16	5501	17	8.6	411	Yes
17	5500	17	7.5	368	Yes
18	5513	17	8	241	No
19	5515	17	7.4	467	Yes
20	5494	18	10	339	Yes
21	5502	16	6.5	500	Yes
22	5505	18	10	358	No
23	5525	16	6.8	251	Yes
24	5517	18	9.1	230	No
25	5492	16	6.6	285	Yes
26	5525	17	8.4	426	No
27	5523	17	7.7	350	No
28	5522	16	6.7	434	Yes
29	5503	17	7.8	491	Yes
30	5526	16	6.8	438	Yes
Detection Rate : 73.3%					

802.11ax (HE40)

Type 4 Radar Statistical Performances					
Trial #	Test Frequency (MHz)	Pulses per Burst	Pulse Width(us)	PRI(us)	Detection
1	5510	15	18.1	258	Yes
2	5520	12	12.3	493	Yes
3	5500	13	13.2	359	Yes
4	5513	16	19.1	397	Yes
5	5494	14	15.4	355	Yes
6	5502	14	14.6	428	Yes
7	5516	12	11.9	271	No
8	5509	16	19.9	371	Yes
9	5505	12	11.6	430	Yes
10	5514	14	15.4	272	Yes
11	5519	15	17.4	202	Yes
12	5510	16	19.9	264	Yes
13	5515	16	18.4	207	Yes
14	5510	14	15.3	456	No
15	5514	14	15.3	291	Yes
16	5515	15	16.8	411	No
17	5505	13	14.3	368	Yes
18	5515	14	15.5	241	No
19	5521	13	14.2	467	No
20	5509	16	20	339	Yes
21	5508	12	12.2	500	No
22	5506	16	19.9	358	No
23	5513	13	12.9	251	Yes
24	5512	15	17.9	230	Yes
25	5492	12	12.3	285	No
26	5502	15	16.5	426	Yes
27	5494	14	14.8	350	Yes
28	5515	12	12.6	434	Yes
29	5503	14	15.1	491	Yes
30	5511	13	12.9	438	Yes
Detection Rate : 73.3%					



802.11ax (HE40)

Type 5 Radar Statistical Performances

Trial #	Minimum Chirp Width(MHz)	Chirp Center Frequency(MHz)	Test Signal Name	Detection
1	12	5510	LP_Signal_01	Yes
2	16	5510	LP_Signal_02	Yes
3	9	5510	LP_Signal_03	Yes
4	8	5510	LP_Signal_04	Yes
5	11	5510	LP_Signal_05	Yes
6	16	5510	LP_Signal_06	Yes
7	18	5510	LP_Signal_07	Yes
8	14	5510	LP_Signal_08	Yes
9	15	5510	LP_Signal_09	Yes
10	5	5510	LP_Signal_10	Yes
11	17	5498	LP_Signal_11	Yes
12	10	5495	LP_Signal_12	Yes
13	9	5495	LP_Signal_13	Yes
14	5	5493	LP_Signal_14	Yes
15	14	5497	LP_Signal_15	Yes
16	16	5497	LP_Signal_16	Yes
17	15	5497	LP_Signal_17	Yes
18	10	5495	LP_Signal_18	No
19	17	5498	LP_Signal_19	Yes
20	13	5496	LP_Signal_20	Yes
21	7	5526	LP_Signal_21	Yes
22	20	5521	LP_Signal_22	No
23	7	5526	LP_Signal_23	Yes
24	9	5525	LP_Signal_24	Yes
25	10	5525	LP_Signal_25	No
26	16	5523	LP_Signal_26	Yes
27	20	5521	LP_Signal_27	No
28	5	5527	LP_Signal_28	Yes
29	6	5527	LP_Signal_29	Yes
30	19	5521	LP_Signal_30	Yes

Detection Rate : 86.6%

Note: The Long Pulse Radar pattern shown in Appendix A.1



802.11ax (HE40)

Type 6 Radar Statistical Performances

Trial #	Pulses per Burst	Pulse Width(us)	PRI(us)	Hopping Frequency Sequence Name	Detection
1	9	1	333.3	HOP_FREQ_SEQ_01	Yes
2	9	1	333.3	HOP_FREQ_SEQ_02	Yes
3	9	1	333.3	HOP_FREQ_SEQ_03	Yes
4	9	1	333.3	HOP_FREQ_SEQ_04	Yes
5	9	1	333.3	HOP_FREQ_SEQ_05	Yes
6	9	1	333.3	HOP_FREQ_SEQ_06	Yes
7	9	1	333.3	HOP_FREQ_SEQ_07	Yes
8	9	1	333.3	HOP_FREQ_SEQ_08	Yes
9	9	1	333.3	HOP_FREQ_SEQ_09	Yes
10	9	1	333.3	HOP_FREQ_SEQ_10	Yes
11	9	1	333.3	HOP_FREQ_SEQ_11	Yes
12	9	1	333.3	HOP_FREQ_SEQ_12	Yes
13	9	1	333.3	HOP_FREQ_SEQ_13	Yes
14	9	1	333.3	HOP_FREQ_SEQ_14	No
15	9	1	333.3	HOP_FREQ_SEQ_15	Yes
16	9	1	333.3	HOP_FREQ_SEQ_16	Yes
17	9	1	333.3	HOP_FREQ_SEQ_17	Yes
18	9	1	333.3	HOP_FREQ_SEQ_18	No
19	9	1	333.3	HOP_FREQ_SEQ_19	No
20	9	1	333.3	HOP_FREQ_SEQ_20	No
21	9	1	333.3	HOP_FREQ_SEQ_21	Yes
22	9	1	333.3	HOP_FREQ_SEQ_22	Yes
23	9	1	333.3	HOP_FREQ_SEQ_23	Yes
24	9	1	333.3	HOP_FREQ_SEQ_24	Yes
25	9	1	333.3	HOP_FREQ_SEQ_25	Yes
26	9	1	333.3	HOP_FREQ_SEQ_26	Yes
27	9	1	333.3	HOP_FREQ_SEQ_27	Yes
28	9	1	333.3	HOP_FREQ_SEQ_28	Yes
29	9	1	333.3	HOP_FREQ_SEQ_29	Yes
30	9	1	333.3	HOP_FREQ_SEQ_30	Yes

Detection Rate : 86.6%

Note: The Frequency Hopping Radar pattern shown in Appendix A.2



802.11ax (HE80)

Type 1 Radar Statistical Performances

Trial #	Test Frequency (MHz)	Pulse Repetition Frequency Number (1 to 23)	Pulse Repetition Frequency (pps)	Pulses per Burst	Pulse Repetition Interval (µsec)	Detection
1	5530	5	1672.2	89	598	Yes
2	5540	21	1089.3	58	918	Yes
3	5560	14	1285.3	68	778	Yes
4	5520	23	326.2	18	3066	Yes
5	5500	10	1432.7	76	698	Yes
6	5527	13	1319.3	70	758	Yes
7	5557	16	1222.5	65	818	Yes
8	5528	15	1253.1	67	798	Yes
9	5548	11	1392.8	74	718	Yes
10	5530	3	1792.1	95	558	Yes
11	5494	22	1066.1	57	938	Yes
12	5507	7	1567.4	83	638	Yes
13	5511	17	1193.3	63	838	Yes
14	5503	18	1165.6	62	858	Yes
15	5505	9	1474.9	78	678	Yes
16	5538	-	1524.4	81	656	Yes
17	5512	-	749.6	40	1334	Yes
18	5502	-	1811.6	96	552	Yes
19	5532	-	660.5	35	1514	No
20	5505	-	364.2	20	2746	Yes
21	5565	-	960.6	51	1041	Yes
22	5499	-	344.1	19	2906	Yes
23	5524	-	421.2	23	2374	No
24	5530	-	751.3	40	1331	Yes
25	5566	-	513.3	28	1948	Yes
26	5503	-	1026.7	55	974	Yes
27	5565	-	409.3	22	2443	Yes
28	5518	-	557.4	30	1794	Yes
29	5520	-	874.1	47	1144	Yes
30	5523	-	473.5	25	2112	Yes

Detection Rate : 93.3%

Note. “ - “ : 15 unique PRI values randomly selected within the range of 518-3066 µsec, with a minimum increment of 1µsec, excluding PRI values selected in Test A

802.11ax (HE80)

Type 2 Radar Statistical Performances					
Trial #	Test Frequency (MHz)	Pulses per Burst	Pulse Width(us)	PRI(us)	Detection
1	5530	28	4.2	228	Yes
2	5540	24	1.6	202	No
3	5560	24	1.9	193	Yes
4	5520	29	4.6	189	Yes
5	5500	26	3	167	Yes
6	5536	25	2.6	180	Yes
7	5518	23	1.4	165	Yes
8	5567	29	5	190	No
9	5527	23	1.2	168	Yes
10	5515	26	3	224	Yes
11	5530	27	3.9	187	Yes
12	5519	29	5	171	Yes
13	5506	28	4.3	223	Yes
14	5500	26	2.9	216	Yes
15	5543	26	2.9	219	Yes
16	5532	27	3.6	169	Yes
17	5544	25	2.5	199	Yes
18	5544	26	3	151	Yes
19	5495	25	2.4	198	Yes
20	5513	29	5	207	No
21	5531	23	1.5	162	Yes
22	5551	29	5	161	Yes
23	5498	24	1.8	194	Yes
24	5496	28	4.1	178	Yes
25	5550	24	1.6	170	Yes
26	5564	27	3.4	195	Yes
27	5513	25	2.7	212	Yes
28	5505	24	1.7	196	Yes
29	5520	26	2.8	217	Yes
30	5549	24	1.8	183	Yes
Detection Rate : 90%					

802.11ax (HE80)

Type 3 Radar Statistical Performances

Trial #	Test Frequency (MHz)	Pulses per Burst	Pulse Width(us)	PRI(us)	Detection
1	5530	18	9.2	258	Yes
2	5540	16	6.6	493	Yes
3	5560	16	6.9	359	No
4	5520	18	9.6	397	Yes
5	5500	17	8	355	Yes
6	5518	17	7.6	428	Yes
7	5555	16	6.4	271	Yes
8	5545	18	10	371	Yes
9	5564	16	6.2	430	No
10	5544	17	8	272	Yes
11	5529	18	8.9	202	No
12	5550	18	10	264	No
13	5512	18	9.3	207	Yes
14	5543	17	7.9	456	Yes
15	5515	17	7.9	291	Yes
16	5551	17	8.6	411	Yes
17	5550	17	7.5	368	Yes
18	5504	17	8	241	No
19	5545	17	7.4	467	Yes
20	5566	18	10	339	Yes
21	5508	16	6.5	500	Yes
22	5549	18	10	358	Yes
23	5501	16	6.8	251	Yes
24	5553	18	9.1	230	No
25	5564	16	6.6	285	Yes
26	5558	17	8.4	426	Yes
27	5524	17	7.7	350	No
28	5523	16	6.7	434	No
29	5545	17	7.8	491	No
30	5539	16	6.8	438	No
Detection Rate : 66.6%					

802.11ax (HE80)

Type 4 Radar Statistical Performances					
Trial #	Test Frequency (MHz)	Pulses per Burst	Pulse Width(us)	PRI(us)	Detection
1	5530	15	18.1	258	No
2	5540	12	12.3	493	Yes
3	5560	13	13.2	359	No
4	5520	16	19.1	397	Yes
5	5500	14	15.4	355	Yes
6	5518	14	14.6	428	Yes
7	5535	12	11.9	271	Yes
8	5523	16	19.9	371	Yes
9	5548	12	11.6	430	Yes
10	5527	14	15.4	272	Yes
11	5525	15	17.4	202	Yes
12	5528	16	19.9	264	Yes
13	5533	16	18.4	207	Yes
14	5563	14	15.3	456	Yes
15	5526	14	15.3	291	No
16	5511	15	16.8	411	Yes
17	5519	13	14.3	368	Yes
18	5560	14	15.5	241	Yes
19	5524	13	14.2	467	No
20	5531	16	20	339	Yes
21	5520	12	12.2	500	Yes
22	5566	16	19.9	358	Yes
23	5521	13	12.9	251	Yes
24	5540	15	17.9	230	No
25	5567	12	12.3	285	Yes
26	5537	15	16.5	426	No
27	5532	14	14.8	350	Yes
28	5557	12	12.6	434	Yes
29	5514	14	15.1	491	Yes
30	5509	13	12.9	438	Yes
Detection Rate : 80%					



802.11ax (HE80)

Type 5 Radar Statistical Performances				
Trial #	Minimum Chirp Width(MHz)	Chirp Center Frequency(MHz)	Test Signal Name	Detection
1	7	5530	LP_Signal_01	Yes
2	10	5530	LP_Signal_02	Yes
3	14	5530	LP_Signal_03	No
4	7	5530	LP_Signal_04	Yes
5	12	5530	LP_Signal_05	Yes
6	14	5530	LP_Signal_06	Yes
7	19	5530	LP_Signal_07	Yes
8	6	5530	LP_Signal_08	No
9	16	5530	LP_Signal_09	Yes
10	10	5530	LP_Signal_10	Yes
11	11	5495	LP_Signal_11	Yes
12	11	5495	LP_Signal_12	Yes
13	12	5496	LP_Signal_13	Yes
14	16	5497	LP_Signal_14	Yes
15	19	5499	LP_Signal_15	Yes
16	10	5495	LP_Signal_16	Yes
17	11	5495	LP_Signal_17	Yes
18	19	5499	LP_Signal_18	Yes
19	5	5493	LP_Signal_19	Yes
20	5	5493	LP_Signal_20	Yes
21	11	5565	LP_Signal_21	Yes
22	8	5566	LP_Signal_22	Yes
23	16	5563	LP_Signal_23	Yes
24	11	5565	LP_Signal_24	Yes
25	8	5566	LP_Signal_25	Yes
26	12	5564	LP_Signal_26	Yes
27	16	5563	LP_Signal_27	Yes
28	14	5563	LP_Signal_28	Yes
29	11	5565	LP_Signal_29	Yes
30	7	5566	LP_Signal_30	Yes

Detection Rate : 93.3%

Note: The Long Pulse Radar pattern shown in Appendix A.1



802.11ax (HE80)

Type 6 Radar Statistical Performances

Trial #	Pulses per Burst	Pulse Width(us)	PRI(us)	Hopping Frequency Sequence Name	Detection
1	9	1	333.3	HOP_FREQ_SEQ_01	Yes
2	9	1	333.3	HOP_FREQ_SEQ_02	Yes
3	9	1	333.3	HOP_FREQ_SEQ_03	Yes
4	9	1	333.3	HOP_FREQ_SEQ_04	Yes
5	9	1	333.3	HOP_FREQ_SEQ_05	Yes
6	9	1	333.3	HOP_FREQ_SEQ_06	Yes
7	9	1	333.3	HOP_FREQ_SEQ_07	Yes
8	9	1	333.3	HOP_FREQ_SEQ_08	Yes
9	9	1	333.3	HOP_FREQ_SEQ_09	Yes
10	9	1	333.3	HOP_FREQ_SEQ_10	Yes
11	9	1	333.3	HOP_FREQ_SEQ_11	Yes
12	9	1	333.3	HOP_FREQ_SEQ_12	Yes
13	9	1	333.3	HOP_FREQ_SEQ_13	Yes
14	9	1	333.3	HOP_FREQ_SEQ_14	Yes
15	9	1	333.3	HOP_FREQ_SEQ_15	Yes
16	9	1	333.3	HOP_FREQ_SEQ_16	Yes
17	9	1	333.3	HOP_FREQ_SEQ_17	Yes
18	9	1	333.3	HOP_FREQ_SEQ_18	Yes
19	9	1	333.3	HOP_FREQ_SEQ_19	No
20	9	1	333.3	HOP_FREQ_SEQ_20	No
21	9	1	333.3	HOP_FREQ_SEQ_21	Yes
22	9	1	333.3	HOP_FREQ_SEQ_22	Yes
23	9	1	333.3	HOP_FREQ_SEQ_23	Yes
24	9	1	333.3	HOP_FREQ_SEQ_24	Yes
25	9	1	333.3	HOP_FREQ_SEQ_25	Yes
26	9	1	333.3	HOP_FREQ_SEQ_26	Yes
27	9	1	333.3	HOP_FREQ_SEQ_27	Yes
28	9	1	333.3	HOP_FREQ_SEQ_28	Yes
29	9	1	333.3	HOP_FREQ_SEQ_29	Yes
30	9	1	333.3	HOP_FREQ_SEQ_30	Yes

Detection Rate : 93.3%

Note: The Frequency Hopping Radar pattern shown in Appendix A.2



802.11ax (HE160)

Type 1 Radar Statistical Performances

Trial #	Test Frequency (MHz)	Pulse Repetition Frequency Number (1 to 23)	Pulse Repetition Frequency (pps)	Pulses per Burst	Pulse Repetition Interval (μ sec)	Detection
1	5570	5	1672.2	89	598	No
2	5580	21	1089.3	58	918	Yes
3	5600	14	1285.3	68	778	Yes
4	5560	23	326.2	18	3066	Yes
5	5540	10	1432.7	76	698	Yes
6	5514	13	1319.3	70	758	Yes
7	5613	16	1222.5	65	818	Yes
8	5495	15	1253.1	67	798	Yes
9	5585	11	1392.8	74	718	Yes
10	5641	3	1792.1	95	558	Yes
11	5636	22	1066.1	57	938	Yes
12	5628	7	1567.4	83	638	Yes
13	5603	17	1193.3	63	838	Yes
14	5634	18	1165.6	62	858	Yes
15	5504	9	1474.9	78	678	Yes
16	5509	-	1524.4	81	656	Yes
17	5581	-	749.6	40	1334	Yes
18	5644	-	1811.6	96	552	No
19	5617	-	660.5	35	1514	Yes
20	5584	-	364.2	20	2746	Yes
21	5553	-	960.6	51	1041	Yes
22	5593	-	344.1	19	2906	Yes
23	5568	-	421.2	23	2374	Yes
24	5499	-	751.3	40	1331	Yes
25	5572	-	513.3	28	1948	Yes
26	5634	-	1026.7	55	974	Yes
27	5601	-	409.3	22	2443	Yes
28	5604	-	557.4	30	1794	Yes
29	5647	-	874.1	47	1144	Yes
30	5558	-	473.5	25	2112	Yes

Detection Rate : 93.3%

Note. " - " : 15 unique PRI values randomly selected within the range of 518-3066 μ sec, with a minimum increment of 1 μ sec, excluding PRI values selected in Test A

802.11ax (HE160)

Type 2 Radar Statistical Performances					
Trial #	Test Frequency (MHz)	Pulses per Burst	Pulse Width(us)	PRI(us)	Detection
1	5570	28	4.2	228	Yes
2	5580	24	1.6	202	Yes
3	5600	24	1.9	193	No
4	5560	29	4.6	189	Yes
5	5540	26	3	167	Yes
6	5646	25	2.6	180	No
7	5614	23	1.4	165	Yes
8	5556	29	5	190	Yes
9	5516	23	1.2	168	Yes
10	5641	26	3	224	Yes
11	5622	27	3.9	187	No
12	5627	29	5	171	Yes
13	5582	28	4.3	223	Yes
14	5511	26	2.9	216	Yes
15	5511	26	2.9	219	Yes
16	5628	27	3.6	169	Yes
17	5499	25	2.5	199	Yes
18	5648	26	3	151	No
19	5604	25	2.4	198	Yes
20	5622	29	5	207	Yes
21	5508	23	1.5	162	Yes
22	5553	29	5	161	Yes
23	5584	24	1.8	194	Yes
24	5632	28	4.1	178	Yes
25	5551	24	1.6	170	Yes
26	5587	27	3.4	195	Yes
27	5595	25	2.7	212	Yes
28	5553	24	1.7	196	Yes
29	5520	26	2.8	217	Yes
30	5566	24	1.8	183	Yes
Detection Rate : 86.6%					

802.11ax (HE160)

Type 3 Radar Statistical Performances					
Trial #	Test Frequency (MHz)	Pulses per Burst	Pulse Width(us)	PRI(us)	Detection
1	5570	18	9.2	258	Yes
2	5580	16	6.6	493	No
3	5600	16	6.9	359	Yes
4	5560	18	9.6	397	Yes
5	5540	17	8	355	Yes
6	5607	17	7.6	428	No
7	5646	16	6.4	271	No
8	5514	18	10	371	Yes
9	5550	16	6.2	430	Yes
10	5573	17	8	272	Yes
11	5612	18	8.9	202	Yes
12	5619	18	10	264	Yes
13	5579	18	9.3	207	Yes
14	5640	17	7.9	456	Yes
15	5554	17	7.9	291	No
16	5516	17	8.6	411	Yes
17	5504	17	7.5	368	No
18	5492	17	8	241	Yes
19	5507	17	7.4	467	Yes
20	5593	18	10	339	Yes
21	5508	16	6.5	500	Yes
22	5610	18	10	358	No
23	5579	16	6.8	251	No
24	5561	18	9.1	230	Yes
25	5509	16	6.6	285	Yes
26	5508	17	8.4	426	Yes
27	5501	17	7.7	350	No
28	5530	16	6.7	434	No
29	5634	17	7.8	491	Yes
30	5624	16	6.8	438	Yes
Detection Rate : 70%					

802.11ax (HE160)

Type 4 Radar Statistical Performances					
Trial #	Test Frequency (MHz)	Pulses per Burst	Pulse Width(us)	PRI(us)	Detection
1	5570	15	18.1	258	Yes
2	5580	12	12.3	493	Yes
3	5600	13	13.2	359	No
4	5560	16	19.1	397	Yes
5	5540	14	15.4	355	No
6	5608	14	14.6	428	Yes
7	5609	12	11.9	271	Yes
8	5577	16	19.9	371	Yes
9	5639	12	11.6	430	Yes
10	5551	14	15.4	272	Yes
11	5541	15	17.4	202	No
12	5647	16	19.9	264	No
13	5581	16	18.4	207	No
14	5538	14	15.3	456	Yes
15	5607	14	15.3	291	Yes
16	5559	15	16.8	411	Yes
17	5570	13	14.3	368	Yes
18	5538	14	15.5	241	Yes
19	5559	13	14.2	467	No
20	5621	16	20	339	Yes
21	5587	12	12.2	500	Yes
22	5551	16	19.9	358	Yes
23	5557	13	12.9	251	Yes
24	5552	15	17.9	230	Yes
25	5644	12	12.3	285	No
26	5615	15	16.5	426	Yes
27	5595	14	14.8	350	Yes
28	5604	12	12.6	434	Yes
29	5594	14	15.1	491	Yes
30	5510	13	12.9	438	Yes
Detection Rate : 76.6%					

802.11ax (HE160)

Type 5 Radar Statistical Performances				
Trial #	Minimum Chirp Width(MHz)	Chirp Center Frequency(MHz)	Test Signal Name	Detection
1	12	5570	LP_Signal_01	Yes
2	18	5570	LP_Signal_02	No
3	20	5570	LP_Signal_03	No
4	16	5570	LP_Signal_04	Yes
5	19	5570	LP_Signal_05	Yes
6	6	5570	LP_Signal_06	Yes
7	9	5570	LP_Signal_07	Yes
8	6	5570	LP_Signal_08	Yes
9	8	5570	LP_Signal_09	Yes
10	17	5570	LP_Signal_10	Yes
11	8	5494	LP_Signal_11	Yes
12	17	5498	LP_Signal_12	Yes
13	16	5497	LP_Signal_13	No
14	20	5499	LP_Signal_14	Yes
15	9	5495	LP_Signal_15	Yes
16	18	5498	LP_Signal_16	No
17	12	5496	LP_Signal_17	Yes
18	11	5495	LP_Signal_18	Yes
19	10	5495	LP_Signal_19	Yes
20	15	5497	LP_Signal_20	Yes
21	20	5641	LP_Signal_21	No
22	7	5646	LP_Signal_22	Yes
23	16	5643	LP_Signal_23	Yes
24	14	5643	LP_Signal_24	Yes
25	11	5645	LP_Signal_25	Yes
26	8	5646	LP_Signal_26	Yes
27	5	5647	LP_Signal_27	No
28	5	5647	LP_Signal_28	Yes
29	19	5641	LP_Signal_29	Yes
30	17	5642	LP_Signal_30	Yes
				Detection Rate : 80%

Note: The Long Pulse Radar pattern shown in Appendix A.1



802.11ax (HE160)

Type 6 Radar Statistical Performances

Trial #	Pulses per Burst	Pulse Width(us)	PRI(us)	Hopping Frequency Sequence Name	Detection
1	9	1	333.3	HOP_FREQ_SEQ_01	Yes
2	9	1	333.3	HOP_FREQ_SEQ_02	Yes
3	9	1	333.3	HOP_FREQ_SEQ_03	Yes
4	9	1	333.3	HOP_FREQ_SEQ_04	Yes
5	9	1	333.3	HOP_FREQ_SEQ_05	Yes
6	9	1	333.3	HOP_FREQ_SEQ_06	Yes
7	9	1	333.3	HOP_FREQ_SEQ_07	Yes
8	9	1	333.3	HOP_FREQ_SEQ_08	Yes
9	9	1	333.3	HOP_FREQ_SEQ_09	No
10	9	1	333.3	HOP_FREQ_SEQ_10	Yes
11	9	1	333.3	HOP_FREQ_SEQ_11	Yes
12	9	1	333.3	HOP_FREQ_SEQ_12	Yes
13	9	1	333.3	HOP_FREQ_SEQ_13	No
14	9	1	333.3	HOP_FREQ_SEQ_14	Yes
15	9	1	333.3	HOP_FREQ_SEQ_15	Yes
16	9	1	333.3	HOP_FREQ_SEQ_16	Yes
17	9	1	333.3	HOP_FREQ_SEQ_17	Yes
18	9	1	333.3	HOP_FREQ_SEQ_18	Yes
19	9	1	333.3	HOP_FREQ_SEQ_19	Yes
20	9	1	333.3	HOP_FREQ_SEQ_20	Yes
21	9	1	333.3	HOP_FREQ_SEQ_21	Yes
22	9	1	333.3	HOP_FREQ_SEQ_22	Yes
23	9	1	333.3	HOP_FREQ_SEQ_23	Yes
24	9	1	333.3	HOP_FREQ_SEQ_24	Yes
25	9	1	333.3	HOP_FREQ_SEQ_25	Yes
26	9	1	333.3	HOP_FREQ_SEQ_26	Yes
27	9	1	333.3	HOP_FREQ_SEQ_27	Yes
28	9	1	333.3	HOP_FREQ_SEQ_28	Yes
29	9	1	333.3	HOP_FREQ_SEQ_29	Yes
30	9	1	333.3	HOP_FREQ_SEQ_30	Yes

Detection Rate : 93.3%

Note: The Frequency Hopping Radar pattern shown in Appendix A.2

6.2.5 Non-Occupancy Period

1) Test results demonstrating an associated client link is established with the master on a test frequency.

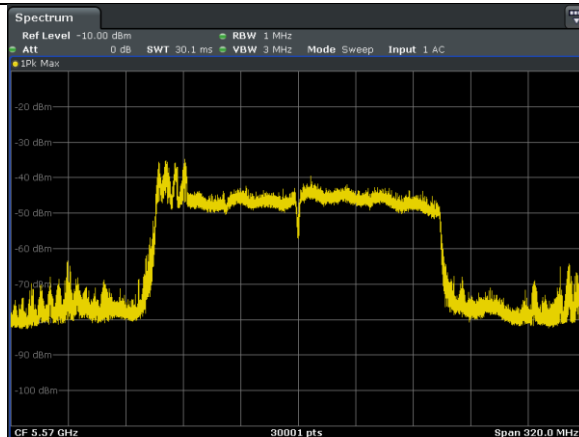

EUT (master) links with Client on 5570MHz

2) The master and DFS-certified client device are associated, and system testing will be performed with channel-loading for a non-occupancy period test.

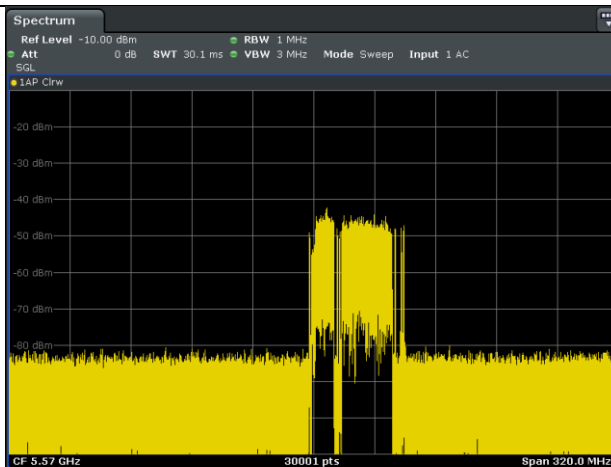

Client performed with channel-loading via master.

3). The device transmits one type of radar as specified in the DFS Order.

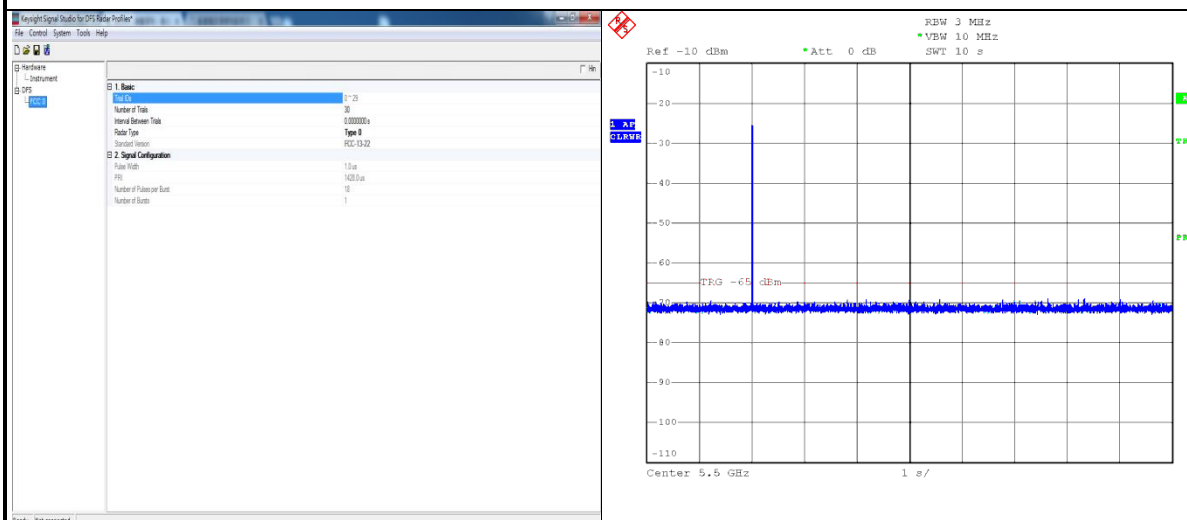

Radar 0 is used to test during DFS testing.

4) The test frequency has been monitored to ensure no transmission of any type has occurred for 30 minutes;

Note: If the client moves with the master, the device is considered compliant if nothing appears in the client non-occupancy period test. For devices that shut down (rather than moving channels), no beacons should appear;

5) An analyzer plot that contains a single 30-minute sweep on the original test frequency.

Non - Occupancy Period

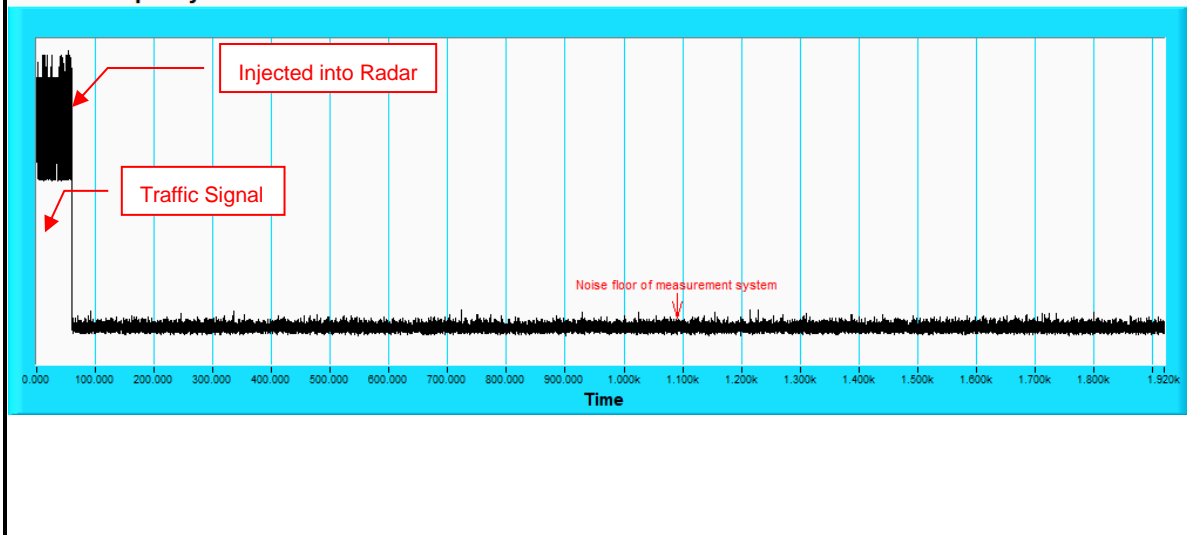

7. Information of the Testing Laboratories

We, Bureau Veritas Consumer Products Services (H.K.) Ltd., Taoyuan Branch, were founded in 1988 to provide our best service in EMC, Radio, Telecom and Safety consultation. Our laboratories are accredited and approved according to ISO/IEC 17025.

If you have any comments, please feel free to contact us at the following:

Lin Kou EMC/RF Lab:

Tel: 886-2-26052180

Fax: 886-2-26051924

Hsin Chu EMC/RF/Telecom Lab:

Tel: 886-3-6668565

Fax: 886-3-6668323

Hwa Ya EMC/RF/Safety Lab:

Tel: 886-3-3183232

Fax: 886-3-3270892

Email: service.adt@tw.bureauveritas.com

Web Site: www.bureauveritas-adt.com

The address and road map of all our labs can be found in our web site also.

APPENDIX-A

RADAR TEST SIGNAL

A.1 The Long Pulse Radar Pattern

802.11ax (HE20)

Long Pulse Radar Test Signal						
Test Signal Name: LP_Signal_01						
Number of Bursts in Trial: 14						
Burst	Pulses per Burst	Chrip (MHz)	Pulse Width(us)	PRI-1 (us)	PRI-2 (us)	PRI-3 (us)
1	2	12	74.6	1498	1371	-
2	2	12	72.6	1404	1520	-
3	2	12	68.3	1025	1340	-
4	1	12	55.8	1311	-	-
5	3	12	90.3	1534	1197	1572
6	3	12	91.2	1238	1078	1790
7	1	12	58	1217	-	-
8	1	12	55.6	1665	-	-
9	2	12	73.6	1921	1507	-
10	2	12	75.9	1965	1873	-
11	3	12	85.1	1269	1489	1933
12	1	12	66	1402	-	-
13	1	12	53.2	1373	-	-
14	1	12	50.7	1466	-	-
15						-
16						-
17						-
18						-
19						
20						



Long Pulse Radar Test Signal

Test Signal Name: LP_Signal_02

Number of Bursts in Trial: 13

Burst	Pulses per Burst	Chrip (MHz)	Pulse Width(us)	PRI-1 (us)	PRI-2 (us)	PRI-3 (us)
1	3	12	84	1985	1756	1615
2	1	12	55.3	1841	-	-
3	1	12	65.9	1409	-	-
4	2	12	80.8	1283	1812	-
5	2	12	70.6	1989	1956	-
6	2	12	71.1	1940	1675	-
7	1	12	61.8	1206	-	-
8	2	12	81.4	1063	1435	-
9	1	12	53	1821	-	-
10	1	12	65.8	1080	-	-
11	2	12	79.9	1974	1011	-
12	2	12	74.4	1760	1239	-
13	3	12	88.5	1496	1310	1186
14						
15						
16						
17						
18						
19						
20						

Long Pulse Radar Test Signal

Test Signal Name: LP_Signal_03

Number of Bursts in Trial: 12

Burst	Pulses per Burst	Chrip (MHz)	Pulse Width(us)	PRI-1 (us)	PRI-2 (us)	PRI-3 (us)
1	1	10	63.4	1136	-	-
2	2	10	72.2	1468	1254	-
3	2	10	71.1	1925	1262	-
4	2	10	73.7	1440	1002	-
5	1	10	52.8	1400	-	-
6	3	10	95.6	1561	1357	1810
7	2	10	76	1172	1358	-
8	3	10	95.5	1163	1957	1521
9	1	10	57	1054	-	-
10	3	10	84.7	1516	1727	1499
11	1	10	60.6	1105	-	-
12	2	10	82	1697	1530	-
13						
14						
15						
16						
17						
18						
19						
20						

Long Pulse Radar Test Signal

Test Signal Name: LP_Signal_04

Number of Bursts in Trial: 9

Burst	Pulses per Burst	Chrip (MHz)	Pulse Width(us)	PRI-1 (us)	PRI-2 (us)	PRI-3 (us)
1	1	6	65.3	1052	-	-
2	1	6	52.1	1442	-	-
3	3	6	88.8	1770	1173	1644
4	3	6	95.3	1387	1848	1446
5	3	6	85.2	1682	1705	1170
6	1	6	57.9	1817	-	-
7	3	6	87	1558	1064	1694
8	3	6	85	1753	1673	1059
9	1	6	51.9	1504	-	-
10						
11						
12						
13						
14						
15						
16						
17						
18						
19						
20						

Long Pulse Radar Test Signal

Test Signal Name: LP_Signal_05

Number of Bursts in Trial: 18

Burst	Pulses per Burst	Chrip (MHz)	Pulse Width(us)	PRI-1 (us)	PRI-2 (us)	PRI-3 (us)
1	1	17	50.6	1264	-	-
2	2	17	78.5	1910	1616	-
3	1	17	57.2	1850	-	-
4	1	17	61.9	1056	-	-
5	1	17	51.1	1720	-	-
6	1	17	53.2	1819	-	-
7	2	17	70.9	1233	1838	-
8	3	17	93.2	1689	1031	1797
9	2	17	69.5	1191	1455	-
10	1	17	52.4	1736	-	-
11	2	17	75.9	1494	1267	-
12	1	17	65.9	1613	-	-
13	1	17	52.6	1266	-	-
14	3	17	94.6	1968	1121	1364
15	3	17	83.4	1745	1908	1246
16	1	17	52.5	1140	-	-
17	1	17	52.1	1216	-	-
18	2	17	82.2	1992	1824	-
19						
20						



Long Pulse Radar Test Signal

Test Signal Name: LP_Signal_06

Number of Bursts in Trial: 18

Burst	Pulses per Burst	Chrip (MHz)	Pulse Width(us)	PRI-1 (us)	PRI-2 (us)	PRI-3 (us)
1	2	18	70.4	1227	1079	-
2	2	18	77.2	1299	1193	-
3	1	18	55.2	1407	-	-
4	2	18	77	1578	1669	-
5	2	18	70.7	1029	1509	-
6	1	18	55.3	1863	-	-
7	3	18	98.8	1995	1674	1628
8	1	18	55.2	1879	-	-
9	2	18	69	1103	1583	-
10	2	18	73	1453	1486	-
11	3	18	86.1	1313	1795	1791
12	2	18	67.9	1210	1153	-
13	1	18	57.9	1418	-	-
14	3	18	93	1710	1857	1169
15	3	18	89.4	1757	1411	1864
16	3	18	86.6	1987	1488	1667
17	1	18	62.7	1202	-	-
18	3	18	93.7	1944	1774	1599
19						
20						

Long Pulse Radar Test Signal

Test Signal Name: LP_Signal_07

Number of Bursts in Trial: 10

Burst	Pulses per Burst	Chrip (MHz)	Pulse Width(us)	PRI-1 (us)	PRI-2 (us)	PRI-3 (us)
1	1	7	63.9	1190	-	-
2	1	7	61.7	1867	-	-
3	1	7	51.7	1752	-	-
4	3	7	92.4	1234	1263	1113
5	1	7	55.1	1624	-	-
6	1	7	52.2	1743	-	-
7	3	7	87.5	1768	1506	1657
8	2	7	82.2	1748	1890	-
9	3	7	84.8	1116	1699	1976
10	1	7	66	1165	-	-
11						
12						
13						
14						
15						
16						
17						
18						
19						
20						



Long Pulse Radar Test Signal

Test Signal Name: LP_Signal_08

Number of Bursts in Trial: 9

Burst	Pulses per Burst	Chrip (MHz)	Pulse Width(us)	PRI-1 (us)	PRI-2 (us)	PRI-3 (us)
1	1	6	62.6	1351	-	-
2	1	6	57.5	2000	-	-
3	1	6	55.4	1132	-	-
4	3	6	92.8	1942	1773	1391
5	2	6	83	1691	1634	-
6	2	6	75.7	1544	1541	-
7	1	6	66.6	1449	-	-
8	1	6	57.7	1854	-	-
9	3	6	96.7	1345	1652	1668
10						
11						
12						
13						
14						
15						
16						
17						
18						
19						
20						



Long Pulse Radar Test Signal

Test Signal Name: LP_Signal_09

Number of Bursts in Trial: 14

Burst	Pulses per Burst	Chrip (MHz)	Pulse Width(us)	PRI-1 (us)	PRI-2 (us)	PRI-3 (us)
1	2	12	73.7	1729	1986	-
2	1	12	57.8	1789	-	-
3	1	12	51.9	1095	-	-
4	1	12	63.2	1481	-	-
5	3	12	95.9	1030	1086	1896
6	3	12	84.2	1221	1102	1687
7	3	12	97.9	1241	1769	1547
8	1	12	57.1	1100	-	-
9	1	12	51.6	1874	-	-
10	3	12	94.6	1677	1028	1764
11	2	12	82.9	1452	1480	-
12	2	12	76.5	1403	1703	-
13	1	12	66.1	1972	-	-
14	2	12	81.9	1017	1523	-
15						
16						
17						
18						
19						
20						



Long Pulse Radar Test Signal

Test Signal Name: LP_Signal_10

Number of Bursts in Trial: 14

Burst	Pulses per Burst	Chrip (MHz)	Pulse Width(us)	PRI-1 (us)	PRI-2 (us)	PRI-3 (us)
1	3	13	89.7	1531	1564	1131
2	3	13	88.6	1290	1461	1573
3	3	13	90.5	1651	1914	1801
4	2	13	80.5	1219	1576	-
5	2	13	78	1439	1866	-
6	2	13	72.1	1831	1148	-
7	1	13	53	1048	-	-
8	3	13	89.5	1137	1287	1220
9	3	13	88.5	1898	1924	1870
10	2	13	70.6	1424	1650	-
11	2	13	82.7	1845	1794	-
12	3	13	92.7	1638	1926	1484
13	1	13	61.4	1085	-	-
14	2	13	67.6	1417	1712	-
15						
16						
17						
18						
19						
20						

Long Pulse Radar Test Signal

Test Signal Name: LP_Signal_11

Number of Bursts in Trial: 17

Burst	Pulses per Burst	Chrip (MHz)	Pulse Width(us)	PRI-1 (us)	PRI-2 (us)	PRI-3 (us)
1	3	16	93.3	1205	1626	1836
2	3	16	85	1782	1476	1016
3	2	16	82.3	1482	1545	-
4	2	16	76.4	1129	1041	-
5	2	16	81.7	1192	1827	-
6	3	16	89.9	1343	1655	1855
7	3	16	89	1556	1888	1539
8	3	16	85.9	1462	1422	1176
9	1	16	62	1808	-	-
10	3	16	98.6	1120	1548	1092
11	1	16	55.9	1607	-	-
12	1	16	58.1	1600	-	-
13	1	16	57.2	1154	-	-
14	3	16	95.2	1524	1467	1349
15	3	16	85.8	1610	1813	1457
16	3	16	87.7	1735	1829	1878
17	1	16	51.8	1458	-	-
18						
19						
20						



Long Pulse Radar Test Signal

Test Signal Name: LP_Signal_12

Number of Bursts in Trial: 12

Burst	Pulses per Burst	Chrip (MHz)	Pulse Width(us)	PRI-1 (us)	PRI-2 (us)	PRI-3 (us)
1	3	10	89.6	1271	1451	1389
2	3	10	96.6	1631	1355	1077
3	2	10	75.7	1414	1049	-
4	1	10	65.7	1606	-	-
5	1	10	54.1	1670	-	-
6	3	10	92.6	1319	1250	1037
7	3	10	95.3	1201	1291	1072
8	3	10	88.6	1441	1425	1352
9	3	10	85.7	1472	1057	1433
10	3	10	93.7	1159	1716	1505
11	3	10	84.2	1739	1330	1960
12	2	10	69.4	1360	1306	-
13						
14						
15						
16						
17						
18						
19						
20						



Long Pulse Radar Test Signal

Test Signal Name: LP_Signal_13

Number of Bursts in Trial: 8

Burst	Pulses per Burst	Chrip (MHz)	Pulse Width(us)	PRI-1 (us)	PRI-2 (us)	PRI-3 (us)
1	2	6	81.3	1553	1004	-
2	2	6	80.5	1143	1350	-
3	1	6	53.2	1485	-	-
4	2	6	72.8	1009	1393	-
5	2	6	80.3	1167	1070	-
6	1	6	63.8	1632	-	-
7	2	6	66.7	1950	1386	-
8	1	6	62.3	1183	-	-
9						
10						
11						
12						
13						
14						
15						
16						
17						
18						
19						
20						

Long Pulse Radar Test Signal

Test Signal Name: LP_Signal_14

Number of Bursts in Trial: 8

Burst	Pulses per Burst	Chrip (MHz)	Pulse Width(us)	PRI-1 (us)	PRI-2 (us)	PRI-3 (us)
1	1	5	56.5	1860	-	-
2	3	5	94.9	1611	1750	1384
3	2	5	76.2	1139	1133	-
4	3	5	92.9	1091	1437	1464
5	1	5	53.8	1214	-	-
6	2	5	76.6	1243	1967	-
7	3	5	91.9	1388	1747	1282
8	2	5	74.5	1793	1122	-
9						
10						
11						
12						
13						
14						
15						
16						
17						
18						
19						
20						



Long Pulse Radar Test Signal

Test Signal Name: LP_Signal_15

Number of Bursts in Trial: 16

Burst	Pulses per Burst	Chrip (MHz)	Pulse Width(us)	PRI-1 (us)	PRI-2 (us)	PRI-3 (us)
1	2	15	69.9	1913	1806	-
2	1	15	64.8	1973	-	-
3	1	15	57.8	1891	-	-
4	1	15	53.7	1211	-	-
5	1	15	50.7	1322	-	-
6	2	15	68.7	1228	1602	-
7	3	15	93.2	1612	1487	1118
8	3	15	96.1	1587	1647	1688
9	3	15	85.8	1209	1213	1894
10	1	15	51.9	1903	-	-
11	3	15	89.2	1991	1090	1366
12	3	15	92.4	1588	1162	1937
13	3	15	87	1503	1882	1115
14	3	15	87.8	1744	1721	1629
15	3	15	96.1	1019	1459	1660
16	3	15	96.2	1180	1478	1144
17						
18						
19						
20						

Long Pulse Radar Test Signal

Test Signal Name: LP_Signal_16

Number of Bursts in Trial: 9

Burst	Pulses per Burst	Chrip (MHz)	Pulse Width(us)	PRI-1 (us)	PRI-2 (us)	PRI-3 (us)
1	1	6	54.7	1880	-	-
2	1	6	66.4	1151	-	-
3	2	6	80.7	1257	1565	-
4	2	6	68.1	1522	1374	-
5	1	6	52.7	1785	-	-
6	3	6	85.4	1101	1767	1094
7	2	6	77	1979	1717	-
8	2	6	81.3	1312	1761	-
9	2	6	69.1	1594	1265	-
10						
11						
12						
13						
14						
15						
16						
17						
18						
19						
20						



Long Pulse Radar Test Signal

Test Signal Name: LP_Signal_17

Number of Bursts in Trial: 12

Burst	Pulses per Burst	Chrip (MHz)	Pulse Width(us)	PRI-1 (us)	PRI-2 (us)	PRI-3 (us)
1	2	10	75.4	1135	1514	-
2	3	10	95.3	1331	1859	1869
3	3	10	94.8	1990	1021	1984
4	2	10	70.4	1557	1696	-
5	2	10	82.8	1232	1008	-
6	1	10	61.8	1584	-	-
7	2	10	77.6	1529	1946	-
8	1	10	50.6	1097	-	-
9	2	10	70.7	1920	1809	-
10	2	10	68.7	1036	1658	-
11	2	10	70.8	1053	1568	-
12	3	10	85.9	1723	1559	1679
13						
14						
15						
16						
17						
18						
19						
20						

Long Pulse Radar Test Signal

Test Signal Name: LP_Signal_18

Number of Bursts in Trial: 15

Burst	Pulses per Burst	Chrip (MHz)	Pulse Width(us)	PRI-1 (us)	PRI-2 (us)	PRI-3 (us)
1	2	14	80.5	1792	1708	-
2	2	14	68.6	1413	1083	-
3	1	14	62.6	1887	-	-
4	3	14	87.3	1653	1709	1604
5	1	14	57.1	1479	-	-
6	3	14	87	1168	1444	1082
7	2	14	78.3	1060	1491	-
8	2	14	74.7	1300	1157	-
9	2	14	74.3	1742	1431	-
10	2	14	75.3	1771	1786	-
11	2	14	68.7	1555	1088	-
12	3	14	98.9	1885	1005	1429
13	2	14	80.1	1609	1342	-
14	3	14	88.2	1911	1511	1575
15	3	14	87.5	1038	1024	1517
16						
17						
18						
19						
20						



Long Pulse Radar Test Signal

Test Signal Name: LP_Signal_19

Number of Bursts in Trial: 13

Burst	Pulses per Burst	Chrip (MHz)	Pulse Width(us)	PRI-1 (us)	PRI-2 (us)	PRI-3 (us)
1	3	11	96	1802	1598	1692
2	2	11	73.8	1276	1895	-
3	2	11	71.8	1749	1258	-
4	3	11	84.5	1728	1301	1370
5	3	11	87.9	1868	1382	1746
6	2	11	76.6	1128	1256	-
7	3	11	84.6	1931	1062	1875
8	2	11	75.3	1704	1581	-
9	2	11	73.4	1614	1222	-
10	3	11	98.5	1188	1865	1065
11	2	11	75.7	1110	1272	-
12	1	11	53	1134	-	-
13	3	11	90.1	1645	1294	1958
14						
15						
16						
17						
18						
19						
20						

Long Pulse Radar Test Signal

Test Signal Name: LP_Signal_20

Number of Bursts in Trial: 13

Burst	Pulses per Burst	Chrip (MHz)	Pulse Width(us)	PRI-1 (us)	PRI-2 (us)	PRI-3 (us)
1	1	11	61.6	1596	-	-
2	3	11	91.8	1595	1014	1825
3	1	11	66.3	1084	-	-
4	2	11	69.1	1114	1951	-
5	2	11	75.2	1570	1889	-
6	1	11	60.3	1542	-	-
7	2	11	74.2	1536	1702	-
8	3	11	97.8	1361	1034	1483
9	2	11	68.1	1138	1663	-
10	2	11	80.8	1685	1204	-
11	3	11	95.6	1881	1242	1155
12	3	11	98.5	1175	1346	1253
13	3	11	98.7	1043	1020	1359
14						
15						
16						
17						
18						
19						
20						

Long Pulse Radar Test Signal

Test Signal Name: LP_Signal_21

Number of Bursts in Trial: 11

Burst	Pulses per Burst	Chrip (MHz)	Pulse Width(us)	PRI-1 (us)	PRI-2 (us)	PRI-3 (us)
1	1	8	56.6	1642	-	-
2	3	8	94.9	1901	1303	1906
3	1	8	50.1	1027	-	-
4	2	8	76.6	1842	1328	-
5	3	8	95.9	1734	1367	1067
6	3	8	90.3	1552	1500	1871
7	3	8	94.6	1304	1495	1592
8	2	8	74.4	1955	1947	-
9	2	8	81.6	1732	1923	-
10	2	8	76.8	1772	1235	-
11	3	8	98.9	1928	1646	1302
12						
13						
14						
15						
16						
17						
18						
19						
20						



Long Pulse Radar Test Signal

Test Signal Name: LP_Signal_22

Number of Bursts in Trial: 16

Burst	Pulses per Burst	Chrip (MHz)	Pulse Width(us)	PRI-1 (us)	PRI-2 (us)	PRI-3 (us)
1	3	15	84.2	1098	1297	1327
2	2	15	83	1805	1018	-
3	1	15	59.2	1892	-	-
4	3	15	95.9	1408	1635	1339
5	3	15	93.3	1426	1314	1285
6	3	15	89.2	1623	1579	1861
7	3	15	88.9	1938	1762	1288
8	2	15	81.5	1929	1554	-
9	3	15	83.9	1470	1026	1502
10	3	15	88.3	1194	1853	1722
11	1	15	63.1	1562	-	-
12	2	15	82.5	1023	1916	-
13	1	15	58.9	1952	-	-
14	3	15	99.6	1380	1261	1104
15	2	15	73.6	1733	1125	-
16	2	15	69.8	1469	1081	-
17						
18						
19						
20						



Long Pulse Radar Test Signal

Test Signal Name: LP_Signal_23

Number of Bursts in Trial: 8

Burst	Pulses per Burst	Chrip (MHz)	Pulse Width(us)	PRI-1 (us)	PRI-2 (us)	PRI-3 (us)
1	1	5	63.9	1997	-	-
2	3	5	89.7	1161	1591	1421
3	2	5	77.9	1563	1982	-
4	3	5	93.1	1981	1832	1179
5	2	5	76.3	1066	1820	-
6	3	5	86.1	1724	1725	1363
7	3	5	89.2	1255	1560	1454
8	2	5	70	1586	1225	-
9						
10						
11						-
12						-
13						
14						
15						
16						
17						
18						
19						
20						



Long Pulse Radar Test Signal

Test Signal Name: LP_Signal_24

Number of Bursts in Trial: 12

Burst	Pulses per Burst	Chrip (MHz)	Pulse Width(us)	PRI-1 (us)	PRI-2 (us)	PRI-3 (us)
1	3	10	89.8	1463	1392	1932
2	2	10	75.2	1492	1905	-
3	3	10	96.9	1515	1917	1698
4	1	10	52.5	1620	-	-
5	3	10	85.4	1798	1015	1525
6	1	10	58.4	1980	-	-
7	1	10	65.6	1706	-	-
8	2	10	80	1840	1713	-
9	1	10	65	1621	-	-
10	2	10	67.5	1401	1296	-
11	3	10	85	1390	1436	1846
12	3	10	92.3	1927	1280	1215
13						
14						
15						
16						
17						
18						
19						
20						

Long Pulse Radar Test Signal

Test Signal Name: LP_Signal_25

Number of Bursts in Trial: 15

Burst	Pulses per Burst	Chrip (MHz)	Pulse Width(us)	PRI-1 (us)	PRI-2 (us)	PRI-3 (us)
1	1	14	51	1497	-	-
2	2	14	78.3	1671	1111	-
3	1	14	54.4	1566	-	-
4	2	14	78.9	1229	1540	-
5	3	14	91.9	1737	1580	1780
6	1	14	64	1546	-	-
7	1	14	64.5	1247	-	-
8	1	14	60.4	1778	-	-
9	3	14	93.5	1788	1828	1777
10	1	14	62.3	1315	-	-
11	3	14	91.3	1943	1993	1292
12	2	14	77	1068	1639	-
13	2	14	72.3	1683	1490	-
14	2	14	70.5	1618	1069	-
15	2	14	80.7	1378	1654	-
16						
17						
18						
19						
20						



Long Pulse Radar Test Signal

Test Signal Name: LP_Signal_26

Number of Bursts in Trial: 14

Burst	Pulses per Burst	Chrip (MHz)	Pulse Width(us)	PRI-1 (us)	PRI-2 (us)	PRI-3 (us)
1	3	12	84.8	1919	1073	1619
2	1	12	53.7	1718	-	-
3	3	12	83.8	1787	1936	1076
4	2	12	72.6	1826	1208	-
5	3	12	98.1	1822	1039	1907
6	3	12	93.8	1341	1649	1145
7	3	12	89.3	1338	1369	1379
8	1	12	56.1	1434	-	-
9	2	12	68.1	1231	1207	-
10	3	12	92.4	1648	1851	1289
11	3	12	86.3	1934	1493	1033
12	3	12	96.2	1676	1074	1156
13	2	12	75.4	1117	1690	-
14	2	12	72.6	1368	1730	-
15						
16						
17						
18						
19						
20						



Long Pulse Radar Test Signal

Test Signal Name: LP_Signal_27

Number of Bursts in Trial: 18

Burst	Pulses per Burst	Chrip (MHz)	Pulse Width(us)	PRI-1 (us)	PRI-2 (us)	PRI-3 (us)
1	2	17	83.1	1075	1839	-
2	2	17	67.5	1001	1195	-
3	3	17	91.5	1659	1274	1317
4	1	17	64.6	1326	-	-
5	2	17	81.4	1071	1230	-
6	2	17	68.7	1971	1275	-
7	3	17	85.6	1329	1055	1252
8	3	17	85.2	1181	1149	1278
9	3	17	99	1174	1776	1512
10	1	17	51.1	1684	-	-
11	1	17	62.2	1666	-	-
12	2	17	71.6	1087	1244	-
13	2	17	78.8	1006	1593	-
14	2	17	76.5	1922	1420	-
15	2	17	77.5	1334	1693	-
16	3	17	84	1158	1535	1918
17	2	17	69.8	1915	1321	-
18	2	17	80.3	1051	1543	-
19						
20						

Long Pulse Radar Test Signal

Test Signal Name: LP_Signal_28

Number of Bursts in Trial: 11

Burst	Pulses per Burst	Chrip (MHz)	Pulse Width(us)	PRI-1 (us)	PRI-2 (us)	PRI-3 (us)
1	1	9	64.9	1126	-	-
2	2	9	77.8	1281	1818	-
3	2	9	80.9	1013	1630	-
4	2	9	76.2	1093	1939	-
5	2	9	81.3	1622	1755	-
6	3	9	94.9	1089	1695	1251
7	3	9	87	1883	1109	1751
8	3	9	98.5	1550	1416	1779
9	1	9	61.7	1047	-	-
10	2	9	72.2	1447	1471	-
11	3	9	86.4	1625	1637	1656
12						
13						
14						
15						
16						
17						
18						
19						
20						



Long Pulse Radar Test Signal

Test Signal Name: LP_Signal_29

Number of Bursts in Trial: 13

Burst	Pulses per Burst	Chrip (MHz)	Pulse Width(us)	PRI-1 (us)	PRI-2 (us)	PRI-3 (us)
1	3	12	86.6	1112	1152	1856
2	1	12	55.6	1816	-	-
3	2	12	67.9	1664	1212	-
4	3	12	89.1	1375	1376	1354
5	3	12	87.8	1582	1308	1383
6	1	12	60.4	1988	-	-
7	3	12	94.8	1356	1538	1843
8	3	12	99.8	1430	1902	1259
9	1	12	62.4	1508	-	-
10	3	12	90.9	1273	1119	1058
11	1	12	51.7	1608	-	-
12	3	12	95.2	1410	1406	1399
13	3	12	99.6	1569	1834	1450
14						
15						
16						
17						
18						
19						

Long Pulse Radar Test Signal

Test Signal Name: LP_Signal_30

Number of Bursts in Trial: 13

Burst	Pulses per Burst	Chrip (MHz)	Pulse Width(us)	PRI-1 (us)	PRI-2 (us)	PRI-3 (us)
1	1	11	54.8	1412	-	-
2	2	11	82.6	1141	1456	-
3	1	11	60.3	1096	-	-
4	2	11	76.5	1032	1953	-
5	1	11	65	1323	-	-
6	1	11	62.8	1804	-	-
7	2	11	78.7	1758	1964	-
8	3	11	84.2	1223	1983	1474
9	2	11	72.5	1099	1532	-
10	1	11	56	1108	-	-
11	2	11	81.3	1551	1307	-
12	3	11	97.7	1295	1893	1107
13	3	11	91.7	1044	1975	1962
14						
15						
16						
17						
18						
19						
20						



802.11ax (HE40)

Long Pulse Radar Test Signal

Test Signal Name: LP_Signal_01

Number of Bursts in Trial: 14

Burst	Pulses per Burst	Chrip (MHz)	Pulse Width(us)	PRI-1 (us)	PRI-2 (us)	PRI-3 (us)
1	2	12	73.8	1073	1713	-
2	3	12	85.2	1207	1828	1620
3	1	12	64.4	1691	-	-
4	1	12	60.3	1775	-	-
5	2	12	71.1	1989	1229	-
6	3	12	86.2	1788	1134	1384
7	3	12	92.8	1757	1984	1778
8	2	12	78.7	1920	1540	-
9	2	12	81.4	1393	1130	-
10	1	12	51.8	1021	-	-
11	3	12	87.9	1260	1473	1243
12	2	12	68.1	1461	1634	-
13	1	12	62.7	1854	-	-
14	1	12	52.4	1145	-	-
15	-	-	-	-	-	-
16	-	-	-	-	-	-
17	-	-	-	-	-	-
18	-	-	-	-	-	-
19	-	-	-	-	-	-
20	-	-	-	-	-	-

Long Pulse Radar Test Signal

Test Signal Name: LP_Signal_02

Number of Bursts in Trial: 17

Burst	Pulses per Burst	Chrip (MHz)	Pulse Width(us)	PRI-1 (us)	PRI-2 (us)	PRI-3 (us)
1	2	16	79	1523	1645	-
2	3	16	87.2	1009	1085	1169
3	2	16	82.5	1543	1538	-
4	2	16	67.8	1642	1459	-
5	3	16	89.5	1179	1797	1764
6	2	16	75.8	1014	1030	-
7	1	16	59	1908	-	-
8	3	16	99.3	1682	1722	1177
9	1	16	58.7	1616	-	-
10	1	16	64.1	1186	-	-
11	2	16	67.2	1007	1591	-
12	3	16	84.7	1481	1923	1855
13	3	16	99.8	1470	1748	1447
14	1	16	50.8	1019	-	-
15	1	16	54.5	1799	-	-
16	3	16	95	1252	1344	1956
17	3	16	99.2	1218	1094	1472
18	-	-	-	-	-	-
19	-	-	-	-	-	-
20	-	-	-	-	-	-

Long Pulse Radar Test Signal

Test Signal Name: LP_Signal_03

Number of Bursts in Trial: 11

Burst	Pulses per Burst	Chrip (MHz)	Pulse Width(us)	PRI-1 (us)	PRI-2 (us)	PRI-3 (us)
1	3	9	100	1595	1705	1361
2	2	9	83.2	1851	1368	-
3	3	9	97.2	1483	1567	1563
4	3	9	94	1741	1710	1084
5	1	9	57.1	1763	-	-
6	2	9	82.1	1160	1712	-
7	2	9	76.9	1002	1496	-
8	3	9	85.1	1396	1062	1617
9	1	9	62.3	1789	-	-
10	2	9	69.3	1858	1987	-
11	2	9	69.3	1029	1015	-
12	-	-	-	-	-	-
13	-	-	-	-	-	-
14	-	-	-	-	-	-
15	-	-	-	-	-	-
16	-	-	-	-	-	-
17	-	-	-	-	-	-
18	-	-	-	-	-	-
19	-	-	-	-	-	-
20	-	-	-	-	-	-



Long Pulse Radar Test Signal

Test Signal Name: LP_Signal_04

Number of Bursts in Trial: 10

Burst	Pulses per Burst	Chrip (MHz)	Pulse Width(us)	PRI-1 (us)	PRI-2 (us)	PRI-3 (us)
1	3	8	87.3	1941	1435	1728
2	1	8	55	1336	-	-
3	1	8	51.5	1551	-	-
4	2	8	74.2	1791	1913	-
5	3	8	93.8	1727	1648	1742
6	3	8	84	1660	1474	1440
7	3	8	88.4	1288	1909	1739
8	2	8	76.5	1188	1036	-
9	2	8	73.6	1092	1887	-
10	3	8	93.7	1471	1824	1032
11	-	-	-	-	-	-
12	-	-	-	-	-	-
13	-	-	-	-	-	-
14	-	-	-	-	-	-
15	-	-	-	-	-	-
16	-	-	-	-	-	-
17	-	-	-	-	-	-
18	-	-	-	-	-	-
19	-	-	-	-	-	-
20	-	-	-	-	-	-

Long Pulse Radar Test Signal

Test Signal Name: LP_Signal_05

Number of Bursts in Trial: 13

Burst	Pulses per Burst	Chrip (MHz)	Pulse Width(us)	PRI-1 (us)	PRI-2 (us)	PRI-3 (us)
1	1	11	65.3	1857	-	-
2	2	11	68.9	1059	1100	-
3	3	11	90.7	1001	1629	1150
4	2	11	74.6	1245	1132	-
5	2	11	76.5	1837	1237	-
6	1	11	50.3	1374	-	-
7	3	11	93.2	1535	1225	1502
8	3	11	86.4	1356	1991	1590
9	3	11	86.4	1501	1951	1706
10	3	11	91.9	1248	1843	1182
11	2	11	74.1	1176	1307	-
12	3	11	86.4	1217	1268	1935
13	1	11	52.6	1304	-	-
14	-	-	-	-	-	-
15	-	-	-	-	-	-
16	-	-	-	-	-	-
17	-	-	-	-	-	-
18	-	-	-	-	-	-
19	-	-	-	-	-	-
20	-	-	-	-	-	-

Long Pulse Radar Test Signal

Test Signal Name: LP_Signal_06

Number of Bursts in Trial: 17

Burst	Pulses per Burst	Chrip (MHz)	Pulse Width(us)	PRI-1 (us)	PRI-2 (us)	PRI-3 (us)
1	3	16	87.9	1696	1985	1064
2	3	16	85	1979	1272	1922
3	1	16	65.5	1510	-	-
4	1	16	58.5	1482	-	-
5	2	16	71.8	1898	1156	-
6	1	16	55	1072	-	-
7	1	16	55.6	1276	-	-
8	2	16	82.7	1618	1655	-
9	2	16	77.1	1845	1902	-
10	1	16	56.5	1115	-	-
11	3	16	89.8	1086	1444	1680
12	1	16	61.9	1560	-	-
13	1	16	53.7	1151	-	-
14	1	16	62.5	1550	-	-
15	3	16	93	1232	1221	1322
16	3	16	91	1743	1168	1822
17	1	16	65.8	1323	-	-
18	-	-	-	-	-	-
19	-	-	-	-	-	-
20	-	-	-	-	-	-

Long Pulse Radar Test Signal

Test Signal Name: LP_Signal_07

Number of Bursts in Trial: 19

Burst	Pulses per Burst	Chrip (MHz)	Pulse Width(us)	PRI-1 (us)	PRI-2 (us)	PRI-3 (us)
1	1	18	62.5	1242	-	-
2	2	18	78.1	1438	1261	-
3	2	18	71.3	1337	1087	-
4	1	18	55.4	1534	-	-
5	3	18	84.6	1345	1430	1885
6	1	18	64.2	1441	-	-
7	1	18	56.5	1371	-	-
8	2	18	69.4	1333	1407	-
9	2	18	80.7	1102	1564	-
10	2	18	81.7	1849	1113	-
11	3	18	83.8	1016	1425	1166
12	3	18	98.7	1429	1640	1943
13	2	18	75.9	1542	1408	-
14	2	18	77.4	1241	1505	-
15	3	18	95.2	1974	1295	1816
16	1	18	50.9	1641	-	-
17	1	18	52.3	1780	-	-
18	1	18	63.7	1872	-	-
19	3	18	89.3	1860	1083	1399
20	-	-	-	-	-	-

Long Pulse Radar Test Signal

Test Signal Name: LP_Signal_08

Number of Bursts in Trial: 15

Burst	Pulses per Burst	Chrip (MHz)	Pulse Width(us)	PRI-1 (us)	PRI-2 (us)	PRI-3 (us)
1	2	14	78.2	1215	1274	-
2	2	14	75.4	1120	1751	-
3	1	14	66.5	1793	-	-
4	2	14	71.5	1852	1066	-
5	2	14	68	1258	1457	-
6	1	14	60.9	1463	-	-
7	3	14	88.2	1076	1819	1525
8	1	14	62.4	1952	-	-
9	1	14	50.9	1192	-	-
10	1	14	62.6	1201	-	-
11	2	14	72.8	1126	1357	-
12	3	14	87.9	1627	1458	1880
13	1	14	50.1	1802	-	-
14	3	14	95.4	1928	1324	1947
15	2	14	70.5	1619	1562	-
16	-	-	-	-	-	-
17	-	-	-	-	-	-
18	-	-	-	-	-	-
19	-	-	-	-	-	-
20	-	-	-	-	-	-

Long Pulse Radar Test Signal

Test Signal Name: LP_Signal_09

Number of Bursts in Trial: 16

Burst	Pulses per Burst	Chrip (MHz)	Pulse Width(us)	PRI-1 (us)	PRI-2 (us)	PRI-3 (us)
1	2	15	79.4	1891	1692	-
2	3	15	96.1	1424	1325	1175
3	1	15	65	1500	-	-
4	3	15	97.2	1770	1740	1005
5	1	15	53.2	1135	-	-
6	2	15	70.8	1809	1081	-
7	1	15	58.9	1668	-	-
8	3	15	89.2	1526	1111	1649
9	3	15	91.2	1664	1414	1303
10	2	15	73.4	1063	1317	-
11	2	15	71.8	1997	1313	-
12	3	15	84.1	1686	1609	1633
13	1	15	51.1	1061	-	-
14	2	15	79.2	1755	1803	-
15	3	15	94.6	1380	1140	1044
16	1	15	61	1465	-	-
17	-	-	-	-	-	-
18	-	-	-	-	-	-
19	-	-	-	-	-	-
20	-	-	-	-	-	-

Long Pulse Radar Test Signal

Test Signal Name: LP_Signal_10

Number of Bursts in Trial: 8

Burst	Pulses per Burst	Chrip (MHz)	Pulse Width(us)	PRI-1 (us)	PRI-2 (us)	PRI-3 (us)
1	1	5	51.3	1829	-	-
2	3	5	98.9	1897	1346	1605
3	1	5	53.7	1498	-	-
4	1	5	62.8	1900	-	-
5	3	5	90.4	1730	1986	1008
6	3	5	96	1433	1187	1808
7	1	5	56.5	1654	-	-
8	1	5	53.3	1398	-	-
9	-	-	-	-	-	-
10	-	-	-	-	-	-
11	-	-	-	-	-	-
12	-	-	-	-	-	-
13	-	-	-	-	-	-
14	-	-	-	-	-	-
15	-	-	-	-	-	-
16	-	-	-	-	-	-
17	-	-	-	-	-	-
18	-	-	-	-	-	-
19	-	-	-	-	-	-
20	-	-	-	-	-	-

Long Pulse Radar Test Signal

Test Signal Name: LP_Signal_11

Number of Bursts in Trial: 17

Burst	Pulses per Burst	Chrip (MHz)	Pulse Width(us)	PRI-1 (us)	PRI-2 (us)	PRI-3 (us)
1	3	17	94.6	1504	1284	1273
2	3	17	96.4	1224	1105	1725
3	1	17	51.8	1931	-	-
4	1	17	55.6	1269	-	-
5	1	17	56.7	1976	-	-
6	1	17	57.9	1911	-	-
7	3	17	93.9	1026	1761	1754
8	3	17	83.7	1841	1388	1366
9	1	17	53.3	1257	-	-
10	1	17	55.4	1518	-	-
11	3	17	98.1	1671	1046	1193
12	3	17	99.2	1104	1861	1434
13	3	17	85.9	1972	1503	1916
14	1	17	55.1	1792	-	-
15	1	17	60.4	1623	-	-
16	2	17	68.4	1929	1821	-
17	2	17	69.3	1211	1883	-
18	-	-	-	-	-	-
19	-	-	-	-	-	-
20	-	-	-	-	-	-

Long Pulse Radar Test Signal

Test Signal Name: LP_Signal_12

Number of Bursts in Trial: 12

Burst	Pulses per Burst	Chrip (MHz)	Pulse Width(us)	PRI-1 (us)	PRI-2 (us)	PRI-3 (us)
1	3	10	86.3	1342	1681	1601
2	2	10	75.4	1420	1865	-
3	3	10	98.1	1394	1622	1406
4	3	10	96.2	1942	1708	1053
5	2	10	76.9	1689	1932	-
6	3	10	87.1	1329	1807	1362
7	2	10	83.2	1732	1926	-
8	1	10	56.4	1784	-	-
9	1	10	51.6	2000	-	-
10	2	10	71.4	1998	1330	-
11	3	10	89.1	1514	1485	1582
12	3	10	96.4	1143	1576	1847
13	-	-	-	-	-	-
14	-	-	-	-	-	-
15	-	-	-	-	-	-
16	-	-	-	-	-	-
17	-	-	-	-	-	-
18	-	-	-	-	-	-
19	-	-	-	-	-	-
20	-	-	-	-	-	-

Long Pulse Radar Test Signal

Test Signal Name: LP_Signal_13

Number of Bursts in Trial: 11

Burst	Pulses per Burst	Chrip (MHz)	Pulse Width(us)	PRI-1 (us)	PRI-2 (us)	PRI-3 (us)
1	2	9	82.6	1970	1494	-
2	2	9	80.1	1946	1173	-
3	3	9	83.4	1028	1283	1863
4	3	9	89.5	1693	1253	1153
5	1	9	61.7	1338	-	-
6	1	9	52.6	1267	-	-
7	1	9	56.9	1774	-	-
8	2	9	69	1899	1263	-
9	1	9	53.2	1695	-	-
10	2	9	82.5	1866	1172	-
11	2	9	83.3	1716	1428	-
12	-	-	-	-	-	-
13	-	-	-	-	-	-
14	-	-	-	-	-	-
15	-	-	-	-	-	-
16	-	-	-	-	-	-
17	-	-	-	-	-	-
18	-	-	-	-	-	-
19	-	-	-	-	-	-
20	-	-	-	-	-	-



Long Pulse Radar Test Signal

Test Signal Name: LP_Signal_14

Number of Bursts in Trial: 8

Burst	Pulses per Burst	Chrip (MHz)	Pulse Width(us)	PRI-1 (us)	PRI-2 (us)	PRI-3 (us)
1	2	5	79.5	1401	1823	-
2	3	5	88.2	1107	1040	1353
3	2	5	80.8	1737	1873	-
4	3	5	95.8	1566	1729	1812
5	2	5	81.1	1796	1117	-
6	3	5	95.4	1558	1006	1769
7	2	5	75.1	1679	1584	-
8	3	5	96.2	1528	1630	1578
9	-	-	-	-	-	-
10	-	-	-	-	-	-
11	-	-	-	-	-	-
12	-	-	-	-	-	-
13	-	-	-	-	-	-
14	-	-	-	-	-	-
15	-	-	-	-	-	-
16	-	-	-	-	-	-
17	-	-	-	-	-	-
18	-	-	-	-	-	-
19	-	-	-	-	-	-
20	-	-	-	-	-	-

Long Pulse Radar Test Signal

Test Signal Name: LP_Signal_15

Number of Bursts in Trial: 15

Burst	Pulses per Burst	Chrip (MHz)	Pulse Width(us)	PRI-1 (us)	PRI-2 (us)	PRI-3 (us)
1	3	14	88.4	1293	1249	1653
2	3	14	85.4	1720	1703	1417
3	3	14	93.5	1469	1831	1869
4	1	14	54.1	1963	-	-
5	2	14	70.6	1181	1110	-
6	1	14	58.5	1390	-	-
7	1	14	57.2	1382	-	-
8	2	14	67.6	1598	1189	-
9	1	14	59.3	1208	-	-
10	2	14	68.6	1669	1573	-
11	3	14	99.3	1400	1826	1907
12	1	14	55	1683	-	-
13	3	14	86.5	1050	1296	1919
14	1	14	54.8	1577	-	-
15	3	14	87.3	1699	1409	1491
16	-	-	-	-	-	-
17	-	-	-	-	-	-
18	-	-	-	-	-	-
19	-	-	-	-	-	-
20	-	-	-	-	-	-

Long Pulse Radar Test Signal

Test Signal Name: LP_Signal_16

Number of Bursts in Trial: 17

Burst	Pulses per Burst	Chrip (MHz)	Pulse Width(us)	PRI-1 (us)	PRI-2 (us)	PRI-3 (us)
1	2	16	70.7	1183	1112	-
2	2	16	75.3	1524	1975	-
3	1	16	64.6	1771	-	-
4	1	16	59.6	1122	-	-
5	2	16	74.2	1955	1827	-
6	1	16	52.5	1559	-	-
7	1	16	53.5	1879	-	-
8	3	16	99.5	1131	1726	1395
9	1	16	66	1038	-	-
10	1	16	53.8	1901	-	-
11	3	16	92.2	1782	1715	1108
12	2	16	68.6	1082	1476	-
13	1	16	57.9	1638	-	-
14	3	16	96.2	1643	1790	1636
15	3	16	91.3	1282	1343	1548
16	1	16	52	1814	-	-
17	1	16	61	1539	-	-
18	-	-	-	-	-	-
19	-	-	-	-	-	-
20	-	-	-	-	-	-

Long Pulse Radar Test Signal

Test Signal Name: LP_Signal_17

Number of Bursts in Trial: 16

Burst	Pulses per Burst	Chrip (MHz)	Pulse Width(us)	PRI-1 (us)	PRI-2 (us)	PRI-3 (us)
1	2	15	76.5	1299	1694	-
2	2	15	75.2	1945	1650	-
3	1	15	50.6	1874	-	-
4	1	15	61	1555	-	-
5	3	15	89.1	1798	1835	1719
6	2	15	76	1833	1223	-
7	1	15	62.7	1734	-	-
8	2	15	81	1098	1936	-
9	1	15	54.4	1037	-	-
10	3	15	85	1581	1058	1762
11	3	15	97.6	1995	1109	1460
12	1	15	50.3	1198	-	-
13	1	15	54	1613	-	-
14	2	15	77.4	1065	1236	-
15	3	15	96.8	1529	1056	1402
16	2	15	74.7	1088	1806	-
17	-	-	-	-	-	-
18	-	-	-	-	-	-
19	-	-	-	-	-	-
20	-	-	-	-	-	-

Long Pulse Radar Test Signal

Test Signal Name: LP_Signal_18

Number of Bursts in Trial: 12

Burst	Pulses per Burst	Chrip (MHz)	Pulse Width(us)	PRI-1 (us)	PRI-2 (us)	PRI-3 (us)
1	1	10	50.9	1537	-	-
2	1	10	60	1372	-	-
3	2	10	70.5	1767	1615	-
4	1	10	66.4	1800	-	-
5	3	10	85.7	1364	1801	1067
6	1	10	50.9	1203	-	-
7	3	10	93.7	1996	1354	1881
8	3	10	84.9	1724	1448	1864
9	3	10	85.9	1596	1890	1917
10	2	10	77.5	1101	1557	-
11	1	10	50.3	1597	-	-
12	2	10	78.5	1379	1519	-
13	-	-	-	-	-	-
14	-	-	-	-	-	-
15	-	-	-	-	-	-
16	-	-	-	-	-	-
17	-	-	-	-	-	-
18	-	-	-	-	-	-
19	-	-	-	-	-	-
20	-	-	-	-	-	-

Long Pulse Radar Test Signal

Test Signal Name: LP_Signal_19

Number of Bursts in Trial: 18

Burst	Pulses per Burst	Chrip (MHz)	Pulse Width(us)	PRI-1 (us)	PRI-2 (us)	PRI-3 (us)
1	3	17	89.9	1422	1776	1096
2	3	17	99.3	1043	1270	1089
3	2	17	71.5	1673	1163	-
4	2	17	68.1	1702	1080	-
5	1	17	66.5	1097	-	-
6	3	17	88.3	1238	1119	1139
7	2	17	78.5	1389	1199	-
8	1	17	61.2	1959	-	-
9	1	17	54.1	1442	-	-
10	2	17	76.3	1676	1114	-
11	2	17	81.6	1977	1127	-
12	3	17	99.4	1468	1133	1644
13	1	17	51.9	1490	-	-
14	2	17	78.7	1439	1589	-
15	2	17	69.7	1316	1331	-
16	2	17	67.5	1281	1157	-
17	1	17	55.9	1068	-	-
18	3	17	99.2	1453	1054	1049
19	-	-	-	-	-	-
20	-	-	-	-	-	-

Long Pulse Radar Test Signal

Test Signal Name: LP_Signal_20

Number of Bursts in Trial: 14

Burst	Pulses per Burst	Chrip (MHz)	Pulse Width(us)	PRI-1 (us)	PRI-2 (us)	PRI-3 (us)
1	1	13	62	1895	-	-
2	2	13	76.4	1477	1375	-
3	3	13	95.4	1358	1456	1745
4	3	13	93.9	1773	1190	1556
5	1	13	57	1646	-	-
6	3	13	86.1	1154	1144	1123
7	2	13	70.8	1328	1423	-
8	3	13	85.7	1148	1707	1078
9	2	13	75.3	1667	1746	-
10	2	13	75.5	1204	1466	-
11	2	13	81.6	1334	1588	-
12	1	13	65.7	1231	-	-
13	2	13	75.1	1499	1662	-
14	1	13	61.6	1071	-	-
15	-	-	-	-	-	-
16	-	-	-	-	-	-
17	-	-	-	-	-	-
18	-	-	-	-	-	-
19	-	-	-	-	-	-
20	-	-	-	-	-	-

Long Pulse Radar Test Signal

Test Signal Name: LP_Signal_21

Number of Bursts in Trial: 10

Burst	Pulses per Burst	Chrip (MHz)	Pulse Width(us)	PRI-1 (us)	PRI-2 (us)	PRI-3 (us)
1	2	7	75.6	1511	1966	-
2	3	7	84.3	1162	1834	1625
3	3	7	91.1	1704	1039	1674
4	1	7	55.1	1747	-	-
5	1	7	63.5	1259	-	-
6	2	7	79.4	1675	1948	-
7	3	7	83.8	1914	1052	1099
8	1	7	65.7	1842	-	-
9	3	7	98.9	1484	1921	1219
10	3	7	85.6	1894	1159	1195
11	-	-	-	-	-	-
12	-	-	-	-	-	-
13	-	-	-	-	-	-
14	-	-	-	-	-	-
15	-	-	-	-	-	-
16	-	-	-	-	-	-
17	-	-	-	-	-	-
18	-	-	-	-	-	-
19	-	-	-	-	-	-
20	-	-	-	-	-	-

Long Pulse Radar Test Signal

Test Signal Name: LP_Signal_22

Number of Bursts in Trial: 20

Burst	Pulses per Burst	Chrip (MHz)	Pulse Width(us)	PRI-1 (us)	PRI-2 (us)	PRI-3 (us)
1	2	20	70.6	1415	1214	-
2	2	20	74.7	1234	1290	-
3	2	20	78.4	1777	1405	-
4	2	20	71.2	1048	1455	-
5	1	20	64.5	1161	-	-
6	1	20	57	1536	-	-
7	2	20	81.3	1264	1093	-
8	2	20	76.2	1452	1128	-
9	2	20	79	1497	1103	-
10	3	20	86.8	1205	1608	1522
11	1	20	65.4	1352	-	-
12	2	20	73.9	1749	1319	-
13	2	20	83.2	1836	1632	-
14	3	20	96.1	1546	1840	1973
15	3	20	92.3	1626	1121	1930
16	3	20	85.4	1532	1486	1635
17	3	20	97.4	1868	1419	1348
18	2	20	80.9	1347	1572	-
19	1	20	62.9	1381	-	-
20	1	20	52.9	1786	-	-

Long Pulse Radar Test Signal

Test Signal Name: LP_Signal_23

Number of Bursts in Trial: 10

Burst	Pulses per Burst	Chrip (MHz)	Pulse Width(us)	PRI-1 (us)	PRI-2 (us)	PRI-3 (us)
1	2	7	79.7	1045	1312	-
2	3	7	88.5	1871	1999	1804
3	1	7	51.1	1606	-	-
4	2	7	69.9	1516	1280	-
5	2	7	73.7	1670	1289	-
6	2	7	67.6	1180	1051	-
7	3	7	87.6	1886	1967	1521
8	1	7	64.5	1418	-	-
9	1	7	54	1602	-	-
10	2	7	76.5	1637	1018	-
11	-	-	-	-	-	-
12	-	-	-	-	-	-
13	-	-	-	-	-	-
14	-	-	-	-	-	-
15	-	-	-	-	-	-
16	-	-	-	-	-	-
17	-	-	-	-	-	-
18	-	-	-	-	-	-
19	-	-	-	-	-	-
20	-	-	-	-	-	-

Long Pulse Radar Test Signal

Test Signal Name: LP_Signal_24

Number of Bursts in Trial: 11

Burst	Pulses per Burst	Chrip (MHz)	Pulse Width(us)	PRI-1 (us)	PRI-2 (us)	PRI-3 (us)
1	1	9	65.3	1202	-	-
2	3	9	96.3	1666	1118	1271
3	2	9	77.5	1250	1285	-
4	1	9	59.8	1750	-	-
5	2	9	73.3	1210	1934	-
6	2	9	82.4	1758	1138	-
7	1	9	57.7	1527	-	-
8	3	9	99.6	1403	1146	1574
9	2	9	71.1	1171	1867	-
10	2	9	68.3	1239	1206	-
11	3	9	94.3	1152	1933	1892
12	-	-	-	-	-	-
13	-	-	-	-	-	-
14	-	-	-	-	-	-
15	-	-	-	-	-	-
16	-	-	-	-	-	-
17	-	-	-	-	-	-
18	-	-	-	-	-	-
19	-	-	-	-	-	-
20	-	-	-	-	-	-

Long Pulse Radar Test Signal

Test Signal Name: LP_Signal_25

Number of Bursts in Trial: 12

Burst	Pulses per Burst	Chrip (MHz)	Pulse Width(us)	PRI-1 (us)	PRI-2 (us)	PRI-3 (us)
1	1	10	55.4	1981	-	-
2	3	10	86.8	1968	1547	1363
3	3	10	88.4	1017	1656	1862
4	3	10	96.3	1025	1954	1158
5	1	10	51.6	1718	-	-
6	1	10	51	1944	-	-
7	3	10	95.1	1611	1075	1940
8	1	10	62.9	1612	-	-
9	2	10	78.1	1815	1013	-
10	2	10	82.1	1450	1969	-
11	1	10	52.9	1698	-	-
12	1	10	52.8	1034	-	-
13	-	-	-	-	-	-
14	-	-	-	-	-	-
15	-	-	-	-	-	-
16	-	-	-	-	-	-
17	-	-	-	-	-	-
18	-	-	-	-	-	-
19	-	-	-	-	-	-
20	-	-	-	-	-	-

Long Pulse Radar Test Signal

Test Signal Name: LP_Signal_26

Number of Bursts in Trial: 17

Burst	Pulses per Burst	Chrip (MHz)	Pulse Width(us)	PRI-1 (us)	PRI-2 (us)	PRI-3 (us)
1	3	16	95.9	1359	1090	1965
2	1	16	55.8	1980	-	-
3	2	16	82.1	1768	1004	-
4	2	16	73.6	1594	1487	-
5	1	16	58.4	1467	-	-
6	3	16	97.5	1723	1391	1684
7	3	16	96.9	1554	1185	1988
8	2	16	69.4	1125	1607	-
9	2	16	66.7	1549	1805	-
10	2	16	72.1	1783	1672	-
11	1	16	52.4	1256	-	-
12	2	16	71.5	1478	1575	-
13	2	16	69.2	1579	1091	-
14	3	16	96.4	1663	1194	1174
15	2	16	73.4	1265	1553	-
16	2	16	72.8	1665	1903	-
17	1	16	59.9	1604	-	-
18	-	-	-	-	-	-
19	-	-	-	-	-	-
20	-	-	-	-	-	-

Long Pulse Radar Test Signal

Test Signal Name: LP_Signal_27

Number of Bursts in Trial: 20

Burst	Pulses per Burst	Chrip (MHz)	Pulse Width(us)	PRI-1 (us)	PRI-2 (us)	PRI-3 (us)
1	2	20	77.7	1308	1315	-
2	3	20	97.8	1136	1688	1446
3	1	20	59.8	1844	-	-
4	3	20	94.7	1142	1129	1291
5	1	20	58.7	1810	-	-
6	2	20	74.3	1012	1427	-
7	1	20	51.6	1918	-	-
8	1	20	62.7	1209	-	-
9	2	20	73.7	1294	1568	-
10	2	20	72	1454	1677	-
11	1	20	66.6	1585	-	-
12	3	20	92.6	1226	1200	1832
13	1	20	51.6	1367	-	-
14	2	20	75.9	1397	1785	-
15	3	20	94.5	1830	1155	1949
16	1	20	62.3	1287	-	-
17	3	20	93.5	1517	1254	1279
18	2	20	81.7	1910	1011	-
19	1	20	53.9	1462	-	-
20	3	20	91.2	1794	1531	1870

Long Pulse Radar Test Signal

Test Signal Name: LP_Signal_28

Number of Bursts in Trial: 8

Burst	Pulses per Burst	Chrip (MHz)	Pulse Width(us)	PRI-1 (us)	PRI-2 (us)	PRI-3 (us)
1	1	5	58.8	1306	-	-
2	3	5	99.3	1978	1027	1350
3	1	5	52	1386	-	-
4	2	5	74.2	1278	1222	-
5	3	5	98.9	1915	1760	1652
6	2	5	77.6	1042	1733	-
7	2	5	83.3	1255	1766	-
8	3	5	84.4	1912	1326	1493
9	-	-	-	-	-	-
10	-	-	-	-	-	-
11	-	-	-	-	-	-
12	-	-	-	-	-	-
13	-	-	-	-	-	-
14	-	-	-	-	-	-
15	-	-	-	-	-	-
16	-	-	-	-	-	-
17	-	-	-	-	-	-
18	-	-	-	-	-	-
19	-	-	-	-	-	-
20	-	-	-	-	-	-

Long Pulse Radar Test Signal

Test Signal Name: LP_Signal_29

Number of Bursts in Trial: 9

Burst	Pulses per Burst	Chrip (MHz)	Pulse Width(us)	PRI-1 (us)	PRI-2 (us)	PRI-3 (us)
1	2	6	66.8	1982	1878	-
2	2	6	77	2000	1247	-
3	1	6	55.2	1925	-	-
4	2	6	77.7	1896	1003	-
5	2	6	72.2	1850	1983	-
6	1	6	52.9	1765	-	-
7	1	6	50.4	1994	-	-
8	3	6	84.3	1302	1369	1600
9	3	6	93.2	1492	1779	1332
10	-	-	-	-	-	-
11	-	-	-	-	-	-
12	-	-	-	-	-	-
13	-	-	-	-	-	-
14	-	-	-	-	-	-
15	-	-	-	-	-	-
16	-	-	-	-	-	-
17	-	-	-	-	-	-
18	-	-	-	-	-	-
19	-	-	-	-	-	-
20	-	-	-	-	-	-

Long Pulse Radar Test Signal

Test Signal Name: LP_Signal_30

Number of Bursts in Trial: 19

Burst	Pulses per Burst	Chrip (MHz)	Pulse Width(us)	PRI-1 (us)	PRI-2 (us)	PRI-3 (us)
1	1	19	58.1	1376	-	-
2	3	19	87.2	1587	1277	1811
3	2	19	81.6	1164	1530	-
4	2	19	80.4	1413	1884	-
5	1	19	60.8	1055	-	-
6	3	19	84.8	1960	1731	1700
7	2	19	75.5	1958	1544	-
8	2	19	80.3	1022	1106	-
9	2	19	76.8	1533	1661	-
10	1	19	65	1141	-	-
11	3	19	96.3	1124	1856	1033
12	1	19	57.9	1443	-	-
13	1	19	59.2	1305	-	-
14	2	19	75.8	1927	1772	-
15	1	19	64.7	1541	-	-
16	2	19	69.4	1246	1825	-
17	2	19	81.6	1230	1571	-
18	1	19	51.1	1320	-	-
19	2	19	78.4	1950	1651	-
20	-	-	-	-	-	-

802.11ax (HE80)

Long Pulse Radar Test Signal

Test Signal Name: LP_Signal_01

Number of Bursts in Trial: 10

Burst	Pulses per Burst	Chrip (MHz)	Pulse Width(us)	PRI-1 (us)	PRI-2 (us)	PRI-3 (us)
1	1	7	58.8	1293	-	-
2	2	7	67.2	1731	1960	-
3	2	7	79	1043	1583	-
4	1	7	56.3	1074	-	-
5	2	7	74.3	1714	1429	-
6	2	7	79.4	1609	1083	-
7	3	7	94.4	1958	1101	1226
8	1	7	54.4	1947	-	-
9	3	7	87.1	1277	1626	1167
10	2	7	67.7	1820	1477	-
11	-	-	-	-	-	-
12						
13						
14	-	-	-	-	-	-
15	-	-	-	-	-	-
16	-	-	-	-	-	-
17	-	-	-	-	-	-
18	-	-	-	-	-	-
19	-	-	-	-	-	-
20	-	-	-	-	-	-

Long Pulse Radar Test Signal

Test Signal Name: LP_Signal_02

Number of Bursts in Trial: 12

Burst	Pulses per Burst	Chrip (MHz)	Pulse Width(us)	PRI-1 (us)	PRI-2 (us)	PRI-3 (us)
1	2	10	69.4	1974	1961	-
2	2	10	69.5	1140	1656	-
3	2	10	72	1863	1564	-
4	3	10	86.6	1887	1299	1953
5	3	10	94	1547	1148	1570
6	2	10	68.2	1409	1353	-
7	2	10	71.7	1909	1632	-
8	3	10	96.8	1337	1052	1212
9	1	10	51.6	1879	-	-
10	1	10	50	1483	-	-
11	2	10	68.8	1094	1738	-
12	1	10	59.6	1408	-	-
13	-	-	-	-	-	-
14	-	-	-	-	-	-
15	-	-	-	-	-	-
16	-	-	-	-	-	-
17	-	-	-	-	-	-
18	-	-	-	-	-	-
19	-	-	-	-	-	-
20	-	-	-	-	-	-

Long Pulse Radar Test Signal

Test Signal Name: LP_Signal_03

Number of Bursts in Trial: 15

Burst	Pulses per Burst	Chrip (MHz)	Pulse Width(us)	PRI-1 (us)	PRI-2 (us)	PRI-3 (us)
1	3	14	84.8	2000	1985	1126
2	2	14	71.3	1309	1366	-
3	1	14	61.3	1230	-	-
4	2	14	74.2	1450	1356	-
5	3	14	86.7	1907	1599	1390
6	2	14	79.7	1406	1328	-
7	2	14	78.9	1097	1734	-
8	1	14	57.3	1698	-	-
9	1	14	65.3	1028	-	-
10	2	14	68.5	1763	1135	-
11	1	14	64.1	1461	-	-
12	1	14	58.5	1515	-	-
13	1	14	51	1549	-	-
14	2	14	76.7	1750	1319	-
15	1	14	54.8	1315	-	-
16	-	-	-	-	-	-
17	-	-	-	-	-	-
18	-	-	-	-	-	-
19	-	-	-	-	-	-
20	-	-	-	-	-	-

Long Pulse Radar Test Signal

Test Signal Name: LP_Signal_04

Number of Bursts in Trial: 9

Burst	Pulses per Burst	Chrip (MHz)	Pulse Width(us)	PRI-1 (us)	PRI-2 (us)	PRI-3 (us)
1	3	7	83.6	1942	1574	1208
2	1	7	62.1	1943	-	-
3	2	7	67.8	1247	1407	-
4	1	7	64.7	1118	-	-
5	3	7	94.4	1657	1248	1116
6	3	7	94.8	1834	1012	1243
7	1	7	55.9	1840	-	-
8	3	7	88.9	1467	1757	1756
9	2	7	70.5	1772	1479	-
10	-	-	-	-	-	-
11	-	-	-	-	-	-
12	-	-	-	-	-	-
13	-	-	-	-	-	-
14	-	-	-	-	-	-
15	-	-	-	-	-	-
16	-	-	-	-	-	-
17	-	-	-	-	-	-
18	-	-	-	-	-	-
19	-	-	-	-	-	-
20	-	-	-	-	-	-

Long Pulse Radar Test Signal

Test Signal Name: LP_Signal_05

Number of Bursts in Trial: 12

Burst	Pulses per Burst	Chrip (MHz)	Pulse Width(us)	PRI-1 (us)	PRI-2 (us)	PRI-3 (us)
1	2	12	82.3	1451	1235	-
2	3	12	86	1809	1996	1426
3	2	12	75.9	1658	1495	-
4	3	12	96.5	1415	1660	1445
5	3	12	92.4	1272	1751	1080
6	1	12	60.6	1234	-	-
7	2	12	80.8	1902	1939	-
8	3	12	99.3	1038	1176	1301
9	2	12	82.5	1045	1802	-
10	1	12	57.7	1838	-	-
11	3	12	95.1	1933	1619	1730
12	1	12	50.1	1762	-	-
13	-	-	-	-	-	-
14	-	-	-	-	-	-
15	-	-	-	-	-	-
16	-	-	-	-	-	-
17	-	-	-	-	-	-
18	-	-	-	-	-	-
19	-	-	-	-	-	-
20	-	-	-	-	-	-

Long Pulse Radar Test Signal

Test Signal Name: LP_Signal_06

Number of Bursts in Trial: 15

Burst	Pulses per Burst	Chrip (MHz)	Pulse Width(us)	PRI-1 (us)	PRI-2 (us)	PRI-3 (us)
1	3	14	92.8	1541	1350	1159
2	1	14	64.7	1633	-	-
3	2	14	75.6	1355	1920	-
4	2	14	79.7	1458	1249	-
5	1	14	52.4	1414	-	-
6	1	14	50.8	1914	-	-
7	1	14	55.3	1711	-	-
8	1	14	63.5	1500	-	-
9	3	14	85.5	1983	1182	1976
10	2	14	67.3	1833	1497	-
11	1	14	63.3	1923	-	-
12	3	14	88.1	1134	1394	1769
13	3	14	84.7	1847	1241	1260
14	3	14	83.8	1411	1748	1039
15	3	14	85.4	1018	1908	1372
16	-	-	-	-	-	-
17	-	-	-	-	-	-
18	-	-	-	-	-	-
19	-	-	-	-	-	-
20	-	-	-	-	-	-

Long Pulse Radar Test Signal

Test Signal Name: LP_Signal_07

Number of Bursts in Trial: 19

Burst	Pulses per Burst	Chrip (MHz)	Pulse Width(us)	PRI-1 (us)	PRI-2 (us)	PRI-3 (us)
1	2	19	74.5	1348	1113	-
2	1	19	64.8	1371	-	-
3	2	19	78.8	1980	1569	-
4	2	19	82.5	1556	1791	-
5	3	19	90.8	1015	1950	1685
6	2	19	77.3	1302	1857	-
7	3	19	95.7	1002	1898	1899
8	3	19	97.4	1518	1873	1216
9	3	19	92.9	1866	1510	1514
10	2	19	81.5	1358	1921	-
11	2	19	68.8	1875	1693	-
12	2	19	76.1	1399	1469	-
13	1	19	53.4	1387	-	-
14	2	19	77.7	1865	1204	-
15	1	19	51.8	1765	-	-
16	3	19	94.2	1132	1488	1717
17	3	19	97.2	1851	1811	1746
18	3	19	88.5	1396	1121	1501
19	1	19	62	1507	-	-
20	-	-	-	-	-	-

Long Pulse Radar Test Signal

Test Signal Name: LP_Signal_08

Number of Bursts in Trial: 9

Burst	Pulses per Burst	Chrip (MHz)	Pulse Width(us)	PRI-1 (us)	PRI-2 (us)	PRI-3 (us)
1	2	6	75.1	1470	1308	-
2	1	6	50	1198	-	-
3	2	6	68.8	1536	1349	-
4	1	6	65.1	1286	-	-
5	1	6	53.4	1614	-	-
6	3	6	88	1852	1223	1168
7	1	6	65.1	1245	-	-
8	2	6	83.3	1800	1238	-
9	1	6	55.4	1622	-	-
10	-	-	-	-	-	-
11	-	-	-	-	-	-
12	-	-	-	-	-	-
13	-	-	-	-	-	-
14	-	-	-	-	-	-
15	-	-	-	-	-	-
16	-	-	-	-	-	-
17	-	-	-	-	-	-
18	-	-	-	-	-	-
19	-	-	-	-	-	-
20	-	-	-	-	-	-

Long Pulse Radar Test Signal

Test Signal Name: LP_Signal_09

Number of Bursts in Trial: 17

Burst	Pulses per Burst	Chrip (MHz)	Pulse Width(us)	PRI-1 (us)	PRI-2 (us)	PRI-3 (us)
1	1	16	65	1755	-	-
2	2	16	72.7	1741	1785	-
3	3	16	87.8	1149	1056	1493
4	1	16	61.8	1284	-	-
5	1	16	58.6	1175	-	-
6	2	16	75.3	1825	1009	-
7	1	16	56.2	1732	-	-
8	3	16	84.4	1292	1989	1605
9	1	16	53.6	1332	-	-
10	2	16	75.3	1482	1023	-
11	1	16	54.2	1455	-	-
12	2	16	72.8	2000	1342	-
13	3	16	97.1	1199	1158	1890
14	2	16	67.3	1035	1818	-
15	2	16	82.7	1611	1558	-
16	3	16	98.2	1252	1651	1922
17	3	16	83.7	1174	1878	1889
18	-	-	-	-	-	-
19	-	-	-	-	-	-
20	-	-	-	-	-	-

Long Pulse Radar Test Signal

Test Signal Name: LP_Signal_10

Number of Bursts in Trial: 12

Burst	Pulses per Burst	Chrip (MHz)	Pulse Width(us)	PRI-1 (us)	PRI-2 (us)	PRI-3 (us)
1	2	10	74.8	1064	1888	-
2	1	10	51.8	1543	-	-
3	3	10	85.8	1526	1813	1330
4	3	10	83.7	1795	1166	1460
5	2	10	73.1	1703	1975	-
6	1	10	66.2	1229	-	-
7	3	10	99.7	1324	1374	1972
8	2	10	72.7	1555	1476	-
9	1	10	58.7	1000	-	-
10	3	10	85.3	1431	1936	1439
11	1	10	55.7	1261	-	-
12	3	10	99.8	1102	1901	1997
13	-	-	-	-	-	-
14	-	-	-	-	-	-
15	-	-	-	-	-	-
16	-	-	-	-	-	-
17	-	-	-	-	-	-
18	-	-	-	-	-	-
19	-	-	-	-	-	-
20	-	-	-	-	-	-

Long Pulse Radar Test Signal

Test Signal Name: LP_Signal_11

Number of Bursts in Trial: 13

Burst	Pulses per Burst	Chrip (MHz)	Pulse Width(us)	PRI-1 (us)	PRI-2 (us)	PRI-3 (us)
1	2	11	75.4	1463	1677	-
2	3	11	94.5	1525	1211	1617
3	2	11	75.7	1202	1963	-
4	3	11	94.1	1645	1684	1191
5	3	11	90.2	1595	1200	1720
6	2	11	82.4	1722	1776	-
7	2	11	70.2	1579	1655	-
8	3	11	93.7	1635	1788	1862
9	1	11	56.9	1087	-	-
10	2	11	67.5	1552	1225	-
11	2	11	78.2	1228	1828	-
12	2	11	71.5	1250	1789	-
13	2	11	67.4	1298	1010	-
14	-	-	-	-	-	-
15	-	-	-	-	-	-
16	-	-	-	-	-	-
17	-	-	-	-	-	-
18	-	-	-	-	-	-
19	-	-	-	-	-	-
20	-	-	-	-	-	-

Long Pulse Radar Test Signal

Test Signal Name: LP_Signal_12

Number of Bursts in Trial: 13

Burst	Pulses per Burst	Chrip (MHz)	Pulse Width(us)	PRI-1 (us)	PRI-2 (us)	PRI-3 (us)
1	3	11	90.6	1770	1184	1671
2	2	11	71.9	1745	1314	-
3	3	11	84.3	1906	1666	1100
4	3	11	89.3	1438	1221	1886
5	2	11	78.1	1767	1537	-
6	2	11	82.8	1502	1739	-
7	3	11	86.1	1351	1530	1652
8	2	11	66.9	1590	1637	-
9	2	11	69.8	1109	1194	-
10	1	11	63.1	1808	-	-
11	1	11	63.2	1904	-	-
12	3	11	97.5	1357	1186	1354
13	2	11	71.8	1965	1259	-
14	-	-	-	-	-	-
15	-	-	-	-	-	-
16	-	-	-	-	-	-
17	-	-	-	-	-	-
18	-	-	-	-	-	-
19	-	-	-	-	-	-
20	-	-	-	-	-	-

Long Pulse Radar Test Signal

Test Signal Name: LP_Signal_13

Number of Bursts in Trial: 13

Burst	Pulses per Burst	Chrip (MHz)	Pulse Width(us)	PRI-1 (us)	PRI-2 (us)	PRI-3 (us)
1	3	12	91.9	1987	1209	1849
2	1	12	56.4	1117	-	-
3	3	12	88.2	1992	1491	1128
4	3	12	89.2	1607	1275	1594
5	3	12	99.9	1565	1596	1404
6	3	12	90	1815	1804	1291
7	1	12	50.5	1412	-	-
8	3	12	84.7	1480	1728	1215
9	2	12	78.3	1152	1581	-
10	2	12	80.8	1793	1417	-
11	2	12	78.6	1462	1814	-
12	2	12	78.7	1504	1081	-
13	1	12	56.8	1786	-	-
14	-	-	-	-	-	-
15	-	-	-	-	-	-
16	-	-	-	-	-	-
17	-	-	-	-	-	-
18	-	-	-	-	-	-
19	-	-	-	-	-	-
20	-	-	-	-	-	-

Long Pulse Radar Test Signal

Test Signal Name: LP_Signal_14

Number of Bursts in Trial: 17

Burst	Pulses per Burst	Chrip (MHz)	Pulse Width(us)	PRI-1 (us)	PRI-2 (us)	PRI-3 (us)
1	3	16	85	1141	1876	1339
2	1	16	62.5	1736	-	-
3	1	16	54.4	1615	-	-
4	2	16	76.7	1304	1568	-
5	1	16	57.2	1701	-	-
6	2	16	73.7	1079	1774	-
7	1	16	64.3	1540	-	-
8	1	16	66.3	1382	-	-
9	2	16	82.6	1214	1924	-
10	3	16	94.4	1435	1941	1692
11	1	16	65.3	1034	-	-
12	3	16	83.4	1691	1959	1145
13	2	16	80.7	1845	1311	-
14	1	16	52.5	1723	-	-
15	2	16	69.7	1760	1271	-
16	2	16	82.8	1037	1859	-
17	1	16	55.5	1662	-	-
18	-	-	-	-	-	-
19	-	-	-	-	-	-
20	-	-	-	-	-	-

Long Pulse Radar Test Signal

Test Signal Name: LP_Signal_15

Number of Bursts in Trial: 19

Burst	Pulses per Burst	Chrip (MHz)	Pulse Width(us)	PRI-1 (us)	PRI-2 (us)	PRI-3 (us)
1	2	19	81.4	1994	1327	-
2	1	19	62.4	1276	-	-
3	3	19	96.7	1123	1968	1210
4	2	19	68.4	1824	1668	-
5	3	19	90.5	1092	1588	1754
6	1	19	63.7	1333	-	-
7	1	19	55.5	1112	-	-
8	2	19	67.8	1869	1115	-
9	2	19	67.6	1077	1437	-
10	3	19	88.2	1338	1481	1855
11	2	19	71	1995	1098	-
12	2	19	82.7	1810	1990	-
13	1	19	62.3	1318	-	-
14	3	19	91.2	1940	1368	1624
15	1	19	55.6	1646	-	-
16	1	19	60.5	1054	-	-
17	2	19	71.2	1381	1452	-
18	3	19	97.9	1856	1213	1422
19	2	19	73.6	1104	1345	-
20	-	-	-	-	-	-

Long Pulse Radar Test Signal

Test Signal Name: LP_Signal_16

Number of Bursts in Trial: 12

Burst	Pulses per Burst	Chrip (MHz)	Pulse Width(us)	PRI-1 (us)	PRI-2 (us)	PRI-3 (us)
1	1	10	62.4	1787	-	-
2	3	10	93.1	1487	1610	1831
3	1	10	55.8	1823	-	-
4	3	10	89.6	1900	1031	1910
5	2	10	83.1	1613	1359	-
6	1	10	55.4	1796	-	-
7	1	10	59.3	1063	-	-
8	1	10	62.1	1492	-	-
9	2	10	72.8	1316	1443	-
10	1	10	55.7	1195	-	-
11	2	10	69.2	1884	1680	-
12	3	10	87.5	1727	1244	1551
13	-	-	-	-	-	-
14	-	-	-	-	-	-
15	-	-	-	-	-	-
16	-	-	-	-	-	-
17	-	-	-	-	-	-
18	-	-	-	-	-	-
19	-	-	-	-	-	-
20	-	-	-	-	-	-

Long Pulse Radar Test Signal

Test Signal Name: LP_Signal_17

Number of Bursts in Trial: 13

Burst	Pulses per Burst	Chrip (MHz)	Pulse Width(us)	PRI-1 (us)	PRI-2 (us)	PRI-3 (us)
1	2	11	80.8	1777	1618	-
2	1	11	51.8	1848	-	-
3	2	11	72.7	1520	1984	-
4	3	11	99.4	1954	1846	1647
5	1	11	66.2	1022	-	-
6	2	11	82.1	1927	1835	-
7	3	11	88.5	1326	1867	1106
8	3	11	94.5	1916	1005	1842
9	3	11	98.8	1060	1885	1288
10	3	11	99	1832	1133	1306
11	1	11	58.9	1201	-	-
12	3	11	89.7	1874	1336	1545
13	3	11	85.5	1227	1024	1496
14	-	-	-	-	-	-
15	-	-	-	-	-	-
16	-	-	-	-	-	-
17	-	-	-	-	-	-
18	-	-	-	-	-	-
19	-	-	-	-	-	-
20	-	-	-	-	-	-

Long Pulse Radar Test Signal

Test Signal Name: LP_Signal_18

Number of Bursts in Trial: 20

Burst	Pulses per Burst	Chrip (MHz)	Pulse Width(us)	PRI-1 (us)	PRI-2 (us)	PRI-3 (us)
1	3	19	93.4	1222	1490	1119
2	3	19	83.6	1237	1138	1971
3	2	19	70.3	1172	1163	-
4	1	19	53.2	1661	-	-
5	1	19	59.7	1957	-	-
6	2	19	72.9	1153	1385	-
7	1	19	59.4	1744	-	-
8	1	19	54.7	1257	-	-
9	3	19	96.2	1970	1058	1026
10	2	19	70.3	1591	1290	-
11	1	19	62.5	1893	-	-
12	2	19	75.5	1082	1764	-
13	2	19	72.8	1076	1180	-
14	1	19	63.5	1150	-	-
15	1	19	62.9	1513	-	-
16	2	19	81.2	1616	1048	-
17	1	19	51.6	1280	-	-
18	2	19	82.7	1485	1020	-
19	1	19	62.1	1164	-	-
20	3	19	98.5	1346	1681	1644

Long Pulse Radar Test Signal

Test Signal Name: LP_Signal_19

Number of Bursts in Trial: 8

Burst	Pulses per Burst	Chrip (MHz)	Pulse Width(us)	PRI-1 (us)	PRI-2 (us)	PRI-3 (us)
1	1	5	50.7	1233	-	-
2	3	5	90.2	1665	1706	1099
3	2	5	80.8	1817	1107	-
4	3	5	89.6	1710	1444	1544
5	3	5	91.8	1775	1640	1090
6	3	5	89.5	1124	1999	1883
7	2	5	78.5	1532	1321	-
8	2	5	82.8	1659	1300	-
9	-	-	-	-	-	-
10	-	-	-	-	-	-
11	-	-	-	-	-	-
12	-	-	-	-	-	-
13	-	-	-	-	-	-
14	-	-	-	-	-	-
15	-	-	-	-	-	-
16	-	-	-	-	-	-
17	-	-	-	-	-	-
18	-	-	-	-	-	-
19	-	-	-	-	-	-
20	-	-	-	-	-	-

Long Pulse Radar Test Signal

Test Signal Name: LP_Signal_20

Number of Bursts in Trial: 8

Burst	Pulses per Burst	Chrip (MHz)	Pulse Width(us)	PRI-1 (us)	PRI-2 (us)	PRI-3 (us)
1	1	5	53.4	1794	-	-
2	2	5	74.8	1489	1915	-
3	1	5	63.5	1473	-	-
4	3	5	84.2	1687	1218	1383
5	1	5	66.2	1344	-	-
6	1	5	54.1	1343	-	-
7	3	5	89.8	1509	1264	1178
8	2	5	71.9	1273	1593	-
9	-	-	-	-	-	-
10	-	-	-	-	-	-
11	-	-	-	-	-	-
12	-	-	-	-	-	-
13	-	-	-	-	-	-
14	-	-	-	-	-	-
15	-	-	-	-	-	-
16	-	-	-	-	-	-
17	-	-	-	-	-	-
18	-	-	-	-	-	-
19	-	-	-	-	-	-
20	-	-	-	-	-	-

Long Pulse Radar Test Signal

Test Signal Name: LP_Signal_21

Number of Bursts in Trial: 12

Burst	Pulses per Burst	Chrip (MHz)	Pulse Width(us)	PRI-1 (us)	PRI-2 (us)	PRI-3 (us)
1	3	11	89.1	1712	1011	1872
2	1	11	58.8	1205	-	-
3	1	11	63.1	1312	-	-
4	2	11	82.9	1918	1410	-
5	1	11	59.7	1442	-	-
6	2	11	82.8	1340	1310	-
7	3	11	84.7	1013	1139	1930
8	2	11	81.6	1548	1347	-
9	1	11	60.2	1584	-	-
10	2	11	73.9	1499	1634	-
11	3	11	93.4	1881	1379	1864
12	2	11	68.5	1160	1991	-
13	-	-	-	-	-	-
14	-	-	-	-	-	-
15	-	-	-	-	-	-
16	-	-	-	-	-	-
17	-	-	-	-	-	-
18	-	-	-	-	-	-
19	-	-	-	-	-	-
20	-	-	-	-	-	-

Long Pulse Radar Test Signal

Test Signal Name: LP_Signal_22

Number of Bursts in Trial: 10

Burst	Pulses per Burst	Chrip (MHz)	Pulse Width(us)	PRI-1 (us)	PRI-2 (us)	PRI-3 (us)
1	2	8	75.5	1830	1546	-
2	1	8	63.2	1506	-	-
3	3	8	97.1	1752	1979	1559
4	1	8	66.2	1192	-	-
5	3	8	96.8	1949	1826	1219
6	3	8	91.3	1317	1008	1812
7	3	8	84.7	1071	1498	1522
8	1	8	53.1	1524	-	-
9	1	8	52.7	1582	-	-
10	2	8	80.7	1562	1612	-
11	-	-	-	-	-	-
12	-	-	-	-	-	-
13	-	-	-	-	-	-
14	-	-	-	-	-	-
15	-	-	-	-	-	-
16	-	-	-	-	-	-
17	-	-	-	-	-	-
18	-	-	-	-	-	-
19	-	-	-	-	-	-
20	-	-	-	-	-	-

Long Pulse Radar Test Signal

Test Signal Name: LP_Signal_23

Number of Bursts in Trial: 17

Burst	Pulses per Burst	Chrip (MHz)	Pulse Width(us)	PRI-1 (us)	PRI-2 (us)	PRI-3 (us)
1	1	16	61.5	1391	-	-
2	2	16	70.3	1402	1578	-
3	3	16	94.4	1154	1523	1044
4	2	16	76.7	1203	1740	-
5	1	16	51.3	1792	-	-
6	2	16	71.3	1352	1919	-
7	1	16	56.8	1676	-	-
8	2	16	78.3	1367	1068	-
9	1	16	59.2	1535	-	-
10	2	16	68.7	1768	1190	-
11	2	16	73.8	1713	1036	-
12	3	16	91.1	1369	1716	1095
13	3	16	92.2	1274	1267	1050
14	3	16	92.9	1042	1623	1335
15	2	16	69.6	1627	1571	-
16	2	16	79.2	1575	1753	-
17	3	16	88.7	1550	1147	1363
18	-	-	-	-	-	-
19	-	-	-	-	-	-
20	-	-	-	-	-	-

Long Pulse Radar Test Signal

Test Signal Name: LP_Signal_24

Number of Bursts in Trial: 13

Burst	Pulses per Burst	Chrip (MHz)	Pulse Width(us)	PRI-1 (us)	PRI-2 (us)	PRI-3 (us)
1	2	11	67.9	1946	1179	-
2	1	11	55.4	1853	-	-
3	3	11	99.3	1398	1423	1631
4	2	11	79.4	1177	1690	-
5	2	11	67.8	1003	1892	-
6	3	11	96.1	1648	1694	1055
7	1	11	60	1689	-	-
8	1	11	57.2	1521	-	-
9	3	11	90.2	1905	1678	1183
10	2	11	77.8	1707	1860	-
11	3	11	97.3	1600	1232	1322
12	3	11	87.4	1683	1870	1130
13	2	11	75	1446	1131	-
14	-	-	-	-	-	-
15	-	-	-	-	-	-
16	-	-	-	-	-	-
17	-	-	-	-	-	-
18	-	-	-	-	-	-
19	-	-	-	-	-	-
20	-	-	-	-	-	-

Long Pulse Radar Test Signal

Test Signal Name: LP_Signal_25

Number of Bursts in Trial: 10

Burst	Pulses per Burst	Chrip (MHz)	Pulse Width(us)	PRI-1 (us)	PRI-2 (us)	PRI-3 (us)
1	2	8	69.4	1512	1305	-
2	3	8	86.6	1170	1236	1169
3	2	8	69.1	1395	1165	-
4	1	8	58.3	1806	-	-
5	3	8	97.4	1977	1161	1726
6	3	8	92.8	1951	1682	1088
7	3	8	88.5	1718	1780	1389
8	2	8	83	1926	1586	-
9	2	8	81.5	1265	1533	-
10	1	8	63.4	1880	-	-
11	-	-	-	-	-	-
12	-	-	-	-	-	-
13	-	-	-	-	-	-
14	-	-	-	-	-	-
15	-	-	-	-	-	-
16	-	-	-	-	-	-
17	-	-	-	-	-	-
18	-	-	-	-	-	-
19	-	-	-	-	-	-
20	-	-	-	-	-	-

Long Pulse Radar Test Signal

Test Signal Name: LP_Signal_26

Number of Bursts in Trial: 14

Burst	Pulses per Burst	Chrip (MHz)	Pulse Width(us)	PRI-1 (us)	PRI-2 (us)	PRI-3 (us)
1	2	12	74.7	1294	1401	-
2	2	12	81.9	1122	1146	-
3	1	12	64.7	1508	-	-
4	2	12	74.7	1638	1400	-
5	3	12	94.8	1016	1801	1969
6	3	12	84.5	1773	1091	1868
7	2	12	71.1	1955	1877	-
8	1	12	54.2	1188	-	-
9	3	12	96.6	1295	1424	1440
10	2	12	67.5	1453	1025	-
11	1	12	52.5	1925	-	-
12	2	12	66.8	1142	1580	-
13	3	12	97.8	1850	1729	1807
14	1	12	53.5	1105	-	-
15	-	-	-	-	-	-
16	-	-	-	-	-	-
17	-	-	-	-	-	-
18	-	-	-	-	-	-
19	-	-	-	-	-	-
20	-	-	-	-	-	-

Long Pulse Radar Test Signal

Test Signal Name: LP_Signal_27

Number of Bursts in Trial: 17

Burst	Pulses per Burst	Chrip (MHz)	Pulse Width(us)	PRI-1 (us)	PRI-2 (us)	PRI-3 (us)
1	1	16	51.2	1278	-	-
2	3	16	93.7	1432	1231	1436
3	2	16	74.3	1111	1621	-
4	3	16	84.4	1066	1030	1871
5	2	16	69.5	1224	1484	-
6	1	16	61.1	1220	-	-
7	3	16	93.5	1428	1093	1061
8	1	16	59.5	1047	-	-
9	3	16	90.9	1254	1242	1903
10	3	16	84.3	1628	1993	1185
11	3	16	99.3	1421	1799	1468
12	3	16	87.2	1531	1127	1572
13	2	16	72	1816	1173	-
14	3	16	83.8	1937	1303	1778
15	3	16	95.5	1197	1256	1944
16	2	16	76.9	1511	1829	-
17	3	16	90.8	1858	1296	1843
18	-	-	-	-	-	-
19	-	-	-	-	-	-
20	-	-	-	-	-	-

Long Pulse Radar Test Signal

Test Signal Name: LP_Signal_28

Number of Bursts in Trial: 15

Burst	Pulses per Burst	Chrip (MHz)	Pulse Width(us)	PRI-1 (us)	PRI-2 (us)	PRI-3 (us)
1	1	14	55.6	1329	-	-
2	3	14	86.5	1986	1360	1759
3	3	14	92	1679	1447	1672
4	2	14	74.6	1125	1705	-
5	3	14	97.6	1403	1654	1563
6	1	14	53.1	1696	-	-
7	2	14	71.3	1454	1266	-
8	1	14	65.2	1313	-	-
9	2	14	72.8	1567	1053	-
10	2	14	69	1931	1253	-
11	2	14	73.6	1474	1601	-
12	1	14	50.7	1239	-	-
13	2	14	69.8	1597	1196	-
14	2	14	72.4	1650	1006	-
15	1	14	52.6	1466	-	-
16	-	-	-	-	-	-
17	-	-	-	-	-	-
18	-	-	-	-	-	-
19	-	-	-	-	-	-
20	-	-	-	-	-	-

Long Pulse Radar Test Signal

Test Signal Name: LP_Signal_29

Number of Bursts in Trial: 15

Burst	Pulses per Burst	Chrip (MHz)	Pulse Width(us)	PRI-1 (us)	PRI-2 (us)	PRI-3 (us)
1	3	14	88.9	1620	1425	1069
2	1	14	65.6	1459	-	-
3	1	14	57.1	1246	-	-
4	1	14	53.6	1988	-	-
5	2	14	68.5	1630	1392	-
6	1	14	54	1688	-	-
7	1	14	63.5	1472	-	-
8	2	14	70.3	1070	1441	-
9	2	14	69.9	1803	1001	-
10	1	14	65.1	1376	-	-
11	3	14	91	1932	1004	1598
12	2	14	80.4	1790	1641	-
13	2	14	75.4	1604	1323	-
14	1	14	57.6	1418	-	-
15	1	14	62.5	1240	-	-
16	-	-	-	-	-	-
17	-	-	-	-	-	-
18	-	-	-	-	-	-
19	-	-	-	-	-	-
20	-	-	-	-	-	-



Long Pulse Radar Test Signal

Test Signal Name: LP_Signal_30

Number of Bursts in Trial: 9

Burst	Pulses per Burst	Chrip (MHz)	Pulse Width(us)	PRI-1 (us)	PRI-2 (us)	PRI-3 (us)
1	3	7	87.3	1917	1784	1702
2	1	7	58.7	1370	-	-
3	2	7	69.7	1649	1320	-
4	2	7	76.8	1700	1285	-
5	3	7	97	1837	1089	1576
6	2	7	80.3	1078	1341	-
7	1	7	55.7	1695	-	-
8	2	7	78.9	1021	1821	-
9	1	7	53.7	1602	-	-
10	-	-	-	-	-	-
11	-	-	-	-	-	-
12	-	-	-	-	-	-
13	-	-	-	-	-	-
14	-	-	-	-	-	-
15	-	-	-	-	-	-
16	-	-	-	-	-	-
17	-	-	-	-	-	-
18	-	-	-	-	-	-
19	-	-	-	-	-	-
20	-	-	-	-	-	-



802.11ax (HE160)

Long Pulse Radar Test Signal

Test Signal Name: LP_Signal_01

Number of Bursts in Trial: 13

Burst	Pulses per Burst	Chrip (MHz)	Pulse Width(us)	PRI-1 (us)	PRI-2 (us)	PRI-3 (us)
1	2	12	72.3	1755	1674	-
2	3	12	93.3	1628	1167	1284
3	3	12	98.4	1837	1798	1519
4	3	12	84.5	1613	1145	1805
5	3	12	95.2	1476	1854	1395
6	1	12	53.7	1358	-	-
7	1	12	63.2	1487	-	-
8	1	12	55.4	1756	-	-
9	1	12	61.2	1050	-	-
10	3	12	89	1609	1244	1978
11	1	12	61.4	1617	-	-
12	3	12	87.9	1036	1397	1221
13	3	12	84.5	1597	1420	1855
14	-	-	-	-	-	-
15	-	-	-	-	-	-
16	-	-	-	-	-	-
17	-	-	-	-	-	-
18	-	-	-	-	-	-
19	-	-	-	-	-	-
20	-	-	-	-	-	-

Long Pulse Radar Test Signal

Test Signal Name: LP_Signal_02

Number of Bursts in Trial: 19

Burst	Pulses per Burst	Chrip (MHz)	Pulse Width(us)	PRI-1 (us)	PRI-2 (us)	PRI-3 (us)
1	3	18	98.8	2000	1421	1218
2	1	18	63.9	1982	-	-
3	3	18	92.9	1852	1405	1622
4	2	18	73.9	1102	1012	-
5	2	18	68.8	1924	1823	-
6	2	18	67.8	1692	1643	-
7	2	18	82.4	1510	1761	-
8	3	18	98.6	1461	1615	1561
9	1	18	56.8	1013	-	-
10	3	18	86.2	1290	1785	1120
11	2	18	80.9	1791	1542	-
12	2	18	70.1	1496	1591	-
13	1	18	60	1138	-	-
14	1	18	52.5	1638	-	-
15	1	18	51.4	1231	-	-
16	3	18	94.6	1948	1689	1417
17	3	18	90.6	1945	1774	1445
18	3	18	86.8	1929	1076	1626
19	2	18	76.5	1449	1775	-
20	-	-	-	-	-	-



Long Pulse Radar Test Signal

Test Signal Name: LP_Signal_03

Number of Bursts in Trial: 20

Burst	Pulses per Burst	Chrip (MHz)	Pulse Width(us)	PRI-1 (us)	PRI-2 (us)	PRI-3 (us)
1	1	20	55.3	1256	-	-
2	2	20	73.5	1475	1085	-
3	1	20	60.5	1229	-	-
4	1	20	52.6	1919	-	-
5	1	20	51.8	1603	-	-
6	3	20	92.5	1468	1109	1577
7	1	20	64.8	1784	-	-
8	1	20	58.5	1915	-	-
9	2	20	75.4	1584	1130	-
10	1	20	61	1323	-	-
11	3	20	88.1	1880	1885	1678
12	2	20	73.8	1739	1514	-
13	1	20	55.1	1810	-	-
14	3	20	99	1737	1719	1034
15	1	20	50.9	1387	-	-
16	1	20	50.4	1275	-	-
17	3	20	91	1700	1738	1316
18	1	20	65.3	1534	-	-
19	3	20	95.6	1792	1937	1819
20	2	20	66.9	1770	1529	-

Long Pulse Radar Test Signal

Test Signal Name: LP_Signal_04

Number of Bursts in Trial: 16

Burst	Pulses per Burst	Chrip (MHz)	Pulse Width(us)	PRI-1 (us)	PRI-2 (us)	PRI-3 (us)
1	2	16	78.4	1900	1706	-
2	2	16	82.9	1313	1579	-
3	1	16	50.8	1990	-	-
4	1	16	65.5	1382	-	-
5	1	16	57.1	1282	-	-
6	2	16	67.5	1314	1702	-
7	1	16	64.3	1286	-	-
8	3	16	85.1	1105	1540	1147
9	1	16	51.2	1815	-	-
10	1	16	61.7	1504	-	-
11	1	16	60.8	1592	-	-
12	2	16	70.7	1112	1894	-
13	1	16	52.2	1291	-	-
14	3	16	84.9	1441	1095	1644
15	2	16	82.5	1156	1732	-
16	1	16	61	1795	-	-
17	-	-	-	-	-	-
18	-	-	-	-	-	-
19	-	-	-	-	-	-
20	-	-	-	-	-	-

Long Pulse Radar Test Signal

Test Signal Name: LP_Signal_05

Number of Bursts in Trial: 19

Burst	Pulses per Burst	Chrip (MHz)	Pulse Width(us)	PRI-1 (us)	PRI-2 (us)	PRI-3 (us)
1	3	19	88.2	1296	1994	1980
2	1	19	61.3	1018	-	-
3	3	19	91.1	1047	1179	1365
4	2	19	81.4	1160	1779	-
5	1	19	53.9	1428	-	-
6	1	19	59.3	1708	-	-
7	1	19	57	1587	-	-
8	3	19	87.6	1078	1844	1283
9	2	19	68.7	1453	1825	-
10	1	19	62.3	1927	-	-
11	2	19	75.7	1459	1471	-
12	2	19	71.2	1905	1489	-
13	1	19	59.1	1710	-	-
14	1	19	52.1	1308	-	-
15	1	19	60.5	1087	-	-
16	2	19	79.3	1828	1889	-
17	3	19	95	1139	1432	1588
18	2	19	69.9	1466	1838	-
19	3	19	98.1	1107	1419	1909
20						



Long Pulse Radar Test Signal

Test Signal Name: LP_Signal_06

Number of Bursts in Trial: 8

Burst	Pulses per Burst	Chrip (MHz)	Pulse Width(us)	PRI-1 (us)	PRI-2 (us)	PRI-3 (us)
1	2	6	72.5	1890	1292	-
2	2	6	72.6	1794	1408	-
3	3	6	95.1	1093	1310	1776
4	3	6	95.6	1225	1694	1778
5	3	6	84.4	1219	1640	1879
6	2	6	78.2	1448	1505	-
7	2	6	79.8	1930	1144	-
8	1	6	57.3	1021	-	-
9	-	-	-	-	-	-
10	-	-	-	-	-	-
11	-	-	-	-	-	-
12	-	-	-	-	-	-
13	-	-	-	-	-	-
14	-	-	-	-	-	-
15	-	-	-	-	-	-
16	-	-	-	-	-	-
17	-	-	-	-	-	-
18	-	-	-	-	-	-
19	-	-	-	-	-	-
20	-	-	-	-	-	-

Long Pulse Radar Test Signal

Test Signal Name: LP_Signal_07

Number of Bursts in Trial: 11

Burst	Pulses per Burst	Chrip (MHz)	Pulse Width(us)	PRI-1 (us)	PRI-2 (us)	PRI-3 (us)
1	1	9	63.6	1490	-	-
2	1	9	50.1	1714	-	-
3	2	9	67.4	1605	1352	-
4	2	9	71.6	1431	1658	-
5	2	9	70.3	1281	1007	-
6	1	9	66.4	1015	-	-
7	3	9	90	1197	1005	1918
8	1	9	62.2	1153	-	-
9	2	9	79.6	1247	1295	-
10	2	9	74.3	1518	1646	-
11	1	9	64.1	1305	-	-
12	-	-	-	-	-	-
13	-	-	-	-	-	-
14	-	-	-	-	-	-
15	-	-	-	-	-	-
16	-	-	-	-	-	-
17	-	-	-	-	-	-
18	-	-	-	-	-	-
19	-	-	-	-	-	-
20	-	-	-	-	-	-



Long Pulse Radar Test Signal

Test Signal Name: LP_Signal_08

Number of Bursts in Trial: 9

Burst	Pulses per Burst	Chrip (MHz)	Pulse Width(us)	PRI-1 (us)	PRI-2 (us)	PRI-3 (us)
1	1	6	63	1460	-	-
2	2	6	69.1	1943	1619	-
3	2	6	75.8	1000	1230	-
4	1	6	63.3	1620	-	-
5	3	6	96.8	1846	1213	1425
6	3	6	94.8	1122	1024	1920
7	3	6	91.8	1634	1991	1960
8	3	6	93.1	1424	1406	1744
9	2	6	76	1687	1763	-
10	-	-	-	-	-	-
11	-	-	-	-	-	-
12	-	-	-	-	-	-
13	-	-	-	-	-	-
14	-	-	-	-	-	-
15	-	-	-	-	-	-
16	-	-	-	-	-	-
17	-	-	-	-	-	-
18	-	-	-	-	-	-
19	-	-	-	-	-	-
20	-	-	-	-	-	-

Long Pulse Radar Test Signal

Test Signal Name: LP_Signal_09

Number of Bursts in Trial: 10

Burst	Pulses per Burst	Chrip (MHz)	Pulse Width(us)	PRI-1 (us)	PRI-2 (us)	PRI-3 (us)
1	3	8	99.1	1635	1214	1201
2	1	8	51.2	1989	-	-
3	2	8	81.6	1817	1152	-
4	2	8	75.7	1816	1596	-
5	2	8	82.3	1783	1375	-
6	3	8	86.8	1649	1690	1434
7	1	8	60	1055	-	-
8	3	8	88.4	1136	1235	1868
9	3	8	93.1	1559	1813	1222
10	1	8	65.7	1503	-	-
11	-	-	-	-	-	-
12	-	-	-	-	-	-
13	-	-	-	-	-	-
14	-	-	-	-	-	-
15	-	-	-	-	-	-
16	-	-	-	-	-	-
17	-	-	-	-	-	-
18	-	-	-	-	-	-
19	-	-	-	-	-	-
20	-	-	-	-	-	-



Long Pulse Radar Test Signal

Test Signal Name: LP_Signal_10

Number of Bursts in Trial: 18

Burst	Pulses per Burst	Chrip (MHz)	Pulse Width(us)	PRI-1 (us)	PRI-2 (us)	PRI-3 (us)
1	1	17	56.7	1263	-	-
2	1	17	53.2	1462	-	-
3	2	17	74.1	1180	1344	-
4	1	17	52	1269	-	-
5	3	17	93.5	1841	1931	1863
6	3	17	87.4	1972	1210	1610
7	1	17	51.3	1208	-	-
8	3	17	90.7	1608	1302	1759
9	1	17	55.4	1509	-	-
10	1	17	54.8	1253	-	-
11	2	17	69.1	1961	1499	-
12	3	17	89.9	1069	1717	1176
13	2	17	80.9	1315	1904	-
14	1	17	55	1553	-	-
15	2	17	80.8	1134	1439	-
16	1	17	56.9	1987	-	-
17	2	17	79	1106	1602	-
18	3	17	96.8	1874	1118	1595
19	-	-	-	-	-	-
20	-	-	-	-	-	-

Long Pulse Radar Test Signal

Test Signal Name: LP_Signal_11

Number of Bursts in Trial: 10

Burst	Pulses per Burst	Chrip (MHz)	Pulse Width(us)	PRI-1 (us)	PRI-2 (us)	PRI-3 (us)
1	1	8	59.3	1126	-	-
2	3	8	98.4	1164	1660	1258
3	1	8	50.7	1351	-	-
4	3	8	92.6	1458	1173	1209
5	3	8	85.1	1474	1843	1374
6	1	8	53.8	1547	-	-
7	1	8	58.2	1833	-	-
8	1	8	62.4	1108	-	-
9	2	8	68.6	1869	1947	-
10	3	8	91.7	1321	1912	1443
11	-	-	-	-	-	-
12	-	-	-	-	-	-
13	-	-	-	-	-	-
14	-	-	-	-	-	-
15	-	-	-	-	-	-
16	-	-	-	-	-	-
17	-	-	-	-	-	-
18	-	-	-	-	-	-
19	-	-	-	-	-	-
20	-	-	-	-	-	-

Long Pulse Radar Test Signal

Test Signal Name: LP_Signal_12

Number of Bursts in Trial: 17

Burst	Pulses per Burst	Chrip (MHz)	Pulse Width(us)	PRI-1 (us)	PRI-2 (us)	PRI-3 (us)
1	3	17	89.3	1766	1771	1623
2	3	17	83.5	1196	1410	1834
3	1	17	56.3	1913	-	-
4	1	17	51.6	1835	-	-
5	2	17	69.1	1333	1348	-
6	1	17	63.9	1583	-	-
7	2	17	67.5	1973	1142	-
8	1	17	60.9	1799	-	-
9	3	17	88.9	1178	1625	1851
10	2	17	67	1866	1908	-
11	2	17	82.4	1041	1010	-
12	2	17	76	1932	1512	-
13	3	17	95.4	1098	1278	1217
14	1	17	54	1494	-	-
15	3	17	86.4	1582	1979	1238
16	3	17	88.3	1551	1251	1294
17	1	17	56.8	1319	-	-
18	-	-	-	-	-	-
19	-	-	-	-	-	-
20	-	-	-	-	-	-

Long Pulse Radar Test Signal

Test Signal Name: LP_Signal_13

Number of Bursts in Trial: 16

Burst	Pulses per Burst	Chrip (MHz)	Pulse Width(us)	PRI-1 (us)	PRI-2 (us)	PRI-3 (us)
1	1	16	59.1	1452	-	-
2	2	16	70.3	1722	1113	-
3	2	16	76.5	1394	1543	-
4	3	16	94.9	1044	1887	1983
5	2	16	75.4	1858	1131	-
6	1	16	57.8	1089	-	-
7	1	16	63.3	1037	-	-
8	2	16	79.1	1389	1165	-
9	3	16	94.8	1383	1882	1986
10	1	16	65	1600	-	-
11	1	16	64.1	1589	-	-
12	2	16	68.2	1268	1787	-
13	2	16	70.3	1048	1631	-
14	3	16	93.9	1418	1954	1353
15	2	16	81.1	1662	1331	-
16	2	16	68.7	1680	1733	-
17	-	-	-	-	-	-
18	-	-	-	-	-	-
19	-	-	-	-	-	-
20	-	-	-	-	-	-

Long Pulse Radar Test Signal

Test Signal Name: LP_Signal_14

Number of Bursts in Trial: 20

Burst	Pulses per Burst	Chrip (MHz)	Pulse Width(us)	PRI-1 (us)	PRI-2 (us)	PRI-3 (us)
1	1	20	59.6	1570	-	-
2	1	20	51.4	1571	-	-
3	2	20	71.9	1059	1463	-
4	3	20	98.5	1667	1707	1558
5	2	20	67.5	1888	1339	-
6	2	20	70.7	1681	1663	-
7	2	20	67	1575	1936	-
8	3	20	87.5	1956	1995	1506
9	2	20	69.9	1998	1578	-
10	2	20	68	1606	1693	-
11	1	20	62	1630	-	-
12	1	20	64.3	1311	-	-
13	2	20	83.3	1731	1655	-
14	1	20	52.9	1958	-	-
15	3	20	96.7	1312	1415	1975
16	1	20	56.2	1790	-	-
17	3	20	96.8	1682	1974	1545
18	3	20	97	1735	1396	1427
19	3	20	99.1	1114	1827	1782
20	3	20	92.1	1023	1330	1500

Long Pulse Radar Test Signal

Test Signal Name: LP_Signal_15

Number of Bursts in Trial: 11

Burst	Pulses per Burst	Chrip (MHz)	Pulse Width(us)	PRI-1 (us)	PRI-2 (us)	PRI-3 (us)
1	3	9	92.1	1337	1233	1636
2	3	9	96.9	1727	1248	1170
3	1	9	63.8	1081	-	-
4	2	9	75.7	1205	1380	-
5	3	9	93.1	1056	1416	1116
6	2	9	72.6	1299	1916	-
7	2	9	74.4	1740	1673	-
8	3	9	99	1356	1901	1450
9	1	9	53.4	1486	-	-
10	3	9	92.7	1182	1911	1992
11	2	9	68.5	1697	1227	-
12	-	-	-	-	-	-
13	-	-	-	-	-	-
14	-	-	-	-	-	-
15	-	-	-	-	-	-
16	-	-	-	-	-	-
17	-	-	-	-	-	-
18	-	-	-	-	-	-
19	-	-	-	-	-	-
20	-	-	-	-	-	-

Long Pulse Radar Test Signal

Test Signal Name: LP_Signal_16

Number of Bursts in Trial: 19

Burst	Pulses per Burst	Chrip (MHz)	Pulse Width(us)	PRI-1 (us)	PRI-2 (us)	PRI-3 (us)
1	2	18	73.2	1907	1191	-
2	1	18	51.3	1764	-	-
3	1	18	57.2	1965	-	-
4	3	18	85.7	1647	1026	1632
5	1	18	52.6	1789	-	-
6	1	18	64.4	1586	-	-
7	3	18	89.8	1341	1976	1435
8	3	18	89.3	1572	1195	1379
9	3	18	88.4	1857	1309	1942
10	1	18	53.3	1574	-	-
11	3	18	89.1	1672	1875	1071
12	2	18	74.9	1952	1598	-
13	1	18	57.4	1549	-	-
14	3	18	95.8	1057	1151	1082
15	3	18	99	1115	1117	1741
16	3	18	95.8	1242	1127	1028
17	3	18	91.9	1480	1899	1250
18	2	18	68.3	1370	1103	-
19	1	18	57.9	1865	-	-
20	-	-	-	-	-	-

Long Pulse Radar Test Signal

Test Signal Name: LP_Signal_17

Number of Bursts in Trial: 14

Burst	Pulses per Burst	Chrip (MHz)	Pulse Width(us)	PRI-1 (us)	PRI-2 (us)	PRI-3 (us)
1	2	12	71.5	1903	1440	-
2	2	12	73.4	1686	1538	-
3	3	12	94.8	1279	1481	1257
4	3	12	89	1873	1043	1601
5	2	12	76.7	1891	1677	-
6	1	12	62.8	1413	-	-
7	3	12	87.6	1226	1472	1552
8	3	12	96.3	1808	1277	1541
9	1	12	55.3	1404	-	-
10	3	12	95	1922	1950	1119
11	3	12	96.4	1092	1401	1881
12	2	12	68.1	1255	1223	-
13	3	12	84.1	1072	1086	1715
14	2	12	77.3	1752	1264	-
15	-	-	-	-	-	-
16	-	-	-	-	-	-
17	-	-	-	-	-	-
18	-	-	-	-	-	-
19	-	-	-	-	-	-
20	-	-	-	-	-	-

Long Pulse Radar Test Signal

Test Signal Name: LP_Signal_18

Number of Bursts in Trial: 12

Burst	Pulses per Burst	Chrip (MHz)	Pulse Width(us)	PRI-1 (us)	PRI-2 (us)	PRI-3 (us)
1	3	11	99.6	1307	1027	1403
2	3	11	88.8	1839	1336	1473
3	1	11	63	1661	-	-
4	2	11	76	1793	1158	-
5	2	11	67.2	1171	1926	-
6	3	11	94.1	1762	1743	1254
7	3	11	91.8	1354	1058	1502
8	1	11	56.9	1133	-	-
9	1	11	57.7	1149	-	-
10	1	11	60.6	1189	-	-
11	3	11	88.7	1971	1508	1065
12	1	11	53	1734	-	-
13	-	-	-	-	-	-
14	-	-	-	-	-	-
15	-	-	-	-	-	-
16	-	-	-	-	-	-
17	-	-	-	-	-	-
18	-	-	-	-	-	-
19	-	-	-	-	-	-
20	-	-	-	-	-	-

Long Pulse Radar Test Signal

Test Signal Name: LP_Signal_19

Number of Bursts in Trial: 12

Burst	Pulses per Burst	Chrip (MHz)	Pulse Width(us)	PRI-1 (us)	PRI-2 (us)	PRI-3 (us)
1	2	10	71.9	1368	1917	-
2	1	10	56.4	1886	-	-
3	2	10	79.9	1757	1566	-
4	3	10	94.2	1020	1243	1928
5	2	10	76.8	1154	1872	-
6	2	10	82.5	1633	1576	-
7	2	10	80.7	1665	1262	-
8	3	10	95.6	1848	1326	1132
9	2	10	71.2	1804	1372	-
10	3	10	95.2	1830	1521	1616
11	2	10	78.4	1546	1161	-
12	1	10	62.3	1068	-	-
13	-	-	-	-	-	-
14	-	-	-	-	-	-
15	-	-	-	-	-	-
16	-	-	-	-	-	-
17	-	-	-	-	-	-
18	-	-	-	-	-	-
19	-	-	-	-	-	-
20	-	-	-	-	-	-

Long Pulse Radar Test Signal

Test Signal Name: LP_Signal_20

Number of Bursts in Trial: 16

Burst	Pulses per Burst	Chrip (MHz)	Pulse Width(us)	PRI-1 (us)	PRI-2 (us)	PRI-3 (us)
1	2	15	80.6	1777	1523	-
2	2	15	72.9	1198	1712	-
3	1	15	65	1207	-	-
4	2	15	68.2	1181	1174	-
5	3	15	84.4	1346	1329	1355
6	3	15	94.4	1022	1914	2000
7	3	15	92.1	1892	1536	1393
8	3	15	85.3	1483	1384	1362
9	1	15	55	1525	-	-
10	3	15	97.7	1442	1200	1046
11	1	15	57.8	1516	-	-
12	1	15	57	1864	-	-
13	3	15	85.9	1030	1042	1051
14	2	15	69.7	1691	1964	-
15	2	15	74.6	1246	1426	-
16	2	15	74.2	1614	1562	-
17	-	-	-	-	-	-
18	-	-	-	-	-	-
19	-	-	-	-	-	-
20	-	-	-	-	-	-



Long Pulse Radar Test Signal

Test Signal Name: LP_Signal_21

Number of Bursts in Trial: 20

Burst	Pulses per Burst	Chrip (MHz)	Pulse Width(us)	PRI-1 (us)	PRI-2 (us)	PRI-3 (us)
1	1	20	66.1	1669	-	-
2	1	20	64.5	1414	-	-
3	1	20	65.6	1347	-	-
4	3	20	84.2	1135	1163	1934
5	1	20	50.2	1332	-	-
6	2	20	73.6	1016	1861	-
7	3	20	91	1511	1155	1814
8	2	20	81.2	1902	1391	-
9	1	20	66.3	1728	-	-
10	1	20	61.2	1696	-	-
11	2	20	68.2	1169	1557	-
12	1	20	63.9	1548	-	-
13	3	20	87.5	1345	1188	1011
14	3	20	88.5	1648	1493	1399
15	1	20	56.1	1679	-	-
16	1	20	54.3	1729	-	-
17	1	20	60.4	1993	-	-
18	1	20	50.7	1772	-	-
19	3	20	95.5	1957	1465	1166
20	3	20	94.4	1216	1862	1668

Long Pulse Radar Test Signal

Test Signal Name: LP_Signal_22

Number of Bursts in Trial: 9

Burst	Pulses per Burst	Chrip (MHz)	Pulse Width(us)	PRI-1 (us)	PRI-2 (us)	PRI-3 (us)
1	2	7	79.1	1703	1045	-
2	2	7	73.6	1276	1666	-
3	2	7	72.6	1607	1895	-
4	1	7	63.4	1451	-	-
5	2	7	68.6	1711	1801	-
6	1	7	53.4	1328	-	-
7	3	7	98.1	1008	1539	1032
8	2	7	74.3	1357	1977	-
9	3	7	98.6	1893	1236	1411
10	-	-	-	-	-	-
11	-	-	-	-	-	-
12	-	-	-	-	-	-
13	-	-	-	-	-	-
14	-	-	-	-	-	-
15	-	-	-	-	-	-
16	-	-	-	-	-	-
17	-	-	-	-	-	-
18	-	-	-	-	-	-
19	-	-	-	-	-	-
20	-	-	-	-	-	-

Long Pulse Radar Test Signal

Test Signal Name: LP_Signal_23

Number of Bursts in Trial: 17

Burst	Pulses per Burst	Chrip (MHz)	Pulse Width(us)	PRI-1 (us)	PRI-2 (us)	PRI-3 (us)
1	2	16	72.9	1327	1684	-
2	1	16	58.2	1704	-	-
3	1	16	57	1999	-	-
4	1	16	57.8	1141	-	-
5	1	16	56.4	1716	-	-
6	2	16	79.4	1388	1285	-
7	1	16	56.7	1507	-	-
8	2	16	79.5	1062	1001	-
9	3	16	94.3	1129	1705	1769
10	1	16	62	1654	-	-
11	1	16	57	1533	-	-
12	2	16	81.9	1361	1742	-
13	3	16	83.9	1017	1111	1373
14	1	16	51.9	1359	-	-
15	2	16	73.2	1140	1641	-
16	2	16	76.2	1988	1484	-
17	2	16	78.1	1698	1829	-
18	-	-	-	-	-	-
19	-	-	-	-	-	-
20	-	-	-	-	-	-

Long Pulse Radar Test Signal

Test Signal Name: LP_Signal_24

Number of Bursts in Trial: 16

Burst	Pulses per Burst	Chrip (MHz)	Pulse Width(us)	PRI-1 (us)	PRI-2 (us)	PRI-3 (us)
1	3	14	97.8	1402	1676	1807
2	1	14	66.5	1168	-	-
3	3	14	91.5	1019	1985	1100
4	1	14	53.5	1204	-	-
5	3	14	96.6	1241	1765	1378
6	3	14	85.2	1856	1524	1501
7	2	14	74.3	1033	1604	-
8	2	14	80.3	1385	1261	-
9	3	14	95.2	1532	1709	1301
10	3	14	92.5	1871	1593	1749
11	3	14	91.9	1293	1412	1724
12	1	14	52.2	1298	-	-
13	1	14	65.5	1650	-	-
14	3	14	96.9	1867	1004	1259
15	2	14	75.6	1446	1966	-
16	1	14	66.6	1923	-	-
17	-	-	-	-	-	-
18	-	-	-	-	-	-
19	-	-	-	-	-	-
20	-	-	-	-	-	-

Long Pulse Radar Test Signal

Test Signal Name: LP_Signal_25

Number of Bursts in Trial: 13

Burst	Pulses per Burst	Chrip (MHz)	Pulse Width(us)	PRI-1 (us)	PRI-2 (us)	PRI-3 (us)
1	2	11	82.6	1349	1573	-
2	3	11	93.4	1594	1563	1183
3	1	11	52.9	1725	-	-
4	1	11	61.1	1187	-	-
5	1	11	56	1515	-	-
6	2	11	81	1809	1877	-
7	1	11	59	1469	-	-
8	3	11	99.5	1831	1845	1438
9	2	11	74.9	1273	1535	-
10	1	11	66.1	1252	-	-
11	3	11	88.7	1157	1860	1997
12	3	11	88.4	1969	1407	1091
13	1	11	62.4	1699	-	-
14	-	-	-	-	-	-
15	-	-	-	-	-	-
16	-	-	-	-	-	-
17	-	-	-	-	-	-
18	-	-	-	-	-	-
19	-	-	-	-	-	-
20	-	-	-	-	-	-



Long Pulse Radar Test Signal

Test Signal Name: LP_Signal_26

Number of Bursts in Trial: 10

Burst	Pulses per Burst	Chrip (MHz)	Pulse Width(us)	PRI-1 (us)	PRI-2 (us)	PRI-3 (us)
1	3	8	95.2	1002	1821	1527
2	2	8	71.7	1840	1035	-
3	3	8	99.4	1289	1177	1656
4	3	8	87.2	1786	1736	1925
5	3	8	90.5	1751	1803	1701
6	1	8	55.6	1067	-	-
7	2	8	81.5	1390	1946	-
8	2	8	82.8	1718	1245	-
9	3	8	95.1	1212	1713	1070
10	2	8	76.3	1317	1695	-
11	-	-	-	-	-	-
12	-	-	-	-	-	-
13	-	-	-	-	-	-
14	-	-	-	-	-	-
15	-	-	-	-	-	-
16	-	-	-	-	-	-
17	-	-	-	-	-	-
18	-	-	-	-	-	-
19	-	-	-	-	-	-
20	-	-	-	-	-	-



Long Pulse Radar Test Signal

Test Signal Name: LP_Signal_27

Number of Bursts in Trial: 8

Burst	Pulses per Burst	Chrip (MHz)	Pulse Width(us)	PRI-1 (us)	PRI-2 (us)	PRI-3 (us)
1	2	5	73	1237	1485	-
2	2	5	82.7	1824	1750	-
3	2	5	77.5	1436	1398	-
4	1	5	61.3	1303	-	-
5	3	5	87	1618	1675	1753
6	1	5	64.8	1215	-	-
7	2	5	77.2	1146	1280	-
8	2	5	78.7	1567	1400	-
9	-	-	-	-	-	-
10	-	-	-	-	-	-
11	-	-	-	-	-	-
12	-	-	-	-	-	-
13	-	-	-	-	-	-
14	-	-	-	-	-	-
15	-	-	-	-	-	-
16	-	-	-	-	-	-
17	-	-	-	-	-	-
18	-	-	-	-	-	-
19	-	-	-	-	-	-
20	-	-	-	-	-	-

Long Pulse Radar Test Signal

Test Signal Name: LP_Signal_28

Number of Bursts in Trial: 8

Burst	Pulses per Burst	Chrip (MHz)	Pulse Width(us)	PRI-1 (us)	PRI-2 (us)	PRI-3 (us)
1	1	5	65.2	1186	-	-
2	2	5	81.4	1193	1271	-
3	1	5	65.2	1556	-	-
4	1	5	51.2	1820	-	-
5	1	5	58.5	1381	-	-
6	2	5	70.2	1624	1564	-
7	1	5	65	1060	-	-
8	2	5	72.1	1364	1099	-
9	-	-	-	-	-	-
10	-	-	-	-	-	-
11	-	-	-	-	-	-
12	-	-	-	-	-	-
13	-	-	-	-	-	-
14	-	-	-	-	-	-
15	-	-	-	-	-	-
16	-	-	-	-	-	-
17	-	-	-	-	-	-
18	-	-	-	-	-	-
19	-	-	-	-	-	-
20	-	-	-	-	-	-

Long Pulse Radar Test Signal

Test Signal Name: LP_Signal_29

Number of Bursts in Trial: 19

Burst	Pulses per Burst	Chrip (MHz)	Pulse Width(us)	PRI-1 (us)	PRI-2 (us)	PRI-3 (us)
1	2	19	66.8	1876	1342	-
2	1	19	57.4	1206	-	-
3	3	19	92.1	1454	1079	1482
4	2	19	78.6	1726	1066	-
5	2	19	80.4	1498	1611	-
6	3	19	96.6	1495	1671	1123
7	3	19	85.9	1800	1232	1159
8	2	19	67.9	1847	1128	-
9	3	19	100	1260	1970	1064
10	2	19	70.8	1639	1796	-
11	3	19	92.5	1080	1367	1780
12	1	19	65	1921	-	-
13	2	19	75	1324	1429	-
14	3	19	91.2	1334	1464	1340
15	3	19	94.1	1386	1747	1409
16	3	19	83.9	1544	1318	1530
17	3	19	87.6	1377	1110	1239
18	2	19	67	1392	1745	-
19	2	19	79.9	1343	1194	-
20	-	-	-	-	-	-

Long Pulse Radar Test Signal

Test Signal Name: LP_Signal_30

Number of Bursts in Trial: 18

Burst	Pulses per Burst	Chrip (MHz)	Pulse Width(us)	PRI-1 (us)	PRI-2 (us)	PRI-3 (us)
1	2	17	78.4	1272	1101	-
2	2	17	78.5	1967	1366	-
3	2	17	69.7	1038	1083	-
4	2	17	72.1	1371	1422	-
5	3	17	84.7	1883	1063	1721
6	3	17	97.8	1897	1760	1651
7	3	17	87.5	1304	1457	1955
8	2	17	73.5	1685	1488	-
9	1	17	56.9	1996	-	-
10	3	17	97.2	1369	1376	1025
11	3	17	94	1568	1944	1806
12	1	17	63.1	1569	-	-
13	2	17	79.2	1802	1555	-
14	2	17	72.2	1531	1470	-
15	2	17	68.4	1288	1659	-
16	3	17	88.9	1832	1768	1287
17	2	17	74.1	1014	1723	-
18	3	17	90.8	1537	1423	1006
19	-	-	-	-	-	-
20	-	-	-	-	-	-

A.2 The Frequency Hopping Radar pattern

Hopping Frequency Sequence Name: HOP_FREQ_SEQ_01					
Frequency (MHz)	0	1	2	3	4
0	5385	5718	5545	5371	5537
5	5323	5519	5588	5621	5549
10	5327	5659	5489	5570	5584
15	5336	5311	5303	5647	5458
20	5612	5354	5716	5479	5348
25	5438	5337	5335	5574	5601
30	5265	5713	5577	5653	5715
35	5307	5432	5674	5562	5506
40	5306	5258	5345	5631	5632
45	5514	5320	5568	5696	5628
50	5602	5428	5708	5378	5349
55	5413	5273	5446	5333	5531
60	5264	5367	5534	5339	5332
65	5561	5580	5624	5251	5459
70	5563	5391	5402	5701	5259
75	5618	5573	5538	5271	5364
80	5328	5353	5252	5496	5670
85	5684	5305	5269	5463	5520
90	5597	5719	5325	5539	5639
95	5550	5678	5465	5552	5664

Hopping Frequency Sequence Name: HOP_FREQ_SEQ_02					
Frequency (MHz)	0	1	2	3	4
0	5543	5482	5481	5435	5282
5	5365	5541	5566	5309	5281
10	5636	5448	5530	5290	5605
15	5424	5438	5406	5692	5650
20	5620	5423	5279	5471	5321
25	5704	5664	5538	5678	5635
30	5307	5699	5534	5393	5489
35	5505	5474	5358	5695	5572
40	5428	5286	5396	5629	5346
45	5437	5626	5274	5418	5381
50	5604	5284	5467	5550	5357
55	5461	5400	5426	5253	5710
60	5399	5639	5484	5623	5350
65	5675	5398	5298	5283	5680
70	5720	5718	5422	5514	5705
75	5711	5708	5568	5277	5359
80	5272	5464	5651	5305	5580
85	5684	5312	5459	5715	5402
90	5337	5601	5370	5445	5649
95	5472	5654	5660	5672	5420



Hopping Frequency Sequence Name: HOP_FREQ_SEQ_03

Frequency (MHz)	0	1	2	3	4
0	5323	5721	5417	5596	5599
5	5504	5466	5641	5472	5585
10	5567	5712	5571	5485	5626
15	5415	5565	5509	5262	5367
20	5628	5589	5695	5560	5294
25	5592	5613	5266	5404	5669
30	5446	5588	5491	5511	5325
35	5381	5629	5434	5609	5411
40	5608	5699	5636	5275	5658
45	5520	5587	5327	5683	5257
50	5305	5335	5556	5373	5679
55	5552	5616	5547	5584	5528
60	5389	5704	5471	5310	5569
65	5648	5624	5605	5553	5483
70	5467	5706	5649	5490	5664
75	5680	5542	5689	5488	5678
80	5533	5523	5677	5281	5651
85	5719	5543	5409	5330	5657
90	5405	5690	5436	5694	5715
95	5425	5526	5644	5575	5377

Hopping Frequency Sequence Name: HOP_FREQ_SEQ_04

Frequency (MHz)	0	1	2	3	4
0	5578	5582	5353	5282	5344
5	5546	5488	5716	5635	5317
10	5498	5501	5612	5583	5647
15	5503	5692	5515	5685	5559
20	5539	5658	5636	5552	5267
25	5480	5465	5469	5508	5703
30	5574	5448	5251	5415	5523
35	5277	5569	5522	5587	5620
40	5347	5691	5637	5401	5623
45	5638	5603	5645	5380	5570
50	5608	5481	5386	5671	5265
55	5686	5331	5366	5555	5657
60	5554	5271	5400	5611	5374
65	5573	5373	5340	5445	5286
70	5314	5346	5466	5649	5591
75	5588	5670	5590	5495	5674
80	5476	5561	5601	5517	5284
85	5333	5318	5479	5419	5257
90	5510	5542	5572	5678	5672
95	5375	5621	5410	5504	5500



Hopping Frequency Sequence Name: HOP_FREQ_SEQ_05

Frequency (MHz)	0	1	2	3	4
0	5358	5346	5289	5443	5661
5	5588	5413	5316	5701	5524
10	5332	5290	5653	5303	5668
15	5591	5722	5618	5255	5276
20	5547	5349	5674	5641	5715
25	5271	5414	5672	5612	5262
30	5530	5463	5405	5466	5567
35	5343	5416	5660	5318	5362
40	5534	5299	5575	5544	5620
45	5511	5686	5703	5433	5360
50	5484	5657	5437	5356	5494
55	5470	5453	5640	5521	5563
60	5526	5311	5719	5691	5707
65	5558	5522	5409	5647	5467
70	5708	5300	5347	5345	5582
75	5711	5256	5651	5420	5326
80	5570	5279	5671	5457	5403
85	5566	5696	5385	5335	5581
90	5675	5260	5324	5407	5361
95	5431	5274	5535	5440	5551

Hopping Frequency Sequence Name: HOP_FREQ_SEQ_06

Frequency (MHz)	0	1	2	3	4
0	5613	5585	5700	5604	5406
5	5630	5435	5391	5389	5353
10	5263	5554	5694	5498	5689
15	5679	5374	5721	5300	5468
20	5555	5418	5615	5633	5688
25	5634	5266	5303	5716	5296
30	5669	5352	5362	5681	5341
35	5541	5458	5276	5589	5515
40	5448	5500	5382	5513	5309
45	5714	5440	5598	5294	5664
50	5722	5358	5488	5445	5695
55	5414	5641	5594	5711	5497
60	5409	5636	5539	5360	5504
65	5398	5471	5510	5270	5305
70	5286	5449	5671	5321	5490
75	5356	5302	5632	5672	5339
80	5351	5443	5621	5668	5457
85	5342	5626	5413	5350	5289
90	5354	5425	5330	5441	5540
95	5291	5590	5575	5338	5530



Hopping Frequency Sequence Name: HOP_FREQ_SEQ_07

Frequency (MHz)	0	1	2	3	4
0	5296	5349	5636	5290	5723
5	5294	5457	5466	5552	5560
10	5669	5440	5260	5693	5710
15	5670	5501	5345	5660	5584
20	5556	5722	5661	5425	5593
25	5506	5330	5711	5338	5319
30	5324	5493	5361	5597	5367
35	5482	5668	5459	5339	5562
40	5451	5549	5272	5578	5377
45	5442	5512	5614	5534	5539
50	5518	5261	5354	5548	5426
55	5676	5371	5569	5574	5581
60	5283	5450	5599	5420	5384
65	5689	5402	5474	5369	5452
70	5423	5297	5500	5362	5476
75	5445	5613	5449	5607	5306
80	5568	5683	5360	5659	5589
85	5508	5340	5602	5590	5336
90	5378	5503	5649	5308	5645
95	5559	5412	5413	5563	5307

Hopping Frequency Sequence Name: HOP_FREQ_SEQ_08

Frequency (MHz)	0	1	2	3	4
0	5551	5588	5572	5451	5468
5	5336	5382	5541	5715	5292
10	5503	5704	5398	5413	5256
15	5283	5628	5452	5293	5377
20	5474	5653	5497	5714	5634
25	5313	5542	5709	5546	5364
30	5278	5702	5276	5539	5267
35	5656	5261	5458	5443	5373
40	5645	5314	5708	5676	5558
45	5460	5305	5495	5399	5490
50	5710	5590	5623	5341	5680
55	5502	5616	5342	5601	5264
60	5678	5584	5396	5422	5369
65	5420	5424	5672	5351	5355
70	5455	5272	5273	5459	5331
75	5499	5491	5594	5701	5559
80	5388	5674	5565	5403	5263
85	5501	5649	5700	5658	5294
90	5375	5416	5280	5412	5385
95	5661	5543	5609	5391	5615



Hopping Frequency Sequence Name: HOP_FREQ_SEQ_09

Frequency (MHz)	0	1	2	3	4
0	5331	5352	5508	5612	5310
5	5378	5404	5616	5403	5596
10	5434	5493	5439	5511	5277
15	5371	5658	5458	5338	5666
20	5482	5344	5535	5328	5704
25	5579	5394	5437	5650	5398
30	5417	5591	5708	5279	5419
35	5379	5303	5646	5549	5287
40	5589	5253	5705	5457	5441
45	5543	5266	5548	5664	5366
50	5411	5641	5334	5639	5527
55	5255	5456	5709	5692	5313
60	5429	5568	5607	5410	5623
65	5318	5359	5256	5564	5629
70	5715	5341	5555	5724	5321
75	5678	5619	5634	5575	5478
80	5572	5644	5363	5432	5562
85	5598	5263	5440	5526	5345
90	5711	5445	5349	5645	5295
95	5280	5624	5507	5273	5718

Hopping Frequency Sequence Name: HOP_FREQ_SEQ_10

Frequency (MHz)	0	1	2	3	4
0	5586	5591	5444	5676	5530
5	5420	5329	5691	5469	5328
10	5268	5282	5480	5706	5298
15	5459	5310	5561	5383	5393
20	5413	5476	5320	5677	5467
25	5343	5640	5279	5432	5577
30	5665	5494	5668	5674	5442
35	5262	5345	5274	5428	5433
40	5643	5697	5702	5437	5421
45	5626	5324	5601	5551	5620
50	5587	5692	5423	5365	5471
55	5346	5410	5424	5511	5284
60	5384	5594	5513	5439	5333
65	5385	5446	5267	5395	5466
70	5359	5335	5312	5327	5558
75	5445	5700	5280	5647	5264
80	5302	5653	5633	5682	5425
85	5527	5495	5559	5318	5641
90	5575	5512	5491	5299	5434
95	5610	5451	5404	5456	5608



Hopping Frequency Sequence Name: HOP_FREQ_SEQ_11

Frequency (MHz)	0	1	2	3	4
0	5269	5355	5380	5362	5372
5	5559	5351	5291	5632	5535
10	5674	5546	5521	5426	5319
15	5450	5437	5664	5331	5575
20	5401	5579	5417	5409	5650
25	5670	5271	5383	5466	5501
30	5622	5612	5345	5397	5581
35	5353	5713	5524	5687	5267
40	5516	5462	5321	5366	5709
45	5382	5654	5341	5496	5288
50	5268	5512	5663	5318	5534
55	5364	5614	5330	5633	5513
60	5284	5458	5634	5647	5691
65	5431	5298	5629	5613	5481
70	5410	5658	5294	5714	5616
75	5384	5348	5317	5681	5655
80	5556	5544	5599	5635	5704
85	5359	5350	5547	5254	5300
90	5457	5320	5312	5416	5473
95	5390	5592	5400	5609	5449

Hopping Frequency Sequence Name: HOP_FREQ_SEQ_12

Frequency (MHz)	0	1	2	3	4
0	5524	5594	5316	5523	5592
5	5601	5276	5366	5320	5267
10	5605	5432	5562	5621	5340
15	5538	5564	5292	5376	5409
20	5270	5455	5401	5623	5522
25	5474	5584	5500	5543	5355
30	5579	5352	5692	5720	5444
35	5509	5677	5581	5599	5519
40	5318	5673	5381	5317	5343
45	5610	5703	5372	5464	5319
50	5486	5262	5722	5329	5527
55	5604	5642	5449	5578	5460
60	5374	5470	5640	5370	5508
65	5521	5416	5553	5396	5661
70	5555	5488	5504	5491	5615
75	5662	5330	5462	5283	5718
80	5544	5598	5324	5304	5452
85	5465	5463	5354	5669	5525
90	5587	5445	5576	5298	5588
95	5552	5550	5466	5417	5566



Hopping Frequency Sequence Name: HOP_FREQ_SEQ_13

Frequency (MHz)	0	1	2	3	4
0	5304	5358	5252	5684	5434
5	5643	5298	5441	5483	5571
10	5439	5696	5603	5341	5361
15	5626	5691	5395	5421	5484
20	5320	5339	5396	5490	5596
25	5509	5471	5677	5688	5534
30	5682	5536	5567	5271	5415
35	5287	5535	5305	5355	5612
40	5420	5457	5370	5315	5602
45	5400	5401	5663	5493	5723
50	5543	5690	5309	5584	5435
55	5272	5519	5346	5575	5674
60	5614	5445	5410	5383	5671
65	5589	5406	5340	5316	5694
70	5625	5382	5286	5531	5632
75	5527	5537	5440	5718	5447
80	5306	5453	5525	5380	5658
85	5516	5667	5258	5568	5630
90	5566	5291	5551	5634	5604
95	5500	5657	5470	5655	5273

Hopping Frequency Sequence Name: HOP_FREQ_SEQ_14

Frequency (MHz)	0	1	2	3	4
0	5559	5597	5663	5370	5654
5	5685	5698	5516	5549	5303
10	5485	5644	5439	5382	5714
15	5721	5401	5466	5676	5328
20	5505	5337	5482	5569	5300
25	5323	5405	5317	5568	5724
30	5705	5493	5307	5520	5710
35	5426	5626	5673	5605	5526
40	5356	5387	5395	5610	5312
45	5434	5341	5483	5459	5716
50	5380	5502	5719	5421	5510
55	5528	5623	5701	5709	5640
60	5546	5304	5390	5339	5684
65	5266	5494	5538	5345	5550
70	5683	5497	5319	5368	5289
75	5694	5507	5591	5329	5647
80	5680	5577	5691	5453	5499
85	5611	5450	5720	5350	5621
90	5708	5632	5309	5470	5320
95	5572	5325	5336	5646	5555



Hopping Frequency Sequence Name: HOP_FREQ_SEQ_15

Frequency (MHz)	0	1	2	3	4
0	5339	5361	5599	5531	5496
5	5349	5720	5591	5712	5510
10	5301	5274	5685	5634	5403
15	5705	5373	5504	5414	5393
20	5336	5574	5375	5571	5542
25	5663	5272	5608	5421	5602
30	5291	5691	5450	5425	5672
35	5530	5565	5469	5283	5440
40	5670	5470	5333	5309	5363
45	5699	5566	5420	5294	5645
50	5378	5472	5490	5558	5424
55	5459	5457	5432	5646	5607
60	5687	5695	5487	5381	5382
65	5478	5678	5391	5451	5389
70	5543	5483	5550	5298	5292
75	5251	5371	5563	5280	5300
80	5529	5447	5350	5636	5681
85	5328	5500	5263	5589	5290
90	5485	5578	5359	5693	5638
95	5610	5625	5467	5331	5386

Hopping Frequency Sequence Name: HOP_FREQ_SEQ_16

Frequency (MHz)	0	1	2	3	4
0	5497	5600	5535	5692	5716
5	5391	5645	5666	5400	5339
10	5610	5538	5348	5354	5424
15	5318	5500	5607	5459	5585
20	5722	5265	5316	5563	5515
25	5454	5599	5714	5622	5539
30	5430	5580	5407	5640	5446
35	5253	5704	5436	5451	5509
40	5553	5649	5518	5403	5292
45	5679	5478	5347	5532	5254
50	5596	5523	5579	5631	5319
55	5427	5512	5517	5656	5586
60	5634	5377	5433	5255	5421
65	5417	5592	5273	5481	5560
70	5437	5392	5412	5394	5623
75	5673	5536	5367	5444	5635
80	5644	5520	5465	5314	5488
85	5650	5584	5296	5277	5665
90	5706	5462	5310	5489	5274
95	5315	5350	5694	5591	5344



Hopping Frequency Sequence Name: HOP_FREQ_SEQ_17

Frequency (MHz)	0	1	2	3	4
0	5277	5364	5471	5281	5558
5	5433	5667	5266	5563	5546
10	5541	5424	5389	5549	5445
15	5406	5627	5710	5504	5399
20	5255	5334	5257	5652	5488
25	5342	5548	5442	5251	5573
30	5472	5469	5380	5598	5271
35	5521	5536	5589	5365	5348
40	5258	5587	5283	5400	5599
45	5659	5322	5508	5297	5574
50	5668	5454	5641	5615	5466
55	5707	5475	5362	5715	5324
60	5310	5259	5676	5719	5385
65	5356	5640	5284	5632	5423
70	5395	5619	5338	5468	5614
75	5435	5537	5520	5686	5317
80	5531	5655	5441	5452	5631
85	5417	5704	5333	5268	5513
90	5340	5590	5330	5360	5401
95	5294	5720	5690	5289	5592

Hopping Frequency Sequence Name: HOP_FREQ_SEQ_18

Frequency (MHz)	0	1	2	3	4
0	5532	5603	5407	5442	5303
5	5572	5592	5341	5629	5278
10	5472	5688	5430	5269	5466
15	5494	5279	5338	5549	5591
20	5263	5500	5295	5644	5461
25	5705	5400	5645	5355	5607
30	5514	5455	5321	5595	5372
35	5271	5410	5612	5429	5364
40	5284	5525	5523	5397	5528
45	5639	5340	5594	5356	5684
50	5384	5473	5625	5379	5655
55	5585	5328	5420	5422	5294
60	5333	5369	5489	5267	5714
65	5657	5622	5445	5334	5392
70	5634	5435	5562	5326	5409
75	5495	5468	5314	5427	5486
80	5555	5583	5501	5652	5573
85	5695	5647	5631	5259	5667
90	5332	5676	5319	5286	5506
95	5505	5693	5717	5510	5311



Hopping Frequency Sequence Name: HOP_FREQ_SEQ_19

Frequency (MHz)	0	1	2	3	4
0	5312	5464	5343	5603	5620
5	5614	5416	5317	5582	5306
10	5477	5471	5367	5487	5485
15	5309	5344	5497	5308	5649
20	5569	5711	5258	5434	5496
25	5252	5373	5459	5641	5653
30	5278	5713	5524	5566	5549
35	5703	5700	5517	5290	5598
40	5424	5463	5288	5394	5360
45	5619	5423	5555	5409	5474
50	5260	5676	5468	5478	5432
55	5516	5374	5612	5491	5682
60	5401	5276	5546	5483	5665
65	5268	5283	5428	5466	5327
70	5365	5398	5492	5498	5386
75	5455	5675	5251	5579	5429
80	5431	5354	5384	5403	5338
85	5534	5576	5273	5704	5670
90	5699	5301	5502	5522	5328
95	5355	5280	5631	5625	5323

Hopping Frequency Sequence Name: HOP_FREQ_SEQ_20

Frequency (MHz)	0	1	2	3	4
0	5470	5703	5279	5289	5365
5	5656	5539	5491	5480	5314
10	5712	5266	5512	5562	5508
15	5573	5436	5447	5542	5500
20	5657	5260	5652	5250	5407
25	5384	5676	5576	5660	5675
30	5695	5708	5710	5453	5298
35	5591	5416	5496	5670	5679
40	5437	5507	5401	5431	5391
45	5599	5506	5613	5462	5361
50	5611	5350	5252	5557	5301
55	5376	5704	5328	5327	5310
60	5653	5530	5441	5254	5378
65	5309	5469	5707	5367	5597
70	5546	5567	5478	5598	5641
75	5345	5424	5320	5297	5560
80	5681	5444	5610	5451	5466
85	5335	5515	5690	5619	5509
90	5324	5307	5524	5360	5705
95	5713	5631	5410	5264	5529



Hopping Frequency Sequence Name: HOP_FREQ_SEQ_21

Frequency (MHz)	0	1	2	3	4
0	5250	5467	5690	5450	5682
5	5698	5561	5566	5643	5521
10	5546	5530	5553	5282	5529
15	5661	5563	5550	5587	5692
20	5665	5329	5593	5339	5380
25	5650	5528	5289	5709	5262
30	5694	5667	5668	5584	5255
35	5507	5389	5445	5276	5687
40	5671	5485	5693	5579	5589
45	5515	5626	5390	5526	5303
50	5646	5599	5417	5517	5604
55	5624	5659	5606	5674	5685
60	5707	5557	5292	5656	5403
65	5508	5392	5349	5639	5464
70	5601	5393	5717	5304	5296
75	5440	5541	5361	5554	5391
80	5615	5332	5437	5357	5275
85	5336	5474	5278	5555	5722
90	5525	5711	5272	5644	5265
95	5459	5465	5723	5427	5486

Hopping Frequency Sequence Name: HOP_FREQ_SEQ_22

Frequency (MHz)	0	1	2	3	4
0	5505	5706	5626	5611	5427
5	5362	5486	5641	5709	5350
10	5477	5416	5594	5550	5274
15	5690	5653	5535	5409	5576
20	5495	5631	5331	5353	5538
25	5410	5393	5268	5401	5583
30	5624	5408	5699	5404	5394
35	5598	5660	5604	5590	5295
40	5277	5436	5482	5525	5462
45	5672	5632	5568	5513	5266
50	5702	5354	5357	5325	5642
55	5605	5711	5707	5423	5595
60	5313	5296	5619	5517	5533
65	5503	5493	5342	5718	5284
70	5627	5547	5701	5717	5693
75	5263	5265	5463	5522	5613
80	5664	5647	5304	5689	5329
85	5574	5340	5713	5431	5328
90	5542	5339	5684	5526	5476
95	5520	5422	5368	5446	5650



Hopping Frequency Sequence Name: HOP_FREQ_SEQ_23

Frequency (MHz)	0	1	2	3	4
0	5285	5470	5562	5297	5269
5	5404	5508	5716	5397	5557
10	5408	5680	5635	5672	5571
15	5265	5342	5281	5580	5601
20	5584	5661	5572	5420	5326
25	5329	5613	5497	5302	5443
30	5569	5581	5526	5376	5602
35	5533	5689	5456	5276	5518
40	5378	5690	5579	5479	5454
45	5442	5280	5621	5303	5617
50	5403	5405	5446	5623	5489
55	5696	5665	5325	5620	5469
60	5461	5546	5694	5554	5550
65	5430	5704	5566	5697	5612
70	5583	5629	5503	5390	5677
75	5428	5468	5277	5294	5718
80	5298	5307	5283	5380	5345
85	5386	5493	5575	5313	5320
90	5347	5638	5266	5270	5471
95	5693	5535	5384	5662	5664

Hopping Frequency Sequence Name: HOP_FREQ_SEQ_24

Frequency (MHz)	0	1	2	3	4
0	5540	5709	5498	5458	5489
5	5446	5433	5316	5560	5289
10	5717	5469	5298	5295	5592
15	5353	5372	5287	5625	5318
20	5255	5513	5412	5299	5692
25	5656	5341	5698	5336	5485
30	5538	5266	5422	5575	5305
35	5252	5526	5432	5365	5461
40	5531	5344	5476	5286	5363
45	5273	5577	5665	5493	5579
50	5456	5535	5409	5619	5515
55	5439	5440	5474	5626	5606
60	5278	5282	5492	5517	5503
65	5414	5285	5708	5477	5519
70	5329	5415	5548	5581	5703
75	5675	5484	5642	5312	5684
80	5340	5701	5718	5455	5261
85	5650	5334	5545	5351	5655
90	5668	5495	5510	5630	5297
95	5693	5704	5464	5268	5683



Hopping Frequency Sequence Name: HOP_FREQ_SEQ_25

Frequency (MHz)	0	1	2	3	4
0	5698	5473	5531	5522	5331
5	5488	5455	5391	5723	5593
10	5648	5258	5339	5490	5613
15	5441	5499	5390	5670	5607
20	5503	5421	5551	5501	5272
25	5580	5605	5544	5327	5370
30	5527	5347	5495	5481	5302
35	5620	5714	5493	5679	5443
40	5641	5469	5584	5690	5402
45	5446	5709	5630	5280	5507
50	5624	5269	5597	5573	5705
55	5411	5603	5316	5585	5583
60	5438	5718	5549	5353	5592
65	5716	5511	5646	5505	5332
70	5264	5524	5615	5453	5348
75	5343	5465	5419	5325	5699
80	5500	5684	5621	5394	5435
85	5288	5283	5710	5357	5689
90	5550	5685	5378	5591	5683
95	5369	5662	5363	5420	5502

Hopping Frequency Sequence Name: HOP_FREQ_SEQ_26

Frequency (MHz)	0	1	2	3	4
0	5478	5712	5467	5683	5551
5	5627	5380	5466	5411	5325
10	5579	5522	5685	5634	5529
15	5626	5493	5618	5324	5511
20	5490	5492	5720	5371	5457
25	5650	5431	5404	5666	5333
30	5452	5696	5440	5378	5584
35	5416	5357	5518	5724	5407
40	5349	5567	5619	5382	5292
45	5342	5623	5456	5558	5713
50	5470	5699	5310	5527	5420
55	5455	5257	5481	5496	5417
60	5506	5541	5498	5389	5327
65	5692	5718	5588	5335	5491
70	5500	5574	5422	5486	5446
75	5435	5721	5388	5563	5695
80	5501	5524	5711	5284	5483
85	5717	5273	5578	5400	5363
90	5723	5616	5641	5265	5362
95	5489	5565	5472	5482	5458



Hopping Frequency Sequence Name: HOP_FREQ_SEQ_27

Frequency (MHz)	0	1	2	3	4
0	5258	5476	5403	5369	5393
5	5669	5402	5541	5477	5532
10	5413	5408	5421	5405	5655
15	5520	5278	5596	5663	5516
20	5519	5656	5433	5582	5693
25	5259	5406	5378	5535	5438
30	5708	5697	5409	5339	5703
35	5638	5420	5675	5687	5607
40	5271	5454	5332	5345	5492
45	5564	5451	5362	5709	5350
50	5261	5499	5632	5609	5424
55	5293	5546	5498	5384	5610
60	5274	5256	5386	5646	5538
65	5724	5427	5267	5447	5328
70	5634	5495	5412	5574	5435
75	5340	5533	5294	5491	5351
80	5545	5502	5552	5626	5692
85	5696	5524	5553	5722	5344
90	5448	5521	5301	5565	5466
95	5660	5250	5658	5320	5346

Hopping Frequency Sequence Name: HOP_FREQ_SEQ_28

Frequency (MHz)	0	1	2	3	4
0	5513	5715	5339	5530	5613
5	5711	5327	5616	5640	5264
10	5344	5672	5462	5600	5676
15	5608	5405	5699	5708	5430
20	5250	5471	5574	5666	5525
25	5258	5581	5639	5472	5275
30	5586	5366	5554	5477	5458
35	5559	5291	5580	5285	5282
40	5293	5512	5283	5257	5561
45	5380	5720	5317	5311	5314
50	5494	5278	5333	5660	5591
55	5490	5686	5338	5325	5568
60	5702	5515	5336	5483	5653
65	5633	5373	5565	5396	5364
70	5369	5673	5298	5484	5560
75	5438	5664	5355	5492	5263
80	5611	5675	5505	5603	5558
85	5619	5689	5592	5416	5427
90	5307	5439	5316	5722	5294
95	5596	5255	5694	5262	5375



Hopping Frequency Sequence Name: HOP_FREQ_SEQ_29

Frequency (MHz)	0	1	2	3	4
0	5671	5479	5275	5691	5455
5	5278	5349	5328	5568	5461
10	5503	5698	5697	5696	5435
15	5705	5425	5438	5416	5412
20	5663	5639	5413	5585	5309
25	5365	5506	5414	5572	5323
30	5294	5629	5382	5376	5607
35	5595	5497	5558	5687	5700
40	5400	5369	5367	5284	5509
45	5711	5602	5337	5302	5292
50	5515	5387	5673	5644	5501
55	5428	5485	5556	5319	5291
60	5345	5676	5565	5576	5653
65	5546	5538	5513	5331	5451
70	5707	5256	5721	5486	5380
75	5668	5539	5308	5374	5589
80	5611	5330	5334	5270	5631
85	5281	5298	5542	5420	5478
90	5359	5371	5692	5430	5411
95	5280	5405	5306	5601	5646

Hopping Frequency Sequence Name: HOP_FREQ_SEQ_30

Frequency (MHz)	0	1	2	3	4
0	5451	5718	5686	5377	5675
5	5417	5274	5291	5491	5300
10	5584	5250	5544	5418	5309
15	5562	5333	5701	5617	5446
20	5485	5353	5655	5612	5679
25	5534	5512	5469	5540	5456
30	5461	5280	5509	5403	5476
35	5362	5473	5647	5688	5585
40	5678	5634	5262	5555	5616
45	5680	5483	5427	5323	5646
50	5505	5685	5287	5691	5615
55	5281	5490	5721	5608	5644
60	5676	5666	5470	5317	5382
65	5492	5294	5339	5411	5360
70	5379	5629	5541	5265	5307
75	5410	5579	5376	5389	5467
80	5632	5303	5320	5472	5437
85	5586	5331	5330	5273	5251
90	5624	5252	5315	5517	5484
95	5665	5716	5383	5395	5653

--- END ---