

CONTENTS

Important Safety Instructions	1
Precautions to Avoid Possible Exposure to Excessive Microwave Energy.....	1
California Proposition 65 Warning.....	1
General Warning	1
Grounding Instructions	3
Installation Guide.....	4
Cooking Utensils Guide.....	5
Product Diagram	6
Control Panel	7
First Time Use	8
Product Specifications	8
Operation Instructions	9
Setting the Clock.....	9
Timer	10
Quick Start Microwave.....	10
Microwave Cooking	11
Beverage	12
Popcorn	12
Dinner Plate	13
Frozen Vegetable	13
Potato.....	14
Soup	14
Sensor Cook.....	15
Sensor Reheat	16
Weight Defrost.....	17
Time Defrost	18
Child Lock	19
+30 Sec Function	19
Troubleshooting	20
Cleaning and Care	21
Product Warranty	22
Warranty Registration	23

IMPORTANT SAFETY INSTRUCTIONS

PRECAUTIONS TO AVOID POSSIBLE EXPOSURE TO EXCESSIVE MICROWAVE TECHNOLOGY

- Do not attempt to operate this oven with the door open since open-door operation can result in harmful exposure to microwave energy. It is important not to tamper with the safety interlocks.
- Do not place any object between the oven front face and the door or allow soil or cleaner residue to accumulate on sealing surfaces.
- Do not operate the oven if it is damaged. It is very important that the oven door closes properly and that there is no damage to the
 - a) Door (including any dents),
 - b) Hinges and latches (broken or loosened),
 - c) Door seals and sealing surfaces.The oven should not be adjusted or repaired by anyone except qualified service personnel.

CALIFORNIA PROPOSITION 65 WARNING

CALIFORNIA RESIDENTS ONLY—

WARNING: This product can expose you to chemicals including styrene, which are known to the State of California to cause cancer, and bisphenol A (BPA), which are known to the State of California to cause birth defects or other reproductive harm. For more information go to www.P65Warnings.ca.gov

SOLO RESIDENTES DE CALIFORNIA

ADVERTENCIA: Este producto puede exponerlo a productos químicos, incluido el estireno, que en el estado de California es cancerígeno, y al bisfenol A (BPA), que el estado de California considera que causan defectos de nacimiento u otros daños reproductivos. Para obtener más información, vaya a www.P65Warnings.ca.gov

GENERAL WARNING

To reduce the risk of burns, electric shock, fire, injury to persons or exposure to excessive microwave energy:

- Read all instructions before using the appliance.
- Read and follow the specific "PRECAUTIONS TO AVOID POSSIBLE EXPOSURE TO EXCESSIVE MICROWAVE ENERGY" on page 1.
- This appliance must be grounded. Connect only to properly grounded outlet. See "GROUNDING INSTRUCTIONS" on page 3.
- Do not operate the oven when empty.
- Install or locate this appliance only in accordance with the provided installation instructions.
- Some products such as whole eggs and sealed containers -for example, closed glass jars- could explode and should not be heated in this oven.
- Use this appliance only for its intended use as described in this manual. Do not use corrosive chemicals or vapors in this appliance. This type of oven is specifically designed to heat, cook, or dry food. It is not designed for industrial or laboratory use.
- As with any appliance, close supervision is necessary when used by children.
- To reduce the risk of fire in the oven cavity:
 - Do not overcook food. Carefully attend appliance when paper, plastic, or other combustible materials are placed inside the oven to facilitate cooking.
 - Remove wire twist-ties from paper or plastic bags before placing bag in oven.
 - If materials inside the oven should ignite, keep oven door closed, turn oven off using the circuit breaker panel, and call

SAVE THESE INSTRUCTIONS

IMPORTANT SAFETY INSTRUCTIONS

emergency services.

- Do not use the cavity for storage purposes. Do not leave paper products, cooking utensils or food in the cavity when not in use.
- Liquids, such as water, coffee, or tea are able to be overheated beyond the boiling point without appearing to be boiling due to surface tension of the liquid. Visible bubbling or boiling when the container is removed from the microwave oven is not always present. This could result in very hot liquids suddenly boiling over when a spoon or other utensil is inserted into the liquid.
- To reduce the risk of injury to person:
 - Do not overheat the liquid.
 - Stir the liquid both before and halfway through heating it.
 - Do not use straight-sided containers with narrow necks.
 - After heating, allow the container to stand in the microwave oven for a short time before removing the container.
 - Use extreme care when inserting a spoon or other utensil into the container.
- Do not heat oil or fat for deep-frying. It is difficult to control the temperature of oil in a microwave oven.
- Do not cover or block any openings on the appliance.
- Do not operate this appliance if it has a damaged cord or a plug, if it is not working properly or if it has been damaged or dropped.
- Do not immerse cord or plug in water. Keep cord away from heated surface. Do not let cord hang over edge of table or counter.
- This appliance should be serviced only by qualified service personnel, contact nearest authorized service facility for examination, repair, or adjustment.
- When cleaning surfaces of door and oven that comes together on closing the door, use only mild, nonabrasive soaps, or

detergents applied with a sponge or soft cloth.

- Oversized food or oversized metal utensils should not be inserted in a microwave/toaster oven as they may create a fire or risk of electric shock.
- Do not store or use this appliance outdoors. Do not use this product near water, for example, near a kitchen sink, in a wet basement, near a swimming pool, or similar locations.
- Do not clean with metal scouring pads. Pieces can break off the pad and touch electrical parts involving a risk of electric shock.
- Do not store any materials, other than manufacturer's recommended accessories, in this oven when not in use.
- Do not cover turntables, pans or any other part of the oven with metal foil. This will cause overheating of the oven.
- This equipment has been tested and found to comply with Part 18 of the FCC Rules. Operation is subject to the following two conditions: (1) This device may not cause harmful interference, and (2) this device must accept any interference received, including interference that may cause undesired operation.

CAUTION: Changes or modifications not expressly approved by the party responsible for compliance could void the user's authority to operate the product.

This equipment generates, uses and can radiate radio frequency energy and, if not installed and used in accordance with the instructions, may cause harmful interference to radio communications. However, there is no guarantee that interference will not occur in a particular

SAVE THESE INSTRUCTIONS

IMPORTANT SAFETY INSTRUCTIONS

installation. If this equipment does cause harmful interference to radio or television reception, which can be determined by turning the equipment off and on, the user is encouraged to try to correct the interference by one or more of the following measures:

- Reorient or relocate the receiving antenna.
- Increase the separation between the equipment and receiver.
- Connect the equipment into an outlet on a circuit different from that to which the receiver is connected.
- Consult the dealer or an experienced radio/TV technician for help.

GROUNDING INSTRUCTIONS

This appliance must be grounded. In the event of an electrical short circuit, grounding reduces risk of electric shock by providing an escape wire for the electric current. This appliance is equipped with a cord having a grounding wire with a grounding plug. The plug must be plugged into an outlet that is properly installed and grounded.

Consult a qualified electrician or serviceman if the grounding instructions are not completely understood, or if doubt exists as to whether the appliance is properly grounded, and if it is necessary to use an extension cord, use only a 3-wire extension cord that has a 3-blade grounding plug and a 3-slot receptacle that will accept the plug on the appliance. The marked rating of the extension cord shall be equal to or greater than the electrical rating of the appliance.

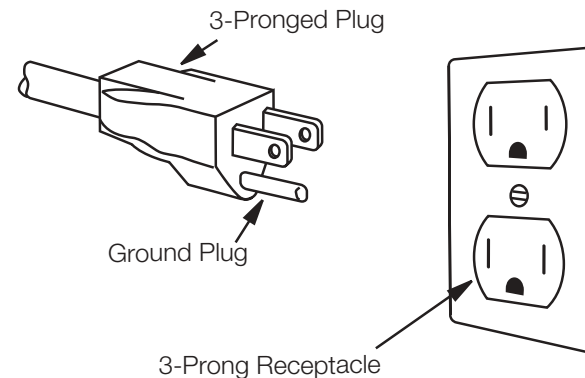

SAVE THESE INSTRUCTIONS

IMPORTANT SAFETY INSTRUCTIONS

Electrical Requirements

The electrical requirements are a 120 volt 60 Hz, AC only, 20 amp. It is recommended that a separate circuit serving only the oven be provided. The oven is equipped with a 3-prong grounding plug. It must be plugged into a wall outlet properly installed and grounded.

Power Cord

—A short power supply cord is provided to reduce the risks resulting from becoming entangled in or tripping over a longer cord.

—Longer cord sets or extension cords are available and may be used if care is exercised in their use.

—If long cord or extension cord is used:

- The marked electrical rating of the cord set or extension cord should be at least as near as the electrical rating of the appliance.
- The extension cord must be a grounding-type 3-wire cord, and The longer cord should be arranged so that it will not drape over the countertop or tabletop where it can be pulled on by children or tripped over accidentally.

SAVE THESE INSTRUCTIONS

INSTALLATION GUIDE

- Make sure that all the packing materials are removed from the inside of the door.
- This microwave oven must be placed on a flat, stable surface.
- For correct operation, the oven must have sufficient airflow. Allow minimum 8 inch (20.32cm) of free space necessary above the top surface of the oven and 2 inch (5.08cm) at both sides. Do not cover or block any openings on the appliance. Do not remove feet.
- The appliance shall be only used on a countertop over 3 feet (91.44cm) above the floor.
- Do not place the oven where heat, moisture, or high humidity are generated, or near combustible materials.

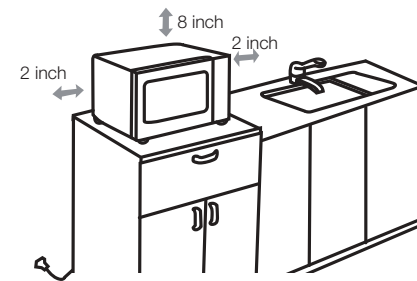

- Make sure that the power cord is undamaged and does not run under the oven or over any hot or sharp surface.
- The socket must be readily accessible so the microwave oven can be easily unplugged in an emergency.

IMPORTANT SAFETY INSTRUCTIONS

IMPORTANT SAFETY INSTRUCTIONS

COOKING UTENSILS GUIDE



This section lists which utensils can be used in this microwave, which have limited use for short periods, and which should not be used in this microwave.

RECOMMENDED

Microwave browning dish — Use to brown the exterior of small items such as steaks, chops, or pancakes. Follow the directions provided with your browning dish.

Microwaveable plastic wrap — Use to retain steam. Leave a small opening for some steam to escape and avoid placing it directly on the food.

Paper towels and napkins — Use for short-term heating and covering; these absorb excess moisture and prevent spattering. Do not use recycled paper towels, which may contain metal and could ignite.

Glass and glass-ceramic bowls and dishes — Use for heating or cooking.

Paper plates and cups — Use for short-term heating at low temperatures. Do not use recycled paper, which contain metal and could ignite.

Wax paper — Use as a cover to prevent spattering.

Thermometers — Use only those labeled "Microwave Safe" and follow all directions. Check the food in several places. Conventional thermometers may be used on microwave food once the food has been removed from the oven.

LIMITED USE

Aluminum foil — Use narrow strips of foil to prevent overcooking of exposed areas. Using too much foil can damage your oven, so be careful. You should keep distance of 1 inch (2.54cm) between aluminum foil and cavity.

Ceramic, porcelain, and stoneware — Use these if they are labeled "Microwave Safe". If they are not labeled, test them to make sure they can be used safely.

Plastic — Use only if labeled "Microwave Safe". Other plastics can melt.

NOT RECOMMENDED

Glass jars and bottles — Regular glass is too thin to be used in a microwave. It can shatter and cause damage and injury.

Paper bags — These are a fire hazard, except for popcorn bags.

Styrofoam plates and cups — These can melt and leave an unhealthy residue on food.

Plastic storage and food containers — Containers such as margarine tubs can melt in the microwave.

Metal utensils — These can damage your oven. Remove all metal before cooking.

Note:

Should you wish to check if a dish is safe for microwaving, place the empty dish in the oven and microwave at high power level for 30 seconds. A dish which becomes very hot should not be used.

SAVE THESE INSTRUCTIONS

PRODUCT DIAGRAM

1. Control Panel
2. Display Screen
3. Menu / Time / Portion / Level Selector Knob
4. Oven Window
5. Glass Turntable
6. Roller Ring
7. Shaft
8. Wave Guide (Please do not remove the mica plate covering the wave guide)
9. Door Safety Lock System

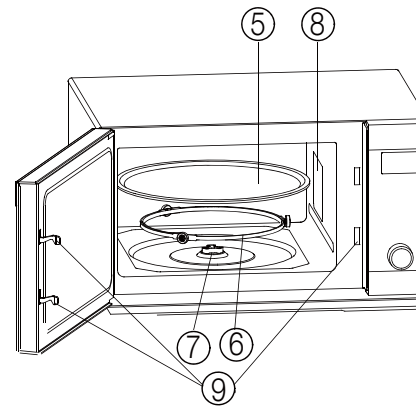
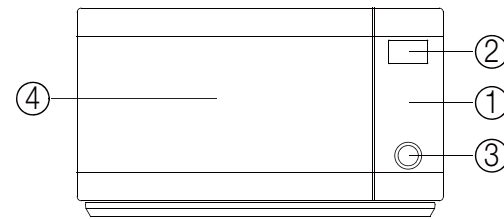

PRODUCT DIAGRAM

CONTROL PANEL

CONTROL PANEL



BEVERAGE

Used to make hot drinks (See Page 16).

POPCORN

Use to set popcorn program (See Page 16).

DINNER PLATE

Used to heat up a dinner plate (See Page 18).

FROZEN VEGETABLE

Used to heat up frozen vegetables (See Page 17).

POTATO

Used to make potatoes (See Page 17).

SOUP

Used to make soup (See Page 18).

SENSOR COOK

Use to set the automatic sensor cook programs (See Page 12).

SENSOR REHEAT

Use to set the automatic sensor reheat programs (See Page 13).

TIME / WEIGHT DEFROST

Press to set defrost program based on time (See Page 15).

Press to set defrost program based on weight (See Page 14).

CLOCK /TIMER

Press and hold to set the clock time (See Page 9).
Press to set the timer function (See Page 10).

POWER LEVEL

Use to microwave food with selected power level (See Page 11).

LOCK

Press and hold to set child lock (See Page 19).

+30 SEC

Press to add time (See Page 19).

STOP/CANCEL

Press to clear all previous settings before cooking starts.

Press once to pause current cooking program or press twice to cancel the program.

Menu / Time / Weight / Level Selector Knob

Turn to select cooking menus, time, food weight, portion, or power level.

FIRST TIME USE

If you are using your microwave oven for the first time, please be sure to:

- Clean the glass turntable, with hot water, a small amount of dishwashing liquid and a nonabrasive cleaning pad.
- Do not immerse the body of the unit in water.
- When you plug in the unit, the display will show "12:00".
- While you are in the process of any setting, the oven will return to standby mode after 20 seconds without any operation.
- During cooking, if press **STOP/CANCEL** once or open the door, the program will be paused. Press the dial to resume cooking, but if you press **STOP/CANCEL** twice, the program will be canceled.
- When the cooking completes, the screen will display "End" with sound every two minutes until you press **STOP/CANCEL** or open the door.

Product Specifications







Power supply	120V/60Hz
Power Consumption (Microwave)	1500W
Rated Microwave Power Output	1100W
Operating Frequency	2450MHZ
Outside Dimensions (W x H x D)	21 3/4 X 12 1/8 X 18 inches
Oven Cavity Dimensions (W x H x D)	16 X 9 3/4 X 15 inches
Oven Capacity	1.3 Cu.Ft.
Net Weight	Approx. 37.26lbs

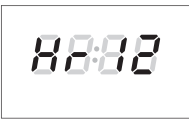

OPERATION INSTRUCTIONS

Setting the Clock

You can set the clock in 12-hour or 24-hour by pressing **CLOCK/TIMER** in standby mode.

Example: How to set a 12-hour clock at 11:58.

1 In standby mode, press and hold CLOCK/TIMER for 3 seconds to select 12-hour clock (press the pad again to select 24-hour clock).	
	
2 Turn the dial until the correct hour is displayed.	
	
3 Press the dial or CLOCK/TIMER to confirm the hour.	
 or 	

4 Turn the dial until the correct minute is displayed.	
	

5 Press the dial or CLOCK/TIMER to confirm the minute and finish setting.	
 or 	

NOTE: While in the process of setting the clock, you can cancel the settings by pressing the **STOP/CANCEL**.







OPERATION INSTRUCTIONS

Timer

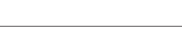

You can use the timer feature to count down a specific amount of time whether it's for cooking or for anything else.

Example: How to set the timer for 3 minutes and 50 seconds.





<p>1 Press CLOCK/TIMER once.</p>	
	
<p>2 Turn the dial to enter the time. The maximum time you can set is 95 minutes.</p>	
	
<p>3 Press the dial or CLOCK/TIMER to confirm and start countdown.</p>	
 or 	

NOTE: Timer countdown can be seen for 5 seconds by touching **CLOCK/TIMER**, if press **STOP/CANCEL** during these 5 seconds, the timer will be canceled.

Quick Start Microwave

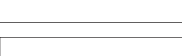

Example: How to quick start microwave for 3 minutes and 50 seconds.



<p>1 In standby mode, turn the dial to enter the time.</p>	
	
<p>2 Press the dial to confirm and start cooking.</p>	
	

OPERATION INSTRUCTIONS



Microwave Cooking

Example: Cook at 30% power level for 3 minutes and 50 seconds.



1 Press **POWER LEVEL** pad once, the default power level is 100% (maximum power).



2 Turn the dial to select the 30% power level.

3 Press the dial once to confirm the power level.

4 Turn the dial again to enter cooking time.

5 Press the dial to confirm and start cooking.



Power Level Chart:





Power Level	Display	Power Level	Display
100%	P100	50%	P 50
90%	P 90	40%	P 40
80%	P 80	30%	P 30
70%	P 70	20%	P 20
60%	P 60	10%	P 10

OPERATION INSTRUCTIONS

Beverage





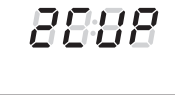

Example: How to heat up a cup of 8 oz beverage.

<p>1 In standby mode, press the BEVERAGE.</p> <div style="text-align: center; border: 1px solid black; padding: 5px; width: fit-content; margin: 0 auto;">BEVERAGE</div>	
<p>2 Turn the dial to select the weight. Display shows 1CUP, 2CUP, or 3CUP.</p> <div style="text-align: center; border: 1px solid black; padding: 5px; width: fit-content; margin: 0 auto;">  </div>	
<p>3 Press the dial once to confirm and start cooking.</p> <div style="text-align: center; border: 1px solid black; padding: 5px; width: fit-content; margin: 0 auto;">  </div>	

Popcorn

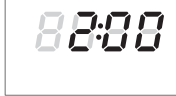

Example: How to cook popcorn for 3 minutes and 30 seconds.

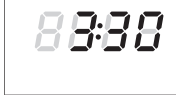
<p>1 In standby mode, press the POPCORN. The default time is 2 minutes and 30 seconds (For one bag around 3.2oz).</p> <div style="text-align: center; border: 1px solid black; padding: 5px; width: fit-content; margin: 0 auto;">POPCORN</div>	
<p>2 Turn the dial to select the cooking time.</p> <div style="text-align: center; border: 1px solid black; padding: 5px; width: fit-content; margin: 0 auto;">  </div>	
<p>3 Press the dial once to confirm and start cooking.</p> <div style="text-align: center; border: 1px solid black; padding: 5px; width: fit-content; margin: 0 auto;">  </div>	







NOTE:

The default time is 2 minutes. For default time, you can skip step 2, directly press the dial to start if you prefer.

OPERATION INSTRUCTIONS







Dinner Plate

Example: How to cook a 11-12 inches dinner plate of 9 oz.

<p>1 In standby mode, press the DINNER PLATE.</p>	
	
<p>2 Turn the dial to select the size. Display shows S (0-8 oz.) or L (8-16 oz.).</p>	
	
<p>3 Press the dial once to confirm and start cooking.</p>	
	

Frozen Vegetable

Example: How to cook 8 oz of frozen vegetables.







<p>1 In standby mode, press the FROZEN VEGETABLE.</p>	
	
<p>2 Turn the dial to select the weight. Display shows 8, 12, 16, or 20 (oz.).</p>	
	
<p>3 Press the dial once to confirm and start cooking.</p>	
	

OPERATION INSTRUCTIONS

Potato









Example: How to cook a potato of 8 oz.

<p>1 In standby mode, press the POTATO.</p>	
	
<p>2 Turn the dial to select the weight. Display shows 8,12,16, 20 or 24 (oz.).</p>	
	
<p>3 Press the dial once to confirm and start cooking.</p>	
	

Soup



Example: How to cook 2 cups of soup.

<p>1 In standby mode, press the SOUP.</p>	
	
<p>2 Turn the dial to select the weight. Display shows 1CUP, 2CUP, or 3CUP.</p>	
	
<p>3 Press the dial once to confirm and start cooking.</p>	
	







OPERATION INSTRUCTIONS

Sensor Cook

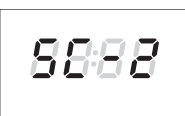

For sensor cook function, you can select the type of food you want to cook from the programs listed on the cooking label located on the interior panel of the appliance.

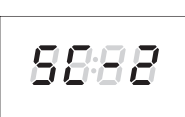
Auto Program: How to Cook 8 oz fish with sensor.

<p>1 In standby mode, press the SENSOR COOK once.</p>	
	
<p>2 Turn the dial to select food code 'SC-2' (Fish).</p>	
	
<p>3 Press the dial once to confirm and start sensing and cooking.</p>	
	

4 The appliance will start countdown after detecting the moisture. Before countdown, the food code will display.



Sensor Cook Food Chart (Auto Program):

Food	Code	Weight Range
Corn on the Cob	SC-1	8-24 oz
Fish	SC-2	7-21 oz
Fresh Vegetable	SC-3	7-21 oz
Ground Meat	SC-4	5-24 oz
Oatmeal	SC-5	5-16 oz
Rice	SC-6	5-16 oz

NOTE:







- After cooking for a period of time, the system will detect whether there is error, if there is error, for example, the sensor short circuit or open circuit, the system will stop automatically with the display showing "Er60", beeps sound until press **STOP/CANCEL** pad.
- If there is no error, the system will judge corresponding cooking time based on the steam generated by the food, after cooking for a period of time, the countdown will display on the screen.
- During sensor cooking program, if press **STOP/CANCEL** pad once or open the door, the system will turn back to standby mode.
- If during the longest sensor time the oven cannot judge the cooking time according the steam produced by food in the cavity, the cooking will auto-end.

OPERATION INSTRUCTIONS

Sensor Reheat

For sensor reheat function, you can select the type of food you want to cook from the programs listed on the cooking label located on the interior panel of the appliance.

Auto Program: How to Reheat chili with sensor.

<p>1 In standby mode, press the SENSOR REHEAT once.</p> 	
<p>2 Turn the dial to select food code 'SH-1' (Chili).</p> 	
<p>3 Press the dial once and start sensing and cooking.</p> 	

4 The appliance will start countdown after detecting the moisture. Before countdown, the food code will display.



Sensor Reheat Food Chart (Auto Program):

Food	Code	Weight Range
Chili	SH-1	5-24 oz
Frozen Entrée	SH-2	7-24 oz
Frozen Pizza	SH-3	5-16 oz
Mac and Cheese	SH-4	5-16 oz
Mashed Potatoes	SH-5	5-24 oz
Pasta	SH-6	5-24 oz
Rice	SH-7	5-28 oz

NOTE:

- After cooking for a period of time, the system will detect whether there is error, if there is error, for example, the sensor short circuit or open circuit, the system will stop automatically with the display showing "Er60", beeps sound until press **STOP/CANCEL** pad.
- If there is no error, the system will judge corresponding cooking time based on the steam generated by the food, after cooking for a period of time, the countdown will display on the screen.
- During sensor cooking program, if press **STOP/CANCEL** pad once or open the door, the system will turn back to standby mode.
- If during the longest sensor time the oven cannot judge the cooking time according the steam produced by food in the cavity, the cooking will auto-end.

OPERATION INSTRUCTIONS

Weight Defrost

The defrosting time and power level are automatically set once the food category and the weight are selected.

Example: How to defrost 8oz seafood.

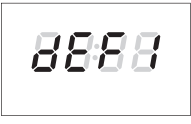

1 In standby mode, press the **TIME/WEIGHT DEFROST** twice.

2 Turn the dial to select food code 'dEF3' (Seafood).



3 Press the dial once to confirm the food type.

4 Turn the dial to select the food weight.



5 Press the dial to confirm and start defrosting.



Weight Defrost Food Chart:

Food	Code	Maximum Weight
Meat	dEF1	80 oz
Poultry	dEF2	80 oz
Seafood	dEF3	32 oz

NOTE:

During the defrosting program, the system will pause and alert the user to turn the food over when 1/3 of the defrosting time remains. After turning food over, close the door and press the dial to resume the defrosting.

OPERATION INSTRUCTIONS

Weight must be in pounds and ounces. If label gives weight in pounds only, change the fraction of a pound to ounces using the following chart.

Converting fractions of a pound to ounces:



Fractions of a pound	Ounces	Fractions of a pound	Ounces
Less than .03	0	.54 to .59	9
.03 to .09	1	.60 to .65	10
.10 to .15	2	.66 to .71	11
.16 to .21	3	.72 to .78	12
.22 to .27	4	.79 to .84	13
.28 to .34	5	.85 to .90	14
.35 to .40	6	.91 to .97	15
.41 to .46	7	.97 to .99	16
.47 to .53	8		



Time Defrost



The defrosting power is adjusted automatically once the cooking time is programmed.

Example: How to defrost food for 3 minutes and 50 seconds.

- In standby mode, press the **TIME/WEIGHT DEFROST** once.



- Turn the dial to select the defrosting time.



- Press the dial to confirm and start defrosting.

NOTE:





During the defrosting program, the system will pause and alert the user to turn the food over when 1/3 of the defrosting time remains. After turning food over, close the door and press the dial to resume the defrosting.

OPERATION INSTRUCTIONS

Child Lock

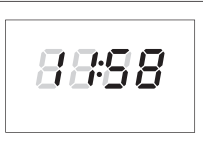
The child proof lock prevents unsupervised operation by children.



Example1: How to set/cancel the child lock.

<p>1 In standby mode, suppose the display is showing 11:58.</p>	
<p>2 Press and hold the LOCK for 3 seconds, then 'Loc' appears.</p>	
<p> Press and hold for 3 seconds.</p>	
<p>3 Press and hold the LOCK for 3 seconds, then 'Loc' disappears.</p>	
<p> Press and hold for 3 seconds.</p>	

+30 Sec Function

In standby mode, press **+30 SEC**, the microwave program will start at 100% power level and cook for 30 seconds. During cooking, you can add cooking time by touching **+30 SEC** pad repeatedly. The longest cooking time is 95 minutes.

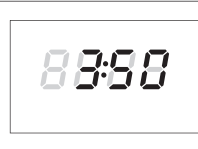
Example: During microwave cooking, add the cooking time by 2 minutes by utilizing the +30 SEC button.

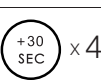
<p>1 During cooking, suppose the display is showing 3:50.</p>	
<p>2 Press the +30 SEC 4 times.</p>	
<p> x 4</p>	

NOTE:

- Below programs cannot use **+30 SEC** during cooking.
 - SENSOR COOK
 - SENSOR REHEAT
 - TIME / WEIGHT DEFROST
 - POPCORN
 - BEVERAGE
 - POTATO
 - FROZEN VEGETABLE
 - DINNER PLATE
 - SOUP

TROUBLESHOOTING

Automatic protection mechanism



OVERHEATING PROTECTION - The display may show Er10 which means the appliance has entered into high temperature overheat mode which will protect the appliance from further damage. Audible alert will be heard until **STOP/CANCEL** is pressed or the appliance is unplugged.

LOW TEMPERATURE PROTECTION - The display may show Er11 which means the appliance has entered into low temperature protection mode which will protect the appliance from further damage. Audible alert will be heard until **STOP/CANCEL** is pressed or the appliance is unplugged.

SENSOR MALFUNCTION PROTECTION - The display may show Er13 which means the appliance has entered into Sensor Malfunction protection mode which will protect the appliance from further damage. Audible alert will be heard until **STOP/CANCEL** is pressed or the appliance is unplugged.

CLEANING AND CARE

CLEANING AND CARE

- Turn off the oven and unplug the power cord from the wall when cleaning.

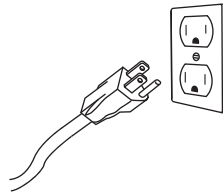

- Keep the inside of the oven clean. When food splatters or spilled liquids adhere to oven walls, wipe with a damp cloth. Mild detergents may be used if the oven gets very dirty. Avoid using spray or other harsh cleaners. They may stain, streak or dull the door surface.



- The outside of the oven should be cleaned with a damp cloth. To prevent damage to the operating parts inside the oven, water should not be allowed to seep into the ventilation openings.
- Wipe the door and window on both sides, the door seals and adjacent parts frequently with a damp cloth to remove any spills or splatters. Do not use abrasive cleaner.
- Do not allow the control panel to become wet. Clean with a soft, damp cloth. When cleaning the control panel, leave oven door open to prevent oven from accidentally turning on.

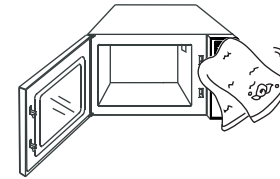

- If steam accumulates inside or around the outside of the oven door, wipe with a soft cloth. This may occur when the microwave oven is operated under high humidity conditions. It is normal.
- It is occasionally necessary to remove the glass turntable, baking and roasting pan, air fry kit for cleaning. Wash them in warm sudsy water.

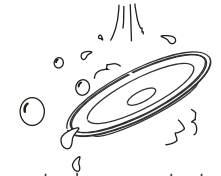

- If the light bulb burns out, please contact customer service to have it replaced.
- The oven should be cleaned regularly and any food deposits should be removed. Failure to maintain the oven in a clean condition could lead to deterioration of surface that could adversely affect the life of the unit and could possibly result in a hazardous situation.
- Please do not dispose of this appliance into normal trash bins; It should be disposed through local municipalities disposal center.

PRODUCT WARRANTY

This warranty applies to products sold by Galanz Americas in the U.S. This warranty is in lieu of any other warranty and expressly applies to the individual product only.

Galanz product is warranted for one year following purchase for defects in material and workmanship. **Please save your receipt as proof of purchase is required to make a warranty claim.** During this period, we will provide the replacement cost of this product, a replacement or the equivalent, or repair per our discretion.

The warranty can not be transferred through resale, including the resale through a 3rd party unauthorized retailer and is only bestowed up on the original consumer purchaser upon purchase from an authorized retailer.

■ **This warranty does not cover and excludes damage or defects caused by:**

- Consumer misuse
- Abuse
- Neglect including the failure to clean and/or provide adequate regular maintenance as outlined in the user manual
- Commercial use
- Subjecting the product to any voltage outside the specified range
- Loss of parts
- The affixing of any attachments not provided with the product
- Accident
- Use in a manner not intended and outlined in the user manual.

■ Any subsequent damages caused by the above listed exclusions will not be covered and any claims determined to meet the above exclusions will be denied. All liability is limited to the purchase price and does not include any:

- Retail offered extended warranties
- Tax
- Other charges(including postage to send required materials)
- Incidental and/or consequential damages associated with the product in question.

Every implied warranty, including any statutory warranty of merchantability or fitness for a particular purpose is disclaimed except to the extent prohibited by law, in which case such warranty is limited to the duration of this written warranty. This warranty gives you specific legal rights. You may have other legal rights that vary depending on where you live. Some states do not allow limitations on implied warranties or special, incidental, or consequential damaged, so the above limitations may not apply to you.

If you have a claim under this warranty, please call our Customer Service number: 1-800-562-0738.

For faster service, please have the model number, serial number, and receipt ready for the operator to assist you.

WARRANTY REGISTRATION

WARRANTY REGISTRATION

Please mail this warranty card to the address below within 30 days of purchase.
Galanz Americas, 55 Challenger Road, Suite 503, Ridgefield Park, NJ 07660.

PLEASE PRINT CLEARLY.

Name _____

Address _____

City _____ State _____ ZIP _____

Phone _____ Email _____

Model Number _____ Serial Number _____

Purchase Location _____

You must attach a copy of your purchase receipt to validate your registration.

