



---

# FCC Test Report

---

Report No.: AGC00053140701FE08

**FCC ID** : UHB-SX987  
**APPLICATION PURPOSE** : Original Equipment  
**PRODUCT DESIGNATION** : Bluetooth Headset  
**BRAND NAME** : SUICEN  
**MODEL NAME** : SX-987, SX-987X, MI-BTH22-XXX, AV-BTH22-XXX  
**CLIENT** : Shenzhen Shuaixian(Suicen)Electronic Equipment Co., Ltd.  
**DATE OF ISSUE** : Jul.11, 2014  
**STANDARD(S)** : FCC Part 15 Rules  
**REPORT VERSION** : V1.0

Attestation of Global Compliance (Shenzhen) Co., Ltd



**CAUTION:**

This report shall not be reproduced except in full without the written permission of the test laboratory and shall not be quoted out of context.

### Report Revise Record

Report Version	Revise Time	Issued Date	Valid Version	Notes
V1.0	/	Jul.11, 2014	Valid	Original Report

## TABLE OF CONTENTS

<b>1. VERIFICATION OF COMPLIANCE</b> .....	<b>5</b>
<b>2. GENERAL INFORMATION</b> .....	<b>6</b>
2.1 PRODUCT DESCRIPTION .....	6
2.2 RELATED SUBMITTAL(S)/GRANT(S).....	6
2.3 TEST METHODOLOGY .....	6
2.4 TEST FACILITY.....	6
2.5 SPECIAL ACCESSORIES.....	6
2.6 EQUIPMENT MODIFICATIONS.....	7
2.7 MEASUREMENT UNCERTAINTY .....	7
<b>3. SYSTEM TEST CONFIGURATION</b> .....	<b>8</b>
3.1 CONFIGURATION OF TESTED SYSTEM .....	8
3.2 EQUIPMENT USED IN TESTED SYSTEM .....	8
3.3. SUMMARY OF TEST RESULTS.....	8
<b>4. DESCRIPTION OF TEST MODES</b> .....	<b>9</b>
<b>5. ANTENNA REQUIREMENT</b> .....	<b>9</b>
5.1. STANDARD APPLICABLE .....	9
5.2. TEST RESULT .....	9
<b>6. TEST FACILITY</b> .....	<b>10</b>
<b>7. RADIATED EMISSION</b> .....	<b>11</b>
7.1 MEASUREMENT PROCEDURE.....	11
7.2 TEST SETUP.....	12
7.3 LIMITS AND MEASUREMENT RESULT .....	13
7.4 TEST RESULT (WORST MODULATION: GFSK) .....	13
<b>8. BAND EDGE EMISSION</b> .....	<b>26</b>
8.1. MEASUREMENT PROCEDURE.....	26
8.2. TEST SET-UP .....	26
8.3. TEST RESULT .....	27
<b>9. 6DB BANDWIDTH</b> .....	<b>31</b>
9.1. TEST PROCEDURE.....	31
9.2. SUMMARY OF TEST RESULTS/PLOTS .....	31
<b>10. CONDUCTED OUTPUT POWER</b> .....	<b>33</b>
10.1. MEASUREMENT PROCEDURE.....	33
10.2. TEST SET-UP (BLOCK DIAGRAM OF CONFIGURATION).....	33
10.3. LIMITS AND MEASUREMENT RESULT.....	34
<b>11. MAXIMUM CONDUCTED OUTPUT POWER SPECTRAL DENSITY</b> .....	<b>36</b>
11.1 MEASUREMENT PROCEDURE.....	36

11.2 TEST SET-UP (BLOCK DIAGRAM OF CONFIGURATION).....	36
11.3 LIMITS AND MEASUREMENT RESULT .....	36
<b>12. FCC LINE CONDUCTED EMISSION TEST .....</b>	<b>39</b>
12.1 LIMITS .....	39
12.2 TEST SETUP.....	39
12.3 PRELIMINARY PROCEDURE .....	40
12.4 FINAL TEST PROCEDURE.....	40
12.5 TEST RESULT OF POWER LINE .....	41
<b>APPENDIX A: PHOTOGRAPHS OF TEST SETUP .....</b>	<b>43</b>
<b>APPENDIX B: PHOTOGRAPHS OF EUT .....</b>	<b>45</b>

**1. VERIFICATION OF COMPLIANCE**

<b>Applicant</b>	Shenzhen Shuaixian(Suicen)Electronic Equipment Co., Ltd.
<b>Address</b>	NO.10,Lane 3,Longxing Road, Dakang Long Village, Henggang Town, Shenzhen
<b>Manufacturer</b>	Shenzhen Shuaixian(Suicen)Electronic Equipment Co., Ltd
<b>Address</b>	NO.10,Lane 3,Longxing Road, Dakang Long Village,Henggang Town, Shenzhen
<b>Product Designation</b>	Bluetooth Headset
<b>Brand Name</b>	SUICEN
<b>Test Model</b>	SX-987
<b>Series Model</b>	SX-987X, MI-BTH22-XXX, AV-BTH22-XXX
<b>Different Description</b>	All the same except for the model name.
<b>Date of test</b>	Jul.08, 2014 to Jul.10, 2014
<b>Deviation</b>	None
<b>Condition of Test Sample</b>	Normal
<b>Report Template</b>	AGCRT-US-BLE/RF (2013-03-01)

**WE HEREBY CERTIFY THAT:**

The above equipment was tested by Attestation of Global Compliance (Shenzhen) Co., Ltd. The test data, data evaluation, test procedures, and equipment configurations shown in this report were made in accordance with the procedures given in ANSI C63.4 (2003) and the energy emitted by the sample EUT tested as described in this report is in compliance with requirement of FCC Part 15 Rules requirement.

Prepared By



Water Zuo

Jul.11, 2014

Checked By



Forrest Lei

Jul.11, 2014

Authorized By



Solger Zhang

Jul.11, 2014

## 2.GENERAL INFORMATION

### 2.1PRODUCT DESCRIPTION

The EUT is designed as a “Bluetooth Headset”. It is designed by way of utilizing the FHSS technology to achieve the system operation.

A major technical description of EUT is described as following

<b>Operation Frequency</b>	2.402 GHz to 2.480GHz
<b>Bluetooth Version</b>	V4.0
<b>Modulation</b>	GFSK
<b>Number of channels</b>	40 Channel(37 Hopping Channel,3 advertising Channel)
<b>Antenna Designation</b>	PCB Antenna
<b>Antenna Gain</b>	0dBi
<b>Hardware Version</b>	1.0
<b>Software Version</b>	4.0
<b>Power Supply</b>	DC3.7V by Built-in Li-ion Battery

Note: The USB Port can not be used for communication with PC. It's only for charging.

### 2.2 RELATED SUBMITTAL(S)/GRANT(S)

This submittal(s) (test report) is intended for **FCC ID: UHB-SX987** filing to comply with Section 15.247of the FCC Part 15, Subpart C Rules.

### 2.3TEST METHODOLOGY

All measurements contained in this report were conducted with ANSI C63.4-2003, American National Standard for Methods of Measurement of Radio-Noise Emissions from Low-Voltage Electrical and Electronic Equipment in the range of 9 kHz to 40 GHz.

The test has been referenced the KDB 558074 D01 DTS Meas Guidance v03r02

The equipment under test (EUT) was configured to measure its highest possible emission level. The test modes were adapted accordingly in reference to the Operating Instructions. The EUT was tested in all three orthogonal planes and the worse case was showed.

### 2.4 TEST FACILITY

All measurement facilities used to collect the measurement data are located at Attestation of Global Compliance (Shenzhen) Co, Ltd

2/F., Building 2, No.1-No.4, Chaxi Sanwei Technical Industrial Park, Gushu, Xixiang, Bao'an District, Shenzhen, Guangdong, China.

FCC register No.: 259865

### 2.5 SPECIAL ACCESSORIES

Refer to section 2.2.

## **2.6 EQUIPMENT MODIFICATIONS**

Not available for this EUT intended for grant.

## **2.7 MEASUREMENT UNCERTAINTY**

Radiation Emission: +/-3.2

Conduction Emission: +/-2.5

### 3. SYSTEM TEST CONFIGURATION

#### 3.1 CONFIGURATION OF TESTED SYSTEM

**Configuration:** Normal Operating

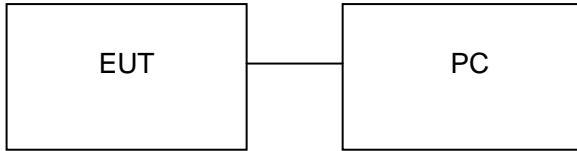

**Configuration:** Continuous TX

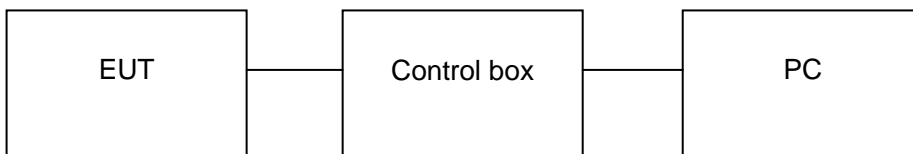

#### 3.2 EQUIPMENT USED IN TESTED SYSTEM

Item	Equipment	Mfr/Brand	Model/Type No.	Remark
1	Bluetooth Headset	SUICEN	SX-987	EUT
2	PC	Dell	INSPIRON	A.E
3	Control box	N/A	N/A	A.E

#### 3.3. SUMMARY OF TEST RESULTS

FCC RULES	DESCRIPTION OF TEST	RESULT
§ 15.203	Antenna Requirement	Compliant
§15.209 §15.247(d)	Radiated Emission	Compliant
§15.247(d)	Band Edges	Compliant
§15.247	6 dB Bandwidth	Compliant
§15.247(b)	Conducted Power	Compliant
§15.247(e)	Maximum Conducted Output Power SPECTRAL Density	Compliant
§15.207	Line Conduction Emission	Compliant



## 4. DESCRIPTION OF TEST MODES

The EUT has been operated in one modulation: GFSK .

NO.	TEST MODE DESCRIPTION
1	Low channel TX
2	Middle channel TX
3	High channel TX
4	Normal Operating (BT)

Note:

1. All the test modes can be supply by Built-in Li-ion battery, only the result of the worst case was recorded in the report if no any records.
2. For Radiated Emission, 3axis were chosen for testing for each applicable mode.
3. Transmitting duty cycle >98%

## 5. ANTENNA REQUIREMENT

### 5.1. STANDARD APPLICABLE

According to FCC 15.203, An intentional radiator shall be designed to ensure that no antenna other than that furnished by the responsible party shall be used with the device. The use of a permanently attached antenna or of an antenna that uses a unique coupling to the intentional radiator shall be considered sufficient to comply with the provisions of this Section. The manufacturer may design the unit so that a broken antenna can be replaced by the user, but the use of a standard antenna jack or electrical connector is prohibited. This requirement does not apply to carrier current devices or to devices operated under the provisions of Sections 15.211, 15.213, 15.217, 15.219, or 15.221. Further, this requirement does not apply to intentional radiators that must be professionally installed, such as perimeter protection systems and some field disturbance sensors, or to other intentional radiators which, in accordance with Section 15.31(d), must be measured at the installation site. However, the installer shall be responsible for ensuring that the proper antenna is employed so that the limits in this Part are not exceeded.

### 5.2. TEST RESULT

This product has a permanent antenna, fulfill the requirement of this section.

## 6. TEST FACILITY

<b>Site</b>	Attestation of Global Compliance (Shenzhen) Co., Ltd
<b>Location</b>	2/F., Building 2, No.1-No.4, Chaxi Sanwei Technical Industrial Park, Gushu, Xixiang, Bao'an District, Shenzhen, Guangdong, China
<b>Description</b>	The test site is constructed and calibrated to meet the FCC requirements in documents ANSI C63.4:2003.

### ALL TEST EQUIPMENT LIST

Description	Manufacturer	Model	S/N	Cal. Date	Cal. Due
Power Probe	R&S	NRP-Z23	100323	07/17/2013	07/16/2014
RF attenuator	N/A	RFA20db	68	N/A	N/A
Spectrum Analyzer	Agilent	E4440A	US41421290	07/17/2013	07/16/2014
EXA Signal Analyzer	Agilent	N9010A	--	02/28/2014	02/27/2015
Amplifier	EM	EM30180	0607030	02/28/2014	02/27/2015
Horn Antenna	EM	EM-AH-10180	67	04/19/2014	04/18/2015
Horn Antenna	A.H. Systems Inc.	SAS-574	--	07/17/2013	07/16/2014
EMI Test Receiver	Rohde & Schwarz	ESCI	100694	07/17/2013	07/16/2014
Biological Antenna	A.H. Systems Inc.	SAS-521-4	26	06/06/2014	06/05/2015
LISN	R&S	ESH3-Z5	8389791009	07/17/2013	07/16/2014
Loop Antenna	Daze	ZN30900N	SEL0097	07/17/2013	07/16/2014
Isolation Transformer	LETEAC	LTBK	--	07/17/2013	07/16/2014
Radiation Cable 1	Sat	RE1	R003	06/04/2014	06/04/2015
Radiation Cable 2	Sat	RE2	R002	06/04/2014	06/04/2015
Conduction Cable	Sat	CE1	C001	06/04/2014	06/04/2015

## 7. RADIATED EMISSION

### 7.1 MEASUREMENT PROCEDURE

1. Configure the EUT according to ANSI C63.4. The EUT was placed on the top of the turntable 0.8 meter above ground. The phase center of the receiving antenna mounted on the top of a height-variable antenna tower was placed 3 meters far away from the turntable.
2. Power on the EUT and all the supporting units. The turntable was rotated by 360 degrees to determine the position of the highest radiation.
3. The height of the broadband receiving antenna was varied between one meter and four meters above ground to find the maximum emissions field strength of both horizontal and vertical polarization.
4. For each suspected emissions, the antenna tower was scan (from 1 M to 4 M) and then the turntable was rotated (from 0 degree to 360 degrees) to find the maximum reading.
5. Set the test-receiver system to Peak or CISPR quasi-peak Detect Function with specified bandwidth under Maximum Hold Mode.
6. For emissions above 1GHz, use 1MHz VBW and RBW for peak reading. Then 1MHz RBW and 10Hz VBW for average reading in spectrum analyzer.
7. When the radiated emissions limits are expressed in terms of the average value of the emissions, and pulsed operation is employed, the measurement field strength shall be determined by averaging over one complete pulse train, including blanking intervals, as long as the pulse train does not exceed 0.1 seconds. As an alternative (provided the transmitter operates for longer than 0.1 seconds) or in cases where the pulse train exceeds 0.1 seconds, the measured field strength shall be determined from the average absolute voltage during a 0.1 second interval during which the field strength is at its maximum values.
8. If the emissions level of the EUT in peak mode was 3 dB lower than the average limit specified, then testing will be stopped and peak values of EUT will be reported, otherwise, the emissions which do not have 3 dB margin will be repeated one by one using the quasi-peak method for below 1GHz.
9. For testing above 1GHz, the emissions level of the EUT in peak mode was lower than average limit (that means the emissions level in peak mode also complies with the limit in average mode), then testing will be stopped and peak values of EUT will be reported, otherwise, the emissions will be measured in average mode again and reported.
10. In case the emission is lower than 30MHz, loop antenna has to be used for measurement and the recorded data should be QP measured by receiver. High - Low scan is not required in this case.

## 7.2 TEST SETUP

### RADIATED EMISSION TEST SETUP 30MHz-1000MHz

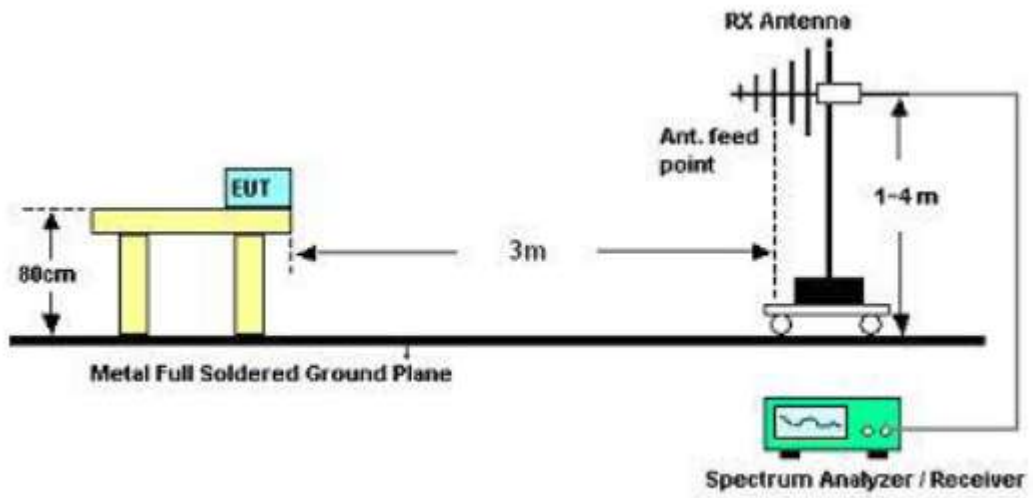

### RADIATED EMISSION TEST SETUP ABOVE 1000MHz

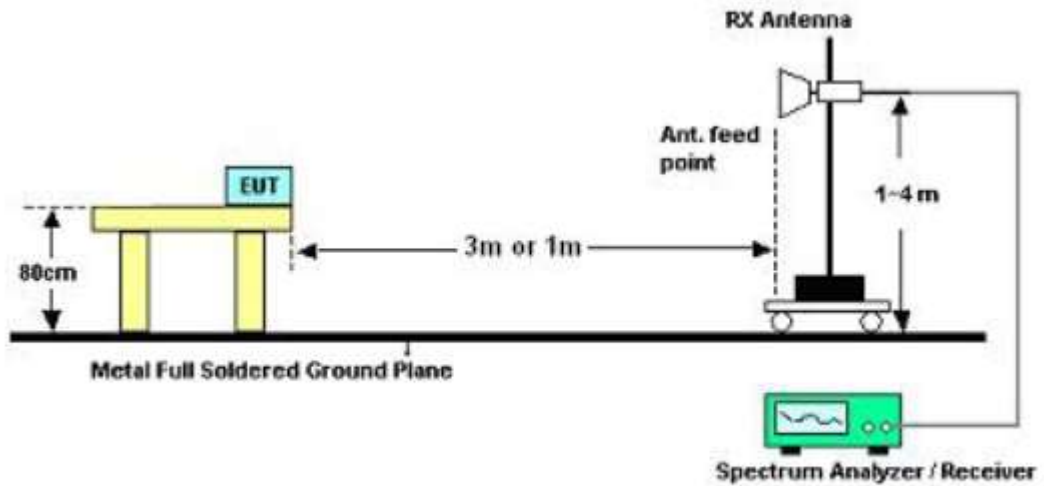

### 7.3 LIMITS AND MEASUREMENT RESULT

15.209 Limit in the below table has to be followed

<b>Frequencies (MHz)</b>	<b>Field Strength (micorvolts/meter)</b>	<b>Measurement Distance (meters)</b>
0.009~0.490	2400/F(KHz)	300
0.490~1.705	24000/F(KHz)	30
1.705~30.0	30	30
30~88	100	3
88~216	150	3
216~960	200	3
Above 960	500	3

Note: All modes were tested For restricted band radiated emission,  
the test records reported below are the worst result compared to other modes.

### 7.4 TEST RESULT (Worst Modulation: GFSK)

#### **RADIATED EMISSION BELOW 30MHZ**

No emission found between lowest internal used/generated frequencies to 30MHz.

**RADIATED EMISSION BELOW 1GHZ**

**RADIATED EMISSION TEST- (30MHZ-1GHZ)-LOW CHANNEL-HORIZONTAL**

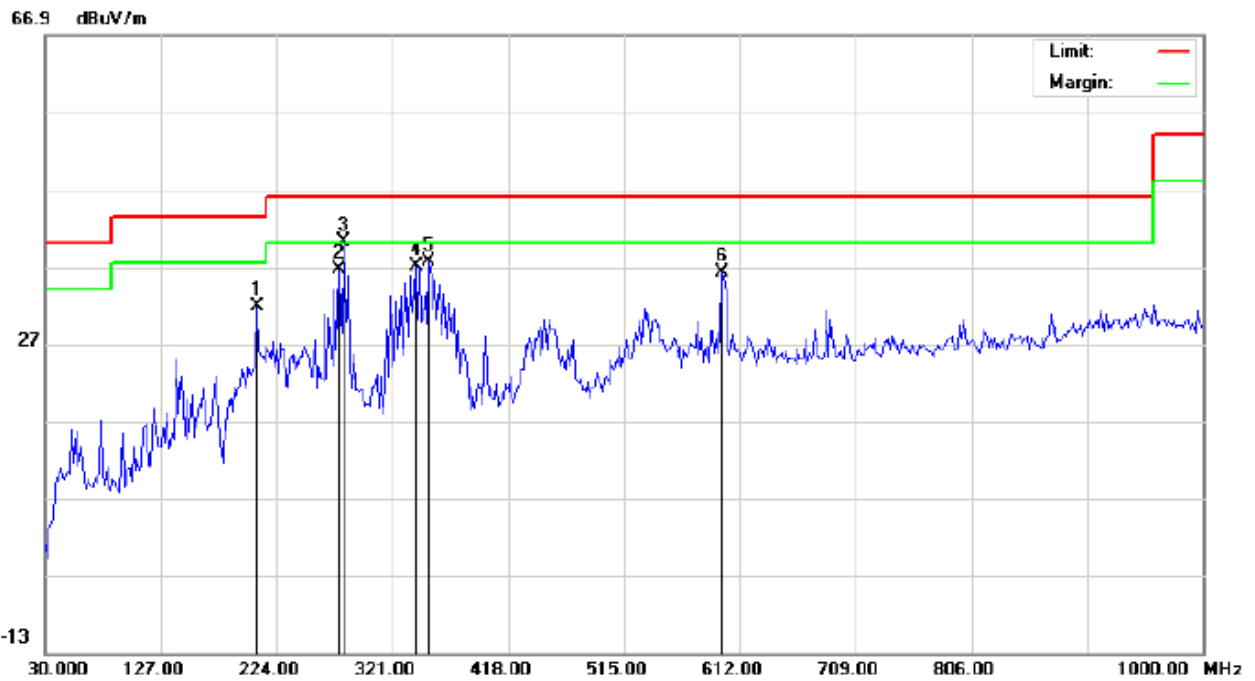

Site: site #1  
 Limit: FCC Class B 3M Radiation  
 EUT:Bluetooth Headset  
 M/N: SX-987  
 Mode: Low channel TX  
 Note:

Polarization: *Horizontal*  
 Power:  
 Distance: 3m

Temperature: 26  
 Humidity: 60 %

No.	Mk	Freq.	Reading	Factor	Measurement	Limit	Over	Detector	Antenna	Table	Comment
		MHz	dBuV	dB/m	dBuV/m	dBuV/m	dB		Height	Degree	
									cm	degree	
1		207.8333	19.48	12.30	31.78	43.50	-11.72	peak			
2		275.7333	21.83	14.68	36.51	46.00	-9.49	peak			
3	*	280.5833	25.37	14.82	40.19	46.00	-5.81	peak			
4		340.4000	18.82	18.10	36.92	46.00	-9.08	peak			
5		351.7167	18.77	18.75	37.52	46.00	-8.48	peak			
6		597.4500	12.52	23.67	36.19	46.00	-9.81	peak			

**RESULT: PASS**

RADIATED EMISSION TEST- (30MHZ-1GHZ)-LOW CHANNEL -VERTICAL

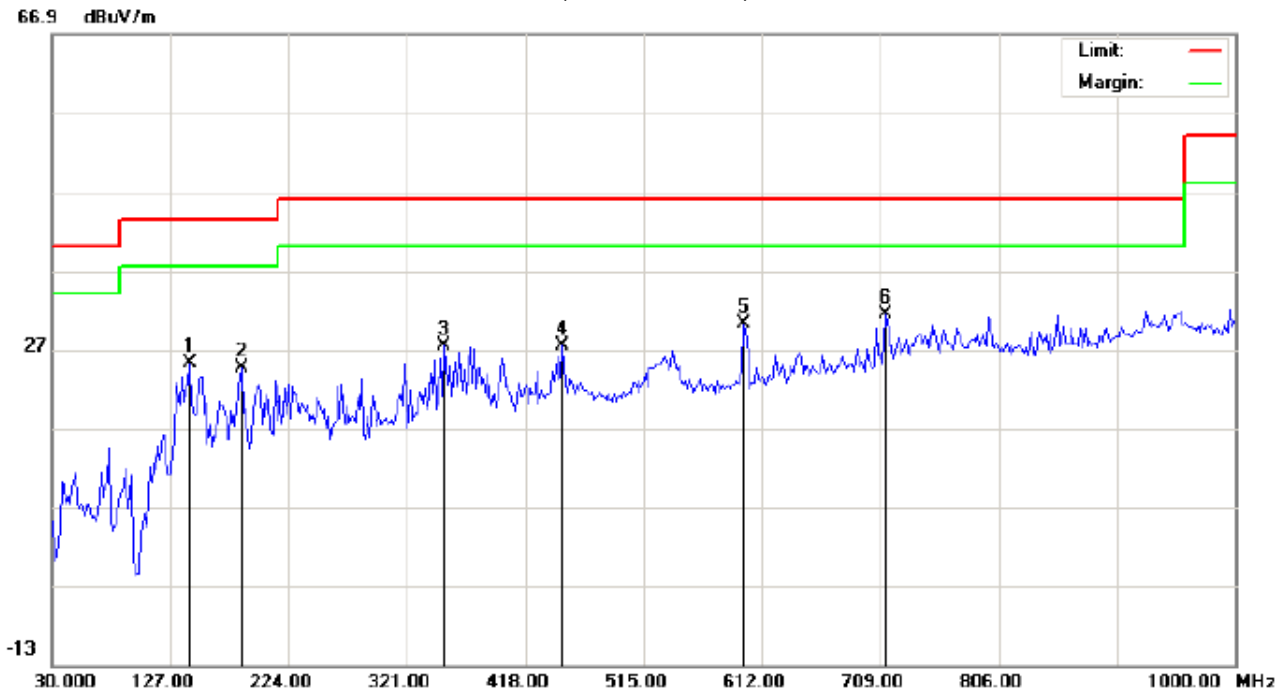

Site: site #1  
 Limit: FCC Class B 3M Radiation  
 EUT:Bluetooth Headset  
 M/N: SX-987  
 Mode: Low channel TX  
 Note:

Polarization: *Vertical*  
 Power:  
 Distance: 3m

Temperature: 26  
 Humidity: 60 %

No.	Mk	Freq.	Reading	Factor	Measurement	Limit	Over	Detector	Antenna Height	Table Degree	Comment
		MHz	dBuV	dB/m	dBuV/m	dBuV/m	dB		cm	degree	
1		143.1667	10.05	15.22	25.27	43.50	-18.23	peak			
2		185.2000	11.92	12.75	24.67	43.50	-18.83	peak			
3		351.7167	8.73	18.75	27.48	46.00	-18.52	peak			
4		448.7167	6.87	20.55	27.42	46.00	-18.58	peak			
5		597.4500	7.39	22.72	30.11	46.00	-15.89	peak			
6	*	713.8500	5.75	25.59	31.34	46.00	-14.66	peak			

**RESULT: PASS**

**Note:** 1. Factor=Antenna Factor + Cable loss, Margin=Measurement-Limit.

2. The "Factor" value can be calculated automatically by software of measurement system.

RADIATED EMISSION TEST- (30MHZ-1GHZ)-MIDDLE CHANNEL-HORIZONTAL

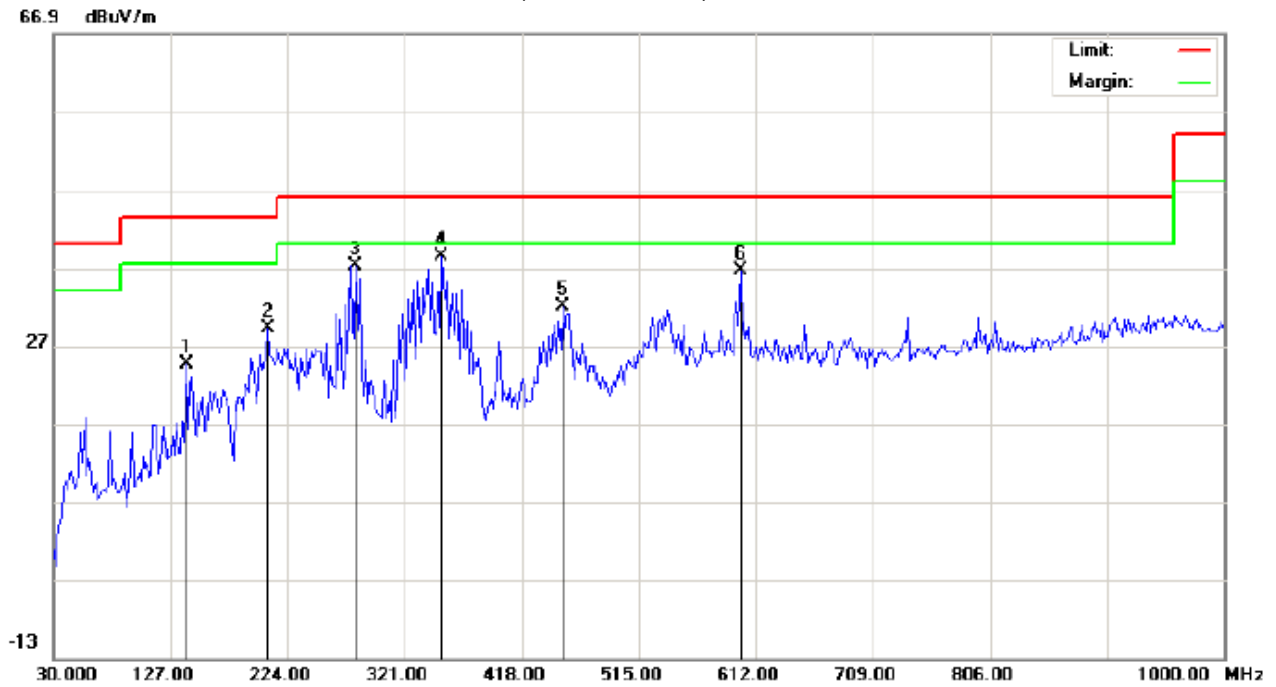

Site: site #1  
 Limit: FCC Class B 3M Radiation  
 EUT:Bluetooth Headset  
 M/N: SX-987  
 Mode: Middle channel TX  
 Note:

Polarization: *Horizontal*  
 Power:  
 Distance: 3m

Temperature: 26  
 Humidity: 60 %

No.	Mk	Freq.	Reading	Factor	Measurement	Limit	Over	Detector	Antenna	Table	Comment
		MHz	dBuV	dB/m	dBuV/m	dBuV/m	dB		Height	Degree	
1		139.9333	9.45	15.19	24.64	43.50	-18.86	peak	cm	degree	
2		207.8333	16.81	12.30	29.11	43.50	-14.39	peak			
3		280.5833	22.44	14.82	37.26	46.00	-8.74	peak			
4	*	351.7167	19.68	18.75	38.43	46.00	-7.57	peak			
5		451.9500	11.37	20.61	31.98	46.00	-14.02	peak			
6		599.0667	12.80	23.71	36.51	46.00	-9.49	peak			

**RESULT: PASS**



RADIATED EMISSION TEST- (30MHZ-1GHZ)- MIDDLE CHANNEL -VERTICAL

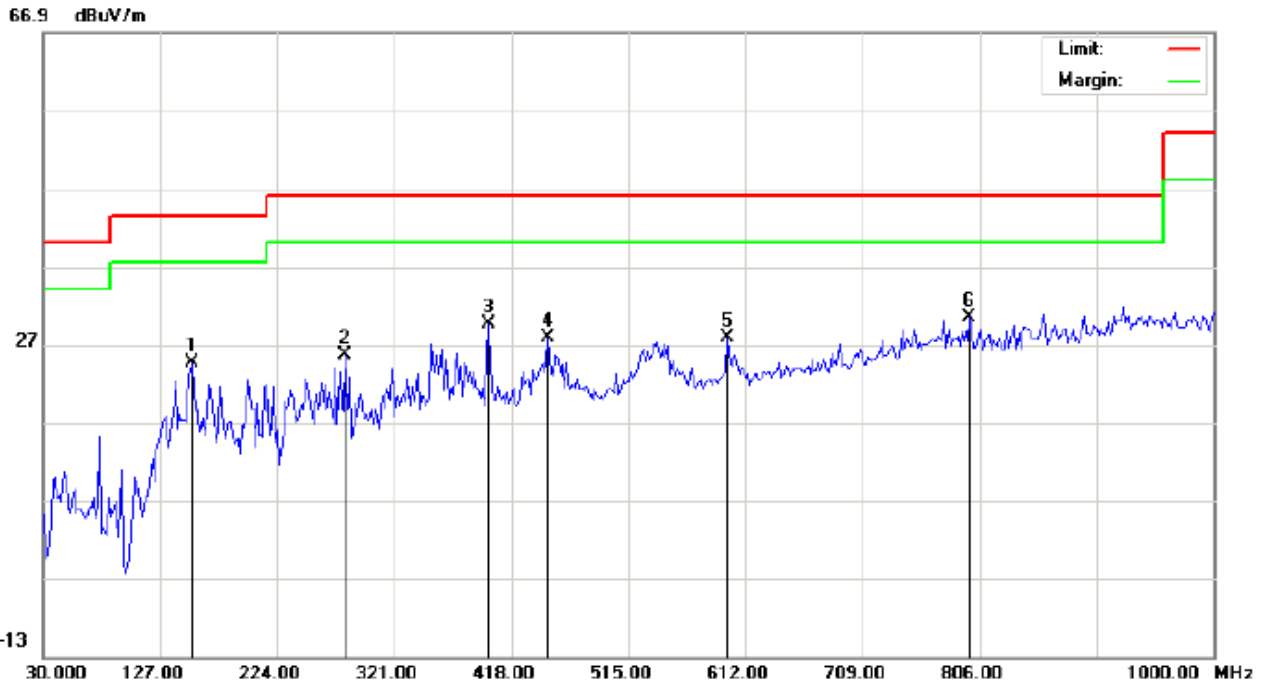

Site: site #1

Polarization: *Vertical*

Temperature: 26

Limit: FCC Class B 3M Radiation

Power:

Humidity: 60 %

EUT:Bluetooth Headset

Distance: 3m

M/N: SX-987

Mode: Middle channel TX

Note:

No.	Mk	Freq.	Reading	Factor	Measurement	Limit	Over	Detector	Antenna Height	Table Degree	Comment
		MHz	dBuV	dB/m	dBuV/m	dBuV/m	dB		cm	degree	
1		152.8667	9.24	15.28	24.52	43.50	-18.98	peak			
2		280.5833	10.87	14.82	25.69	46.00	-20.31	peak			
3		398.6000	10.56	19.06	29.62	46.00	-16.38	peak			
4		448.7167	7.23	20.55	27.78	46.00	-18.22	peak			
5		597.4500	5.16	22.72	27.88	46.00	-18.12	peak			
6	*	797.9167	3.06	27.29	30.35	46.00	-15.65	peak			

**RESULT: PASS**

**Note:** 1. Factor=Antenna Factor + Cable loss, Margin=Measurement-Limit.

2. The "Factor" value can be calculated automatically by software of measurement system.

RADIATED EMISSION TEST- (30MHZ-1GHZ)-HIGH CHANNEL-HORIZONTAL

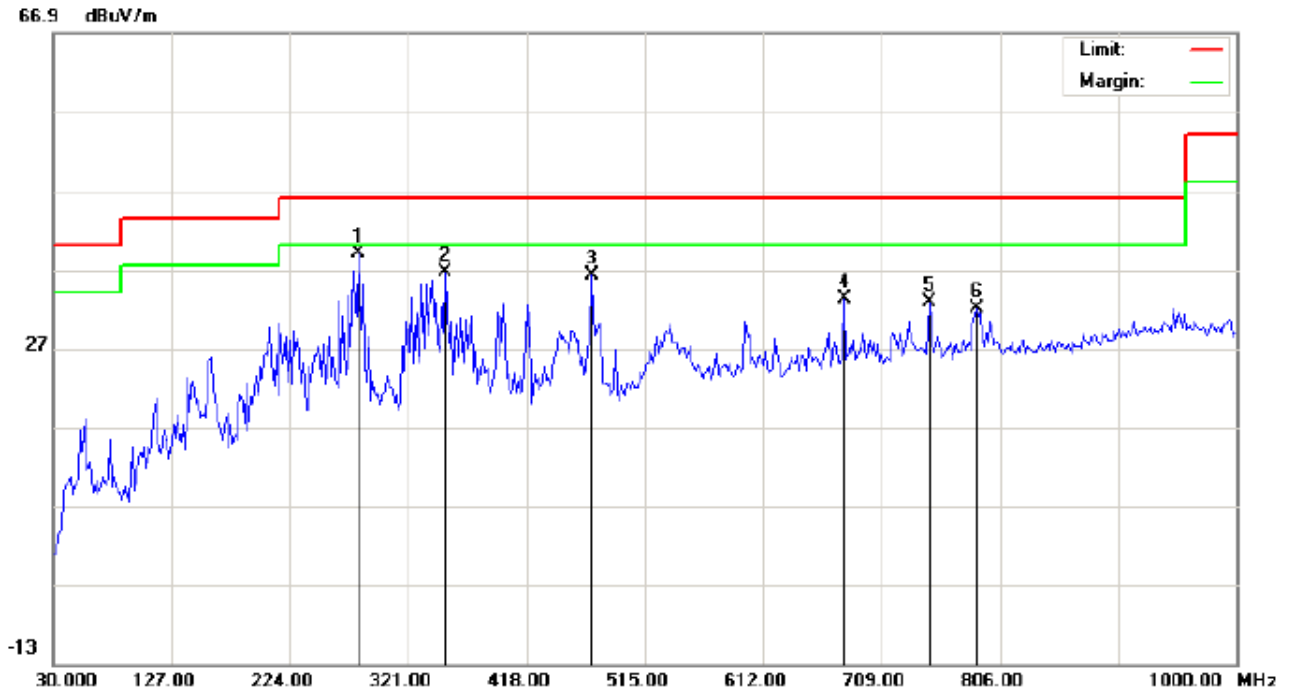

Site: site #1  
Limit: FCC Class B 3M Radiation  
EUT:Bluetooth Headset  
M/N: SX-987  
Mode: High channel TX  
Note:

Polarization: *Horizontal*  
Power:  
Distance: 3m

Temperature: 26  
Humidity: 60 %

No.	Mk	Freq.	Reading	Factor	Measurement	Limit	Over	Detector	Antenna Height	Table Degree	Comment
		MHz	dBuV	dB/m	dBuV/m	dBuV/m	dB		cm	degree	
1	*	280.5833	24.20	14.82	39.02	46.00	-6.98	peak			
2		351.7167	17.84	18.75	36.59	46.00	-9.41	peak			
3		471.3500	15.34	20.82	36.16	46.00	-9.84	peak			
4		678.2833	8.64	24.61	33.25	46.00	-12.75	peak			
5		747.8000	6.33	26.57	32.90	46.00	-13.10	peak			
6		786.6000	4.82	27.14	31.96	46.00	-14.04	peak			

**RESULT: PASS**

RADIATED EMISSION TEST- (30MHZ-1GHZ)-HIGH CHANNEL -VERTICAL

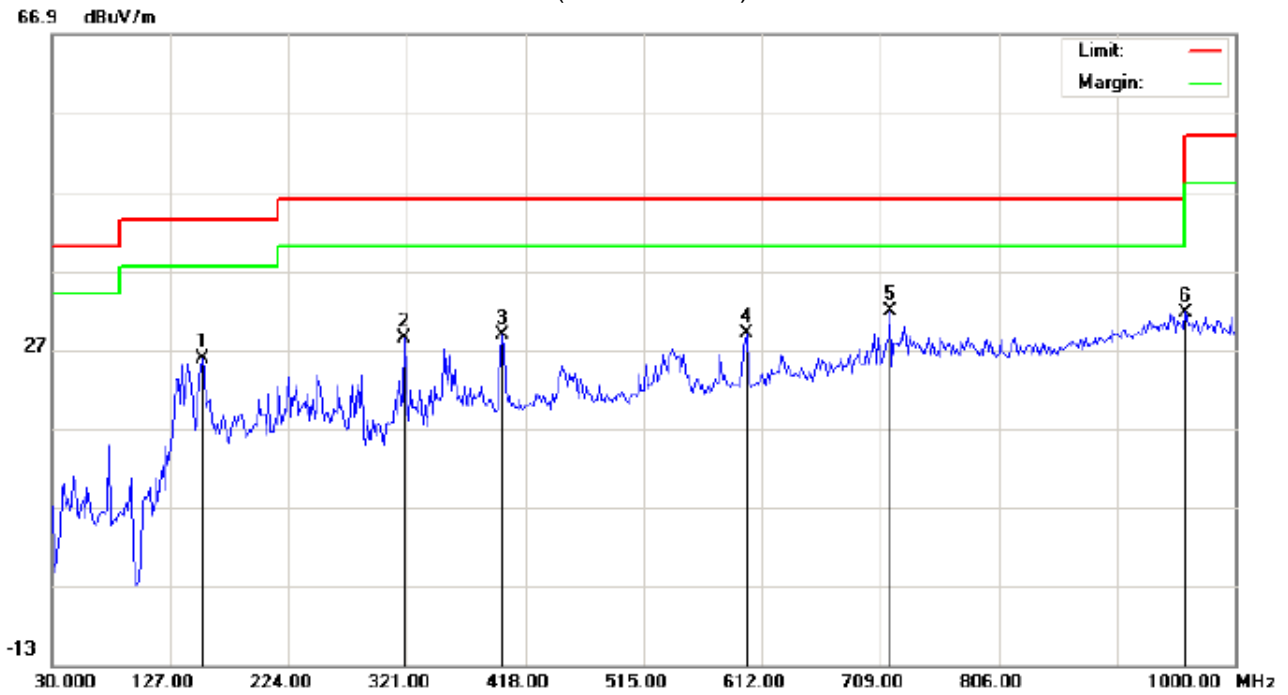

Site: site #1  
 Limit: FCC Class B 3M Radiation  
 EUT:Bluetooth Headset  
 M/N: SX-987  
 Mode: High channel TX  
 Note:

Polarization: *Vertical*  
 Power:  
 Distance: 3m

Temperature: 26  
 Humidity: 60 %

No.	Mk	Freq.	Reading	Factor	Measurement	Limit	Over	Detector	Antenna Height	Table Degree	Comment
		MHz	dBuV	dB/m	dBuV/m	dBuV/m	dB		cm	degree	
1		152.8667	10.58	15.28	25.86	43.50	-17.64	peak			
2		319.3833	11.72	16.70	28.42	46.00	-17.58	peak			
3		398.6000	9.66	19.06	28.72	46.00	-17.28	peak			
4		599.0667	6.28	22.73	29.01	46.00	-16.99	peak			
5	*	717.0833	6.22	25.68	31.90	46.00	-14.10	peak			
6		959.5833	1.79	29.91	31.70	46.00	-14.30	peak			

**RESULT: PASS**

**Note:** 1. Factor=Antenna Factor + Cable loss, Margin=Measurement-Limit.

2. The "Factor" value can be calculated automatically by software of measurement system.

**RADIATED EMISSION ABOVE 1GHZ**

**RADIATED EMISSION TEST- (ABOVE 1GHZ)-LOW CHANNEL-HORIZONTAL**

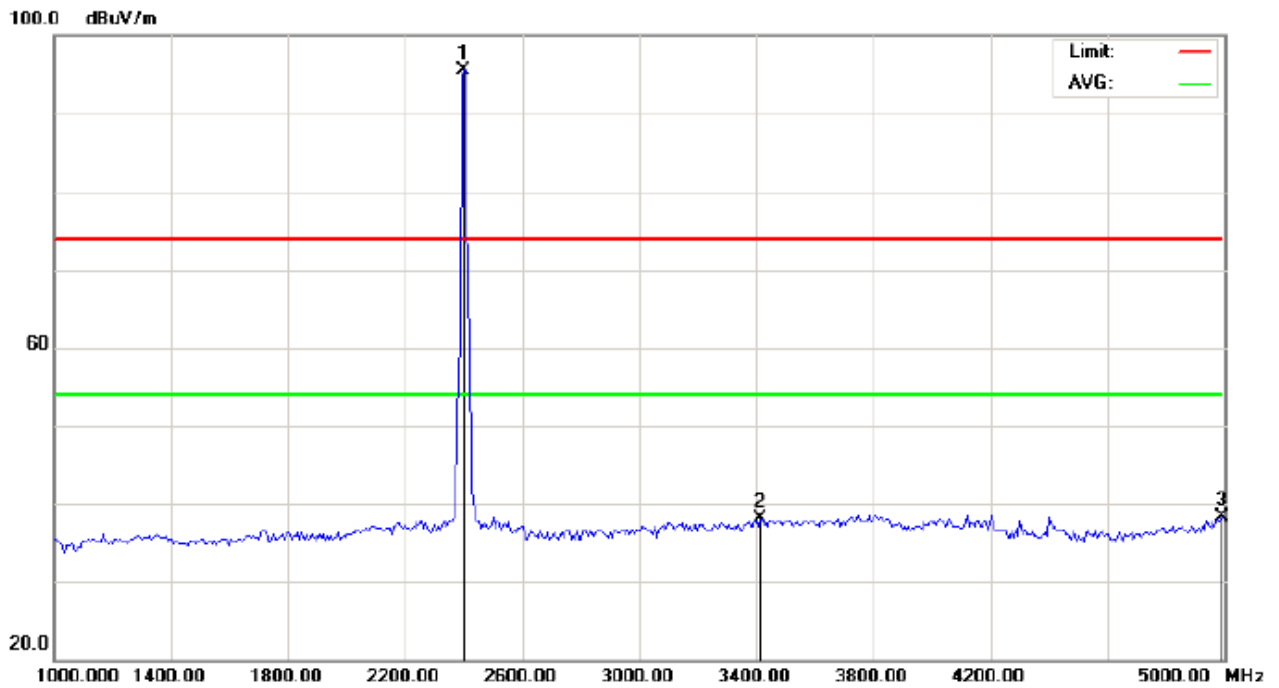

Site: site #1	Polarization: <i>Horizontal</i>	Temperature: 26
Limit: FCC Class B 3M Radiation above 1GHZ(PK)	Power:	Humidity: 60 %
EUT:Bluetooth Headset	Distance:	
M/N: SX-987		
Mode: Low channel TX		
Note:		

No.	Mk	Freq.	Reading	Factor	Measurement	Limit	Over	Detector	Antenna Height	Table Degree	Comment
		MHz	dBuV	dB/m	dBuV/m	dBuV/m	dB		cm	degree	
1	*	2402.000	105.11	-9.68	95.43	74.00	21.43	peak			
2		3413.333	46.00	-7.97	38.03	74.00	-35.97	peak			
3		4993.333	40.14	-1.82	38.32	74.00	-35.68	peak			

**RESULT: PASS**

RADIATED EMISSION TEST-(ABOVE 1GHZ)-LOW CHANNEL-VERTICAL

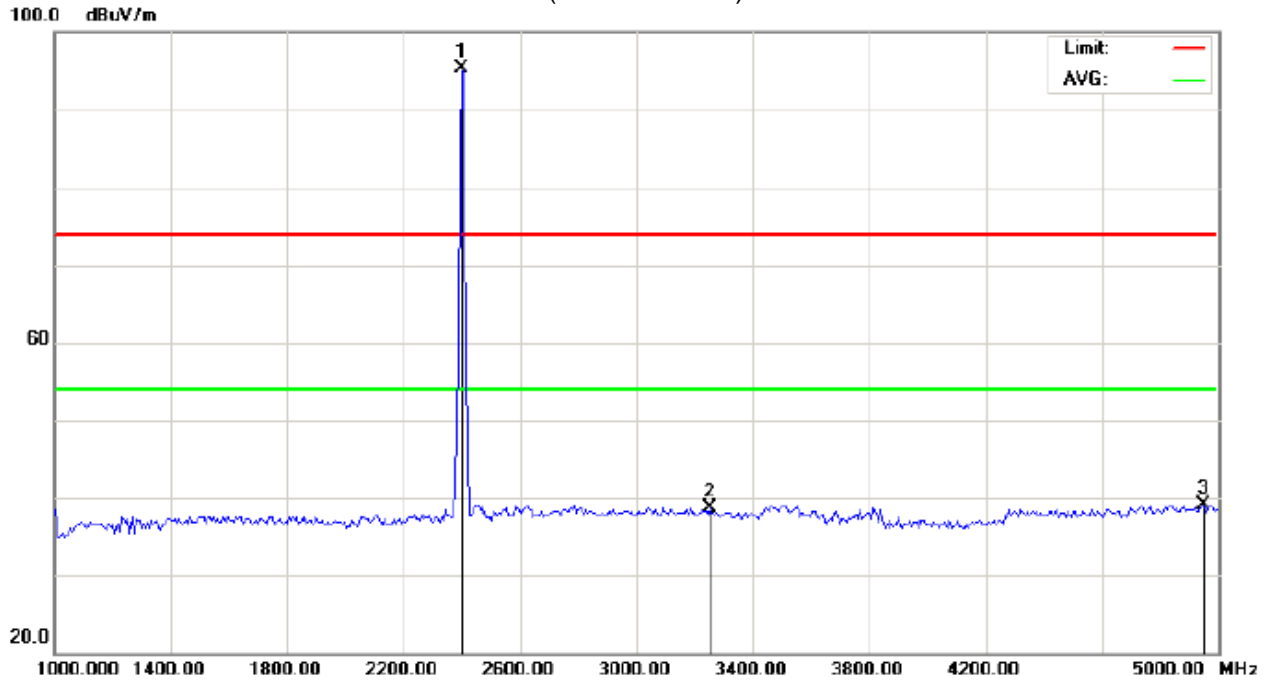

Site: site #1 Polarization: *Vertical* Temperature: 26  
 Limit: FCC Class B 3M Radiation above 1GHZ(PK) Power: Humidity: 60 %  
 EUT:Bluetooth Headset Distance:  
 M/N: SX-987  
 Mode: Low channel TX  
 Note:

No.	Mk	Freq.	Reading	Factor	Measurement	Limit	Over	Detector	Antenna Height	Table Degree	Comment
		MHz	dBuV	dB/m	dBuV/m	dBuV/m	dB		cm	degree	
1	*	2402.000	104.95	-9.68	95.27	74.00	21.27	peak			
2		3253.333	46.76	-8.12	38.64	74.00	-35.36	peak			
3		4946.667	41.03	-1.94	39.09	74.00	-34.91	peak			

**RESULT: PASS**

**Note:** 1. Factor=Antenna Factor + Cable loss, Margin=Measurement-Limit.

2. The "Factor" value can be calculated automatically by software of measurement system.

RADIATED EMISSION TEST-(ABOVE 1GHZ)-MIDDLE CHANNEL-HORIZONTAL

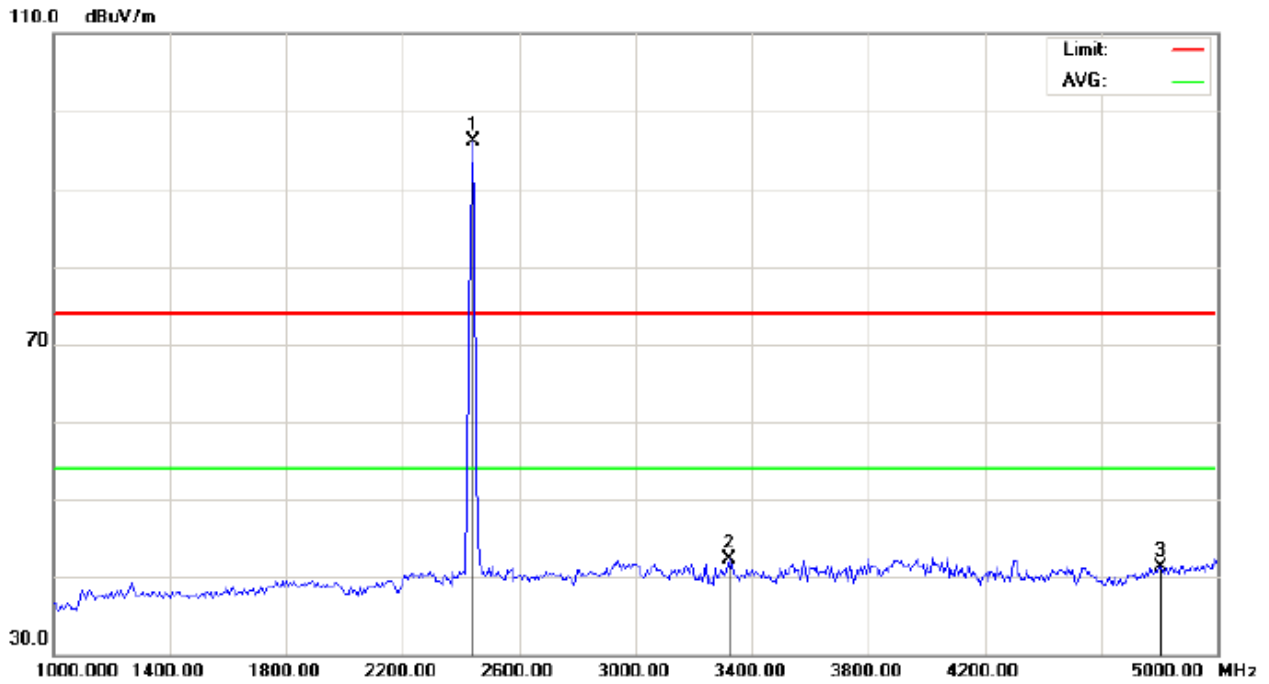

Site: site #1 Polarization: *Horizontal* Temperature: 26  
Limit: FCC Class B 3M Radiation above 1GHZ(PK) Power: Humidity: 60 %  
EUT:Bluetooth Headset Distance:  
M/N: SX-987  
Mode: Middle channel TX  
Note:

No.	Mk	Freq.	Reading	Factor	Measurement	Limit	Over	Detector	Antenna Height	Table Degree	Comment
		MHz	dBuV	dB/m	dBuV/m	dBuV/m	dB		cm	degree	
1	*	2440.000	105.76	-9.64	96.12	74.00	22.12	peak			
2		3320.000	50.45	-8.06	42.39	74.00	-31.61	peak			
3		4806.667	43.69	-2.31	41.38	74.00	-32.62	peak			

**RESULT: PASS**

RADIATED EMISSION TEST-(ABOVE 1GHZ)-MIDDLE CHANNEL-VERTICAL

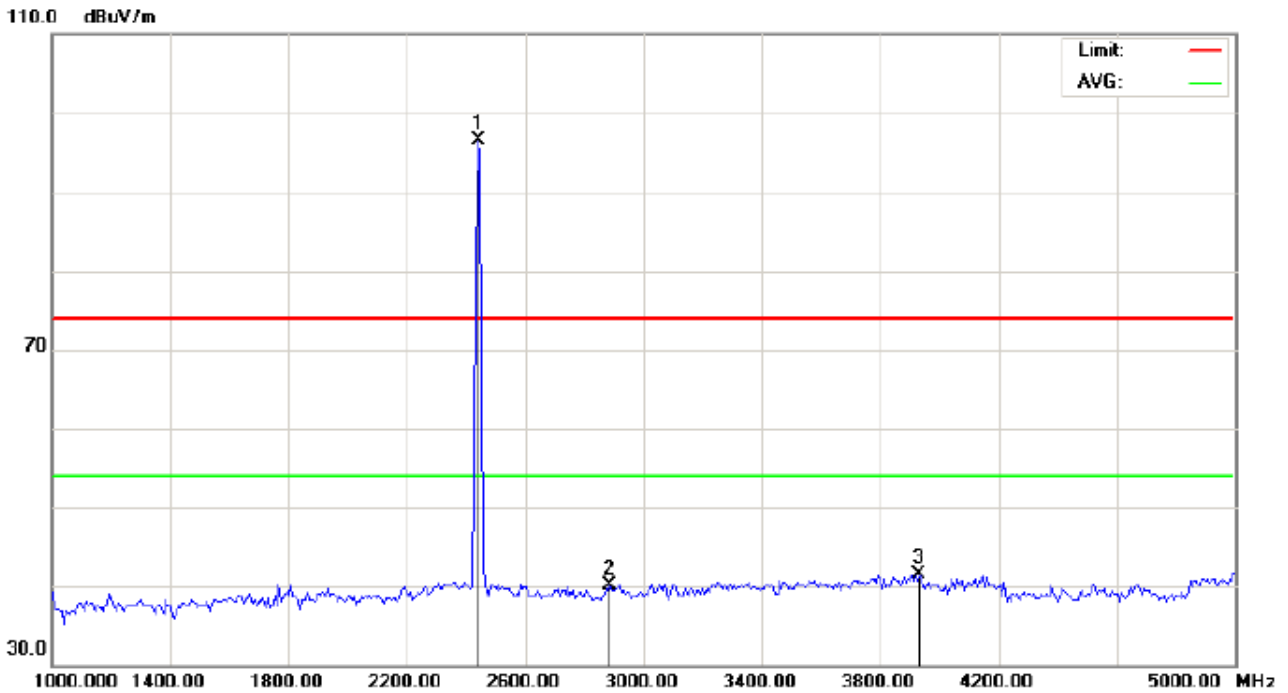

Site: site #1 Polarization: *Vertical* Temperature: 26  
 Limit: FCC Class B 3M Radiation above 1GHZ(PK) Power: Humidity: 60 %  
 EUT:Bluetooth Headset Distance:  
 M/N: SX-987  
 Mode: Middle channel TX  
 Note:

No.	Mk	Freq.	Reading	Factor	Measurement	Limit	Over	Detector	Antenna Height	Table Degree	Comment
		MHz	dBuV	dB/m	dBuV/m	dBuV/m	dB		cm	degree	
1	*	2440.000	106.17	-9.64	96.53	74.00	22.53	peak			
2		2886.667	48.75	-8.63	40.12	74.00	-33.88	peak			
3		3933.333	46.63	-5.22	41.41	74.00	-32.59	peak			

**RESULT: PASS**

- Note:** 1. Factor=Antenna Factor + Cable loss, Margin=Measurement-Limit.  
 2. The "Factor" value can be calculated automatically by software of measurement system.

RADIATED EMISSION TEST-(ABOVE 1GHZ)-HIGH CHANNEL-HORIZONTAL

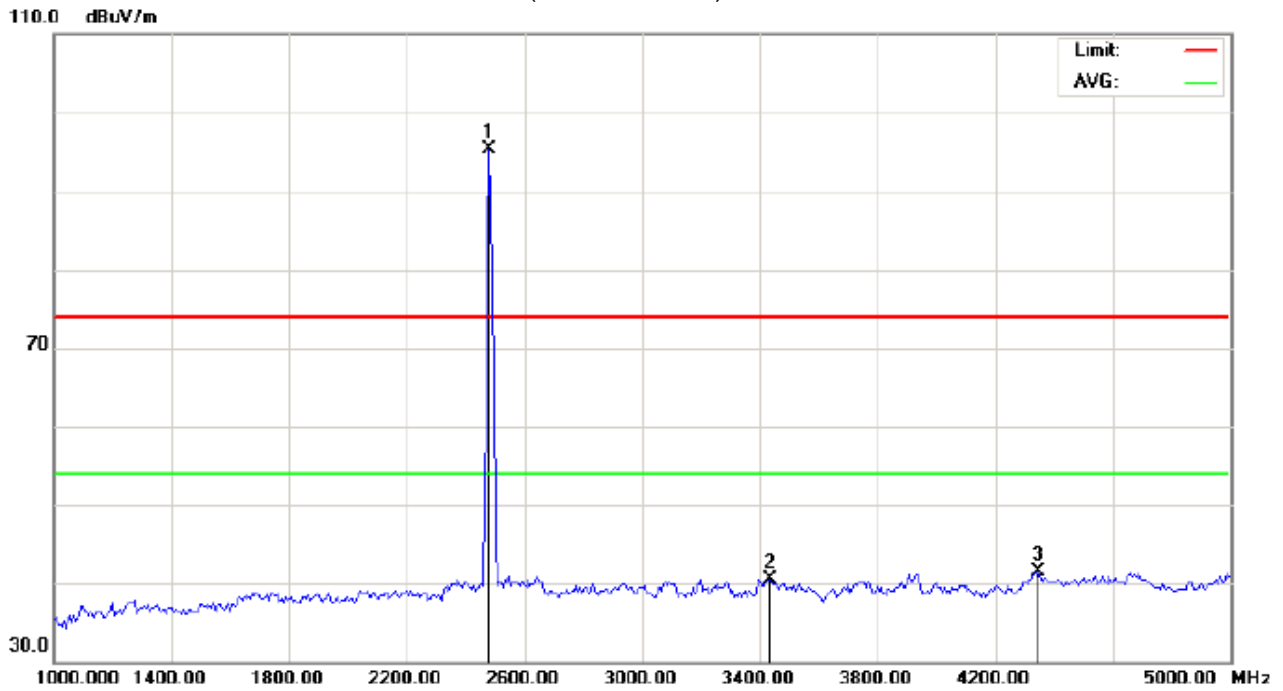

Site: site #1 Polarization: *Horizontal* Temperature: 26  
 Limit: FCC Class B 3M Radiation above 1GHZ(PK) Power: Humidity: 60 %  
 EUT:Bluetooth Headset Distance:  
 M/N: SX-987  
 Mode: High channel TX  
 Note:

No.	Mk	Freq.	Reading	Factor	Measurement	Limit	Over	Detector	Antenna Height	Table Degree	Comment
		MHz	dBuV	dB/m	dBuV/m	dBuV/m	dB		cm	degree	
1	*	2480.000	104.96	-9.59	95.37	74.00	21.37	peak			
2		3433.333	48.51	-7.95	40.56	74.00	-33.44	peak			
3		4346.667	45.18	-3.63	41.55	74.00	-32.45	peak			

**RESULT: PASS**



RADIATED EMISSION TEST-(ABOVE 1GHZ)-HIGH CHANNEL-VERTICAL

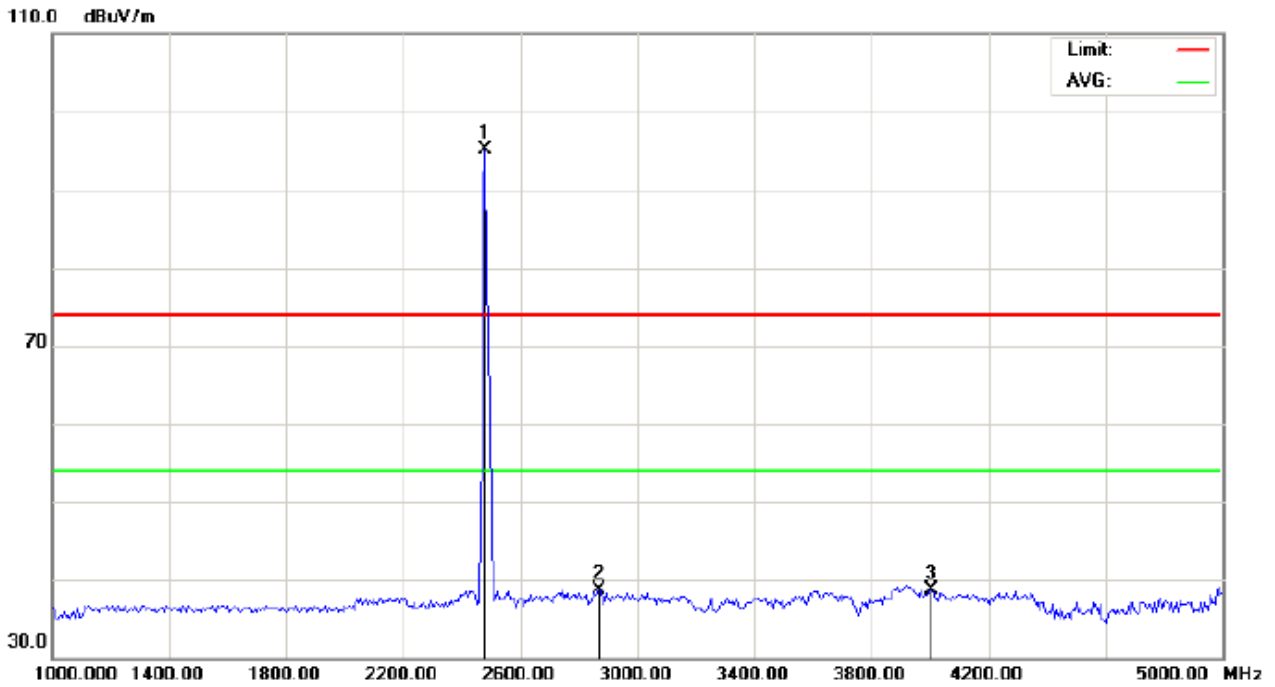

Site: site #1 Polarization: *Vertical* Temperature: 26  
Limit: FCC Class B 3M Radiation above 1GHZ(PK) Power: Humidity: 60 %  
EUT:Bluetooth Headset Distance:  
M/N: SX-987  
Mode: High channel TX  
Note:

No.	Mk	Freq.	Reading	Factor	Measurement	Limit	Over	Detector	Antenna Height	Table Degree	Comment
		MHz	dBuV	dB/m	dBuV/m	dBuV/m	dB		cm	degree	
1	*	2480.000	104.77	-9.59	95.18	74.00	21.18	peak			
2		2866.667	47.37	-8.68	38.69	74.00	-35.31	peak			
3		4006.667	43.55	-4.79	38.76	74.00	-35.24	peak			

**RESULT: PASS**

**Note:** 5~25GHz at least have 20dB margin. No recording in the test report.

Factor=Antenna Factor+ Cable loss-Amplifier gain,

Margin=Measurement-Limit.

The "Factor" value can be calculated automatically by software of measurement system.

## **8. BAND EDGE EMISSION**

### **8.1. MEASUREMENT PROCEDURE**

1. Set the EUT Work on the top, the bottom operation frequency individually.
2. Set SPA Start or Stop Frequency=Operation Frequency ,  $RBW \geq 100\text{KHz}$ ,  $VBW \geq RBW$ ,  
Center frequency =Operation frequency
3. The band edges was measured and recorded.

### **8.2. TEST SET-UP**

Radiated same as 7.2

8.3. TEST RESULT

TEST PLOT OF BAND EDGE FOR LOW CHANNEL -Horizontal

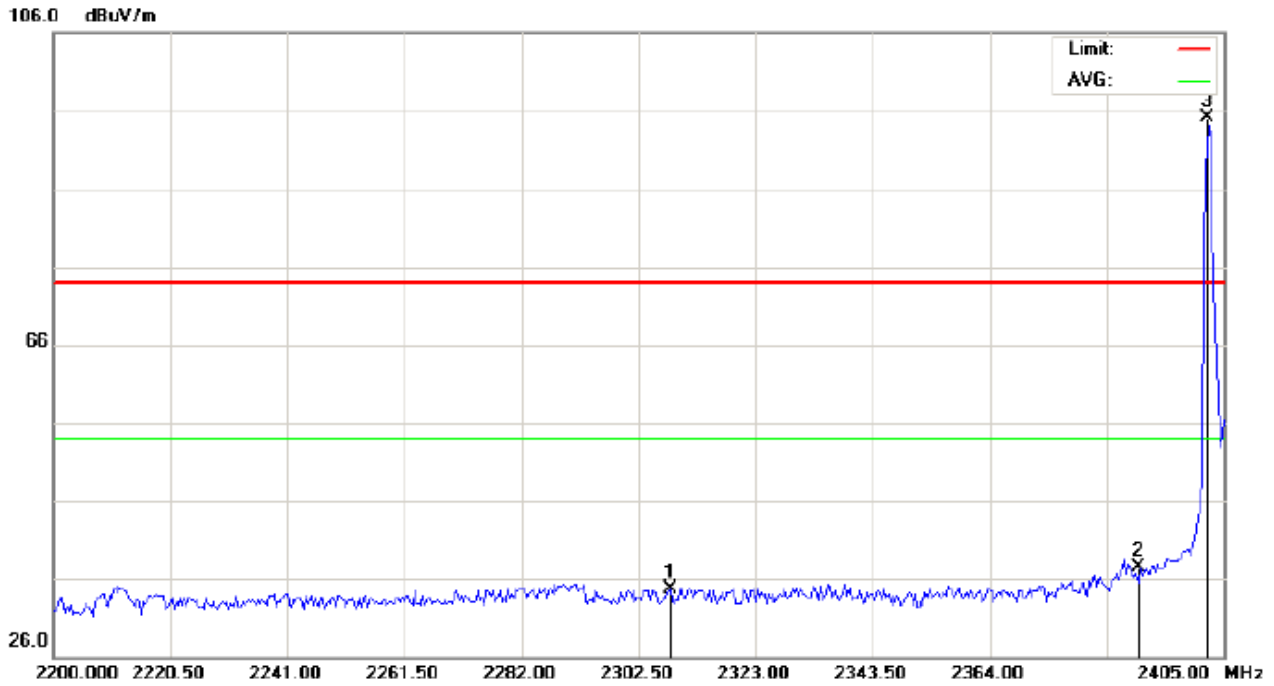

Site: site #1	Polarization: <i>Horizontal</i>	Temperature: 26
Limit: FCC Class B 3M Radiation above 1GHZ(PK)	Power:	Humidity: 60 %
EUT:Bluetooth Headset	Distance:	
M/N: SX-987		
Mode: Low Channel TX		
Note:		

No.	Mk	Freq.	Reading	Factor	Measurement	Limit	Over	Detector	Antenna	Table	Comment
		MHz	dBuV	dB/m	dBuV/m	dBuV/m	dB		Height	Degree	
									cm	degree	
1		2307.967	44.56	-9.78	34.78	74.00	-39.22	peak			
2		2390.000	47.21	-9.69	37.52	74.00	-36.48	peak			
3	*	2402.000	104.74	-9.68	95.06	74.00	21.06	peak			

TEST PLOT OF BAND EDGE FOR LOW CHANNEL - Vertical

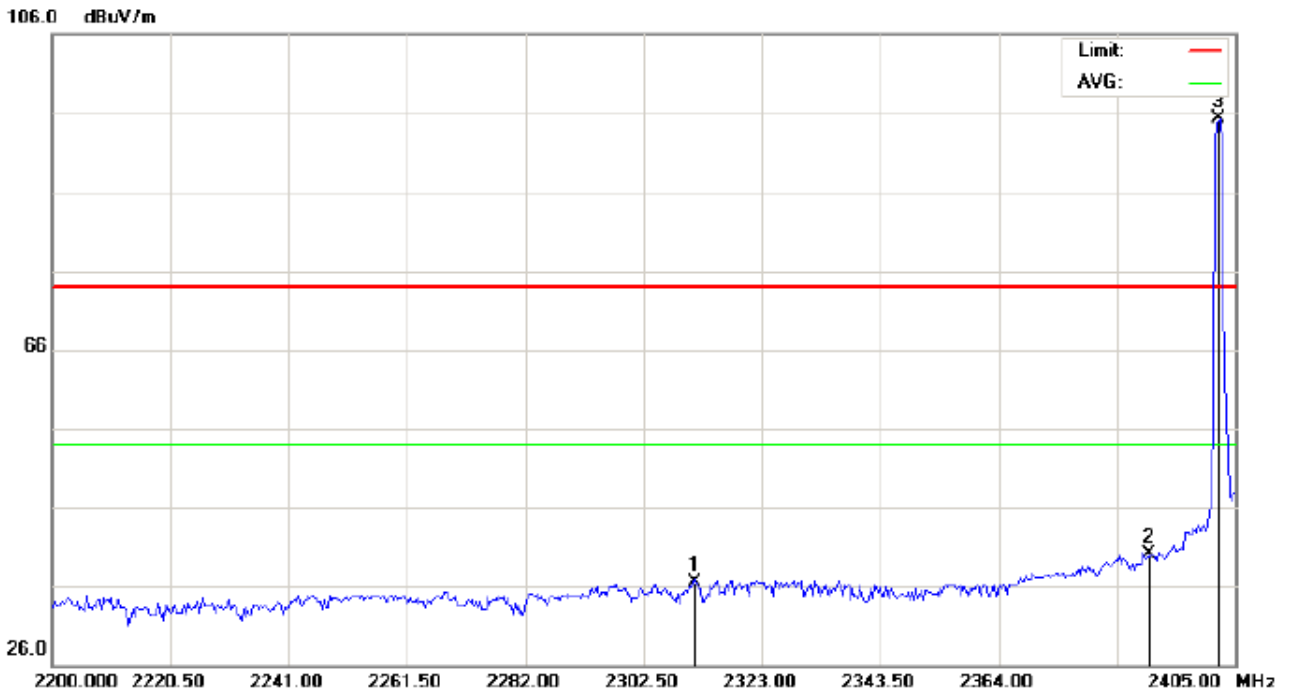

Site: site #1  
Limit: FCC Class B 3M Radiation above 1GHZ(PK)  
EUT:Bluetooth Headset  
M/N: SX-987  
Mode: Low Channel TX  
Note:

Polarization: *Vertical*  
Power:  
Distance:

Temperature: 26  
Humidity: 60 %

No.	Mk	Freq.	Reading	Factor	Measurement	Limit	Over	Detector	Antenna Height	Table Degree	Comment
		MHz	dBuV	dB/m	dBuV/m	dBuV/m	dB		cm	degree	
1		2311.383	46.22	-9.78	36.44	74.00	-37.56	peak			
2		2390.000	49.84	-9.69	40.15	74.00	-33.85	peak			
3	*	2402.000	104.99	-9.68	95.31	74.00	21.31	peak			

**RESULT: PASS**

TEST PLOT OF BAND EDGE FOR HIGH CHANNEL –Horizontal

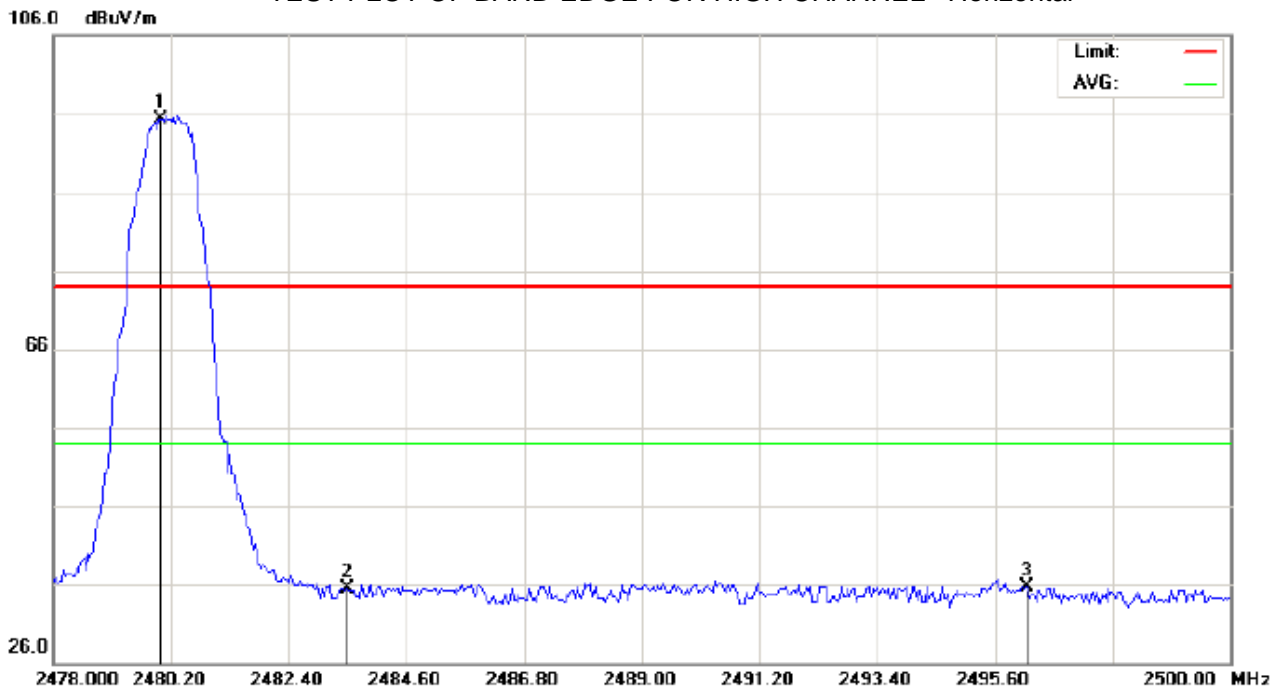

Site: site #1 Polarization: *Horizontal* Temperature: 26  
 Limit: FCC Class B 3M Radiation above 1GHZ(PK) Power: Humidity: 60 %  
 EUT:Bluetooth Headset Distance:  
 M/N: SX-987  
 Mode: High Channel TX  
 Note:

No.	Mk	Freq.	Reading	Factor	Measurement	Limit	Over	Detector	Antenna Height	Table Degree	Comment
		MHz	dBuV	dB/m	dBuV/m	dBuV/m	dB		cm	degree	
1	*	2480.000	104.96	-9.59	95.37	74.00	21.37	peak			
2		2483.500	45.06	-9.59	35.47	74.00	-38.53	peak			
3		2496.187	45.29	-9.57	35.72	74.00	-38.28	peak			

TEST PLOT OF BAND EDGE FOR HIGH CHANNEL -Vertical

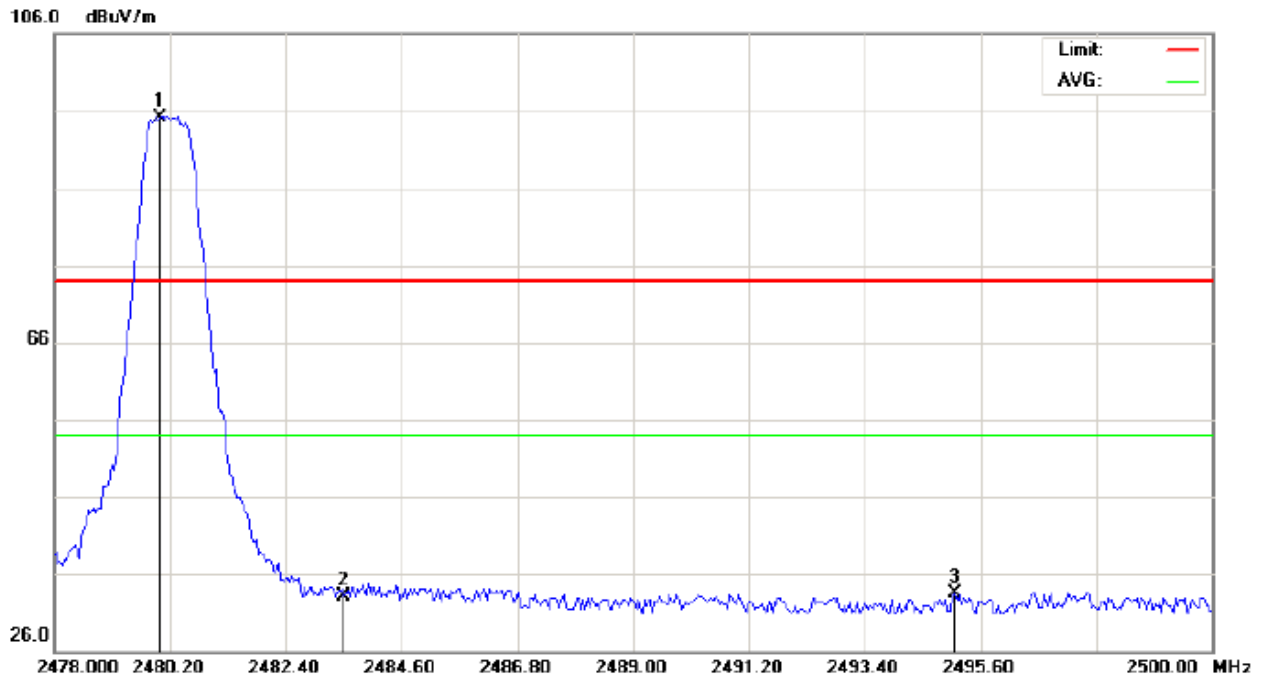

Site: site #1

Polarization: *Vertical*

Temperature: 26

Limit: FCC Class B 3M Radiation above 1GHZ(PK)

Power:

Humidity: 60 %

EUT:Bluetooth Headset

Distance:

M/N: SX-987

Mode: High Channel TX

Note:

No.	Mk	Freq.	Reading	Factor	Measurement	Limit	Over	Detector	Antenna Height	Table Degree	Comment
		MHz	dBuV	dB/m	dBuV/m	dBuV/m	dB		cm	degree	
1	*	2480.000	104.76	-9.59	95.17	74.00	21.17	peak			
2		2483.500	42.62	-9.59	33.03	74.00	-40.97	peak			
3		2495.123	43.01	-9.58	33.43	74.00	-40.57	peak			

**RESULT: PASS**

Note: Hopping on and Hopping off have been tested and only Hopping off worst case was recorded.

## 9. 6DB BANDWIDTH

### 9.1. TEST PROCEDURE

1. Connect EUT RF output port to the Spectrum Analyzer through an RF attenuator
2. Set the EUT Work on the top, the middle and the bottom operation frequency individually.
3. Set SPA Centre Frequency = Operation Frequency, RBW= 100 KHz, VBW $\geq$ 3\*RBW.
4. Set SPA Trace 1 Max hold, then View.

### 9.2. SUMMARY OF TEST RESULTS/PLOTS

Channel	6dB Bandwidth (KHz)	Minimum Limit (KHz)	Pass/Fail
Low	668	500KHz	Pass
Middle	678		Pass
High	666		Pass

TEST PLOT OF BANDWIDTH FOR LOW CHANNEL

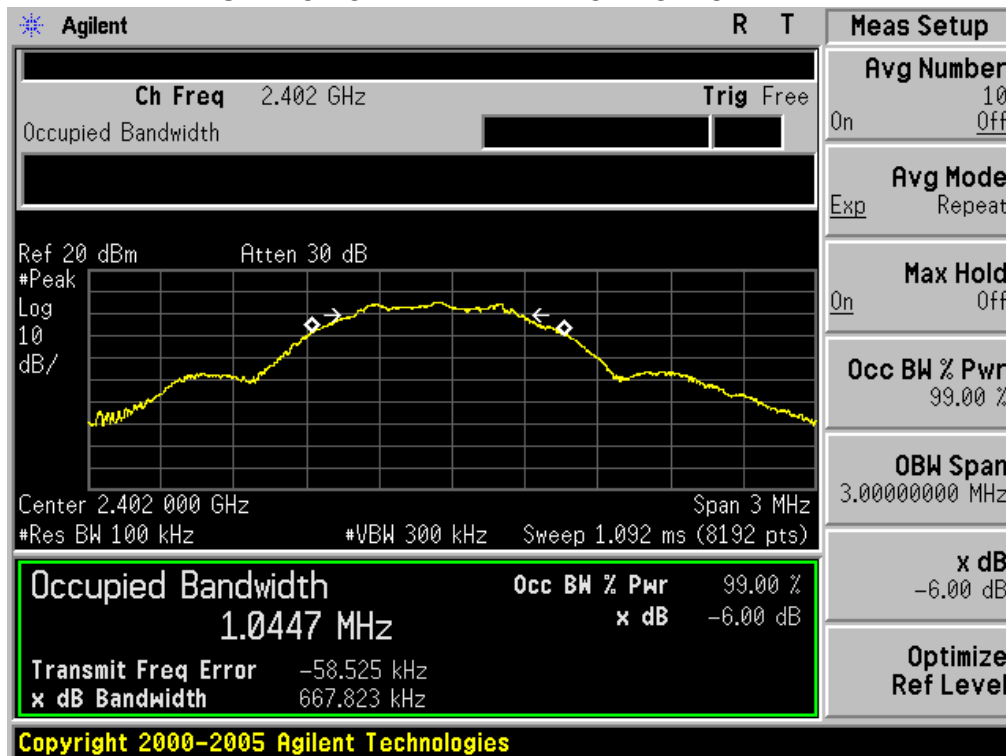

TEST PLOT OF BANDWIDTH FOR MIDDLE CHANNEL

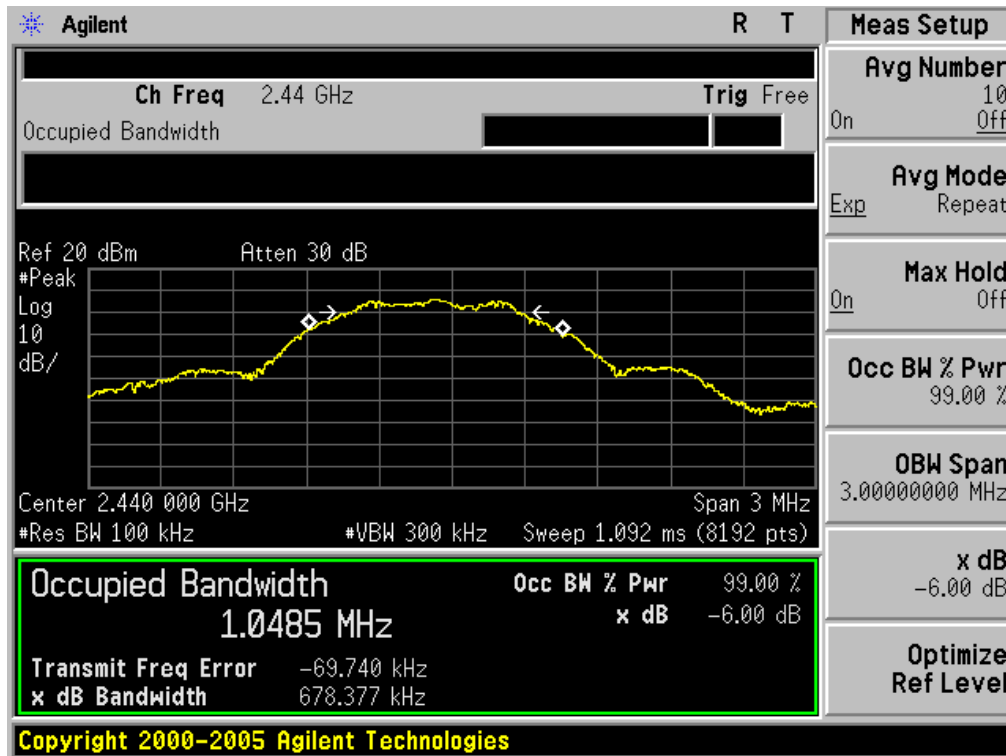

TEST PLOT OF BANDWIDTH FOR HIGH CHANNEL

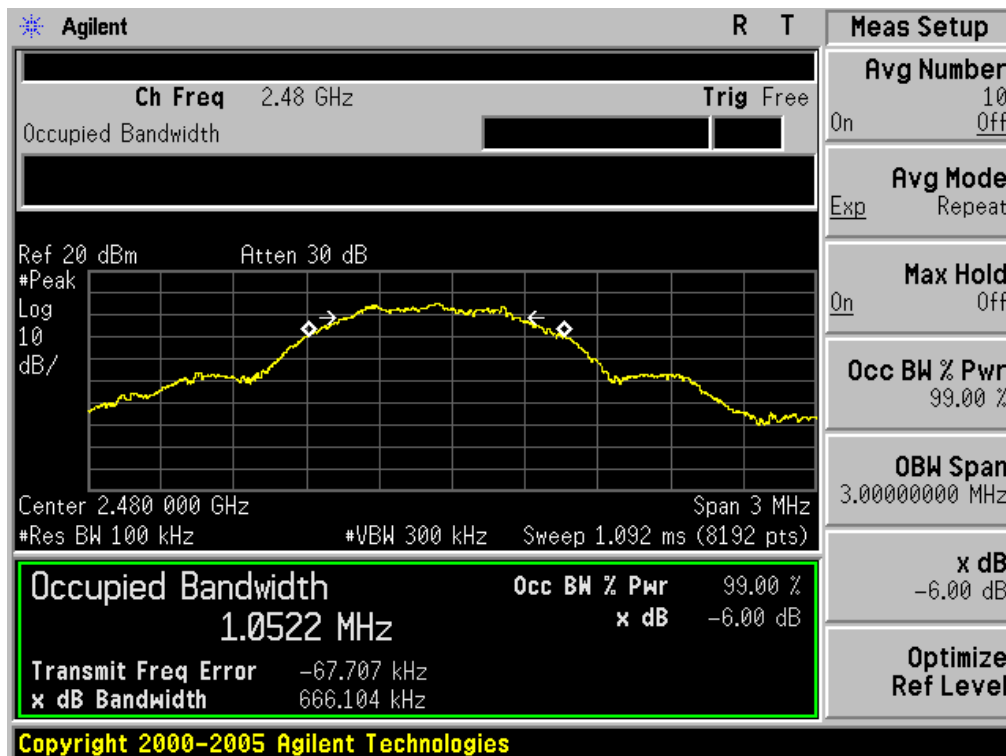



## 10. CONDUCTED OUTPUT POWER

### 10.1. MEASUREMENT PROCEDURE

For peak power test:

1. Connect EUT RF output port to the Spectrum Analyzer through an RF attenuator
2. Set the EUT Work on the top, middle and the bottom operation frequency individually.
3. Use the following spectrum analyzer settings:
  - a) Set the RBW  $\geq$  DTS bandwidth.
  - b) Set VBW  $\geq 3$  RBW.
  - c) Set span  $\geq 3 \times$  RBW
  - d) Sweep time = auto couple.
  - e) Detector = peak.
  - f) Trace mode = max hold.
  - g) Allow trace to fully stabilize.
  - h) Use peak marker function to determine the peak amplitude level.
4. Allow the trace to stabilize.
5. Record the result form the Spectrum Analyzer.

For average power test:

1. Connect EUT RF output port to power probe through an RF attenuator.
2. Connect the power probe to the PC.
3. Set the EUT Work on the top, the middle and the bottom operation frequency individually.
4. Record the maximum power from the software.
5. The maximum peak power shall be less 1W (30dBm).

**Note:** The EUT was tested according to KDB 558074 for compliance to FCC 47CFR 15.247 requirements

### 10.2. TEST SET-UP (BLOCK DIAGRAM OF CONFIGURATION)

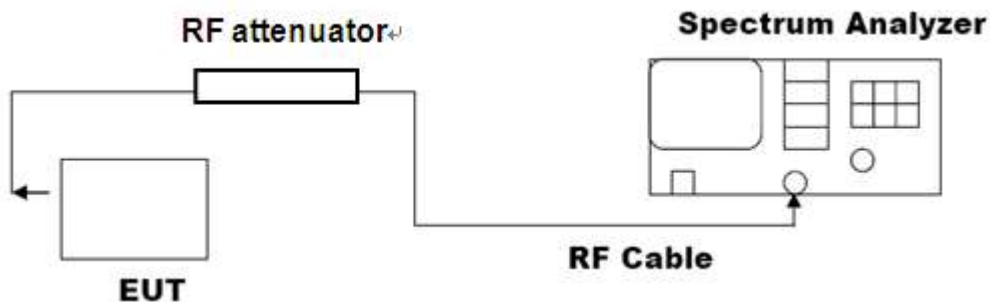

10.3. LIMITS AND MEASUREMENT RESULT

Channel	Average Power (dBm)	Peak Power (dBm)	Applicable Limits (dBm)	Pass/Fail
Low Channel	3.54	5.39	30	Pass
Middle Channel	4.45	6.34	30	Pass
High Channel	3.34	5.25	30	Pass

The Low Channel Result

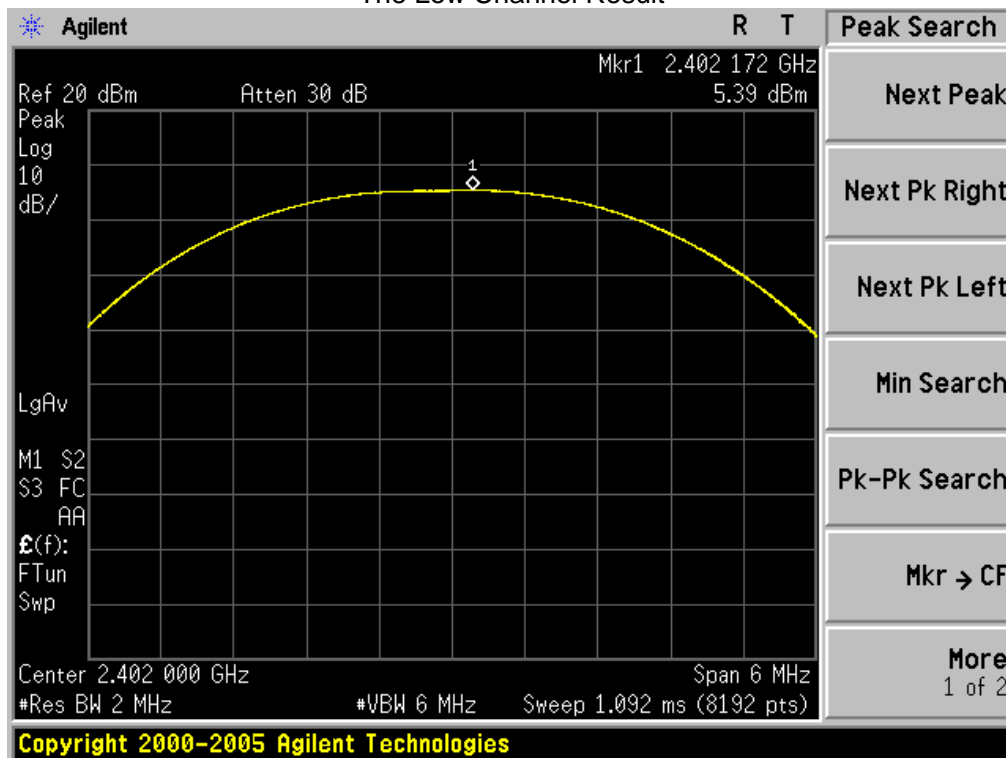

The Middle Channel Result

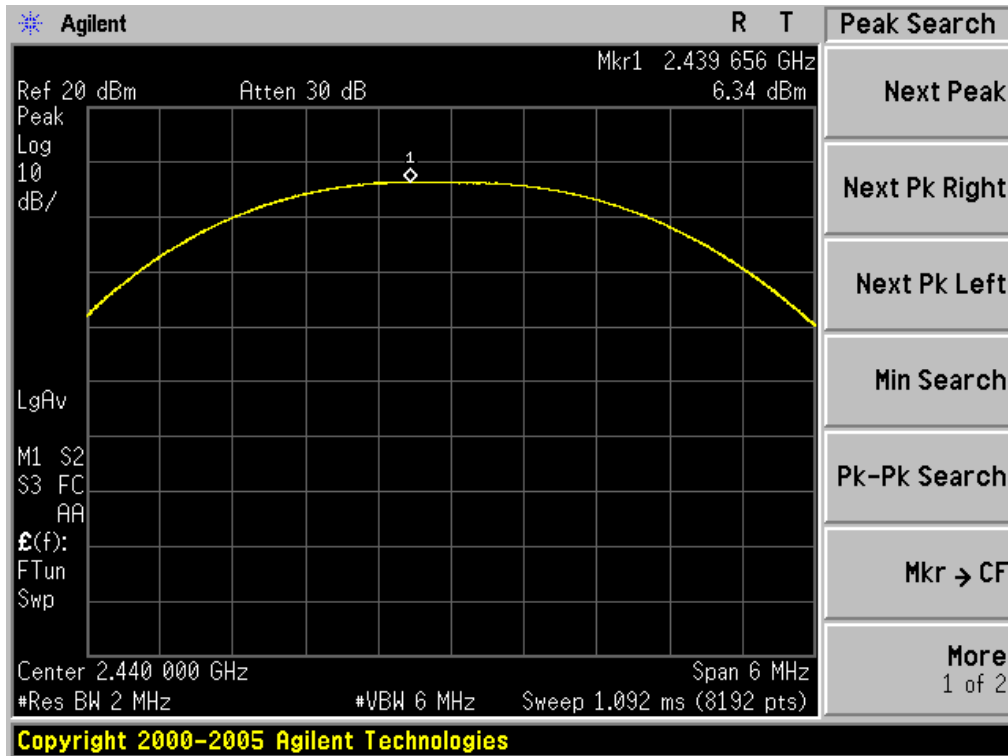

The High Channel Result

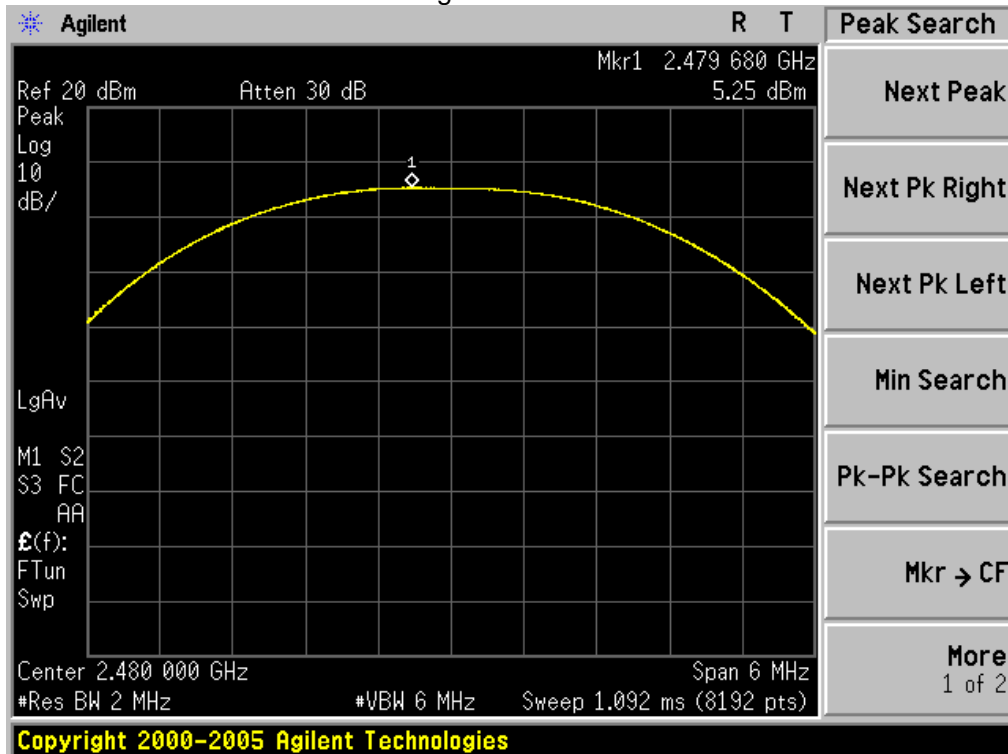

## 11. MAXIMUM CONDUCTED OUTPUT POWER SPECTRAL DENSITY

### 11.1 MEASUREMENT PROCEDURE

- (1). Connect EUT RF output port to the Spectrum Analyzer through an RF attenuator
- (2). Set the EUT Work on the top, the middle and the bottom operation frequency individually.
- (3). Set the span to 1.5times the DTS bandwidth, RBW:  $3\text{kHz} \leq \text{RBW} \leq 100\text{KHz}$ ,  $\text{VBW} = 3 * \text{RBW}$
- 4). Set SPA Trace 1 Max hold, then View.

Note: The EUT was tested according to KDB 558074 for compliance to FCC 47CFR 15.247 requirements.

### 11.2 TEST SET-UP (BLOCK DIAGRAM OF CONFIGURATION)

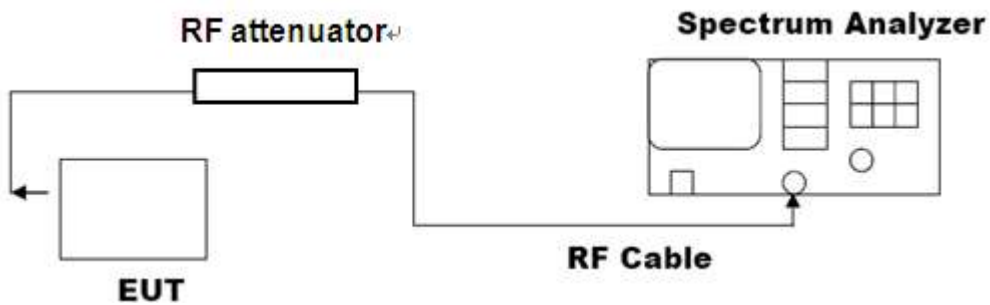

### 11.3 LIMITS AND MEASUREMENT RESULT

Channel No.	PSD (dBm)	Limit (dBm)	Result
Low Channel	-10.19	8	Pass
Middle Channel	-9.14	8	Pass
High Channel	-10.29	8	Pass

TEST PLOT OF SPECTRAL DENSITY FOR LOW CHANNEL

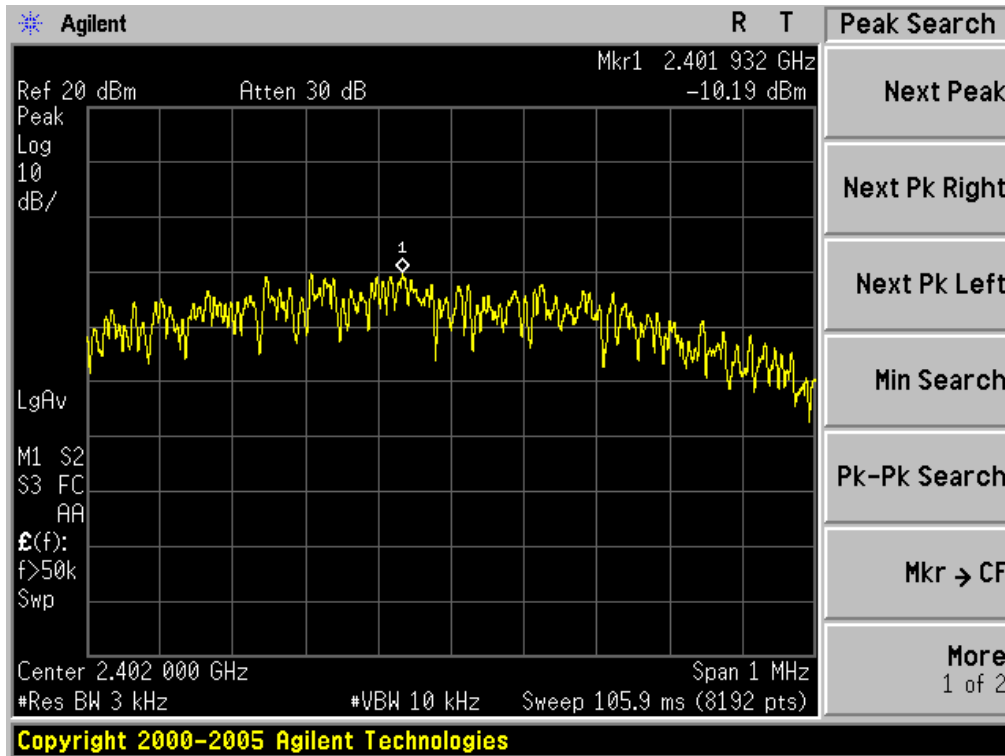

TEST PLOT OF SPECTRAL DENSITY FOR MIDDLE CHANNEL

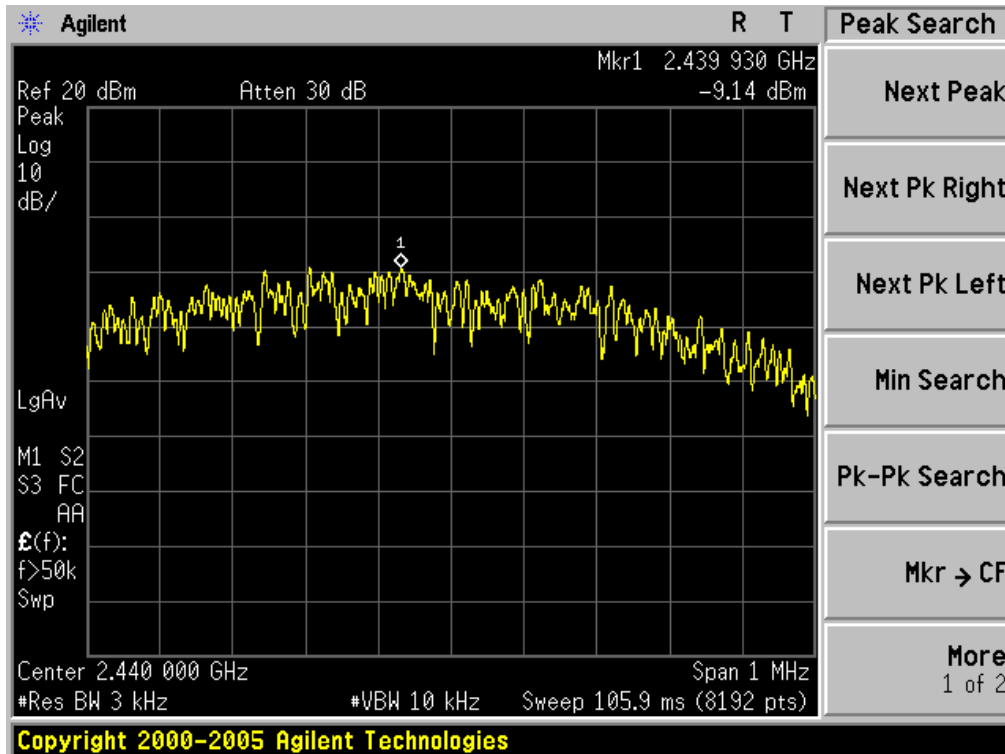

TEST PLOT OF SPECTRAL DENSITY FOR HIGH CHANNEL

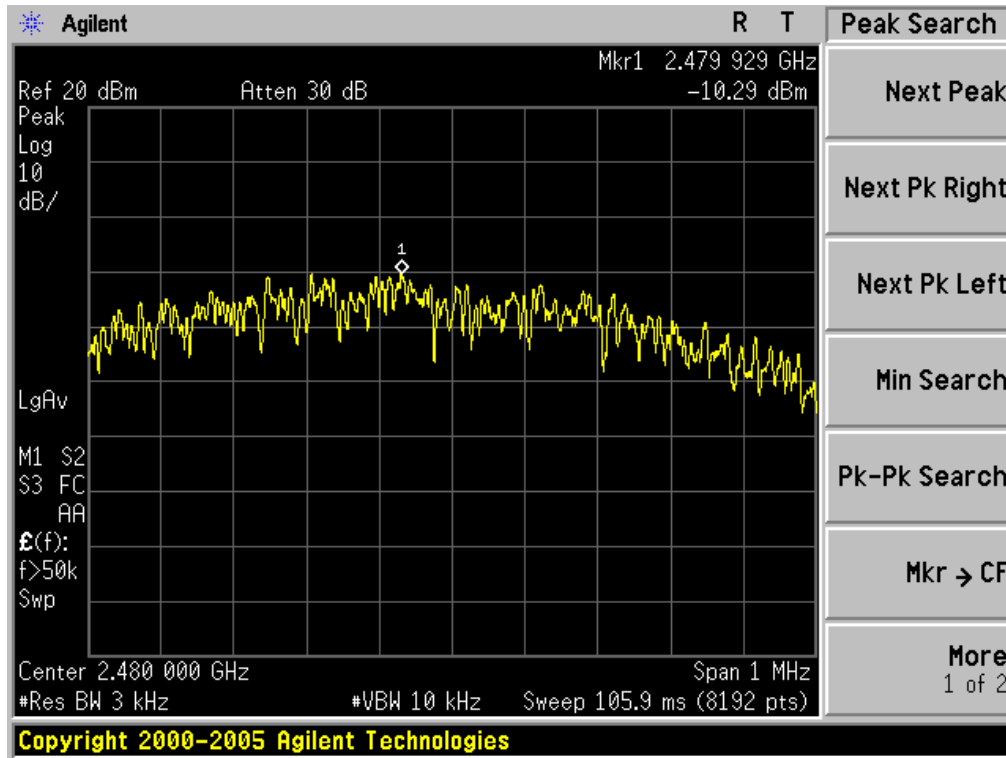

## 12. FCC LINE CONDUCTED EMISSION TEST

### 12.1 LIMITS

Frequency	Maximum RF Line Voltage	
	Q.P.( dBuV)	Average( dBuV)
150kHz~500kHz	66-56	56-46
500kHz~5MHz	56	46
5MHz~30MHz	60	50

- \*\*Note:** 1. The lower limit shall apply at the transition frequency.  
2. The limit decreases linearly with the logarithm of the frequency in the range 0.15 MHz to 0.50 MHz

### 12.2 TEST SETUP

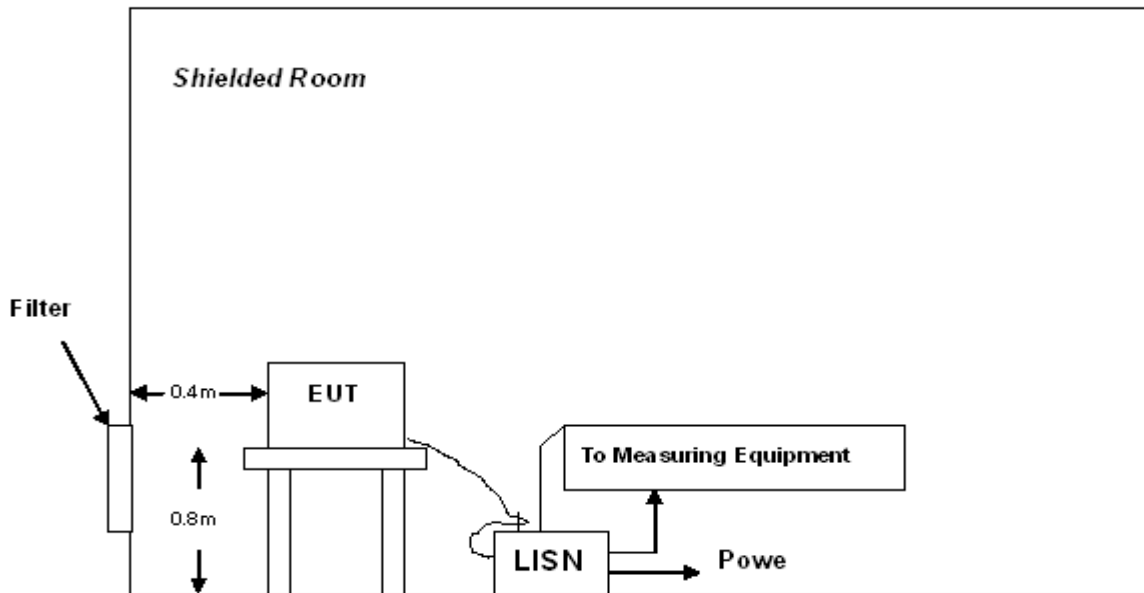

A: Powered through filter

### 12.3 PRELIMINARY PROCEDURE

- 1) The equipment was set up as per the test configuration to simulate typical actual usage per the user's manual. When the EUT is a tabletop system, a wooden table with a height of 0.8 meters is used and is placed on the ground plane as per ANSI C63.4 (see Test Facility for the dimensions of the ground plane used). When the EUT is a floor-standing equipment, it is placed on the ground plane which has a 3-12 mm non-conductive covering to insulate the EUT from the ground plane.
- 2) Support equipment, if needed, was placed as per ANSI C63.4.
- 3) All I/O cables were positioned to simulate typical actual usage as per ANSI C63.4.
- 4) All support equipments received AC120V/60Hz power from a LISN, if any.
- 5) The EUT received power by adapter which received power by a LISN.
- 6) The test program was started. Emissions were measured on each current carrying line of the EUT using a spectrum Analyzer / Receiver connected to the LISN powering the EUT. The LISN has two monitoring points: Line 1 (Hot Side) and Line 2 (Neutral Side). Two scans were taken: one with Line 1 connected to Analyzer / Receiver and Line 2 connected to a 50 ohm load; the second scan had Line 1 connected to a 50 ohm load and Line 2 connected to the Analyzer / Receiver.
- 7) Analyzer / Receiver scanned from 150 kHz to 30MHz for emissions in each of the test modes.
- 8) During the above scans, the emissions were maximized by cable manipulation.
- 9) The following test mode(s) were scanned during the preliminary test.  
Then, the EUT configuration and cable configuration of the above highest emission level were recorded for reference of final testing.

### 12.4 FINAL TEST PROCEDURE

- 10) EUT and support equipment was set up on the test bench as per step 2 of the preliminary test.
- 11) 2) A scan was taken on both power lines, Line 1 and Line 2, recording at least the six highest emissions. Emission frequency and amplitude were recorded into a computer in which correction factors were used to calculate the emission level and compare reading to the applicable limit. If EUT emission level was less -2dB to the A.V. limit in Peak mode, then the emission signal was re-checked using Q.P and Average detector.
- 12) 3) The test data of the worst case condition(s) was reported on the Summary Data page.



12.5 TEST RESULT OF POWER LINE

Line Conducted Emission Test Line 1-L

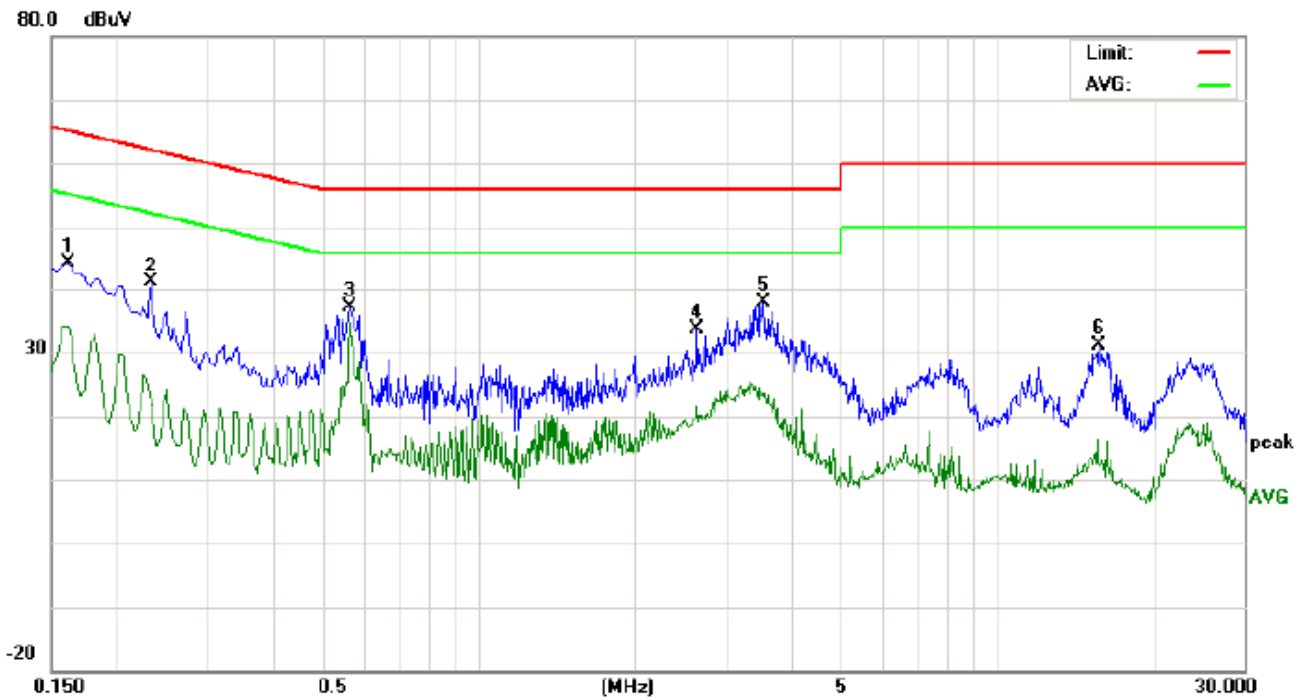

Site: Conduction Phase: *L1* Temperature: 26  
 Limit: FCC Class B Conduction(QP) Power: Humidity: 60 %  
 EUT:Bluetooth Headset  
 M/N: SX-987  
 Mode: Normal operation  
 Note:

No.	Freq. (MHz)	Reading Level (dBuV)			Correct Factor (dB)	Measurement (dBuV)			Limit (dBuV)		Margin (dB)		P/F	Comment
		Peak	QP	AVG		Peak	QP	AVG	QP	AVG	QP	AVG		
1	0.1620	34.14		24.06	10.17	44.31		34.23	65.36	55.36	-21.05	-21.13	P	
2	0.2340	30.83		11.72	10.25	41.08		21.97	62.30	52.30	-21.22	-30.33	P	
3	0.5660	26.66		24.32	10.34	37.00		34.66	56.00	46.00	-19.00	-11.34	P	
4	2.6460	23.06		11.24	10.46	33.52		21.70	56.00	46.00	-22.48	-24.30	P	
5	3.5340	27.46		12.96	10.50	37.96		23.46	56.00	46.00	-18.04	-22.54	P	
6	15.7900	21.02		2.20	10.11	31.13		12.31	60.00	50.00	-28.87	-37.69	P	

Line Conducted Emission Test Line 2-N

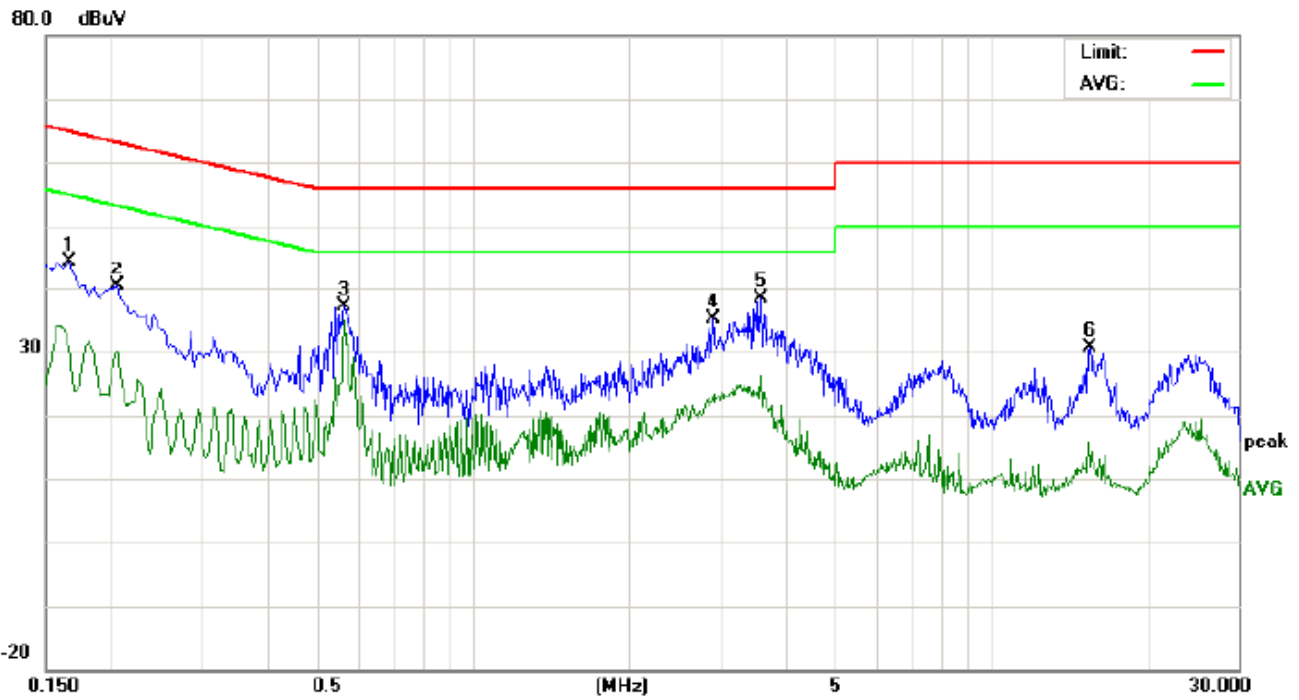

Site: Conduction Phase: **N** Temperature: 26  
Limit: FCC Class B Conduction(QP) Power: Humidity: 60 %  
EUT:Bluetooth Headset  
M/N: SX-987  
Mode: Normal operation  
Note:

No.	Freq. (MHz)	Reading_Level (dBuV)			Correct Factor (dB)	Measurement (dBuV)			Limit (dBuV)		Margin (dB)		P/F	Comment
		Peak	QP	AVG		Peak	QP	AVG	QP	AVG	QP	AVG		
1	0.1660	34.31		20.33	10.18	44.49		30.51	65.15	55.15	-20.66	-24.64	P	
2	0.2060	30.06		19.82	10.22	40.28		30.04	63.36	53.36	-23.08	-23.32	P	
3	0.5660	26.80		24.63	10.34	37.14		34.97	56.00	46.00	-18.86	-11.03	P	
4	2.9140	24.65		11.76	10.53	35.18		22.29	56.00	46.00	-20.82	-23.71	P	
5	3.5900	27.99		15.61	10.50	38.49		26.11	56.00	46.00	-17.51	-19.89	P	
6	15.5380	20.58		1.75	10.11	30.69		11.86	60.00	50.00	-29.31	-38.14	P	

## APPENDIX A: PHOTOGRAPHS OF TEST SETUP

### FCC LINE CONDUCTED EMISSION TEST SETUP



FCC RADIATED EMISSION TEST SETUP





## APPENDIX B: PHOTOGRAPHS OF EUT

### ALL VIEW OF EUT



TOP VIEW OF EUT



BOTTOM VIEW OF EUT



FRONT VIEW OF EUT



BACK VIEW OF EUT



LEFT VIEW OF EUT



RIGHT VIEW OF EUT



OPEN VIEW OF EUT-1





OPEN VIEW OF EUT-2



OPEN VIEW OF EUT-3



INTERNAL VIEW OF EUT-1

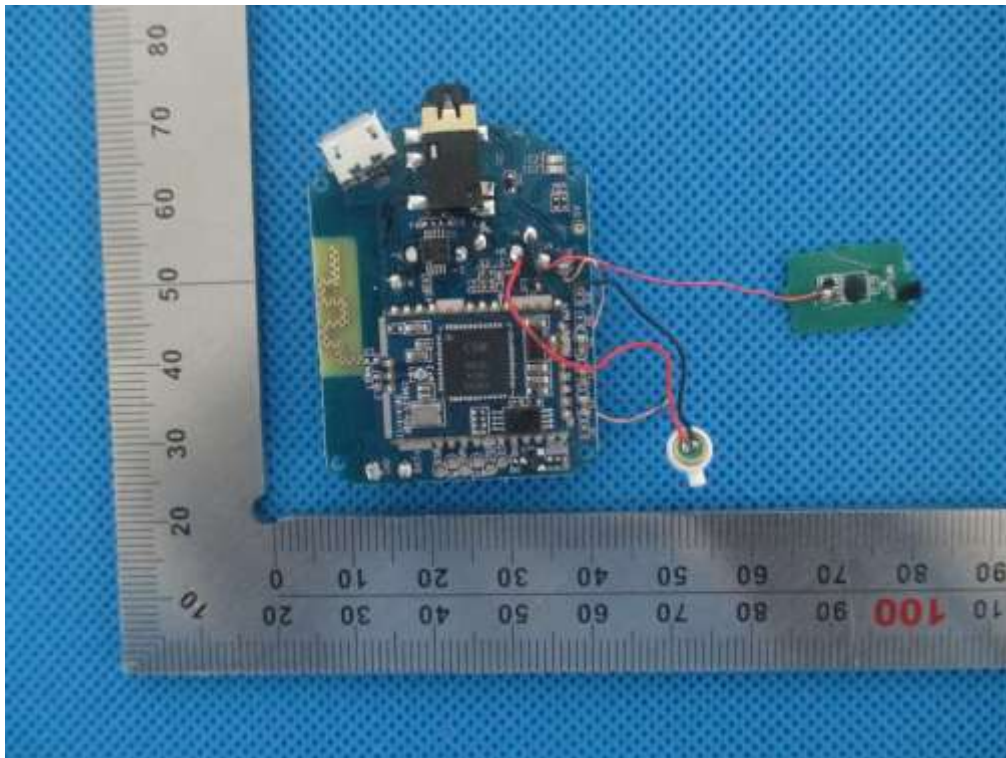

INTERNAL VIEW OF EUT-2

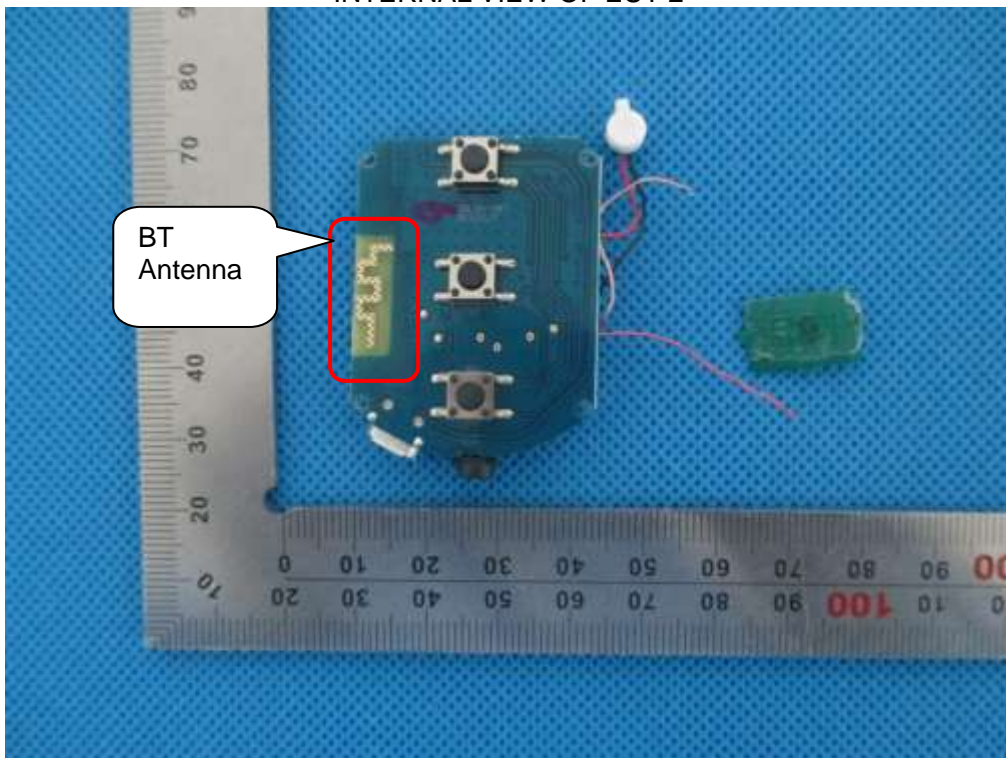

INTERNAL VIEW OF EUT-3

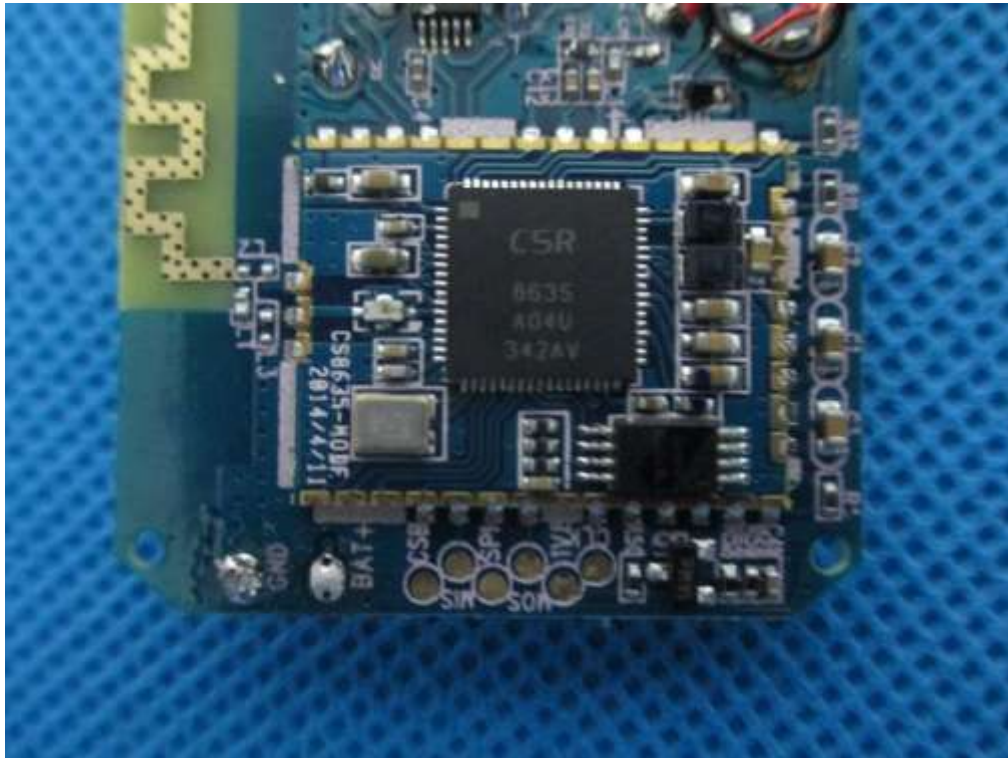

----END OF REPORT----