

# Electric Vehicle AC Charger

## Installation Instructions

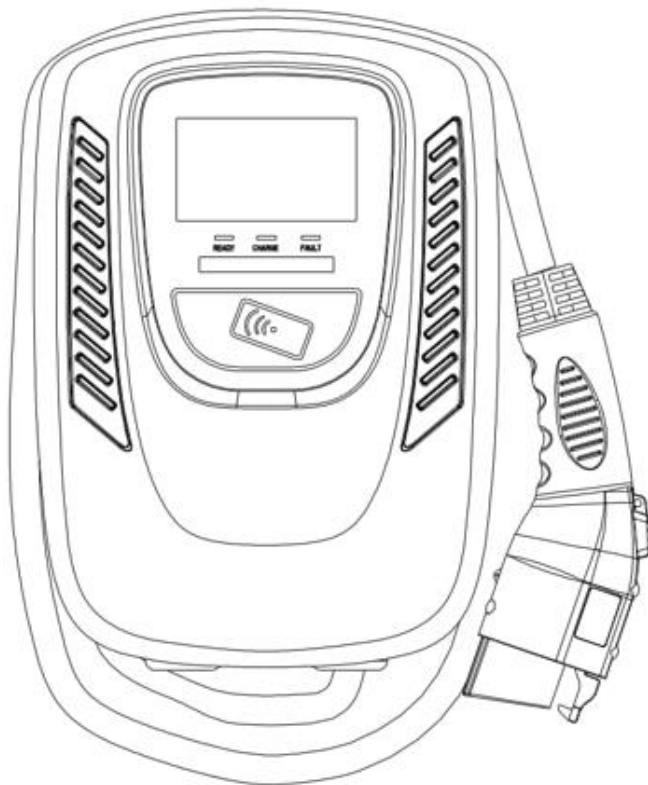

## TABLE OF CONTENTS

1. IMPORTANT SAFETY INSTRUCTIONS .....	2
2. PRODUCT INTRODUCTIONS .....	6
3. VERIFY CONTENTS .....	8
4. GATHER TOOLS .....	10
5. PLAN THE MOUNTING .....	11
6. MOUNT THE CHARGING STATION .....	13
7. WIRE THE CIRCUIT .....	15
8. OPERATE YOUR DEVICE .....	16
9. LIGHT CODES .....	20
10. WARRANTY AND MAINTENANCE .....	21



## WARNING & CAUTION

# 1. Important Safety Instructions

## 1.1 Overall Warnings & Cautions

- ⚠ WARNING:** To avoid fire, injury or death, carefully read and follow the instructions during installation, operation and maintenance.
  - **DO NOT** put fingers into the electric vehicle connector.
  - **DO NOT** use this product if the flexible power cord or EV cable is frayed, insulation-broken, or any other signs of damage.
  - **DO NOT** use this product if the enclosure or the EV connector is broken, cracked, open, or shows any other indication of damage.
  - **DO NOT** remove cover or attempt to open the enclosure because of risk of electric shock.
- ⚠ WARNING:** This device should be supervised when used around children.
- ⚠ WARNING:** This device must be grounded.
- ⚠ WARNING:** To avoid a risk of fire or electric shock, do not use this device with an extension cord.
- ⚠ WARNING:** The suitability of the use of flexible cord in accordance with CE code, part I, rule 4-012, is to be determined by the local inspection authority.
- ⚠ WARNING:** To reduce the risk of fire, connect only to a circuit provided branch circuit over-current protection in accordance with the CSA C22.1–15 Canadian Electrical Code, Part 1 (Canada) or NOM-001-SEDE Electrical installations (utility) (Mexico) or ANSI / NFPA 70 National Electrical Code (USA).

Circuit Breaker Options table						
Output Amperage (A)	16A	32A	40A	48A	70A	80A
Circuit Breaker Options (A)	20A	40A	50A	60A	90A	100A

# USER MANUAL



## WARNING & CAUTION

### 1.2 Installation Requirements

- ⚠ WARNING:** Disconnect electrical power prior to installing the charging station.
- ⚠ WARNING:** Be sure to preview the user manual and ensure local building and electrical codes are reviewed before installing the AC charger.
- ⚠ WARNING:** The AC charger should be installed by a qualified technician according to the user manual and local safety regulations.
- ! CAUTION:** Use appropriate protection when connecting to the main power distribution cable.
- ! CAUTION:** Type B, C or D breaker with the rating current for table should be installed in the upstream AC distribution box.
- ! CAUTION:** The device shall be mounted at height between 2 feet and 4 feet from ground.
- ! CAUTION:** Please keep the charger in a clean area with low humidity. Not recommended to be installed in coastal environments with high humidity or high dust.

### 1.3 Daily Maintenance







- ! CAUTION:** Avoid moisture or water in the charger. If there is water or moisture ingress in the charger, it is necessary to immediately power off to avoid immediate danger, and notify the professionals to carry out maintenance before next use.
- ! CAUTION:** Please use the charger properly. Do not hit or press hard on the enclosure. If it is damaged, please contact a professional technician.
- ! CAUTION:** Avoid placing the charger near hot objects and at high temperature locations and away from dangerous substances such as flammable gases and corrosive materials.
- ! CAUTION:** Do not put heavy objects on the charger to avoid danger.



## WARNING & CAUTION

# Consignes De Sécurité Importantes

## 1.1 Avertissement & Mise En Garde Généraux

- 
**AVERTISSEMENT** : Pour éviter les risques d'incendie, de blessure ou de mort, il faut lire et suivre soigneusement les instructions pendant l'installation, l'utilisation et l'entretien.
  - **Ne mettez pas** les doigts dans le connecteur du véhicule électrique.
  - **N'utilisez pas** ce produit si le cordon d'alimentation flexible ou le câble EV est effiloché, isolé ou présentant tout autre signe de dommage.
  - **N'utilisez pas** ce produit si le boîtier ou le connecteur EV est cassé, fissuré, ouvert ou montre toute autre indication de dommage.
- 
**Ne retirez pas** le couvercle et n'essayez pas d'ouvrir le boîtier en raison du risque de choc électrique.
- 
**AVERTISSEMENT** : Cet appareil doit être surveillé lorsqu'il est utilisé à proximité d'enfants.
- 
**AVERTISSEMENT** : Cet appareil doit être mis à la terre.
- 
**AVERTISSEMENT** : Pour éviter tout risque d'incendie ou de choc électrique, n'utilisez pas cet appareil avec une rallonge électrique.
- 
**AVERTISSEMENT** : L'adéquation de l'utilisation du cordon flexible conformément au code ce, partie i, règle 4-012, doit être déterminée par l'autorité d'inspection locale compétente.
- 
**AVERTISSEMENT** : Pour réduire les risques d'incendie, ne connecter qu'à un circuit protection contre les surintensités des circuits de dérivation conformément à la norme canadienne CSA C22.1-15 Code électrique, partie 1 (Canada) ou NOM-001-SEDE Installations électriques (Mexique) ou ANSI / NFPA 70 National Electrical Code (États-Unis).

Circuit Breaker Options table						
Output Amperage (A)	16A	32A	40A	48A	70A	80A
Circuit Breaker Options (A)	20A	40A	50A	60A	90A	100A



## WARNING & CAUTION

### 1.2 Exigence Avant L'installation

- ⚠ AVERTISSEMENT** : Assurez-vous de consulter le manuel d'utilisation et assurez-vous que les codes locaux du bâtiment et de l'électricité sont passés en revue avant d'installer le chargeur.
- ⚠ AVERTISSEMENT** : Débranchez l'alimentation électrique avant d'installer la station de charge.
- ⚠ AVERTISSEMENT** : Le chargeur CA doit être installé par un technicien qualifié conformément au manuel d'utilisation et aux réglementations de sécurité locales.
- ⚠ MISE EN GARDE** : Utilisez une protection appropriée lors de la connexion au câble de distribution d'alimentation principal.
- ⚠ MISE EN GARDE** : Un disjoncteur de type B, C ou D avec le courant nominal indiqué dans le tableau doit être installé dans le boîtier de distribution CA en amont.
- ⚠ MISE EN GARDE** : Cet appareil doit être monté à une hauteur entre 2 feet and 4 feet du sol.
- ⚠ MISE EN GARDE** : Veuillez conserver le chargeur dans un endroit propre et peu humide. Il n'est pas recommandé de l'installer dans des environnements côtiers à forte humidité ou à forte poussière

### 1.3 Entretien Quotidien

- ⚠ MISE EN GARDE** : Évitez l'humidité ou l'eau dans le chargeur. En cas d'infiltration d'eau ou d'humidité dans le chargeur, il est nécessaire de l'éteindre immédiatement pour éviter tout danger immédiat et d'avertir le personnel professionnel d'effectuer l'entretien avant la prochaine utilisation.
- ⚠ MISE EN GARDE** : Veuillez utiliser le chargeur correctement. Ne frappez pas ou n'appuyez pas trop fort sur le boîtier. Si le boîtier est endommagé, veuillez contacter un technicien professionnel.
- ⚠ MISE EN GARDE** : Évitez de placer le chargeur à proximité d'objets chauds et à des endroits à haute température et loin de substances dangereuses telles que des gaz inflammables et des matériaux corrosifs.
- ⚠ MISE EN GARDE** : Ne placez pas d'objets lourds sur le chargeur pour éviter tout danger.

## 2. Product Introductions



**CAUTION:** Avoid placing the charger near hot objects and at high temperature locations and away from dangerous substances such as flammable gases and corrosive materials.

### 2.1 Basic Interface

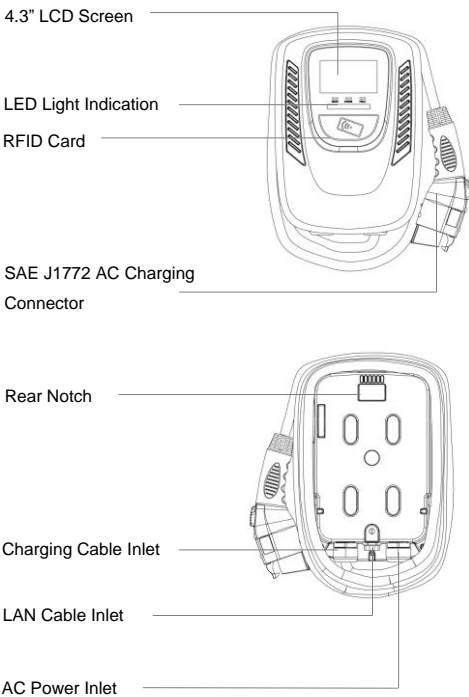

### 2.2 Basic Dimension

#### Enclosure

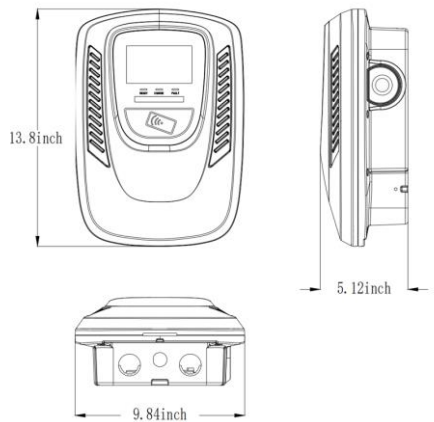

#### Wall-Mounted Bracket

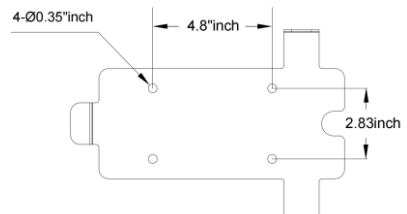

# USER MANUAL

## 2.3 Specifications

Model Number	JNT-EVC Version
Rated Input Voltage	208/240VAC
Rated Output Current	16/32/40/48/70/80A
AC Power Frequency	50-60 Hz
Input Protection	UVP, OVP, RCD, SPD, Ground Fault Protection
Output Protection	OCP, OTP, Control Pilot Fault Protection
Output Interface	SAE J1772AC Charging Connector
Storage Temperature	-40°F to 158°F
Operation Temperature	-22°F to 122°F
Relative Operation Humidity	95% RH Maximum
Relative Storage Humidity	95% RH Maximum
Network Connection	LAN Version /Wi-Fi Version/4G version
Internet Function	10M / 100M Base-T
Wi-Fi Function	802.11 b/g/n
3G/4G Function	GSM/4G
Cable Length	18ft (25ft optional)
Protection Level	Type 3
Installation Type	Wall-Mounted
Altitude	≤ 6561ft
Status Indication	Red, Green, Blue LED



## 3. Verify Contents

Check the box to ensure you have this installation guide and these parts:



1

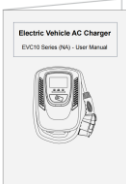

2

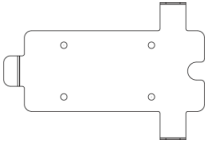

3



4



5



6



7



8

# USER MANUAL

No.	Product Name	Quantity	Description
1	AC Charger	1	With attached input power cable and output charging cable
2	User Manual	1	Please read carefully before use
3	Wall-Mounted Bracket	1	For mounting the charging station to the wall/structure
4	M5 Anti-Theft Round Head Screws	2	For securing the charging station to the Mounting Bracket
5	M6 Hexagonal Expansion Screws	4	For installing the Mounting Bracket to the wall/structure
6	Allen Wrench	1	For tightening M5 Screws
7	Corrugated Mounting Template	1	For easy drilling of 4 screws holes for wall-mounted bracket.
8	RFID Card (Optional)	2	Control the charger start/stop

## 4. Gather Tools

Tools required before installing the Wall-Mounted charger, gather the following tools:

1. Wire stripper
2. Adjustable Wrench
3. Voltmeter or digital multi-meter (for measuring AC voltage at the installation site)
4. Level
5. Pencil or marker
6. Drill
7. Phillips screwdriver

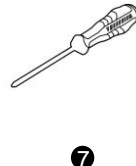
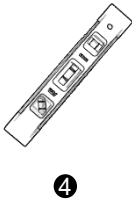
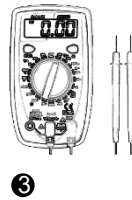
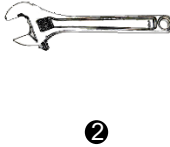
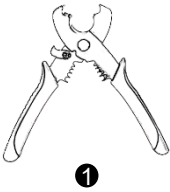

Note: The above tools are very important, please gather them all.

# USER MANUAL

## 5. Plan The Mounting



---

**WARNING:** In areas with frequent thunderstorms, add surge protection at the service panel for all circuits. Ensure all power and ground connections, especially those at the breaker and bus bar, are clean and tight.

---



---

**CAUTION:** Not recommended to be installed in coastal environments with high humidity or high dust.

---

### STEP 1 (Only for 4G Version)

Use screwdriver to loosen the 13 fixed screws on the rear of charger, then remove the front cover (for 4G Version).

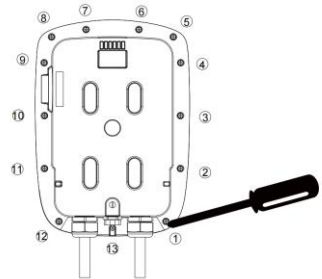

### STEP 2 (Only for 4G Version)

Insert the SIM card according to the picture's instruction (for 4G Version).

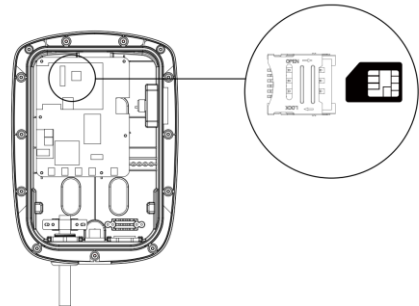

## STEP 3 (Only for 4G Version)

Tighten 13 screws on the front cover after the front cover is put back, the recommended screw torque is 1.0 N.m (9.6 lbf.in) (for 4G Version).

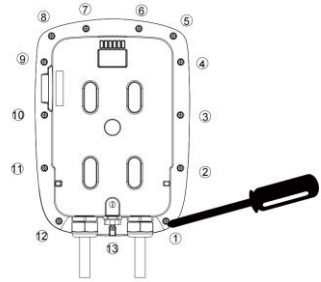

## STEP 4

**Select** the appropriate mounting location with electrical capacity:

- I. Ensure the owner has chosen a mounting location that allows the charging cable to reach the car's charging port while still providing slack.
- II. The device must be anchored into mounting such as 3.14" x 5.11" stud or a solid wall.
- III. The device shall be mounted at height between 2 feet and 4 feet from ground.

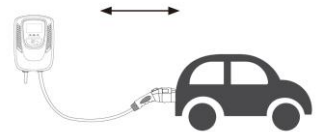

## STEP 5

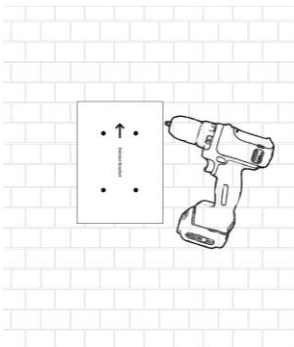

**Drill 4 Screw Holes** with a diameter of 0.32" and a depth of 2.04" by using our mounting template. Please drill screw holes in the direction of the template arrow.

# USER MANUAL

## 6. Mount the Charging Station

### STEP 1

Use 4 sets Hexagonal Expansion Screws to secure the wall-mounted bracket on the wall. Then level the brackets.

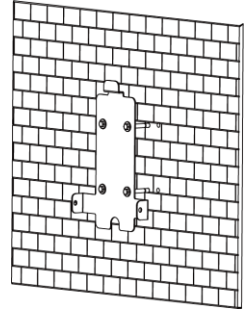

### STEP 2



**Align** the rear notch of charger with the wall-mounted bracket and fit the screw holes of the right and left side.

### STEP 3



**Tighten** two M5 anti-theft screws to complete the installation.

## STEP 4

Overall outlook picture after installation.

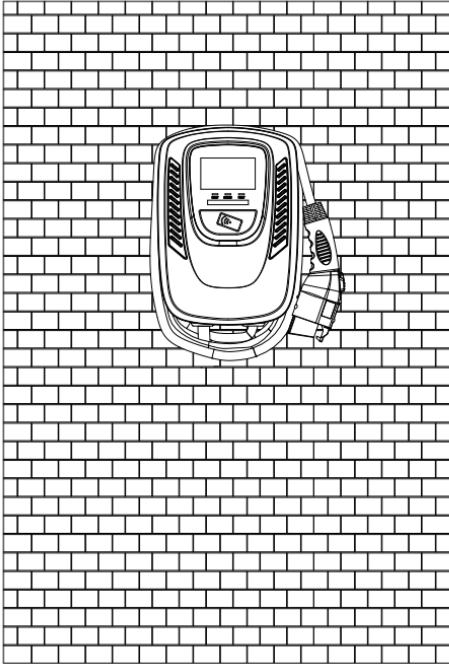

Wall-mounted cable winding

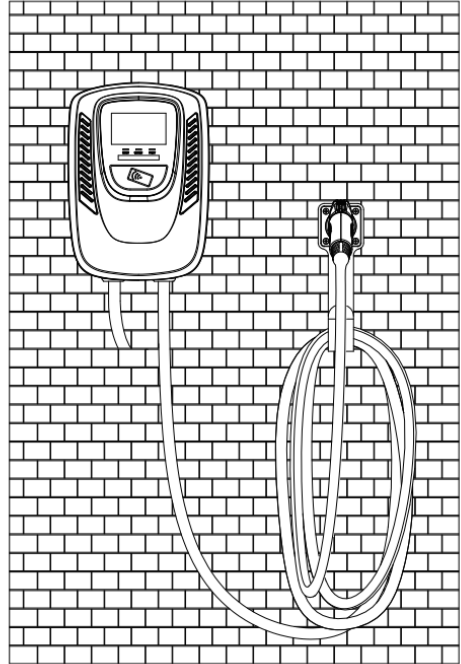

Optional cable hanging (optional accessory)

# USER MANUAL

## 7. Wire The Circuit



**WARNING:** This device must be grounded. Disconnect electrical power prior to installing the charging station.



**WARNING:** Improper connection of the equipment-grounding conductor would result in a risk of electric shock. Check with a qualified electrician or serviceman if you are not sure whether the product is properly grounded. Do not modify the plug provided with the product – if it doesn't fit the outlet, have a proper outlet installed by a qualified electrician.



**CAUTION:** Use appropriate protection when connecting to the main power distribution cable.

For safe use of electricity, please set circuit breaker protection in the input part of EV Charger. The wiring is not complicated, just need to follow the instructions below:

Connect the L1 lead to the grid L1, connect the L2 lead to the grid L2, connect the PE lead to the grid PE.

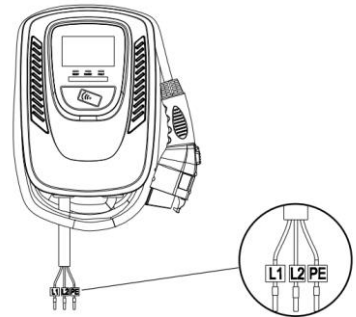

Circuit Breaker Options table						
Output Amperage (A)	16A	32A	40A	48A	70A	80A
Circuit Breaker Options (A)	20A	40A	50A	60A	90A	100A



## 8. Operate Your Device



---

**WARNING:** This device should be supervised when used around children.

---



---

**CAUTION:** Please use the charger properly. Do not hit or press hard on the enclosure. If the case is damaged, please contact a professional technician.

---



---

**CAUTION:** Do not put heavy objects on the charger to avoid danger.

---

### 8.1 Operating Steps with Plug and Charge

#### STEP 1

Standby Mode: After being powered on, the lights will be all on, blue light (READY), green light (CHARGE) and red light (FAULT). Then the blue light (READY) is constantly on in standby mode.



READY

# USER MANUAL

## STEP 2

### Plug the Charging Connector:

Please plug the charging connector into the vehicle charging inlet.



## STEP 3

**Charging:** The green light (CHARGE) turns to flash automatically, charging is in process.

- If the red light (FAULT) is on, plug the vehicle connector again.
- If red light is still on, please refer to "Error and Warning Messages".

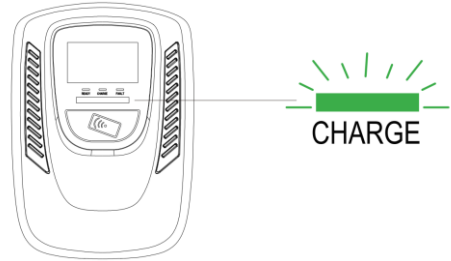

## STEP 4

**Charging finished:** When the charging is finished, the green light (CHARGE) is constantly on, pull out the charging connector.

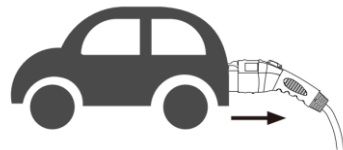

## 8.2 Operating Steps with RFID (Optional)



**CAUTION:** Please keep your RFID card properly to avoid unnecessary loss.

### STEP 1

**Standby Mode:** After power-on, blue light (READY), green light (CHARGE) and red light (FAULT) all on. The blue light (READY) is constantly on when in standby mode.

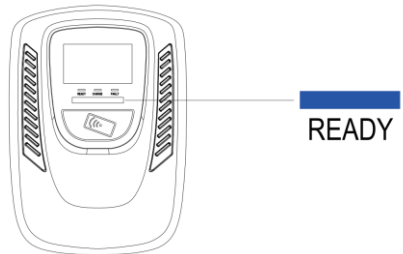

### STEP 2

**Ready to charge:**

Please plug the charging connector into the vehicle charging inlet. When the green light (CHARGE) is constantly on, the user can swipe the RFID Card

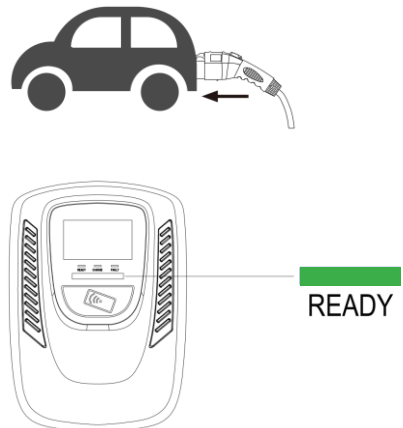

# USER MANUAL

## STEP 3

### Swipe the RFID Card:

Swipe the RFID card first and plug in the charging connector within 120 seconds, otherwise you need to swipe the RFID card again.

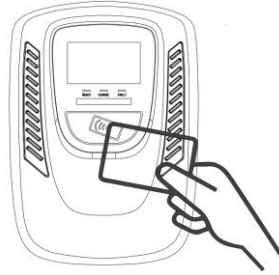

## STEP 4

**Charging:** The green light (CHARGE) turns to flash automatically, charging is in process.

- If the red light (FAULT) is on, plug in the charging connector again.
- If red light is still on, please refer to "Error and Warning Messages".

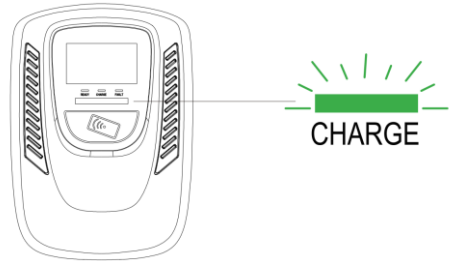

## STEP 5

### Charging finished:

When the charging is finished or swipe your RFID card, the green light (CHARGE) is constantly on. Please press the button on connector and pull out the charging connector

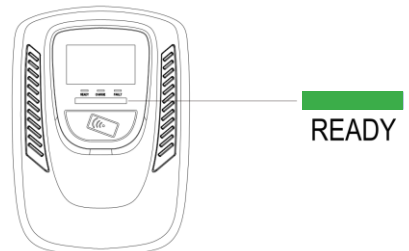

## 9. Light Codes

### 9.1 After Start UP

Standby, waiting to plug in	Waiting to charge, communicating with vehicle	Charging in progress	Finished charging	Fault
Solid Blue	Solid Green	Green Blinking	Solid Green	Solid Red

### 9.2 Error and Warning Messages

Status	Red	Remark
Input OVP	1 flash followed by 3 sec pause	Auto Recover
Input UVP	2 flashes followed by 3 sec pause	Auto Recover
Output OCP	3 flashes followed by 3 sec pause	Auto Recover
OTP	4 flashes followed by 3 sec pause	Auto Recover
RCD Abnormal	5 flashes followed by 3 sec pause	Auto Recover
Ground Fault	6 flashes followed by 3 sec pause	Auto Recover
Control Pilot Fault	Flicker	Auto Recover
Emergency Fault	Constantly Bright	Rotate to Reset Emergency Button
MCU Self-Test Fail	Constantly Bright	Contact Customer Service
RCD Self-Test Fail	Constantly Bright	Contact Customer Service
Relay Self-Test Fail	Constantly Bright	Contact Customer Service
RCD Abnormal Stop Charging	Constantly Bright	Contact Customer Service
Output OCP Stop Charging	Constantly Bright	Contact Customer Service
OTP Stop Charging	Constantly Bright	Contact Customer Service

## 10. Warranty and Maintenance

- The warranty period for this charger is three years.
- During the warranty period for any malfunction under normal use according to the User Manual (to be determined by certified maintenance technicians of sellers), the product shall be repaired free of charge. Except for the following situations, the charger shall be subject to the above warranty terms:
  1. The warranty certificate cannot be provided or the contents of the warranty certificate are modified or inconsistent with the label indication of the repaired product.
  2. Those who are unable to provide valid proof of purchase.
  3. Those who exceed the manufacturer's specified warranty period.
  4. Those who damage the product due to not following the product service instruction for use, maintenance and storage.
  5. Damage or malfunction caused by external object entering.
  6. Unauthorized repair, disassembly or modification.
  7. Damage caused by force majeure (such as lightning, excessive voltage, earthquake, fire, flood, etc.).
  8. Malfunction and damage caused by other unavoidable external factors. Malfunction and damage caused by improper use of equipment, such as water or other solutions entering into the equipment.
  9. Malfunction and damage caused by the grid power supply and voltage which is not specified for use with the charger equipment.

The above guarantees shall be made solely, and no other express or implied warranties shall be made (including the implied warranties of merchant ability, particular and applicable reason- ableness and adaptability, etc.) whether in the contract, civil negligence, or other aspects, the Company shall not be responsible for any special, incidental or consequential damages.

# USER MANUAL

This device complies with part 15 of the FCC Rules.

Operation is subject to the following two conditions:

This device may not cause harmful interference, and this device must accept any interference received, including interference that may cause undesired operation.

Caution: Changes or modifications to this unit not expressly approved by the party responsible for compliance could void the user's authority to operate the equipment.

Note: This equipment has been tested and found to comply with the limits for a Class A digital device, pursuant to part 15 of the FCC Rules. These limits are designed to provide reasonable protection against harmful interference when the equipment is operated in a commercial environment. This equipment generates, uses, and can radiate radio frequency energy and, if not installed and used in accordance with the instruction manual, may cause harmful interference to radio communications. Operation of this equipment in a residential area is likely to cause harmful interference in which case the user will be required to correct the interference at his own expense.

LTE module : Contians FCC ID: XMR201909EC25AFX

WiFi module : Contians FCC ID: 2AC7Z-ESPWROOM32D

To satisfy FCC RF exposure requirements, a separation distance of 20cm or more should be maintained between the antenna of this device and persons during device operation. To ensure compliance, operations at closer than this distance is not recommended.

ISED Regulatory Compliance

This device contains licence-exempt transmitter(s)/receiver(s) that comply with Innovation, Science and Economic Development Canada's licence-exempt RSS(s). Operation is subject to the following two conditions:

(1) This device may not cause interference.

(2) This device must accept any interference, including interference that may cause undesired operation of the device.

L' émetteur/récepteur exempt de licence contenu dans le présent appareil est conforme aux CNR d' Innovation, Sciences et Développement économique Canada applicables aux appareils radio exempts de licence. L' exploitation est autorisée aux deux conditions suivantes :

1) L' appareil ne doit pas produire de brouillage;

2) L' appareil doit accepter tout brouillage radioélectrique subi, même si le brouillage est susceptible d' en compromettre le fonctionnement.

This equipment complies with IC RSS 102 radiation exposure limits set forth for an uncontrolled environment.

This equipment should be installed and operated with minimum distance 20cm between the radiator and your body.

Cet équipement est conforme aux limites d' exposition aux radiations IC CNR 102 établies pour un environnement non contrôlé. Cet équipement doit être installé et utilisé avec une distance minimale de 20cm

entre le radiateur et votre corps.

