

# FCC Radio Test Report

**FCC ID: UFOOPN4200I**

**Report No.** : BTL-FCCP-1-2107T062  
**Equipment** : Handheld Bluetooth 1D CCD Scanner  
**Model Name** : OPN-4200i  
**Brand Name** : OPTICON  
**Applicant** : OPTOELECTRONICS Co., Ltd.  
**Address** : 4-12-17, Tsukagoshi, Warabi-shi, Saitama Pref., 335-0002 Japan  
**Manufacturer** : OPTOELECTRONICS Co., Ltd.  
**Address** : 4-12-17, Tsukagoshi, Warabi-shi, Saitama Pref., 335-0002 Japan

**Radio Function** : Bluetooth EDR

**FCC Rule Part(s)** : FCC Part15, Subpart C (15.247)  
**Measurement Procedure(s)** : ANSI C63.10-2013

**Date of Receipt** : 2014/5/6  
2021/7/16

**Date of Test** : 2014/5/6~ 2014/9/19  
2021/7/16~ 2021/10/13

**Issued Date** : 2021/12/9

The above equipment has been tested and found in compliance with the requirement of the above standards by BTL Inc.

**Prepared by**

  
Jerry Chuang, Supervisor

**Approved by**

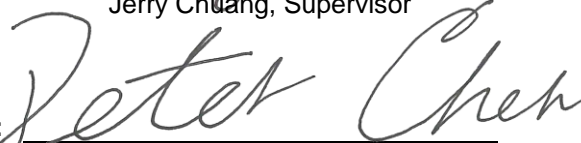
  
Peter Chen, Vice Manager

**BTL Inc.**

No.18, Ln. 171, Sec. 2, Jiuzong Rd., Neihu Dist., Taipei City 114, Taiwan

Tel: +886-2-2657-3299

Fax: +886-2-2657-3331

Web: www.newbtl.com

**Declaration**

**BTL** represents to the client that testing is done in accordance with standard procedures as applicable and that test instruments used has been calibrated with standards traceable to international standard(s) and/or national standard(s).

**BTL's** reports apply only to the specific samples tested under conditions. It is manufacture's responsibility to ensure that additional production units of this model are manufactured with the identical electrical and mechanical components. **BTL** shall have no liability for any declarations, inferences or generalizations drawn by the client or others from **BTL** issued reports.

This report is the confidential property of the client. As a mutual protection to the clients, the public and ourselves, the test report shall not be reproduced, except in full, without our written approval.

**BTL's** laboratory quality assurance procedures are in compliance with the **ISO/IEC 17025** requirements, and accredited by the conformity assessment authorities listed in this test report.

**BTL** is not responsible for the sampling stage, so the results only apply to the sample as received.

The information, data and test plan are provided by manufacturer which may affect the validity of results, so it is manufacturer's responsibility to ensure that the apparatus meets the essential requirements of applied standards and in all the possible configurations as representative of its intended use.

**Limitation**

For the use of the authority's logo is limited unless the Test Standard(s)/Scope(s)/Item(s) mentioned in this test report is (are) included in the conformity assessment authorities acceptance respective.

Please note that the measurement uncertainty is provided for informational purpose only and are not use in determining the Pass/Fail results.

**CONTENTS**

REVISION HISTORY	5
1 SUMMARY OF TEST RESULTS	6
1.1 TEST FACILITY	7
1.2 MEASUREMENT UNCERTAINTY	7
1.3 TEST ENVIRONMENT CONDITIONS	8
1.4 TABLE OF PARAMETERS OF TEST SOFTWARE SETTING	8
1.5 DUTY CYCLE	9
2 GENERAL INFORMATION	10
2.1 DESCRIPTION OF EUT	10
2.2 TEST MODES	12
2.3 BLOCK DIAGRAM SHOWING THE CONFIGURATION OF SYSTEM TESTED	13
2.4 SUPPORT UNITS	13
3 AC POWER LINE CONDUCTED EMISSIONS TEST	14
3.1 LIMIT	14
3.2 TEST PROCEDURE	14
3.3 DEVIATION FROM TEST STANDARD	14
3.4 TEST SETUP	15
3.5 TEST RESULT	15
4 RADIATED EMISSIONS TEST	16
4.1 LIMIT	16
4.2 TEST PROCEDURE	17
4.3 DEVIATION FROM TEST STANDARD	17
4.4 TEST SETUP	17
4.5 EUT OPERATING CONDITIONS	18
4.6 TEST RESULT – BELOW 30 MHZ	19
4.7 TEST RESULT – 30 MHZ TO 1 GHZ	19
4.8 TEST RESULT – ABOVE 1 GHZ	19
5 NUMBER OF HOPPING CHANNEL	20
5.1 APPLIED PROCEDURES	20
5.2 TEST PROCEDURE	20
5.3 DEVIATION FROM STANDARD	20
5.4 TEST SETUP	20
5.5 EUT OPERATION CONDITIONS	20
5.6 TEST RESULTS	20
6 AVERAGE TIME OF OCCUPANCY	21
6.1 APPLIED PROCEDURES / LIMIT	21
6.2 TEST PROCEDURE	21
6.3 DEVIATION FROM STANDARD	21
6.4 TEST SETUP	21
6.5 EUT OPERATION CONDITIONS	21
6.6 TEST RESULTS	21
7 HOPPING CHANNEL SEPARATION MEASUREMENT	22
7.1 APPLIED PROCEDURES / LIMIT	22
7.2 TEST PROCEDURE	22
7.3 DEVIATION FROM STANDARD	22
7.4 TEST SETUP	22
7.5 TEST RESULTS	22

8	BANDWIDTH TEST	23
8.1	APPLIED PROCEDURES	23
8.2	TEST PROCEDURE	23
8.3	DEVIATION FROM STANDARD	23
8.4	TEST SETUP	23
8.5	EUT OPERATION CONDITIONS	23
8.6	TEST RESULTS	23
9	OUTPUT POWER TEST	24
9.1	APPLIED PROCEDURES / LIMIT	24
9.2	TEST PROCEDURE	24
9.3	DEVIATION FROM STANDARD	24
9.4	TEST SETUP	24
9.5	EUT OPERATION CONDITIONS	24
9.6	TEST RESULTS	24
10	ANTENNA CONDUCTED SPURIOUS EMISSION	25
10.1	APPLIED PROCEDURES / LIMIT	25
10.2	TEST PROCEDURE	25
10.3	DEVIATION FROM STANDARD	25
10.4	TEST SETUP	25
10.5	EUT OPERATION CONDITIONS	25
10.6	TEST RESULTS	25
11	LIST OF MEASURING EQUIPMENTS	26
12	EUT TEST PHOTO	28
13	EUT PHOTOS	28
APPENDIX A	AC POWER LINE CONDUCTED EMISSIONS	29
APPENDIX B	RADIATED EMISSIONS - 30 MHZ TO 1 GHZ	34
APPENDIX C	RADIATED EMISSIONS - ABOVE 1 GHZ	37
APPENDIX D	NUMBER OF HOPPING CHANNEL	54
APPENDIX E	AVERAGE TIME OF OCCUPANCY	56
APPENDIX F	HOPPING CHANNEL SEPARATION MEASUREMENT	59
APPENDIX G	BANDWIDTH	62
APPENDIX H	OUTPUT POWER	65
APPENDIX I	ANTENNA CONDUCTED SPURIOUS EMISSION	67

**REVISION HISTORY**

Report No.	Version	Description	Issued Date
BTL-FCCP-1-2107T062	R00	Original Report.	2021/12/9

## 1 SUMMARY OF TEST RESULTS

Test procedures according to the technical standards.

FCC Part 15, Subpart C (15.247)				
Standard(s) Section	Description	Test Result	Judgement	Remark
15.207	AC Power Line Conducted Emissions	APPENDIX A	Pass	-----
15.205 15.209 15.247(d)	Radiated Emissions	APPENDIX B APPENDIX C	Pass	-----
15.247 (a)(1)(iii)	Number of Hopping Frequency	APPENDIX D	Pass	-----
15.247 (a)(1)(iii)	Average Time of Occupancy	APPENDIX E	Pass	-----
15.247 (a)(1)	Hopping Channel Separation	APPENDIX F	Pass	-----
15.247 (a)(1)	Bandwidth	APPENDIX G	Pass	-----
15.247 (b)(1)	Output Power	APPENDIX H	Pass	-----
15.247(d)	Antenna conducted Spurious Emission	APPENDIX I	Pass	-----
15.203	Antenna Requirement	-----	Pass	-----

**NOTE:**

- (1) "N/A" denotes test is not applicable in this Test Report.
- (2) The report format version is TP.1.1.1.

### 1.1 TEST FACILITY

The test facilities used to collect the test data in this report:

No. 68-1, Ln. 169, Sec. 2, Datong Rd., Xizhi Dist., New Taipei City 221, Taiwan

The test sites and facilities are covered under FCC RN: 674415 and DN: TW0659.

- C05       CB08       CB11       CB15       CB16  
 SR05

### 1.2 MEASUREMENT UNCERTAINTY

The reported uncertainty of measurement  $y \pm U$ , where expanded uncertainty  $U$  is based on a standard uncertainty multiplied by a coverage factor of  $k = 2$ , providing a level of confidence of approximately **95 %**. The measurement instrumentation uncertainty considerations contained in CISPR 16-4-2. The BTL measurement uncertainty is less than the CISPR 16-4-2  $U_{\text{CISPR}}$  requirement.

#### A. AC power line conducted emissions test:

Test Site	Method	Measurement Frequency Range	U (dB)
C05	CISPR	150 kHz ~ 30 MHz	3.44

#### B. Radiated emissions test :

Test Site	Measurement Frequency Range	U,(dB)
CB15	0.03 GHz ~ 0.2 GHz	4.17
	0.2 GHz ~ 1 GHz	4.72
	1 GHz ~ 6 GHz	5.21
	6 GHz ~ 18 GHz	5.51
	18 GHz ~ 26 GHz	3.69
	26 GHz ~ 40 GHz	4.23

#### C. Conducted test :

Test Item	U,(dB)
Occupied Bandwidth	0.5338
Output power	0.3659
Conducted Spurious emissions	0.5416
Conducted Band edges	0.5348
Dwell time	0.6606
Channel separation	0.6606
Channel numbers	0.6606

#### NOTE:

Unless specifically mentioned, the uncertainty of measurement has not been taken into account to declare the compliance or non-compliance to the specification.

**1.3 TEST ENVIRONMENT CONDITIONS**

Test Item	Environment Condition	Test Voltage	Tested by
AC Power Line Conducted Emissions	23 °C, 55 %	AC120V	Tim Lee
Radiated emissions below 1 GHz	25 °C, 60 %	AC120V	Vincent Lee
Radiated emissions above 1 GHz	25 °C, 60 %	AC120V	Vincent Lee
Number of Hopping Frequency	26 °C, 53 %	AC120V	Josh Lin
Average Time of Occupancy	26 °C, 53 %	AC120V	Josh Lin
Hopping Channel Separation	26 °C, 53 %	AC120V	Josh Lin
Bandwidth	26 °C, 53 %	AC120V	Josh Lin
Output Power	23 °C, 45 %	AC120V	Tim Lee
Antenna conducted Spurious Emission	26 °C, 53 %	AC120V	Josh Lin

**1.4 TABLE OF PARAMETERS OF TEST SOFTWARE SETTING**

Test Software	CMD			
	2402 MHz	2441 MHz	2480 MHz	Data Rate
GFSK	max	max	max	1 Mbps
$\pi/4$ -DQPSK	max	max	max	2 Mbps
8DPSK	max	max	max	3 Mbps



## 1.5 DUTY CYCLE

If duty cycle is  $\geq 98\%$ , duty factor is not required.  
 If duty cycle is  $< 98\%$ , duty factor shall be considered.

Remark	Delta 1			Delta 2	On Time/Period	10 log(1/Duty Cycle)
Mode	ON (ms)	Numbers (ON)	On Time (B) (ms)	Period (ON+OFF) (ms)	Duty Cycle (%)	Duty Factor (dB)
BT (1 Mbps)	3.007	1	3.007	3.767	79.82%	0.98
BT (3 Mbps)	3.040	1	3.040	3.760	80.85%	0.92

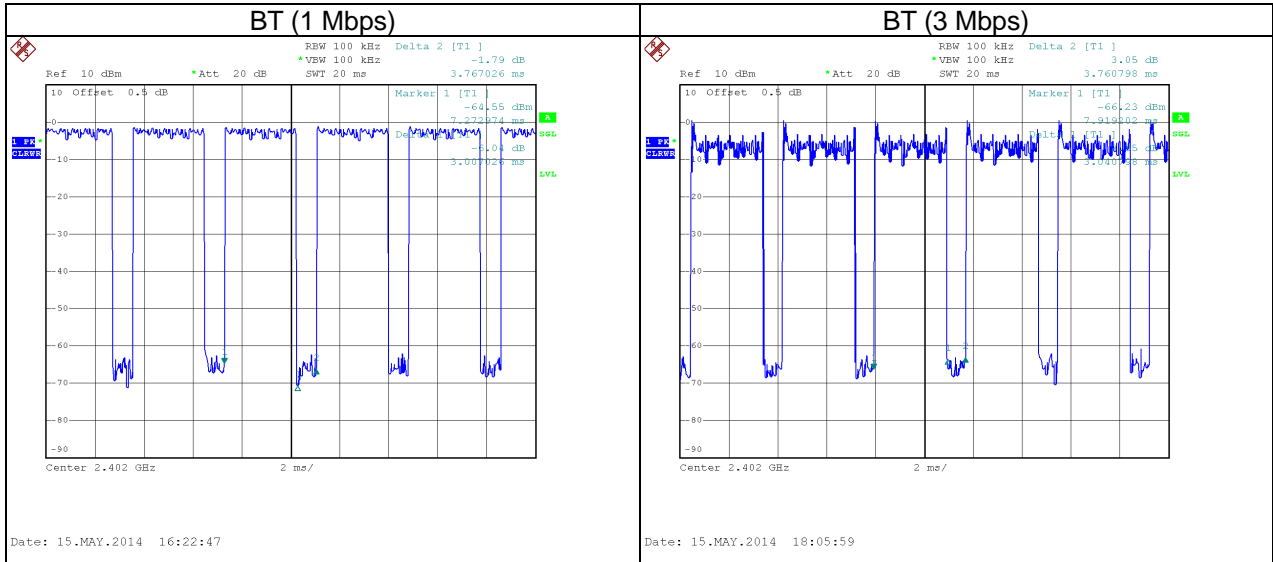

## 2 GENERAL INFORMATION

### 2.1 DESCRIPTION OF EUT

Equipment	Handheld Bluetooth 1D CCD Scanner
Model Name	OPN-4200i
Brand Name	OPTICON
Model Difference	N/A
Power Source	#1 DC Voltage supplied from AC/DC adapter via charger. #2 Supplied from battery.
Power Rating	#1 I/P: 100-240V~ 50/60Hz 0.5A / O/P: 6.0V--- 2.0A 12.0W #2 3.7V--- 1100mAh 4.1Wh
Products Covered	1 * Adapter: OPTICON / S018BAM0600200 1 * Charger: OPTICON / CHG-3201 1 * Battery: OPTICON / OPR33015505-0-02
Operation Band	2400 MHz ~ 2483.5 MHz
Operation Frequency	2402 MHz ~ 2480 MHz
Modulation Type	GFSK, $\pi/4$ -DQPSK, 8DPSK
Modulation Technology	FHSS
Transfer Rate	1 Mbps, 2 Mbps, 3Mbps
Output Power Max.	1 Mbps: -1.04 dBm (0.0008 W) 2 Mbps: -1.66 dBm (0.0007 W) 3 Mbps: -1.54 dBm (0.0007 W)
Test Model	OPN-4200i
Sample Status	Engineering Sample
EUT Modification(s)	N/A

**NOTE:**

- (1) For a more detailed features description, please refer to the manufacturer's specifications or the user's manual.
- (2) This is a supplement report of BTL-FCCP-1-1405026 report. The differences compared with original report are changed antenna, battery, equipment name and adapter.  
After evaluated, the changes with respect to the original one, only AC power line conducted emissions , radiated emissions and output power tests need to be verified.

## (3) Channel List:

Channel	Frequency (MHz)	Channel	Frequency (MHz)	Channel	Frequency (MHz)
00	2402	27	2429	54	2456
01	2403	28	2430	55	2457
02	2404	29	2431	56	2458
03	2405	30	2432	57	2459
04	2406	31	2433	58	2460
05	2407	32	2434	59	2461
06	2408	33	2435	60	2462
07	2409	34	2436	61	2463
08	2410	35	2437	62	2464
09	2411	36	2438	63	2465
10	2412	37	2439	64	2466
11	2413	38	2440	65	2467
12	2414	39	2441	66	2468
13	2415	40	2442	67	2469
14	2416	41	2443	68	2470
15	2417	42	2444	69	2471
16	2418	43	2445	70	2472
17	2419	44	2446	71	2473
18	2420	45	2447	72	2474
19	2421	46	2448	73	2475
20	2422	47	2449	74	2476
21	2423	48	2450	75	2477
22	2424	49	2451	76	2478
23	2425	50	2452	77	2479
24	2426	51	2453	78	2480
25	2427	52	2454		
26	2428	53	2455		

## (4) Table for Filed Antenna:

Ant.	Brand	Model Name	Antenna Type	Connector	Gain (dBi)
1	OPTOELECTRO NICS CO., LTD.	2.4G PCB Antenna	PCB Layout	N/A	-0.86

**2.2 TEST MODES**

Test Items	Test mode	Channel	Note
AC power line conducted emissions	Normal/Idle	-	-
Transmitter Radiated Emissions (below 1GHz)	1 Mbps	78	-
Transmitter Radiated Emissions (above 1GHz)	1/3 Mbps	00/78	Bandedge
	1/3 Mbps	00/39/78	Harmonic
Number of Hopping Frequency	1/3 Mbps	00~78	-
Average Time of Occupancy	1/3 Mbps	00/39/78	-
Hopping Channel Separation	1/3 Mbps	00/39/78	-
Bandwidth	1/3 Mbps	00/39/78	-
Peak Output Power	1/2/3 Mbps	00/39/78	-
Antenna conducted Spurious Emission	1/3 Mbps	00/39/78	-

**NOTE:**

- (1) For radiated emission band edge test, both Vertical and Horizontal are evaluated, but only the worst case (Horizontal) is recorded.
- (2) All X, Y and Z axes are evaluated, but only the worst case (X axis) is recorded.

### 2.3 BLOCK DIAGRAM SHOWING THE CONFIGURATION OF SYSTEM TESTED

Equipment letters and Cable numbers refer to item numbers described in the tables of clause 2.4.

AC power line conducted emissions

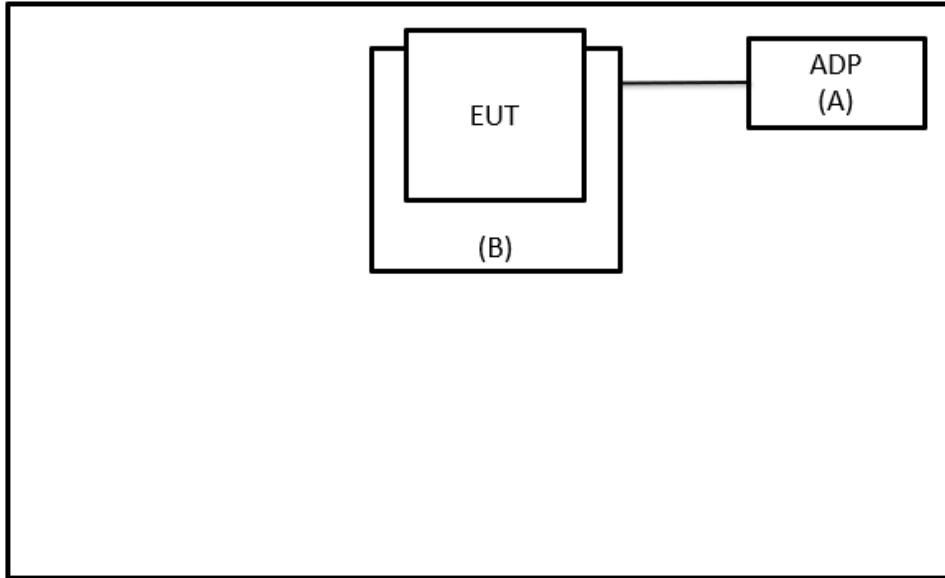

Radiated Emissions

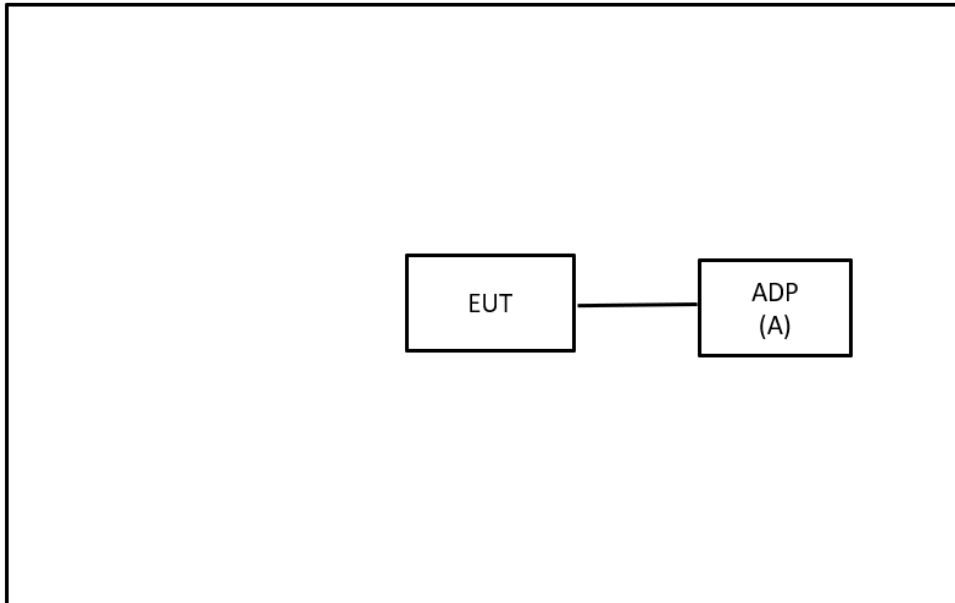

### 2.4 SUPPORT UNITS

Item	Equipment	Brand	Model No.	Series No.	Remarks
A	Adapter	OTPICON	S018BAM060020 0	N/A	Supplied by test requester
B	CHARGER	OTPICON	CHG-3201	N/A	Supplied by test requester

Item	Shielded	Ferrite Core	Length	Cable Type	Remarks
-	-	-	-	-	-

### 3 AC POWER LINE CONDUCTED EMISSIONS TEST

#### 3.1 LIMIT

Frequency (MHz)	Limit (dB $\mu$ V)	
	Quasi-peak	Average
0.15 - 0.5	66 - 56 *	56 - 46 *
0.50 - 5.0	56	46
5.0 - 30.0	60	50

**NOTE:**

- (1) The tighter limit applies at the band edges.
- (2) The limit of " \* " marked band means the limitation decreases linearly with the logarithm of the frequency in the range.
- (3) The test result calculated as following:  
 Measurement Value = Reading Level + Correct Factor  
 Correct Factor = Insertion Loss + Cable Loss + Attenuator Factor (if use)  
 Margin Level = Measurement Value – Limit Value  
 Calculation example:

Reading Level		Correct Factor		Measurement Value
38.22	+	3.45	=	41.67

Measurement Value		Limit Value		Margin Level
41.67	-	60	=	-18.33

The following table is the setting of the receiver.

Receiver Parameter	Setting
Attenuation	10 dB
Start Frequency	0.15 MHz
Stop Frequency	30 MHz
IF Bandwidth	9 KHz

#### 3.2 TEST PROCEDURE

- a. The EUT was placed 0.8 m above the horizontal ground plane with the EUT being connected to the power mains through a line impedance stabilization network (LISN).  
 All other support equipment were powered from an additional LISN(s).  
 The LISN provides 50 Ohm/50uH of impedance for the measuring instrument.
- b. Interconnecting cables that hang closer than 40 cm to the ground plane shall be folded back and forth in the center forming a bundle to keep the cable above 40 cm.
- c. Excess I/O cables that are not connected to a peripheral shall be bundled in the center.  
 The end of the cable will be terminated, using the correct terminating impedance.  
 The overall length shall not exceed 1 m.
- d. The LISN is spaced at least 80 cm from the nearest part of the EUT chassis.
- e. For the actual test configuration, please refer to the related Item - EUT TEST PHOTO.

**NOTE:**

- (1) In the results, each reading is marked as Peak, QP or AVG per the detector used.  
 BW=9 kHz (6 dB Bandwidth)
- (2) All readings are Peak unless otherwise stated QP or AVG in column of Note. Both the QP and the AVG readings must be less than the limit for compliance.

#### 3.3 DEVIATION FROM TEST STANDARD

No deviation.

### 3.4 TEST SETUP

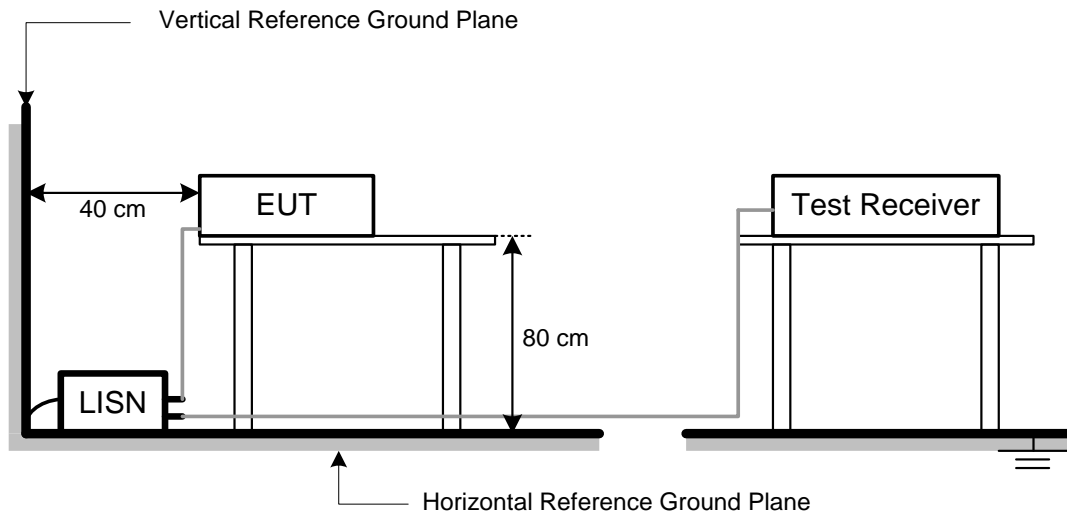

### 3.5 TEST RESULT

Please refer to the APPENDIX A.

## 4 RADIATED EMISSIONS TEST

### 4.1 LIMIT

In case the emission fall within the restricted band specified on 15.205, then the 15.209 limit in the table below has to be followed.

#### LIMITS OF RADIATED EMISSIONS MEASUREMENT (9 kHz to 1000 MHz)

Frequency (MHz)	Field Strength (microvolts/meter)	Measurement Distance (meters)
0.009~0.490	2400/F(KHz)	300
0.490~1.705	24000/F(KHz)	30
1.705~30.0	30	30
30~88	100	3
88~216	150	3
216~960	200	3
960~1000	500	3

#### LIMITS OF RADIATED EMISSIONS MEASUREMENT (Above 1000 MHz)

Frequency (MHz)	Radiated Emissions (dBuV/m)		Measurement Distance (meters)
	Peak	Average	
Above 1000	74	54	3

#### NOTE:

- (1) The limit for radiated test was performed according to FCC Part 15, Subpart C.
- (2) The tighter limit applies at the band edges.
- (3) Emission level (dBuV/m)=20log Emission level (uV/m).
- (4) The test result calculated as following:

Measurement Value = Reading Level + Correct Factor

Correct Factor = Antenna Factor + Cable Loss - Amplifier Gain(if use)

Margin Level = Measurement Value - Limit Value

Calculation example:

Reading Level		Correct Factor		Measurement Value
35.45	+	-11.37	=	24.08

Measurement Value		Limit Value		Margin Level
24.08	-	40	=	-15.92

Spectrum Parameter	Setting
Attenuation	Auto
Start Frequency	1000 MHz
Stop Frequency	10th carrier harmonic
RBW / VBW (Emission in restricted band)	1MHz / 3MHz for Peak, 1MHz / 1/T for Average

Spectrum Parameter	Setting
Attenuation	Auto
Start ~ Stop Frequency	9KHz~90KHz for PK/AVG detector
Start ~ Stop Frequency	90KHz~110KHz for QP detector
Start ~ Stop Frequency	110KHz~490KHz for PK/AVG detector
Start ~ Stop Frequency	490KHz~30MHz for QP detector
Start ~ Stop Frequency	30MHz~1000MHz for QP detector



**4.2 TEST PROCEDURE**

- a. The measuring distance of 3 m shall be used for measurements. The EUT was placed on the top of a rotating table 0.8 meter above the ground at a 3 meter semi-anechoic chamber. The table was rotated 360 degrees to determine the position of the highest radiation.(below 1GHz)
- b. The measuring distance of 3 m shall be used for measurements. The EUT was placed on the top of a rotating table 1.5 meter above the ground at a 3 meter semi-anechoic chamber. The table was rotated 360 degrees to determine the position of the highest radiation.(above 1GHz)
- c. The height of the equipment or of the substitution antenna shall be 0.8 m or 1.5 m, the height of the test antenna shall vary between 1 m to 4 m. Both horizontal and vertical polarizations of the antenna are set to make the measurement.
- d. For each suspected emission, the EUT was arranged to its worst case and then the antenna was tuned to heights find the maximum reading (used Bore sight function).
- e. The receiver system was set to peak and average detect function and specified bandwidth with maximum hold mode when the test frequency is above 1GHz.
- f. The initial step in collecting radiated emission data is a receiver peak detector mode pre-scanning the measurement frequency range. Significant peaks are then marked and then Quasi Peak detector mode re-measured.
- g. All readings are Peak unless otherwise stated QP in column of Note. Peak denotes that the Peak reading compliance with the QP Limits and then QP Mode measurement didn't perform. (below 1GHz)
- h. All readings are Peak Mode value unless otherwise stated AVG in column of Note. If the Peak Mode Measured value compliance with the Peak Limits and lower than AVG Limits, the EUT shall be deemed to meet both Peak & AVG Limits and then only Peak Mode was measured, but AVG Mode didn't perform. (above 1GHz)
- i. For the actual test configuration, please refer to the related Item – EUT TEST PHOTO.

**4.3 DEVIATION FROM TEST STANDARD**

No deviation.

**4.4 TEST SETUP**

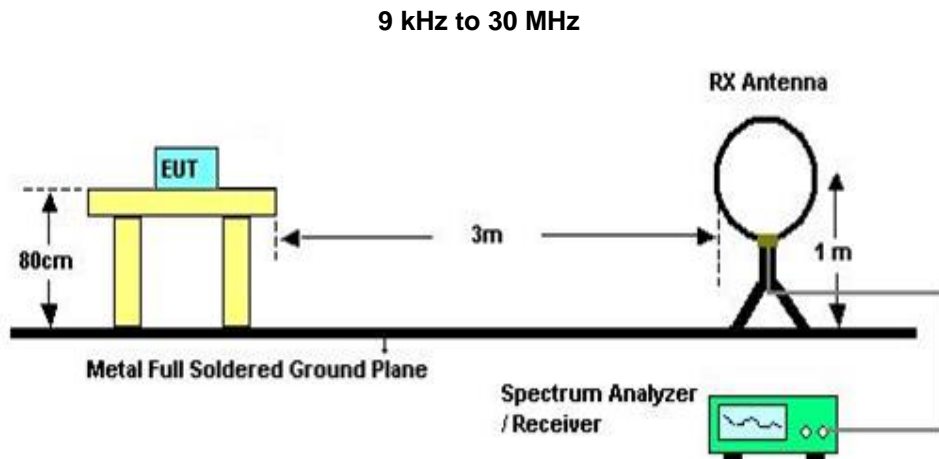

**30 MHz to 1 GHz**

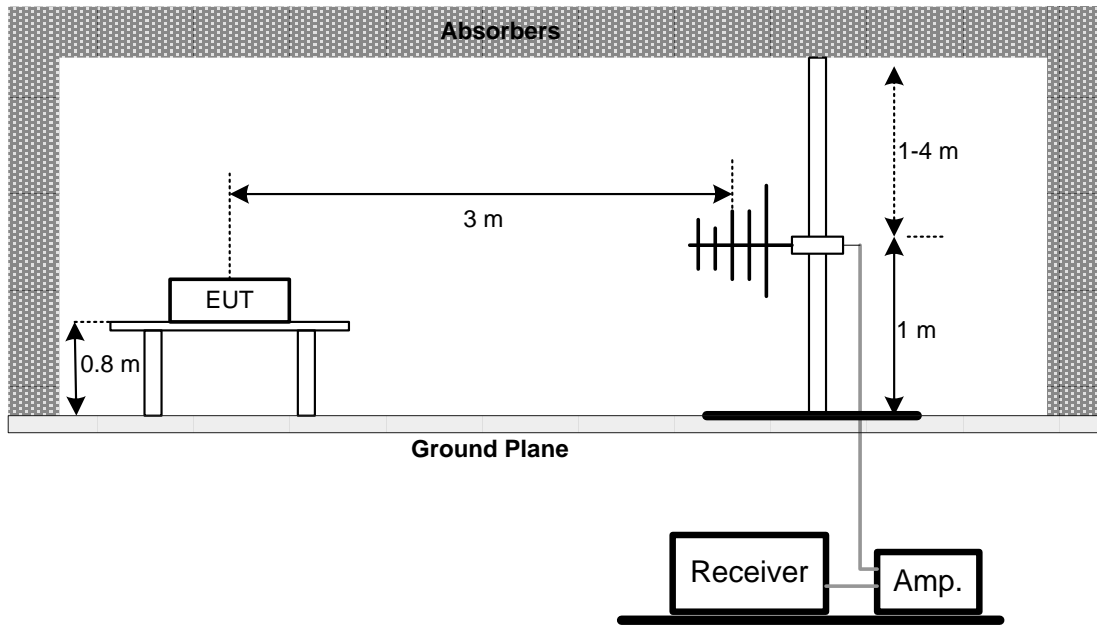

**Above 1 GHz**

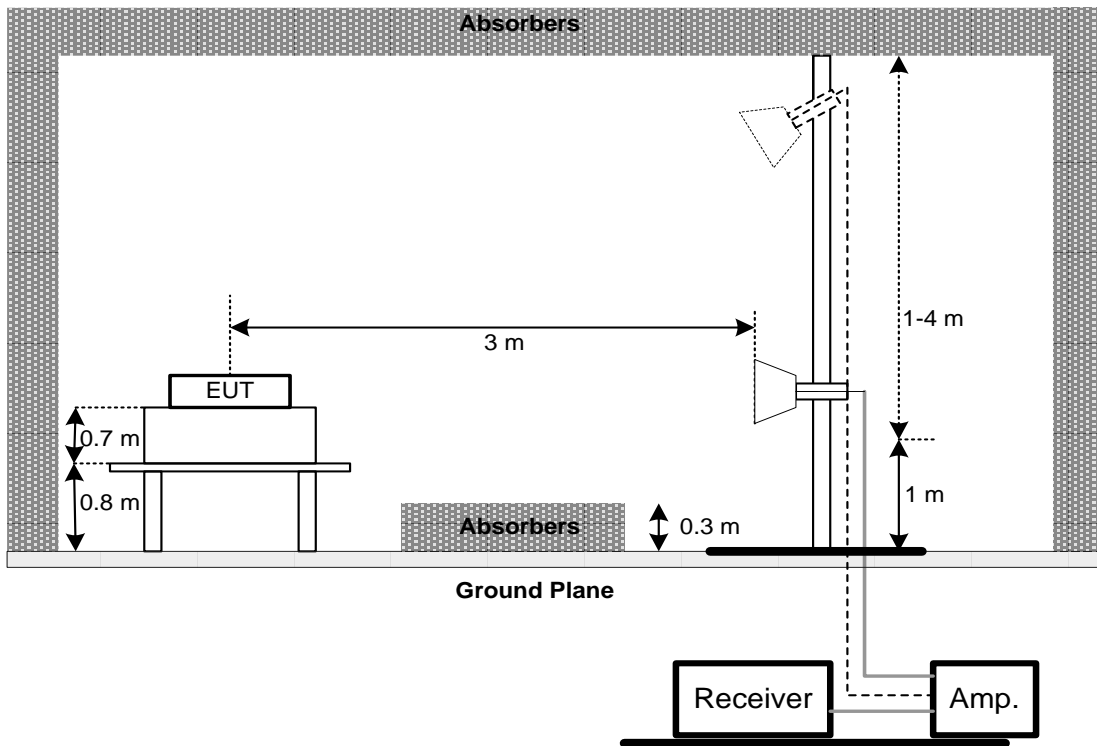

**4.5 EUT OPERATING CONDITIONS**

The EUT was programmed to be in continuously transmitting mode.

**4.6 TEST RESULT – BELOW 30 MHZ**

There were no emissions found below 30 MHz within 20 dB of the limit.

**4.7 TEST RESULT – 30 MHZ TO 1 GHZ**

Please refer to the APPENDIX B.

**4.8 TEST RESULT – ABOVE 1 GHZ**

Please refer to the APPENDIX C.

**NOTE:**

- (1) No limit: This is fundamental signal, the judgment is not applicable.  
For fundamental signal judgment was referred to Peak output test.

## 5 NUMBER OF HOPPING CHANNEL

### 5.1 APPLIED PROCEDURES

FCC Part15 (15.247) , Subpart C			
Section	Test Item	Frequency Range (MHz)	Result
15.247(a)(1)(iii)	Number of Hopping Channel	2400-2483.5	PASS

Spectrum Parameters	Setting
Attenuation	Auto
Span Frequency	> Operating Frequency Range
RBW	100 KHz
VBW	100 KHz
Detector	Peak
Trace	Max Hold
Sweep Time	Auto

### 5.2 TEST PROCEDURE

- a. The EUT was directly connected to the spectrum analyzer and antenna output port as show in the block diagram below,
- b. Spectrum Setting: RBW=100KHz, VBW=100KHz, Sweep time = Auto.

### 5.3 DEVIATION FROM STANDARD

No deviation.

### 5.4 TEST SETUP

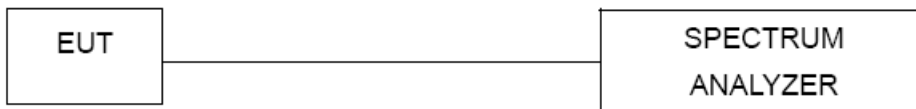

### 5.5 EUT OPERATION CONDITIONS

The EUT tested system was configured as the statements of 3.5 unless otherwise a special operating condition is specified in the follows during the testing.

### 5.6 TEST RESULTS

Please refer to the APPENDIX D.

## 6 AVERAGE TIME OF OCCUPANCY

### 6.1 APPLIED PROCEDURES / LIMIT

FCC Part15 (15.247) , Subpart C				
Section	Test Item	Limit	Frequency Range (MHz)	Result
15.247(a)(1)(iii)	Average Time of Occupancy	0.4sec	2400-2483.5	PASS

### 6.2 TEST PROCEDURE

- a. The transmitter output (antenna port) was connected to the spectrum analyzer
- b. Set RBW of spectrum analyzer to 1MHz and VBW to 1MHz.
- c. Use a video trigger with the trigger level set to enable triggering only on full pulses.
- d. Sweep Time is more than once pulse time.
- e. Set the center frequency on any frequency would be measure and set the frequency span to zero span.
- f. Measure the maximum time duration of one single pulse.
- g. Set the EUT for DH5, DH3 and DH1 packet transmitting.
- h. Measure the maximum time duration of one single pulse.
- i. Measure the maximum time duration of one single pulse.  
 $A \text{ Period Time} = (\text{channel number}) * 0.4$

For Non-AFH Mode (79 Channel):

DH1 Time Solt: Reading \* (1600/6)/79 \* (0.4 \* 79)

DH3 Time Solt: Reading \* (1600/6)/79 \* (0.4 \* 79)

DH5 Time Solt: Reading \* (1600/6)/79 \* (0.4 \* 79)

For AFH Mode (20 Channel):

DH1 Time Solt: Reading \* (800/6)/20 \* (0.4 \* 20)

DH3 Time Solt: Reading \* (800/6)/20 \* (0.4 \* 20)

DH5 Time Solt: Reading \* (800/6)/20 \* (0.4 \* 20)

### 6.3 DEVIATION FROM STANDARD

No deviation.

### 6.4 TEST SETUP



### 6.5 EUT OPERATION CONDITIONS

The EUT tested system was configured as the statements of 3.5 unless otherwise a special operating condition is specified in the follows during the testing.

### 6.6 TEST RESULTS

Please refer to the APPENDIX E.

## 7 Hopping Channel Separation Measurement

### 7.1 APPLIED PROCEDURES / LIMIT

Frequency hopping systems operating in the 2400-2483.5 MHz band may have hopping channel carrier frequencies that are separated by 25 KHz or two-thirds of the 20 dB bandwidth of the hopping channel, whichever is greater.

Spectrum Parameter	Setting
Attenuation	Auto
Span Frequency	> Measurement Bandwidth or Channel Separation
RBW	30 KHz
VBW	100 KHz
Detector	Peak
Trace	Max Hold
Sweep Time	Auto

### 7.2 TEST PROCEDURE

- a. The EUT must have its hopping function enabled
- b. Span = wide enough to capture the peaks of two adjacent channels  
 Resolution (or IF) Bandwidth (RBW)  $\geq$  1% of the span  
 Video (or Average) Bandwidth (VBW)  $\geq$  RBW  
 Sweep = Auto  
 Detector function = Peak  
 Trace = Max Hold

### 7.3 DEVIATION FROM STANDARD

No deviation.

### 7.4 TEST SETUP

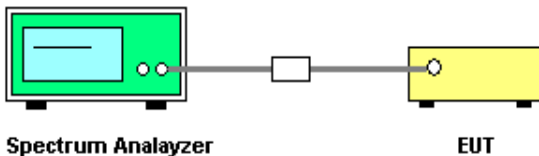

### 7.5 TEST RESULTS

Please refer to the APPENDIX F.

**8 BANDWIDTH TEST**

**8.1 APPLIED PROCEDURES**

FCC Part15 (15.247) , Subpart C		
Section	Test Item	Frequency Range (MHz)
15.247(a)(2)	Bandwidth	2400-2483.5

Spectrum Parameter	Setting
Attenuation	Auto
Span Frequency	> Measurement Bandwidth or Channel Separation
RBW	30 KHz (20dB Bandwidth) / 30 KHz (Channel Separation)
VBW	100 KHz (20dB Bandwidth) / 100 KHz (Channel Separation)
Detector	Peak
Trace	Max Hold
Sweep Time	Auto

**8.2 TEST PROCEDURE**

- a. The EUT was directly connected to the spectrum analyzer and antenna output port as show in the block diagram below,
- b. Spectrum Setting: RBW= 30KHz, VBW=100KHz, Sweep Time = Auto.

**8.3 DEVIATION FROM STANDARD**

No deviation.

**8.4 TEST SETUP**



**8.5 EUT OPERATION CONDITIONS**

The EUT tested system was configured as the statements of 3.5 unless otherwise a special operating condition is specified in the follows during the testing.

**8.6 TEST RESULTS**

Please refer to the APPENDIX G.

## 9 OUTPUT POWER TEST

### 9.1 APPLIED PROCEDURES / LIMIT

FCC Part15 (15.247) , Subpart C				
Section	Test Item	Limit	Frequency Range (MHz)	Result
15.247(b)(1)	Peak Output Power	0.125Watt or 21dBm	2400-2483.5	PASS

### 9.2 TEST PROCEDURE

- a. The EUT was directly connected to the spectrum analyzer and antenna output port as show in the block diagram below,
- b. Spectrum Setting: RBW= 3MHz, VBW= 3MHz, Sweep time = Auto.

### 9.3 DEVIATION FROM STANDARD

No deviation.

### 9.4 TEST SETUP

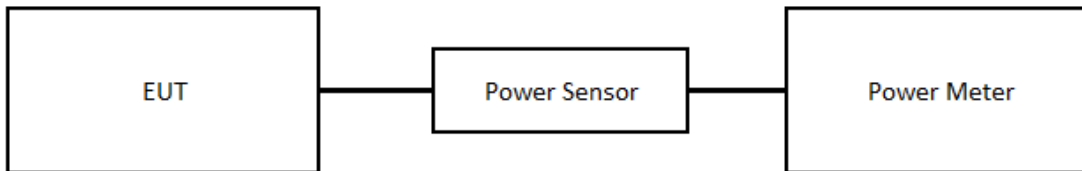

### 9.5 EUT OPERATION CONDITIONS

The EUT tested system was configured as the statements of 3.5 unless otherwise a special operating condition is specified in the follows during the testing.

### 9.6 TEST RESULTS

Please refer to the APPENDIX H.



## 10 ANTENNA CONDUCTED SPURIOUS EMISSION

### 10.1 APPLIED PROCEDURES / LIMIT

In any 100 kHz bandwidth outside the frequency band in which the spread spectrum or digitally modulated device is operating, the RF power that is produced shall be at least 20 dB below that in the 100 kHz bandwidth within the band that contains the highest level of the desired power, based on either an RF conducted or a radiated measurement, provided that the transmitter demonstrates compliance with the peak conducted power limits.

### 10.2 TEST PROCEDURE

- a. The EUT was directly connected to the spectrum analyzer and antenna output port as show in the block diagram below,
- b. Spectrum Setting: RBW= 100KHz, VBW=100KHz, Sweep time = Auto.
- c. Offset=antenna gain+cable loss

### 10.3 DEVIATION FROM STANDARD

No deviation.

### 10.4 TEST SETUP

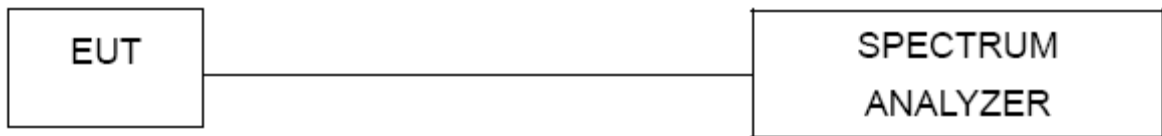

### 10.5 EUT OPERATION CONDITIONS

The EUT tested system was configured as the statements of 3.5 unless otherwise a special operating condition is specified in the follows during the testing.

### 10.6 TEST RESULTS

Please refer to the APPENDIX I.

**11 LIST OF MEASURING EQUIPMENTS**

AC Power Line Conducted Emissions						
Item	Kind of Equipment	Manufacturer	Type No.	Serial No.	Calibrated Date	Calibrated Until
1	TWO-LINE V-NETWORK	R&S	ENV216	101339	2021/3/10	2022/3/9
2	Test Cable	EMCI	EMCRG58-BM-B M-9000	210501	2021/5/3	2022/5/2
3	EMI Test Receiver	R&S	ESR 7	101433	2020/12/11	2021/12/10
4	Measurement Software	EZ	EZ EMC (Version NB-03A1-01)	N/A	N/A	N/A

Radiated Emissions						
Item	Kind of Equipment	Manufacturer	Type No.	Serial No.	Calibrated Date	Calibrated Until
1	Preamplifier	EMCI	EMC02325B	980217	2021/4/8	2022/4/7
2	Preamplifier	EMCI	EMC012645B	980267	2021/4/8	2022/4/7
3	Preamplifier	EMCI	EMC001340	980555	2021/4/8	2022/4/7
4	Test Cable	EMCI	EMC-SM-SM-1000	180809	2021/4/8	2022/4/7
5	Test Cable	EMCI	EMC104-SM-SM-3000	151205	2021/4/8	2022/4/7
6	Test Cable	EMCI	EMC-SM-SM-7000	180408	2021/4/8	2022/4/7
7	MXE EMI Receiver	Agilent	N9038A	MY554200087	2021/5/27	2022/5/26
8	Signal Analyzer	Agilent	N9010A	MY56480554	2021/8/25	2022/8/24
9	Loop Ant	Electro-Metrics	EMCI-LPA600	274	2021/6/1	2022/5/31
10	Horn Ant	SCHWARZBECK	BBHA 9120D	9120D-1342	2021/6/2	2022/6/1
11	Horn Ant	Schwarzbeck	BBHA 9170	BBHA 9170340	2021/7/9	2022/7/8
12	Trilog-Broadband Antenna	Schwarzbeck	VULB 9168	VULB 9168-352	2021/8/11	2022/8/10
13	5dB Attenuator	EMCI	EMCI-N-6-05	AT-N0625	2021/8/11	2022/8/10
14	Measurement Software	EZ	EZ EMC (Version NB-03A1-01)	N/A	N/A	N/A

Number of Hopping Frequency					
Item	Kind of Equipment	Manufacturer	Type No.	Serial No.	Calibrated Until
1	Spectrum Analyzer	R&S	FSP-30	100854	Sep. 08, 2015

Average Time of Occupancy					
Item	Kind of Equipment	Manufacturer	Type No.	Serial No.	Calibrated Until
1	Spectrum Analyzer	R&S	FSP-30	100854	Sep. 08, 2015

Hopping Channel Separation					
Item	Kind of Equipment	Manufacturer	Type No.	Serial No.	Calibrated Until
1	Spectrum Analyzer	R&S	FSP-30	100854	Sep. 08, 2015

Bandwidth					
Item	Kind of Equipment	Manufacturer	Type No.	Serial No.	Calibrated Until
1	Spectrum Analyzer	R&S	FSP-30	100854	Sep. 08, 2015

Output Power						
Item	Kind of Equipment	Manufacturer	Type No.	Serial No.	Calibrated Date	Calibrated Until
1	Power Meter	Anritsu	ML2495A	1128008	2021/5/26	2022/5/25
2	Power Sensor	Anritsu	MA2411B	1126001	2021/5/26	2022/5/25

Antenna conducted Spurious Emission					
Item	Kind of Equipment	Manufacturer	Type No.	Serial No.	Calibrated Until
1	Spectrum Analyzer	R&S	FSP-30	100854	Sep. 08, 2015

Remark: "N/A" denotes no model name, no serial no. or no calibration specified.  
 All calibration period of equipment list is one year.

**12 EUT TEST PHOTO**

Please refer to document Appendix No.: TP-2107T062-FCCP-1 (APPENDIX-TEST PHOTOS).

**13 EUT PHOTOS**

Please refer to document Appendix No.: EP-2107T062-2 (APPENDIX-EUT PHOTOS).

## **APPENDIX A AC POWER LINE CONDUCTED EMISSIONS**

Test Mode	Normal	Tested Date	2021/7/30
Test Frequency	-	Phase	Line

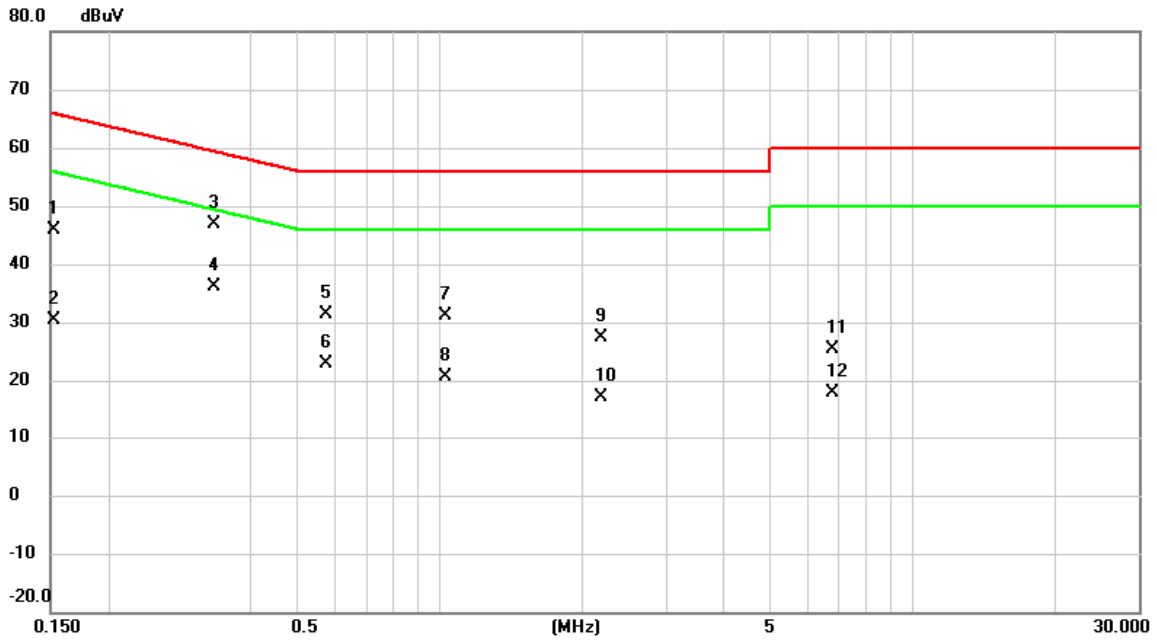

No.	Mk.	Freq.	Reading Level	Correct Factor	Measurement	Limit	Over	Detector	Comment
		MHz	dBuV	dB	dBuV	dBuV	dB		
1		0.1522	36.21	9.71	45.92	65.88	-19.96	QP	
2		0.1522	20.71	9.71	30.42	55.88	-25.46	AVG	
3	*	0.3345	37.19	9.70	46.89	59.34	-12.45	QP	
4		0.3345	26.31	9.70	36.01	49.34	-13.33	AVG	
5		0.5775	21.70	9.71	31.41	56.00	-24.59	QP	
6		0.5775	13.25	9.71	22.96	46.00	-23.04	AVG	
7		1.0275	21.36	9.72	31.08	56.00	-24.92	QP	
8		1.0275	10.80	9.72	20.52	46.00	-25.48	AVG	
9		2.1840	17.67	9.77	27.44	56.00	-28.56	QP	
10		2.1840	7.35	9.77	17.12	46.00	-28.88	AVG	
11		6.7740	15.41	10.03	25.44	60.00	-34.56	QP	
12		6.7740	7.74	10.03	17.77	50.00	-32.23	AVG	

REMARKS:  
 (1) Measurement Value = Reading Level + Correct Factor.  
 (2) Margin Level = Measurement Value - Limit Value.

Test Mode	Normal	Tested Date	2021/7/30
Test Frequency	-	Phase	Neutral

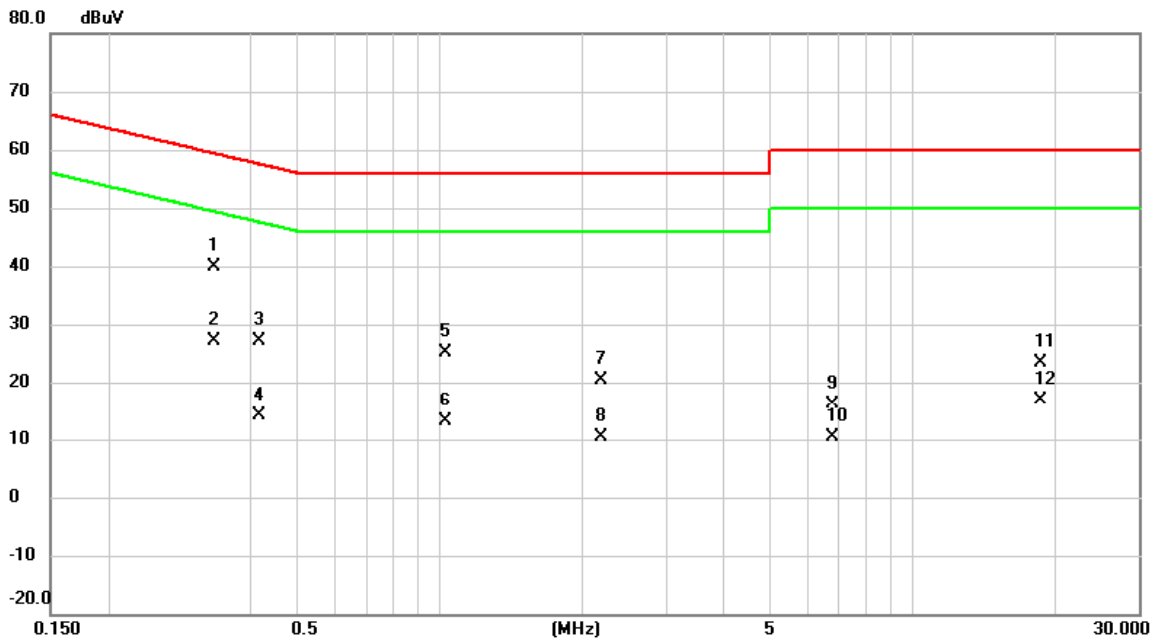

No.	Mk.	Freq. MHz	Reading Level dBuV	Correct Factor dB	Measure- ment dBuV	Limit dBuV	Over dB	Detector	Comment
1	*	0.3345	30.17	9.70	39.87	59.34	-19.47	QP	
2		0.3345	17.51	9.70	27.21	49.34	-22.13	AVG	
3		0.4155	17.51	9.71	27.22	57.54	-30.32	QP	
4		0.4155	4.47	9.71	14.18	47.54	-33.36	AVG	
5		1.0275	15.37	9.73	25.10	56.00	-30.90	QP	
6		1.0275	3.40	9.73	13.13	46.00	-32.87	AVG	
7		2.1840	10.51	9.76	20.27	56.00	-35.73	QP	
8		2.1840	0.58	9.76	10.34	46.00	-35.66	AVG	
9		6.7740	6.19	10.04	16.23	60.00	-43.77	QP	
10		6.7740	0.31	10.04	10.35	50.00	-39.65	AVG	
11		18.6293	13.04	10.33	23.37	60.00	-36.63	QP	
12		18.6293	6.67	10.33	17.00	50.00	-33.00	AVG	

REMARKS:  
 (1) Measurement Value = Reading Level + Correct Factor.  
 (2) Margin Level = Measurement Value - Limit Value.

Test Mode	Idle	Tested Date	2021/7/30
Test Frequency	-	Phase	Line

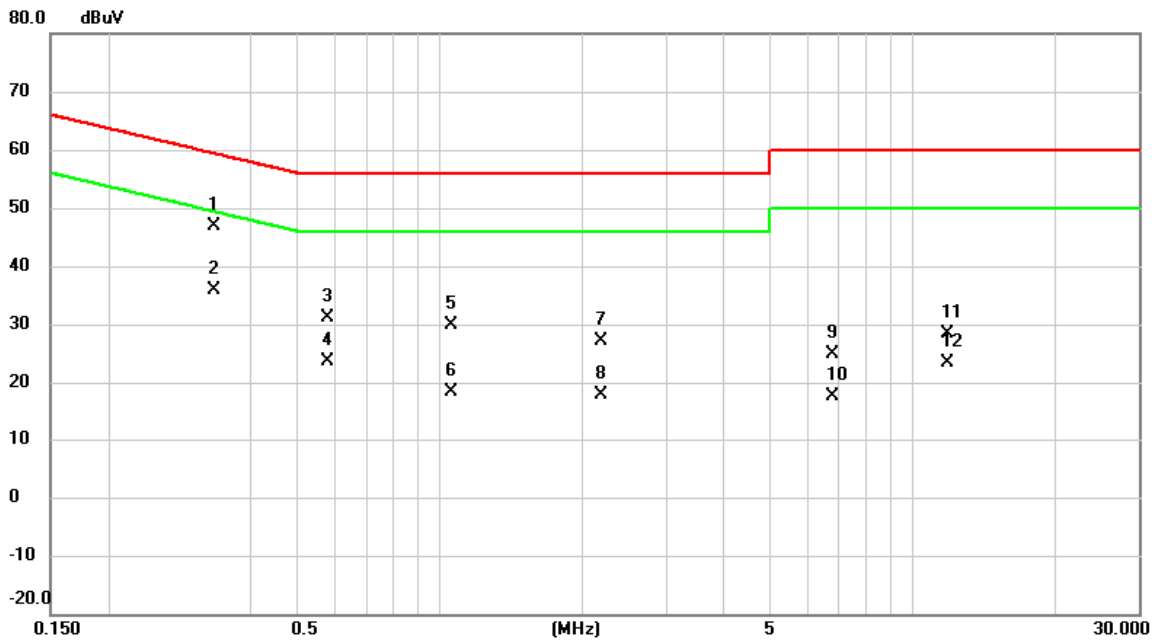

No.	Mk.	Freq. MHz	Reading Level dBuV	Correct Factor dB	Measure- ment dBuV	Limit dBuV	Over dB	Detector	Comment
1	*	0.3345	37.22	9.70	46.92	59.34	-12.42	QP	
2		0.3345	26.24	9.70	35.94	49.34	-13.40	AVG	
3		0.5797	21.33	9.71	31.04	56.00	-24.96	QP	
4		0.5797	13.96	9.71	23.67	46.00	-22.33	AVG	
5		1.0545	20.27	9.72	29.99	56.00	-26.01	QP	
6		1.0545	8.75	9.72	18.47	46.00	-27.53	AVG	
7		2.1863	17.34	9.77	27.11	56.00	-28.89	QP	
8		2.1863	8.14	9.77	17.91	46.00	-28.09	AVG	
9		6.7695	14.97	10.03	25.00	60.00	-35.00	QP	
10		6.7695	7.53	10.03	17.56	50.00	-32.44	AVG	
11		11.8478	18.28	10.16	28.44	60.00	-31.56	QP	
12		11.8478	13.17	10.16	23.33	50.00	-26.67	AVG	

REMARKS:  
 (1) Measurement Value = Reading Level + Correct Factor.  
 (2) Margin Level = Measurement Value - Limit Value.



Test Mode	Idle	Tested Date	2021/7/30
Test Frequency	-	Phase	Neutral

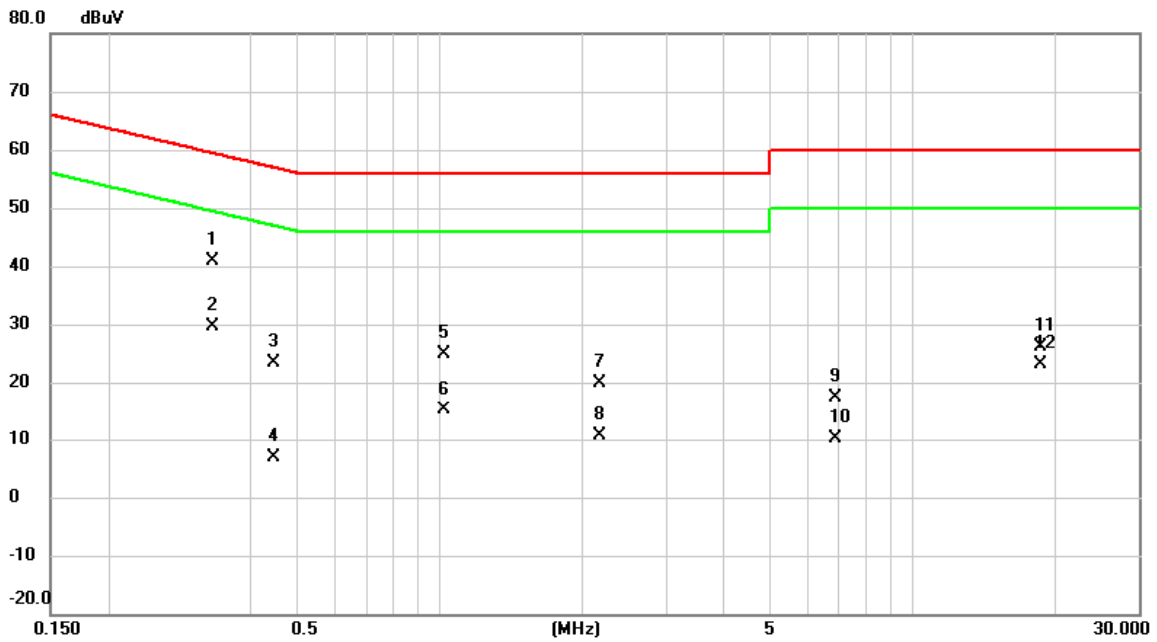

No.	Mk.	Freq. MHz	Reading Level dBuV	Correct Factor dB	Measure- ment dBuV	Limit dBuV	Over dB	Detector	Comment
1	*	0.3322	31.26	9.70	40.96	59.40	-18.44	QP	
2		0.3322	19.88	9.70	29.58	49.40	-19.82	AVG	
3		0.4470	13.69	9.71	23.40	56.93	-33.53	QP	
4		0.4470	-2.90	9.71	6.81	46.93	-40.12	AVG	
5		1.0207	15.09	9.73	24.82	56.00	-31.18	QP	
6		1.0207	5.40	9.73	15.13	46.00	-30.87	AVG	
7		2.1705	10.14	9.76	19.90	56.00	-36.10	QP	
8		2.1705	0.96	9.76	10.72	46.00	-35.28	AVG	
9		6.8708	7.40	10.04	17.44	60.00	-42.56	QP	
10		6.8708	0.11	10.04	10.15	50.00	-39.85	AVG	
11		18.6203	15.79	10.33	26.12	60.00	-33.88	QP	
12		18.6203	12.77	10.33	23.10	50.00	-26.90	AVG	

REMARKS:  
 (1) Measurement Value = Reading Level + Correct Factor.  
 (2) Margin Level = Measurement Value - Limit Value.

## **APPENDIX B RADIATED EMISSIONS - 30 MHZ TO 1 GHZ**

Test Mode	BT(1Mbps)	Test Date	2021/10/7
Test Frequency	2480MHz	Polarization	Vertical
Temp	25°C	Hum.	60%

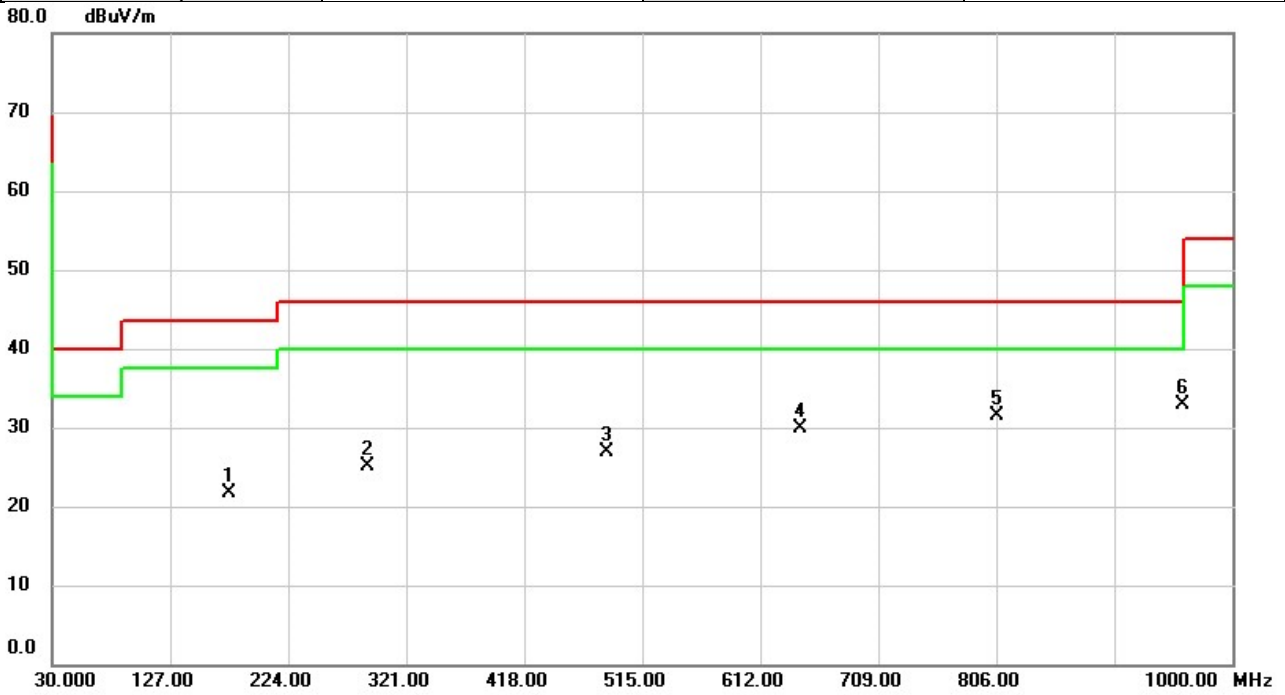

No.	Mk.	Freq.	Reading Level	Correct Factor	Measurement	Limit	Over	Detector	Comment
		MHz	dBuV	dB	dBuV/m	dBuV/m	dB		
1		175.9850	31.82	-10.03	21.79	43.50	-21.71	peak	
2		289.4103	33.55	-8.51	25.04	46.00	-20.96	peak	
3		485.5767	30.71	-3.85	26.86	46.00	-19.14	peak	
4		644.4627	30.38	-0.38	30.00	46.00	-16.00	peak	
5		806.3232	29.46	2.05	31.51	46.00	-14.49	peak	
6	*	959.3893	28.42	4.42	32.84	46.00	-13.16	peak	

**REMARKS:**

- (1) Measurement Value = Reading Level + Correct Factor.
- (2) Margin Level = Measurement Value - Limit Value.

Test Mode	BT(1Mbps)	Test Date	2021/10/7
Test Frequency	2480MHz	Polarization	Horizontal
Temp	25°C	Hum.	60%

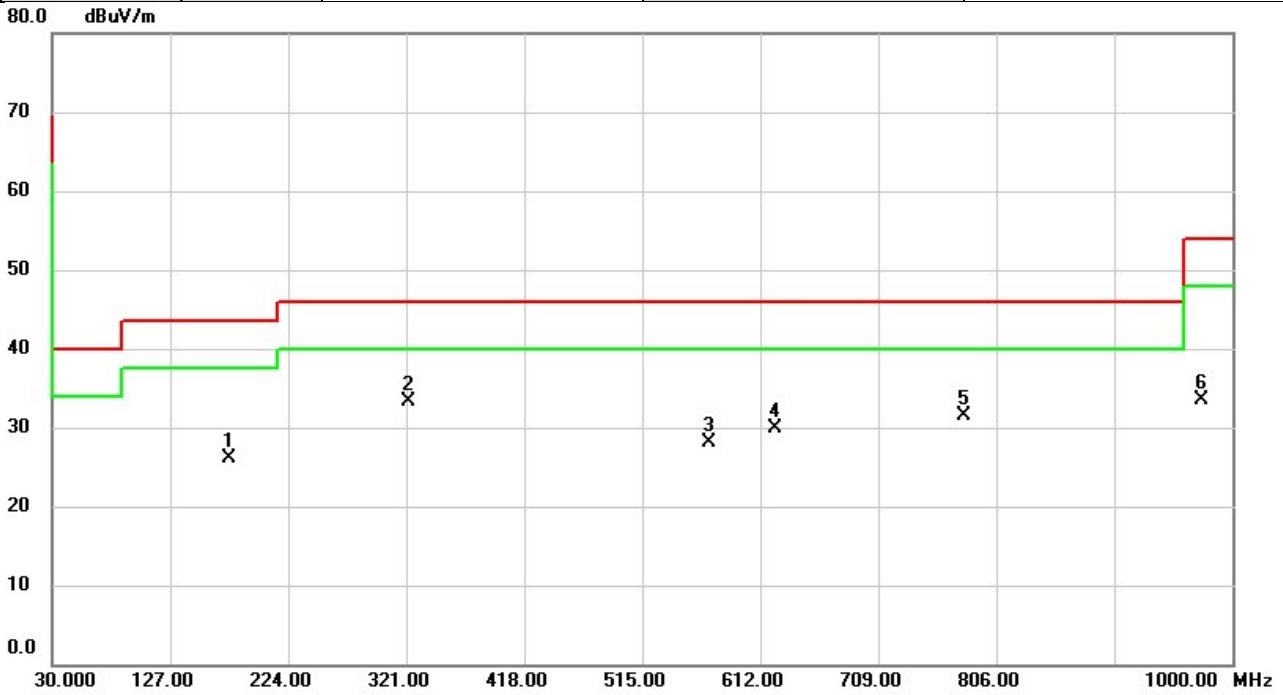

No.	Mk.	Freq. MHz	Reading Level dBuV	Correct Factor dB	Measure- ment dBuV/m	Limit dBuV/m	Over dB	Detector	Comment
1		175.9850	36.15	-10.03	26.12	43.50	-17.38	peak	
2	*	323.2633	41.14	-7.79	33.35	46.00	-12.65	peak	
3		570.2253	30.05	-2.01	28.04	46.00	-17.96	peak	
4		624.3836	30.53	-0.69	29.84	46.00	-16.16	peak	
5		778.9046	29.73	1.73	31.46	46.00	-14.54	peak	
6		974.5213	28.97	4.61	33.58	54.00	-20.42	peak	

**REMARKS:**

- (1) Measurement Value = Reading Level + Correct Factor.
- (2) Margin Level = Measurement Value - Limit Value.

## **APPENDIX C RADIATED EMISSIONS - ABOVE 1 GHZ**

Test Mode	BT(1Mbps)	Test Date	2021/10/7
Test Frequency	2402MHz	Polarization	Horizontal
Temp	25°C	Hum.	60%

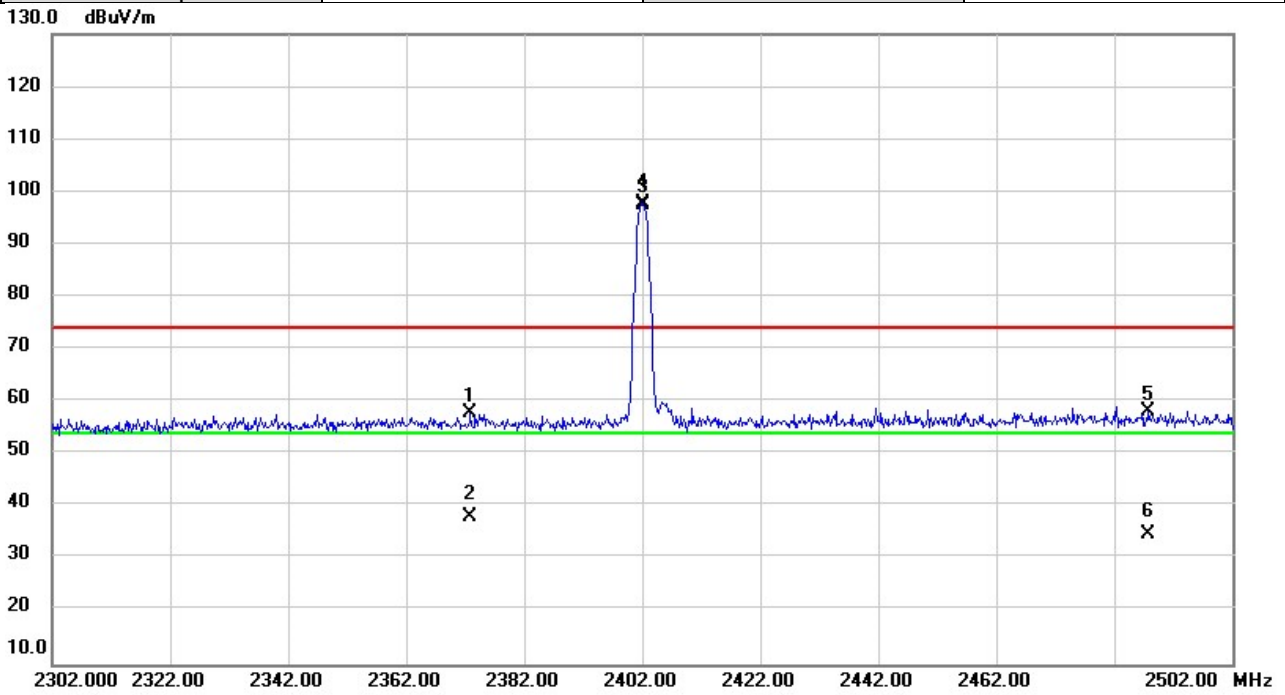

No.	Mk.	Freq.	Reading Level	Correct Factor	Measurement	Limit	Over	Detector	Comment
		MHz	dBuV	dB	dBuV/m	dBuV/m	dB		
1		2372.933	26.68	31.16	57.84	74.00	-16.16	peak	
2		2372.933	6.99	31.16	38.15	54.00	-15.85	AVG	
3	X	2402.000	66.50	31.26	97.76	74.00	23.76	peak	NoLimit
4	*	2402.000	66.05	31.26	97.31	54.00	43.31	AVG	NoLimit
5		2487.820	26.61	31.53	58.14	74.00	-15.86	peak	
6		2487.820	3.33	31.53	34.86	54.00	-19.14	AVG	

REMARKS:

- (1) Measurement Value = Reading Level + Correct Factor.
- (2) Margin Level = Measurement Value - Limit Value.

Test Mode	BT(1Mbps)	Test Date	2021/10/7
Test Frequency	2480MHz	Polarization	Horizontal
Temp	25°C	Hum.	60%

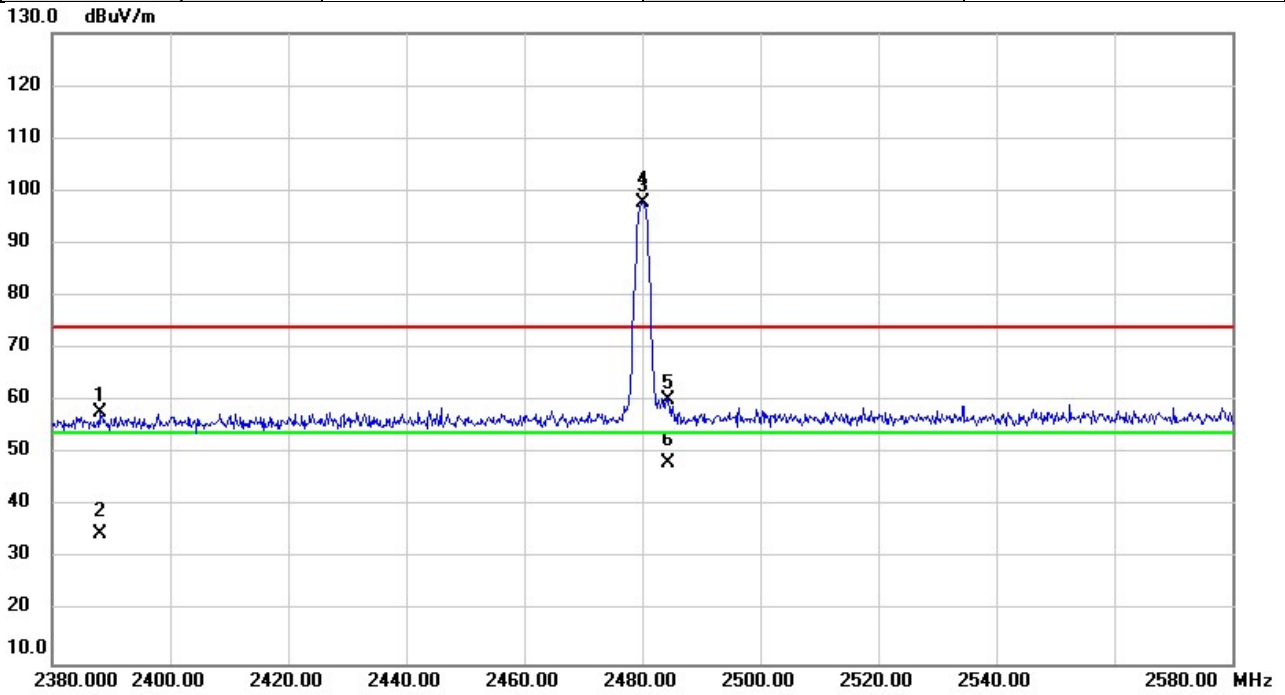

No.	Mk.	Freq.	Reading Level	Correct Factor	Measurement	Limit	Over	Detector	Comment
		MHz	dBuV	dB	dBuV/m	dBuV/m	dB		
1		2388.260	26.60	31.21	57.81	74.00	-16.19	peak	
2		2388.260	3.43	31.21	34.64	54.00	-19.36	AVG	
3	X	2480.000	66.29	31.51	97.80	74.00	23.80	peak	NoLimit
4	*	2480.000	66.12	31.51	97.63	54.00	43.63	AVG	NoLimit
5		2484.473	28.75	31.52	60.27	74.00	-13.73	peak	
6		2484.473	16.86	31.52	48.38	54.00	-5.62	AVG	

**REMARKS:**

- (1) Measurement Value = Reading Level + Correct Factor.
- (2) Margin Level = Measurement Value - Limit Value.

Test Mode	BT(3Mbps)	Test Date	2021/10/7
Test Frequency	2402MHz	Polarization	Horizontal
Temp	25°C	Hum.	60%

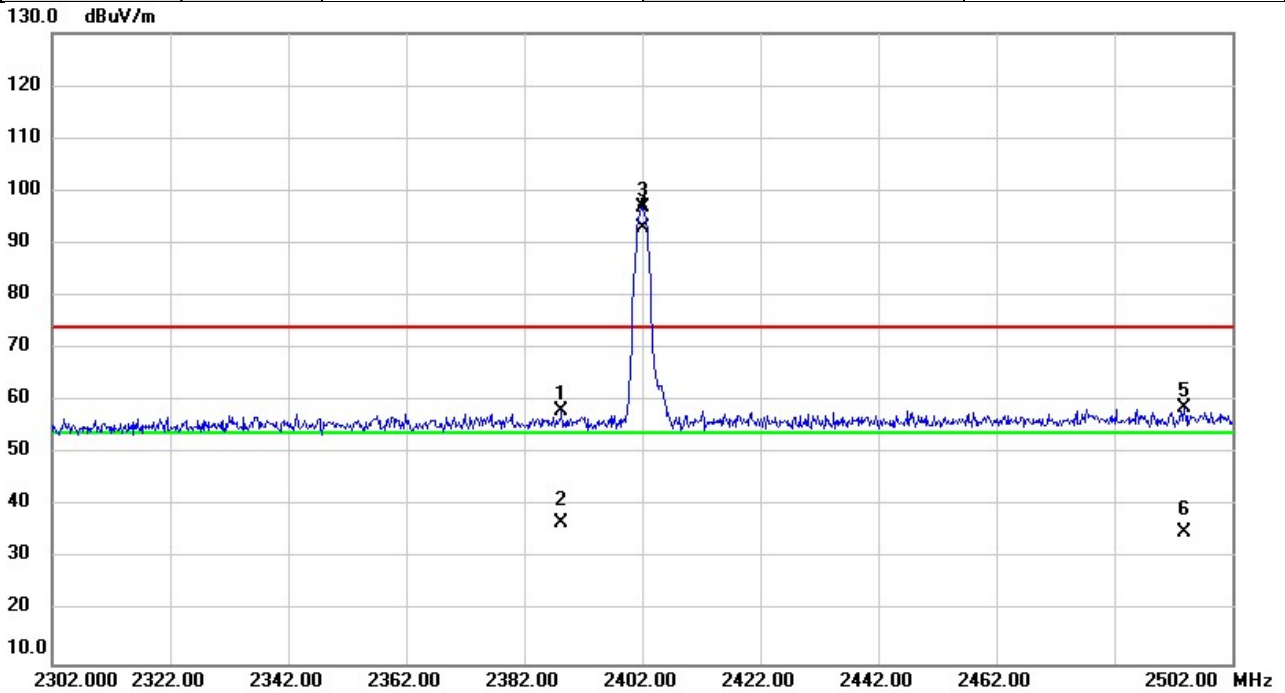

No.	Mk.	Freq.	Reading Level	Correct Factor	Measurement	Limit	Over	Detector	Comment
		MHz	dBuV	dB	dBuV/m	dBuV/m	dB		
1		2388.273	26.95	31.21	58.16	74.00	-15.84	peak	
2		2388.273	5.51	31.21	36.72	54.00	-17.28	AVG	
3	X	2402.000	65.69	31.26	96.95	74.00	22.95	peak	NoLimit
4	*	2402.000	61.80	31.26	93.06	54.00	39.06	AVG	NoLimit
5		2493.953	27.25	31.55	58.80	74.00	-15.20	peak	
6		2493.953	3.43	31.55	34.98	54.00	-19.02	AVG	

**REMARKS:**

- (1) Measurement Value = Reading Level + Correct Factor.
- (2) Margin Level = Measurement Value - Limit Value.



Test Mode	BT(3Mbps)	Test Date	2021/10/7
Test Frequency	2480MHz	Polarization	Horizontal
Temp	25°C	Hum.	60%

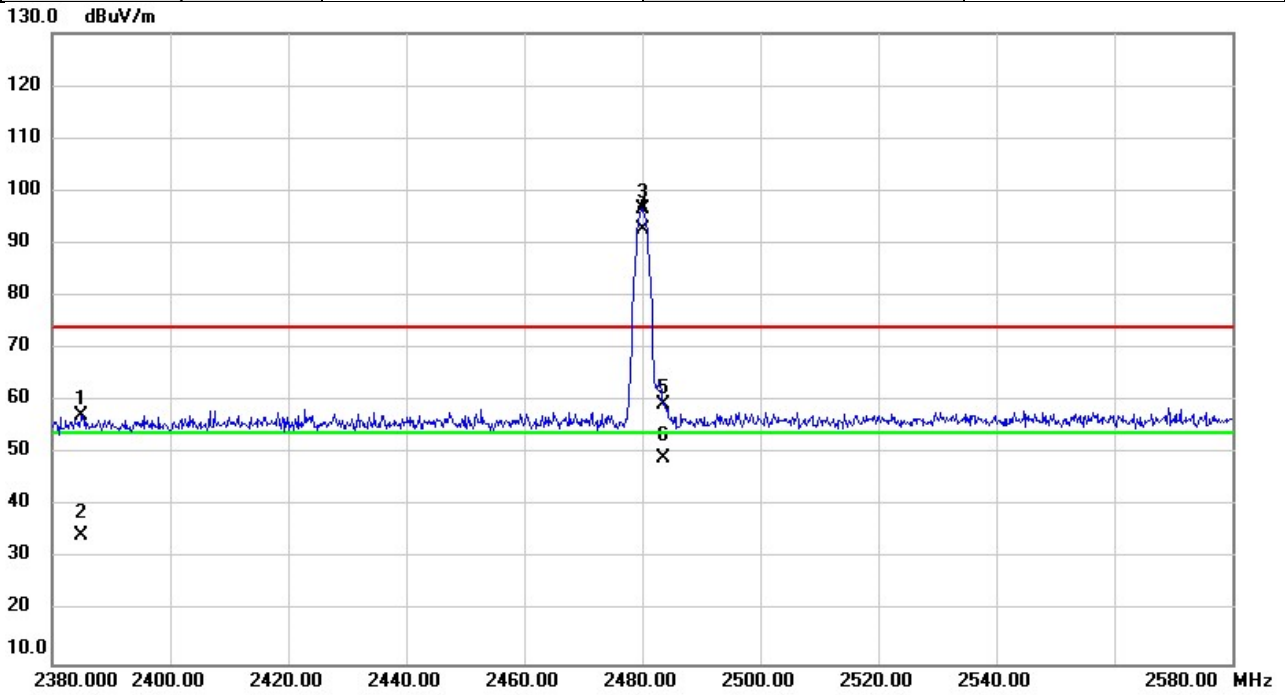

No.	Mk.	Freq.	Reading Level	Correct Factor	Measurement	Limit	Over	Detector	Comment
		MHz	dBuV	dB	dBuV/m	dBuV/m	dB		
1		2384.953	26.01	31.19	57.20	74.00	-16.80	peak	
2		2384.953	3.20	31.19	34.39	54.00	-19.61	AVG	
3	X	2480.000	64.99	31.51	96.50	74.00	22.50	peak	NoLimit
4	*	2480.000	61.24	31.51	92.75	54.00	38.75	AVG	NoLimit
5		2483.500	27.97	31.52	59.49	74.00	-14.51	peak	
6		2483.500	17.71	31.52	49.23	54.00	-4.77	AVG	

**REMARKS:**

- (1) Measurement Value = Reading Level + Correct Factor.
- (2) Margin Level = Measurement Value - Limit Value.

Test Mode	BT(1Mbps)	Test Date	2021/10/7
Test Frequency	2402MHz	Polarization	Vertical
Temp	25°C	Hum.	60%

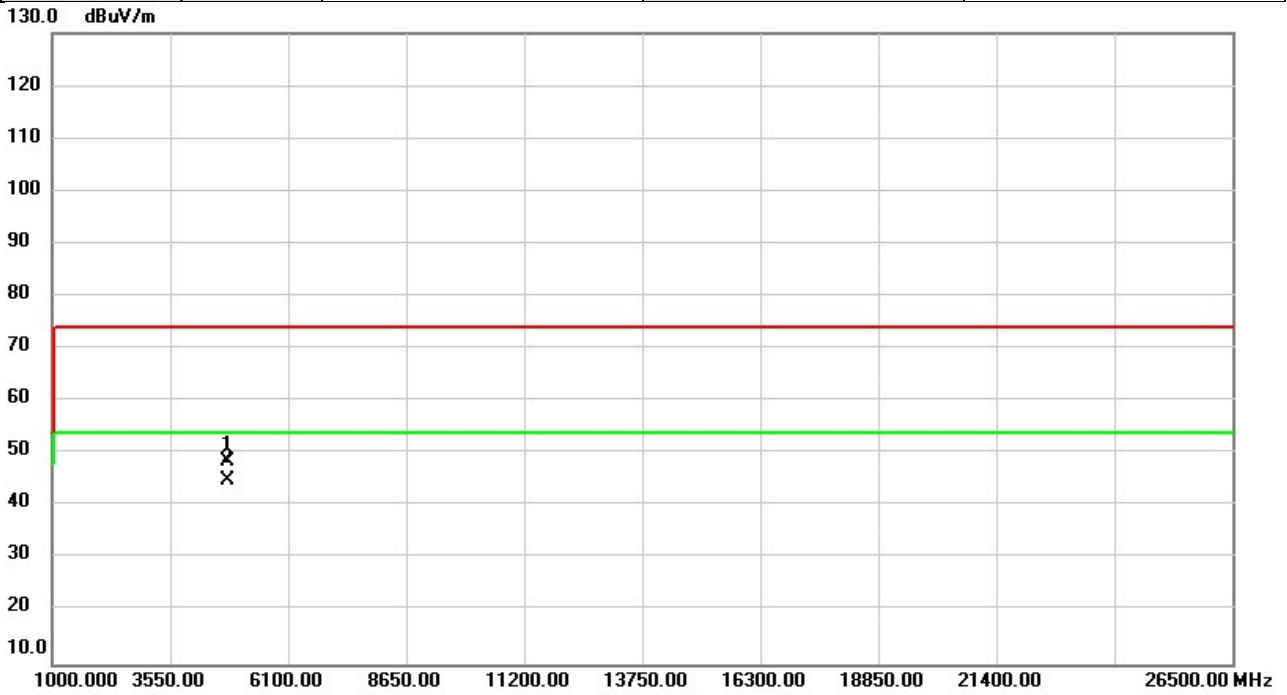

No.	Mk.	Freq. MHz	Reading Level dBuV	Correct Factor dB	Measure- ment dBuV/m	Limit dBuV/m	Over dB	Detector	Comment
1		4804.000	58.27	-9.84	48.43	74.00	-25.57	peak	
2	*	4804.000	54.87	-9.84	45.03	54.00	-8.97	AVG	

**REMARKS:**

- (1) Measurement Value = Reading Level + Correct Factor.
- (2) Margin Level = Measurement Value - Limit Value.

Test Mode	BT(1Mbps)	Test Date	2021/10/7
Test Frequency	2402MHz	Polarization	Horizontal
Temp	25°C	Hum.	60%

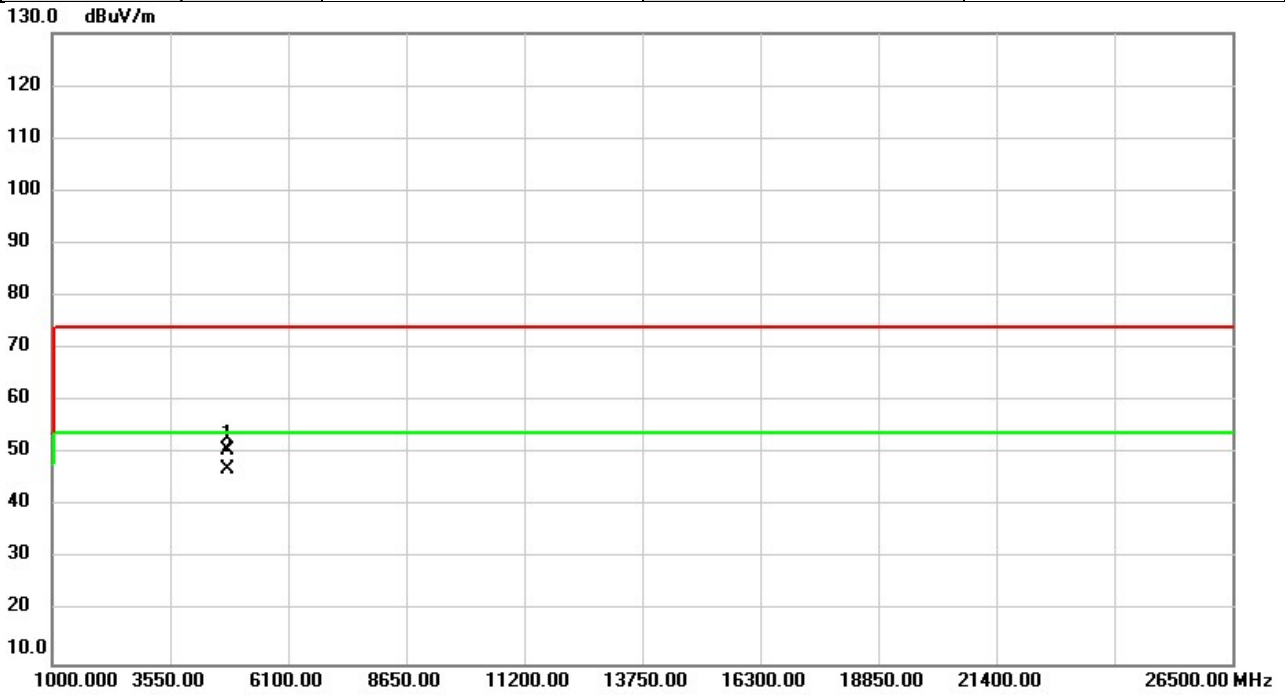

No.	Mk.	Freq. MHz	Reading Level dBuV	Correct Factor dB	Measure- ment dBuV/m	Limit dBuV/m	Over dB	Detector	Comment
1		4804.000	60.38	-9.84	50.54	74.00	-23.46	peak	
2	*	4804.000	57.02	-9.84	47.18	54.00	-6.82	AVG	

REMARKS:

- (1) Measurement Value = Reading Level + Correct Factor.
- (2) Margin Level = Measurement Value - Limit Value.

Test Mode	BT(1Mbps)	Test Date	2021/10/7
Test Frequency	2441MHz	Polarization	Vertical
Temp	25°C	Hum.	60%

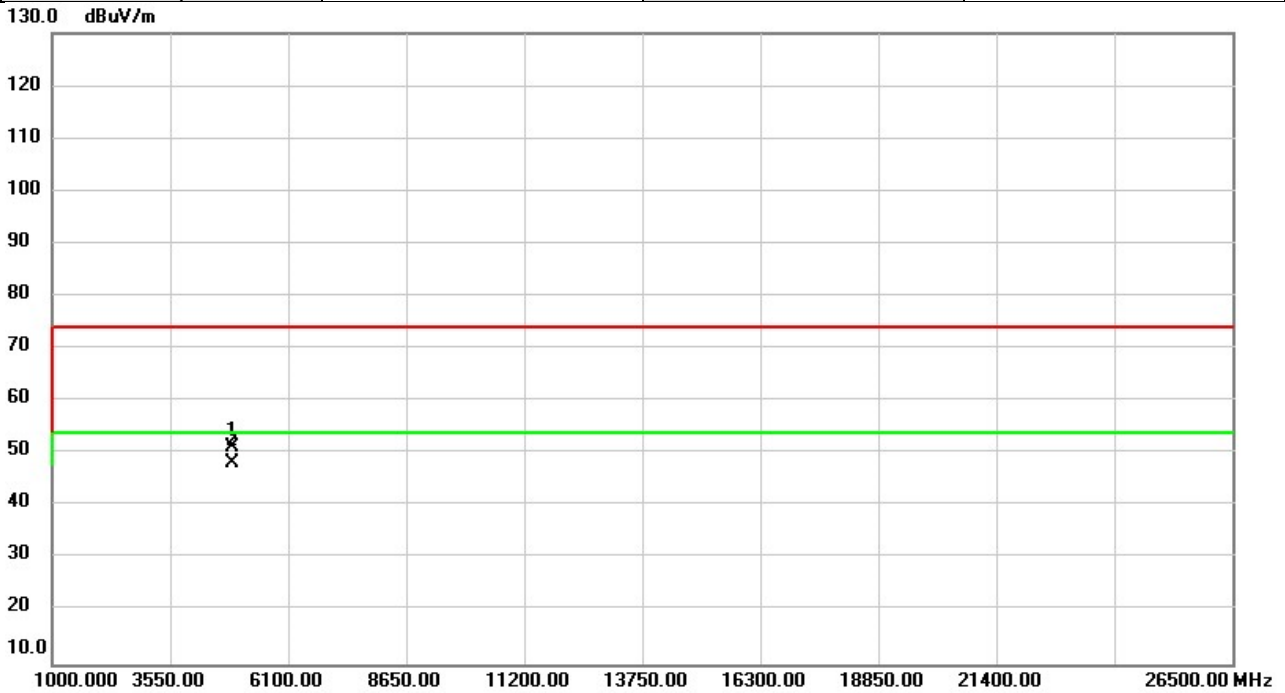

No.	Mk.	Freq. MHz	Reading Level dBuV	Correct Factor dB	Measure- ment dBuV/m	Limit dBuV/m	Over dB	Detector	Comment
1		4882.000	61.08	-9.77	51.31	74.00	-22.69	peak	
2	*	4882.000	57.92	-9.77	48.15	54.00	-5.85	AVG	

**REMARKS:**

- (1) Measurement Value = Reading Level + Correct Factor.
- (2) Margin Level = Measurement Value - Limit Value.

Test Mode	BT(1Mbps)	Test Date	2021/10/7
Test Frequency	2441MHz	Polarization	Horizontal
Temp	25°C	Hum.	60%

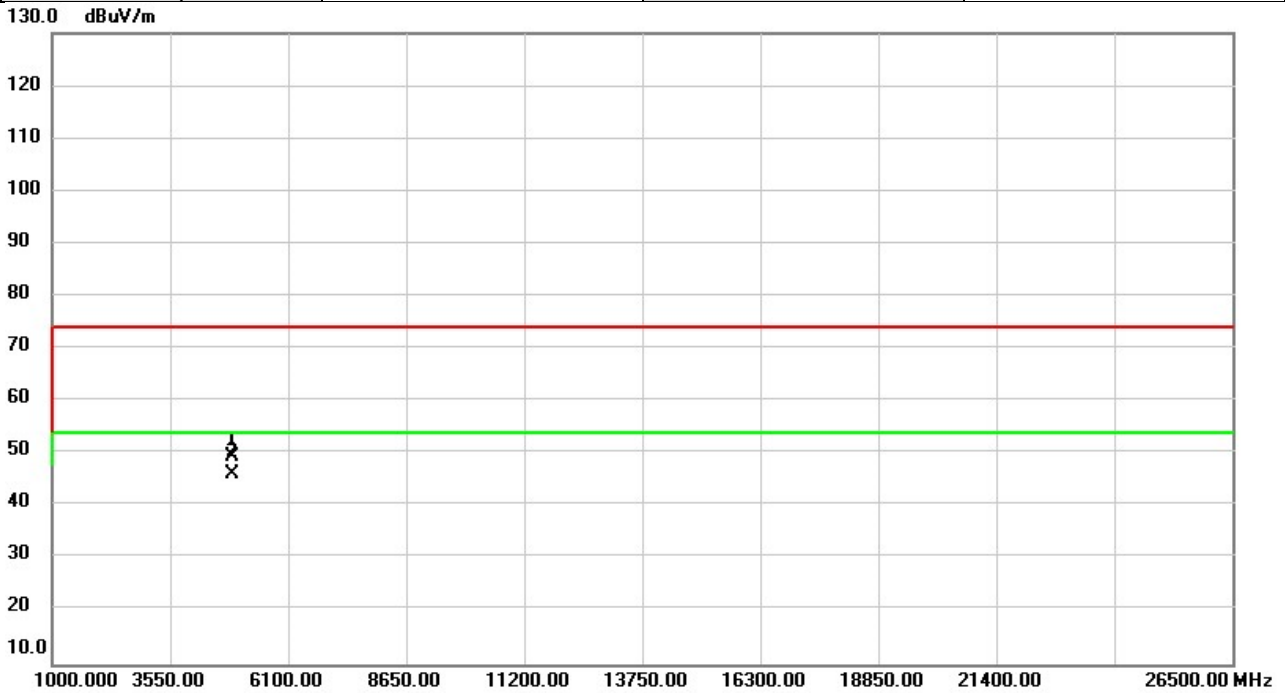

No.	Mk.	Freq. MHz	Reading Level dBuV	Correct Factor dB	Measure- ment dBuV/m	Limit dBuV/m	Over dB	Detector	Comment
1		4882.000	59.22	-9.77	49.45	74.00	-24.55	peak	
2	*	4882.000	55.95	-9.77	46.18	54.00	-7.82	AVG	

**REMARKS:**

- (1) Measurement Value = Reading Level + Correct Factor.
- (2) Margin Level = Measurement Value - Limit Value.

Test Mode	BT(1Mbps)	Test Date	2021/10/7
Test Frequency	2480MHz	Polarization	Vertical
Temp	25°C	Hum.	60%

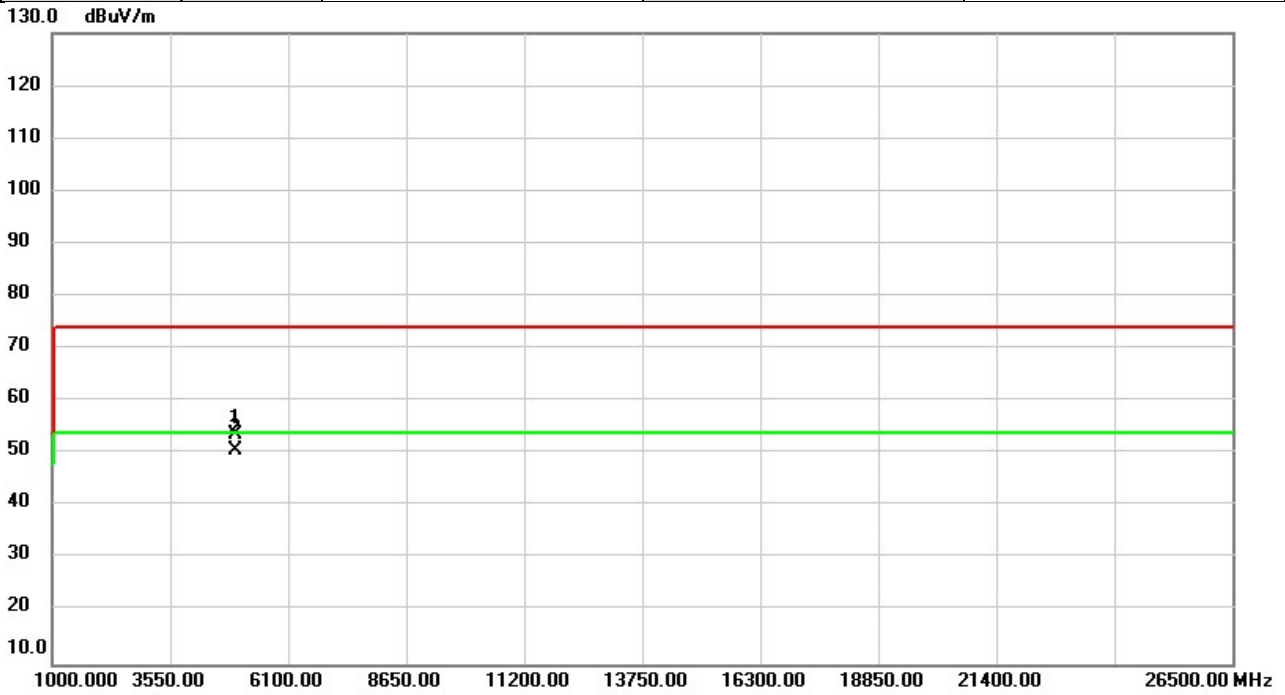

No.	Mk.	Freq. MHz	Reading Level dBuV	Correct Factor dB	Measure- ment dBuV/m	Limit dBuV/m	Over dB	Detector	Comment
1		4960.150	63.34	-9.68	53.66	74.00	-20.34	peak	
2	*	4960.150	60.19	-9.68	50.51	54.00	-3.49	AVG	

**REMARKS:**

- (1) Measurement Value = Reading Level + Correct Factor.
- (2) Margin Level = Measurement Value - Limit Value.

Test Mode	BT(1Mbps)	Test Date	2021/10/7
Test Frequency	2480MHz	Polarization	Horizontal
Temp	25°C	Hum.	60%

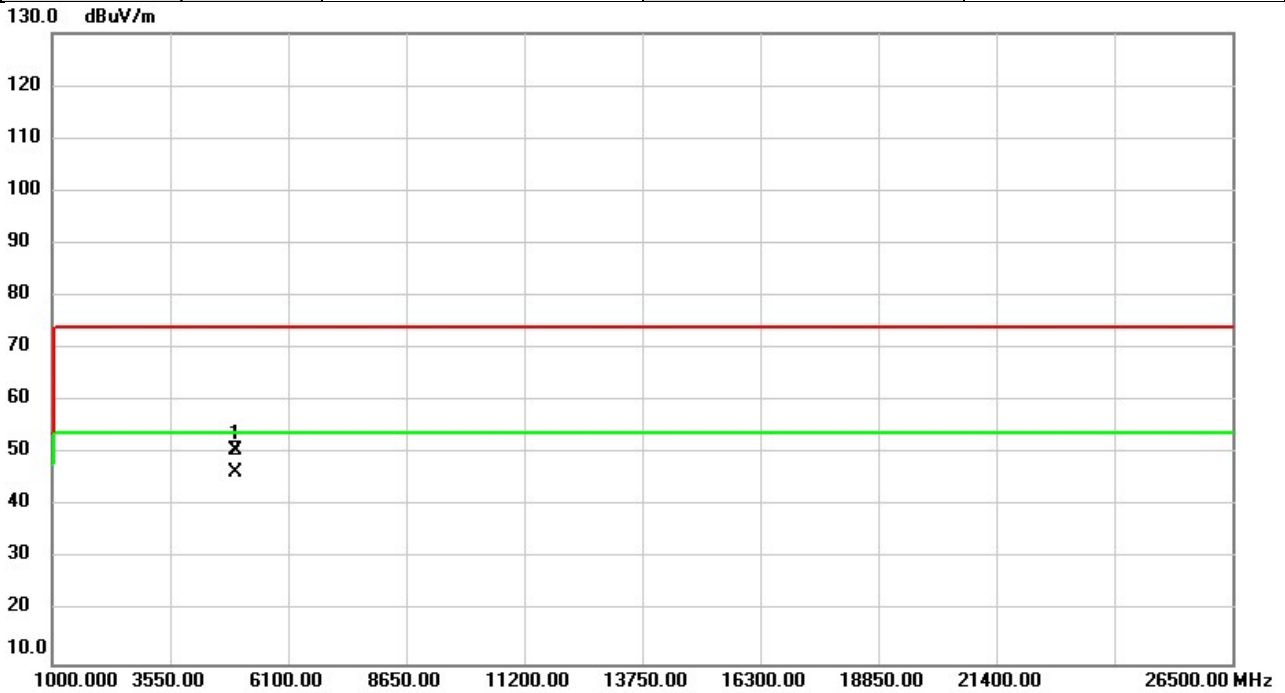

No.	Mk.	Freq. MHz	Reading Level dBuV	Correct Factor dB	Measure- ment dBuV/m	Limit dBuV/m	Over dB	Detector	Comment
1		4960.000	60.30	-9.68	50.62	74.00	-23.38	peak	
2	*	4960.000	56.09	-9.68	46.41	54.00	-7.59	AVG	

**REMARKS:**

- (1) Measurement Value = Reading Level + Correct Factor.
- (2) Margin Level = Measurement Value - Limit Value.

Test Mode	BT(3Mbps)	Test Date	2021/10/7
Test Frequency	2402MHz	Polarization	Vertical
Temp	25°C	Hum.	60%

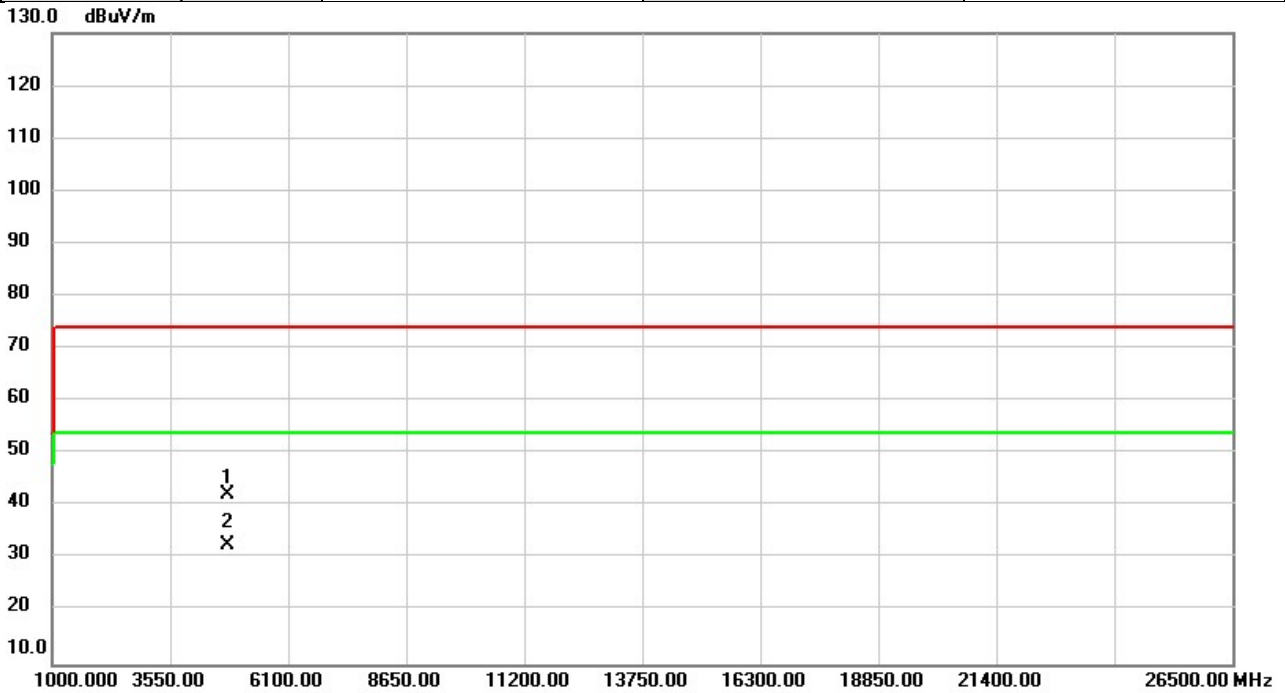

No.	Mk.	Freq. MHz	Reading Level dBuV	Correct Factor dB	Measure- ment dBuV/m	Limit dBuV/m	Over dB	Detector	Comment
1		4804.000	52.11	-9.84	42.27	74.00	-31.73	peak	
2	*	4804.000	42.52	-9.84	32.68	54.00	-21.32	AVG	

**REMARKS:**

- (1) Measurement Value = Reading Level + Correct Factor.
- (2) Margin Level = Measurement Value - Limit Value.



Test Mode	BT(3Mbps)	Test Date	2021/10/7
Test Frequency	2402MHz	Polarization	Horizontal
Temp	25°C	Hum.	60%

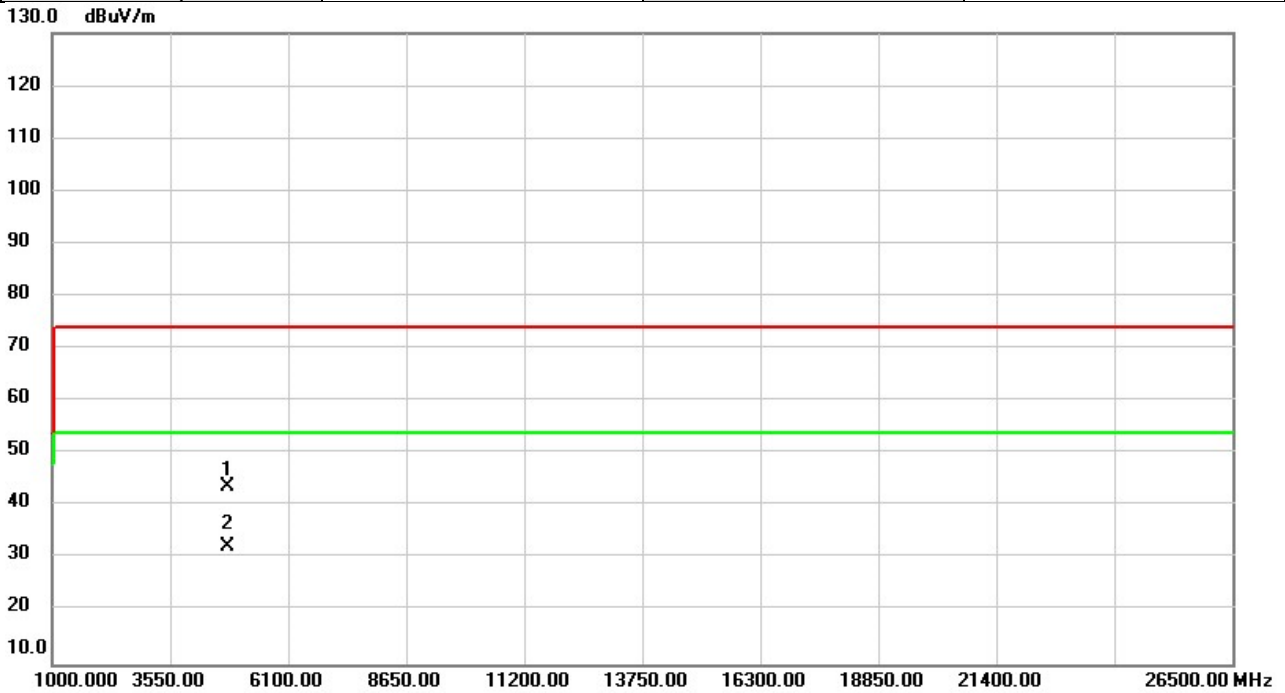

No.	Mk.	Freq. MHz	Reading Level dBuV	Correct Factor dB	Measure- ment dBuV/m	Limit dBuV/m	Over dB	Detector	Comment
1		4804.000	53.51	-9.84	43.67	74.00	-30.33	peak	
2	*	4804.000	42.32	-9.84	32.48	54.00	-21.52	AVG	

**REMARKS:**

- (1) Measurement Value = Reading Level + Correct Factor.
- (2) Margin Level = Measurement Value - Limit Value.

Test Mode	BT(3Mbps)	Test Date	2021/10/7
Test Frequency	2441MHz	Polarization	Vertical
Temp	25°C	Hum.	60%

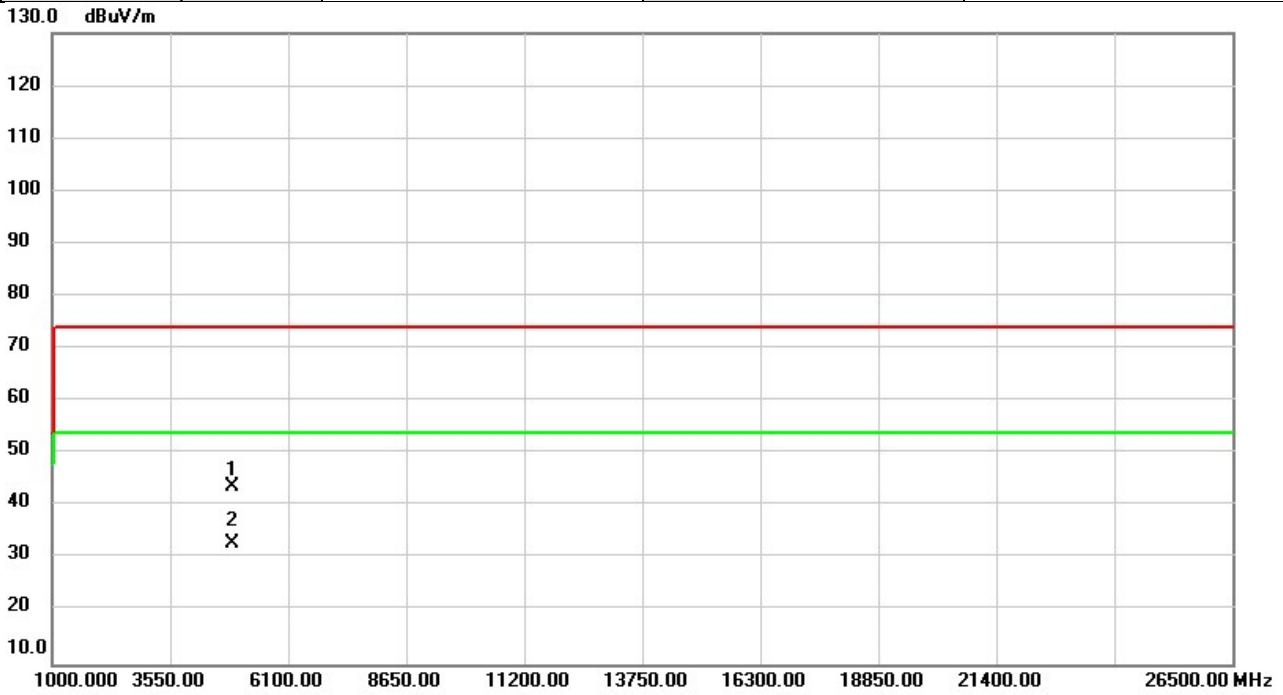

No.	Mk.	Freq. MHz	Reading Level dBuV	Correct Factor dB	Measure- ment dBuV/m	Limit dBuV/m	Over dB	Detector	Comment
1		4882.000	53.40	-9.77	43.63	74.00	-30.37	peak	
2	*	4882.000	42.76	-9.77	32.99	54.00	-21.01	AVG	

**REMARKS:**

- (1) Measurement Value = Reading Level + Correct Factor.
- (2) Margin Level = Measurement Value - Limit Value.

Test Mode	BT(3Mbps)	Test Date	2021/10/7
Test Frequency	2441MHz	Polarization	Horizontal
Temp	25°C	Hum.	60%

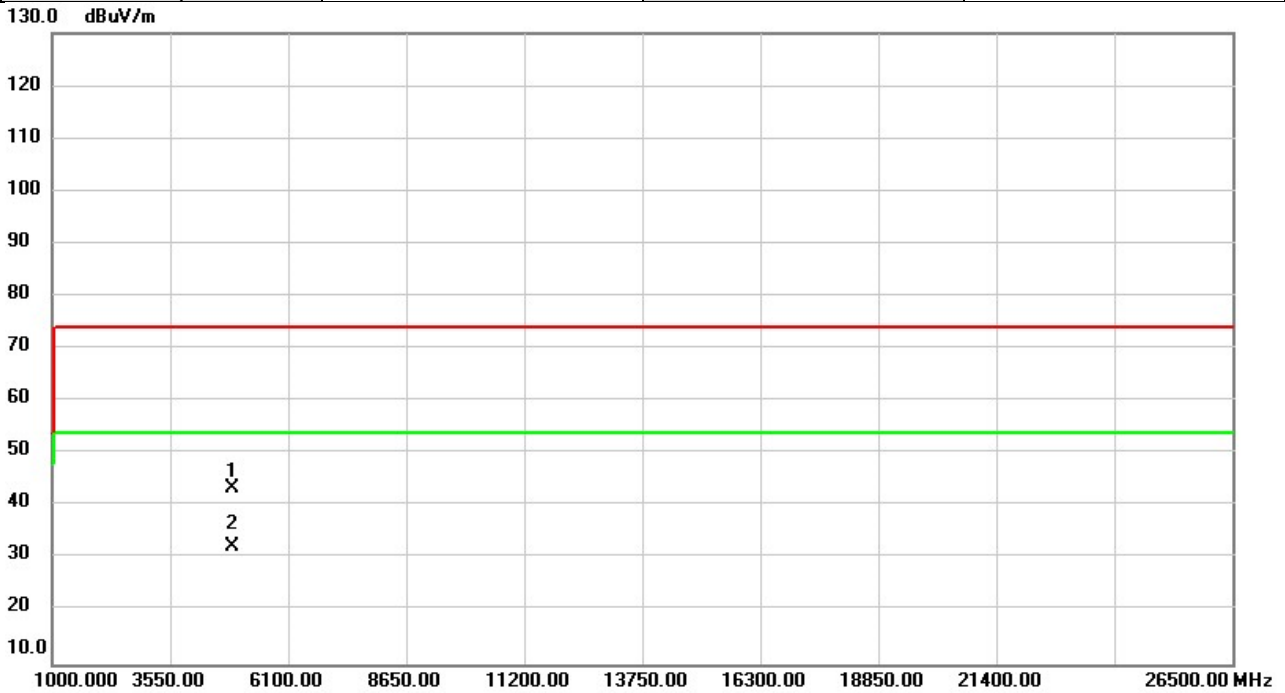

No.	Mk.	Freq. MHz	Reading Level dBuV	Correct Factor dB	Measure- ment dBuV/m	Limit dBuV/m	Over dB	Detector	Comment
1		4882.000	53.18	-9.77	43.41	74.00	-30.59	peak	
2	*	4882.000	42.26	-9.77	32.49	54.00	-21.51	AVG	

**REMARKS:**

- (1) Measurement Value = Reading Level + Correct Factor.
- (2) Margin Level = Measurement Value - Limit Value.

Test Mode	BT(3Mbps)	Test Date	2021/10/7
Test Frequency	2480MHz	Polarization	Vertical
Temp	25°C	Hum.	60%

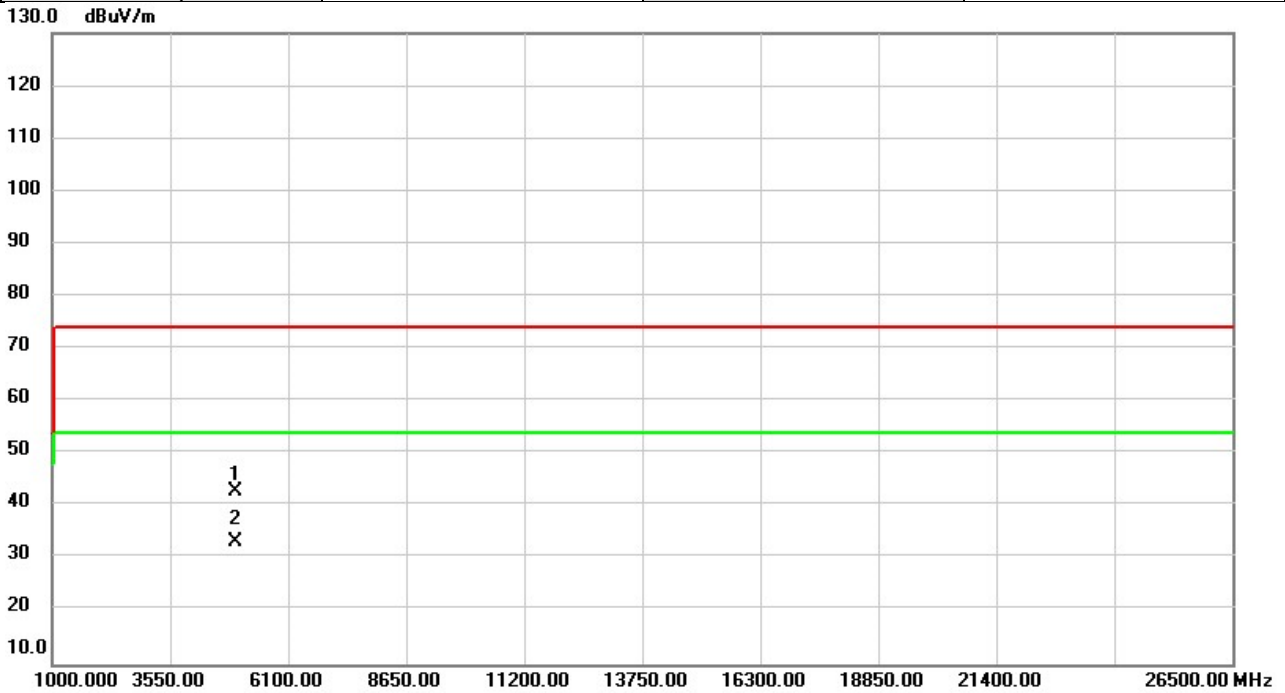

No.	Mk.	Freq. MHz	Reading Level dBuV	Correct Factor dB	Measure- ment dBuV/m	Limit dBuV/m	Over dB	Detector	Comment
1		4960.000	52.62	-9.68	42.94	74.00	-31.06	peak	
2	*	4960.000	42.83	-9.68	33.15	54.00	-20.85	AVG	

**REMARKS:**

- (1) Measurement Value = Reading Level + Correct Factor.
- (2) Margin Level = Measurement Value - Limit Value.

Test Mode	BT(3Mbps)	Test Date	2021/10/7
Test Frequency	2480MHz	Polarization	Horizontal
Temp	25°C	Hum.	60%

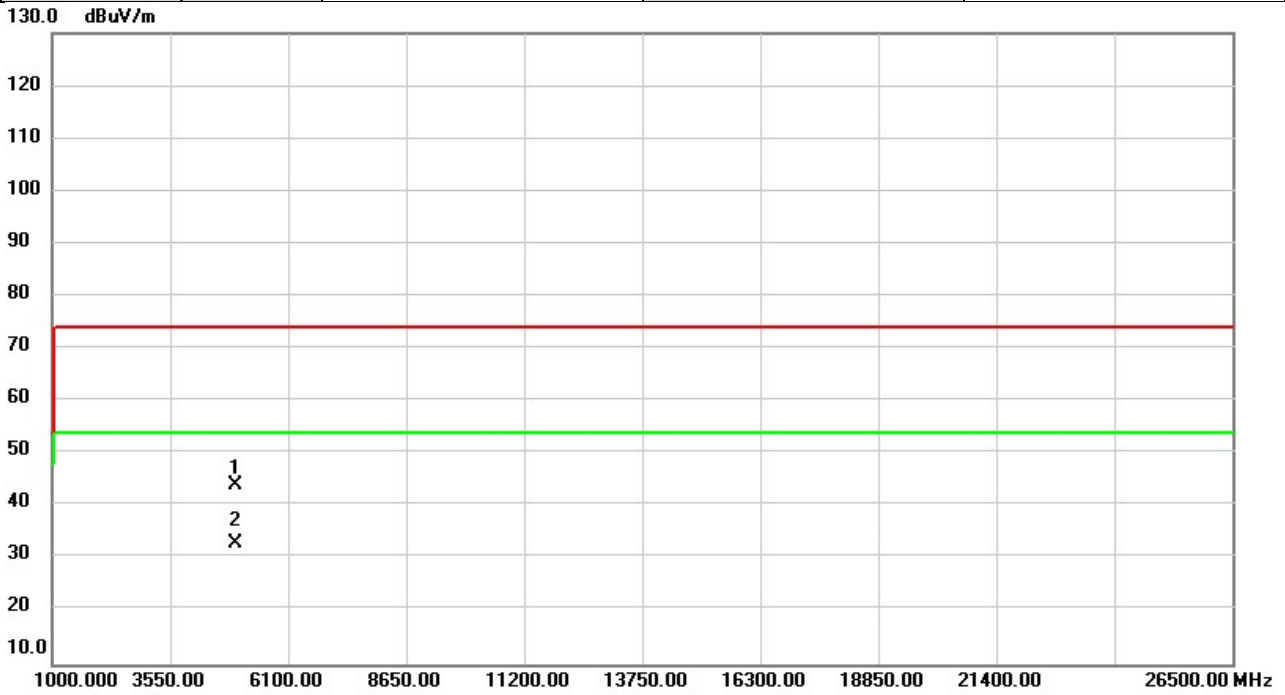

No.	Mk.	Freq. MHz	Reading Level dBuV	Correct Factor dB	Measure- ment dBuV/m	Limit dBuV/m	Over dB	Detector	Comment
1		4960.000	53.73	-9.68	44.05	74.00	-29.95	peak	
2	*	4960.000	42.68	-9.68	33.00	54.00	-21.00	AVG	

**REMARKS:**

- (1) Measurement Value = Reading Level + Correct Factor.
- (2) Margin Level = Measurement Value - Limit Value.

## APPENDIX D NUMBER OF HOPPING CHANNEL

Test Mode	1/3Mbps
-----------	---------

Test Mode	Number of Hopping Channel	≥ Limit	Test Result
1 Mbps	79	15	Pass
3 Mbps	79	15	Pass

1 Mbps

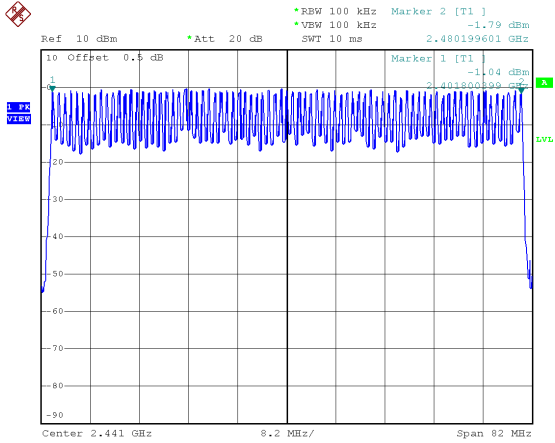

Date: 15.MAY.2014 17:56:10

3 Mbps

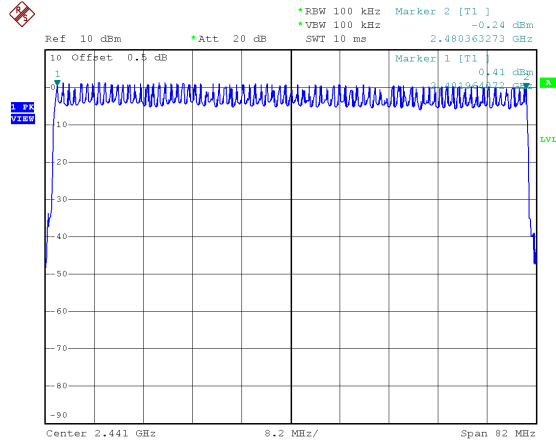

Date: 15.MAY.2014 18:03:31

## APPENDIX E AVERAGE TIME OF OCCUPANCY



Test Mode	1Mbps
-----------	-------

Data Packet	Frequency (MHz)	Pulse Duration (ms)	Dwell Time (s)	Limits (s)	Test Result
DH5	2402	3.0818	0.3287	0.4	Pass
DH3	2402	1.8009	0.2881	0.4	Pass
DH1	2402	0.5205	0.1666	0.4	Pass
DH5	2441	3.0411	0.3244	0.4	Pass
DH3	2441	1.8015	0.2882	0.4	Pass
DH1	2441	0.5217	0.1669	0.4	Pass
DH5	2480	3.0445	0.3247	0.4	Pass
DH3	2480	1.8038	0.2886	0.4	Pass
DH1	2480	0.5213	0.1668	0.4	Pass

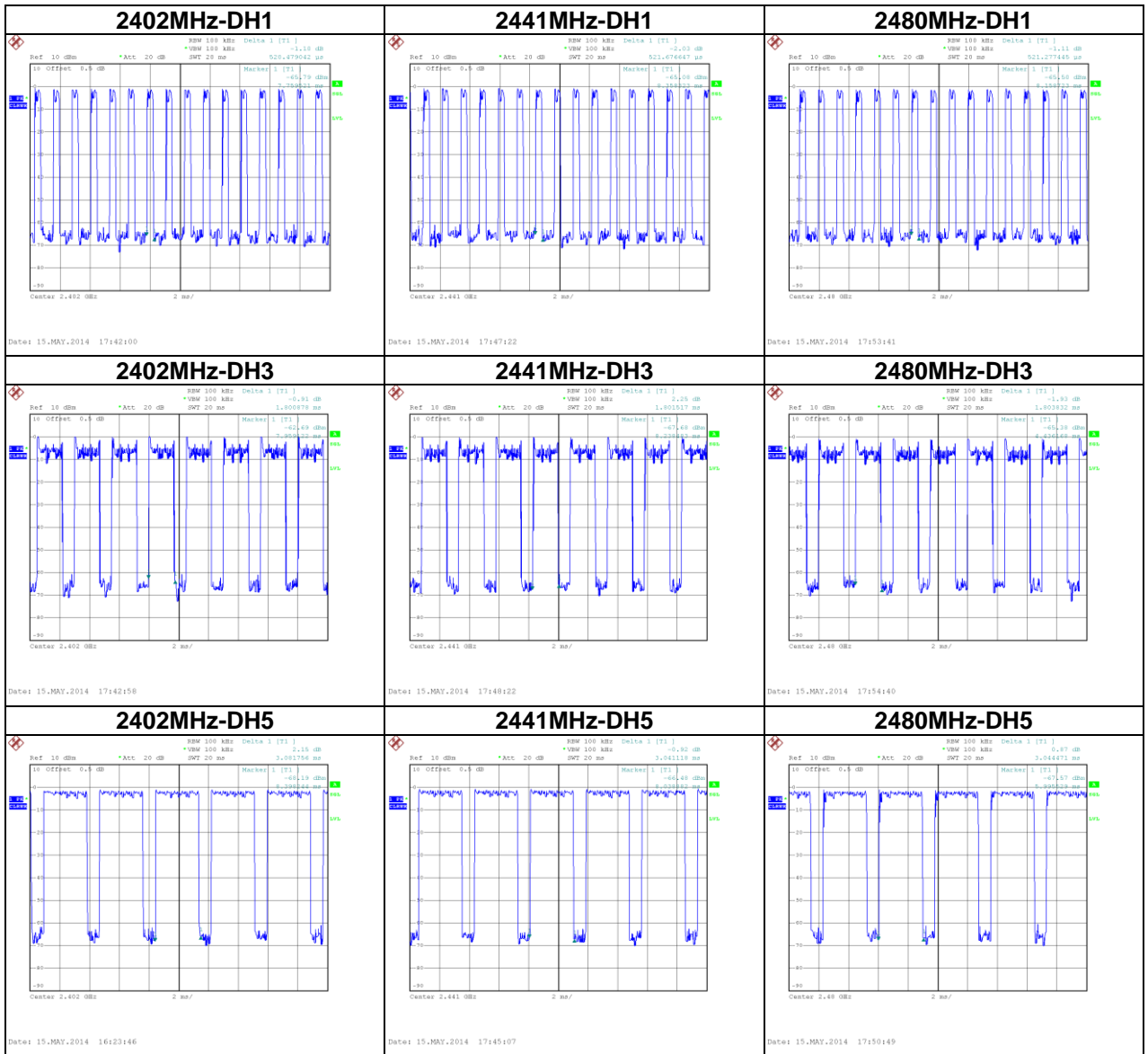

Test Mode	3Mbps
-----------	-------

Data Packet	Frequency (MHz)	Pulse Duration(ms)	Dwell Time(s)	Limits(s)	Test Result
3DH5	2402	3.0425	0.3245	0.4	Pass
3DH3	2402	1.8043	0.2887	0.4	Pass
3DH1	2402	0.5224	0.1672	0.4	Pass
3DH5	2441	3.0407	0.3243	0.4	Pass
3DH3	2441	1.8037	0.2886	0.4	Pass
3DH1	2441	0.5219	0.1670	0.4	Pass
3DH5	2480	3.0406	0.3243	0.4	Pass
3DH3	2480	1.7602	0.2816	0.4	Pass
3DH1	2480	0.5202	0.1665	0.4	Pass



## **APPENDIX F HOPPING CHANNEL SEPARATION MEASUREMENT**

Test Mode | Hopping on \_1Mbps

Frequency (MHz)	Channel Separation (MHz)	2/3 of 20dB Bandwidth (MHz)	Test Result
2402	1.002	0.631	Pass
2441	1.002	0.628	Pass
2480	1.002	0.631	Pass

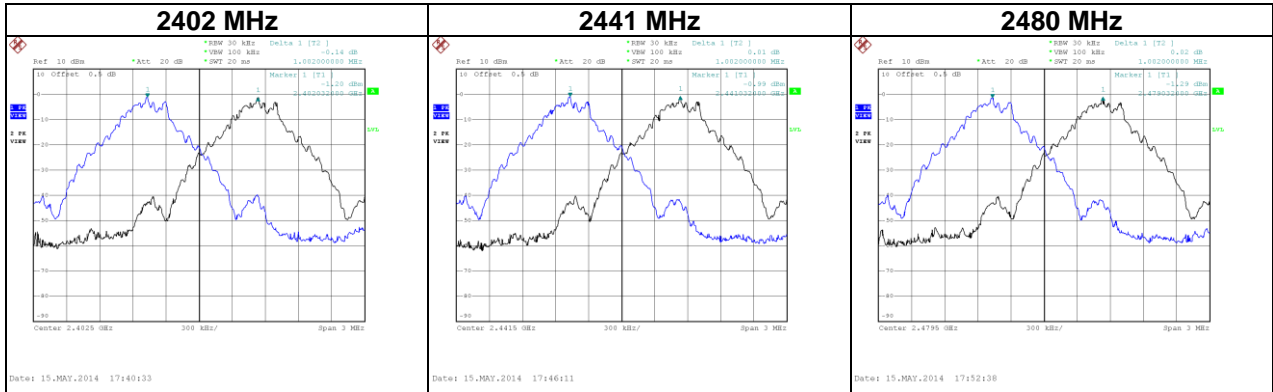

Test Mode      Hopping on \_3Mbps

Frequency (MHz)	Channel Separation (MHz)	2/3 of 20dB Bandwidth (MHz)	Test Result
2402	1.002	0.841	Pass
2441	1.002	0.844	Pass
2480	1.008	0.841	Pass

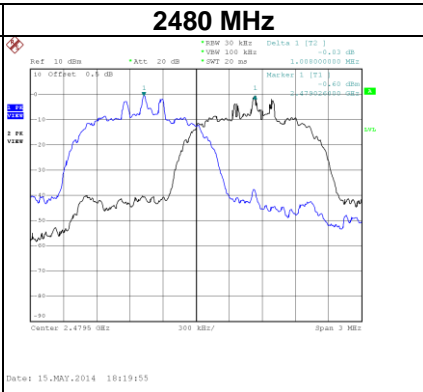
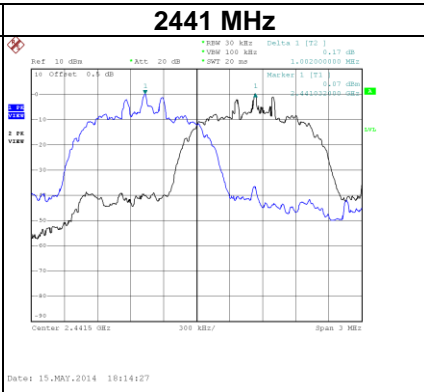
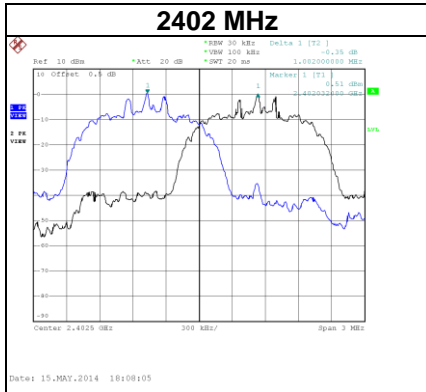

## APPENDIX G BANDWIDTH

Test Mode	1Mbps
-----------	-------

Frequency (MHz)	20dB Bandwidth (MHz)	99% Occupied BW (MHz)	Test Result
2402	0.946	0.876	Pass
2441	0.942	0.872	Pass
2480	0.946	0.880	Pass

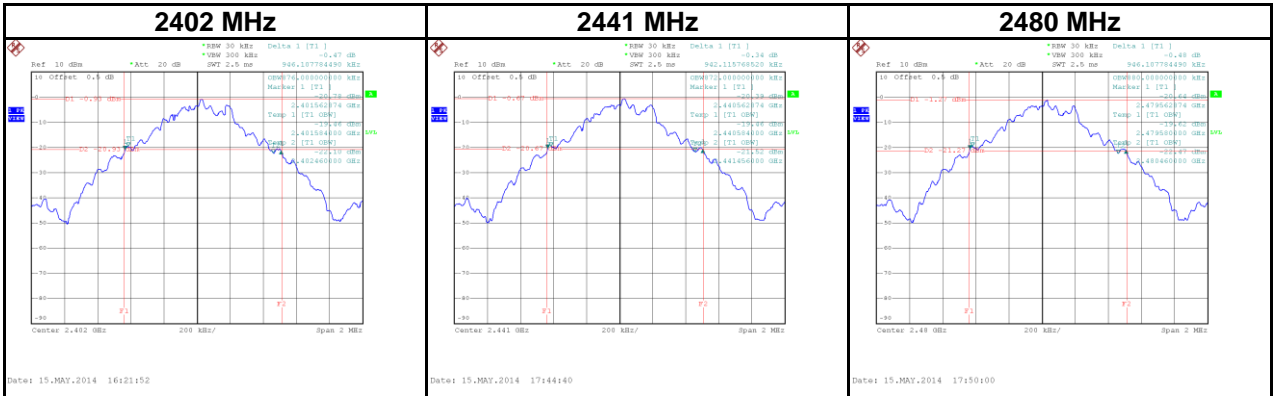

Test Mode	3Mbps
-----------	-------

Frequency (MHz)	20dB Bandwidth (MHz)	99% Occupied BW (MHz)	Test Result
2402	1.261	1.180	Pass
2441	1.265	1.180	Pass
2480	1.261	1.176	Pass

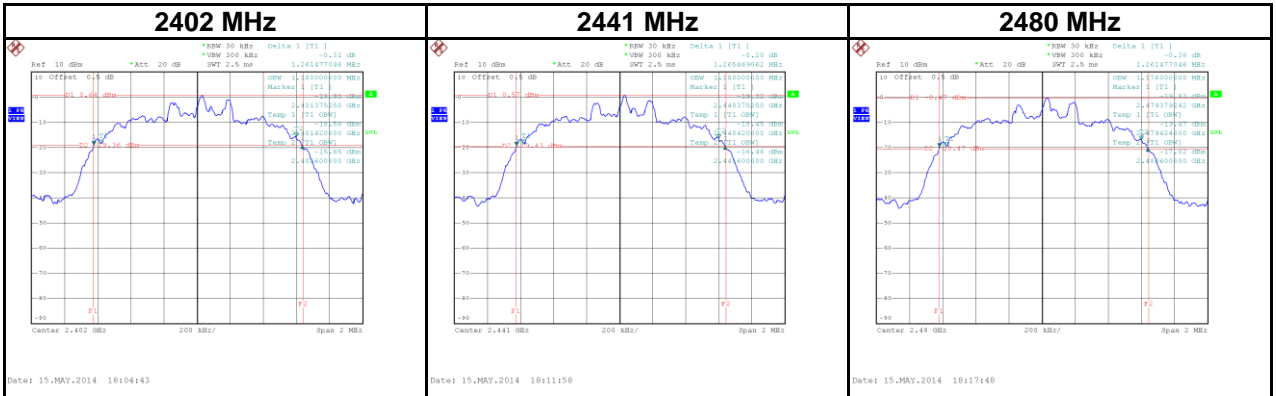



## APPENDIX H OUTPUT POWER

Test Mode	1Mbps	Tested Date	2021/8/4
-----------	-------	-------------	----------

Frequency (MHz)	Conducted Power (dBm)	Conducted Power (W)	Max. Limit (dBm)	Max. Limit (W)	Test Result
2402	-1.04	0.0008	21.00	0.1259	Pass
2441	-1.31	0.0007	21.00	0.1259	Pass
2480	-1.95	0.0006	21.00	0.1259	Pass

Test Mode	2Mbps	Tested Date	2021/8/4
-----------	-------	-------------	----------

Frequency (MHz)	Conducted Power (dBm)	Conducted Power (W)	Max. Limit (dBm)	Max. Limit (W)	Test Result
2402	-1.66	0.0007	21.00	0.1259	Pass
2441	-2.30	0.0006	21.00	0.1259	Pass
2480	-2.58	0.0006	21.00	0.1259	Pass

Test Mode	3Mbps	Tested Date	2021/8/4
-----------	-------	-------------	----------

Frequency (MHz)	Conducted Power (dBm)	Conducted Power (W)	Max. Limit (dBm)	Max. Limit (W)	Test Result
2402	-1.54	0.0007	21.00	0.1259	Pass
2441	-2.16	0.0006	21.00	0.1259	Pass
2480	-2.49	0.0006	21.00	0.1259	Pass

## **APPENDIX I    ANTENNA CONDUCTED SPURIOUS EMISSION**

Test Mode | 1Mbps

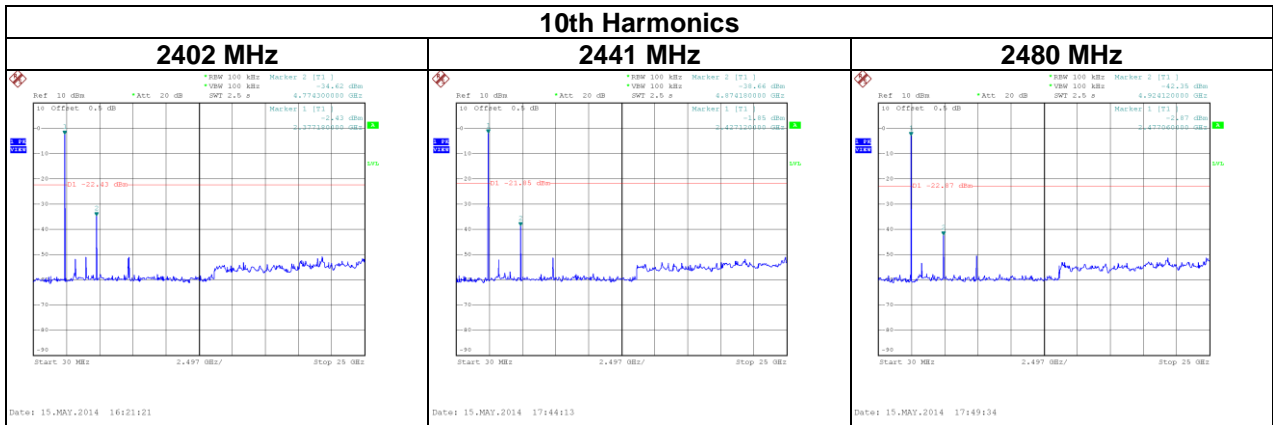
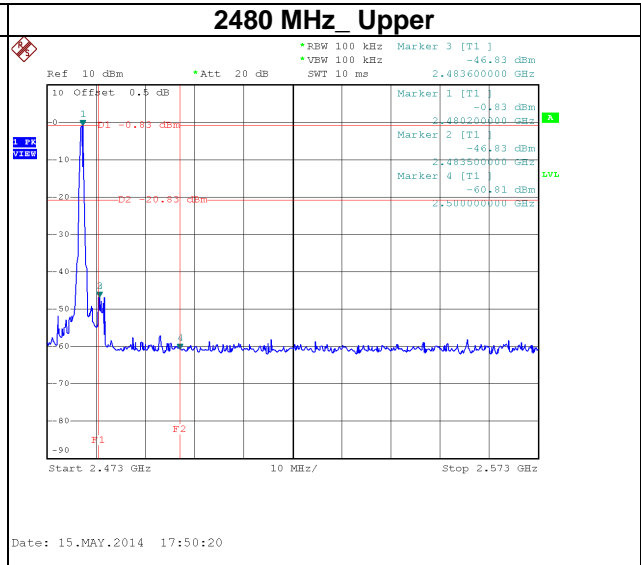
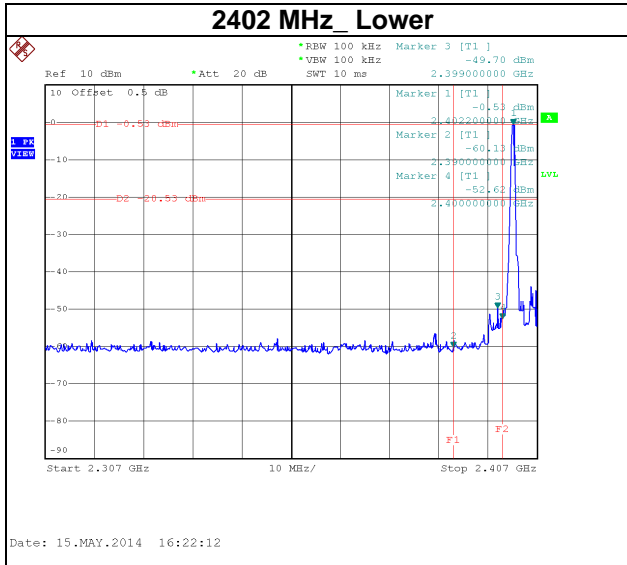

Test Mode **3Mbps**

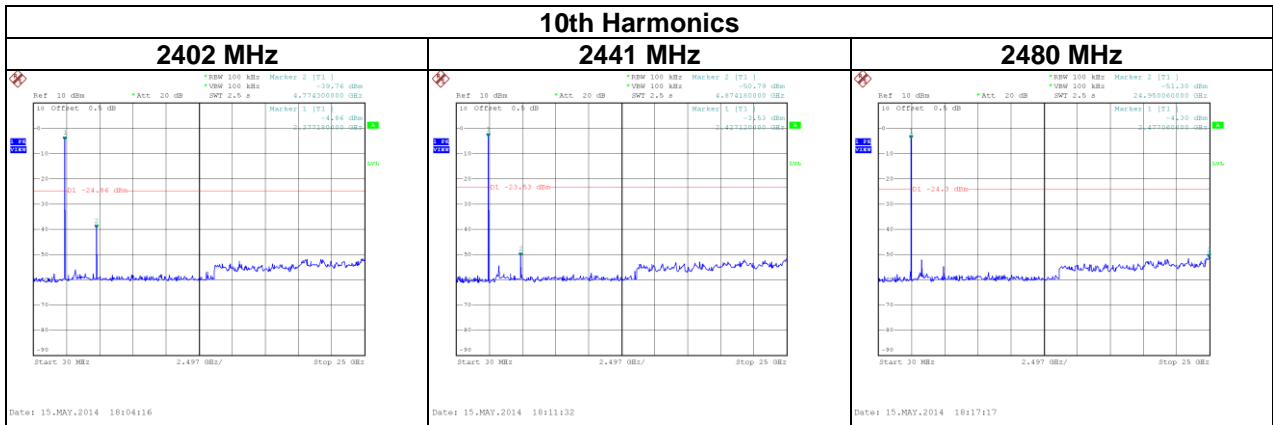
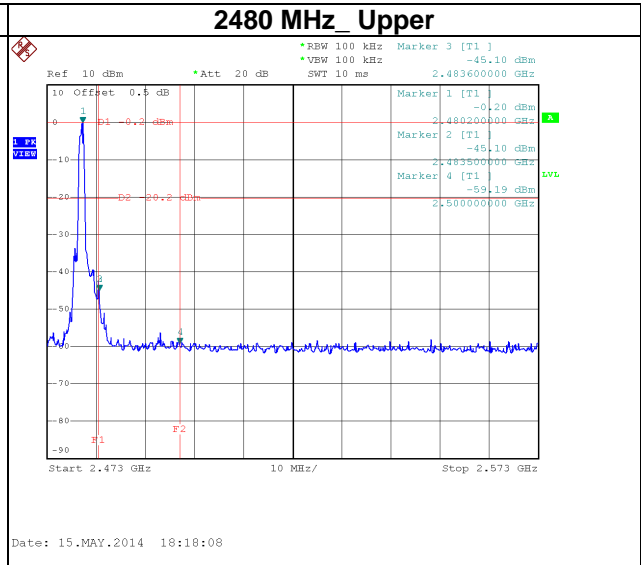
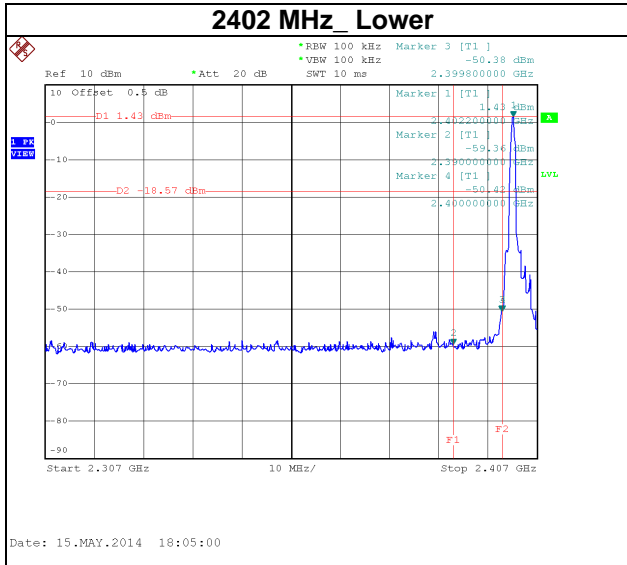

**End of Test Report**