

FCC Radio Test Report

FCC ID: UFOOPN4000I

Report No. : BTL-FCCP-1-2106T008
Equipment : Bluetooth Barcode Scanner
Model Name : OPN-4000i
Brand Name : OPTICON
Applicant : OPTOELECTRONICS Co., Ltd.
Address : 4-12-17, Tsukagoshi, Warabi-shi, Saitama Pref., 335-0002 Japan
Manufacturer : OPTOELECTRONICS Co., Ltd.
Address : 4-12-17, Tsukagoshi, Warabi-shi, Saitama Pref., 335-0002 Japan

Radio Function : Bluetooth EDR

FCC Rule Part(s) : FCC Part15, Subpart C (15.247)
Measurement Procedure(s) : ANSI C63.10-2013

Date of Receipt : 2014/2/27
2021/6/9
Date of Test : 2014/2/27 ~ 2014/3/31
2021/6/9~ 2021/9/28, 2022/2/15
Issued Date : 2022/3/1

The above equipment has been tested and found in compliance with the requirement of the above standards by BTL Inc.

Prepared by :

Eric Lee, Engineer

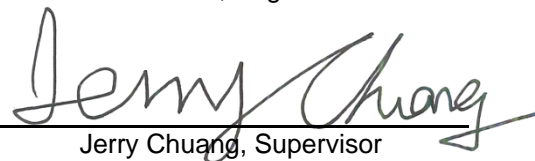
Approved by :

Jerry Chuang, Supervisor

**BTL Inc.**

No.18, Ln. 171, Sec. 2, Jiuzong Rd., Neihu Dist., Taipei City 114, Taiwan

Tel: +886-2-2657-3299

Fax: +886-2-2657-3331

Web: www.newbtl.com

Declaration

BTL represents to the client that testing is done in accordance with standard procedures as applicable and that test instruments used has been calibrated with standards traceable to international standard(s) and/or national standard(s).

BTL's reports apply only to the specific samples tested under conditions. It is manufacture's responsibility to ensure that additional production units of this model are manufactured with the identical electrical and mechanical components. **BTL** shall have no liability for any declarations, inferences or generalizations drawn by the client or others from **BTL** issued reports.

This report is the confidential property of the client. As a mutual protection to the clients, the public and ourselves, the test report shall not be reproduced, except in full, without our written approval.

BTL's laboratory quality assurance procedures are in compliance with the **ISO/IEC 17025** requirements, and accredited by the conformity assessment authorities listed in this test report.

BTL is not responsible for the sampling stage, so the results only apply to the sample as received.

The information, data and test plan are provided by manufacturer which may affect the validity of results, so it is manufacturer's responsibility to ensure that the apparatus meets the essential requirements of applied standards and in all the possible configurations as representative of its intended use.

Limitation

For the use of the authority's logo is limited unless the Test Standard(s)/Scope(s)/Item(s) mentioned in this test report is (are) included in the conformity assessment authorities acceptance respective.

Please note that the measurement uncertainty is provided for informational purpose only and are not use in determining the Pass/Fail results.

CONTENTS

| | |
|--|----|
| REVISION HISTORY | 5 |
| 1 SUMMARY OF TEST RESULTS | 6 |
| 1.1 TEST FACILITY | 7 |
| 1.2 MEASUREMENT UNCERTAINTY | 7 |
| 1.3 TEST ENVIRONMENT CONDITIONS | 8 |
| 1.4 TABLE OF PARAMETERS OF TEST SOFTWARE SETTING | 8 |
| 1.5 DUTY CYCLE | 9 |
| 2 GENERAL INFORMATION | 10 |
| 2.1 DESCRIPTION OF EUT | 10 |
| 2.2 TEST MODES | 12 |
| 2.3 BLOCK DIAGRAM SHOWING THE CONFIGURATION OF SYSTEM TESTED | 13 |
| 2.4 SUPPORT UNITS | 13 |
| 3 AC POWER LINE CONDUCTED EMISSIONS TEST | 14 |
| 3.1 LIMIT | 14 |
| 3.2 TEST PROCEDURE | 14 |
| 3.3 DEVIATION FROM TEST STANDARD | 14 |
| 3.4 TEST SETUP | 15 |
| 3.5 TEST RESULT | 15 |
| 4 RADIATED EMISSIONS TEST | 16 |
| 4.1 LIMIT | 16 |
| 4.2 TEST PROCEDURE | 17 |
| 4.3 DEVIATION FROM TEST STANDARD | 17 |
| 4.4 TEST SETUP | 17 |
| 4.5 EUT OPERATING CONDITIONS | 18 |
| 4.6 TEST RESULT – BELOW 30 MHZ | 19 |
| 4.7 TEST RESULT – 30 MHZ TO 1 GHZ | 19 |
| 4.8 TEST RESULT – ABOVE 1 GHZ | 19 |
| 5 NUMBER OF HOPPING CHANNEL | 20 |
| 5.1 APPLIED PROCEDURES | 20 |
| 5.2 TEST PROCEDURE | 20 |
| 5.3 DEVIATION FROM STANDARD | 20 |
| 5.4 TEST SETUP | 20 |
| 5.5 EUT OPERATION CONDITIONS | 20 |
| 5.6 TEST RESULTS | 20 |
| 6 AVERAGE TIME OF OCCUPANCY | 21 |
| 6.1 APPLIED PROCEDURES / LIMIT | 21 |
| 6.2 TEST PROCEDURE | 21 |
| 6.3 DEVIATION FROM STANDARD | 21 |
| 6.4 TEST SETUP | 21 |
| 6.5 EUT OPERATION CONDITIONS | 21 |
| 6.6 TEST RESULTS | 21 |
| 7 HOPPING CHANNEL SEPARATION MEASUREMENT | 22 |
| 7.1 APPLIED PROCEDURES / LIMIT | 22 |
| 7.2 TEST PROCEDURE | 22 |
| 7.3 DEVIATION FROM STANDARD | 22 |
| 7.4 TEST SETUP | 22 |
| 7.5 TEST RESULTS | 22 |

| | | |
|------------|--|----|
| 8 | BANDWIDTH TEST | 23 |
| 8.1 | APPLIED PROCEDURES | 23 |
| 8.2 | TEST PROCEDURE | 23 |
| 8.3 | DEVIATION FROM STANDARD | 23 |
| 8.4 | TEST SETUP | 23 |
| 8.5 | EUT OPERATION CONDITIONS | 23 |
| 8.6 | TEST RESULTS | 23 |
| 9 | OUTPUT POWER TEST | 24 |
| 9.1 | APPLIED PROCEDURES / LIMIT | 24 |
| 9.2 | TEST PROCEDURE | 24 |
| 9.3 | DEVIATION FROM STANDARD | 24 |
| 9.4 | TEST SETUP | 24 |
| 9.5 | EUT OPERATION CONDITIONS | 24 |
| 9.6 | TEST RESULTS | 24 |
| 10 | ANTENNA CONDUCTED SPURIOUS EMISSION | 25 |
| 10.1 | APPLIED PROCEDURES / LIMIT | 25 |
| 10.2 | TEST PROCEDURE | 25 |
| 10.3 | DEVIATION FROM STANDARD | 25 |
| 10.4 | TEST SETUP | 25 |
| 10.5 | EUT OPERATION CONDITIONS | 25 |
| 10.6 | TEST RESULTS | 25 |
| 11 | LIST OF MEASURING EQUIPMENTS | 26 |
| 12 | EUT TEST PHOTO | 28 |
| 13 | EUT PHOTOS | 28 |
| APPENDIX A | AC POWER LINE CONDUCTED EMISSIONS | 29 |
| APPENDIX B | RADIATED EMISSIONS - 30 MHZ TO 1 GHZ | 34 |
| APPENDIX C | RADIATED EMISSIONS - ABOVE 1 GHZ | 37 |
| APPENDIX D | NUMBER OF HOPPING CHANNEL | 54 |
| APPENDIX E | AVERAGE TIME OF OCCUPANCY | 56 |
| APPENDIX F | HOPPING CHANNEL SEPARATION MEASUREMENT | 59 |
| APPENDIX G | BANDWIDTH | 62 |
| APPENDIX H | OUTPUT POWER | 65 |
| APPENDIX I | ANTENNA CONDUCTED SPURIOUS EMISSION | 67 |

REVISION HISTORY

| Report No. | Version | Description | Issued Date | Note |
|---------------------|---------|---|-------------|---------|
| BTL-FCCP-1-2106T008 | R00 | Original Report. | 2021/10/28 | Invalid |
| BTL-FCCP-1-2106T008 | R01 | Revised Typo. | 2022/2/18 | Invalid |
| BTL-FCCP-1-2106T008 | R02 | Revised report to address TCB's comments. | 2022/3/1 | Valid |

1 SUMMARY OF TEST RESULTS

Test procedures according to the technical standards.

| FCC Part 15, Subpart C (15.247) | | | | |
|---------------------------------|-------------------------------------|--------------------------|-----------|--------|
| Standard(s) Section | Description | Test Result | Judgement | Remark |
| 15.207 | AC Power Line Conducted Emissions | APPENDIX A | Pass | ----- |
| 15.205 15.209 15.247(d) | Radiated Emissions | APPENDIX B APPENDIX C | Pass | ----- |
| 15.247 (a)(1)(iii) | Number of Hopping Frequency | APPENDIX D | Pass | ----- |
| 15.247 (a)(1)(iii) | Average Time of Occupancy | APPENDIX E | Pass | ----- |
| 15.247 (a)(1) | Hopping Channel Separation | APPENDIX F | Pass | ----- |
| 15.247 (a)(1) | Bandwidth | APPENDIX G | Pass | ----- |
| 15.247 (b)(1) | Output Power | APPENDIX H | Pass | ----- |
| 15.247(d) | Antenna conducted Spurious Emission | APPENDIX I | Pass | ----- |
| 15.203 | Antenna Requirement | ----- | Pass | ----- |

NOTE:

- (1) "N/A" denotes test is not applicable in this Test Report.
- (2) The report format version is TP.1.1.1.

1.1 TEST FACILITY

The test facilities used to collect the test data in this report:

No. 68-1, Ln. 169, Sec. 2, Datong Rd., Xizhi Dist., New Taipei City 221, Taiwan

The test sites and facilities are covered under FCC RN: 674415 and DN: TW0659.

- C05 CB08 CB11 CB15 CB16
 SR05

1.2 MEASUREMENT UNCERTAINTY

The reported uncertainty of measurement $y \pm U$, where expanded uncertainty U is based on a standard uncertainty multiplied by a coverage factor of $k = 2$, providing a level of confidence of approximately **95 %**. The measurement instrumentation uncertainty considerations contained in CISPR 16-4-2. The BTL measurement uncertainty is less than the CISPR 16-4-2 U_{CISPR} requirement.

A. AC power line conducted emissions test:

| Test Site | Method | Measurement Frequency Range | U (dB) |
|-----------|--------|-----------------------------|--------|
| C05 | CISPR | 150 kHz ~ 30 MHz | 3.44 |

B. Radiated emissions test :

| Test Site | Measurement Frequency Range | U,(dB) |
|-----------|-----------------------------|--------|
| CB15 | 0.03 GHz ~ 0.2 GHz | 4.17 |
| | 0.2 GHz ~ 1 GHz | 4.72 |
| | 1 GHz ~ 6 GHz | 5.21 |
| | 6 GHz ~ 18 GHz | 5.51 |
| | 18 GHz ~ 26 GHz | 3.69 |
| | 26 GHz ~ 40 GHz | 4.23 |

C. Conducted test :

| Test Item | U,(dB) |
|------------------------------|--------|
| Occupied Bandwidth | 0.5338 |
| Output power | 0.3659 |
| Conducted Spurious emissions | 0.5416 |
| Conducted Band edges | 0.5348 |
| Dwell time | 0.6606 |
| Channel separation | 0.6606 |
| Channel numbers | 0.6606 |

NOTE:

Unless specifically mentioned, the uncertainty of measurement has not been taken into account to declare the compliance or non-compliance to the specification.

1.3 TEST ENVIRONMENT CONDITIONS

| Test Item | Environment Condition | Test Voltage | Tested by |
|-------------------------------------|-----------------------|--------------|-------------|
| AC Power Line Conducted Emissions | 22 °C, 56 % | AC 120V | Paul Shen |
| Radiated emissions below 1 GHz | 22 °C, 54 % | AC 120V | Vincent Lee |
| Radiated emissions above 1 GHz | 22 °C, 54 % | AC 120V | Vincent Lee |
| Number of Hopping Frequency | 26 °C, 60 % | AC 120V | Josh Lin |
| Average Time of Occupancy | 26 °C, 60 % | AC 120V | Josh Lin |
| Hopping Channel Separation | 26 °C, 60 % | AC 120V | Josh Lin |
| Bandwidth | 26 °C, 60 % | AC 120V | Josh Lin |
| Output Power | 25.9 °C, 46 % | AC 120V | Paul Shen |
| Antenna conducted Spurious Emission | 26 °C, 60 % | AC 120V | Josh Lin |

1.4 TABLE OF PARAMETERS OF TEST SOFTWARE SETTING

| Test Software | CMD | | | |
|----------------|----------|----------|----------|-----------|
| | 2402 MHz | 2441 MHz | 2480 MHz | Data Rate |
| GFSK | 0 | 2 | 8 | 1 Mbps |
| $\pi/4$ -DQPSK | 8 | 8 | 8 | 2 Mbps |
| 8DPSK | 8 | 8 | 8 | 3 Mbps |

1.5 DUTY CYCLE

If duty cycle is $\geq 98\%$, duty factor is not required.
 If duty cycle is $< 98\%$, duty factor shall be considered.

| Remark | Delta 1 | | | Delta 2 | On Time/Period | 10 log(1/Duty Cycle) |
|-------------|---------|--------------|------------------|----------------------|----------------|----------------------|
| Mode | ON (ms) | Numbers (ON) | On Time (B) (ms) | Period (ON+OFF) (ms) | Duty Cycle (%) | Duty Factor (dB) |
| BT (1 Mbps) | 3.056 | 1 | 3.056 | 3.776 | 80.93% | 0.92 |
| BT (3 Mbps) | 3.061 | 1 | 3.061 | 3.781 | 80.96% | 0.92 |

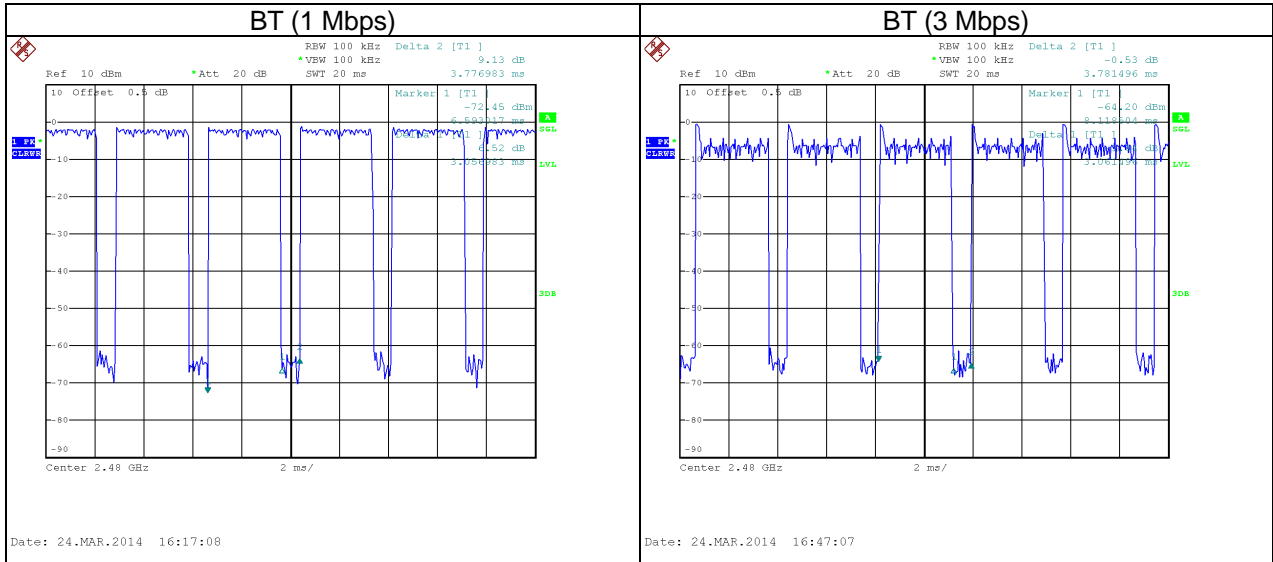

2 GENERAL INFORMATION

2.1 DESCRIPTION OF EUT

| | |
|-----------------------|---|
| Equipment | Bluetooth Barcode Scanner |
| Model Name | OPN-4000i |
| Brand Name | OPTICON |
| Model Difference | N/A |
| Power Source | #1 Supplied from USB port. #2 Supplied from battery. |
| Power Rating | #1 I/P: DC 5V #2 I/P: DC 3.7V, 600mAh(Li-ion) |
| Products Covered | N/A |
| Operation Band | 2400 MHz ~ 2483.5 MHz |
| Operation Frequency | 2402 MHz ~ 2480 MHz |
| Modulation Type | GFSK, $\pi/4$ -DQPSK, 8DPSK |
| Modulation Technology | FHSS |
| Transfer Rate | 1 Mbps, 2 Mbps, 3Mbps |
| Output Power Max. | 1 Mbps: -0.89 dBm (0.0008W) 2 Mbps: -0.62 dBm (0.0009W) 3 Mbps: -0.62 dBm (0.0009W) |
| Test Model | OPN-4000i |
| Sample Status | Engineering Sample |
| EUT Modification(s) | N/A |

NOTE:

- (1) For a more detailed features description, please refer to the manufacturer's specifications or the user's manual.
- (2) This is a supplement report of NEI-FCCP-1-1402201 report. The differences compared with original report are changed antenna and battery model.
After evaluated, the changes with respect to the original one, only AC power line conducted emissions , radiated emissions and output power tests need to be verified.

(3) Channel List:

| Channel | Frequency (MHz) | Channel | Frequency (MHz) | Channel | Frequency (MHz) |
|---------|-----------------|---------|-----------------|---------|-----------------|
| 00 | 2402 | 27 | 2429 | 54 | 2456 |
| 01 | 2403 | 28 | 2430 | 55 | 2457 |
| 02 | 2404 | 29 | 2431 | 56 | 2458 |
| 03 | 2405 | 30 | 2432 | 57 | 2459 |
| 04 | 2406 | 31 | 2433 | 58 | 2460 |
| 05 | 2407 | 32 | 2434 | 59 | 2461 |
| 06 | 2408 | 33 | 2435 | 60 | 2462 |
| 07 | 2409 | 34 | 2436 | 61 | 2463 |
| 08 | 2410 | 35 | 2437 | 62 | 2464 |
| 09 | 2411 | 36 | 2438 | 63 | 2465 |
| 10 | 2412 | 37 | 2439 | 64 | 2466 |
| 11 | 2413 | 38 | 2440 | 65 | 2467 |
| 12 | 2414 | 39 | 2441 | 66 | 2468 |
| 13 | 2415 | 40 | 2442 | 67 | 2469 |
| 14 | 2416 | 41 | 2443 | 68 | 2470 |
| 15 | 2417 | 42 | 2444 | 69 | 2471 |
| 16 | 2418 | 43 | 2445 | 70 | 2472 |
| 17 | 2419 | 44 | 2446 | 71 | 2473 |
| 18 | 2420 | 45 | 2447 | 72 | 2474 |
| 19 | 2421 | 46 | 2448 | 73 | 2475 |
| 20 | 2422 | 47 | 2449 | 74 | 2476 |
| 21 | 2423 | 48 | 2450 | 75 | 2477 |
| 22 | 2424 | 49 | 2451 | 76 | 2478 |
| 23 | 2425 | 50 | 2452 | 77 | 2479 |
| 24 | 2426 | 51 | 2453 | 78 | 2480 |
| 25 | 2427 | 52 | 2454 | | |
| 26 | 2428 | 53 | 2455 | | |

(4) Table for Filed Antenna:

| Ant. | Brand | Model Name | Antenna Type | Connector | Gain (dBi) |
|------|---------------------------|------------------|--------------|-----------|------------|
| 1 | OPTOELECTRONICS CO., LTD. | 2.4G PCB Antenna | PCB Layout | N/A | -0.86 |

2.2 TEST MODES

| Test Items | Test mode | Channel | Note |
|---|-------------|----------|----------|
| AC power line conducted emissions | Normal/Idle | - | - |
| Transmitter Radiated Emissions (below 1GHz) | 1 Mbps | 39 | - |
| Transmitter Radiated Emissions (above 1GHz) | 1/3 Mbps | 00/78 | Bandedge |
| | 1/3 Mbps | 00/39/78 | Harmonic |
| Number of Hopping Frequency | 1/3 Mbps | 00~78 | - |
| Average Time of Occupancy | 1/3 Mbps | 00/39/78 | - |
| Hopping Channel Separation | 1/3 Mbps | 00/39/78 | - |
| Bandwidth | 1/3 Mbps | 00/39/78 | - |
| Peak Output Power | 1/2/3 Mbps | 00/39/78 | - |
| Antenna conducted Spurious Emission | 1/3 Mbps | 00/39/78 | - |

NOTE:

- (1) For radiated emission band edge test, both Vertical and Horizontal are evaluated, but only the worst case (Horizontal) is recorded.
- (2) All X, Y and Z axes are evaluated, but only the worst case (X axis) is recorded.

2.3 BLOCK DIAGRAM SHOWING THE CONFIGURATION OF SYSTEM TESTED

Equipment letters and Cable numbers refer to item numbers described in the tables of clause 2.4.

AC power line conducted emissions

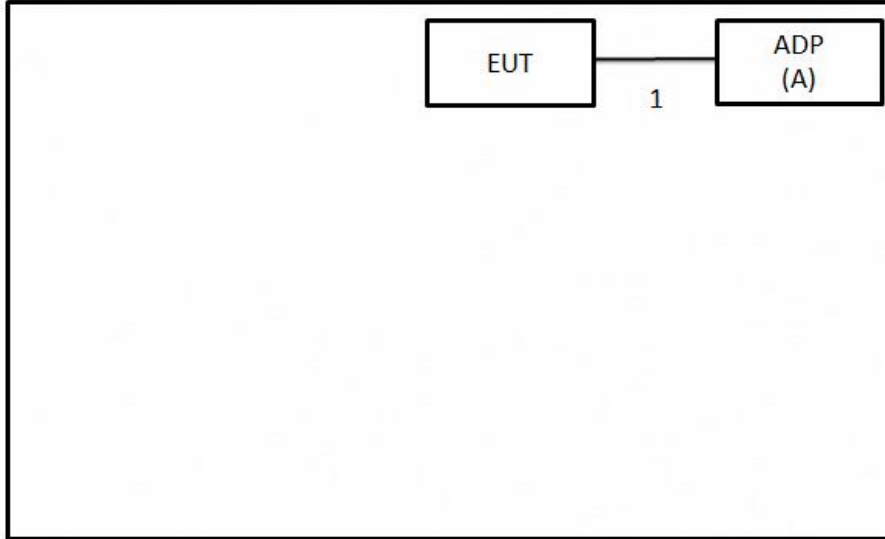

Radiated Emissions

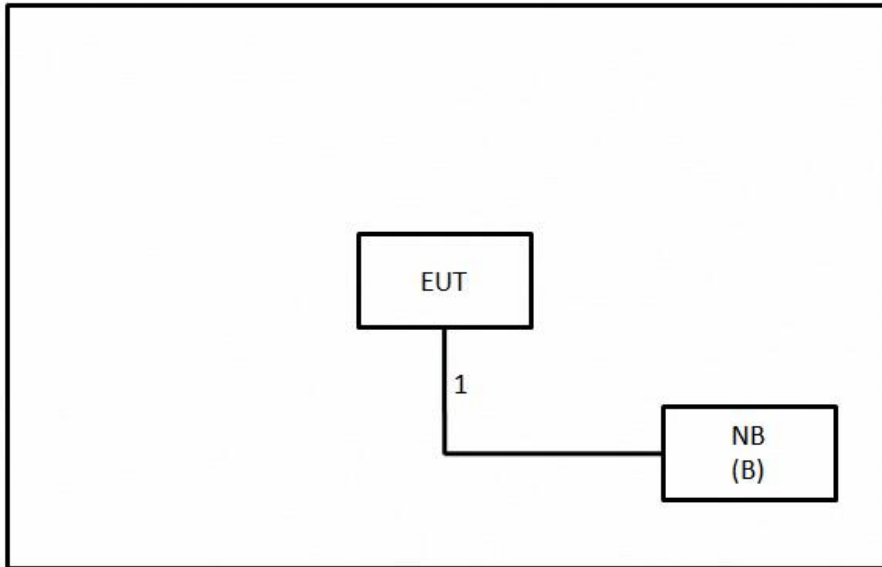

2.4 SUPPORT UNITS

| Item | Equipment | Brand | Model No. | Series No. | Remarks |
|------|-----------|--------|-----------|------------|------------------------|
| A | Adapter | GARMIN | ADP-58W | N/A | Furnished by test lab. |
| B | NB | Acer | MS2351 | N/A | Furnished by test lab. |

| Item | Shielded | Ferrite Core | Length | Cable Type | Remarks |
|------|----------|--------------|--------|------------|----------------------------|
| 1 | N/A | N/A | 1m | USB Cable | Supplied by test requester |

3 AC POWER LINE CONDUCTED EMISSIONS TEST

3.1 LIMIT

| Frequency (MHz) | Limit (dB μ V) | |
|-----------------|--------------------|-----------|
| | Quasi-peak | Average |
| 0.15 - 0.5 | 66 - 56 * | 56 - 46 * |
| 0.50 - 5.0 | 56 | 46 |
| 5.0 - 30.0 | 60 | 50 |

NOTE:

- (1) The tighter limit applies at the band edges.
- (2) The limit of " * " marked band means the limitation decreases linearly with the logarithm of the frequency in the range.
- (3) The test result calculated as following:
 Measurement Value = Reading Level + Correct Factor
 Correct Factor = Insertion Loss + Cable Loss + Attenuator Factor (if use)
 Margin Level = Measurement Value – Limit Value
 Calculation example:

| | | | | |
|---------------|---|----------------|---|-------------------|
| Reading Level | | Correct Factor | | Measurement Value |
| 38.22 | + | 3.45 | = | 41.67 |

| | | | | |
|-------------------|---|-------------|---|--------------|
| Measurement Value | | Limit Value | | Margin Level |
| 41.67 | - | 60 | = | -18.33 |

The following table is the setting of the receiver.

| Receiver Parameter | Setting |
|--------------------|----------|
| Attenuation | 10 dB |
| Start Frequency | 0.15 MHz |
| Stop Frequency | 30 MHz |
| IF Bandwidth | 9 KHz |

3.2 TEST PROCEDURE

- a. The EUT was placed 0.8 m above the horizontal ground plane with the EUT being connected to the power mains through a line impedance stabilization network (LISN).
 All other support equipment were powered from an additional LISN(s).
 The LISN provides 50 Ohm/50uH of impedance for the measuring instrument.
- b. Interconnecting cables that hang closer than 40 cm to the ground plane shall be folded back and forth in the center forming a bundle to keep the cable above 40 cm.
- c. Excess I/O cables that are not connected to a peripheral shall be bundled in the center.
 The end of the cable will be terminated, using the correct terminating impedance.
 The overall length shall not exceed 1 m.
- d. The LISN is spaced at least 80 cm from the nearest part of the EUT chassis.
- e. For the actual test configuration, please refer to the related Item - EUT TEST PHOTO.

NOTE:

- (1) In the results, each reading is marked as Peak, QP or AVG per the detector used.
 BW=9 kHz (6 dB Bandwidth)
- (2) All readings are Peak unless otherwise stated QP or AVG in column of Note. Both the QP and the AVG readings must be less than the limit for compliance.

3.3 DEVIATION FROM TEST STANDARD

No deviation.

3.4 TEST SETUP

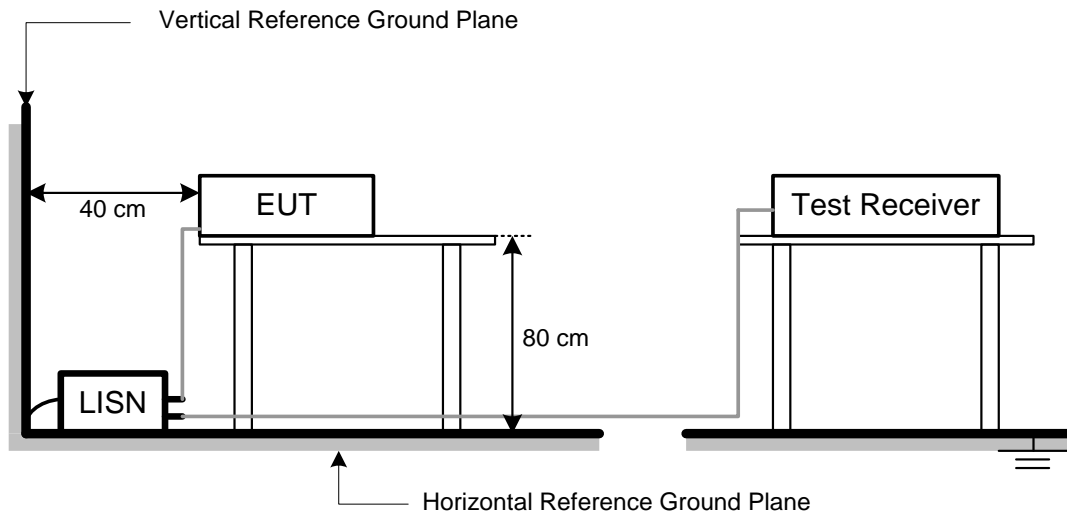

3.5 TEST RESULT

Please refer to the APPENDIX A.

4 RADIATED EMISSIONS TEST

4.1 LIMIT

In case the emission fall within the restricted band specified on 15.205, then the 15.209 limit in the table below has to be followed.

LIMITS OF RADIATED EMISSIONS MEASUREMENT (9 kHz to 1000 MHz)

| Frequency (MHz) | Field Strength (microvolts/meter) | Measurement Distance (meters) |
|-----------------|-----------------------------------|-------------------------------|
| 0.009~0.490 | 2400/F(KHz) | 300 |
| 0.490~1.705 | 24000/F(KHz) | 30 |
| 1.705~30.0 | 30 | 30 |
| 30~88 | 100 | 3 |
| 88~216 | 150 | 3 |
| 216~960 | 200 | 3 |
| 960~1000 | 500 | 3 |

LIMITS OF RADIATED EMISSIONS MEASUREMENT (Above 1000 MHz)

| Frequency (MHz) | Radiated Emissions (dBuV/m) | | Measurement Distance (meters) |
|-----------------|-----------------------------|---------|-------------------------------|
| | Peak | Average | |
| Above 1000 | 74 | 54 | 3 |

NOTE:

- (1) The limit for radiated test was performed according to FCC Part 15, Subpart C.
- (2) The tighter limit applies at the band edges.
- (3) Emission level (dBuV/m)=20log Emission level (uV/m).
- (4) The test result calculated as following:

Measurement Value = Reading Level + Correct Factor

Correct Factor = Antenna Factor + Cable Loss - Amplifier Gain(if use)

Margin Level = Measurement Value - Limit Value

Calculation example:

| | | | | |
|---------------|---|----------------|---|-------------------|
| Reading Level | | Correct Factor | | Measurement Value |
| 35.45 | + | -11.37 | = | 24.08 |

| | | | | |
|-------------------|---|-------------|---|--------------|
| Measurement Value | | Limit Value | | Margin Level |
| 24.08 | - | 40 | = | -15.92 |

| Spectrum Parameter | Setting |
|--|---|
| Attenuation | Auto |
| Start Frequency | 1000 MHz |
| Stop Frequency | 10th carrier harmonic |
| RBW / VBW (Emission in restricted band) | 1MHz / 3MHz for Peak, 1MHz / 1/T for Average |

| Spectrum Parameter | Setting |
|------------------------|-----------------------------------|
| Attenuation | Auto |
| Start ~ Stop Frequency | 9KHz~90KHz for PK/AVG detector |
| Start ~ Stop Frequency | 90KHz~110KHz for QP detector |
| Start ~ Stop Frequency | 110KHz~490KHz for PK/AVG detector |
| Start ~ Stop Frequency | 490KHz~30MHz for QP detector |
| Start ~ Stop Frequency | 30MHz~1000MHz for QP detector |

4.2 TEST PROCEDURE

- a. The measuring distance of 3 m shall be used for measurements. The EUT was placed on the top of a rotating table 0.8 meter above the ground at a 3 meter semi-anechoic chamber. The table was rotated 360 degrees to determine the position of the highest radiation.(below 1GHz)
- b. The measuring distance of 3 m shall be used for measurements. The EUT was placed on the top of a rotating table 1.5 meter above the ground at a 3 meter semi-anechoic chamber. The table was rotated 360 degrees to determine the position of the highest radiation.(above 1GHz)
- c. The height of the equipment or of the substitution antenna shall be 0.8 m or 1.5 m, the height of the test antenna shall vary between 1 m to 4 m. Both horizontal and vertical polarizations of the antenna are set to make the measurement.
- d. For each suspected emission, the EUT was arranged to its worst case and then the antenna was tuned to heights find the maximum reading (used Bore sight function).
- e. The receiver system was set to peak and average detect function and specified bandwidth with maximum hold mode when the test frequency is above 1GHz.
- f. The initial step in collecting radiated emission data is a receiver peak detector mode pre-scanning the measurement frequency range. Significant peaks are then marked and then Quasi Peak detector mode re-measured.
- g. All readings are Peak unless otherwise stated QP in column of Note. Peak denotes that the Peak reading compliance with the QP Limits and then QP Mode measurement didn't perform. (below 1GHz)
- h. All readings are Peak Mode value unless otherwise stated AVG in column of Note. If the Peak Mode Measured value compliance with the Peak Limits and lower than AVG Limits, the EUT shall be deemed to meet both Peak & AVG Limits and then only Peak Mode was measured, but AVG Mode didn't perform. (above 1GHz)
- i. For the actual test configuration, please refer to the related Item – EUT TEST PHOTO.

4.3 DEVIATION FROM TEST STANDARD

No deviation.

4.4 TEST SETUP

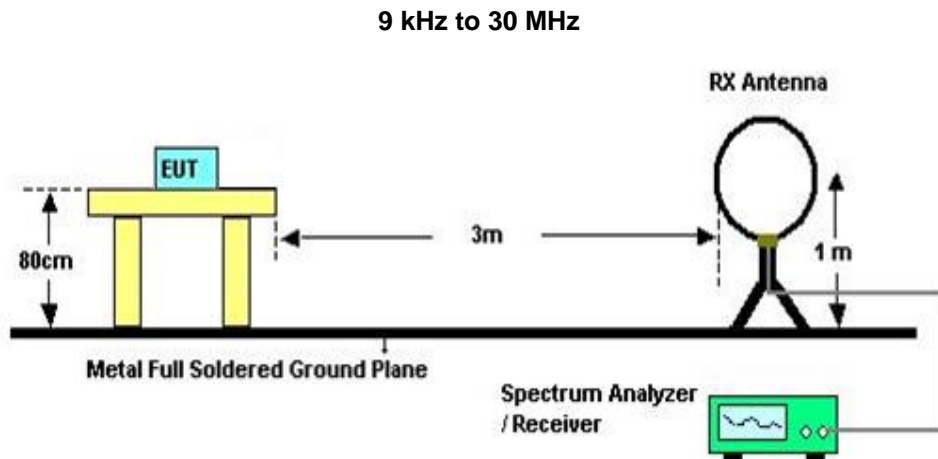

30 MHz to 1 GHz

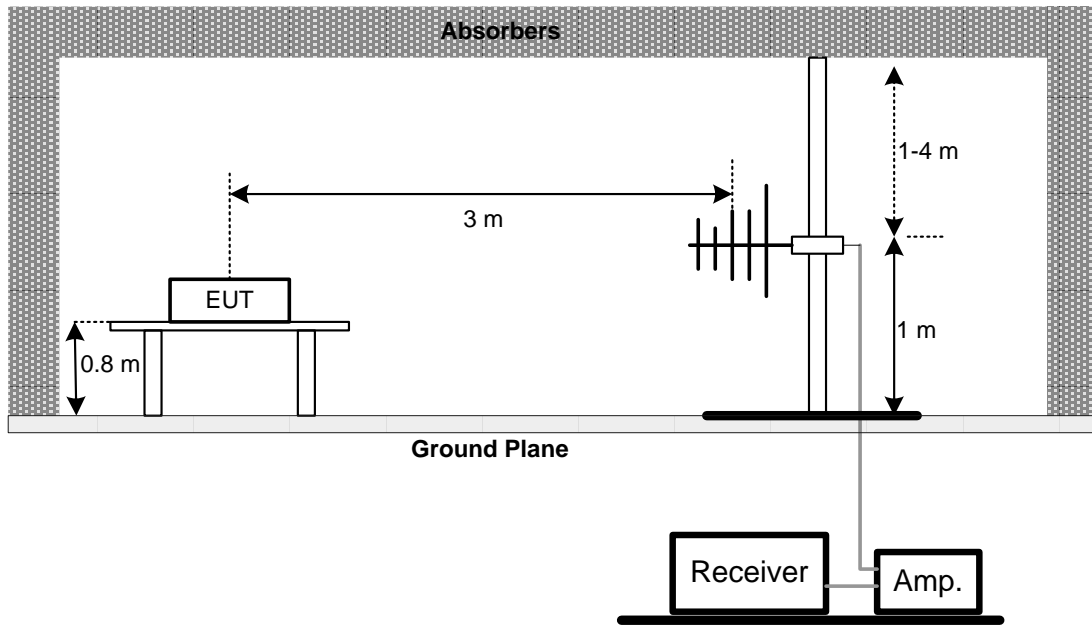

Above 1 GHz

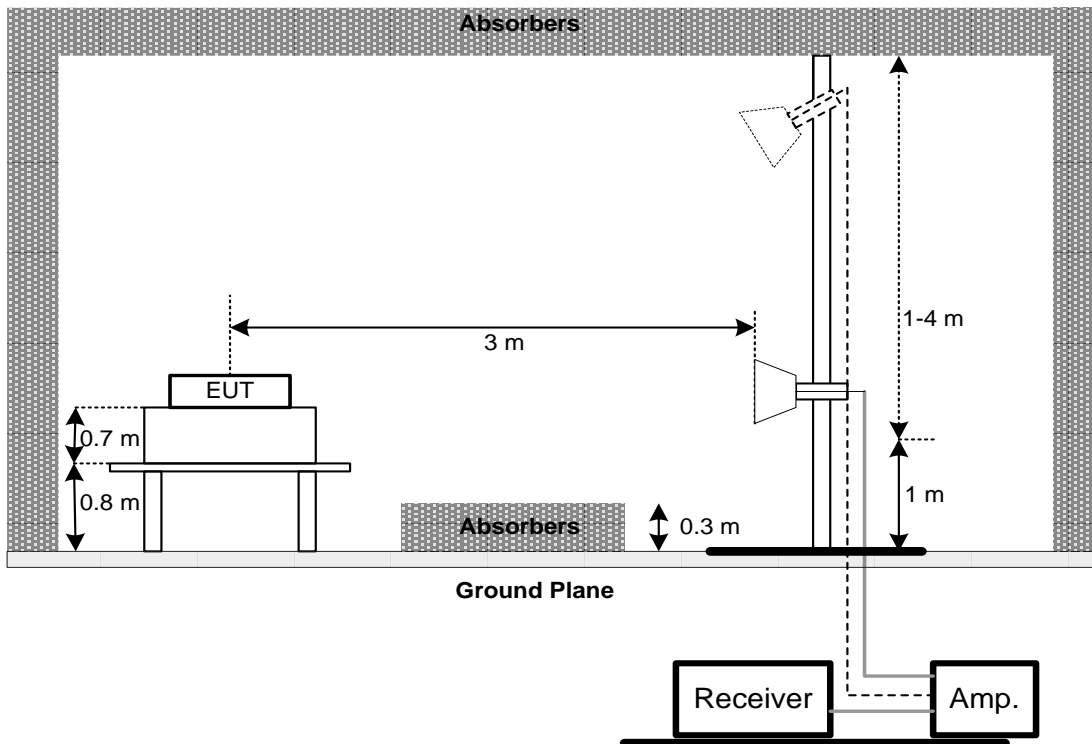

4.5 EUT OPERATING CONDITIONS

The EUT was programmed to be in continuously transmitting mode.

4.6 TEST RESULT – BELOW 30 MHZ

There were no emissions found below 30 MHz within 20 dB of the limit.

4.7 TEST RESULT – 30 MHZ TO 1 GHZ

Please refer to the APPENDIX B.

4.8 TEST RESULT – ABOVE 1 GHZ

Please refer to the APPENDIX C.

NOTE:

- (1) No limit: This is fundamental signal, the judgment is not applicable.
For fundamental signal judgment was referred to Peak output test.

5 NUMBER OF HOPPING CHANNEL

5.1 APPLIED PROCEDURES

| FCC Part15 (15.247) , Subpart C | | | |
|---------------------------------|---------------------------|-----------------------|--------|
| Section | Test Item | Frequency Range (MHz) | Result |
| 15.247(a)(1)(iii) | Number of Hopping Channel | 2400-2483.5 | PASS |

| Spectrum Parameters | Setting |
|---------------------|-----------------------------|
| Attenuation | Auto |
| Span Frequency | > Operating Frequency Range |
| RBW | 100 KHz |
| VBW | 100 KHz |
| Detector | Peak |
| Trace | Max Hold |
| Sweep Time | Auto |

5.2 TEST PROCEDURE

- a. The EUT was directly connected to the spectrum analyzer and antenna output port as show in the block diagram below,
- b. Spectrum Setting: RBW=100KHz, VBW=100KHz, Sweep time = Auto.

5.3 DEVIATION FROM STANDARD

No deviation.

5.4 TEST SETUP

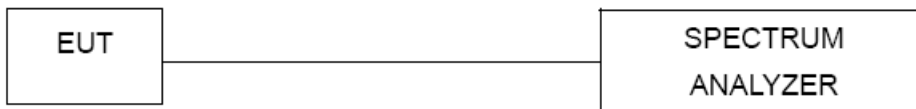

5.5 EUT OPERATION CONDITIONS

The EUT tested system was configured as the statements of 3.5 unless otherwise a special operating condition is specified in the follows during the testing.

5.6 TEST RESULTS

Please refer to the APPENDIX D.

6 AVERAGE TIME OF OCCUPANCY

6.1 APPLIED PROCEDURES / LIMIT

| FCC Part15 (15.247) , Subpart C | | | | |
|---------------------------------|---------------------------|--------|-----------------------|--------|
| Section | Test Item | Limit | Frequency Range (MHz) | Result |
| 15.247(a)(1)(iii) | Average Time of Occupancy | 0.4sec | 2400-2483.5 | PASS |

6.2 TEST PROCEDURE

- a. The transmitter output (antenna port) was connected to the spectrum analyzer
- b. Set RBW of spectrum analyzer to 1MHz and VBW to 1MHz.
- c. Use a video trigger with the trigger level set to enable triggering only on full pulses.
- d. Sweep Time is more than once pulse time.
- e. Set the center frequency on any frequency would be measure and set the frequency span to zero span.
- f. Measure the maximum time duration of one single pulse.
- g. Set the EUT for DH5, DH3 and DH1 packet transmitting.
- h. Measure the maximum time duration of one single pulse.
- i. Measure the maximum time duration of one single pulse.
 $A \text{ Period Time} = (\text{channel number}) * 0.4$

For Non-AFH Mode (79 Channel):

DH1 Time Solt: Reading * (1600/6)/79 * (0.4 * 79)

DH3 Time Solt: Reading * (1600/6)/79 * (0.4 * 79)

DH5 Time Solt: Reading * (1600/6)/79 * (0.4 * 79)

For AFH Mode (20 Channel):

DH1 Time Solt: Reading * (800/6)/20 * (0.4 * 20)

DH3 Time Solt: Reading * (800/6)/20 * (0.4 * 20)

DH5 Time Solt: Reading * (800/6)/20 * (0.4 * 20)

6.3 DEVIATION FROM STANDARD

No deviation.

6.4 TEST SETUP



6.5 EUT OPERATION CONDITIONS

The EUT tested system was configured as the statements of 3.5 unless otherwise a special operating condition is specified in the follows during the testing.

6.6 TEST RESULTS

Please refer to the APPENDIX E.

7 Hopping Channel Separation Measurement

7.1 APPLIED PROCEDURES / LIMIT

Frequency hopping systems operating in the 2400-2483.5 MHz band may have hopping channel carrier frequencies that are separated by 25 KHz or two-thirds of the 20 dB bandwidth of the hopping channel, whichever is greater.

| Spectrum Parameter | Setting |
|--------------------|---|
| Attenuation | Auto |
| Span Frequency | > Measurement Bandwidth or Channel Separation |
| RBW | 30 KHz |
| VBW | 100 KHz |
| Detector | Peak |
| Trace | Max Hold |
| Sweep Time | Auto |

7.2 TEST PROCEDURE

- a. The EUT must have its hopping function enabled
- b. Span = wide enough to capture the peaks of two adjacent channels
 Resolution (or IF) Bandwidth (RBW) \geq 1% of the span
 Video (or Average) Bandwidth (VBW) \geq RBW
 Sweep = Auto
 Detector function = Peak
 Trace = Max Hold

7.3 DEVIATION FROM STANDARD

No deviation.

7.4 TEST SETUP

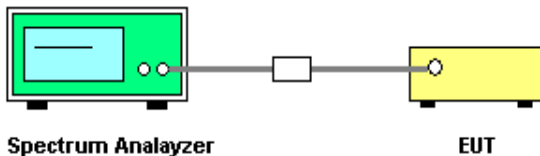

7.5 TEST RESULTS

Please refer to the APPENDIX F.

8 BANDWIDTH TEST

8.1 APPLIED PROCEDURES

| FCC Part15 (15.247) , Subpart C | | |
|---------------------------------|-----------|-----------------------|
| Section | Test Item | Frequency Range (MHz) |
| 15.247(a)(2) | Bandwidth | 2400-2483.5 |

| Spectrum Parameter | Setting |
|--------------------|---|
| Attenuation | Auto |
| Span Frequency | > Measurement Bandwidth or Channel Separation |
| RBW | 30 KHz (20dB Bandwidth) / 30 KHz (Channel Separation) |
| VBW | 100 KHz (20dB Bandwidth) / 100 KHz (Channel Separation) |
| Detector | Peak |
| Trace | Max Hold |
| Sweep Time | Auto |

8.2 TEST PROCEDURE

- a. The EUT was directly connected to the spectrum analyzer and antenna output port as show in the block diagram below,
- b. Spectrum Setting: RBW= 30KHz, VBW=100KHz, Sweep Time = Auto.

8.3 DEVIATION FROM STANDARD

No deviation.

8.4 TEST SETUP

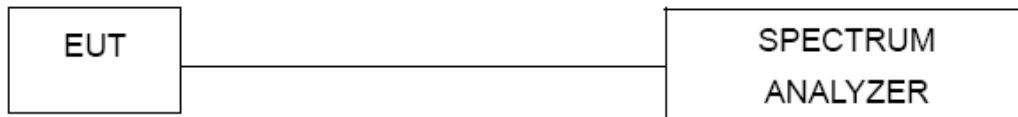

8.5 EUT OPERATION CONDITIONS

The EUT tested system was configured as the statements of 3.5 unless otherwise a special operating condition is specified in the follows during the testing.

8.6 TEST RESULTS

Please refer to the APPENDIX G.

9 OUTPUT POWER TEST**9.1 APPLIED PROCEDURES / LIMIT**

| FCC Part15 (15.247) , Subpart C | | | | |
|---------------------------------|-------------------|--------------------|-----------------------|--------|
| Section | Test Item | Limit | Frequency Range (MHz) | Result |
| 15.247(b)(1) | Peak Output Power | 0.125Watt or 21dBm | 2400-2483.5 | PASS |

9.2 TEST PROCEDURE

- a. The EUT was directly connected to the spectrum analyzer and antenna output port as show in the block diagram below,
- b. Spectrum Setting: RBW= 3MHz, VBW= 3MHz, Sweep time = Auto.

9.3 DEVIATION FROM STANDARD

No deviation.

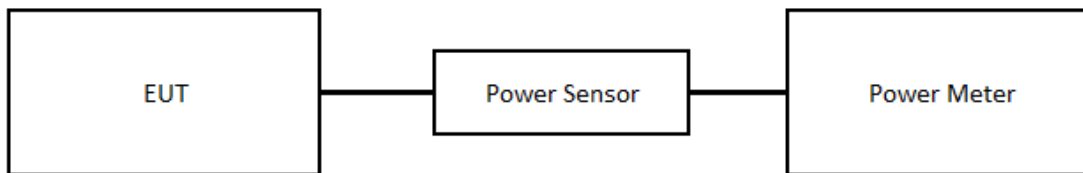
9.4 TEST SETUP**9.5 EUT OPERATION CONDITIONS**

The EUT tested system was configured as the statements of 3.5 unless otherwise a special operating condition is specified in the follows during the testing.

9.6 TEST RESULTS

Please refer to the APPENDIX H.

10 ANTENNA CONDUCTED SPURIOUS EMISSION

10.1 APPLIED PROCEDURES / LIMIT

In any 100 kHz bandwidth outside the frequency band in which the spread spectrum or digitally modulated device is operating, the RF power that is produced shall be at least 20 dB below that in the 100 kHz bandwidth within the band that contains the highest level of the desired power, based on either an RF conducted or a radiated measurement, provided that the transmitter demonstrates compliance with the peak conducted power limits.

10.2 TEST PROCEDURE

- a. The EUT was directly connected to the spectrum analyzer and antenna output port as show in the block diagram below,
- b. Spectrum Setting: RBW= 100KHz, VBW=100KHz, Sweep time = Auto.
- c. Offset=antenna gain+cable loss

10.3 DEVIATION FROM STANDARD

No deviation.

10.4 TEST SETUP

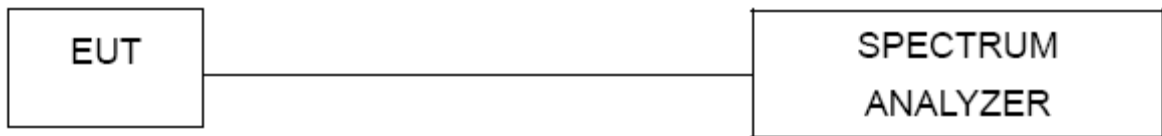

10.5 EUT OPERATION CONDITIONS

The EUT tested system was configured as the statements of 3.5 unless otherwise a special operating condition is specified in the follows during the testing.

10.6 TEST RESULTS

Please refer to the APPENDIX I.

11 LIST OF MEASURING EQUIPMENTS

| AC Power Line Conducted Emissions | | | | | | |
|-----------------------------------|----------------------|--------------|-----------------------------|------------|-----------------|------------------|
| Item | Kind of Equipment | Manufacturer | Type No. | Serial No. | Calibrated Date | Calibrated Until |
| 1 | TWO-LINE V-NETWORK | R&S | ENV216 | 101339 | 2021/3/10 | 2022/3/9 |
| 2 | Test Cable | EMCI | EMCRG58-BM-B M-9000 | 210501 | 2021/5/3 | 2022/5/2 |
| 3 | EMI Test Receiver | R&S | ESR 7 | 101433 | 2020/12/11 | 2021/12/10 |
| 4 | Measurement Software | EZ | EZ EMC (Version NB-03A1-01) | N/A | N/A | N/A |

| Radiated Emissions | | | | | | |
|--------------------|--------------------------|-----------------|-----------------------------|---------------|-----------------|------------------|
| Item | Kind of Equipment | Manufacturer | Type No. | Serial No. | Calibrated Date | Calibrated Until |
| 1 | Preamplifier | EMCI | EMC02325B | 980217 | 2021/4/8 | 2022/4/7 |
| 2 | Preamplifier | EMCI | EMC012645B | 980267 | 2021/4/8 | 2022/4/7 |
| 3 | Preamplifier | EMCI | EMC001340 | 980555 | 2021/4/8 | 2022/4/7 |
| 4 | Test Cable | EMCI | EMC-SM-SM-1000 | 180809 | 2021/4/8 | 2022/4/7 |
| 5 | Test Cable | EMCI | EMC104-SM-SM-3000 | 151205 | 2021/4/8 | 2022/4/7 |
| 6 | Test Cable | EMCI | EMC-SM-SM-7000 | 180408 | 2021/4/8 | 2022/4/7 |
| 7 | MXE EMI Receiver | Agilent | N9038A | MY554200087 | 2021/5/27 | 2022/5/26 |
| 8 | Signal Analyzer | Agilent | N9010A | MY56480554 | 2021/8/25 | 2022/8/24 |
| 9 | Loop Ant | Electro-Metrics | EMCI-LPA600 | 274 | 2021/6/1 | 2022/5/31 |
| 10 | Horn Ant | SCHWARZBECK | BBHA 9120D | 9120D-1342 | 2021/6/2 | 2022/6/1 |
| 11 | Horn Ant | Schwarzbeck | BBHA 9170 | BBHA 9170340 | 2021/7/9 | 2022/7/8 |
| 12 | Trilog-Broadband Antenna | Schwarzbeck | VULB 9168 | VULB 9168-352 | 2021/8/11 | 2022/8/10 |
| 13 | 5dB Attenuator | EMCI | EMCI-N-6-05 | AT-N0625 | 2021/8/11 | 2022/8/10 |
| 14 | Measurement Software | EZ | EZ EMC (Version NB-03A1-01) | N/A | N/A | N/A |

| Number of Hopping Frequency | | | | | |
|-----------------------------|-------------------|--------------|----------|------------|------------------|
| Item | Kind of Equipment | Manufacturer | Type No. | Serial No. | Calibrated Until |
| 1 | Spectrum Analyzer | R&S | FSP-30 | 100854 | Sep. 08, 2014 |

| Average Time of Occupancy | | | | | |
|---------------------------|-------------------|--------------|----------|------------|------------------|
| Item | Kind of Equipment | Manufacturer | Type No. | Serial No. | Calibrated Until |
| 1 | Spectrum Analyzer | R&S | FSP-30 | 100854 | Sep. 08, 2014 |

| Hopping Channel Separation | | | | | |
|----------------------------|-------------------|--------------|----------|------------|------------------|
| Item | Kind of Equipment | Manufacturer | Type No. | Serial No. | Calibrated Until |
| 1 | Spectrum Analyzer | R&S | FSP-30 | 100854 | Sep. 08, 2014 |

| Bandwidth | | | | | |
|-----------|-------------------|--------------|----------|------------|------------------|
| Item | Kind of Equipment | Manufacturer | Type No. | Serial No. | Calibrated Until |
| 1 | Spectrum Analyzer | R&S | FSP-30 | 100854 | Sep. 08, 2014 |

| Output Power | | | | | | |
|--------------|-------------------|--------------|----------|------------|-----------------|------------------|
| Item | Kind of Equipment | Manufacturer | Type No. | Serial No. | Calibrated Date | Calibrated Until |
| 1 | Power Meter | Anritsu | ML2487A | 6K00004714 | 2021/8/15 | 2022/8/14 |
| 2 | Power Sensor | Anritsu | MA2491A | 034138 | 2021/8/15 | 2022/8/14 |

| Antenna conducted Spurious Emission | | | | | |
|-------------------------------------|-------------------|--------------|----------|------------|------------------|
| Item | Kind of Equipment | Manufacturer | Type No. | Serial No. | Calibrated Until |
| 1 | Spectrum Analyzer | R&S | FSP-30 | 100854 | Sep. 08, 2014 |

| Antenna conducted Spurious Emission(Hopping) | | | | | | |
|--|-------------------|--------------|----------|------------|-----------------|------------------|
| Item | Kind of Equipment | Manufacturer | Type No. | Serial No. | Calibrated Date | Calibrated Until |
| 1 | Power Meter | Anritsu | ML2487A | 6K00004714 | 2021/8/15 | 2022/8/14 |

Remark: "N/A" denotes no model name, no serial no. or no calibration specified.
 All calibration period of equipment list is one year.

12 EUT TEST PHOTO

Please refer to document Appendix No.: TP-2106T008-FCCP-1 (APPENDIX-TEST PHOTOS).

13 EUT PHOTOS

Please refer to document Appendix No.: EP-2106T008-4 (APPENDIX-EUT PHOTOS).

APPENDIX A AC POWER LINE CONDUCTED EMISSIONS

| | | | |
|----------------|--------|-------------|-----------|
| Test Mode | Normal | Tested Date | 2021/7/16 |
| Test Frequency | - | Phase | Line |

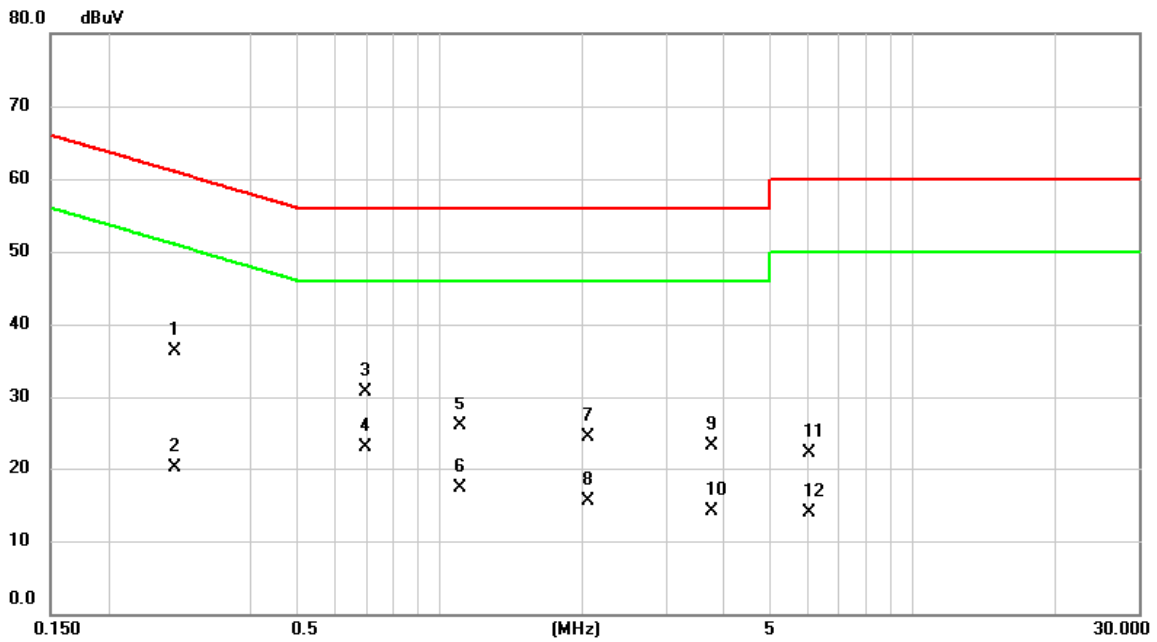

| No. | Mk. | Freq. MHz | Reading Level dBuV | Correct Factor dB | Measurement dBuV | Limit dBuV | Over dB | Detector | Comment |
|-----|-----|-----------|--------------------|-------------------|------------------|------------|---------|----------|---------|
| 1 | | 0.2737 | 26.65 | 9.71 | 36.36 | 61.00 | -24.64 | QP | |
| 2 | | 0.2737 | 10.32 | 9.71 | 20.03 | 51.00 | -30.97 | AVG | |
| 3 | | 0.6967 | 21.03 | 9.71 | 30.74 | 56.00 | -25.26 | QP | |
| 4 | * | 0.6967 | 13.20 | 9.71 | 22.91 | 46.00 | -23.09 | AVG | |
| 5 | | 1.1017 | 16.27 | 9.72 | 25.99 | 56.00 | -30.01 | QP | |
| 6 | | 1.1017 | 7.56 | 9.72 | 17.28 | 46.00 | -28.72 | AVG | |
| 7 | | 2.0558 | 14.45 | 9.76 | 24.21 | 56.00 | -31.79 | QP | |
| 8 | | 2.0558 | 5.69 | 9.76 | 15.45 | 46.00 | -30.55 | AVG | |
| 9 | | 3.7815 | 13.27 | 9.87 | 23.14 | 56.00 | -32.86 | QP | |
| 10 | | 3.7815 | 4.18 | 9.87 | 14.05 | 46.00 | -31.95 | AVG | |
| 11 | | 6.0473 | 12.19 | 10.00 | 22.19 | 60.00 | -37.81 | QP | |
| 12 | | 6.0473 | 3.94 | 10.00 | 13.94 | 50.00 | -36.06 | AVG | |

REMARKS:
 (1) Measurement Value = Reading Level + Correct Factor.
 (2) Margin Level = Measurement Value - Limit Value.

| | | | |
|----------------|--------|-------------|-----------|
| Test Mode | Normal | Tested Date | 2021/7/16 |
| Test Frequency | - | Phase | Neutral |

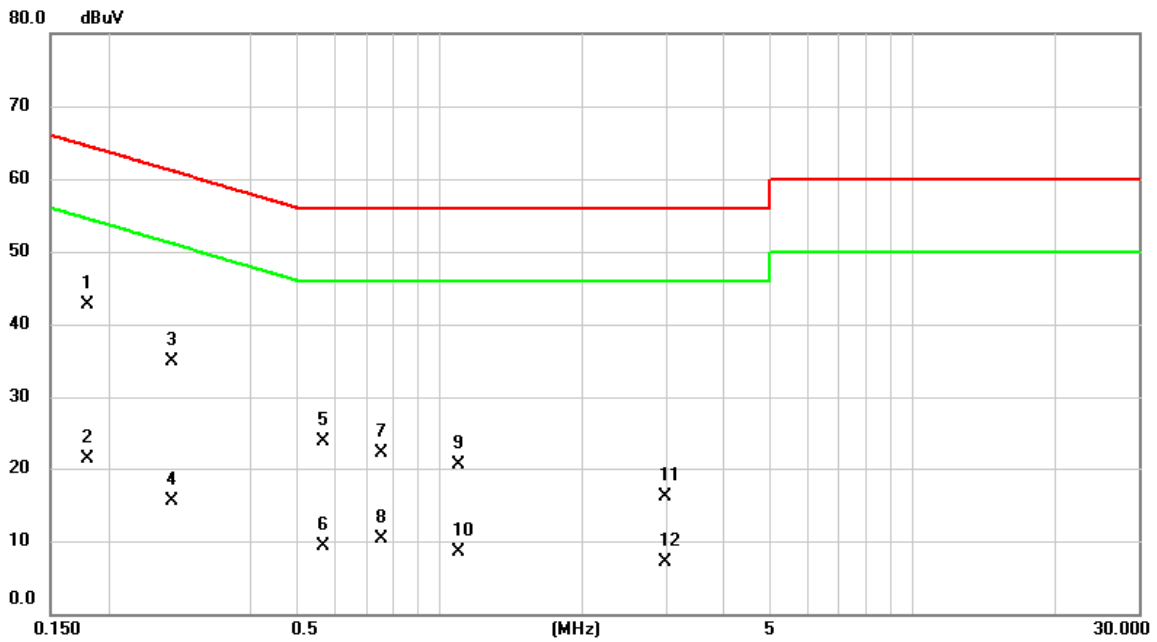

| No. | Mk. | Freq. (MHz) | Reading Level (dBuV) | Correct Factor (dB) | Measurement (dBuV) | Limit (dBuV) | Over (dB) | Detector | Comment |
|-----|-----|-------------|----------------------|---------------------|--------------------|--------------|-----------|----------|---------|
| 1 | * | 0.1793 | 32.98 | 9.71 | 42.69 | 64.52 | -21.83 | QP | |
| 2 | | 0.1793 | 11.69 | 9.71 | 21.40 | 54.52 | -33.12 | AVG | |
| 3 | | 0.2714 | 25.27 | 9.71 | 34.98 | 61.07 | -26.09 | QP | |
| 4 | | 0.2714 | 5.71 | 9.71 | 15.42 | 51.07 | -35.65 | AVG | |
| 5 | | 0.5662 | 14.02 | 9.71 | 23.73 | 56.00 | -32.27 | QP | |
| 6 | | 0.5662 | -0.32 | 9.71 | 9.39 | 46.00 | -36.61 | AVG | |
| 7 | | 0.7552 | 12.45 | 9.73 | 22.18 | 56.00 | -33.82 | QP | |
| 8 | | 0.7552 | 0.50 | 9.73 | 10.23 | 46.00 | -35.77 | AVG | |
| 9 | | 1.0950 | 10.68 | 9.73 | 20.41 | 56.00 | -35.59 | QP | |
| 10 | | 1.0950 | -1.13 | 9.73 | 8.60 | 46.00 | -37.40 | AVG | |
| 11 | | 2.9850 | 6.34 | 9.79 | 16.13 | 56.00 | -39.87 | QP | |
| 12 | | 2.9850 | -2.63 | 9.79 | 7.16 | 46.00 | -38.84 | AVG | |

REMARKS:
 (1) Measurement Value = Reading Level + Correct Factor.
 (2) Margin Level = Measurement Value - Limit Value.

| | | | |
|----------------|------|-------------|-----------|
| Test Mode | Idle | Tested Date | 2021/7/16 |
| Test Frequency | - | Phase | Line |

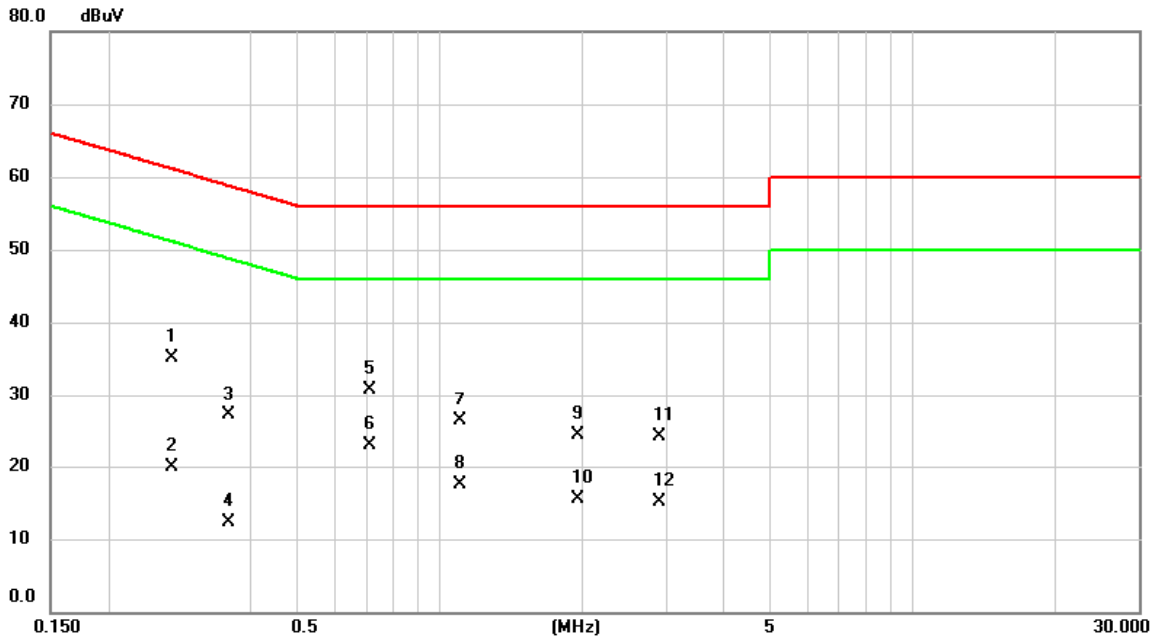

| No. | Mk. | Freq. MHz | Reading Level dBuV | Correct Factor dB | Measure- ment dBuV | Limit dBuV | Over dB | Detector | Comment |
|-----|-----|--------------|--------------------------|-------------------------|--------------------------|---------------|------------|----------|---------|
| 1 | | 0.2714 | 25.44 | 9.71 | 35.15 | 61.07 | -25.92 | QP | |
| 2 | | 0.2714 | 10.25 | 9.71 | 19.96 | 51.07 | -31.11 | AVG | |
| 3 | | 0.3592 | 17.38 | 9.70 | 27.08 | 58.75 | -31.67 | QP | |
| 4 | | 0.3592 | 2.69 | 9.70 | 12.39 | 48.75 | -36.36 | AVG | |
| 5 | | 0.7125 | 20.97 | 9.71 | 30.68 | 56.00 | -25.32 | QP | |
| 6 | * | 0.7125 | 13.15 | 9.71 | 22.86 | 46.00 | -23.14 | AVG | |
| 7 | | 1.1017 | 16.54 | 9.72 | 26.26 | 56.00 | -29.74 | QP | |
| 8 | | 1.1017 | 7.79 | 9.72 | 17.51 | 46.00 | -28.49 | AVG | |
| 9 | | 1.9523 | 14.62 | 9.76 | 24.38 | 56.00 | -31.62 | QP | |
| 10 | | 1.9523 | 5.82 | 9.76 | 15.58 | 46.00 | -30.42 | AVG | |
| 11 | | 2.9063 | 14.39 | 9.79 | 24.18 | 56.00 | -31.82 | QP | |
| 12 | | 2.9063 | 5.27 | 9.79 | 15.06 | 46.00 | -30.94 | AVG | |

REMARKS:
 (1) Measurement Value = Reading Level + Correct Factor.
 (2) Margin Level = Measurement Value - Limit Value.

| | | | |
|----------------|------|-------------|-----------|
| Test Mode | Idle | Tested Date | 2021/7/16 |
| Test Frequency | - | Phase | Neutral |

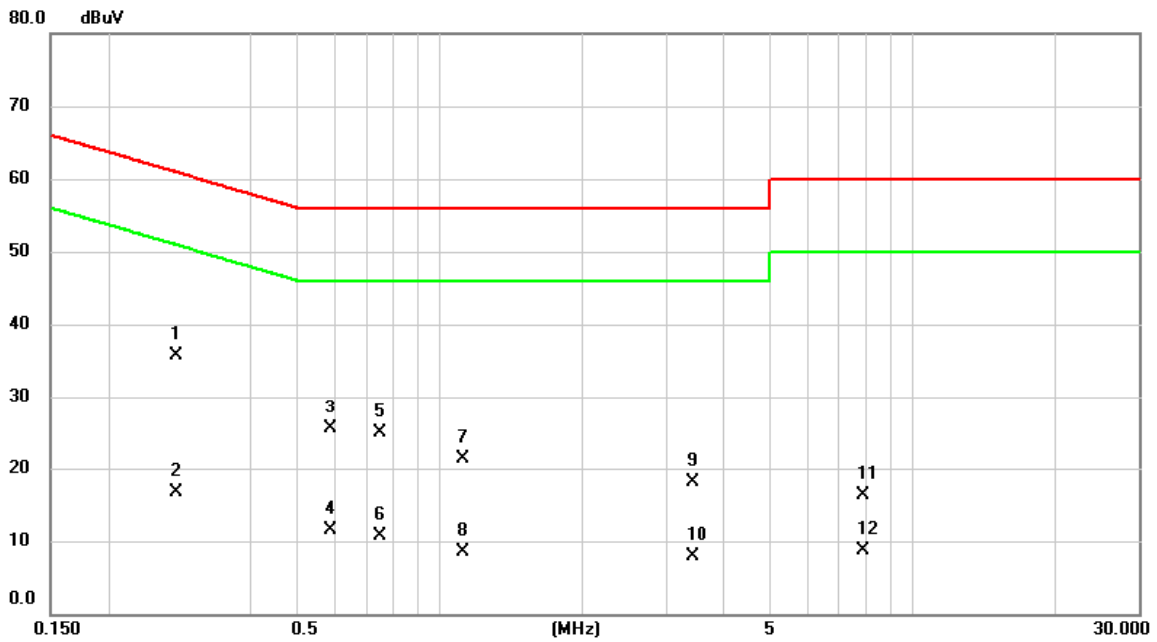

| No. | Mk. | Freq. MHz | Reading Level dBuV | Correct Factor dB | Measure- ment dBuV | Limit dBuV | Over dB | Detector | Comment |
|-----|-----|--------------|--------------------------|-------------------------|--------------------------|---------------|------------|----------|---------|
| 1 | * | 0.2760 | 26.02 | 9.71 | 35.73 | 60.94 | -25.21 | QP | |
| 2 | | 0.2760 | 7.05 | 9.71 | 16.76 | 50.94 | -34.18 | AVG | |
| 3 | | 0.5887 | 15.81 | 9.71 | 25.52 | 56.00 | -30.48 | QP | |
| 4 | | 0.5887 | 1.75 | 9.71 | 11.46 | 46.00 | -34.54 | AVG | |
| 5 | | 0.7462 | 15.21 | 9.72 | 24.93 | 56.00 | -31.07 | QP | |
| 6 | | 0.7462 | 1.03 | 9.72 | 10.75 | 46.00 | -35.25 | AVG | |
| 7 | | 1.1174 | 11.67 | 9.73 | 21.40 | 56.00 | -34.60 | QP | |
| 8 | | 1.1174 | -1.16 | 9.73 | 8.57 | 46.00 | -37.43 | AVG | |
| 9 | | 3.4058 | 8.23 | 9.82 | 18.05 | 56.00 | -37.95 | QP | |
| 10 | | 3.4058 | -1.86 | 9.82 | 7.96 | 46.00 | -38.04 | AVG | |
| 11 | | 7.8765 | 6.14 | 10.07 | 16.21 | 60.00 | -43.79 | QP | |
| 12 | | 7.8765 | -1.29 | 10.07 | 8.78 | 50.00 | -41.22 | AVG | |

REMARKS:
 (1) Measurement Value = Reading Level + Correct Factor.
 (2) Margin Level = Measurement Value - Limit Value.

APPENDIX B RADIATED EMISSIONS - 30 MHZ TO 1 GHZ

| | | | |
|----------------|------------|--------------|------------|
| Test Mode | BT(1 Mbps) | Test Date | 2021/9/25 |
| Test Frequency | 2441MHz | Polarization | Horizontal |
| Temp | 22°C | Hum. | 54% |

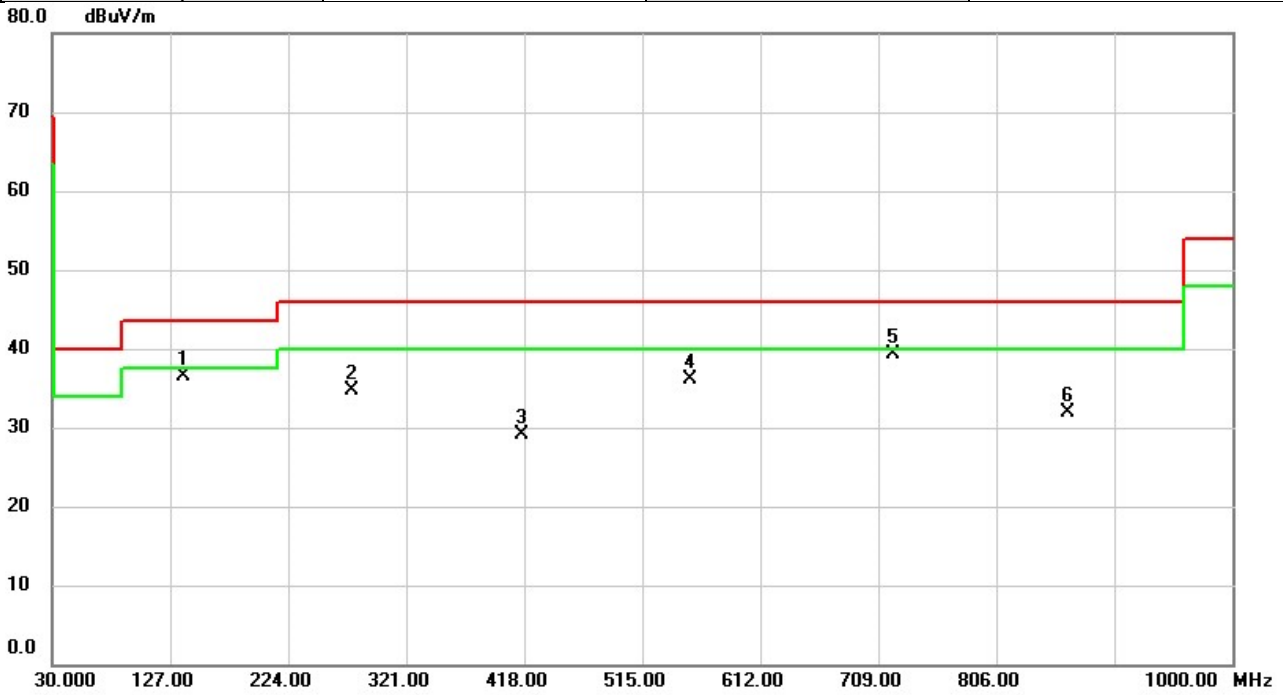

| No. | Mk. | Freq. | Reading Level | Correct Factor | Measurement | Limit | Over | Detector | Comment |
|-----|-----|----------|---------------|----------------|-------------|--------|--------|----------|---------|
| | | MHz | dBuV | dB | dBuV/m | dBuV/m | dB | | |
| 1 | | 137.6700 | 46.21 | -9.74 | 36.47 | 43.50 | -7.03 | peak | |
| 2 | | 277.0266 | 43.49 | -8.88 | 34.61 | 46.00 | -11.39 | peak | |
| 3 | | 415.5750 | 34.47 | -5.42 | 29.05 | 46.00 | -16.95 | peak | |
| 4 | | 554.0586 | 38.53 | -2.52 | 36.01 | 46.00 | -9.99 | peak | |
| 5 | * | 720.9633 | 38.69 | 0.66 | 39.35 | 46.00 | -6.65 | peak | |
| 6 | | 864.9113 | 28.96 | 2.95 | 31.91 | 46.00 | -14.09 | peak | |

REMARKS:

- (1) Measurement Value = Reading Level + Correct Factor.
- (2) Margin Level = Measurement Value - Limit Value.

| | | | |
|----------------|------------|--------------|-----------|
| Test Mode | BT(1 Mbps) | Test Date | 2021/9/25 |
| Test Frequency | 2441MHz | Polarization | Vertical |
| Temp | 22°C | Hum. | 54% |

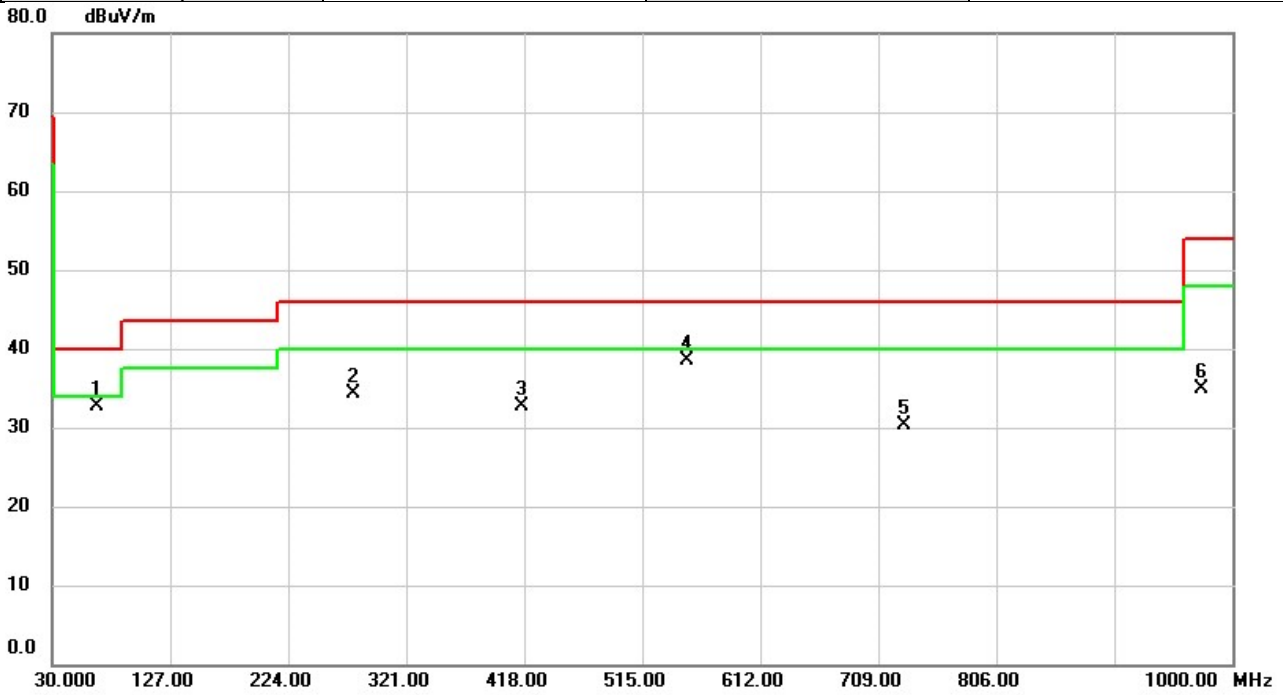

| No. | Mk. | Freq. | Reading Level | Correct Factor | Measurement | Limit | Over | Detector | Comment |
|-----|-----|----------|---------------|----------------|-------------|--------|--------|----------|---------|
| | | MHz | dBuV | dB | dBuV/m | dBuV/m | dB | | |
| 1 | * | 66.6013 | 43.05 | -10.37 | 32.68 | 40.00 | -7.32 | peak | |
| 2 | | 277.0267 | 43.27 | -8.88 | 34.39 | 46.00 | -11.61 | peak | |
| 3 | | 415.5426 | 38.18 | -5.42 | 32.76 | 46.00 | -13.24 | peak | |
| 4 | | 551.9247 | 41.00 | -2.59 | 38.41 | 46.00 | -7.59 | peak | |
| 5 | | 729.7580 | 29.35 | 0.89 | 30.24 | 46.00 | -15.76 | peak | |
| 6 | | 974.6183 | 30.20 | 4.61 | 34.81 | 54.00 | -19.19 | peak | |

REMARKS:

- (1) Measurement Value = Reading Level + Correct Factor.
- (2) Margin Level = Measurement Value - Limit Value.

APPENDIX C RADIATED EMISSIONS - ABOVE 1 GHZ

| | | | |
|----------------|------------|--------------|------------|
| Test Mode | BT(1 Mbps) | Test Date | 2021/9/25 |
| Test Frequency | 2402MHz | Polarization | Horizontal |
| Temp | 22°C | Hum. | 54% |

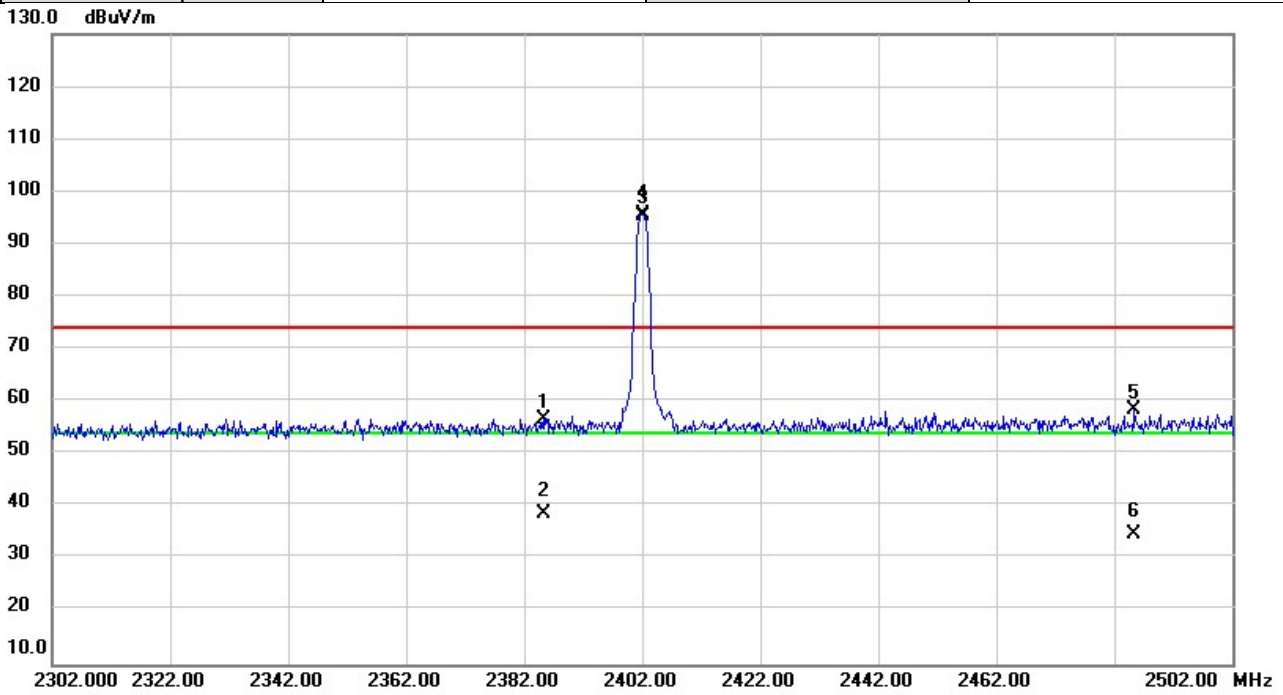

| No. | Mk. | Freq. | Reading Level | Correct Factor | Measurement | Limit | Over | Detector | Comment |
|-----|-----|----------|---------------|----------------|-------------|--------|--------|----------|---------|
| | | MHz | dBuV | dB | dBuV/m | dBuV/m | dB | | |
| 1 | | 2385.260 | 25.61 | 31.19 | 56.80 | 74.00 | -17.20 | peak | |
| 2 | | 2385.260 | 7.36 | 31.19 | 38.55 | 54.00 | -15.45 | AVG | |
| 3 | X | 2402.000 | 64.54 | 31.26 | 95.80 | 74.00 | 21.80 | peak | NoLimit |
| 4 | * | 2402.000 | 64.01 | 31.26 | 95.27 | 54.00 | 41.27 | AVG | NoLimit |
| 5 | | 2485.460 | 26.82 | 31.52 | 58.34 | 74.00 | -15.66 | peak | |
| 6 | | 2485.460 | 3.09 | 31.52 | 34.61 | 54.00 | -19.39 | AVG | |

REMARKS:

- (1) Measurement Value = Reading Level + Correct Factor.
- (2) Margin Level = Measurement Value - Limit Value.

| | | | |
|----------------|------------|--------------|------------|
| Test Mode | BT(1 Mbps) | Test Date | 2021/9/25 |
| Test Frequency | 2480MHz | Polarization | Horizontal |
| Temp | 22°C | Hum. | 54% |

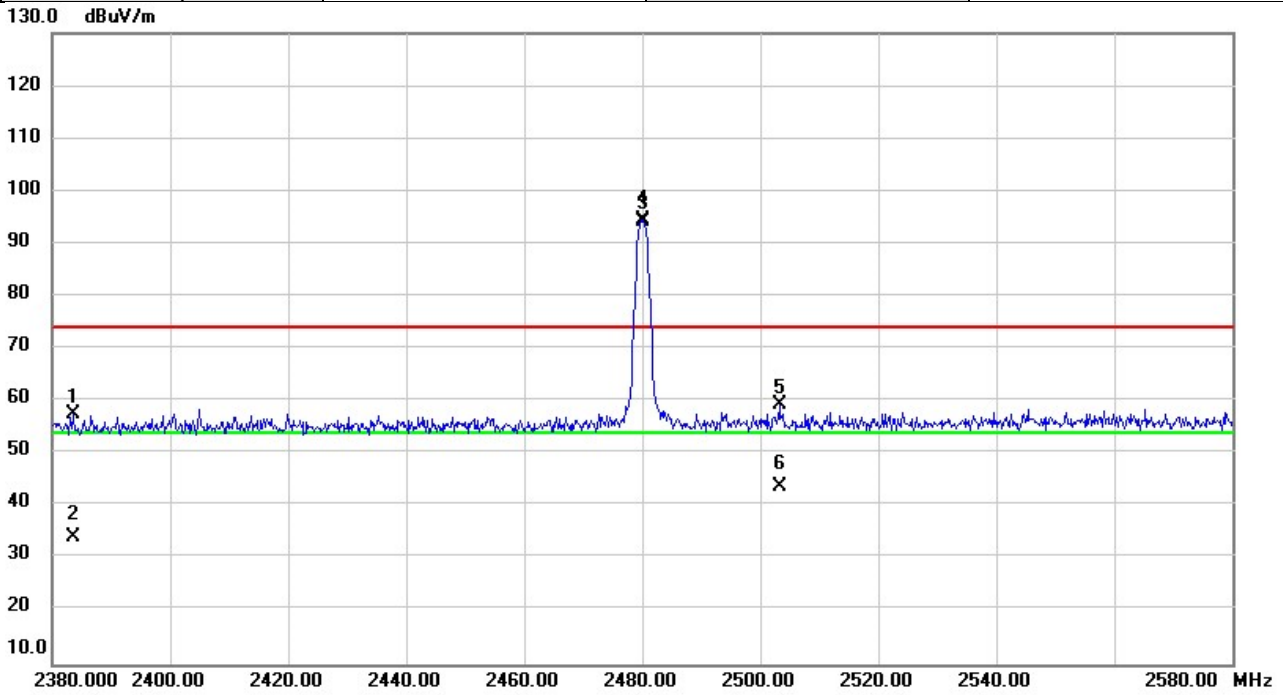

| No. | Mk. | Freq. | Reading Level | Correct Factor | Measurement | Limit | Over | Detector | Comment |
|-----|-----|----------|---------------|----------------|-------------|--------|--------|----------|---------|
| | | MHz | dBuV | dB | dBuV/m | dBuV/m | dB | | |
| 1 | | 2383.587 | 26.47 | 31.19 | 57.66 | 74.00 | -16.34 | peak | |
| 2 | | 2383.587 | 3.08 | 31.19 | 34.27 | 54.00 | -19.73 | AVG | |
| 3 | X | 2480.000 | 62.99 | 31.51 | 94.50 | 74.00 | 20.50 | peak | NoLimit |
| 4 | * | 2480.000 | 62.66 | 31.51 | 94.17 | 54.00 | 40.17 | AVG | NoLimit |
| 5 | | 2503.307 | 27.86 | 31.58 | 59.44 | 74.00 | -14.56 | peak | |
| 6 | | 2503.307 | 12.19 | 31.58 | 43.77 | 54.00 | -10.23 | AVG | |

REMARKS:

- (1) Measurement Value = Reading Level + Correct Factor.
- (2) Margin Level = Measurement Value - Limit Value.

| | | | |
|----------------|------------|--------------|------------|
| Test Mode | BT(3 Mbps) | Test Date | 2021/9/25 |
| Test Frequency | 2402MHz | Polarization | Horizontal |
| Temp | 22°C | Hum. | 54% |

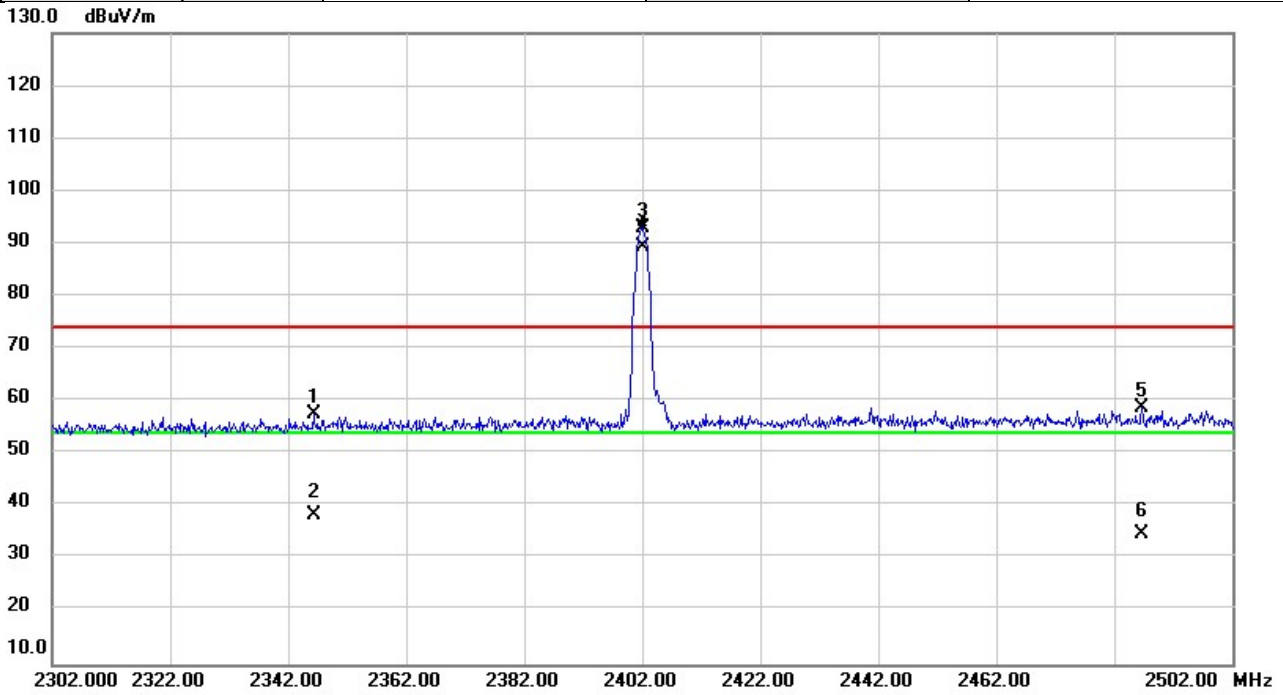

| No. | Mk. | Freq. | Reading Level | Correct Factor | Measurement | Limit | Over | Detector | Comment |
|-----|-----|----------|---------------|----------------|-------------|--------|--------|----------|---------|
| | | MHz | dBuV | dB | dBuV/m | dBuV/m | dB | | |
| 1 | | 2346.313 | 26.56 | 31.07 | 57.63 | 74.00 | -16.37 | peak | |
| 2 | | 2346.313 | 7.20 | 31.07 | 38.27 | 54.00 | -15.73 | AVG | |
| 3 | X | 2402.000 | 61.84 | 31.26 | 93.10 | 74.00 | 19.10 | peak | NoLimit |
| 4 | * | 2402.000 | 58.00 | 31.26 | 89.26 | 54.00 | 35.26 | AVG | NoLimit |
| 5 | | 2486.673 | 27.28 | 31.53 | 58.81 | 74.00 | -15.19 | peak | |
| 6 | | 2486.673 | 3.10 | 31.53 | 34.63 | 54.00 | -19.37 | AVG | |

REMARKS:

- (1) Measurement Value = Reading Level + Correct Factor.
- (2) Margin Level = Measurement Value - Limit Value.

| | | | |
|----------------|------------|--------------|------------|
| Test Mode | BT(3 Mbps) | Test Date | 2021/9/25 |
| Test Frequency | 2480MHz | Polarization | Horizontal |
| Temp | 22°C | Hum. | 54% |

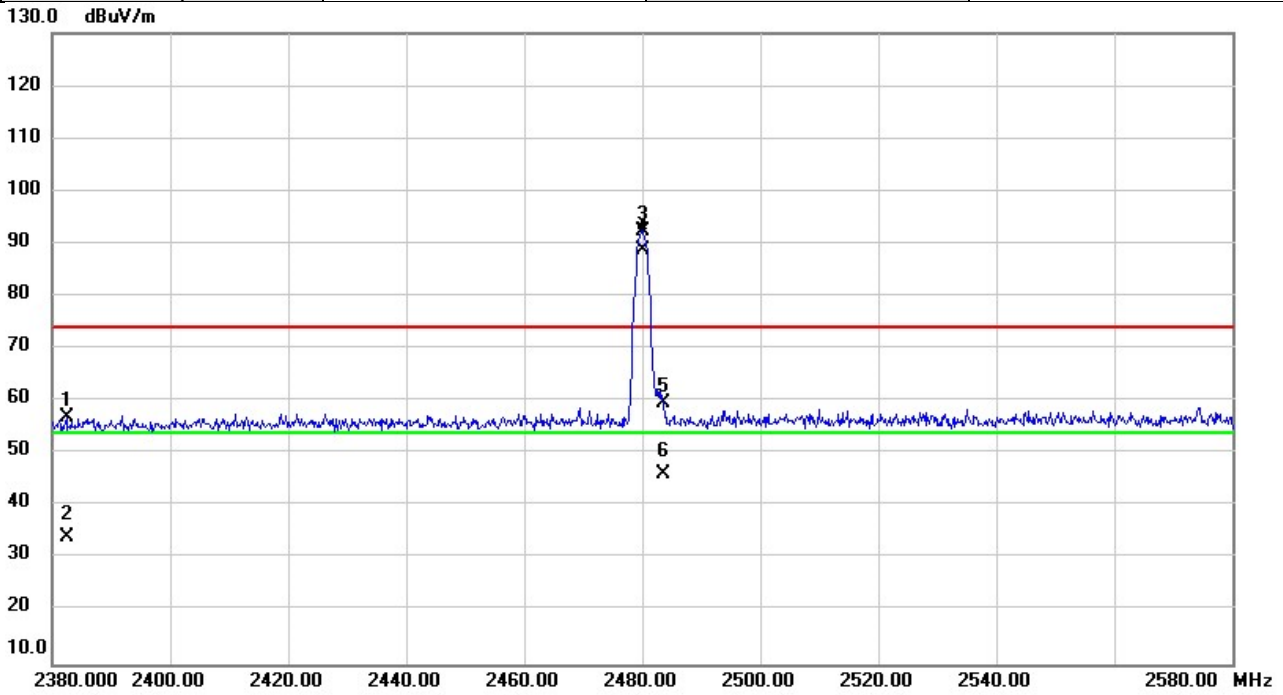

| No. | Mk. | Freq. | Reading Level | Correct Factor | Measurement | Limit | Over | Detector | Comment |
|-----|-----|----------|---------------|----------------|-------------|--------|--------|----------|---------|
| | | MHz | dBuV | dB | dBuV/m | dBuV/m | dB | | |
| 1 | | 2382.413 | 25.78 | 31.18 | 56.96 | 74.00 | -17.04 | peak | |
| 2 | | 2382.413 | 2.91 | 31.18 | 34.09 | 54.00 | -19.91 | AVG | |
| 3 | X | 2480.000 | 60.96 | 31.51 | 92.47 | 74.00 | 18.47 | peak | NoLimit |
| 4 | * | 2480.000 | 57.27 | 31.51 | 88.78 | 54.00 | 34.78 | AVG | NoLimit |
| 5 | | 2483.633 | 28.00 | 31.52 | 59.52 | 74.00 | -14.48 | peak | |
| 6 | | 2483.633 | 14.64 | 31.52 | 46.16 | 54.00 | -7.84 | AVG | |

REMARKS:

- (1) Measurement Value = Reading Level + Correct Factor.
- (2) Margin Level = Measurement Value - Limit Value.

| | | | |
|----------------|------------|--------------|-----------|
| Test Mode | BT(1 Mbps) | Test Date | 2021/9/25 |
| Test Frequency | 2402MHz | Polarization | Vertical |
| Temp | 22°C | Hum. | 54% |

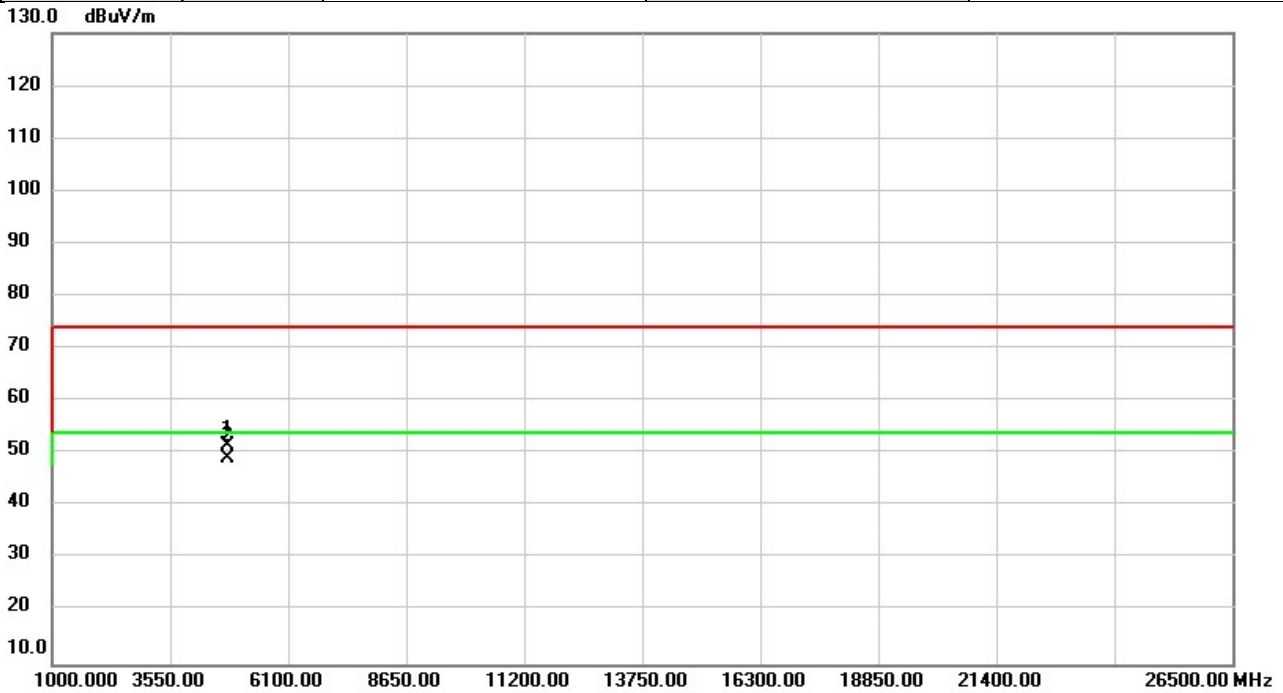

| No. | Mk. | Freq. MHz | Reading Level dBuV | Correct Factor dB | Measure- ment dBuV/m | Limit dBuV/m | Over dB | Detector | Comment |
|-----|-----|--------------|--------------------------|-------------------------|----------------------------|-----------------|------------|----------|---------|
| 1 | | 4804.000 | 61.31 | -9.84 | 51.47 | 74.00 | -22.53 | peak | |
| 2 | * | 4804.000 | 59.02 | -9.84 | 49.18 | 54.00 | -4.82 | AVG | |

REMARKS:

- (1) Measurement Value = Reading Level + Correct Factor.
- (2) Margin Level = Measurement Value - Limit Value.

| | | | |
|----------------|------------|--------------|------------|
| Test Mode | BT(1 Mbps) | Test Date | 2021/9/25 |
| Test Frequency | 2402MHz | Polarization | Horizontal |
| Temp | 22°C | Hum. | 54% |

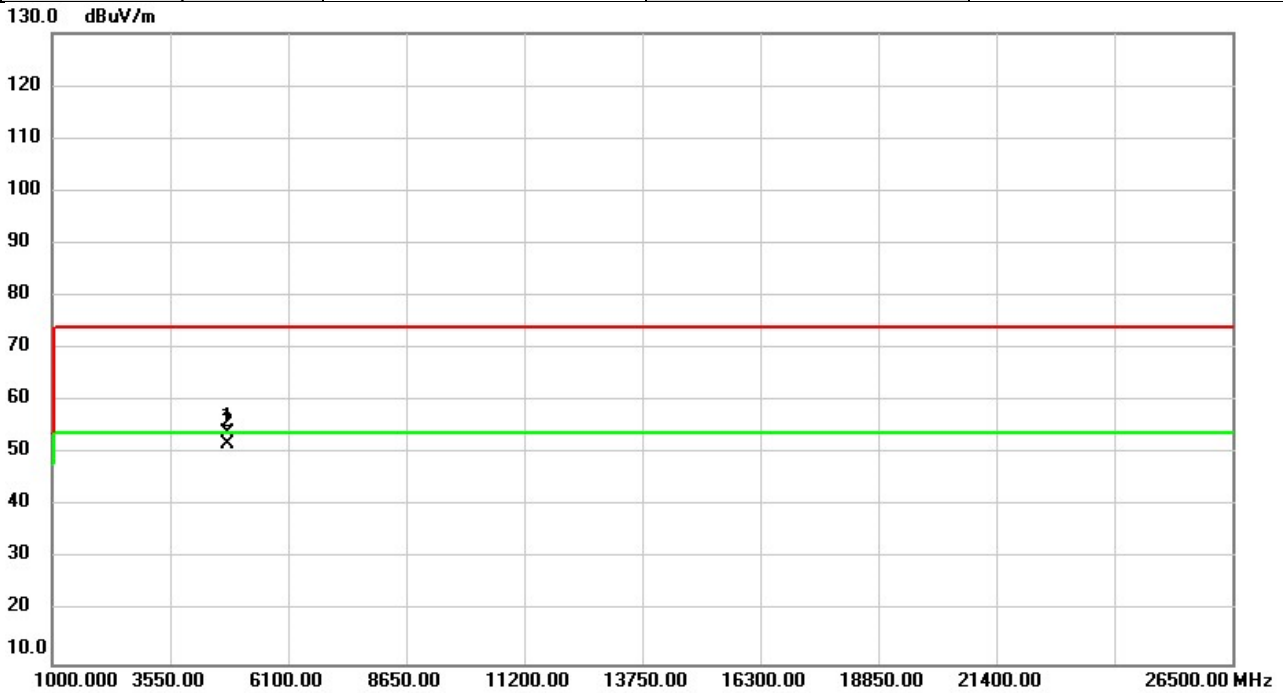

| No. | Mk. | Freq. MHz | Reading Level dBuV | Correct Factor dB | Measure- ment dBuV/m | Limit dBuV/m | Over dB | Detector | Comment |
|-----|-----|--------------|--------------------------|-------------------------|----------------------------|-----------------|------------|----------|---------|
| 1 | | 4804.000 | 63.83 | -9.84 | 53.99 | 74.00 | -20.01 | peak | |
| 2 | * | 4804.000 | 61.56 | -9.84 | 51.72 | 54.00 | -2.28 | AVG | |

REMARKS:

- (1) Measurement Value = Reading Level + Correct Factor.
- (2) Margin Level = Measurement Value - Limit Value.

| | | | |
|----------------|------------|--------------|-----------|
| Test Mode | BT(1 Mbps) | Test Date | 2021/9/25 |
| Test Frequency | 2441MHz | Polarization | Vertical |
| Temp | 22°C | Hum. | 54% |

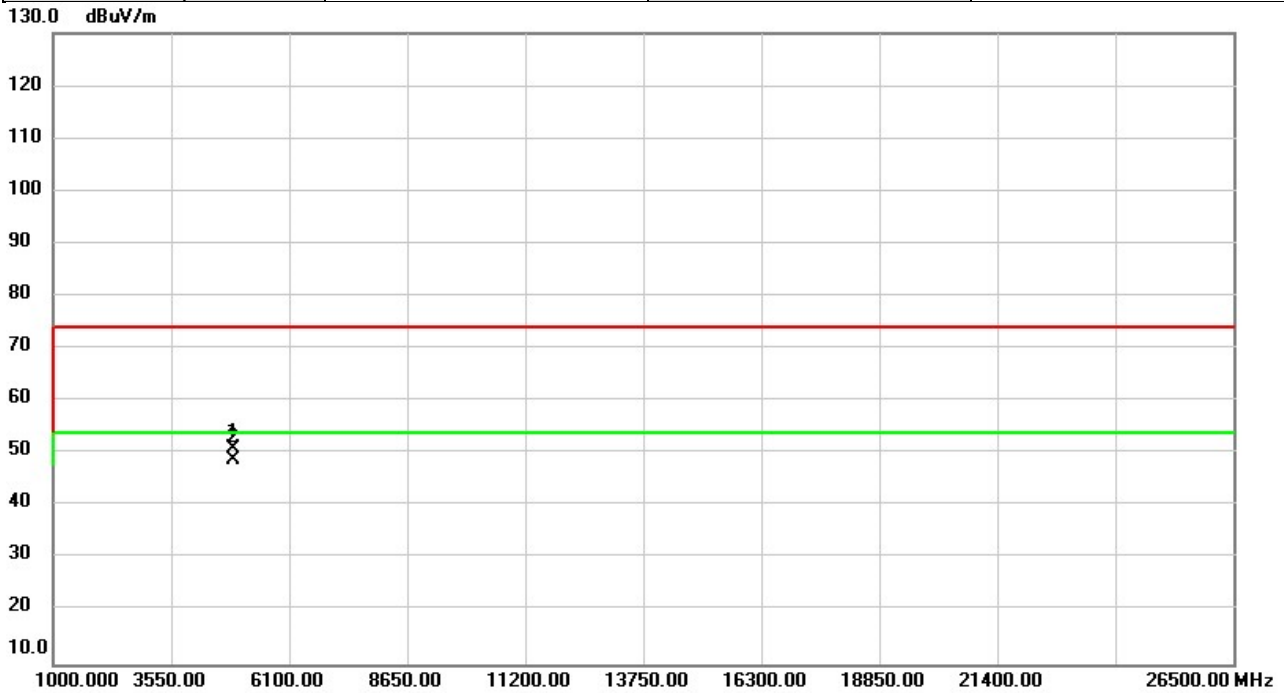

| No. | Mk. | Freq. MHz | Reading Level dBuV | Correct Factor dB | Measure- ment dBuV/m | Limit dBuV/m | Over dB | Detector | Comment |
|-----|-----|--------------|--------------------------|-------------------------|----------------------------|-----------------|------------|----------|---------|
| 1 | | 4882.000 | 60.79 | -9.77 | 51.02 | 74.00 | -22.98 | peak | |
| 2 | * | 4882.000 | 58.50 | -9.77 | 48.73 | 54.00 | -5.27 | AVG | |

REMARKS:

- (1) Measurement Value = Reading Level + Correct Factor.
- (2) Margin Level = Measurement Value - Limit Value.

| | | | |
|----------------|------------|--------------|------------|
| Test Mode | BT(1 Mbps) | Test Date | 2021/9/25 |
| Test Frequency | 2441MHz | Polarization | Horizontal |
| Temp | 22°C | Hum. | 54% |

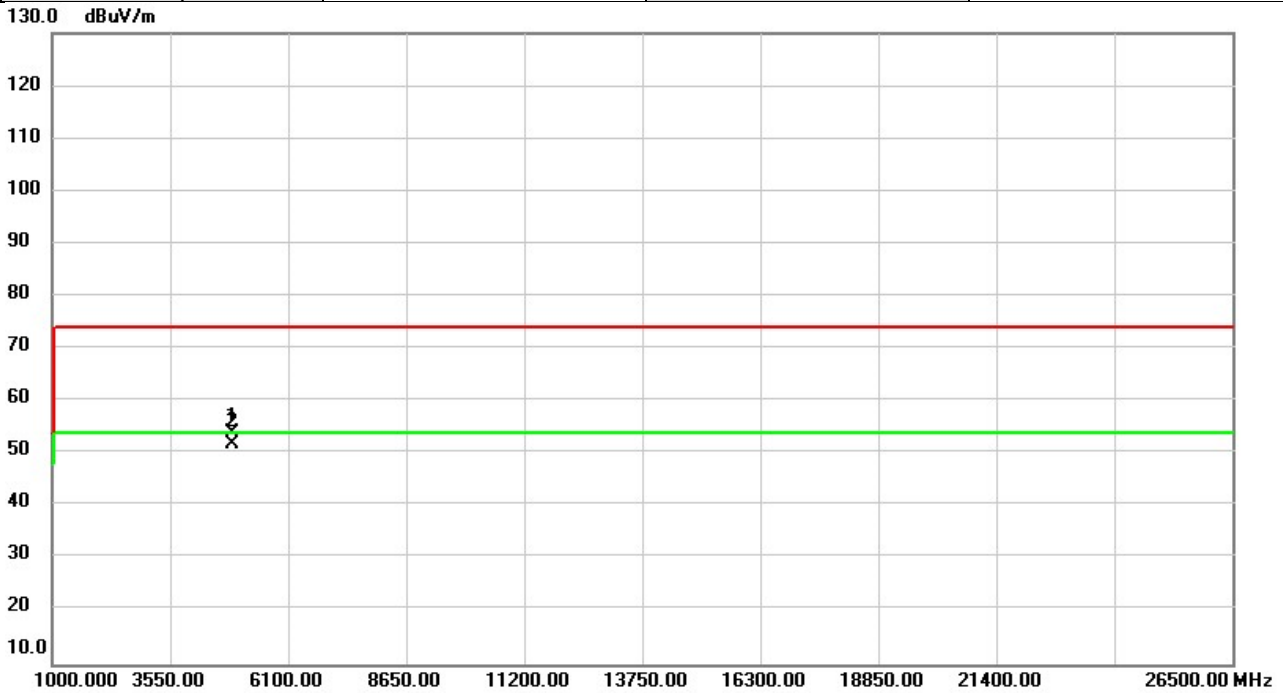

| No. | Mk. | Freq. MHz | Reading Level dBuV | Correct Factor dB | Measure- ment dBuV/m | Limit dBuV/m | Over dB | Detector | Comment |
|-----|-----|--------------|--------------------------|-------------------------|----------------------------|-----------------|------------|----------|---------|
| 1 | | 4882.000 | 63.73 | -9.77 | 53.96 | 74.00 | -20.04 | peak | |
| 2 | * | 4882.000 | 61.69 | -9.77 | 51.92 | 54.00 | -2.08 | AVG | |

REMARKS:

- (1) Measurement Value = Reading Level + Correct Factor.
- (2) Margin Level = Measurement Value - Limit Value.

| | | | |
|----------------|------------|--------------|-----------|
| Test Mode | BT(1 Mbps) | Test Date | 2021/9/25 |
| Test Frequency | 2480MHz | Polarization | Vertical |
| Temp | 22°C | Hum. | 54% |

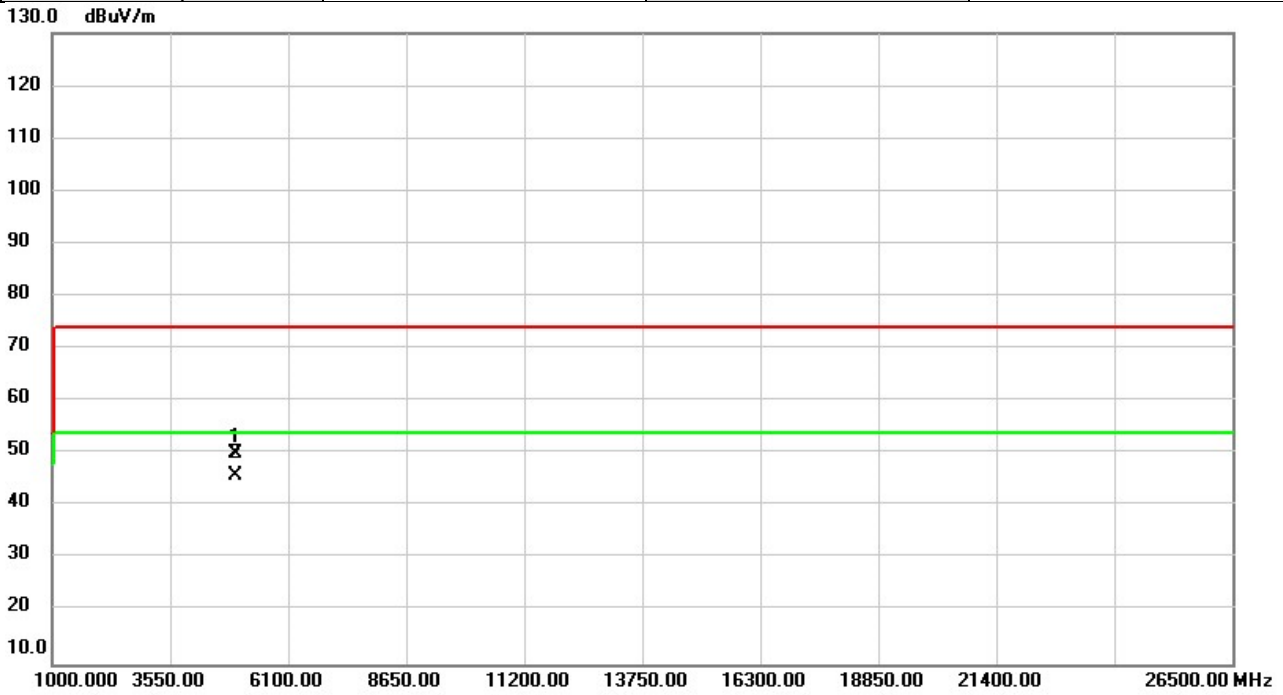

| No. | Mk. | Freq. MHz | Reading Level dBuV | Correct Factor dB | Measure- ment dBuV/m | Limit dBuV/m | Over dB | Detector | Comment |
|-----|-----|--------------|--------------------------|-------------------------|----------------------------|-----------------|------------|----------|---------|
| 1 | | 4960.000 | 59.59 | -9.68 | 49.91 | 74.00 | -24.09 | peak | |
| 2 | * | 4960.000 | 55.38 | -9.68 | 45.70 | 54.00 | -8.30 | AVG | |

REMARKS:

- (1) Measurement Value = Reading Level + Correct Factor.
- (2) Margin Level = Measurement Value - Limit Value.

| | | | |
|----------------|------------|--------------|------------|
| Test Mode | BT(1 Mbps) | Test Date | 2021/9/25 |
| Test Frequency | 2480MHz | Polarization | Horizontal |
| Temp | 22°C | Hum. | 54% |

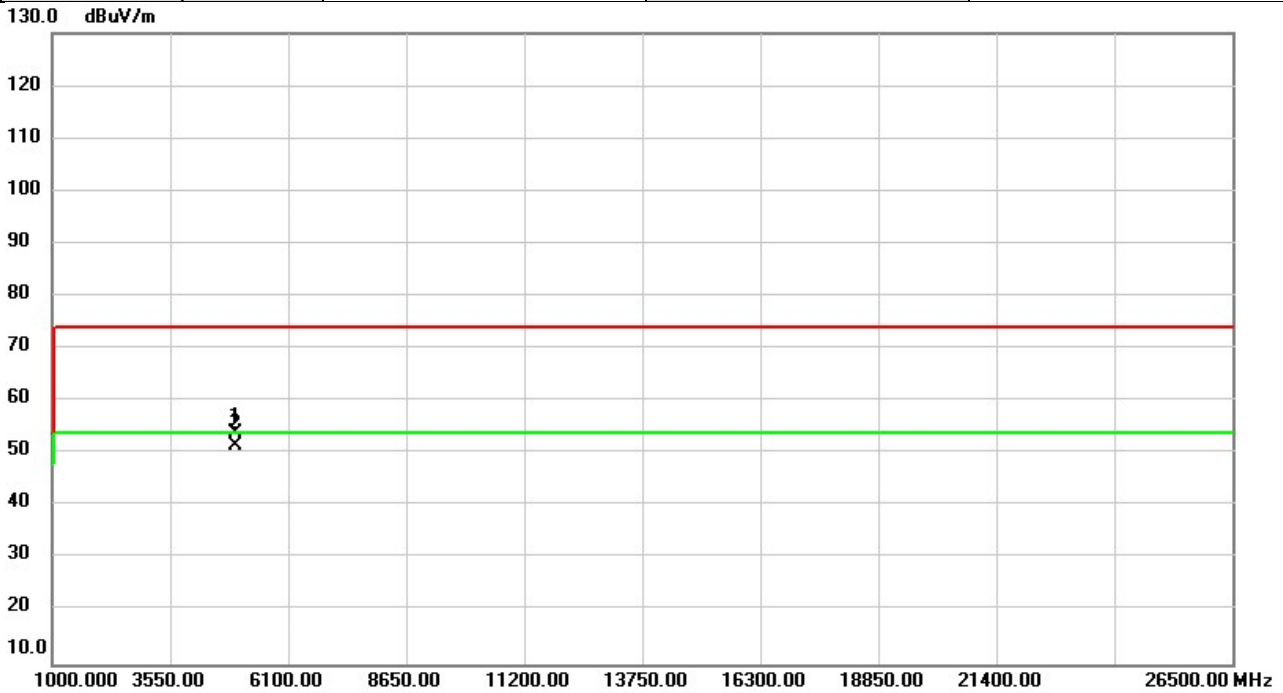

| No. | Mk. | Freq. MHz | Reading Level dBuV | Correct Factor dB | Measure- ment dBuV/m | Limit dBuV/m | Over dB | Detector | Comment |
|-----|-----|--------------|--------------------------|-------------------------|----------------------------|-----------------|------------|----------|---------|
| 1 | | 4960.000 | 63.68 | -9.68 | 54.00 | 74.00 | -20.00 | peak | |
| 2 | * | 4960.000 | 61.16 | -9.68 | 51.48 | 54.00 | -2.52 | AVG | |

REMARKS:

- (1) Measurement Value = Reading Level + Correct Factor.
- (2) Margin Level = Measurement Value - Limit Value.

| | | | |
|----------------|------------|--------------|-----------|
| Test Mode | BT(3 Mbps) | Test Date | 2021/9/25 |
| Test Frequency | 2402MHz | Polarization | Vertical |
| Temp | 22°C | Hum. | 54% |

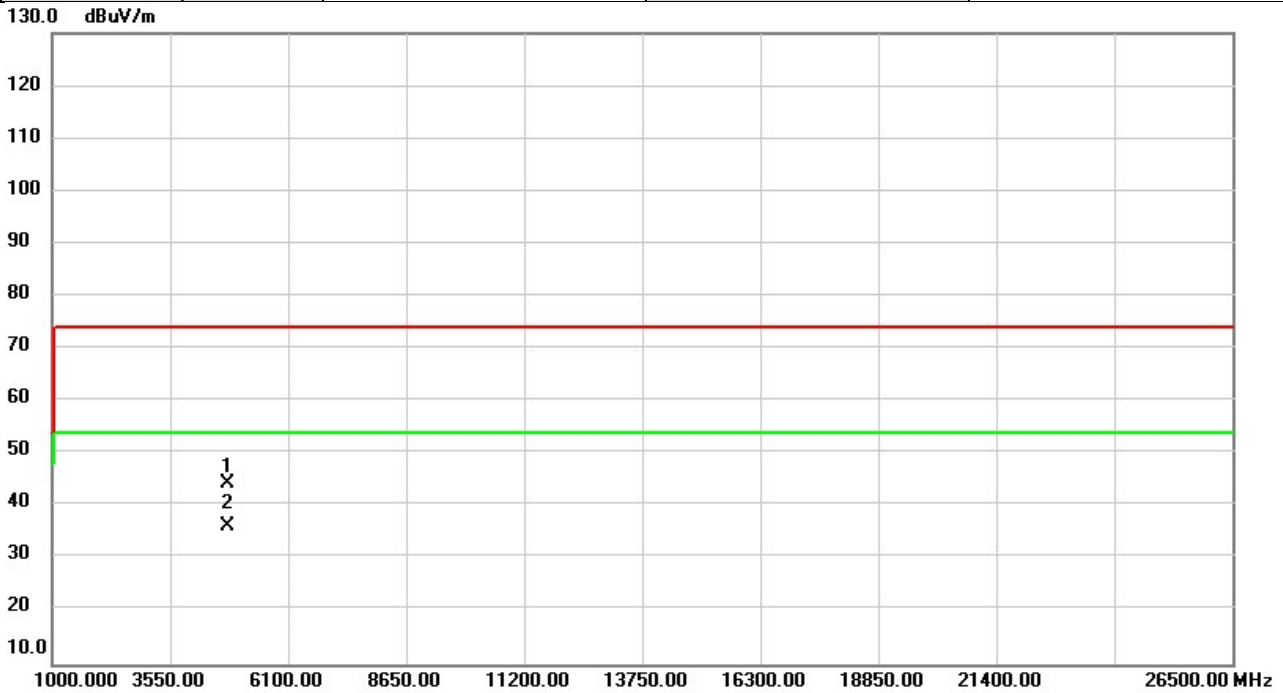

| No. | Mk. | Freq. MHz | Reading Level dBuV | Correct Factor dB | Measure- ment dBuV/m | Limit dBuV/m | Over dB | Detector | Comment |
|-----|-----|--------------|--------------------------|-------------------------|----------------------------|-----------------|------------|----------|---------|
| 1 | | 4804.000 | 54.08 | -9.84 | 44.24 | 74.00 | -29.76 | peak | |
| 2 | * | 4804.000 | 46.08 | -9.84 | 36.24 | 54.00 | -17.76 | AVG | |

REMARKS:

- (1) Measurement Value = Reading Level + Correct Factor.
- (2) Margin Level = Measurement Value - Limit Value.

| | | | |
|----------------|------------|--------------|------------|
| Test Mode | BT(3 Mbps) | Test Date | 2021/9/25 |
| Test Frequency | 2402MHz | Polarization | Horizontal |
| Temp | 22°C | Hum. | 54% |

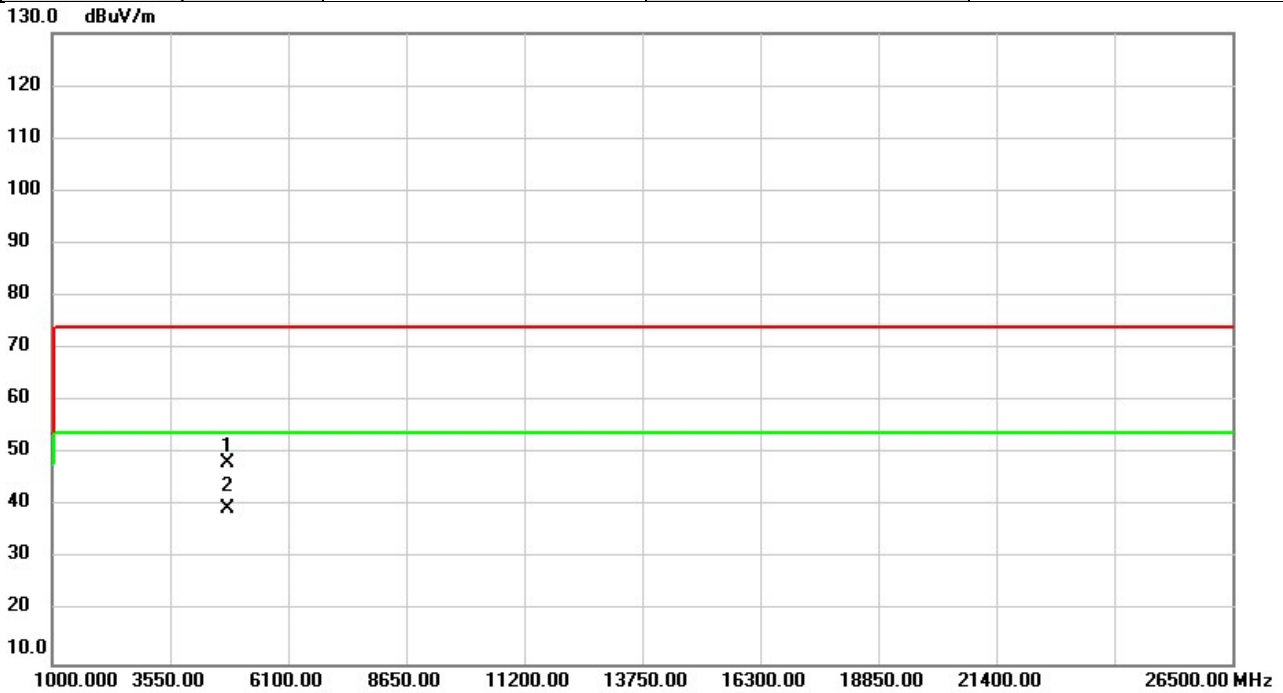

| No. | Mk. | Freq. MHz | Reading Level dBuV | Correct Factor dB | Measure- ment dBuV/m | Limit dBuV/m | Over dB | Detector | Comment |
|-----|-----|--------------|--------------------------|-------------------------|----------------------------|-----------------|------------|----------|---------|
| 1 | | 4804.000 | 58.19 | -9.84 | 48.35 | 74.00 | -25.65 | peak | |
| 2 | * | 4804.000 | 49.25 | -9.84 | 39.41 | 54.00 | -14.59 | AVG | |

REMARKS:

- (1) Measurement Value = Reading Level + Correct Factor.
- (2) Margin Level = Measurement Value - Limit Value.

| | | | |
|----------------|------------|--------------|-----------|
| Test Mode | BT(3 Mbps) | Test Date | 2021/9/25 |
| Test Frequency | 2441MHz | Polarization | Vertical |
| Temp | 22°C | Hum. | 54% |

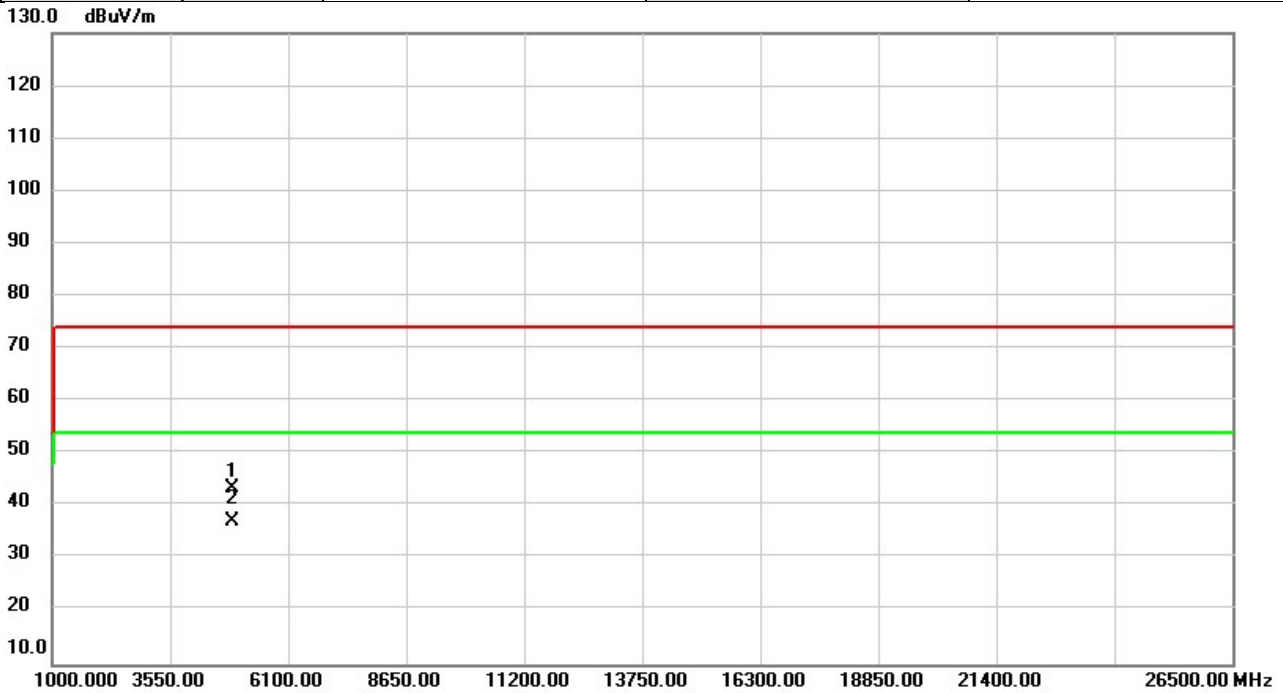

| No. | Mk. | Freq. MHz | Reading Level dBuV | Correct Factor dB | Measure- ment dBuV/m | Limit dBuV/m | Over dB | Detector | Comment |
|-----|-----|--------------|--------------------------|-------------------------|----------------------------|-----------------|------------|----------|---------|
| 1 | | 4882.000 | 53.27 | -9.77 | 43.50 | 74.00 | -30.50 | peak | |
| 2 | * | 4882.000 | 46.91 | -9.77 | 37.14 | 54.00 | -16.86 | AVG | |

REMARKS:

- (1) Measurement Value = Reading Level + Correct Factor.
- (2) Margin Level = Measurement Value - Limit Value.

| | | | |
|----------------|------------|--------------|------------|
| Test Mode | BT(3 Mbps) | Test Date | 2021/9/25 |
| Test Frequency | 2441MHz | Polarization | Horizontal |
| Temp | 22°C | Hum. | 54% |

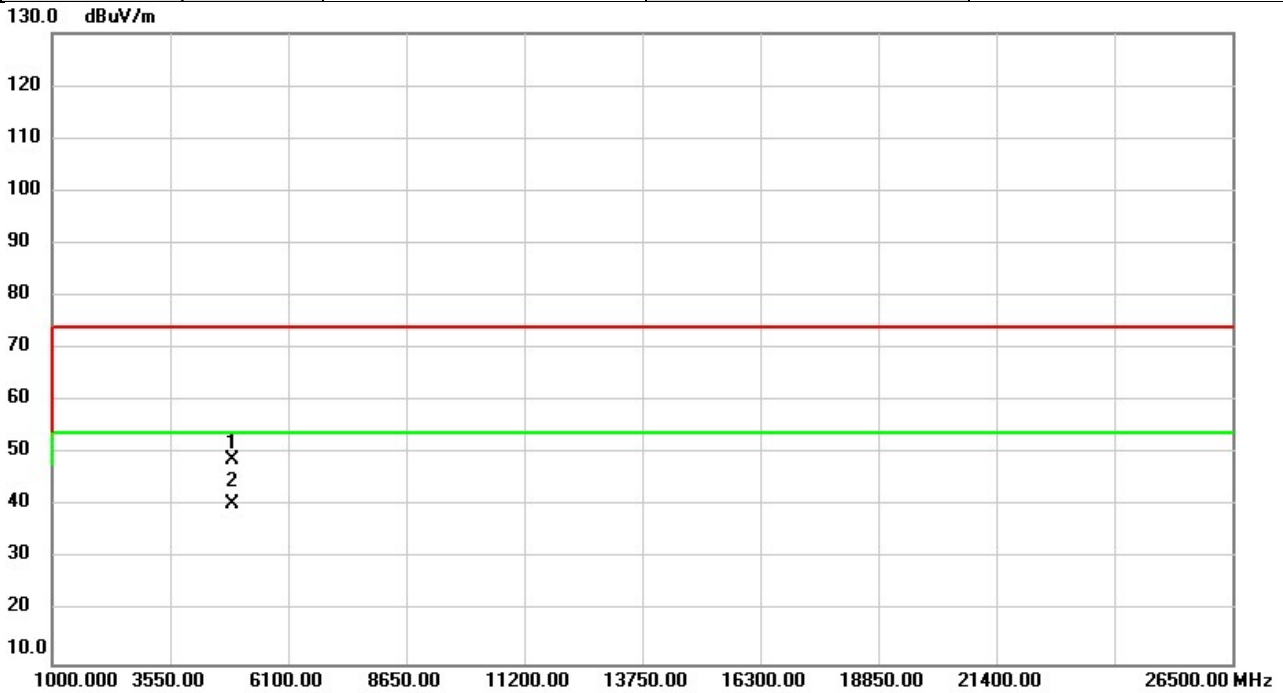

| No. | Mk. | Freq. MHz | Reading Level dBuV | Correct Factor dB | Measure- ment dBuV/m | Limit dBuV/m | Over dB | Detector | Comment |
|-----|-----|--------------|--------------------------|-------------------------|----------------------------|-----------------|------------|----------|---------|
| 1 | | 4882.000 | 58.55 | -9.77 | 48.78 | 74.00 | -25.22 | peak | |
| 2 | * | 4882.000 | 50.36 | -9.77 | 40.59 | 54.00 | -13.41 | AVG | |

REMARKS:

- (1) Measurement Value = Reading Level + Correct Factor.
- (2) Margin Level = Measurement Value - Limit Value.

| | | | |
|----------------|------------|--------------|-----------|
| Test Mode | BT(3 Mbps) | Test Date | 2021/9/25 |
| Test Frequency | 2480MHz | Polarization | Vertical |
| Temp | 22°C | Hum. | 54% |

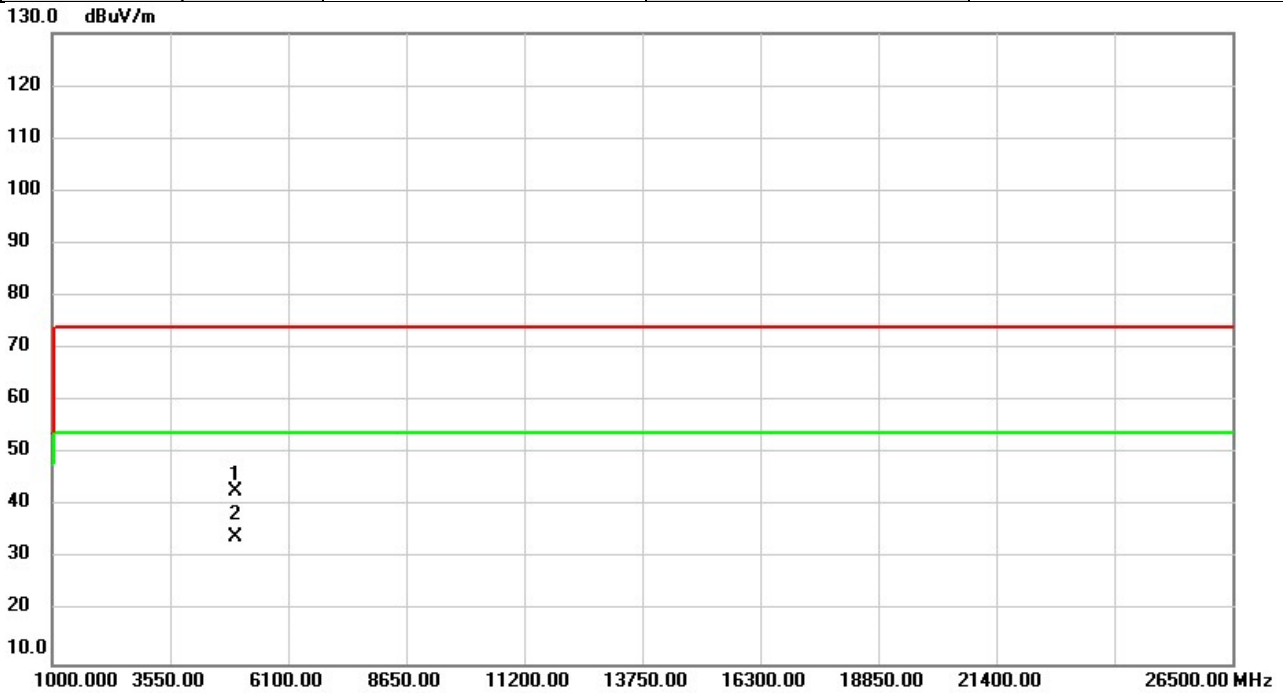

| No. | Mk. | Freq. MHz | Reading Level dBuV | Correct Factor dB | Measure- ment dBuV/m | Limit dBuV/m | Over dB | Detector | Comment |
|-----|-----|--------------|--------------------------|-------------------------|----------------------------|-----------------|------------|----------|---------|
| 1 | | 4960.000 | 52.68 | -9.68 | 43.00 | 74.00 | -31.00 | peak | |
| 2 | * | 4960.000 | 43.86 | -9.68 | 34.18 | 54.00 | -19.82 | AVG | |

REMARKS:

- (1) Measurement Value = Reading Level + Correct Factor.
- (2) Margin Level = Measurement Value - Limit Value.

| | | | |
|----------------|------------|--------------|------------|
| Test Mode | BT(3 Mbps) | Test Date | 2021/9/25 |
| Test Frequency | 2480MHz | Polarization | Horizontal |
| Temp | 22°C | Hum. | 54% |

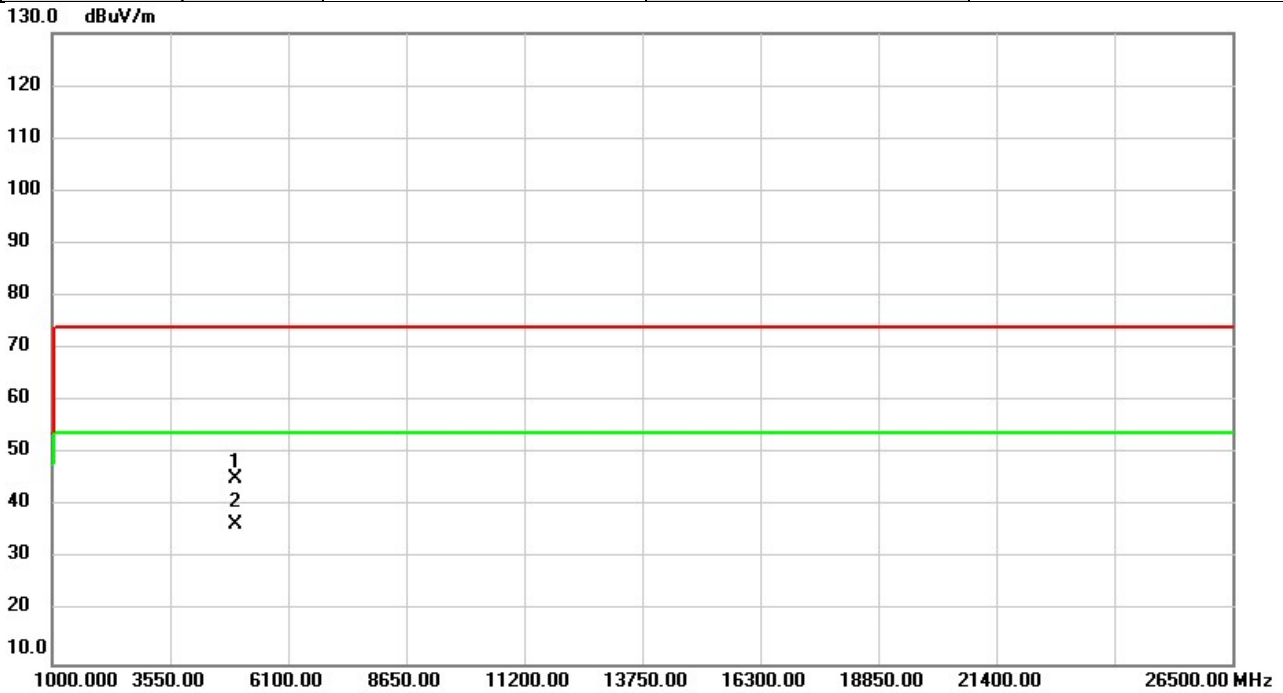

| No. | Mk. | Freq. MHz | Reading Level dBuV | Correct Factor dB | Measure- ment dBuV/m | Limit dBuV/m | Over dB | Detector | Comment |
|-----|-----|--------------|--------------------------|-------------------------|----------------------------|-----------------|------------|----------|---------|
| 1 | | 4960.000 | 55.00 | -9.68 | 45.32 | 74.00 | -28.68 | peak | |
| 2 | * | 4960.000 | 46.24 | -9.68 | 36.56 | 54.00 | -17.44 | AVG | |

REMARKS:

- (1) Measurement Value = Reading Level + Correct Factor.
- (2) Margin Level = Measurement Value - Limit Value.

APPENDIX D NUMBER OF HOPPING CHANNEL

| | |
|-----------|---------|
| Test Mode | 1/3Mbps |
|-----------|---------|

| Test Mode | Number of Hopping Channel | ≥ Limit | Test Result |
|-----------|---------------------------|---------|-------------|
| 1 Mbps | 79 | 15 | Pass |
| 3 Mbps | 79 | 15 | Pass |

1 Mbps

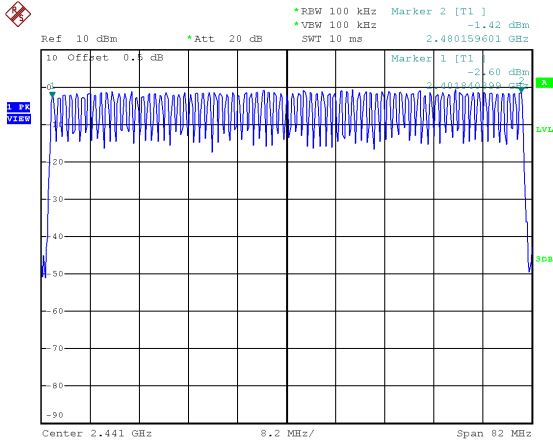

Date: 24.MAR.2014 16:21:06

3 Mbps

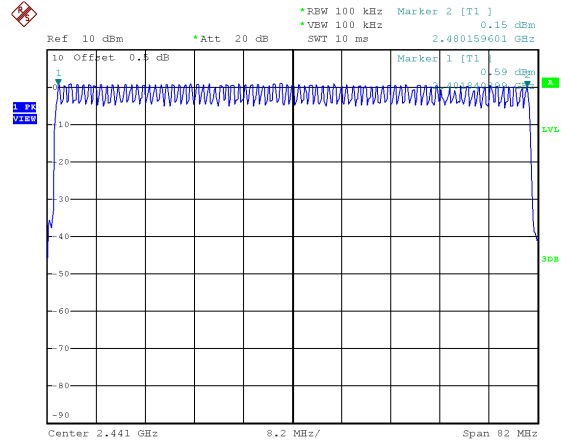

Date: 24.MAR.2014 17:15:18

APPENDIX E AVERAGE TIME OF OCCUPANCY

Test Mode 1Mbps

| Data Packet | Frequency (MHz) | Pulse Duration (ms) | Dwell Time (s) | Limits (s) | Test Result |
|-------------|-----------------|---------------------|----------------|------------|-------------|
| DH5 | 2402 | 3.0136 | 0.3215 | 0.4 | Pass |
| DH3 | 2402 | 1.8104 | 0.2897 | 0.4 | Pass |
| DH1 | 2402 | 0.4901 | 0.1568 | 0.4 | Pass |
| DH5 | 2441 | 3.0571 | 0.3261 | 0.4 | Pass |
| DH3 | 2441 | 1.7637 | 0.2822 | 0.4 | Pass |
| DH1 | 2441 | 0.5210 | 0.1667 | 0.4 | Pass |
| DH5 | 2480 | 3.0060 | 0.3206 | 0.4 | Pass |
| DH3 | 2480 | 1.7625 | 0.2820 | 0.4 | Pass |
| DH1 | 2480 | 0.5406 | 0.1730 | 0.4 | Pass |

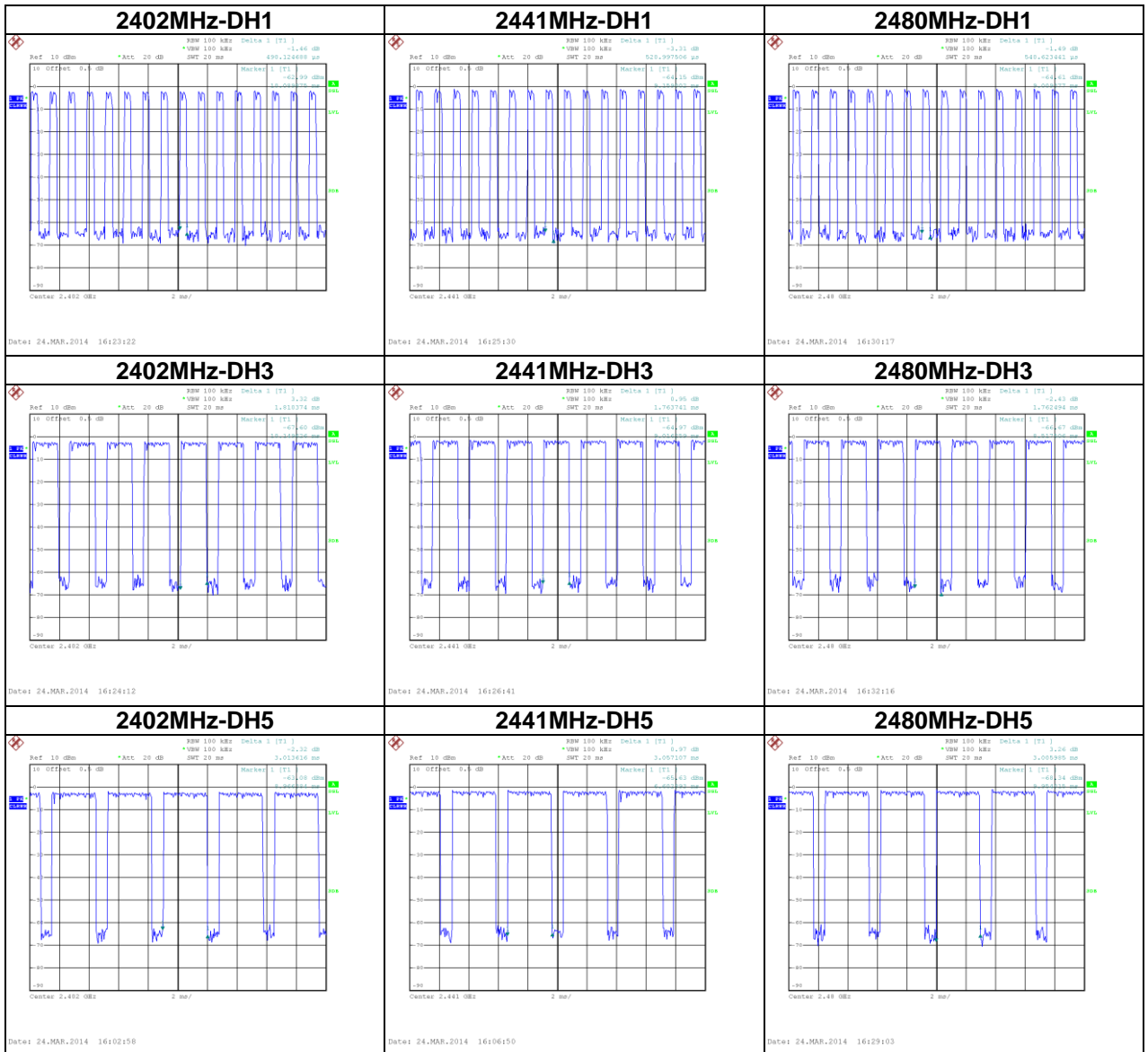

| | |
|-----------|-------|
| Test Mode | 3Mbps |
|-----------|-------|

| Data Packet | Frequency (MHz) | Pulse Duration(ms) | Dwell Time(s) | Limits(s) | Test Result |
|-------------|-----------------|--------------------|---------------|-----------|-------------|
| 3DH5 | 2402 | 3.0517 | 0.3255 | 0.4 | Pass |
| 3DH3 | 2402 | 1.7756 | 0.2841 | 0.4 | Pass |
| 3DH1 | 2402 | 0.5224 | 0.1672 | 0.4 | Pass |
| 3DH5 | 2441 | 3.0409 | 0.3244 | 0.4 | Pass |
| 3DH3 | 2441 | 1.8109 | 0.2897 | 0.4 | Pass |
| 3DH1 | 2441 | 0.5412 | 0.1732 | 0.4 | Pass |
| 3DH5 | 2480 | 3.0979 | 0.3304 | 0.4 | Pass |
| 3DH3 | 2480 | 1.7656 | 0.2825 | 0.4 | Pass |
| 3DH1 | 2480 | 0.5219 | 0.1670 | 0.4 | Pass |

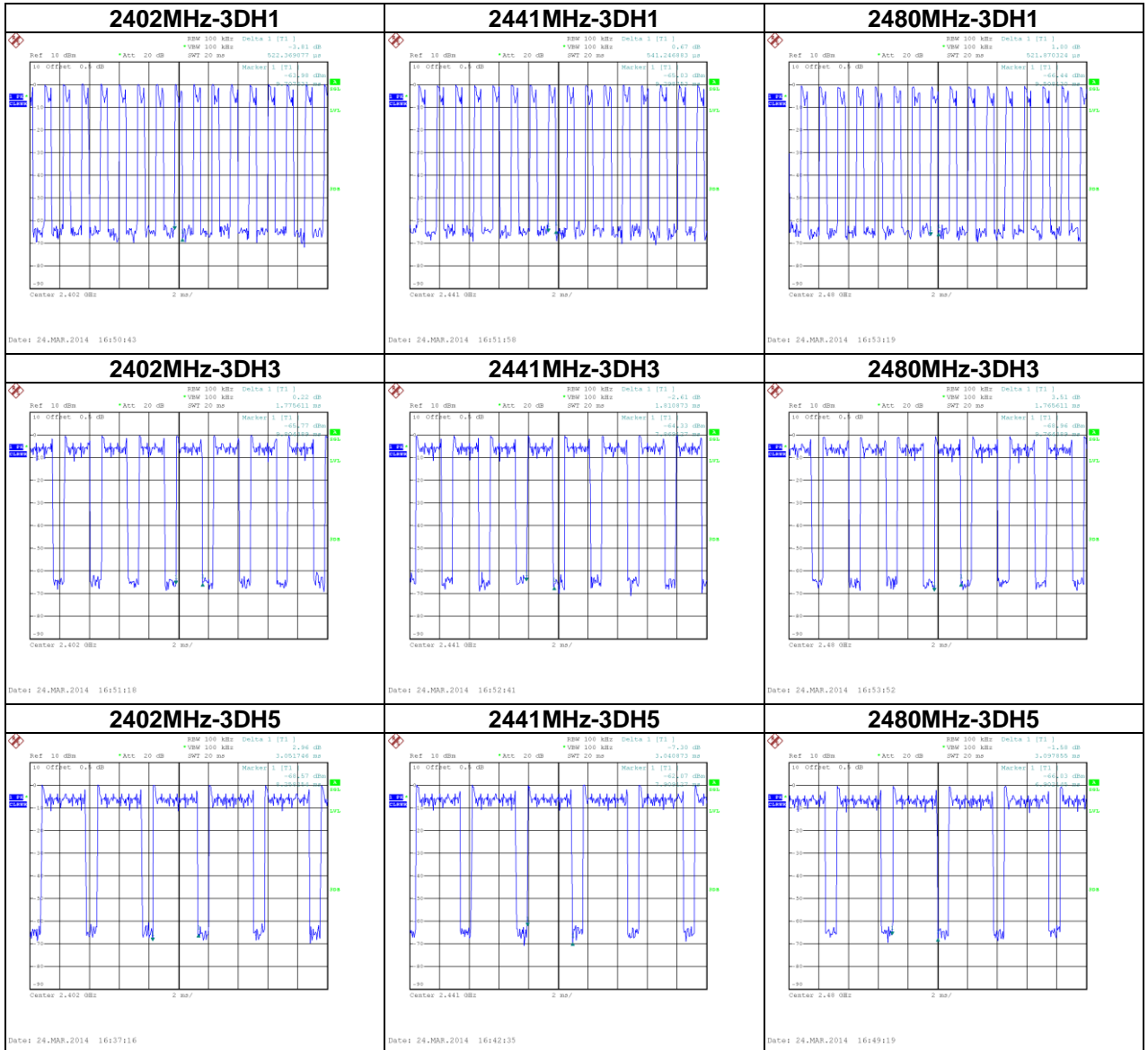

APPENDIX F HOPPING CHANNEL SEPARATION MEASUREMENT

Test Mode | Hopping on _1Mbps

| Frequency (MHz) | Channel Separation (MHz) | 2/3 of 20dB Bandwidth (MHz) | Test Result |
|-----------------|--------------------------|-----------------------------|-------------|
| 2402 | 1.005 | 0.625 | Pass |
| 2441 | 1.005 | 0.628 | Pass |
| 2480 | 1.005 | 0.632 | Pass |

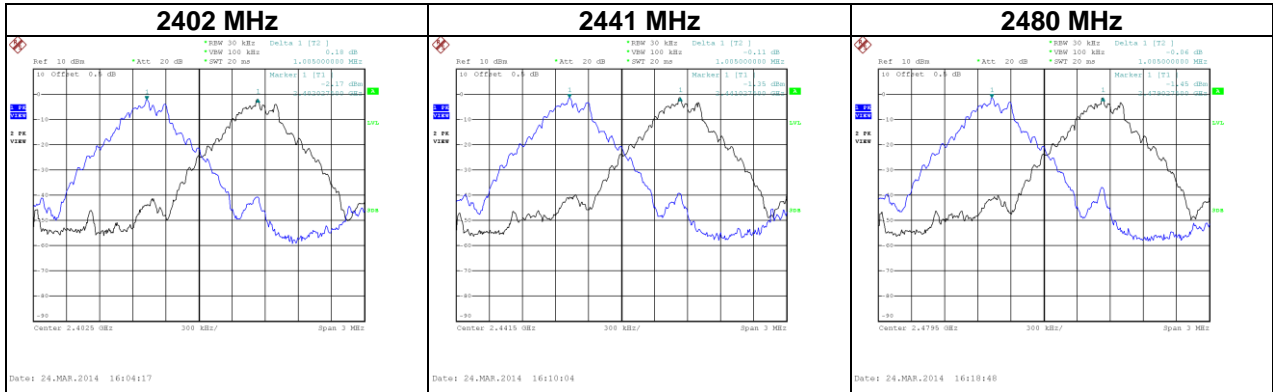

Test Mode: Hopping on _3Mbps

| Frequency (MHz) | Channel Separation (MHz) | 2/3 of 20dB Bandwidth (MHz) | Test Result |
|-----------------|--------------------------|-----------------------------|-------------|
| 2402 | 1.005 | 0.838 | Pass |
| 2441 | 1.005 | 0.848 | Pass |
| 2480 | 1.005 | 0.841 | Pass |

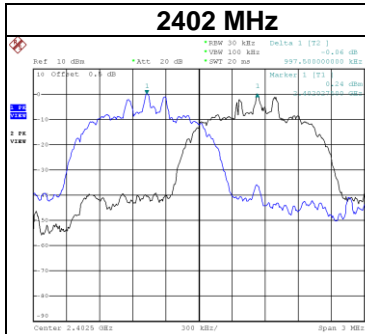

Date: 24_MAR_2014 16:39:46

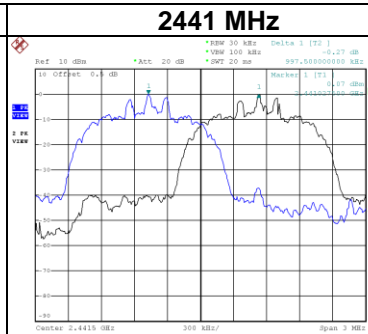

Date: 24_MAR_2014 16:43:27

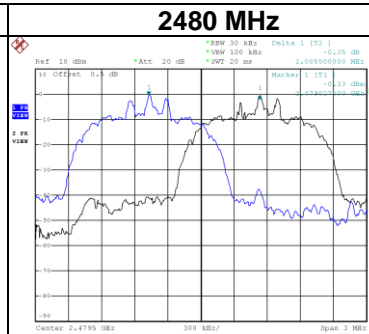

Date: 24_MAR_2014 16:49:22

APPENDIX G BANDWIDTH

| | |
|-----------|-------|
| Test Mode | 1Mbps |
|-----------|-------|

| Frequency (MHz) | 20dB Bandwidth (MHz) | 99% Occupied BW (MHz) | Test Result |
|-----------------|----------------------|-----------------------|-------------|
| 2402 | 0.938 | 0.875 | Pass |
| 2441 | 0.943 | 0.870 | Pass |
| 2480 | 0.948 | 0.870 | Pass |

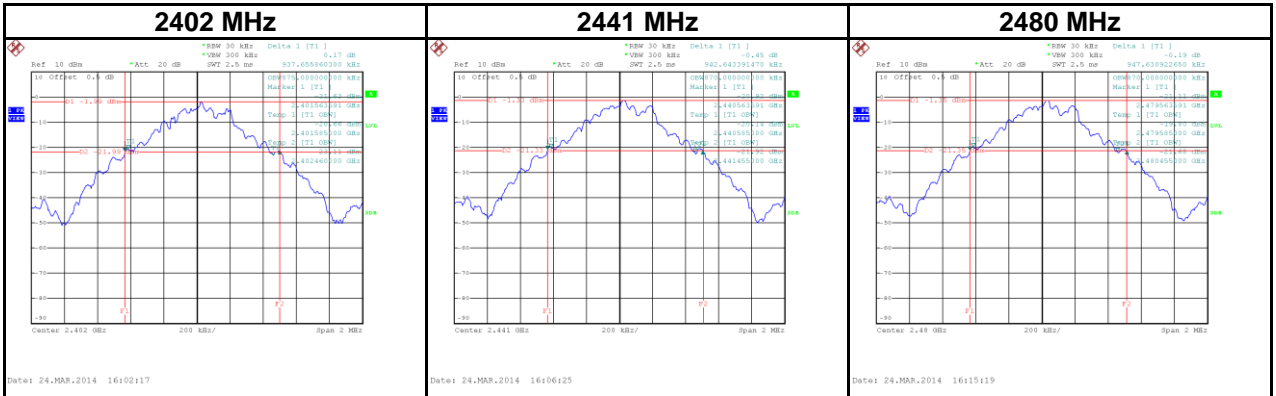

| | |
|-----------|-------|
| Test Mode | 3Mbps |
|-----------|-------|

| Frequency (MHz) | 20dB Bandwidth (MHz) | 99% Occupied BW (MHz) | Test Result |
|-----------------|----------------------|-----------------------|-------------|
| 2402 | 1.257 | 1.180 | Pass |
| 2441 | 1.272 | 1.175 | Pass |
| 2480 | 1.262 | 1.165 | Pass |

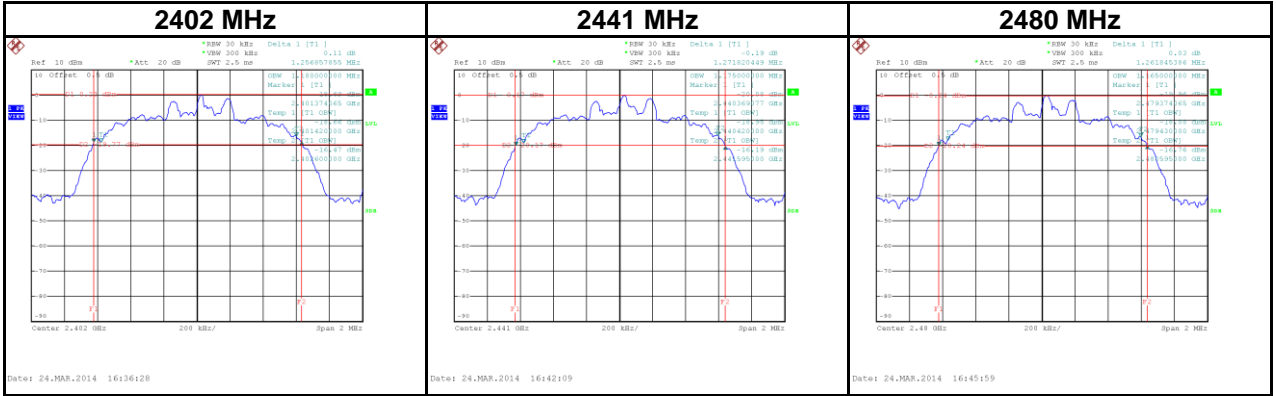

APPENDIX H OUTPUT POWER

| | | | |
|-----------|-------|-------------|-----------|
| Test Mode | 1Mbps | Tested Date | 2021/7/22 |
|-----------|-------|-------------|-----------|

| Frequency (MHz) | Conducted Power (dBm) | Conducted Power (W) | Max. Limit (dBm) | Max. Limit (W) | Test Result |
|-----------------|-----------------------|---------------------|------------------|----------------|-------------|
| 2402 | -3.54 | 0.0004 | 21.00 | 0.1259 | Pass |
| 2441 | -3.02 | 0.0005 | 21.00 | 0.1259 | Pass |
| 2480 | -0.89 | 0.0008 | 21.00 | 0.1259 | Pass |

| | | | |
|-----------|-------|-------------|-----------|
| Test Mode | 2Mbps | Tested Date | 2021/7/22 |
|-----------|-------|-------------|-----------|

| Frequency (MHz) | Conducted Power (dBm) | Conducted Power (W) | Max. Limit (dBm) | Max. Limit (W) | Test Result |
|-----------------|-----------------------|---------------------|------------------|----------------|-------------|
| 2402 | -0.62 | 0.0009 | 21.00 | 0.1259 | Pass |
| 2441 | -1.01 | 0.0008 | 21.00 | 0.1259 | Pass |
| 2480 | -1.13 | 0.0008 | 21.00 | 0.1259 | Pass |

| | | | |
|-----------|-------|-------------|-----------|
| Test Mode | 3Mbps | Tested Date | 2021/7/22 |
|-----------|-------|-------------|-----------|

| Frequency (MHz) | Conducted Power (dBm) | Conducted Power (W) | Max. Limit (dBm) | Max. Limit (W) | Test Result |
|-----------------|-----------------------|---------------------|------------------|----------------|-------------|
| 2402 | -0.62 | 0.0009 | 21.00 | 0.1259 | Pass |
| 2441 | -1.01 | 0.0008 | 21.00 | 0.1259 | Pass |
| 2480 | -1.13 | 0.0008 | 21.00 | 0.1259 | Pass |

APPENDIX I ANTENNA CONDUCTED SPURIOUS EMISSION

Test Mode | 1Mbps

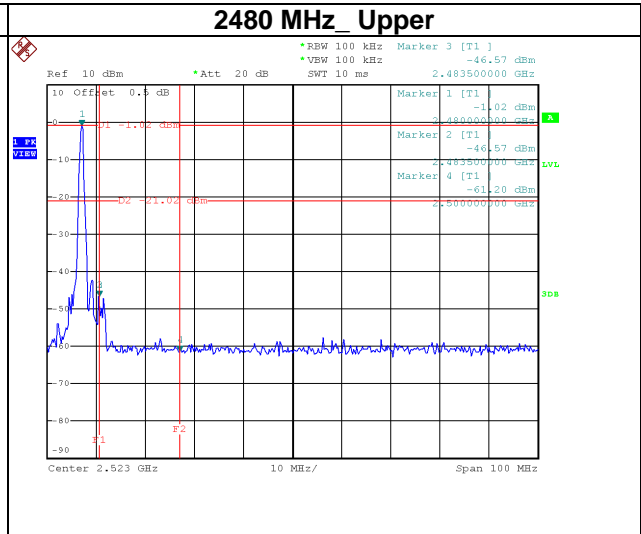
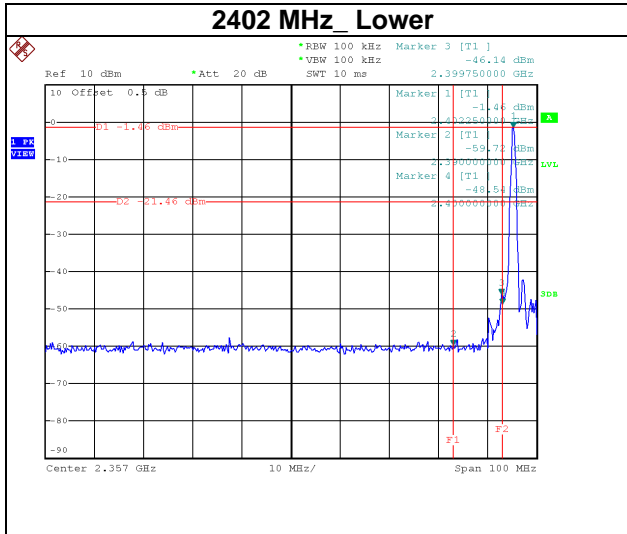

Date: 24.MAR.2014 16:02:31

Date: 24.MAR.2014 16:15:32

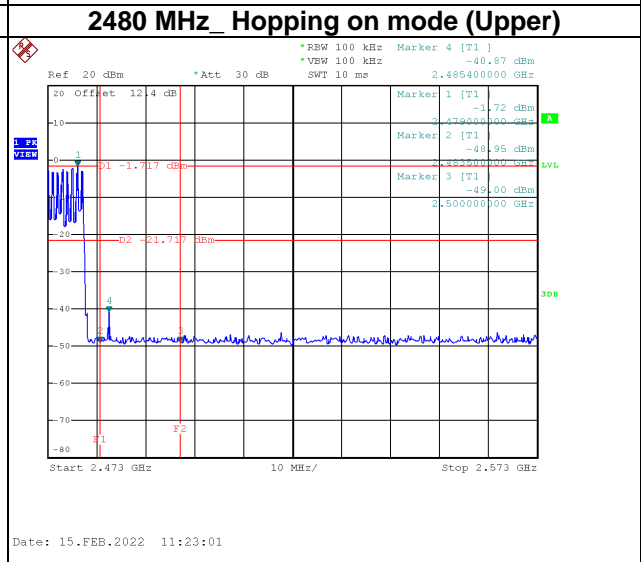
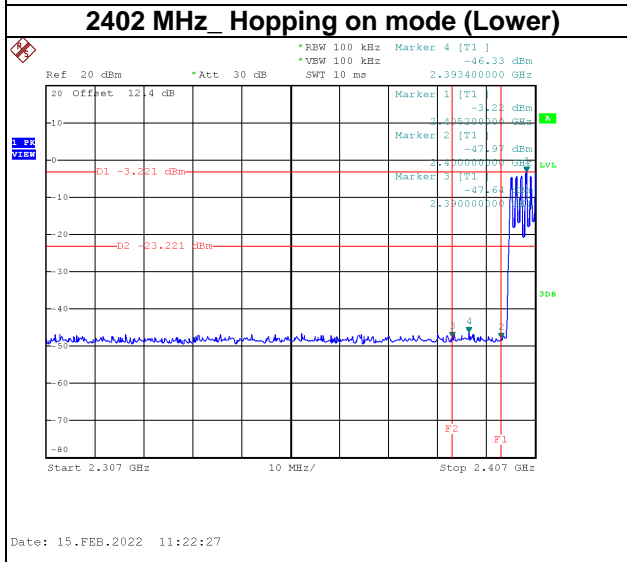

Date: 15.FEB.2022 11:22:27

Date: 15.FEB.2022 11:23:01

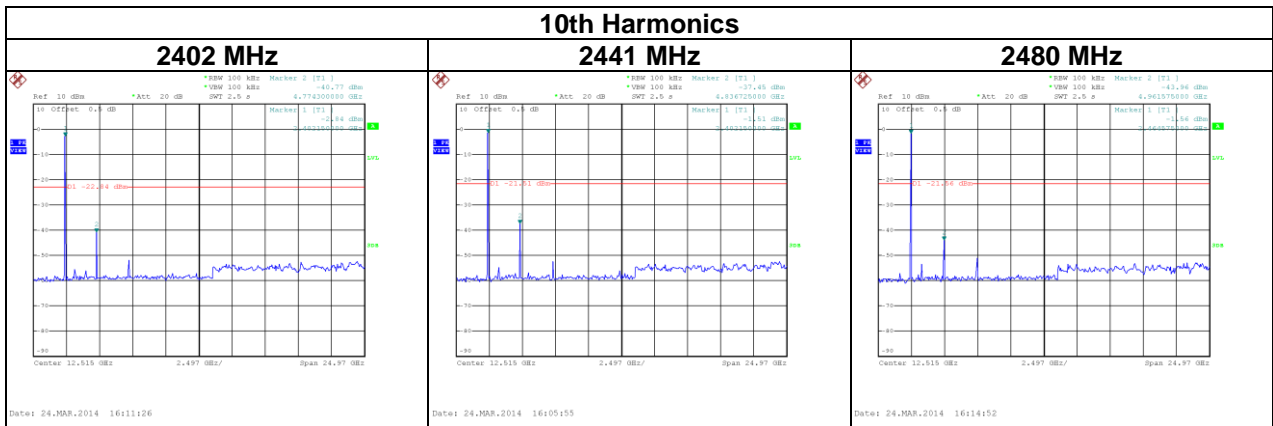

Test Mode 3Mbps

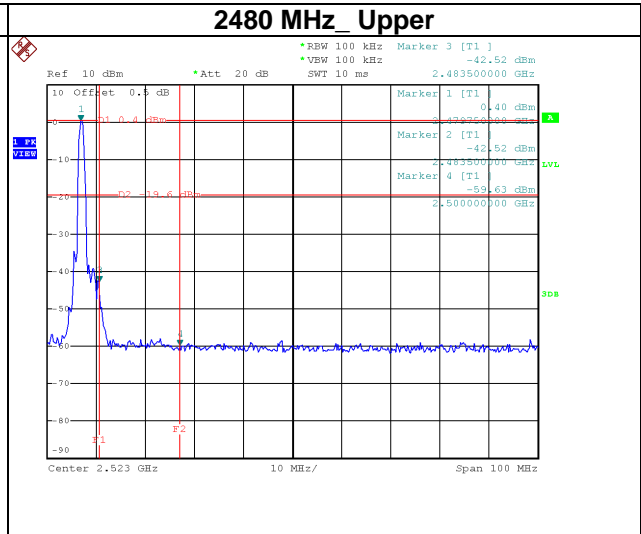
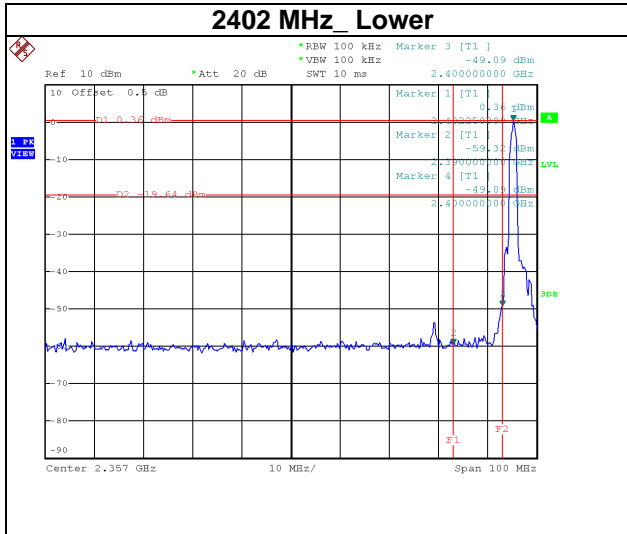

Date: 24.MAR.2014 16:36:49

Date: 24.MAR.2014 16:46:31

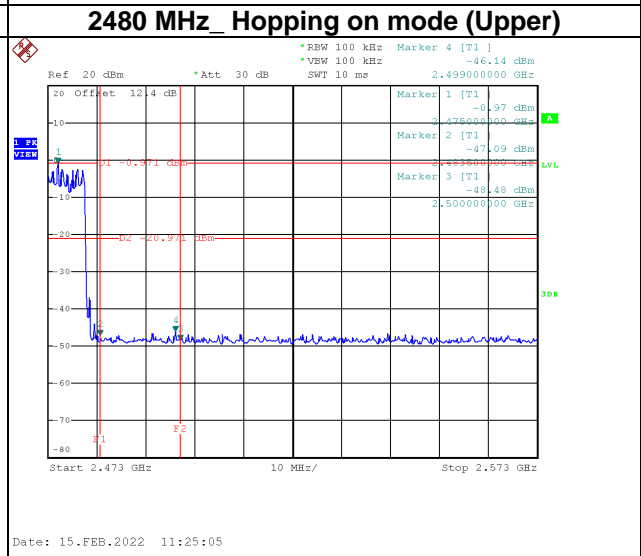
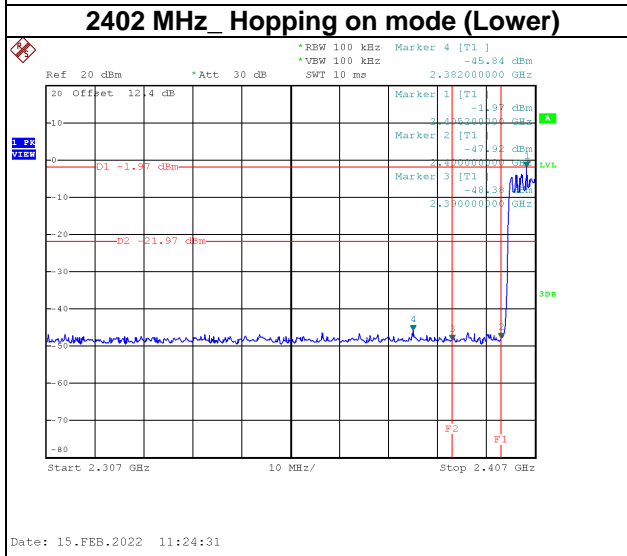

Date: 15.FEB.2022 11:24:31

Date: 15.FEB.2022 11:25:05

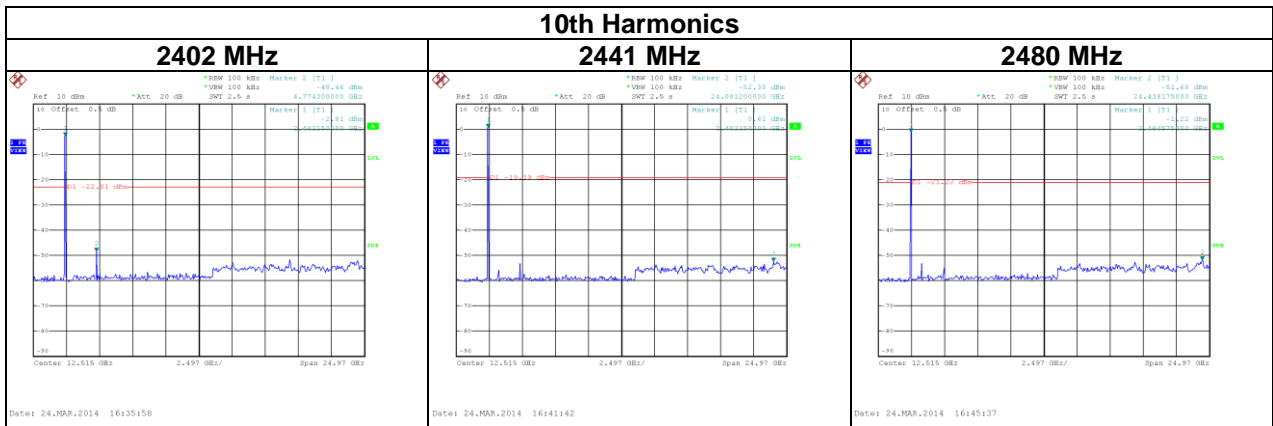

Date: 24.MAR.2014 16:35:58

Date: 24.MAR.2014 16:41:42

Date: 24.MAR.2014 16:45:37

End of Test Report