



Variant FCC Test Report

According to

47 CFR Part 22H, 24E

Equipment : PDA Phone
Trade Name : Opticon
Model Name : H-19A, H-19B
FCC ID : UFOBC0164AAA390
Tx Frequency Range : GSM850 : 824.2 ~ 848.8MHz
GSM1900 : 1850.2 ~1909.8 MHz
Max. ERP/EIRP Power : GSM850 : 0.94W
GSM1900 : 1.16W
Emission Designator : GSM : 300KGXW
EDGE : 300KG7W
Applicant : OPTOELECTRONICS CO., LTD.
12-17, Tsukagoshi 4-chome, Warabi-shi, Saitama,
335-0002, Japan

- This is a variant report which is only valid together with the original test report.
- The test result refers exclusively to the test presented test model / sample.
- Without written approval of SPORTON International Inc., the test report shall not be reproduced except in full.
- **Certificate or Test Report must not be used by the applicant to claim the product in this test report endorsement by NVLAP or any agency of U.S. government.**
- The data shown in this test report were carried out on Apr. 15, 2008 at **Sporton International Inc. LAB.**
- Report No.: FG853006, Report Version: Rev. 02.

Roy Wu
Manager

SPORTON International Inc.

No. 52, Hwa Ya 1st Rd., Hwa Ya Technology Park, Kwei-Shan Hsiang, Tao Yuan Hsien, Taiwan, R.O.C.

SPORTON International Inc.

TEL : 886-3-327-3456

FAX : 886-3-328-4978

Report Version: Rev. 02



Table of Contents

History of This Test Report ii

1. General Information 1

1.1 Applicant..... 1

1.2 Manufacturer 1

1.3 Basic Description of Equipment under Test..... 1

1.4 Feature of Equipment under Test..... 2

1.5 Report Date 2

2. Test Configuration of Equipment under Test 3

2.1 Test Manner 3

2.2 Test Mode 3

2.3 Connection Diagram of Test System 3

2.4 Ancillary Equipment List 3

3. General Information of Test Site..... 4

3.1 Test Voltage 4

3.2 Test Compliance..... 4

3.3 Frequency Range 4

3.4 Test Distance..... 4

4. Test Data and Test Result 5

4.1 List of Measurements and Examinations 5

4.2 ERP / EIRP Measurement..... 6

4.3 Field Strength of Spurious Radiation 9

5. List of Measurement Equipments 15

6. Uncertainty Evaluation 16

Appendix A. Photographs of EUT

Appendix B. Setup Photographs

Appendix C. Original Report



1. General Information

1.1 Applicant

OPTOELECTRONICS CO., LTD.

12-17, Tsukagoshi 4-chome, Warabi-shi, Saitama, 335-0002, Japan

1.2 Manufacturer

OPTOELECTRONICS CO., LTD.

12-17, Tsukagoshi 4-chome, Warabi-shi, Saitama, 335-0002, Japan

1.3 Basic Description of Equipment under Test

Equipment		PDA Phone
Trade Name		Opticon
Model Name		H-19A, H-19B
FCC ID		UFOBC0164AAA390
AC Adapter 1	Brand Name	PI Electronics Ltd.
	Model Name	AD7112B 03LF
	Power Rating	I/P:100-240Vac, 50-60Hz, 0.25A; O/P: 5Vdc, 1A
	AC Power Cord Type	1.6 meter shielded cable with ferrite core
AC Adapter 2 (for Cradle)	Brand Name	PI
	Model Name	AD7010-2LF
	Power Rating	I/P:100-240Vac, 50-60Hz, 0.6A; O/P: 5Vdc, 3.6A
	AC Power Cord Type	1.6 meter shielded cable without ferrite core
Battery	Brand Name	Opticon
	Model Name	H-19
	Power Rating	4.2Vdc, 1440mA
	Type	Li-ion
Earphone	Brand Name	TECHWIN Communication Co. Ltd
	Model Name	EE-624B-7EN
	Signal Line Type	1.2 meter non-shielded cable without ferrite core
USB Cable for PDA Phone	Brand Name	WIESON
	Model Name	G9904HT0220-002
	Signal Line Type	0.9 meter shielded cable without ferrite core
USB Cable for Cradle	Brand Name	WANSHIH
	Model Name	WA1Z3614B
	Signal line Type	1 meter shielded cable without ferrite core
Holster	Brand Name	Opticon
	Model Name	CRD-19
Scanner 1	Brand Name	OPTOELECTRONICS
	Model Name	MDL-2000
Scanner 2	Brand Name	OPTOELECTRONICS
	Model Name	MDI-1000

Remark:

- Scanner 1 was used for H-19A, and scanner 2 was used for H-19B.
- Above EUT's information was declared by manufacturer. Please refer to the specifications of manufacturer or User's Manual for more detailed features description.



1.4 Feature of Equipment under Test

Product Feature & Specification	
DUT Type :	PDA Phone
Trade Name :	Opticon
Model Name :	H-19A, H-19B
FCC ID :	UFOBC0164AAA390
Tx Frequency :	GSM850 : 824 MHz ~ 849 MHz GSM1900 : 1850 MHz ~1910 MHz
Rx Frequency :	GSM850 : 869 MHz ~ 894 MHz GSM1900 : 1930 MHz ~ 1990 MHz
Channel Spacing :	200 KHz
Maximum ERP/EIRP :	GSM850 : 0.94W (29.73dBm) GSM1900 : 1.16W (30.65dBm)
HW Version :	PEONY_PLUS2_MB_P3_V4.4
SW Version :	WM6: CE OS 5.2.1620 (Build 18125.0.4.2) ROM: 0.0.1.1(SVN=16)
GPRS Multislot class :	12
EGPRS Multislot class :	10
Power Rating (DC/AC , Voltage and Current of RF element or PA) :	DC 3.2V / 3.5A
Type of Modulation :	GSM : GMSK EDGE : 8PSK
Type of Emission :	GSM : 300KGXW EDGE : 300KG7W
DUT Stage :	Production Unit

1.5 Report Date

EUT Received : Apr. 04, 2008

Report Date : Aug. 12, 2008

2. Test Configuration of Equipment under Test

2.1 Test Manner

1. The spurious emission measurements were carried out in semi-anechoic chamber with 3-meter test range.
2. During all testings, EUT is in link mode with base station emulator at maximum power level.
3. Frequency range investigated: radiated emission 30 MHz to 9000 MHz for GSM850; 30MHz to 19000 MHz for GSM1900.

2.2 Test Mode

Application	GSM850	GSM1900
Radiated Emission	<input checked="" type="checkbox"/> Mode 1: GSM Link	<input checked="" type="checkbox"/> Mode 2: GSM Link

2.3 Connection Diagram of Test System

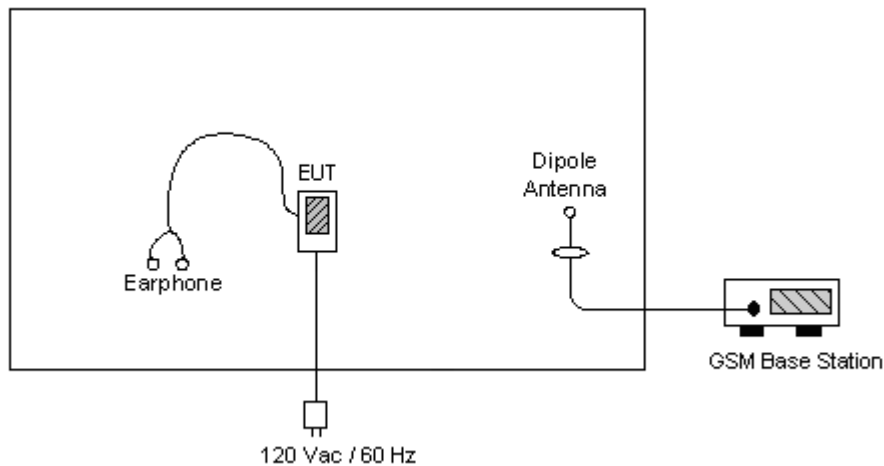

2.4 Ancillary Equipment List

Item	Equipment	Trade Name	Model No.	FCC ID	Data Cable	Power Code
1.	GSM Base Station	R&S	CMU200	N/A	N/A	Unshielded, 1.8m



3. General Information of Test Site

Test Site Location : No. 52, Hwa Ya 1st Rd., Hwa Ya Technology Park,
Kwei-Shan Hsiang, Tao Yuan Hsien, Taiwan, R.O.C.
TEL : 886-3-327-3456
FAX : 886-3-328-4978
Test Site No : 03CH06-HY
FCC Designation No : TW1022

The chamber meets the characteristics of ANSI C63.4-2003. This site is on file with the FCC.

3.1 Test Voltage

AC 120V / 60Hz

3.2 Test Compliance

47 CFR Part 22H, 24E, Part 2

3.3 Frequency Range

- a. Radiation: from 30MHz to 9000MHz for GSM850
- b. Radiation: from 30 MHz to 19000 MHz for GSM1900

3.4 Test Distance

The test distance of radiated emission from antenna to EUT is 3 m.



4. Test Data and Test Result

4.1 List of Measurements and Examinations

FCC Rule	Description of Test	Result	Section
§ 22.913 §24.232	ERP / EIRP	Passed	4.3
§2.1053	Field Strength of Spurious Radiation	Passed	4.6

Remark : The compliance is based on this report and the original report shown in appendix c.



4.2 ERP / EIRP Measurement

Equivalent isotropic radiated power measurements by substitution method according to ANSI/TIA/EIA-603-C.

4.2.1 Measurement Instruments

As described in chapter 5 of this test report.

4.2.2 Test Procedure

- a. The EUT was placed on a table with 1.0 meter height in an fully anechoic chamber.
- b. The EUT was set 1.2 meters from the receiving antenna which was mounted on the antenna tower.
- c. The table was rotated 360 degrees to determine the position of the highest radiated power.
- d. The height of the receiving antenna is also kept at 1.0M height.
- e. Taking the record of maximum ERP/EIRP.
- f. A dipole antenna was substituted in place of the EUT and was driven by a signal generator.
- g. The conducted power at the terminal of the dipole antenna is measured.
- h. Repeat step 3 to step 5 to get the maximum ERP/EIRP of the substitution antenna.
- i. $ERP/EIRP = P_s + E_t - E_s + G_s = P_s + R_t - R_s + G_s$

P_s (dBm) : Input power to substitution antenna.

G_s (dBi or dBd) : Substitution antenna Gain.

$E_t = R_t + AF$

$E_s = R_s + AF$

AF (dB/m) : Receive antenna factor

R_t : The highest received signal in Spectrum Analyzer for EUT.

R_s : The highest received signal in spectrum analyzer for substitution antenna.

4.2.3 Test Setup Layout of ERP/EIRP

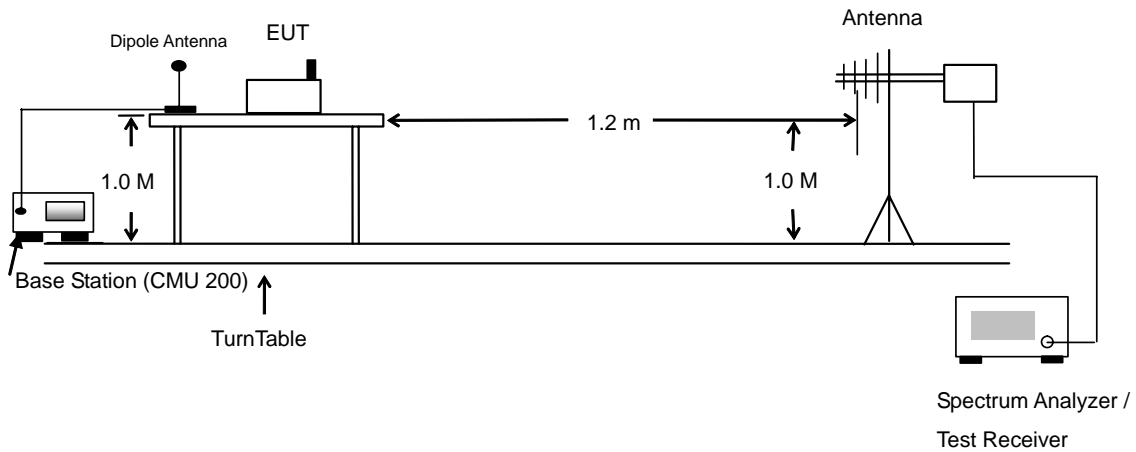



4.2.4 Test Result

GSM850 Radiated Power ERP						
Horizontal Polarization						
Frequency (MHz)	Rt (dBm)	Rs (dBm)	Ps (dBm)	Gs (dBd)	ERP (dBm)	ERP (W)
824.20	-29.81	-48.12	0.00	-1.08	17.23	0.05
836.40	-28.71	-48.28	0.00	-0.93	18.64	0.07
848.80	-27.38	-48.35	0.00	-0.76	20.21	0.10
Vertical Polarization						
Frequency (MHz)	Rt (dBm)	Rs (dBm)	Ps (dBm)	Gs (dBd)	ERP (dBm)	ERP (W)
824.20	-20.14	-47.97	0.00	-1.08	26.75	0.47
836.40	-18.74	-48.01	0.00	-0.93	28.34	0.68
848.80	-17.56	-48.05	0.00	-0.76	29.73	0.94

GSM1900 Radiated Power EIRP						
Horizontal Polarization						
Frequency (MHz)	Rt (dBm)	Rs (dBm)	Ps (dBm)	Gs (dBi)	EIRP (dBm)	EIRP (W)
1850.20	-24.34	-51.88	0.00	1.96	29.50	0.89
1880.00	-28.04	-52.99	0.00	2.00	26.95	0.50
1909.80	-30.80	-54.28	0.00	1.98	25.46	0.35
Vertical Polarization						
Frequency (MHz)	Rt (dBm)	Rs (dBm)	Ps (dBm)	Gs (dBi)	EIRP (dBm)	EIRP (W)
1850.20	-23.44	-52.13	0.00	1.96	30.65	1.16
1880.00	-26.45	-53.17	0.00	2.00	28.72	0.74
1909.80	-28.81	-54.13	0.00	1.98	27.30	0.54



4.3 Field Strength of Spurious Radiation

Equivalent isotropic radiated Power Measurements by substitution method according to ANSI/TIA/EIA-603-C.

4.3.1 Measurement Instruments

As described in chapter 5 of this test report.

4.3.2 Test Procedure

- a. The EUT was placed on a rotatable wooden table with 0.8 meter about ground.
- b. The EUT was set 3 meters from the receiving antenna which was mounted on the antenna tower.
- c. The table was rotated 360 degrees to determine the position of the highest spurious emission.
- d. The height of the receiving antenna is varied between one meter and four meters to reach the maximum spurious emission for both horizontal and vertical polarizations.
- e. Taking the record of maximum spurious emission.
- f. A Horn antenna was substituted in place of the EUT and was driven by a signal generator.
- g. Tune the output power of signal generator to the same emission level with EUT maximum spurious emission.
- h. Taking the record of output power at antenna port.
- i. Repeat step 7 to step 8 for another polarization.
- j. Emission level (dBm) = output power + substitution Gain.

4.3.3 Test Setup Layout

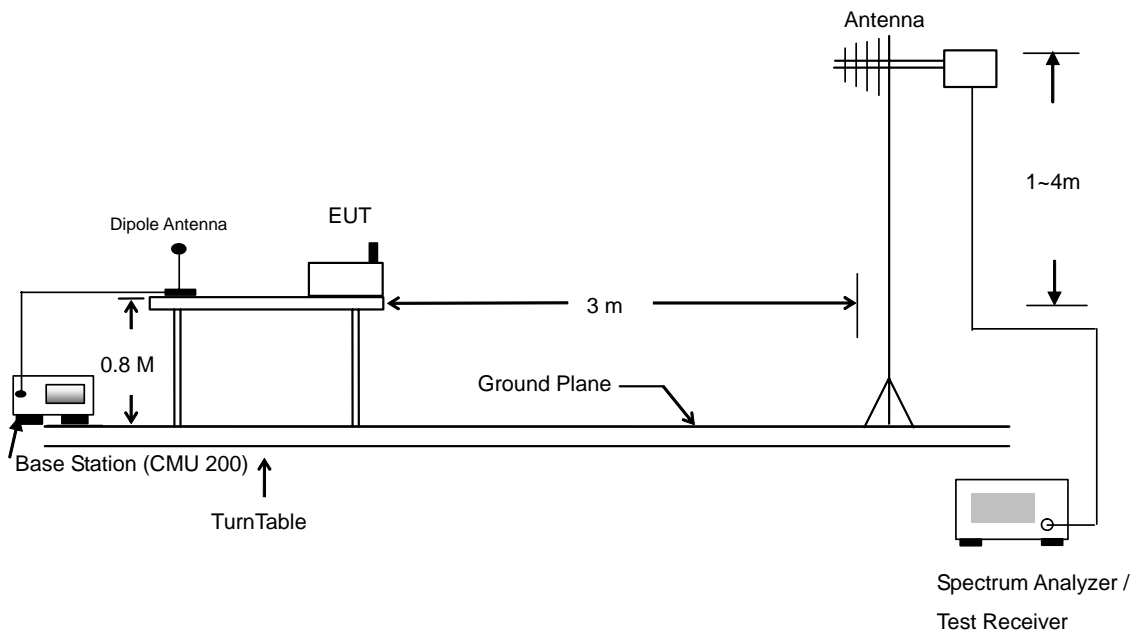



4.3.4 Test Result

4.3.4.1 Test Data

- Mode 1
- Horizontal Polarization

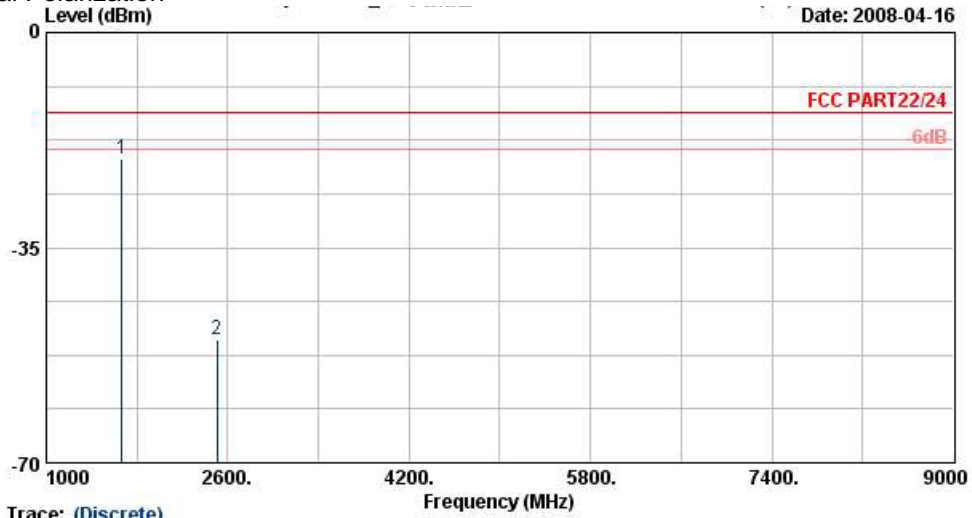

Trace: (Discrete)
 Site : 03CH07-HY
 Condition : FCC PART22/24 HF-EIRP(080306) HORIZONTAL
 EUT : PDA Phone
 Power : 120Vac/60Hz
 Model : PG 840402
 Mode : GSM 850 Link; Ch189 + Adaptor + Earphone
 Plane : E2
 IMEI : 355634007734400

Frequency (MHz)	ERP (dBm)	Limit (dBm)	Over Limit (dB)	SPA Reading (dBm)	S.G. Power (dBm)	TX Cable loss (dB)	TX Antenna Gain (dBi)	Polarization (H/V)	Result
1669	-20.49	-13	-7.49	-27.33	-19.5	3.39	4.55	H	Pass
2509	-49.94	-13	-36.94	-57.85	-50.0	3.71	5.92	H	Pass

Remark : Spurious emissions within 30-1000MHz were found more than 20dB below limit line.



Vertical Polarization

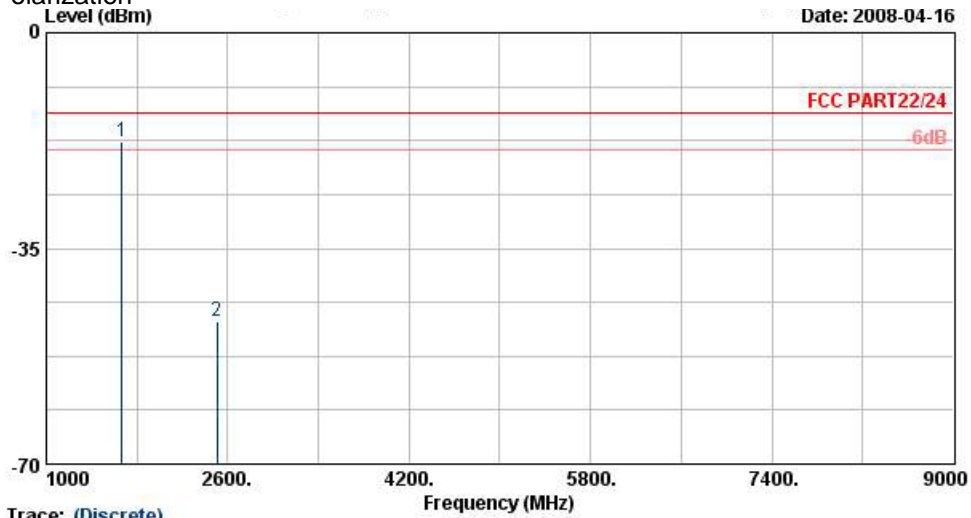

Trace: (Discrete)
 Site : 03CH07-HY
 Condition : FCC PART22/24 HF-EIRP(080306) VERTICAL
 EUT : PDA Phone
 Power : 120Vac/60Hz
 Model : FG 840402
 Mode : GSM 850 Link; Ch189 + Adaptor + Earphone
 Plane : E2
 IMEI : 355634007734400

Frequency (MHz)	ERP (dBm)	Limit (dBm)	Over Limit (dB)	SPA Reading (dBm)	S.G. Power (dBm)	TX Cable loss (dB)	TX Antenna Gain (dBi)	Polarization (H/V)	Result
1669	-17.78	-13	-4.78	-25.69	-16.4	3.39	4.16	V	Pass
2509	-46.74	-13	-33.74	-57.57	-46.6	3.71	5.72	V	Pass

Remark : Spurious emissions within 30-1000MHz were found more than 20dB below limit line.



- Mode 2
- Horizontal Polarization

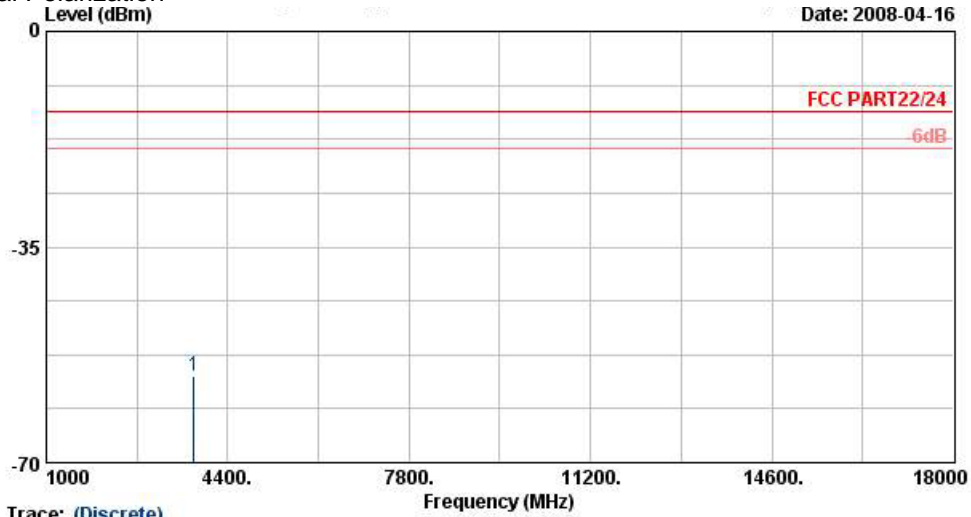

Trace: (Discrete)
 Site : 03CH07-HY
 Condition : FCC PART22/24 HF-EIRP(080306) HORIZONTAL
 EUT : PDA Phone
 Power : 120Vac/60Hz
 Model : FG 840402
 Mode : PCS1900 Link; Ch661 + Adaptor + Earphone
 Plane : E2
 IMEI : 355634007734400

Frequency (MHz)	ERP (dBm)	Limit (dBm)	Over Limit (dB)	SPA Reading (dBm)	S.G. Power (dBm)	TX Cable loss (dB)	TX Antenna Gain (dBi)	Polarization (H/V)	Result
3760	-55.93	-13	-42.93	-65.29	-59.3	4.03	7.40	H	Pass

Remark : Spurious emissions within 30-1000MHz were found more than 20dB below limit line.



Vertical Polarization

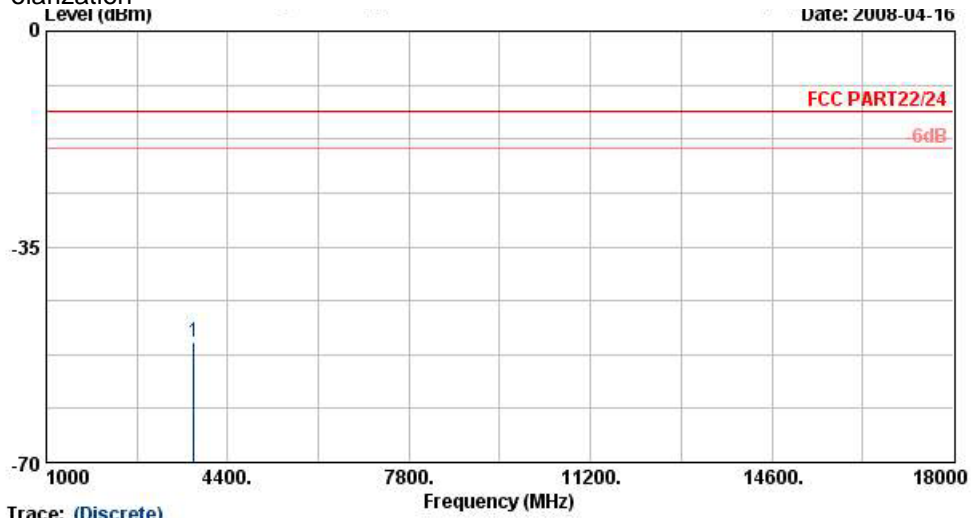

Site : 03CH07-HY
 Condition : FCC PART22/24 HF-EIRP(080306) VERTICAL
 EUT : PDA Phone
 Power : 120Wac/60Hz
 Model : FG 840402
 Mode : PCS1900 Link; Ch661 + Adaptor + Earphone
 Plane : E2
 IMEI : 355634007734400

Frequency (MHz)	ERP (dBm)	Limit (dBm)	Over Limit (dB)	SPA Reading (dBm)	S.G. Power (dBm)	TX Cable loss (dB)	TX Antenna Gain (dBi)	Polarization (H/V)	Result
3760	-50.52	-13	-37.52	-63.8	-54.4	4.03	7.91	V	Pass

Remark : Spurious emissions within 30-1000MHz were found more than 20dB below limit line.



5. List of Measurement Equipments

Instrument	Manufacturer	Model No.	Serial No.	Characteristics	Calibration Date	Due Date	Remark
Spectrum Analyzer	Agilent	E4408B	MY44211028	9KHz-26.5GHz	Oct. 17, 2007	Oct. 16, 2008	Radiation (03CH07-HY)
EMI Test Receiver	R&S	ESCS30	100356	9KHz-2.75GHz	Jul. 26, 2007	Jul. 25, 2008	Radiation (03CH07-HY)
Bilog Antenna	SCHAFFNER	CBL6112B	2885	30MHz -2GHz	Dec. 01, 2007	Nov. 30, 2008	Radiation (03CH07-HY)
Double Ridge Horn Antenna	EMCO	3117	00075962	1G~18G	Aug. 29, 2007	Aug. 28, 2008	Radiation (03CH07-HY)
SHF-EHF Horn	SCHWARZBECK	BBHA 9170	9170-251	14G - 40G	Oct. 17, 2007	Oct. 16, 2008	Radiation (03CH07-HY)
Pre Amplifier	Agilent	8449B	3008A01917	1G - 26.5G	Nov. 22, 2007	Nov. 21, 2008	Radiation (03CH07-HY)
Pre Amplifier	EMEC	PA303	PA303-SMA-	100K~3GHz	Nov. 26, 2007	Nov. 25, 2008	Radiation (03CH07-HY)
Base Station Simulator	R & S	CMU200	103937	Third-Band	Oct. 19, 2007	Oct. 18, 2008	Radiation (03CH07-HY)

6. Uncertainty Evaluation

Uncertainty of Radiated Emission Measurement (30MHz ~ 1000MHz)

Contribution	Uncertainty of x_i		$u(x_i)$
	dB	Probability Distribution	
Receiver reading	0.41	Normal(k=2)	0.21
Antenna factor calibration	0.83	Normal(k=2)	0.42
Cable loss calibration	0.25	Normal(k=2)	0.13
Pre Amplifier Gain calibration	0.27	Normal(k=2)	0.14
RCV/SPA specification	2.50	Rectangular	0.72
Antenna Factor Interpolation for Frequency	1.00	Rectangular	0.29
Site imperfection	1.43	Rectangular	0.83
Mismatch	+0.39/-0.41	U-shaped	0.28
Combined standard uncertainty Uc(y)	1.27		
Measuring uncertainty for a level of confidence of 95% U=2Uc(y)	2.54		

Uncertainty of Radiated Emission Measurement (1GHz ~ 40GHz)

Contribution	Uncertainty of x_i		$u(x_i)$	C_i	$C_i * u(x_i)$
	dB	Probability Distribution			
Receiver reading	±0.10	Normal(k=1)	0.10	1	0.10
Antenna factor calibration	±1.70	Normal(k=2)	0.85	1	0.85
Cable loss calibration	±0.50	Normal(k=2)	0.25	1	0.25
Receiver Correction	±2.00	Rectangular	1.15	1	1.15
Antenna Factor Directional	±1.50	Rectangular	0.87	1	0.87
Site imperfection	±2.80	Triangular	1.14	1	1.14
Mismatch Receiver VSWR $\Gamma_1 = 0.197$ Antenna VSWR $\Gamma_2 = 0.194$ Uncertainty = $20 \log(1 - \Gamma_1 * \Gamma_2 * \Gamma_3)$	+0.34/-0.35	U-shaped	0.244	1	0.244
Combined standard uncertainty Uc(y)	2.36				
Measuring uncertainty for a level of confidence of 95% U=2Uc(y)	4.72				

END OF TEST REPORT



Appendix A. Photographs of EUT

Please refer to Sporton report number EP840402 as below.



Appendix B. Setup Photographs

Please refer to Appendix B as below.



Appendix C. Original Report

Please refer to Sporton report number FG762206-B as below.



FCC TEST REPORT

for

47 CFR Part 22H, 24E

Equipment : PDA Phone
Trade Name : Opticon
Model No. : H-19A, H-19B
FCC ID : UFOBC0164AAA390
Tx Frequency Range : GSM850 : 824.2~848.8 MHz
PCS1900 : 1850.2~1909.8 MHz
Max. ERP/EIRP Power : GSM850(GSM) : 0.83W
GSM850(EDGE) : 0.12W
PCS1900(GSM) : 1.31W
PCS1900(EDGE) : 0.29W
Emission Designator : GSM : 300KGXW
EDGE : 300KG7W
Applicant : OPTOELECTRONICS CO., LTD.
12-17, Tsukagoshi 4-chome, Warabi-shi, Saitama,
335-0002, Japan

- The test result refers exclusively to the test presented test model / sample.
- Without written approval of SPORTON International Inc., the test report shall not be reproduced except in full.
- **Certificate or Test Report must not be used by the applicant to claim the product in this test report endorsement by NVLAP or any agency of U.S. government.**
- The data shown in this test report were carried out on Jul. 15, 2007 at **Sporton International Inc. LAB.**
- Report No.: FG762206-B, Report Version: Rev. 01.

Jones Tsai
Manager

SPORTON International Inc.

6F, No.106, Sec. 1, Hsin Tai Wu Rd., Hsi Chih, Taipei Hsien, Taiwan, R.O.C.

SPORTON International Inc.

TEL : 886-2-2696-2468

FAX : 886-2-2696-2255

Report Version: Rev. 01



Table of Contents

History of this test reportii

1. General Information.....1

 1.1. Applicant.....1

 1.2. Manufacturer1

 1.3. Basic Description of Equipment under Test.....1

 1.4. Feature of Equipment under Test.....2

 1.5. Report Date3

2. Test Configuration of Equipment under Test.....4

 2.1. Test Manner4

 2.2. Test Mode.....4

 2.3. Connection Diagram of Test System4

 2.4. Ancillary Equipment List4

3. General Information of Test Site5

 3.1. Test Voltage5

 3.2. Test Compliance.....5

 3.3. Frequency Range5

 3.4. Test Distance.....5

4. Test Data and Test Result.....6

 4.1. List of Measurements and Examinations.....6

 4.2. RF Output Power.....7

 4.3. ERP / EIRP Measurement.....9

 4.4. Occupied Bandwidth and Band Edge Measurement15

 4.5. Conducted Emission.....48

 4.6. Field Strength of Spurious Radiation67

 4.7. Frequency Stability (Temperature Variation)81

 4.8. Frequency Stability (Voltage Variation)84

5. List of Measurement Equipments86

6. Uncertainty Evaluation.....87

- Appendix A - External Photographs
- Appendix B - Internal Photographs
- Appendix C - Setup Photographs



History of this test report

Report Issue Date: Jul. 23, 2007

Report No.	Description



1. General Information

1.1. Applicant

OPTOELECTRONICS CO., LTD.
12-17, Tsukagoshi 4-chome, Warabi-shi, Saitama, 335-0002, Japan

1.2 Manufacturer

OPTOELECTRONICS CO., LTD.
12-17, Tsukagoshi 4-chome, Warabi-shi, Saitama, 335-0002, Japan

1.3 Basic Description of Equipment under Test

Equipment		PDA Phone
Trade Name		Opticon
Model Name		H-19A, H-19B
AC Adapter 1	Brand Name	PI Electronics
	Model Name	AD7112B 03LF
	Power Rating	I/P:100-240Vac, 50-60Hz, 0.25A; O/P: 5Vdc, 1A
	AC Power Cord Type	1.6 meter shielded cable with ferrite core
AC Adapter 2	Brand Name	HP
	Model Name	HSTNN-P05A
	Power Rating	I/P:100-240Vac, 50-60Hz, 0.6A; O/P: 5Vdc, 3.6A
	AC Power Cord Type	1.6 meter shielded cable without ferrite core
Battery	Brand Name	Opticon
	Model Name	H-19
	Rating	4.2Vdc, 1440mA
	Type	Li-ion
Earphone	Brand Name	TECHWIN Communication Co. Ltd
	Model Name	EE-624A-8EN
	Signal line Type	1.2 meter non-shielded cable without ferrite core
USB Cable for Phone	Brand Name	WIESON
	Model Name	160035
	Signal line Type	0.9 meter shielded cable without ferrite core
USB Cable for Cradle	Brand Name	WIESON
	Model Name	160035
	Signal line Type	1 meter shielded cable without ferrite core
Cradle	Brand Name	Opticon
	Model Name	CRD-19
Scanner 1	Brand Name	OPTOELECTRONICS
	Model Name	MDL-2000
Scanner 2	Brand Name	OPTOELECTRONICS
	Model Name	MDI-1000

Remark : Scanner 1 was used for H-19A, and scanner 2 was used for H-19B.

**1.4 Feature of Equipment under Test**

DUT Type :	PDA Phone
Trade Name :	Opticon
Model Name :	H-19A, H-19B
FCC ID :	UFOBC0164AAA390
Tx Frequency :	GSM850 : 824 ~ 849 MHz PCS1900 : 1850 ~1910 MHz
Rx Frequency :	GSM850 : 869 ~ 894 MHz PCS1900 : 1930 ~ 1990 MHz
Maximum Output Power to Antenna :	Phone with Scanner 1 GSM850 : 32.23 dBm (GSM) ; 24.21 dBm (EDGE) PCS1900 : 29.26 dBm (GSM) ; 22.84 dBm (EDGE) Phone with Scanner 2 GSM850 : 32.61 dBm (GSM) ; 24.16 dBm (EDGE) PCS1900 : 29.29 dBm (GSM) ; 22.91 dBm (EDGE)
Maximum ERP/EIRP :	Phone with Scanner 1 GSM850(GSM) : 0.31 W (24.86 dBm) GSM850(EDGE) : 0.07 W (18.22 dBm) PCS1900(GSM) : 0.51 W (27.08 dBm) PCS1900(EDGE) : 0.10 W (19.84 dBm) Phone with Scanner 2 GSM850(GSM) : 0.83 W (29.18 dBm) GSM850(EDGE) : 0.12 W (20.78 dBm) PCS1900(GSM) : 1.31 W (31.18 dBm) PCS1900(EDGE) : 0.29 W (24.67 dBm)
Antenna Type :	GSM : PIFA Antenna Bluetooth : Chip Antenna WLAN : PIFA Antenna
Type of Antenna Connector	N/A
Power Rating (DC/AC ,Voltage) :	DC 3.7V
Digital Modulation Emission :	GSM : GMSK EDGE : 8PSK
Type of Emission :	GSM : 300KGXW EDGE : 300KG7W
DUT Stage :	Identical Prototype



1.5 Report Date

EUT Received : Jun. 22, 2007

Report Date : Jul. 23, 2007

2 Test Configuration of Equipment under Test

2.1 Test Manner

- a. The spurious emission measurements were carried out in semi-anechoic chamber with 3-meter test range.
- b. During all testings, EUT is in link mode with base station emulator at maximum power level.
- c. Frequency range investigated: radiated emission 30 MHz to 9000 MHz for GSM850; 30MHz to 19000 MHz for PCS1900.
- d. Test modes were performed with scanner 2.

2.2 Test Mode

Application	GSM850	PCS1900
Radiated Emission	<input checked="" type="checkbox"/> Mode 1: GSM Link <input checked="" type="checkbox"/> Mode 2: EDGE Link <input checked="" type="checkbox"/> Mode 5: GSM Link + WLAN Link	<input checked="" type="checkbox"/> Mode 3: GSM Link <input checked="" type="checkbox"/> Mode 4: EDGE Link
Conducted Measurement	<input checked="" type="checkbox"/> Mode 1: GSM Link <input checked="" type="checkbox"/> Mode 2: EDGE Link	<input checked="" type="checkbox"/> Mode 3: GSM Link <input checked="" type="checkbox"/> Mode 4: EDGE Link

2.3 Connection Diagram of Test System

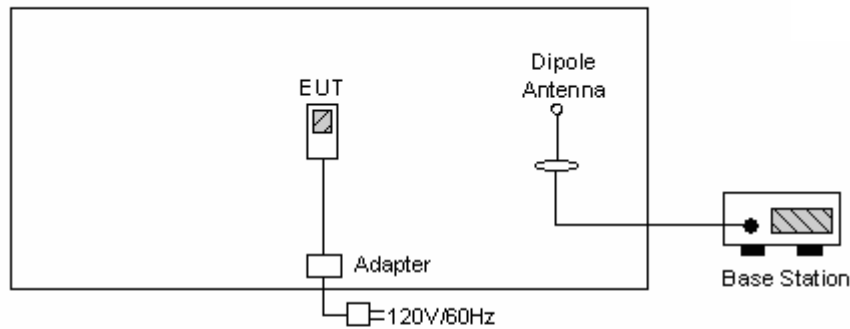

2.4 Ancillary Equipment List

Item	Equipment	Trade Name	Model No.	FCC ID	Serial No.
1.	Base Station	R&S	CMU200	N/A	106656



3. General Information of Test Site

Test Site Location : No. 52, Hwa Ya 1st Rd., Hwa Ya Technology Park,
Kwei-Shan Hsiang, Tao Yuan Hsien, Taiwan, R.O.C.
TEL : 886-3-327-3456
FAX : 886-3-318-0055

Test Site No : 03CH06-HY

The chamber meets the characteristics of ANSI C63.4-2003. This site is on file with the FCC.

3.1 Test Voltage

AC 120V / 60Hz

3.2 Test Compliance

47 CFR Part 22H, 24E, Part 2

3.3 Frequency Range

- a. Radiation: from 30MHz to 9000MHz for GSM850
- b. Radiation: from 30 MHz to 19000 MHz for PCS1900

3.4 Test Distance

The test distance of radiated emission from antenna to EUT is 3 m.



4. Test Data and Test Result

4.1 List of Measurements and Examinations

FCC Rule	DESCRIPTION OF TEST	Result	Section
§2.1046	RF Output Power	Passed	4.2
§ 22.913 §24.232	ERP / EIRP	Passed	4.3
§2.1049, § 22.917, § 24.238(b)	Occupied Bandwidth & Band Edge Measurement	Passed	4.4
§2.1051	Conducted Emission	Passed	4.5
§2.1053	Field Strength of Spurious Radiation	Passed	4.6
§2.1055, § 22.355, §24.235	Frequency Stability vs. Temperature	Passed	4.7
§2.1055, §22.355, §24.235	Frequency Stability vs. Voltage	Passed	4.8

4.2 RF Output Power

4.2.1 Measurement Instruments :

As described in chapter 5 of this test report.

4.2.2 Test Procedure :

1. The transmitter output was connected to power meter and base station through power divider.
2. Set EUT at PCL=5 for GSM850 and/or PCL=0 for PCS1900 maximum power through base station.
3. Select lowest, middle, and highest channels for each band.

4.2.3 Test Setup Layout :

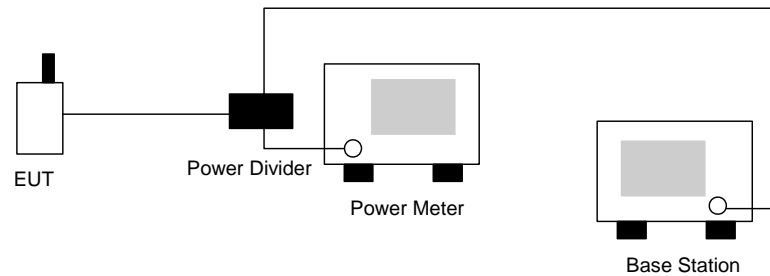



4.2.4 Test Result :

<Phone with Scanner 1>

Bands	Channel	Frequency (MHz)	Conducted Power (dBm)	Conducted Power (Watts)
GSM850 (GSM)	128	824.2 (Low)	32.12	1.629
	189	836.4 (Mid)	32.19	1.656
	251	848.8 (High)	32.23	1.671
GSM850 (EDGE)	128	824.2 (Low)	24.21	0.264
	189	836.4 (Mid)	24.14	0.259
	251	848.8 (High)	24.12	0.258
PCS1900 (GSM)	512	1850.2 (Low)	28.75	0.750
	661	1880.0 (Mid)	29.11	0.815
	810	1909.8 (High)	29.26	0.843
PCS1900 (EDGE)	512	1850.2 (Low)	22.84	0.192
	661	1880.0 (Mid)	22.76	0.189
	810	1909.8 (High)	22.68	0.185

<Phone with Scanner 2>

Bands	Channel	Frequency (MHz)	Conducted Power (dBm)	Conducted Power (Watts)
GSM850 (GSM)	128	824.2 (Low)	32.23	1.671
	189	836.4 (Mid)	32.44	1.754
	251	848.8 (High)	32.61	1.824
GSM850 (EDGE)	128	824.2 (Low)	24.16	0.261
	189	836.4 (Mid)	24.11	0.258
	251	848.8 (High)	24.04	0.254
PCS1900 (GSM)	512	1850.2 (Low)	28.89	0.774
	661	1880.0 (Mid)	29.28	0.847
	810	1909.8 (High)	29.29	0.849
PCS1900 (EDGE)	512	1850.2 (Low)	22.91	0.195
	661	1880.0 (Mid)	22.83	0.192
	810	1909.8 (High)	22.71	0.187



4.3 ERP / EIRP Measurement

Equivalent isotropic radiated power measurements by substitution method according to ANSI/TIA/EIA-603-C.

4.3.1 Measurement Instruments

As described in chapter 5 of this test report.

4.3.2 Test Procedure

1. The EUT was placed on a rotatable table with 1.0 meter height in an fully anechoic chamber.
2. The EUT was set 1.2 meters from the receiving antenna which was mounted on the antenna tower.
3. The table was rotated 360 degrees to determine the position of the highest radiated power.
4. The height of the receiving antenna is also kept at 1.0M height.
5. Taking the record of maximum ERP/EIRP.
6. A dipole antenna was substituted in place of the EUT and was driven by a signal generator.
7. The conducted power at the terminal of the dipole antenna is measured.
8. Repeat step 3 to step 5 to get the maximum ERP/EIRP of the substitution antenna.
9. $ERP/EIRP = P_s + E_t - E_s + G_s = P_s + R_t - R_s + G_s$

P_s (dBm) : Input power to substitution antenna.

G_s (dBi or dBd) : Substitution antenna Gain.

$E_t = R_t + AF$

$E_s = R_s + AF$

AF (dB/m) : Receive antenna factor

R_t : The highest received signal in Spectrum Analyzer for EUT.

R_s : The highest received signal in spectrum analyzer for substitution antenna.

4.3.3 Test Setup Layout of ERP/EIRP

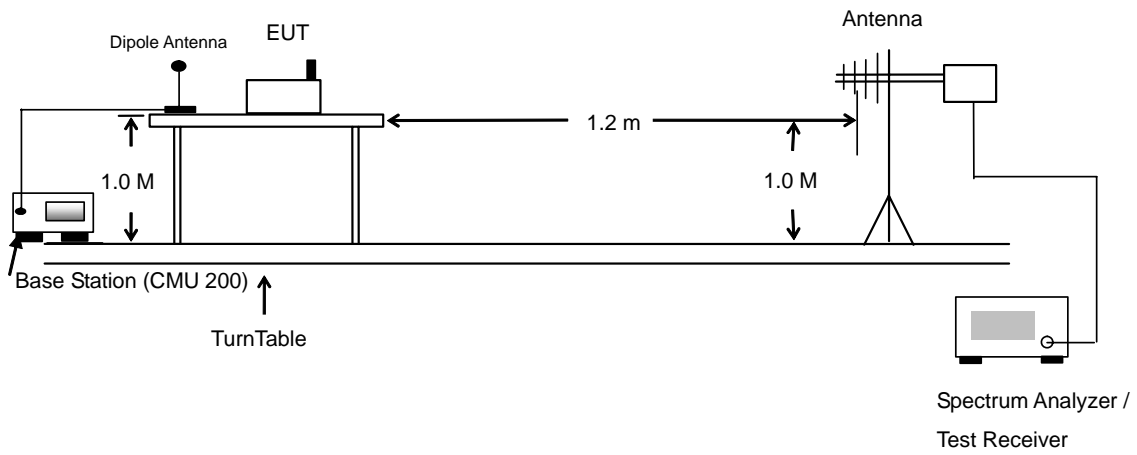



4.3.4 Test Result :

<Phone with Scanner 1>

GSM850 (GSM) Radiated Power ERP						
Horizontal Polarization						
Frequency (MHz)	Rt (dBm)	Rs (dBm)	Ps (dBm)	Gs (dBd)	ERP (dBm)	ERP (W)
824.20	-34.98	-48.12	0.00	-1.08	12.06	0.02
836.40	-34.56	-48.28	0.00	-0.93	12.79	0.02
848.80	-34.90	-48.35	0.00	-0.76	12.69	0.02
Vertical Polarization						
Frequency (MHz)	Rt (dBm)	Rs (dBm)	Ps (dBm)	Gs (dBd)	ERP (dBm)	ERP (W)
824.20	-22.29	-47.97	0.00	-1.08	24.60	0.29
836.40	-22.34	-48.01	0.00	-0.93	24.74	0.30
848.80	-22.43	-48.05	0.00	-0.76	24.86	0.31

GSM850 (EDGE) Radiated Power ERP						
Horizontal Polarization						
Frequency (MHz)	Rt (dBm)	Rs (dBm)	Ps (dBm)	Gs (dBd)	ERP (dBm)	ERP (W)
824.20	-40.89	-48.12	0.00	-1.08	6.15	0.00
836.40	-41.96	-48.28	0.00	-0.93	5.39	0.00
848.80	-42.88	-48.35	0.00	-0.76	4.71	0.00
Vertical Polarization						
Frequency (MHz)	Rt (dBm)	Rs (dBm)	Ps (dBm)	Gs (dBd)	ERP (dBm)	ERP (W)
824.20	-28.67	-47.97	0.00	-1.08	18.22	0.07
836.40	-29.46	-48.01	0.00	-0.93	17.62	0.06
848.80	-30.26	-48.05	0.00	-0.76	17.03	0.05



PCS1900 (GSM) Radiated Power EIRP						
Horizontal Polarization						
Frequency (MHz)	Rt (dBm)	Rs (dBm)	Ps (dBm)	Gs (dBi)	EIRP (dBm)	EIRP (W)
1850.20	-27.05	-51.88	0.00	1.96	26.79	0.48
1880.00	-28.70	-52.99	0.00	2.00	26.29	0.43
1909.80	-32.70	-54.28	0.00	1.98	23.56	0.23
Vertical Polarization						
Frequency (MHz)	Rt (dBm)	Rs (dBm)	Ps (dBm)	Gs (dBi)	EIRP (dBm)	EIRP (W)
1850.20	-27.01	-52.13	0.00	1.96	27.08	0.51
1880.00	-28.69	-53.17	0.00	2.00	26.48	0.44
1909.80	-33.38	-54.13	0.00	1.98	22.73	0.19

PCS1900 (EDGE) Radiated Power EIRP						
Horizontal Polarization						
Frequency (MHz)	Rt (dBm)	Rs (dBm)	Ps (dBm)	Gs (dBi)	EIRP (dBm)	EIRP (W)
1850.20	-34.65	-51.88	0.00	1.96	19.19	0.08
1880.00	-37.38	-52.99	0.00	2.00	17.61	0.06
1909.80	-39.72	-54.28	0.00	1.98	16.54	0.05
Vertical Polarization						
Frequency (MHz)	Rt (dBm)	Rs (dBm)	Ps (dBm)	Gs (dBi)	EIRP (dBm)	EIRP (W)
1850.20	-34.25	-52.13	0.00	1.96	19.84	0.10
1880.00	-37.51	-53.17	0.00	2.00	17.66	0.06
1909.80	-39.57	-54.13	0.00	1.98	16.54	0.05



<Phone with Scanner 2>

GSM850 (GSM) Radiated Power ERP						
Horizontal Polarization						
Frequency (MHz)	Rt (dBm)	Rs (dBm)	Ps (dBm)	Gs (dBd)	ERP (dBm)	ERP (W)
824.20	-34.07	-48.12	0.00	-1.08	12.97	0.02
836.40	-33.19	-48.28	0.00	-0.93	14.16	0.03
848.80	-31.80	-48.35	0.00	-0.76	15.79	0.04
Vertical Polarization						
Frequency (MHz)	Rt (dBm)	Rs (dBm)	Ps (dBm)	Gs (dBd)	ERP (dBm)	ERP (W)
824.20	-20.99	-47.97	0.00	-1.08	25.90	0.39
836.40	-19.43	-48.01	0.00	-0.93	27.65	0.58
848.80	-18.11	-48.05	0.00	-0.76	29.18	0.83

GSM850 (EDGE) Radiated Power ERP						
Horizontal Polarization						
Frequency (MHz)	Rt (dBm)	Rs (dBm)	Ps (dBm)	Gs (dBd)	ERP (dBm)	ERP (W)
824.20	-40.39	-48.12	0.00	-1.08	6.65	0.00
836.40	-40.66	-48.28	0.00	-0.93	6.69	0.00
848.80	-40.26	-48.35	0.00	-0.76	7.33	0.01
Vertical Polarization						
Frequency (MHz)	Rt (dBm)	Rs (dBm)	Ps (dBm)	Gs (dBd)	ERP (dBm)	ERP (W)
824.20	-27.39	-47.97	0.00	-1.08	19.50	0.09
836.40	-26.62	-48.01	0.00	-0.93	20.46	0.11
848.80	-26.51	-48.05	0.00	-0.76	20.78	0.12



PCS1900 (GSM) Radiated Power EIRP						
Horizontal Polarization						
Frequency (MHz)	Rt (dBm)	Rs (dBm)	Ps (dBm)	Gs (dBi)	EIRP (dBm)	EIRP (W)
1850.20	-24.20	-51.88	0.00	1.96	29.64	0.92
1880.00	-24.73	-52.99	0.00	2.00	30.26	1.06
1909.80	-27.69	-54.28	0.00	1.98	28.57	0.72
Vertical Polarization						
Frequency (MHz)	Rt (dBm)	Rs (dBm)	Ps (dBm)	Gs (dBi)	EIRP (dBm)	EIRP (W)
1850.20	-23.49	-52.13	0.00	1.96	30.60	1.15
1880.00	-23.99	-53.17	0.00	2.00	31.18	1.31
1909.80	-26.63	-54.13	0.00	1.98	29.48	0.89

PCS1900 (EDGE) Radiated Power EIRP						
Horizontal Polarization						
Frequency (MHz)	Rt (dBm)	Rs (dBm)	Ps (dBm)	Gs (dBi)	EIRP (dBm)	EIRP (W)
1850.20	-32.25	-51.88	0.00	1.96	21.59	0.14
1880.00	-31.25	-52.99	0.00	2.00	23.74	0.24
1909.80	-32.93	-54.28	0.00	1.98	23.33	0.22
Vertical Polarization						
Frequency (MHz)	Rt (dBm)	Rs (dBm)	Ps (dBm)	Gs (dBi)	EIRP (dBm)	EIRP (W)
1850.20	-31.10	-52.13	0.00	1.96	22.99	0.20
1880.00	-30.50	-53.17	0.00	2.00	24.67	0.29
1909.80	-32.40	-54.13	0.00	1.98	23.71	0.23

4.4 Occupied Bandwidth and Band Edge Measurement

4.4.1 Measurement Instruments

As described in chapter 5 of this test report.

4.4.2 Test Procedure

1. The EUT was connected to Spectrum Analyzer and Base Station via power divider.
2. The 99% occupied bandwidth of middle channel for the highest and lowest RF powers were measured.
3. The bandedge of low and high channels for the highest RF powers within the transmitting frequency band were measured. Setting RBW as roughly $BW/100$.

4.4.3 Test Setup Layout

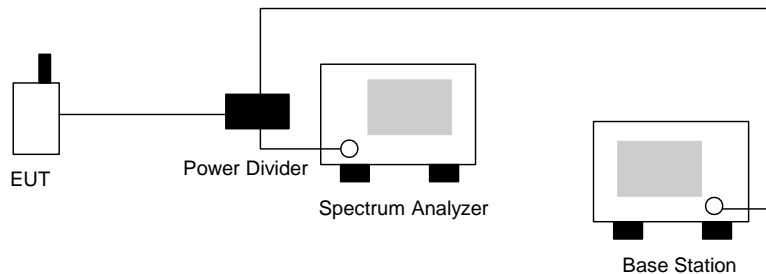



- Test Mode : GSM850 (GSM) CH189 99% Occupied Bandwidth
- Power State : High

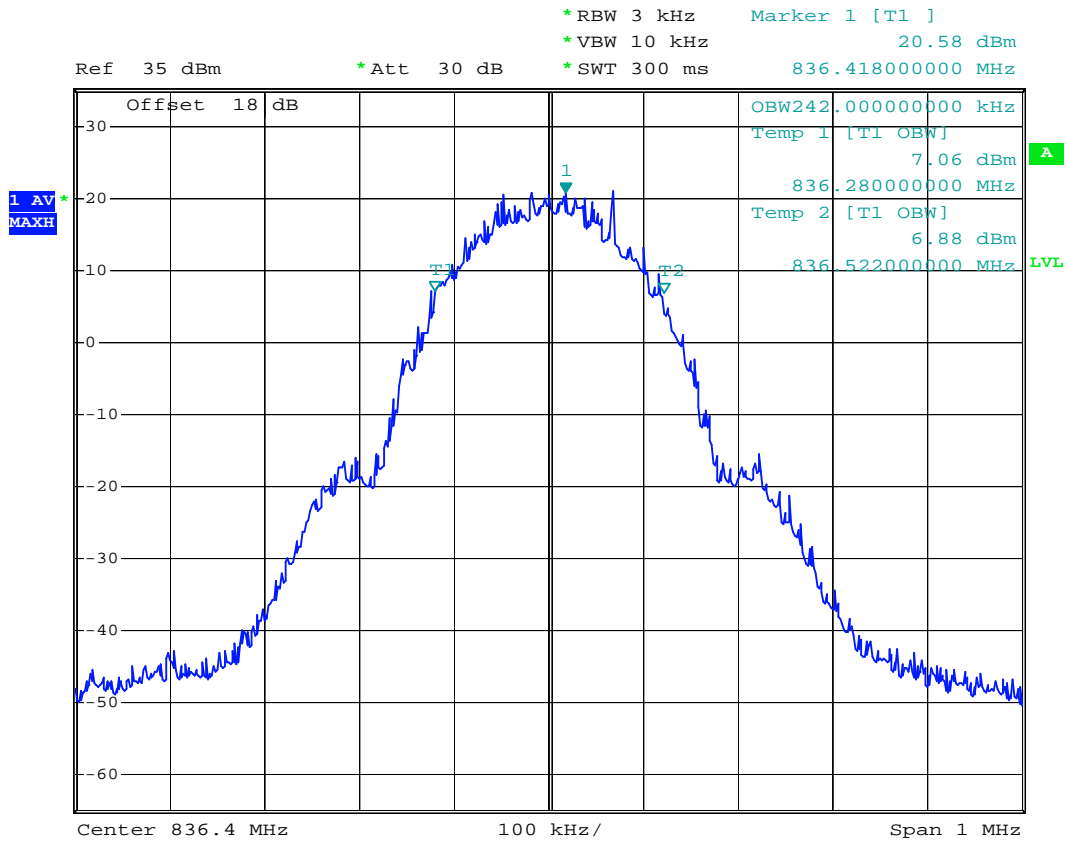

Date: 15.JUL.2007 18:10:03



- Test Mode : GSM850 (GSM) CH 251 99% Occupied Bandwidth
- Power State : High

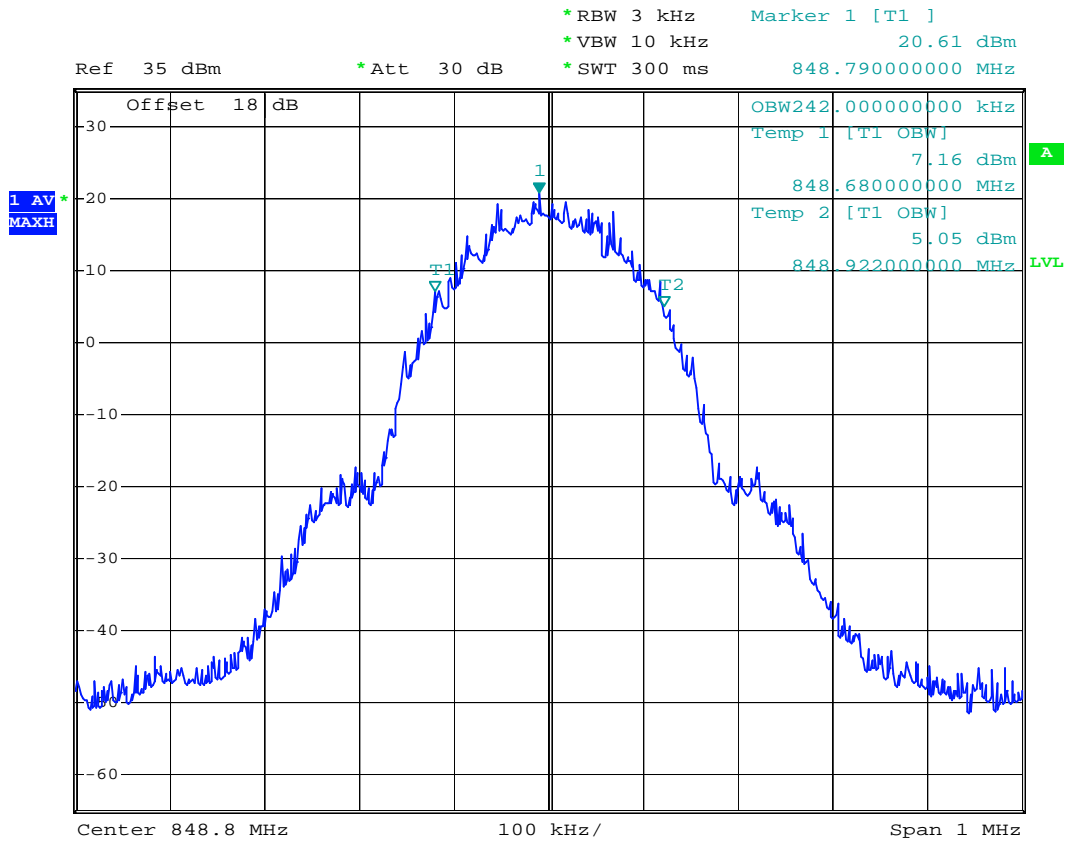

Date: 15.JUL.2007 18:11:48



- Test Mode : GSM850 (GSM) CH128 26dB Bandwidth
- Power State : High

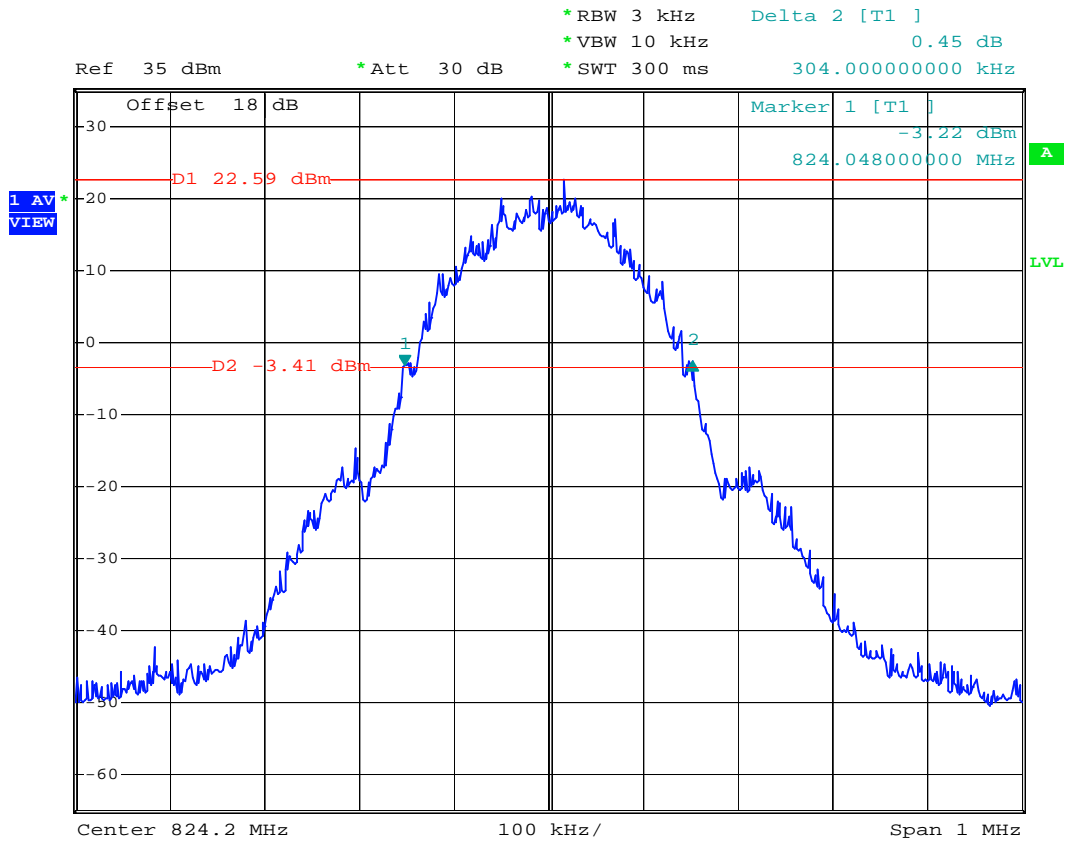

Date: 15.JUL.2007 14:18:55



- Test Mode : GSM850 (GSM) CH189 26dB Bandwidth
- Power State : High

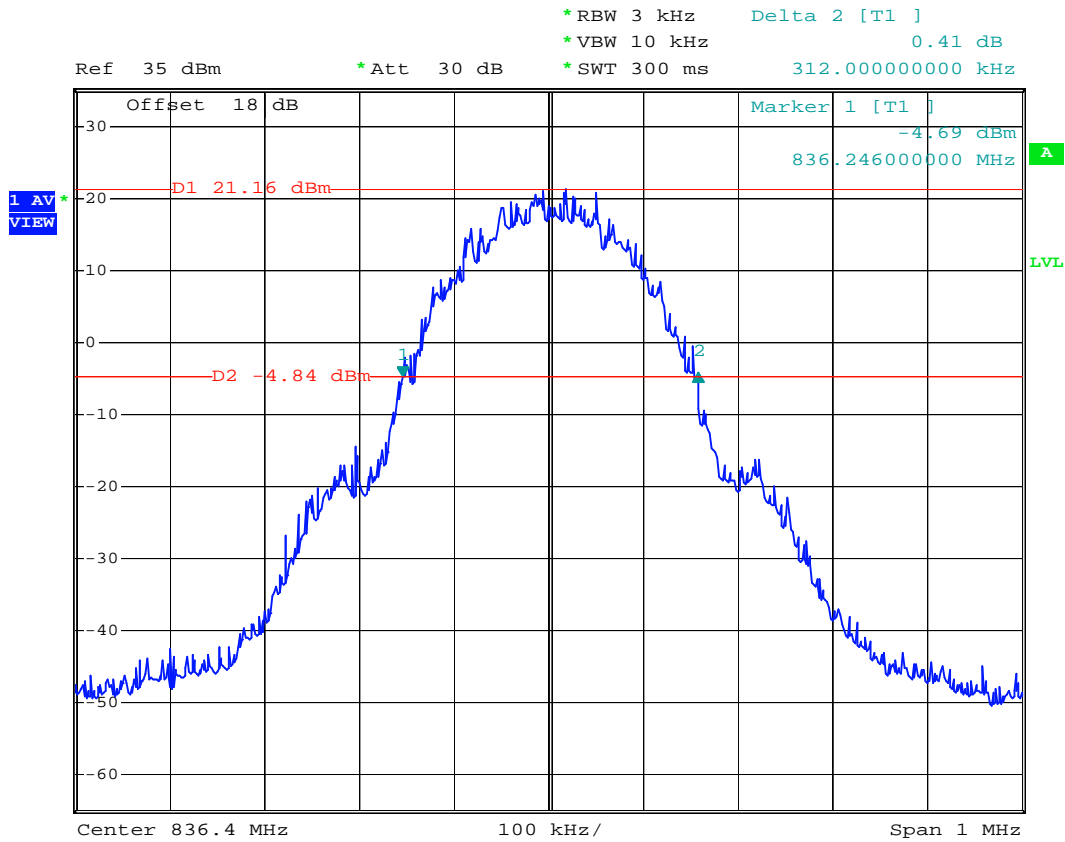

Date: 15.JUL.2007 14:21:00



- Test Mode : GSM850 (GSM) CH 251 26dB Bandwidth
- Power State : High

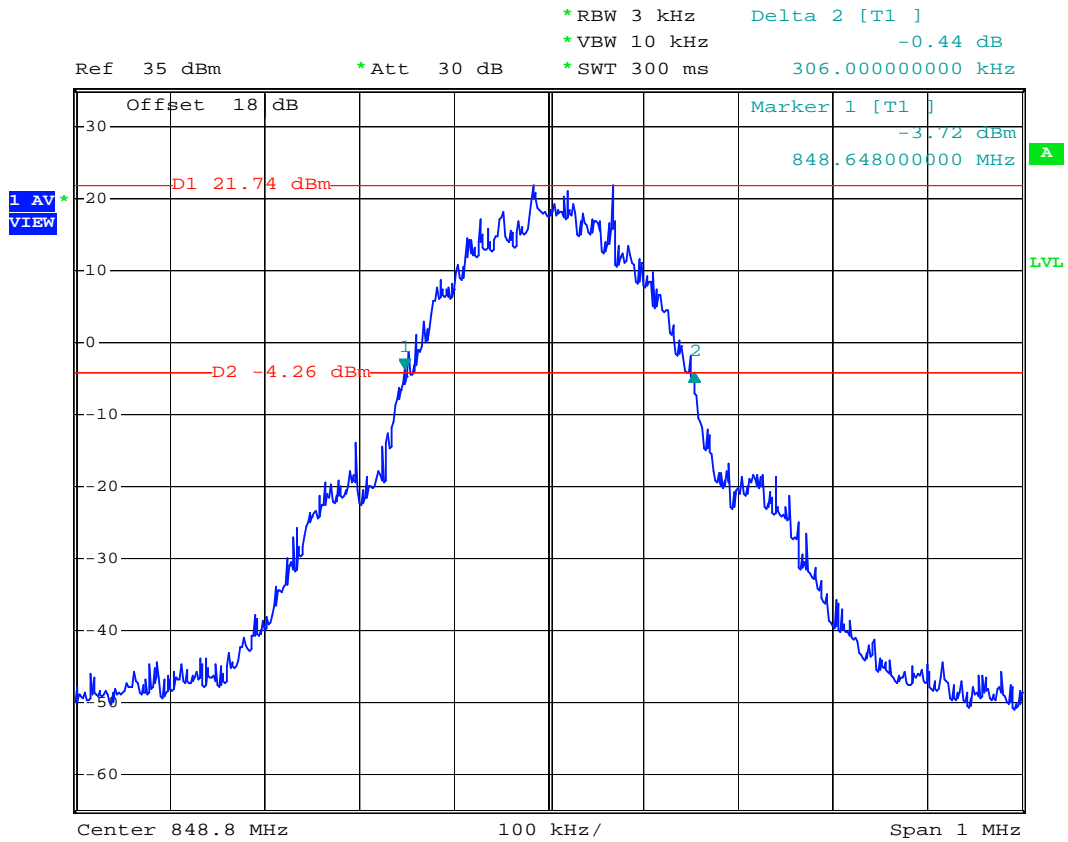

Date: 15.JUL.2007 14:23:11



- Test Mode : GSM850 (GSM) CH251 Higher Band Edge
- Power State : High

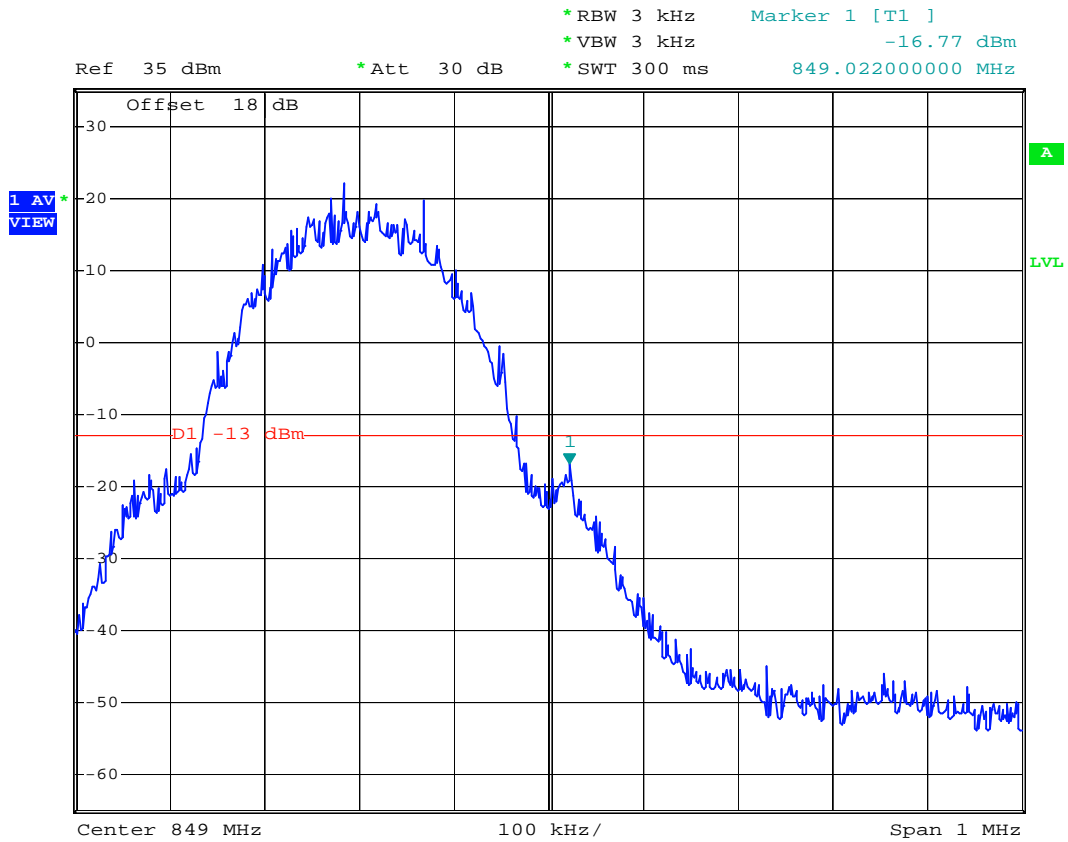

Date: 15.JUL.2007 14:27:22



- Mode 2
- Test Mode : GSM850 (EDGE) CH128 Lower Band Edge
- Power State : High

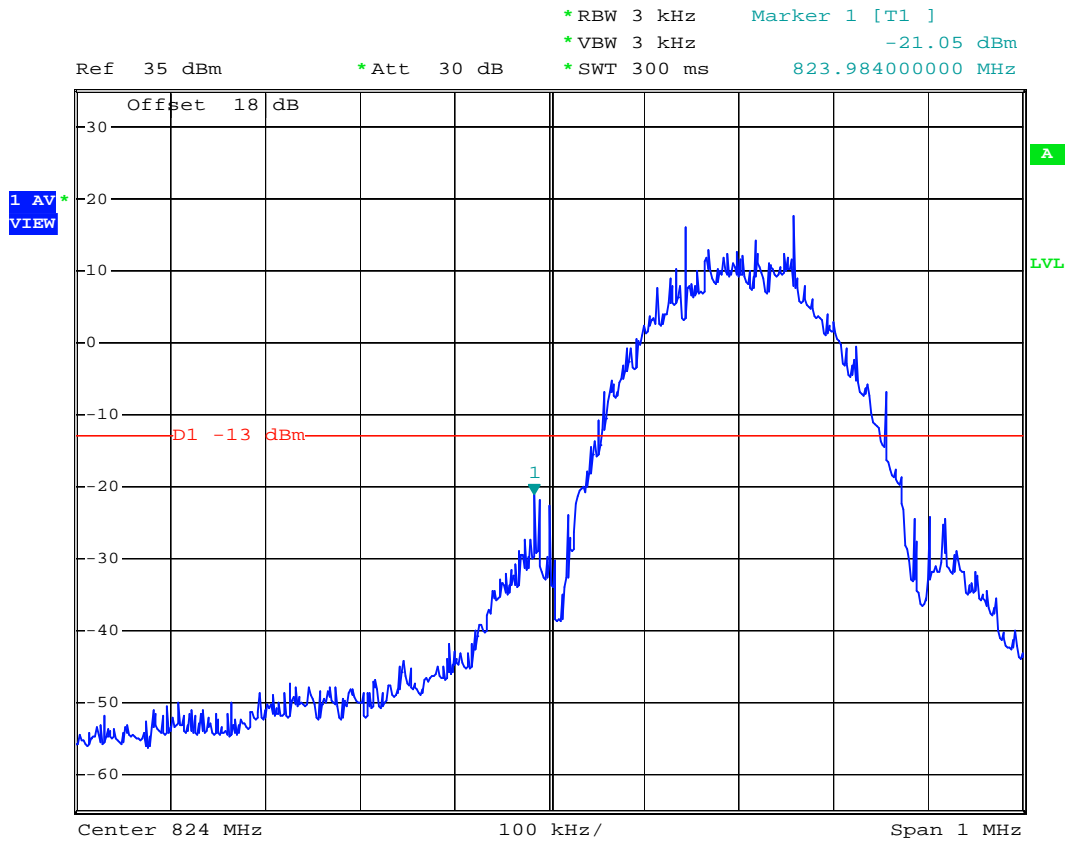

Date: 15.JUL.2007 14:45:42



Test Mode : GSM850 (EDGE) CH128 99% Occupied Bandwidth

- Power State : High

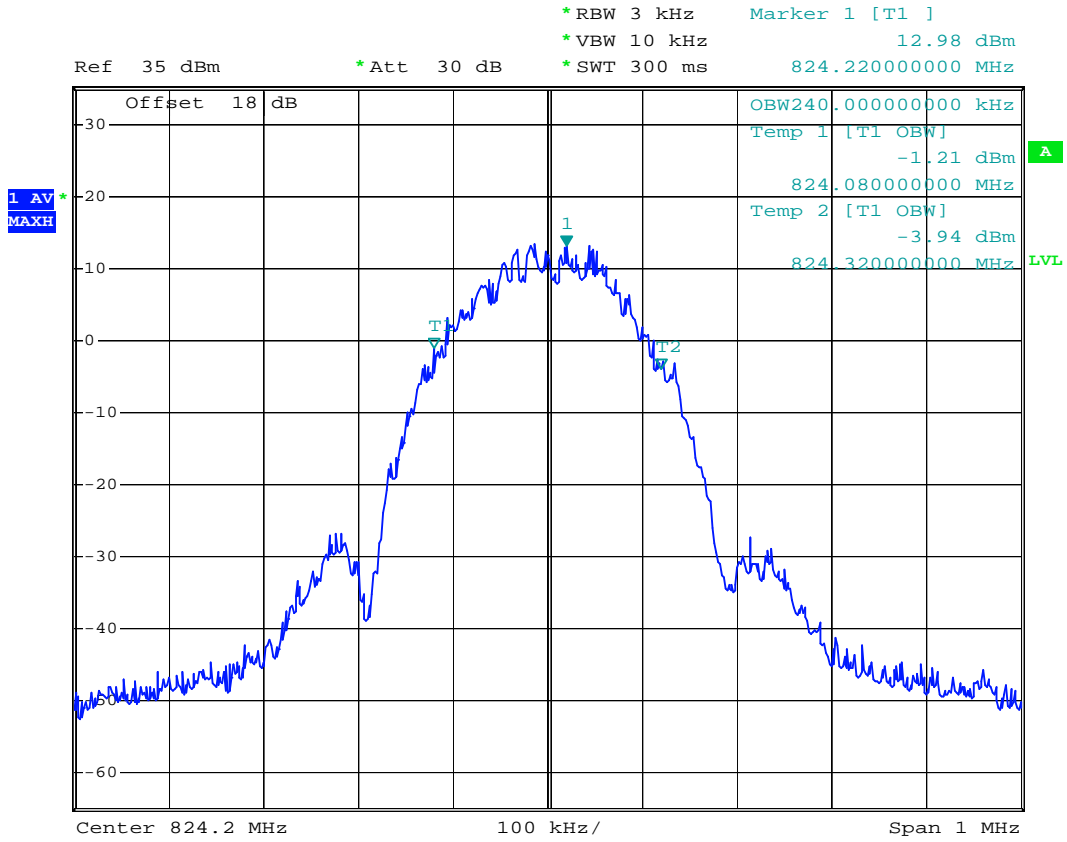

Date: 15.JUL.2007 18:14:54



FCC TEST REPORT

Report No. : FG762206-B

- Test Mode : GSM850 (EDGE) CH189 99% Occupied Bandwidth
- Power State : High

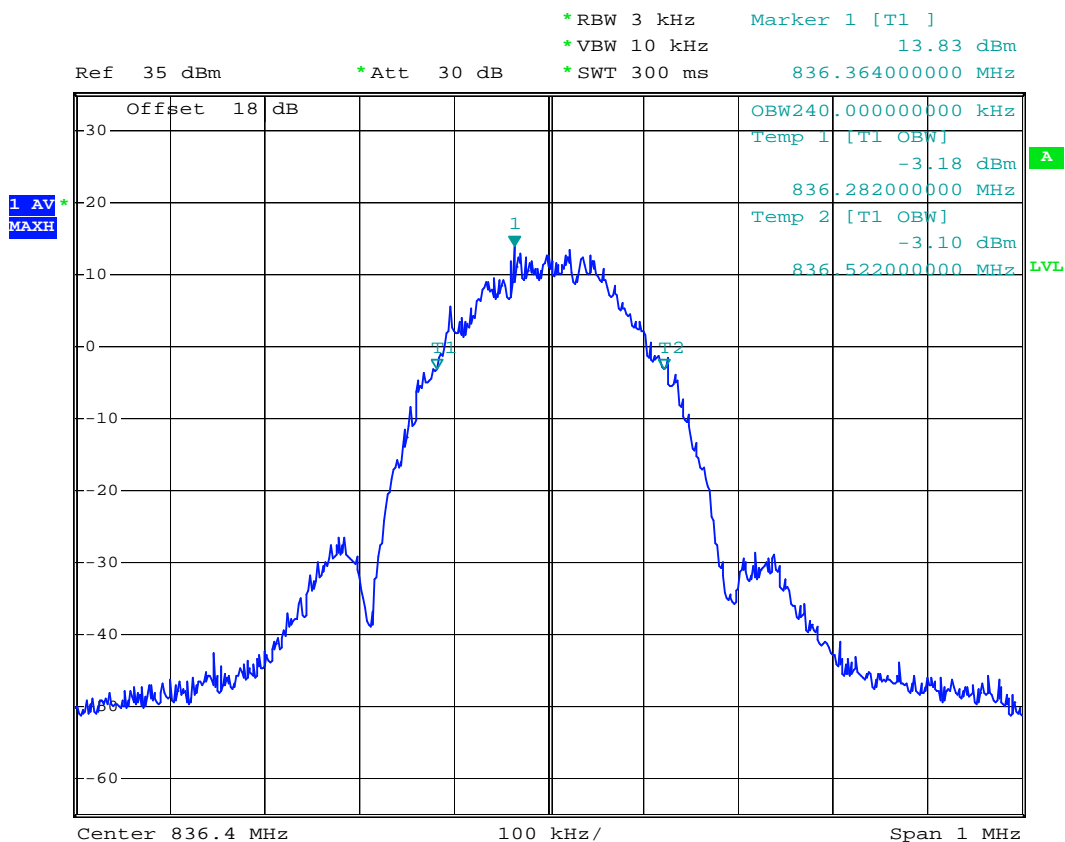

Date: 15.JUL.2007 18:14:14



- Test Mode : GSM850 (EDGE) CH 251 99% Occupied Bandwidth
- Power State : High

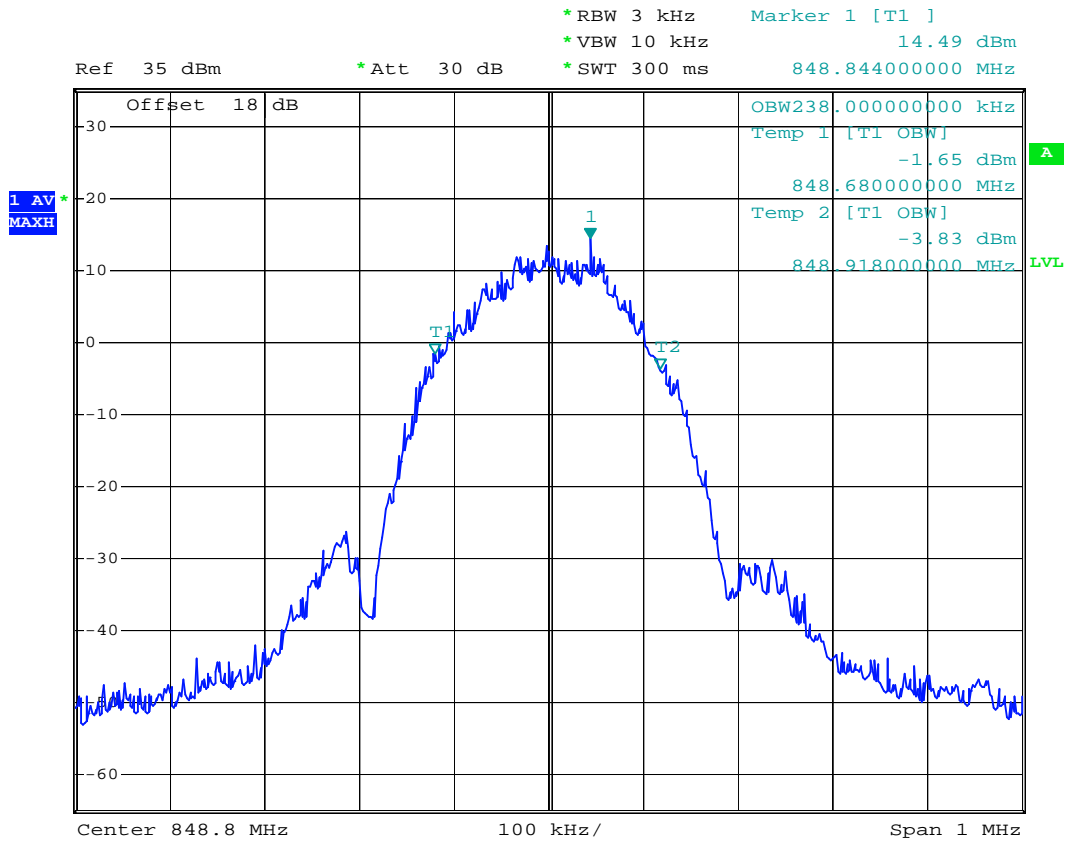

Date: 15.JUL.2007 18:13:10



- Test Mode : GSM850 (EDGE) CH128 26dB Bandwidth
- Power State : High

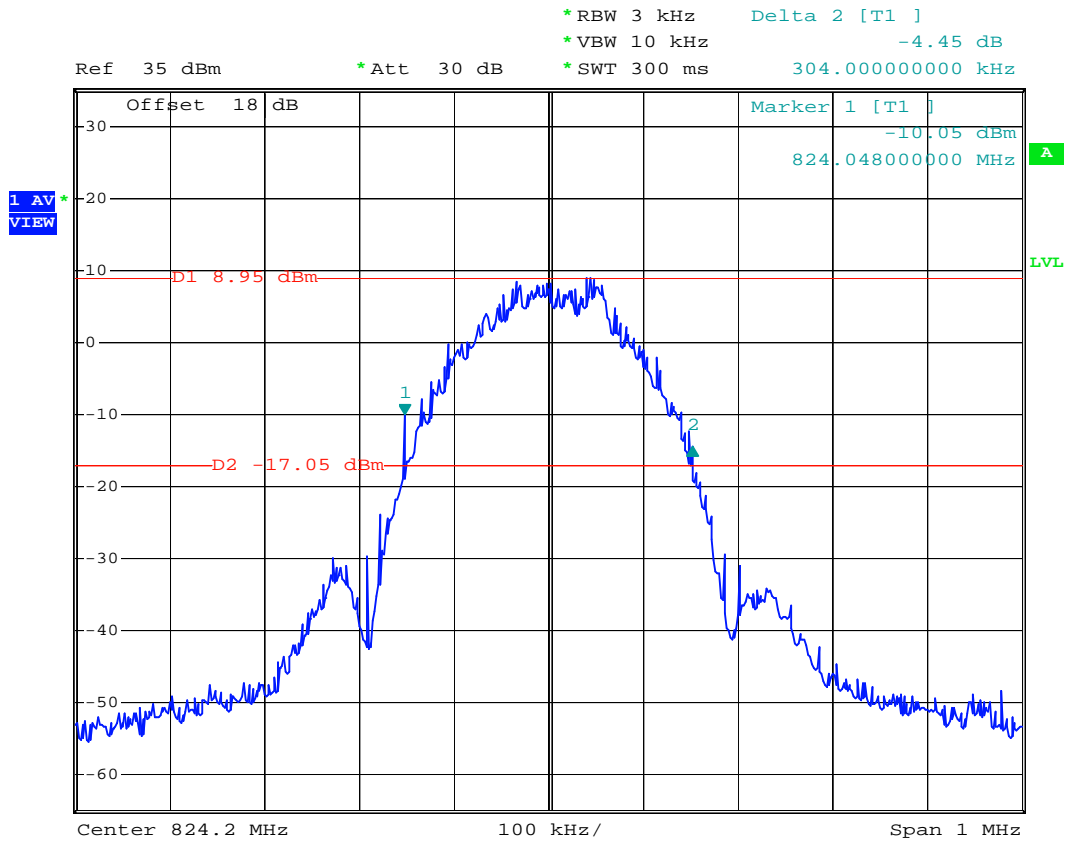

Date: 15.JUL.2007 15:03:36



- Test Mode : GSM850 (EDGE) CH189 26dB Bandwidth
- Power State : High

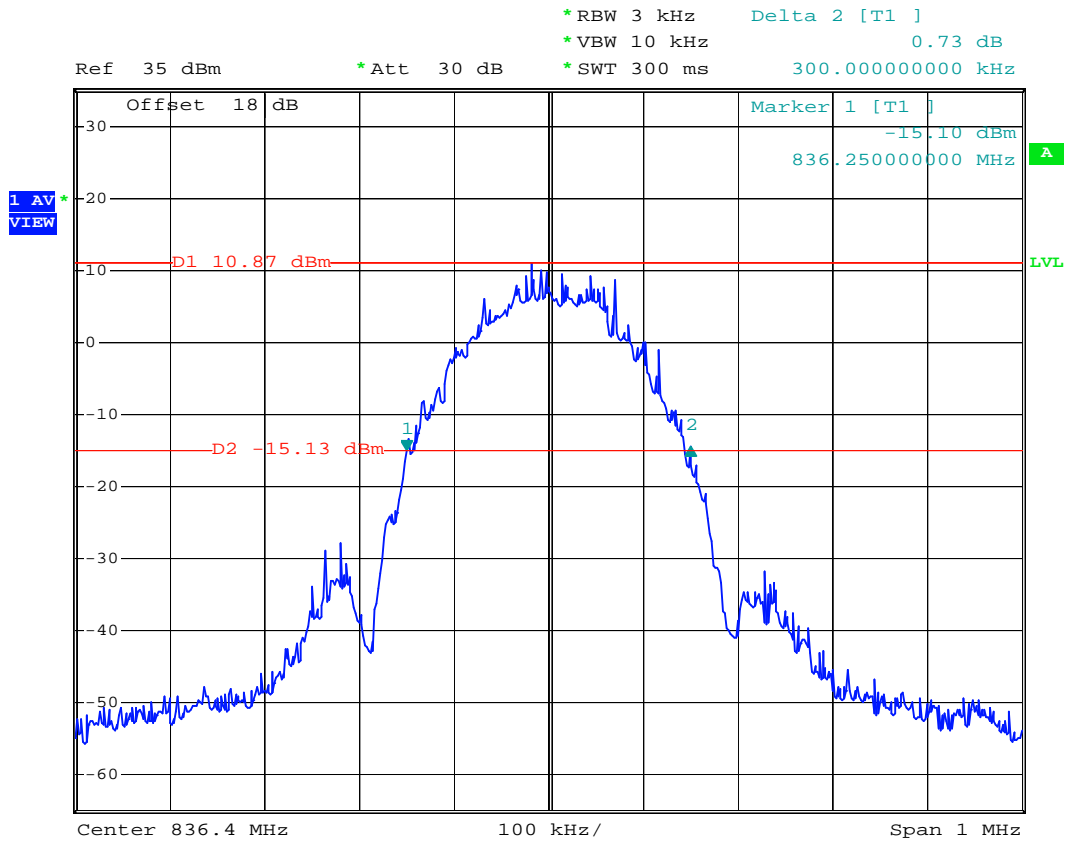

Date: 15.JUL.2007 15:01:32



- Test Mode : GSM850 (EDGE) CH 251 26dB Bandwidth
- Power State : High

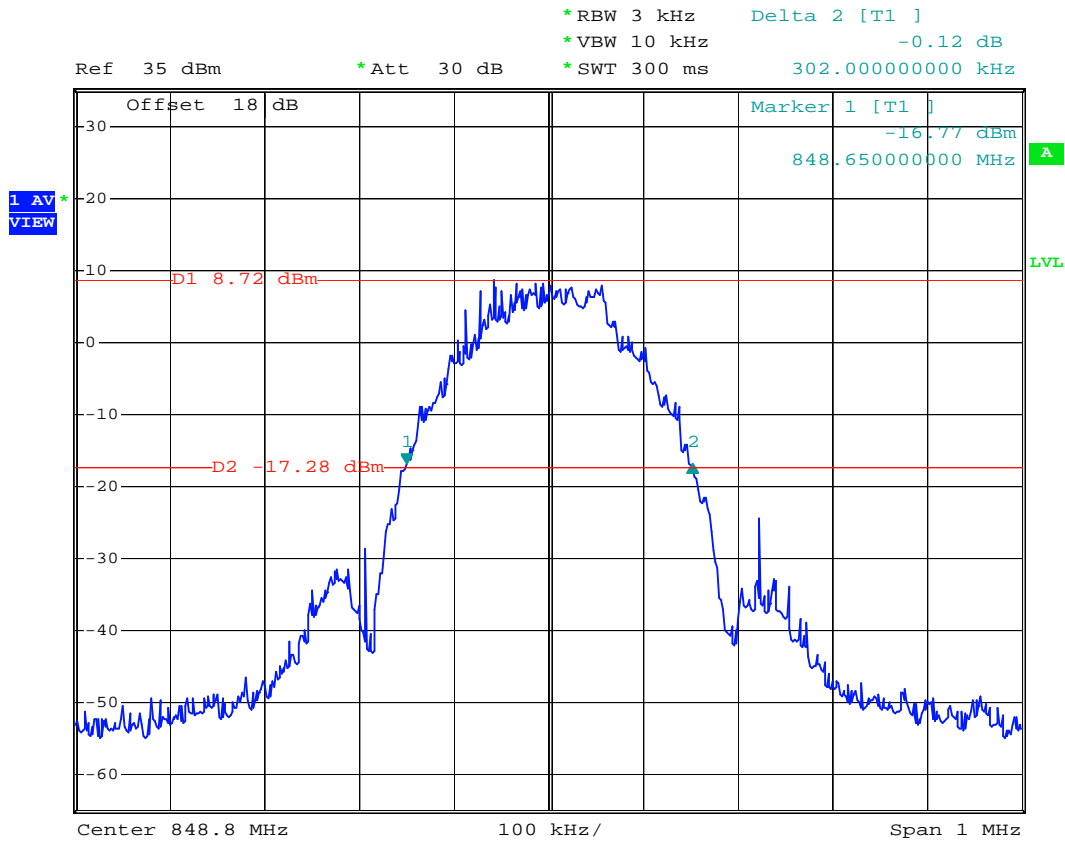

Date: 15.JUL.2007 15:00:10



- Test Mode : GSM850 (EDGE) CH251 Higher Band Edge
- Power State : High



Date: 15.JUL.2007 14:44:57



- Mode 3
- Test Mode : PCS1900 (GSM) CH512 Lower Band Edge
- Power State : High

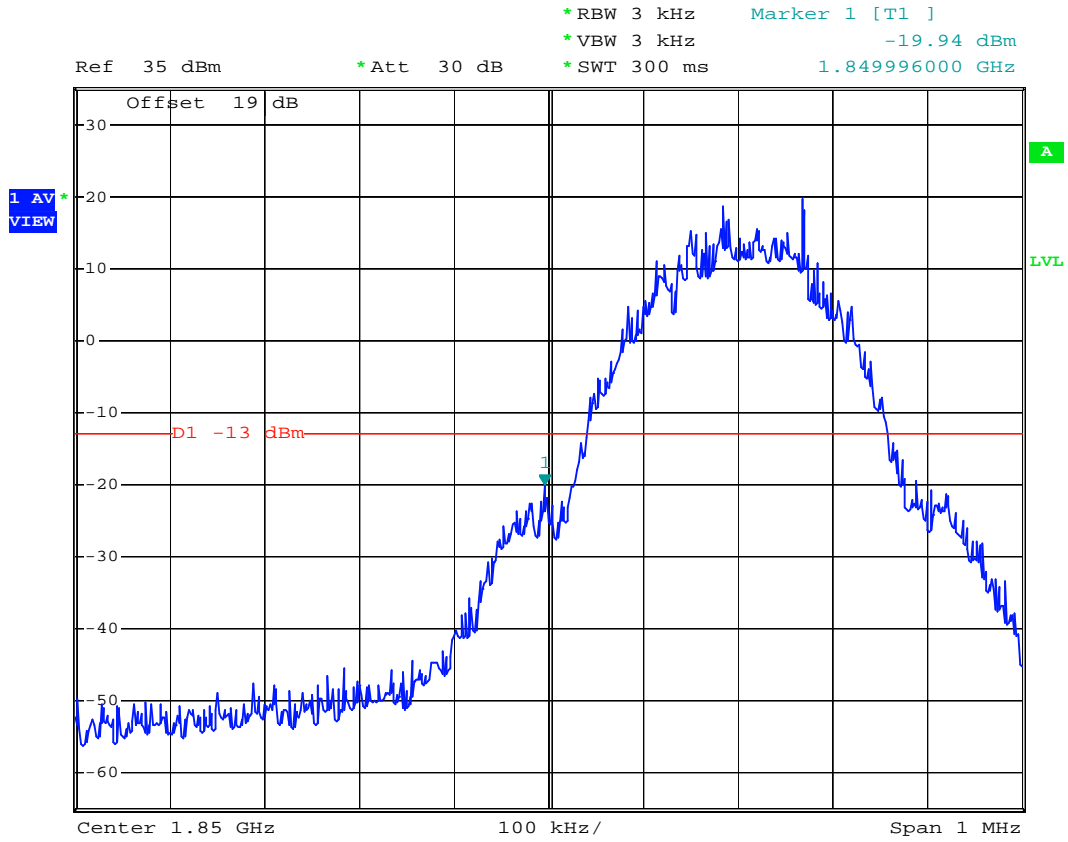

Date: 15.JUL.2007 17:33:14



- Test Mode : PCS1900 (GSM) CH512 99% Occupied Bandwidth
- Power State : High

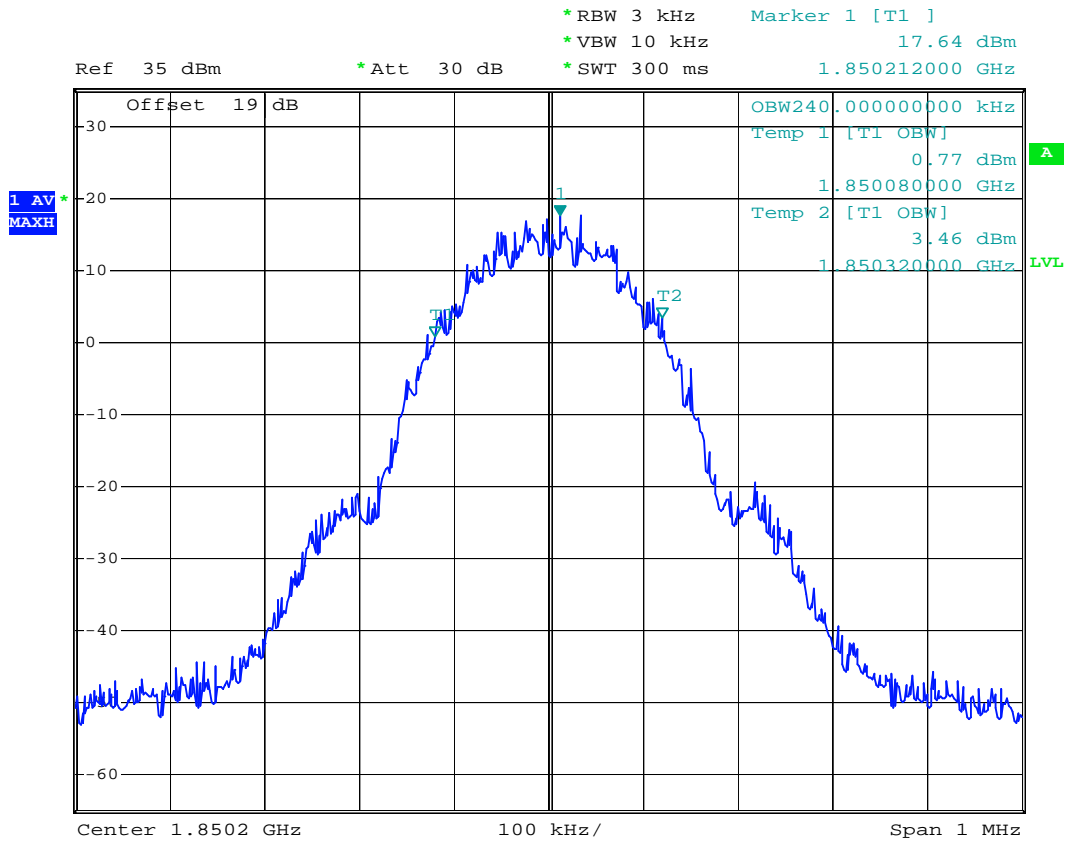

Date: 15.JUL.2007 17:35:34



- Test Mode : PCS1900 (GSM) CH661 99% Occupied Bandwidth
- Power State : High

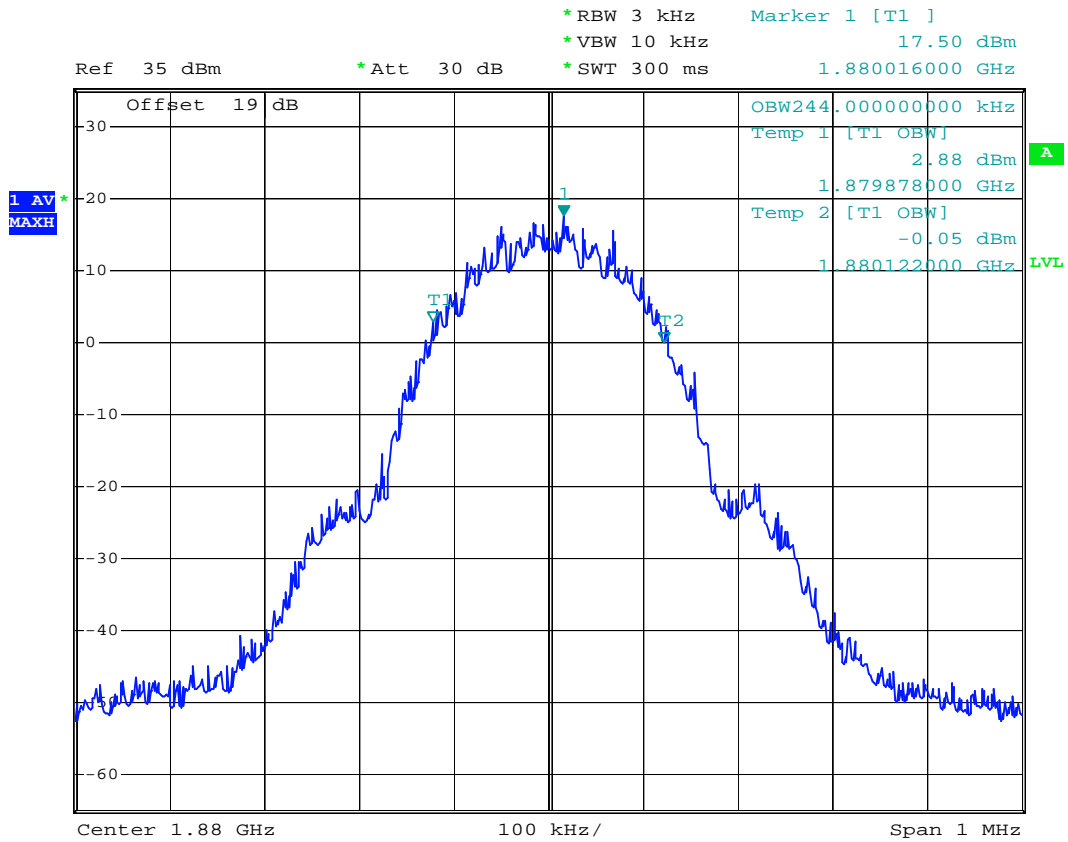

Date: 15.JUL.2007 17:36:40



- Test Mode : PCS1900 (GSM) CH810 99% Occupied Bandwidth
- Power State : High

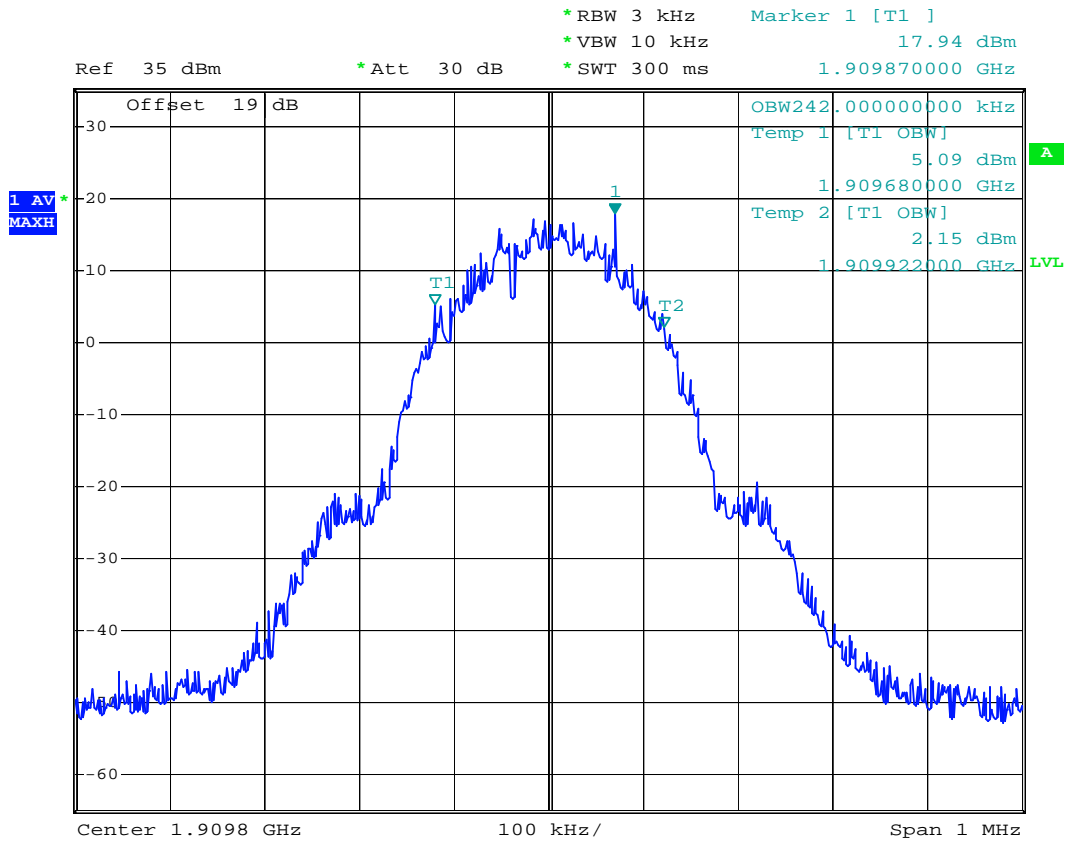

Date: 15.JUL.2007 17:38:24



- Test Mode : PCS1900 (GSM) CH512 26dB Bandwidth
- Power State : High

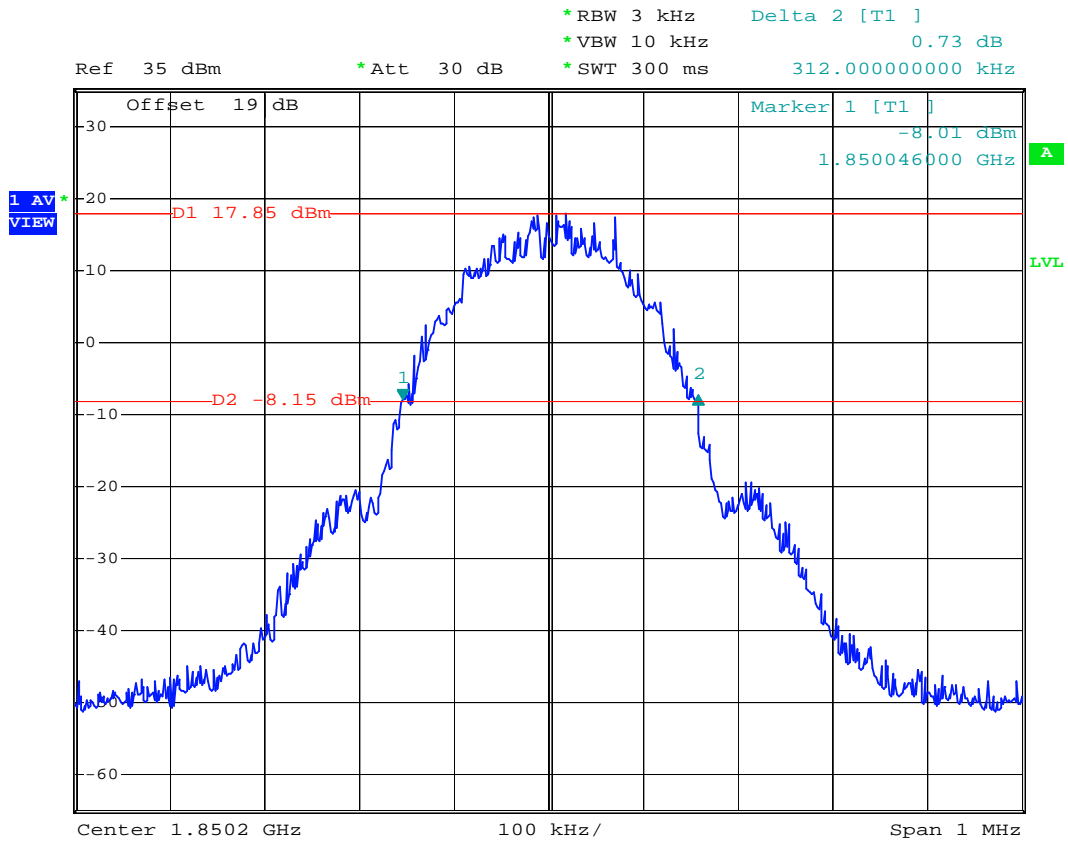

Date: 15.JUL.2007 17:48:00



- Test Mode : PCS1900 (GSM) CH661 26dB Bandwidth
- Power State : High

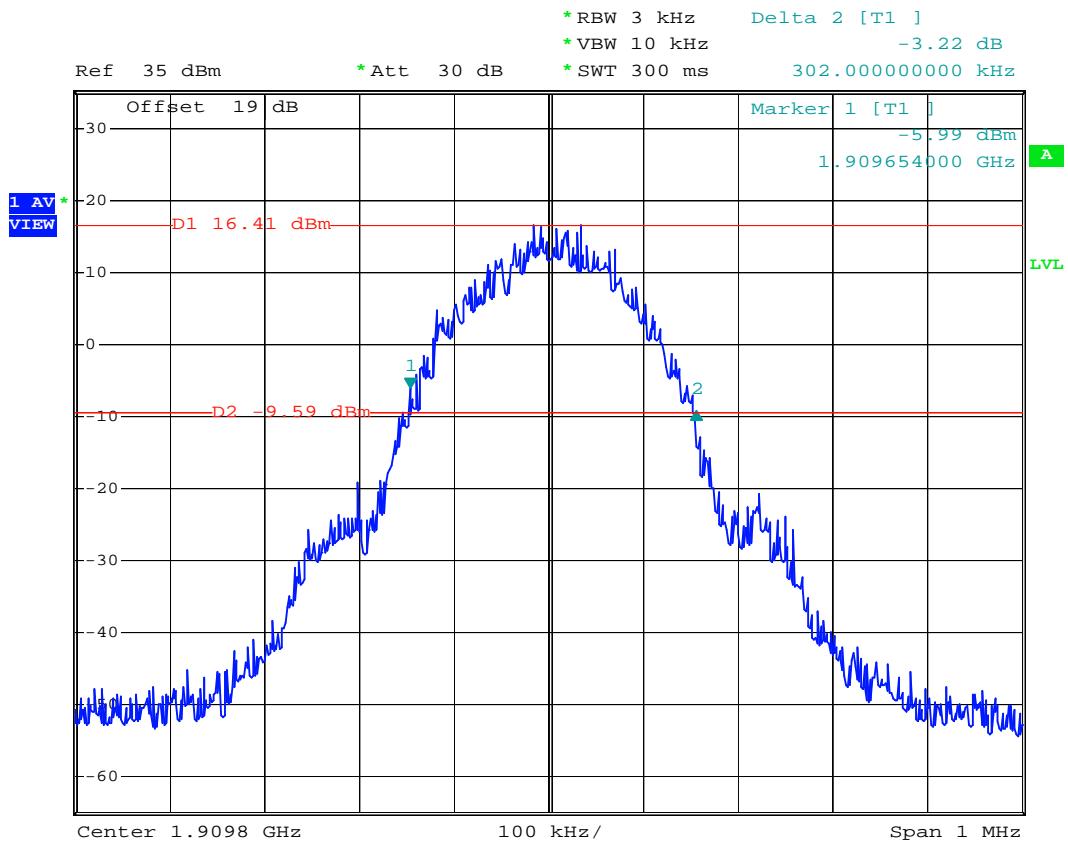

Date: 15.JUL.2007 17:46:25



- Test Mode : PCS1900 (GSM) CH810 26dB Bandwidth
- Power State : High

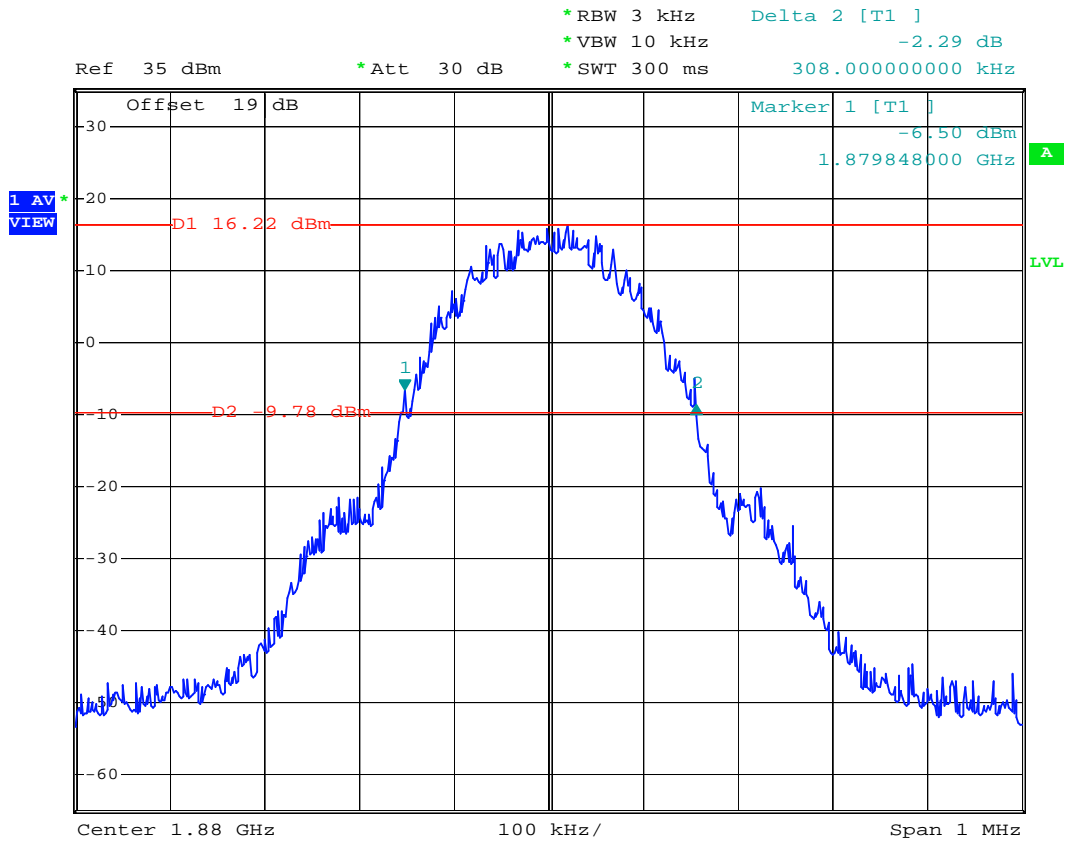

Date: 15.JUL.2007 17:41:30



- Test Mode : PCS1900 (GSM) CH810 Higher Band Edge
- Power State : High

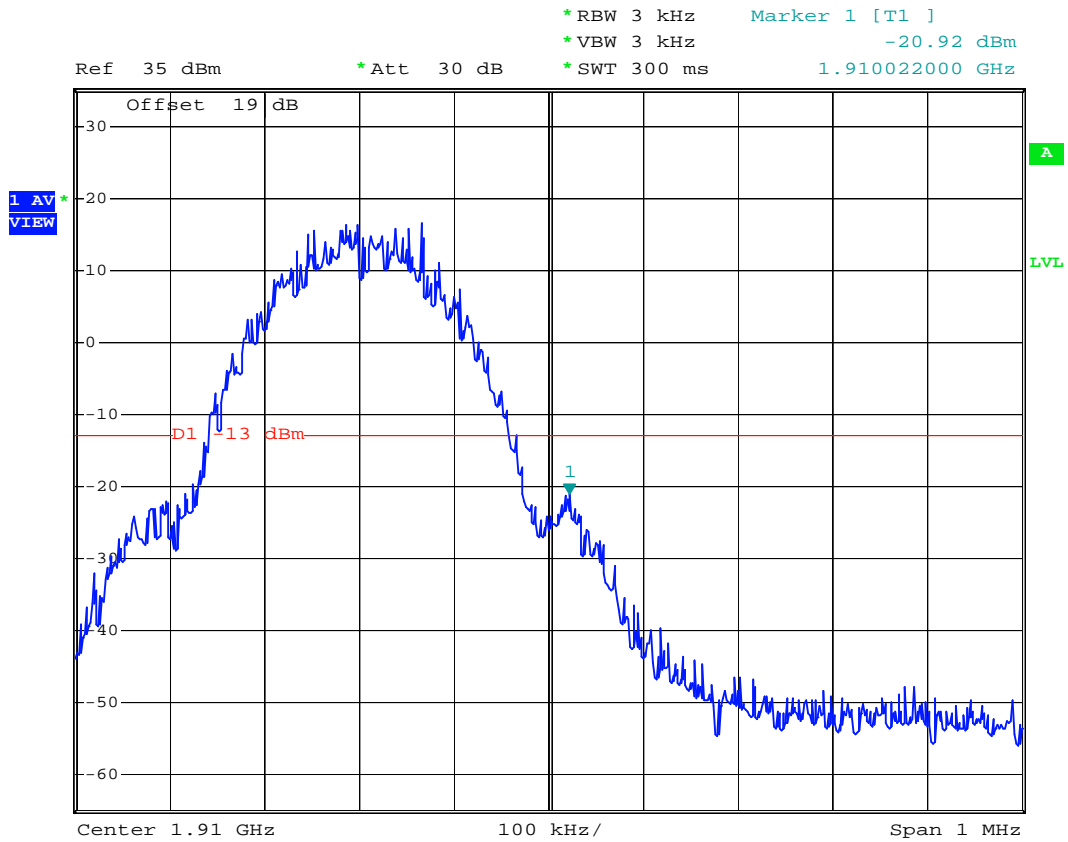

Date: 15.JUL.2007 17:33:46



- Mode 4
- Test Mode : PCS1900 (EDGE) CH512 Lower Band Edge
- Power State : High

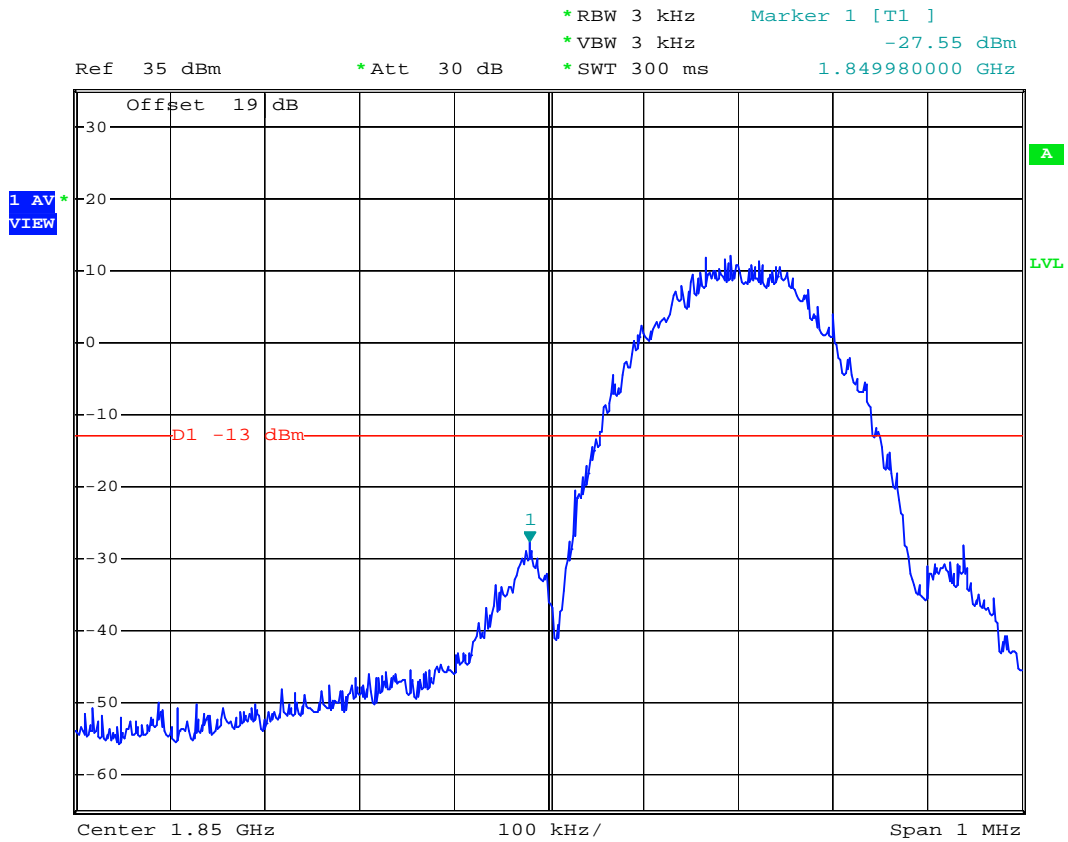

Date: 15.JUL.2007 17:13:57



- Test Mode : PCS1900 (EDGE) CH512 99% Occupied Bandwidth
- Power State : High

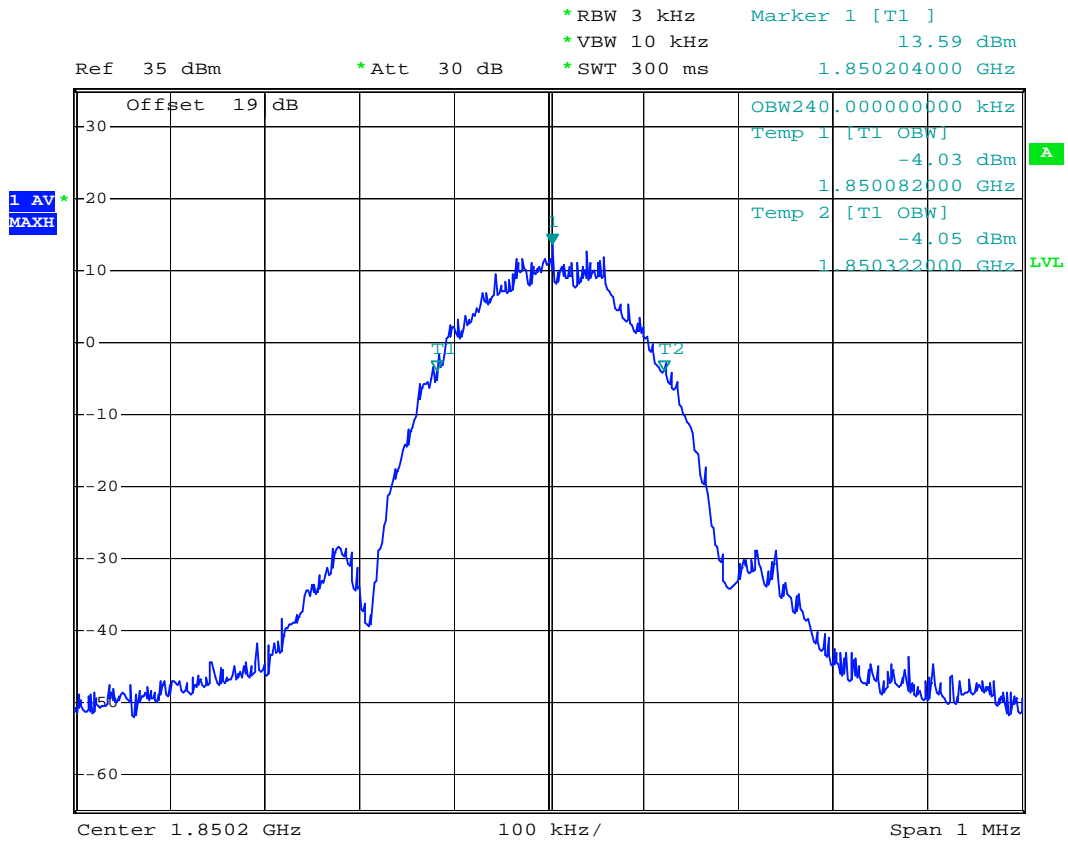

Date: 15.JUL.2007 16:53:50



- Test Mode : PCS1900 (EDGE) CH661 99% Occupied Bandwidth
- Power State : High

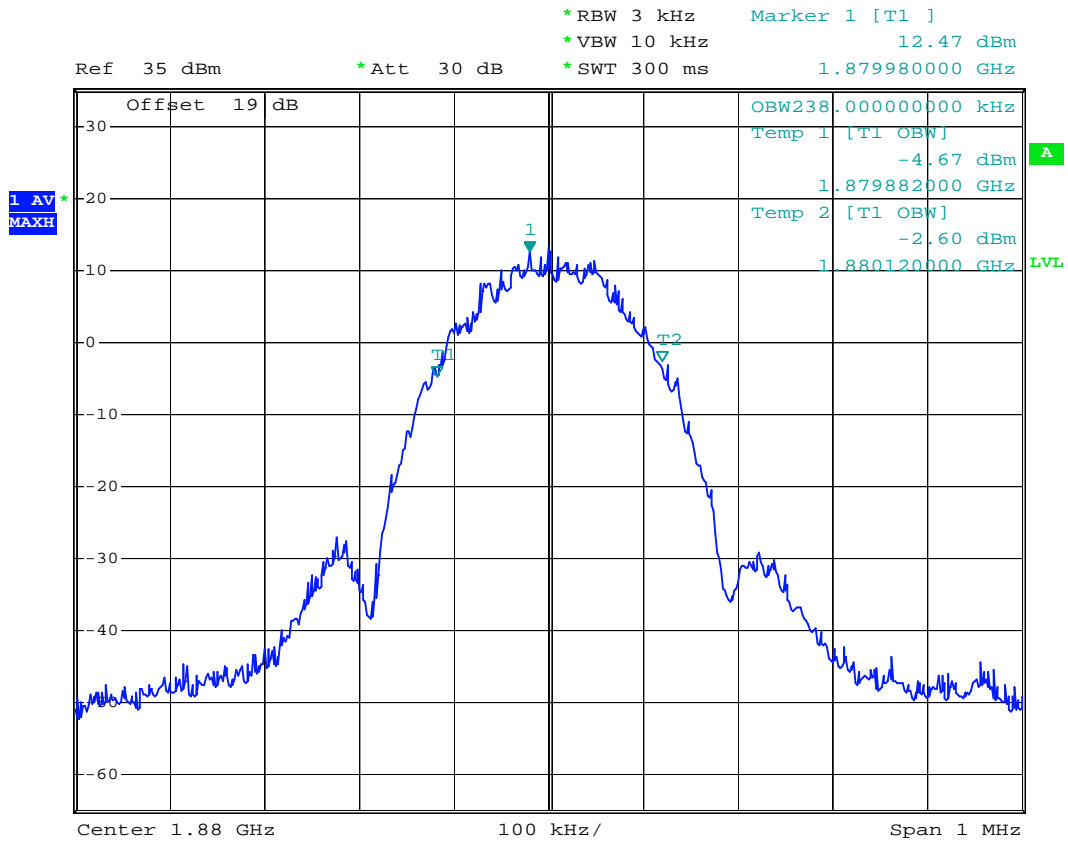

Date: 15.JUL.2007 16:52:44



- Test Mode : PCS1900 (EDGE) CH810 99% Occupied Bandwidth
- Power State : High

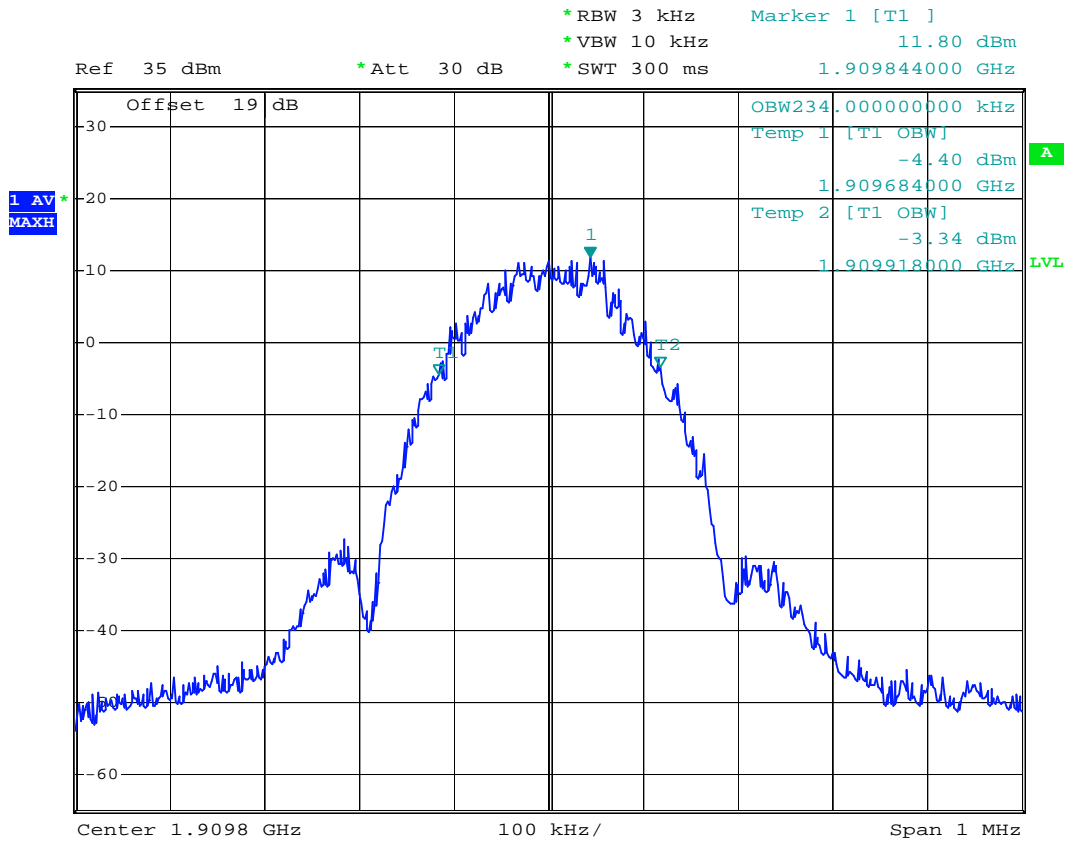

Date: 15.JUL.2007 16:54:45



- Test Mode : PCS1900 (EDGE) CH512 26dB Bandwidth
- Power State : High

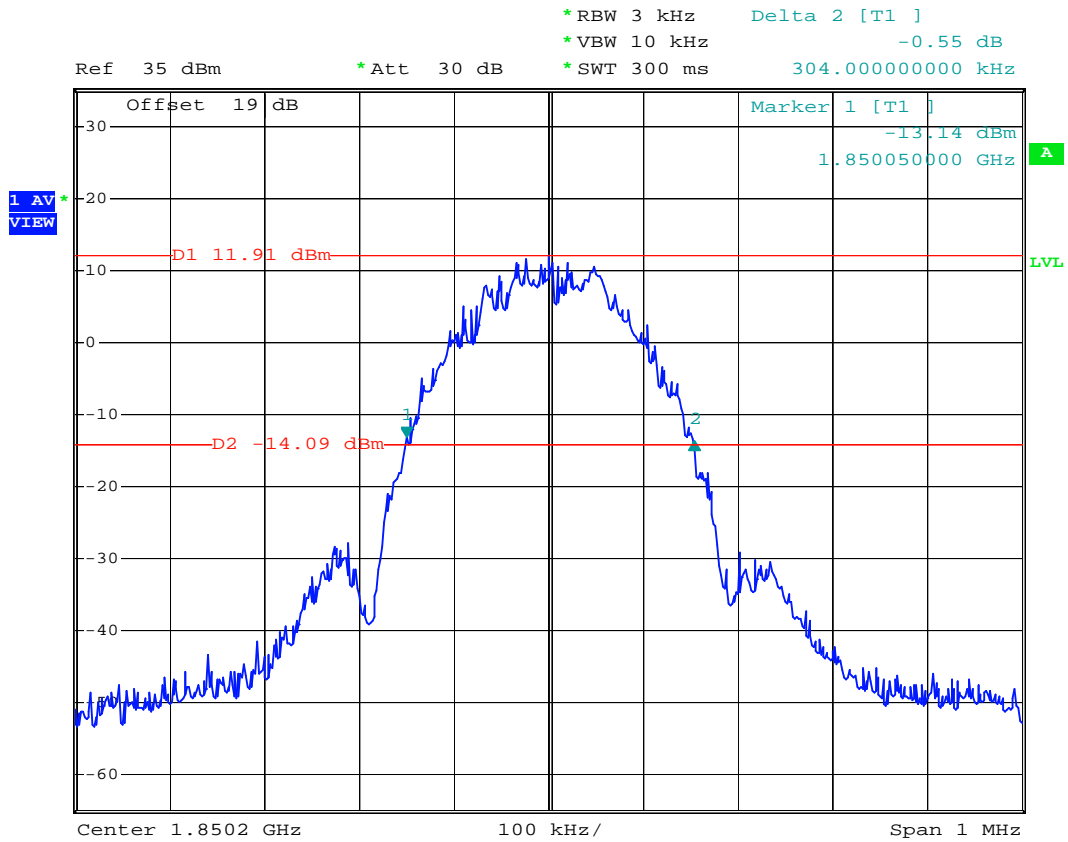

Date: 15.JUL.2007 17:11:17



- Test Mode : PCS1900 (EDGE) CH661 26dB Bandwidth
- Power State : High

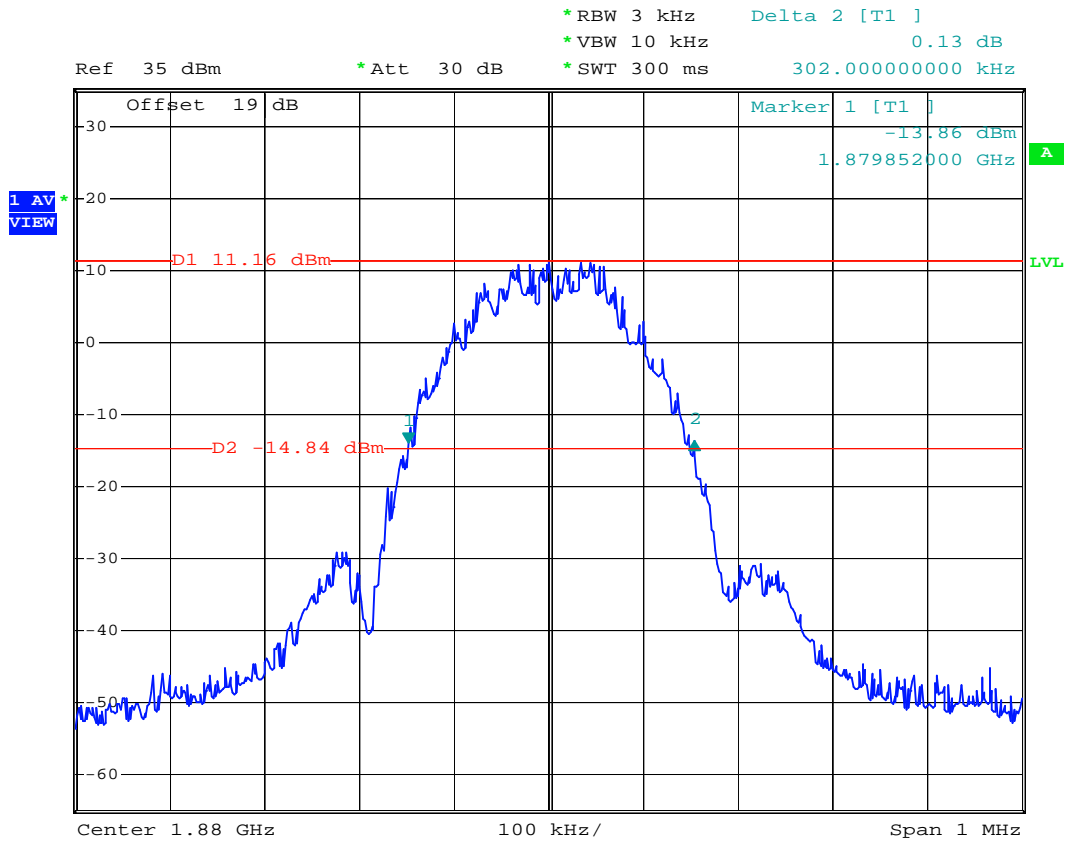

Date: 15.JUL.2007 17:12:14



- Test Mode : PCS1900 (EDGE) CH810 26dB Bandwidth
- Power State : High

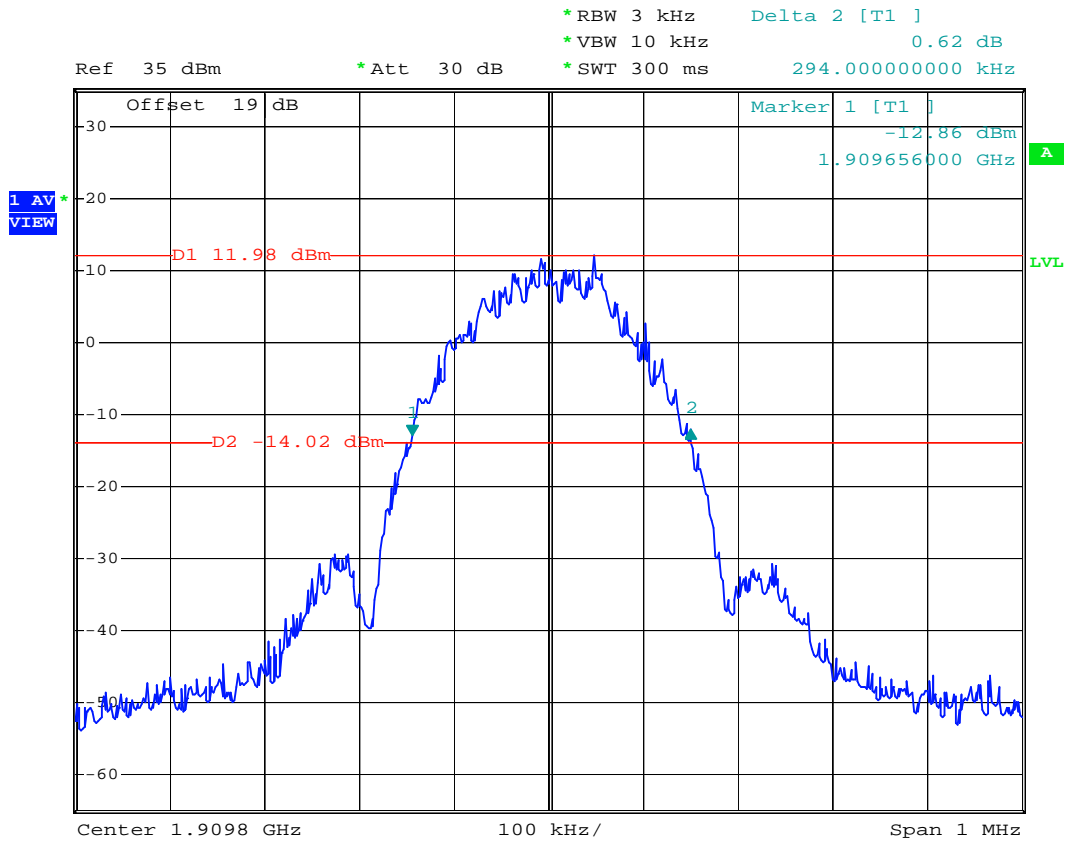

Date: 15.JUL.2007 17:10:05



- Test Mode : PCS1900(EDGE) CH810 Higher Band Edge
- Power State : High



Date: 15.JUL.2007 17:14:33

4.5 Conducted Emission

4.5.1 Measurement Instruments

As described in chapter 5 of this test report.

4.5.2 Test Procedure

1. The EUT was connected to Spectrum Analyzer and Base Station via power divider.
2. The middle channel for the highest RF power within the transmitting frequency was measured.
3. The conducted spurious emission for the whole frequency range was taken.

4.5.3 Test Setup Layout

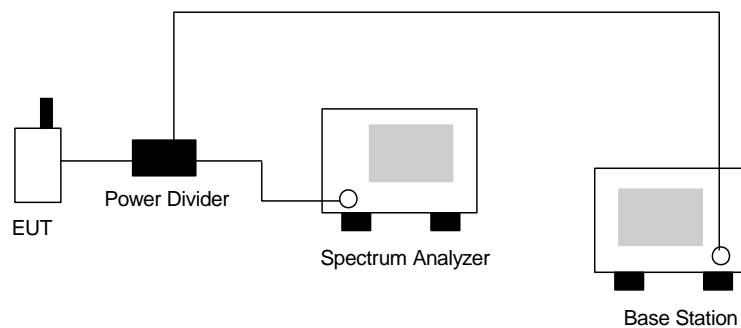



4.5.4 Test Result

- Mode 1
- Test Mode : GSM850 (GSM) CH189
- Frequency Range : 30M-1G

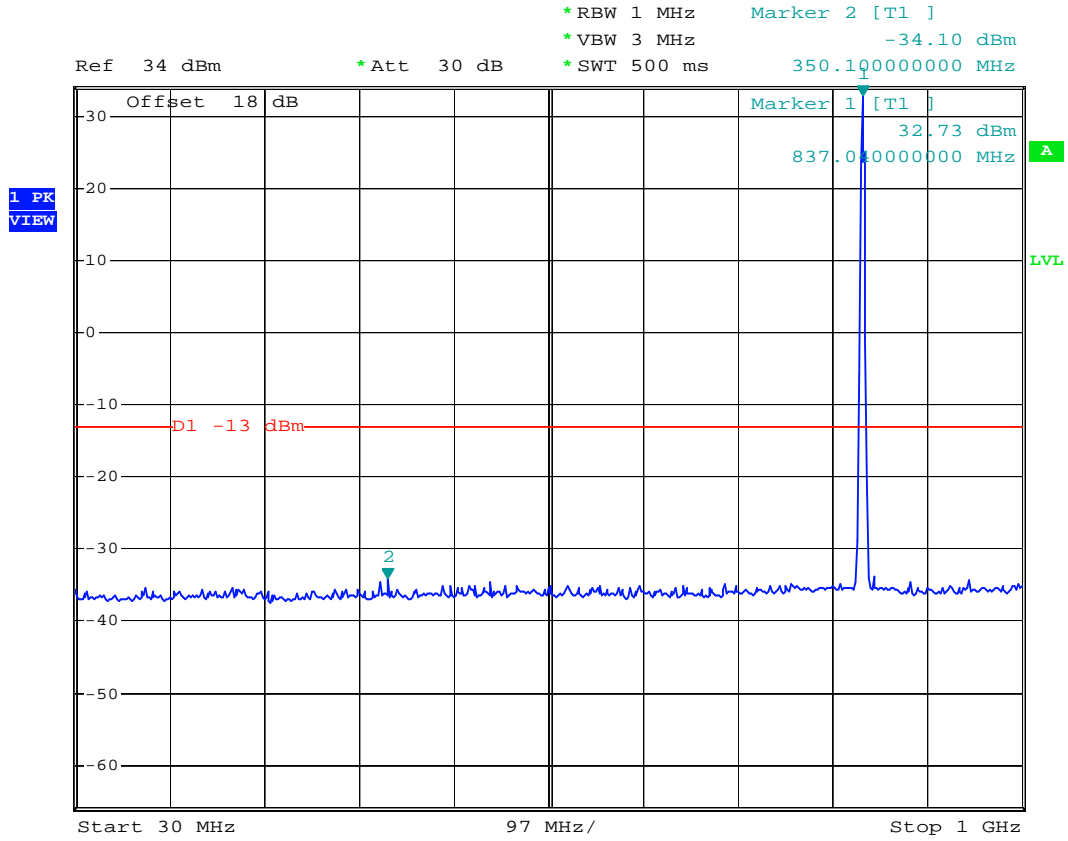

Date: 15.JUL.2007 16:04:45



- Test Mode : GSM850 (GSM) CH189
- Frequency Range : 1G-3G

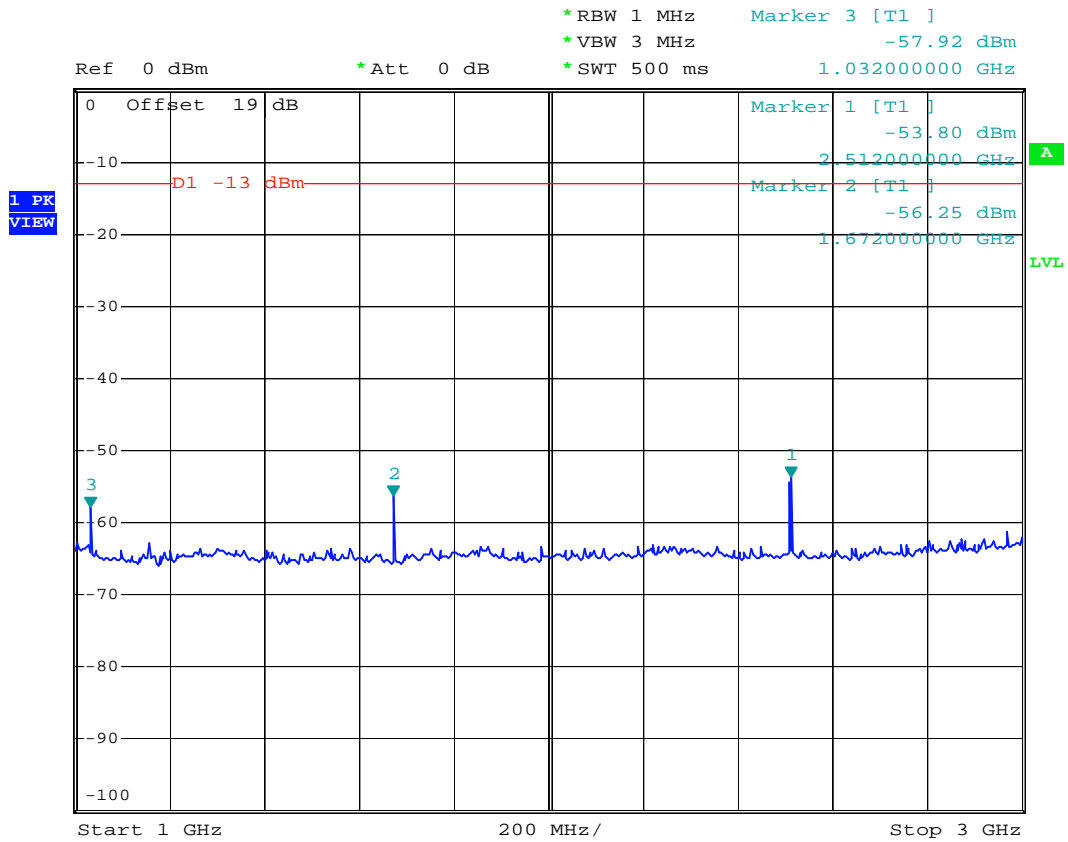

Date: 15.JUL.2007 16:03:26



- Test Mode : GSM850 (GSM) CH189
- Frequency Range : 3G-7G

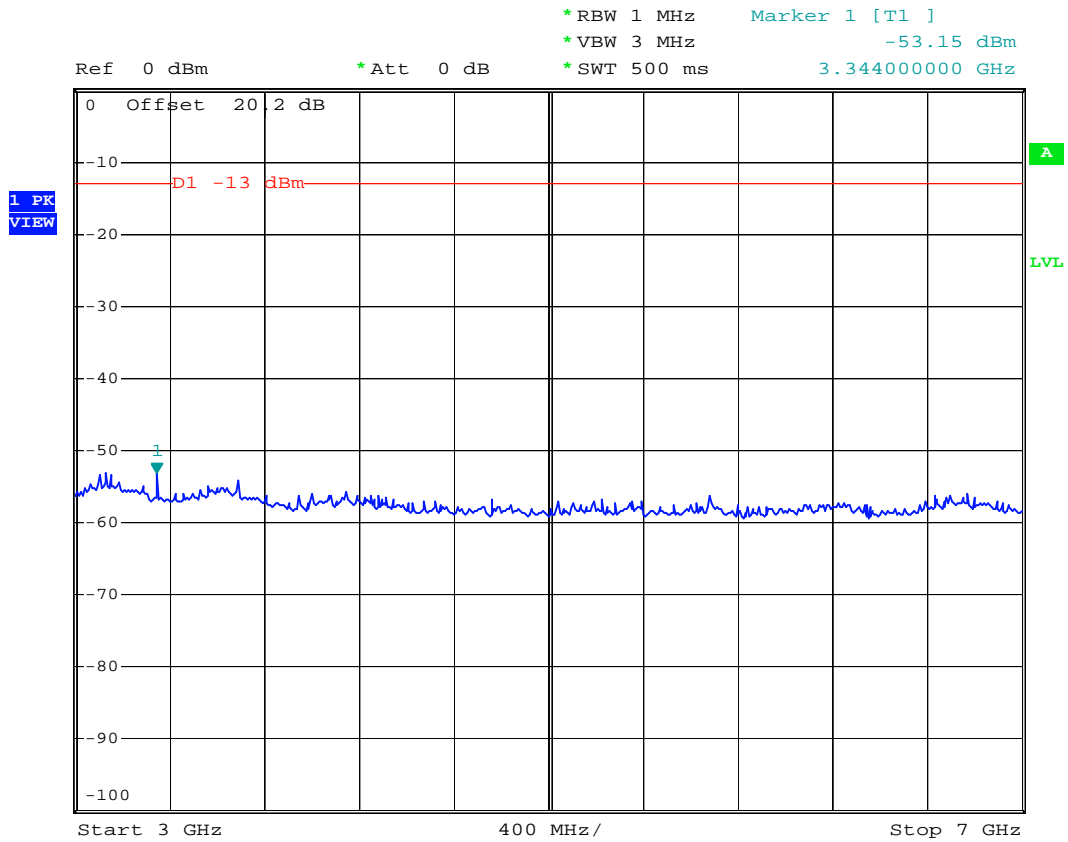

Date: 15.JUL.2007 16:02:46



- Test Mode : GSM850 (GSM) CH189
- Frequency Range : 7G-9G

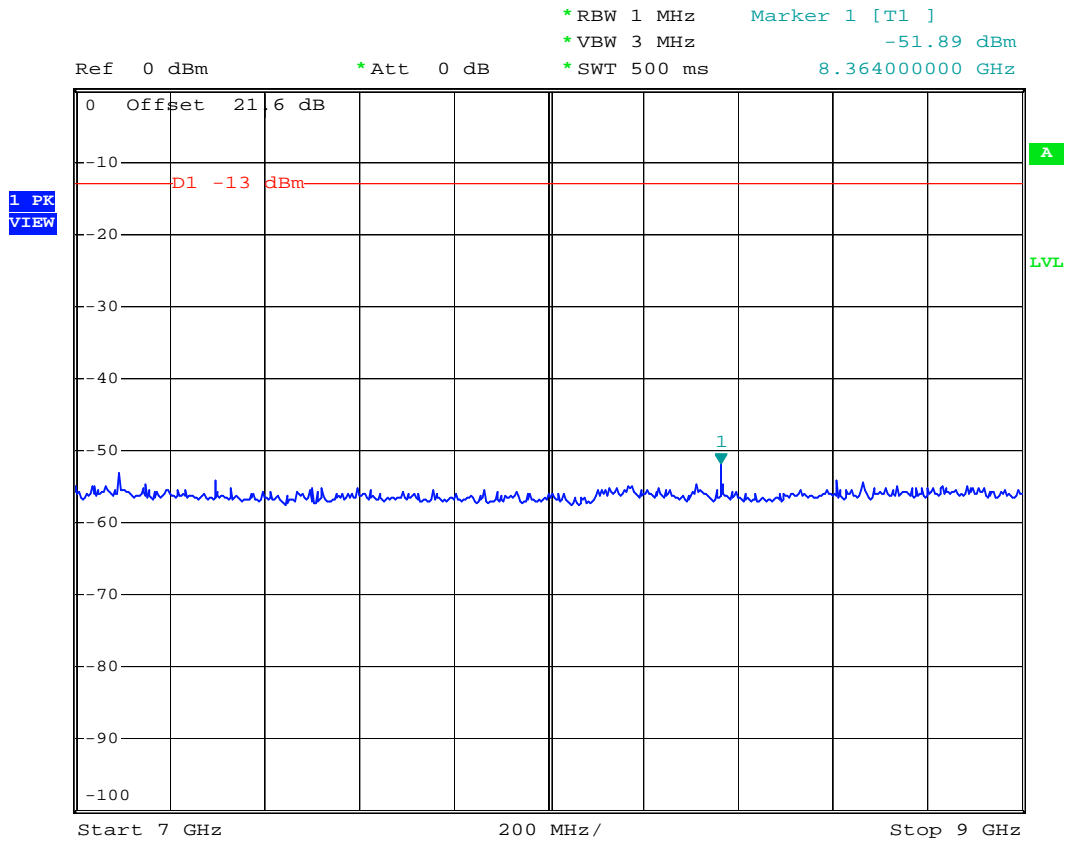

Date: 15.JUL.2007 16:02:18



- Mode 2
- Test Mode : GSM850 (EDGE) CH189
- Frequency Range : 30M-1G

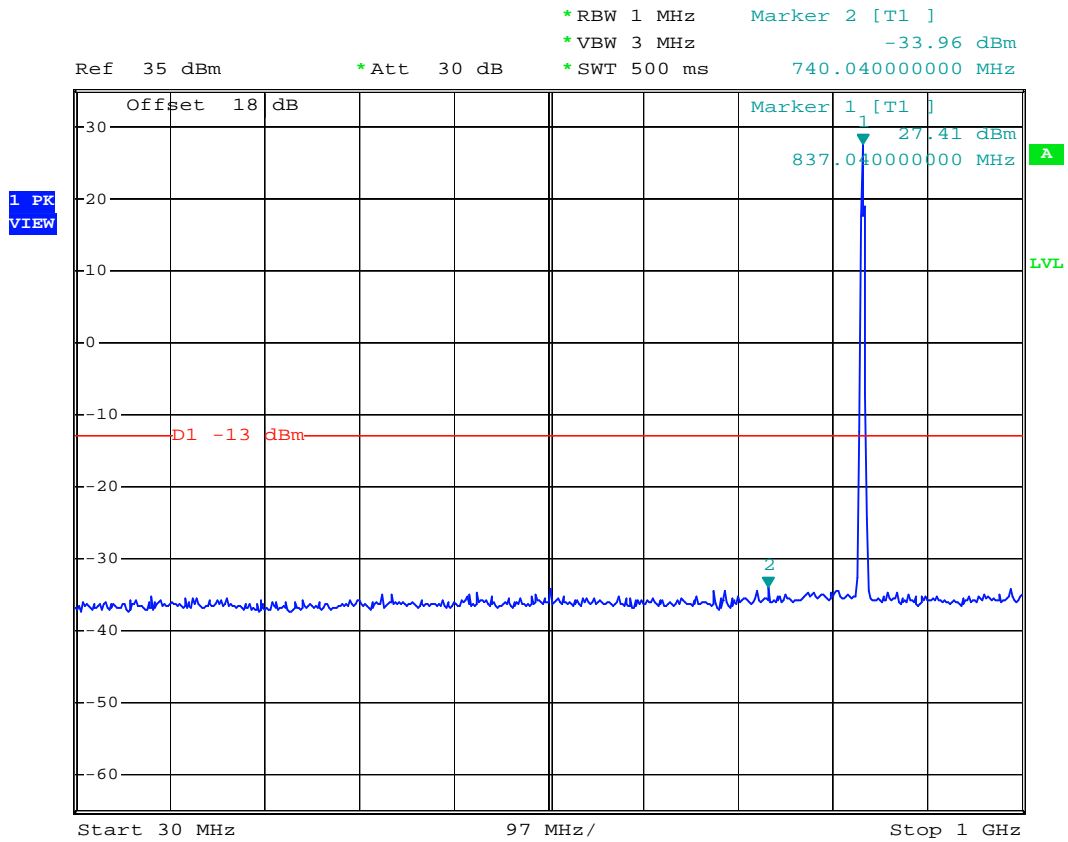

Date: 15.JUL.2007 15:54:17



- Test Mode : GSM850 (EDGE) CH189
- Frequency Range : 1G-3G

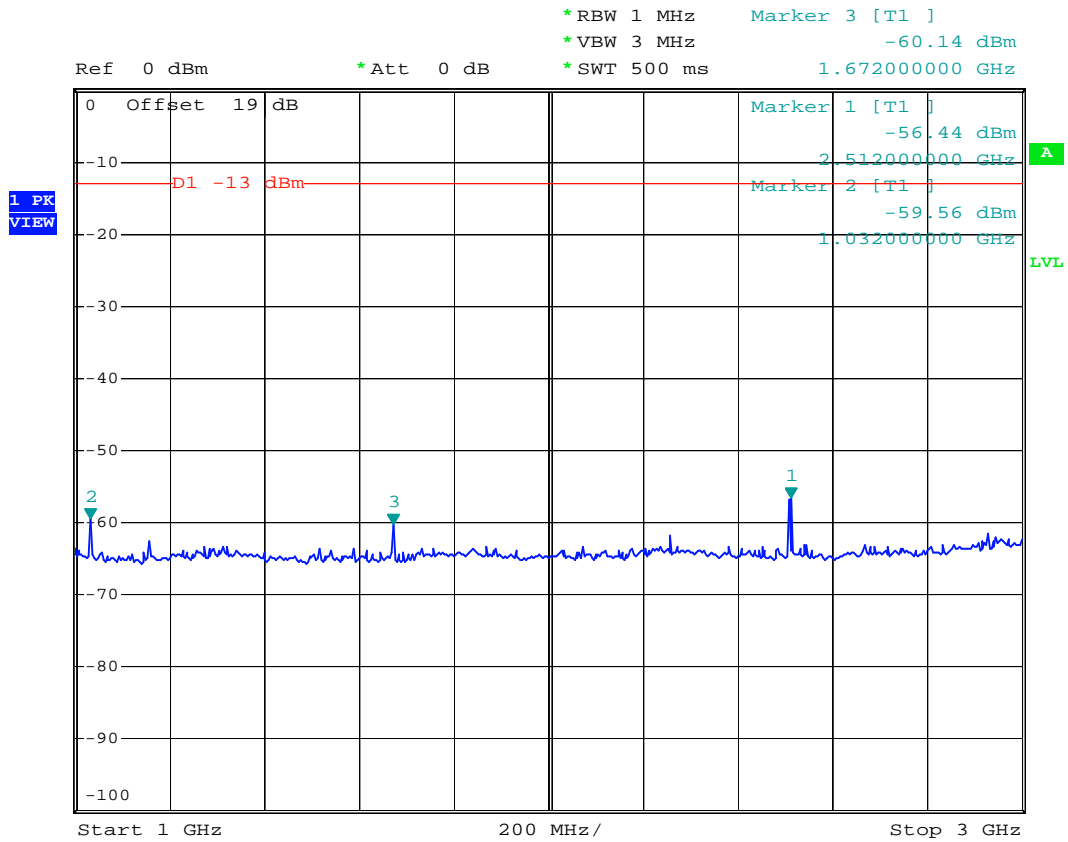

Date: 15.JUL.2007 15:56:51



- Test Mode : GSM850 (EDGE) CH189
- Frequency Range : 3G-7G

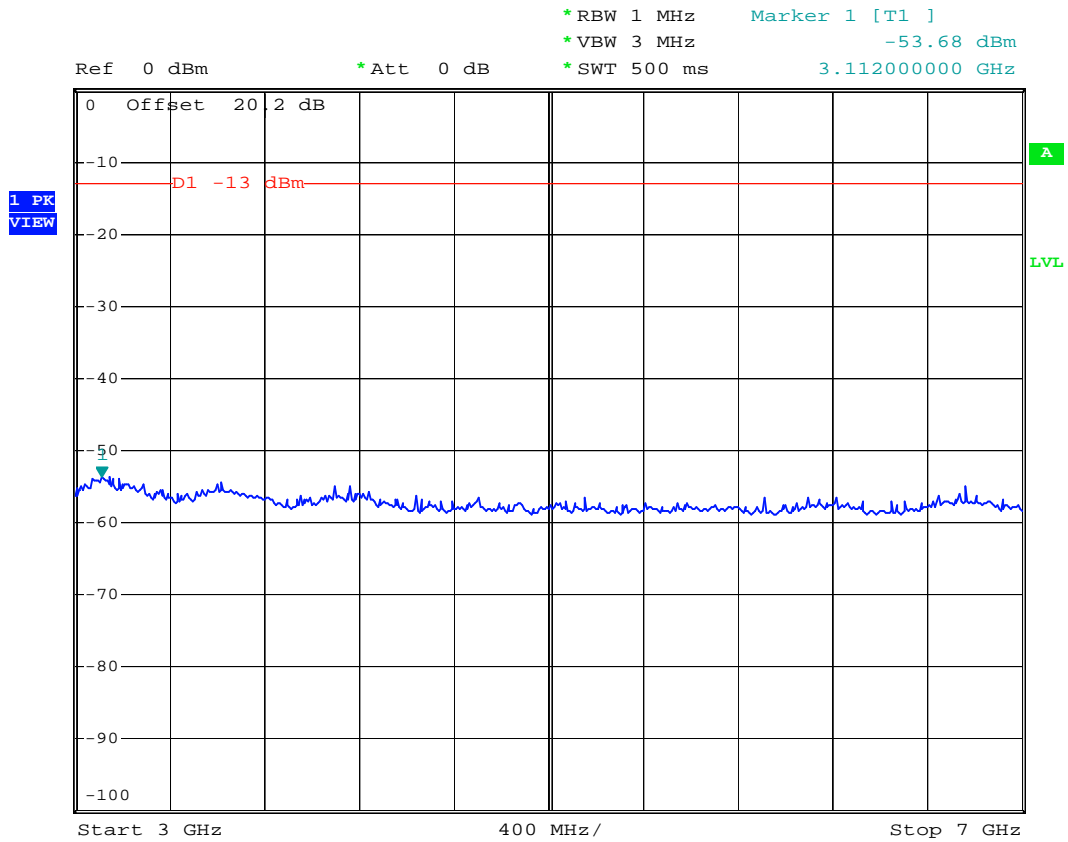

Date: 15.JUL.2007 16:00:06



- Test Mode : GSM850 (EDGE) CH189
- Frequency Range : 7G-9G

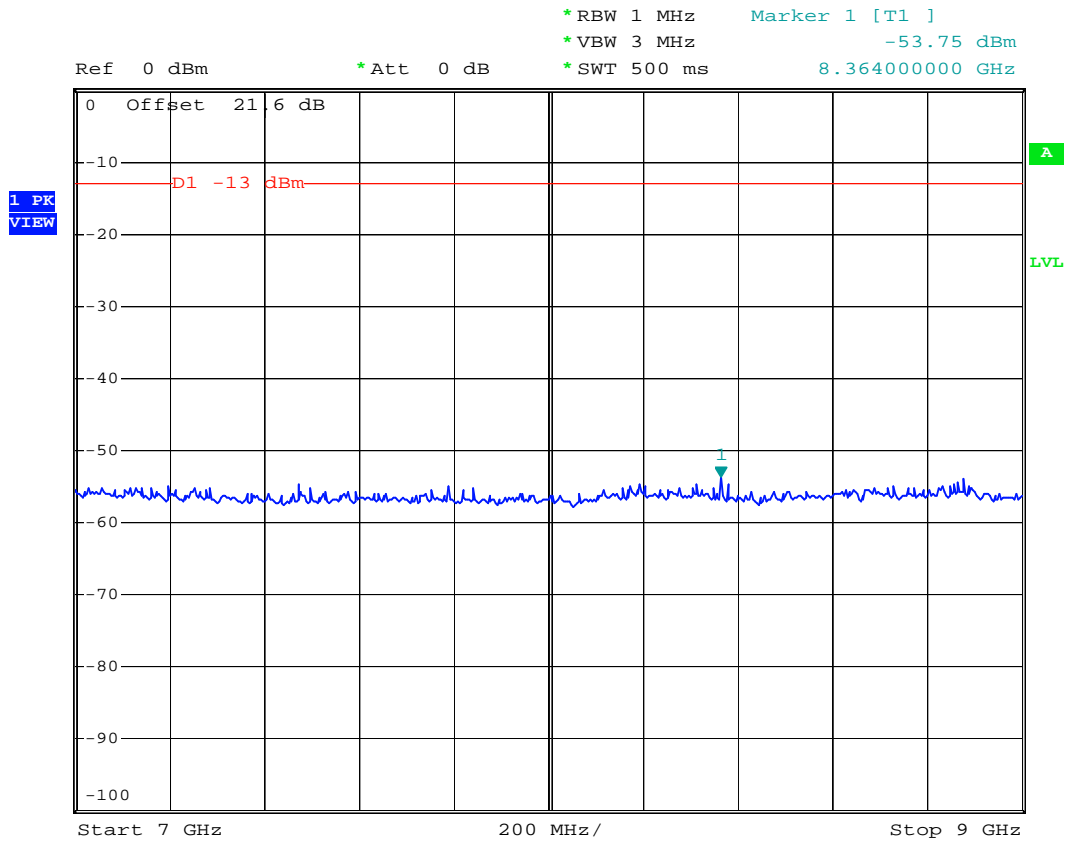

Date: 15.JUL.2007 16:01:29



- Mode 3
- Test Mode : PCS1900 (GSM) CH661
- Frequency Range : 30M-1G

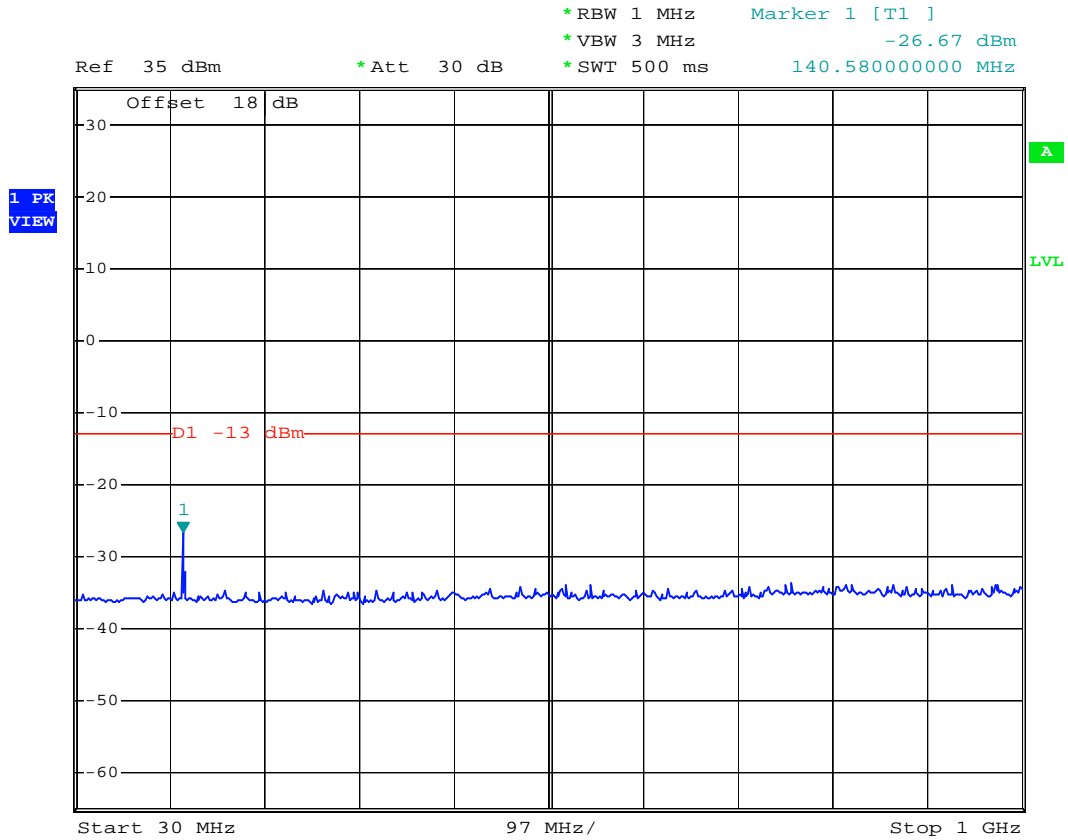

Date: 15.JUL.2007 16:19:14



- Test Mode : PCS1900 (GSM) CH661
- Frequency Range : 1G-3G

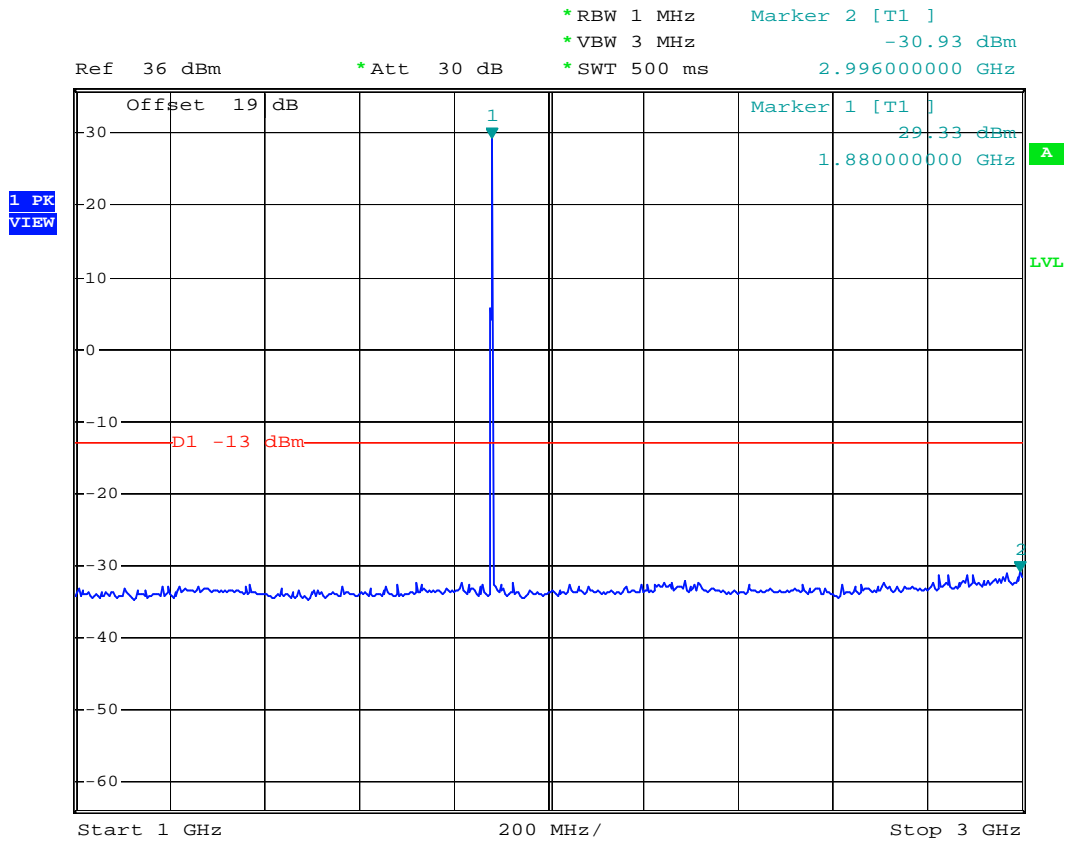

Date: 15.JUL.2007 16:20:53



- Test Mode : PCS1900 (GSM) CH661
- Frequency Range : 3G-7G

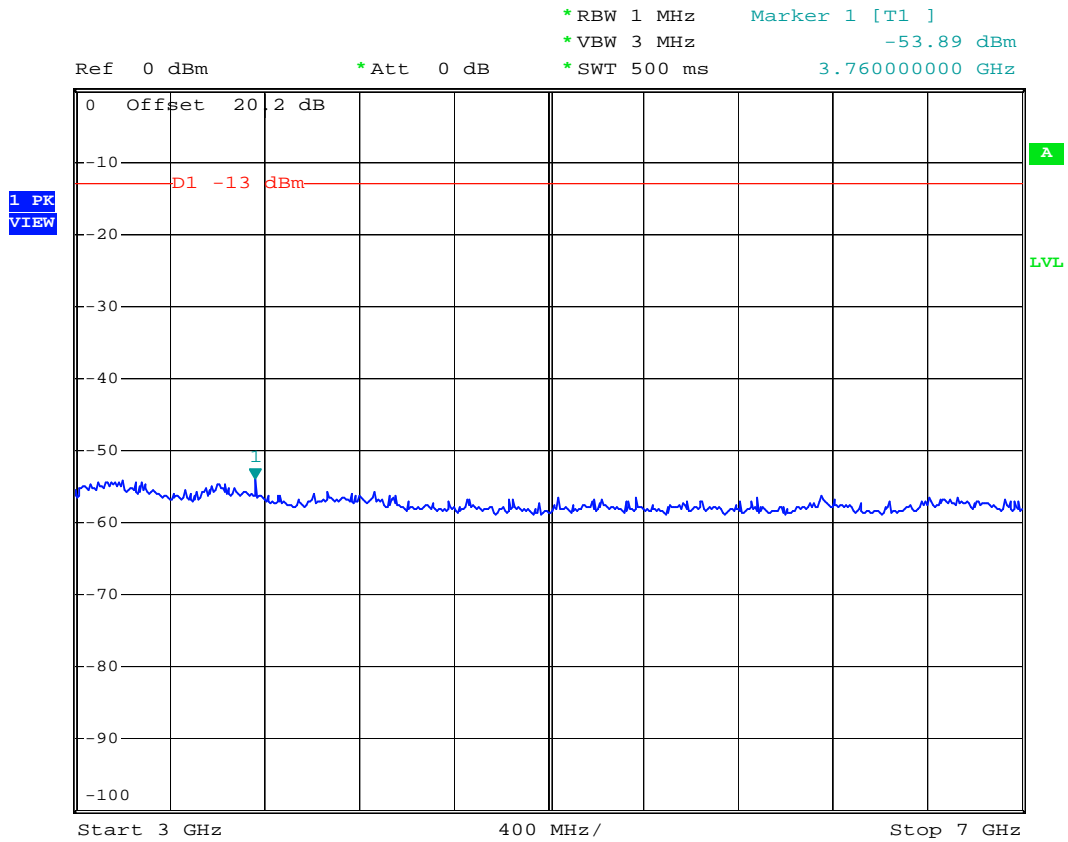

Date: 15.JUL.2007 16:22:00



- Test Mode : PCS1900 (GSM) CH661
- Frequency Range : 7G-13.6G

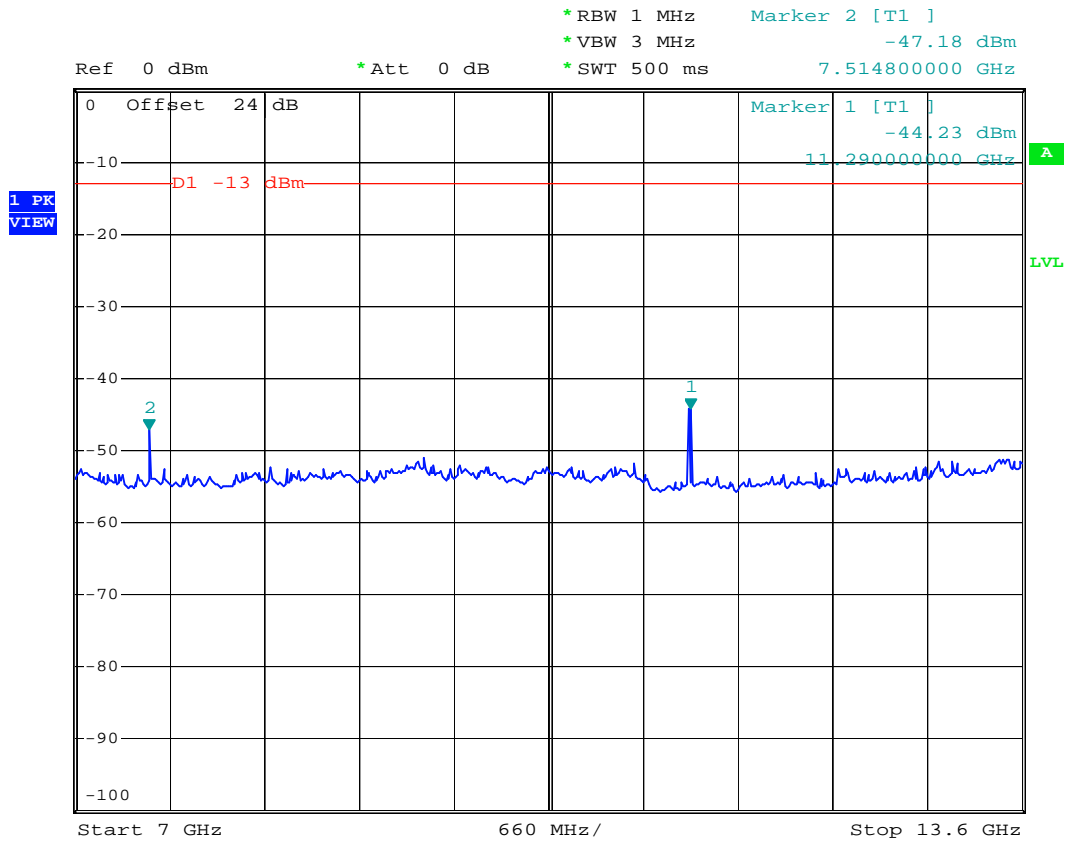

Date: 15.JUL.2007 16:24:20



- Test Mode : PCS1900 (GSM) CH661
- Frequency Range : 13.6G-19.1G

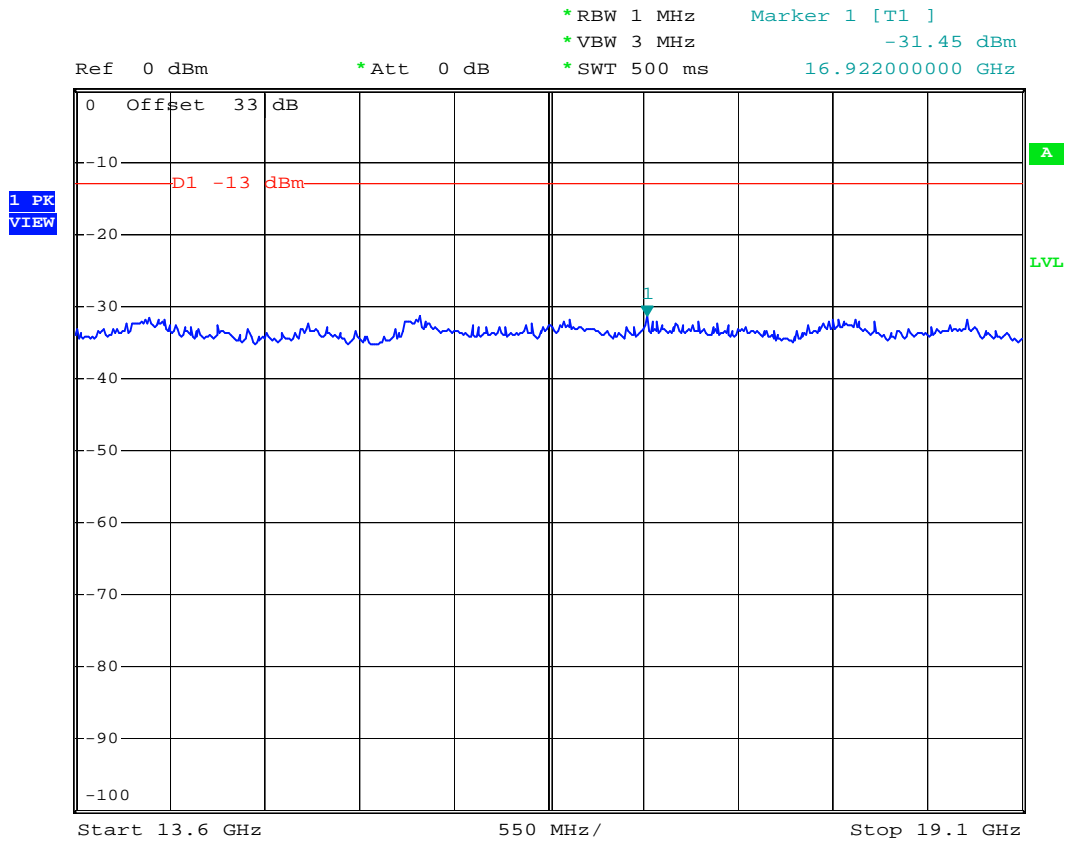

Date: 15.JUL.2007 16:25:10



- Mode 4
- Test Mode : PCS1900 (EDGE) CH661
- Frequency Range : 30M-1G

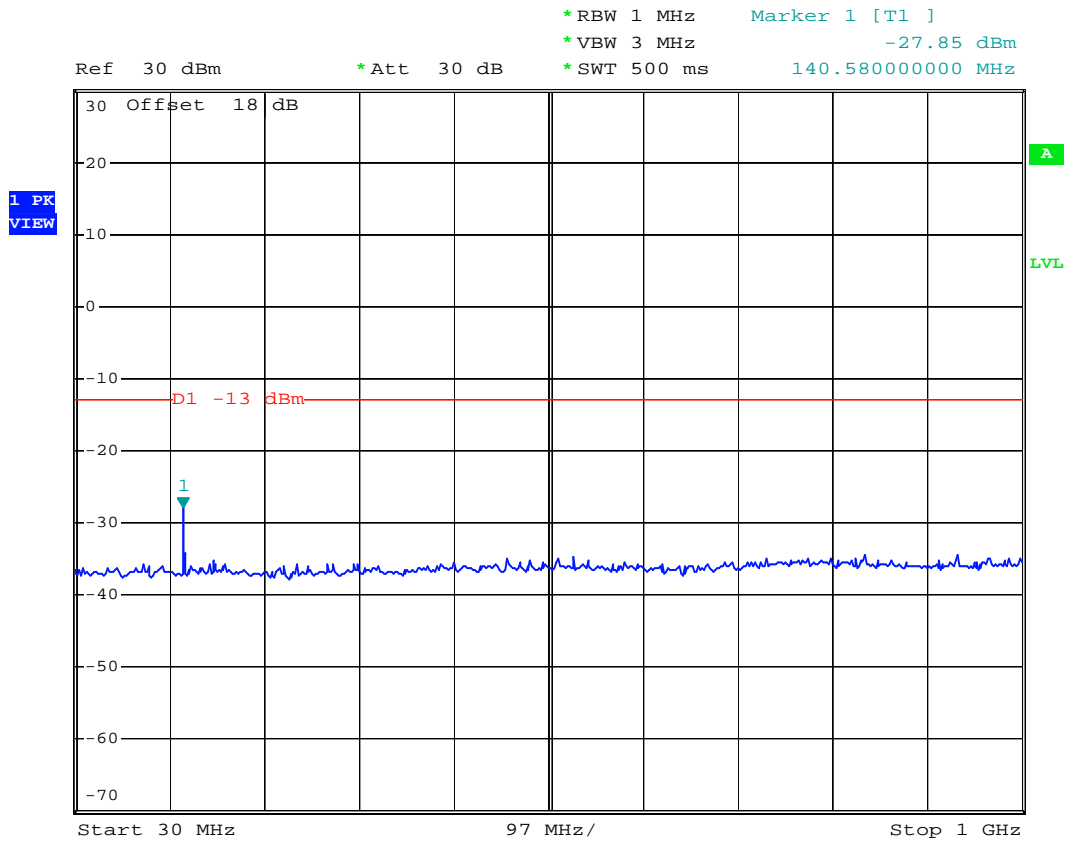

Date: 15.JUL.2007 16:30:30



- Test Mode : PCS1900 (EDGE) CH661
- Frequency Range : 1G-3G

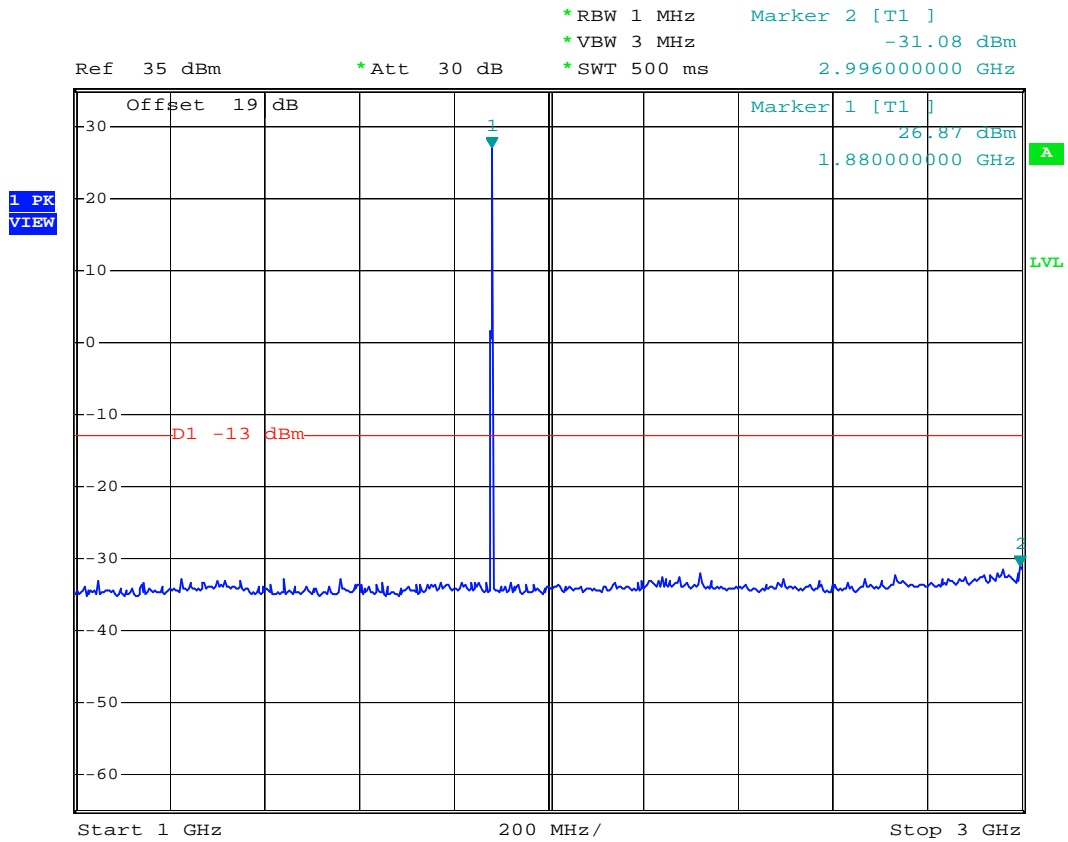

Date: 15.JUL.2007 16:38:58



- Test Mode : PCS1900 (EDGE) CH661
- Frequency Range : 3G-7G

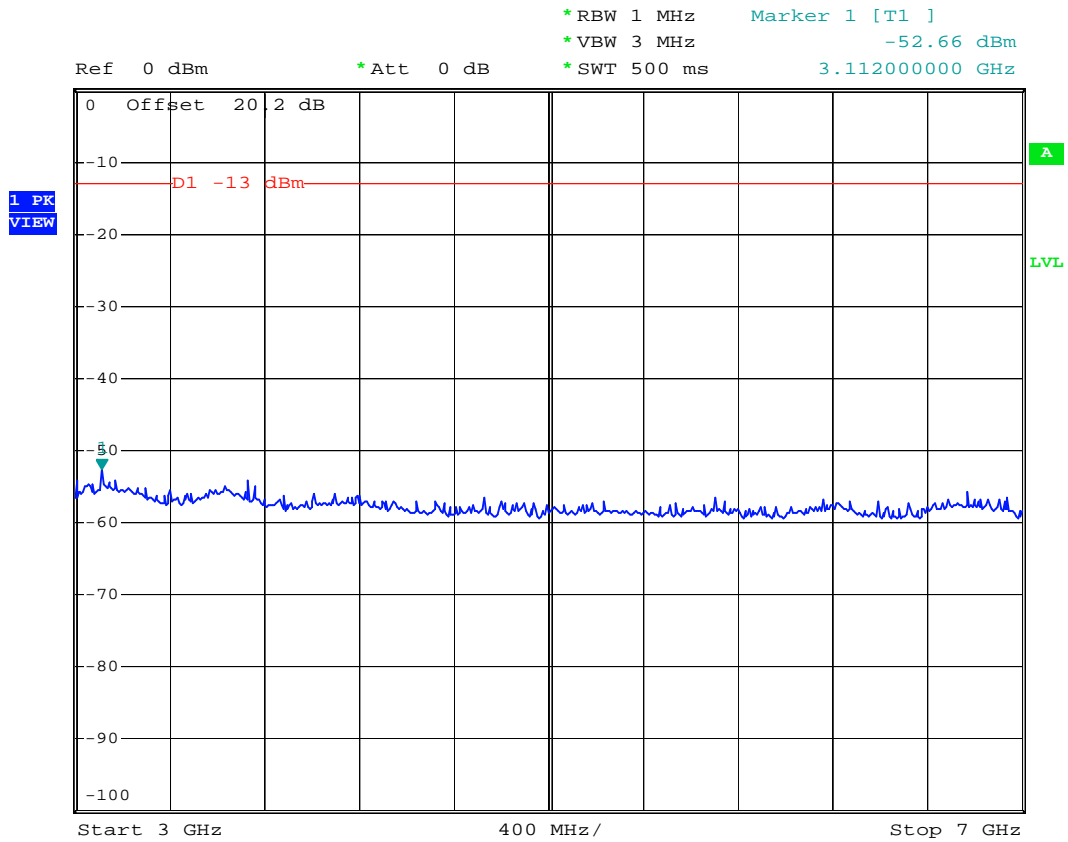

Date: 15.JUL.2007 16:27:45



- Test Mode : PCS1900 (EDGE) CH661
- Frequency Range : 7G-13.6G

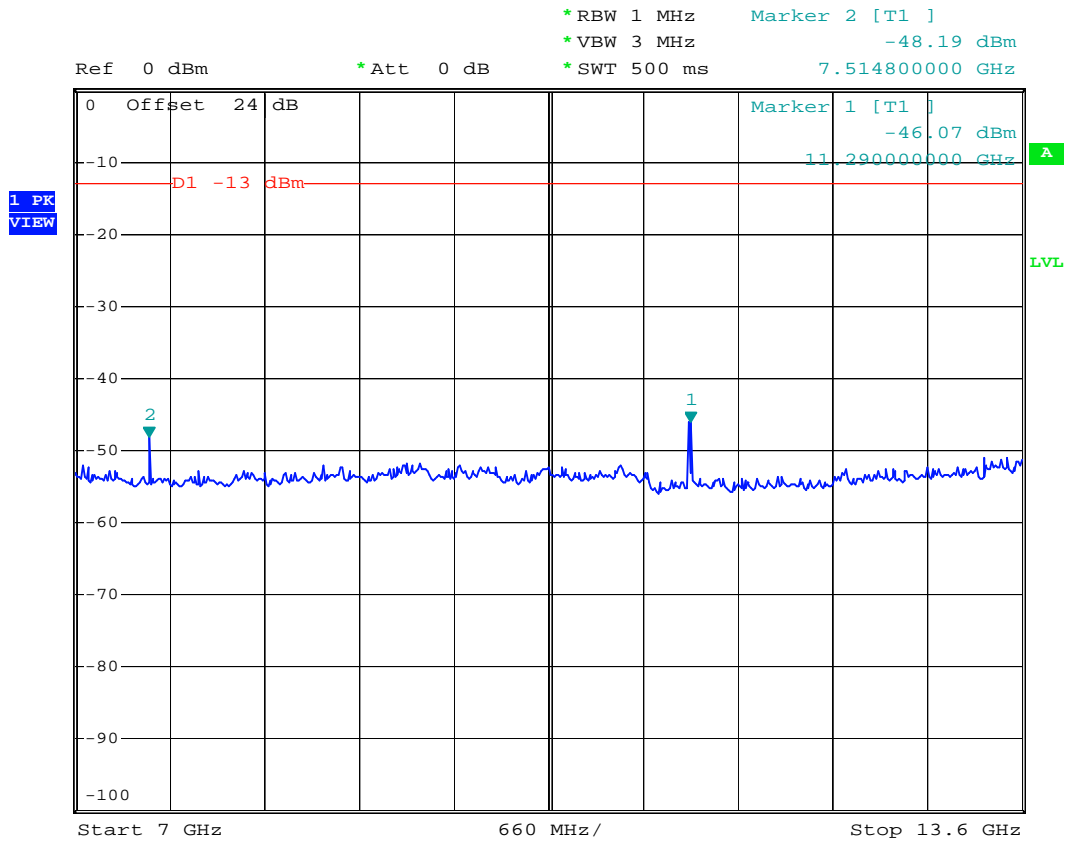

Date: 15.JUL.2007 16:27:01



- Test Mode : PCS1900 (EDGE) CH661
- Frequency Range : 13.6G-19.1G

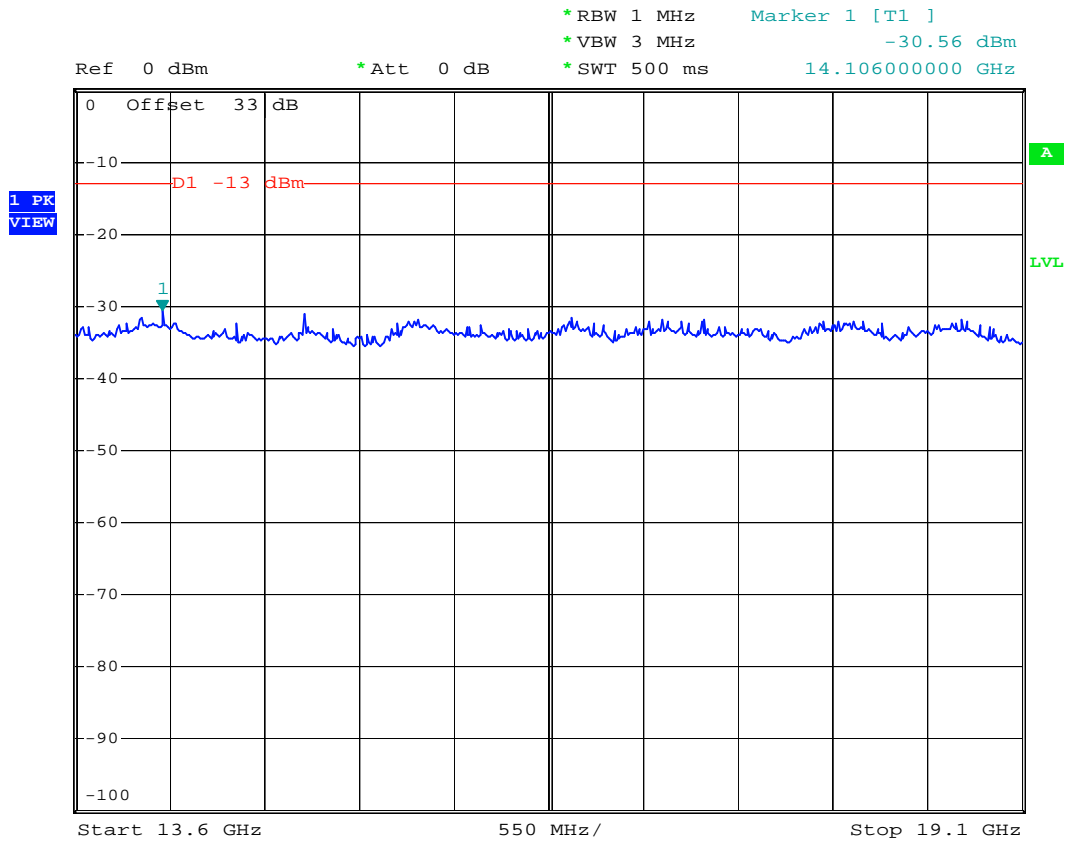

Date: 15.JUL.2007 16:26:24

4.6 Field Strength of Spurious Radiation

Equivalent isotropic radiated Power Measurements by substitution method according to ANSI/TIA/EIA-603-C.

4.6.1 Measurement Instruments

As described in chapter 5 of this test report.

4.6.2 Test Procedure

1. The EUT was placed on a rotatable wooden table with 0.8 meter about ground.
2. The EUT was set 3 meters from the receiving antenna which was mounted on the antenna tower.
3. The table was rotated 360 degrees to determine the position of the highest spurious emission.
4. The height of the receiving antenna is varied between one meter and four meters to reach the maximum spurious emission for both horizontal and vertical polarizations.
5. Taking the record of maximum spurious emission.
6. A Horn antenna was substituted in place of the EUT and was driven by a signal generator.
7. Tune the output power of signal generator to the same emission level with EUT maximum spurious emission.
8. Taking the record of output power at antenna port.
9. Repeat step 7 to step 8 for another polarization.
10. Emission level (dBm) = output power + substitution Gain.

4.6.3 Test Setup Layout

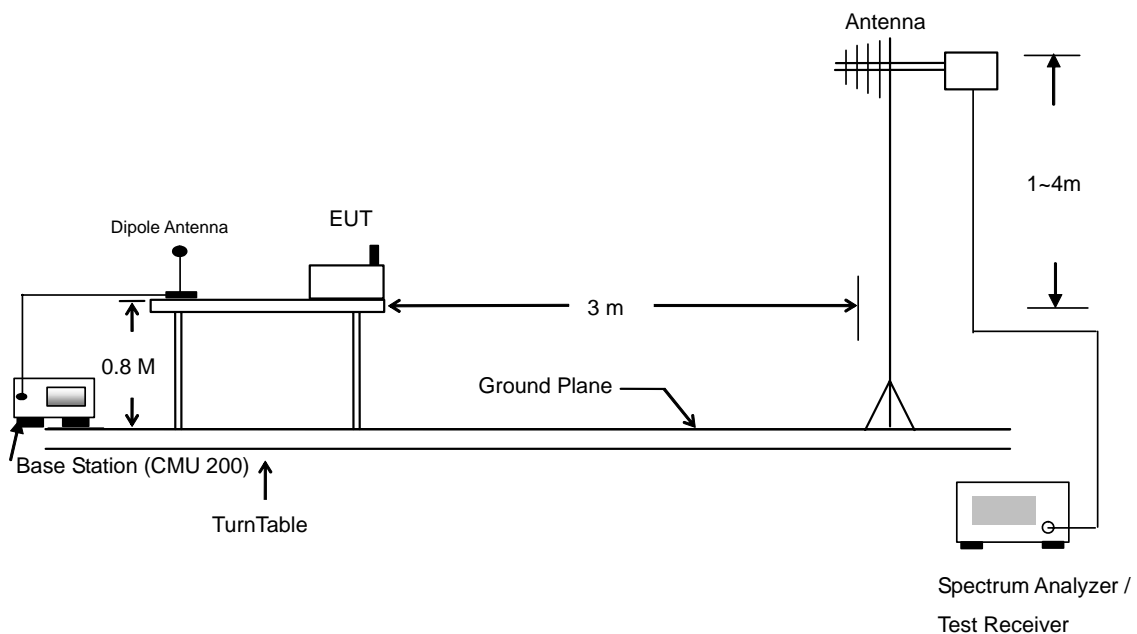



4.6.4 Test Result

- Test Mode : Mode 1

GSM850 (GSM) Radiated Spurious ERP							
H Polarization				V Polarization			
Frequency (MHz)	ERP (dBm)	Limit (dBm)	Margin (dB)	Frequency (MHz)	ERP (dBm)	Limit (dBm)	Margin (dB)
36.480	-60.060	-13	-47.06	35.940	-56.890	-13	-43.89
214.680	-65.190	-13	-52.19	266.790	-66.440	-13	-53.44
265.980	-63.400	-13	-50.40	675.900	-60.270	-13	-47.27
995.800	-56.430	-13	-43.43	1674.000	-24.100	-13	-11.10
1674.000	-21.500	-13	-8.50	2508.000	-43.710	-13	-30.71
3344.000	-55.440	-13	-42.44	2994.000	-58.020	-13	-45.02

- Test Mode : Mode 2

GSM850 (EDGE) Radiated Spurious ERP							
H Polarization				V Polarization			
Frequency (MHz)	ERP (dBm)	Limit (dBm)	Margin (dB)	Frequency (MHz)	ERP (dBm)	Limit (dBm)	Margin (dB)
31.080	-62.160	-13	-49.16	71.580	-60.760	-13	-47.76
76.440	-69.640	-13	-56.64	101.280	-62.200	-13	-49.20
265.440	-64.730	-13	-51.73	192.540	-59.580	-13	-46.58
448.400	-66.120	-13	-53.12	675.900	-63.960	-13	-50.96
1464.000	-55.990	-13	-42.99	1674.000	-57.740	-13	-44.74



Test Mode : Mode 3

PCS1900 (GSM) Radiated Spurious EIRP							
H Polarization				V Polarization			
Frequency (MHz)	EIRP (dBm)	Limit (dBm)	Margin (dB)	Frequency (MHz)	EIRP (dBm)	Limit (dBm)	Margin (dB)
31.890	-60.500	-13	-47.50	85.890	-55.570	-13	-42.57
43.230	-50.990	-13	-37.99	142.590	-59.290	-13	-46.29
266.790	-62.410	-13	-49.41	266.790	-62.520	-13	-49.52
666.800	-63.180	-13	-50.18	665.400	-62.700	-13	-49.70
798.400	-60.200	-13	-47.20	901.300	-60.620	-13	-47.62
934.900	-63.320	-13	-50.32	932.800	-59.590	-13	-46.59
5048.000	-51.350	-13	-38.35	3758.000	-49.960	-13	-36.96
7518.000	-41.960	-13	-28.96	7518.000	-44.550	-13	-31.55

Test Mode : Mode 4

PCS1900 (EDGE) Radiated Spurious EIRP							
H Polarization				V Polarization			
Frequency (MHz)	EIRP (dBm)	Limit (dBm)	Margin (dB)	Frequency (MHz)	EIRP (dBm)	Limit (dBm)	Margin (dB)
31.080	-59.930	-13	-46.93	58.080	-51.210	-13	-38.21
180.930	-59.400	-13	-46.40	142.590	-62.730	-13	-49.73
220.890	-61.060	-13	-48.06	214.680	-63.080	-13	-50.08
448.400	-59.470	-13	-46.47	409.900	-45.700	-13	-32.70
637.400	-48.030	-13	-35.03	444.900	-61.290	-13	-48.29
866.300	-59.740	-13	-46.74	957.300	-61.650	-13	-48.65
1598.000	-53.930	-13	-40.93	1464.000	-57.830	-13	-44.83
1718.000	-49.870	-13	-36.87	1824.000	-58.850	-13	-45.85



- Test Mode : Mode 5

GSM850 (GSM) with WLAN Co-location Radiated Spurious ERP							
H Polarization				V Polarization			
Frequency (MHz)	EIRP (dBm)	Limit (dBm)	Margin (dB)	Frequency (MHz)	EIRP (dBm)	Limit (dBm)	Margin (dB)
31.890	-62.670	-13	-49.67	65.640	-61.510	-13	-48.51
82.380	-69.700	-13	-56.70	90.480	-64.530	-13	-51.53
265.440	-65.890	-13	-52.89	265.980	-64.850	-13	-51.85
995.800	-57.460	-13	-44.46	675.900	-60.420	-13	-47.42
1674.000	-32.860	-13	-19.86	1674.000	-39.790	-13	-26.79
7378.000	-45.190	-13	-32.19				



4.6.5 Test Data
4.6.5.1 Mode 1
Horizontal Polarization

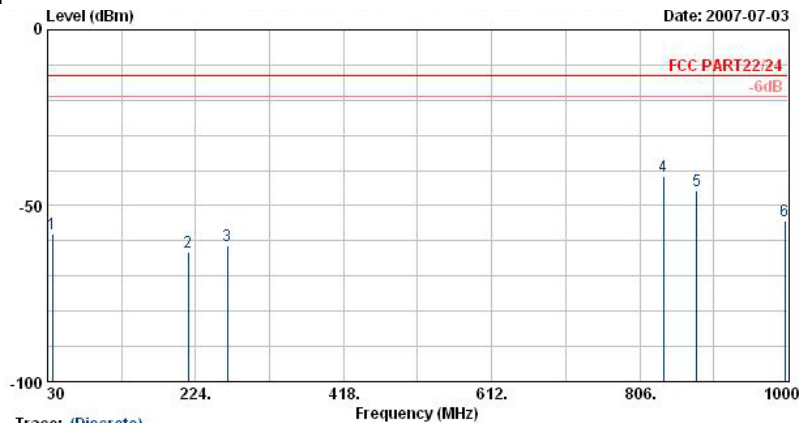

Trace: (Discrete)
Site : 03CH06-HY
Condition : HF-SPURIOUS HORIZONTAL
EUT : Mobile Phone
Power : 120Wac/60Hz
Model : FG 762206
Memo : GSM 850 Link Mode, CH189+Earphone
Plane : E2

Table with 9 columns: Freq (MHz), Level (dBm), Over Limit (dB), Limit Line (dBm), Read Level (dBm), Factor, Remark, Pol/Phase. Contains 6 rows of data for peaks 1-6.

Remark:

- 1. #4: MS Signal
2. #5: BS Signal

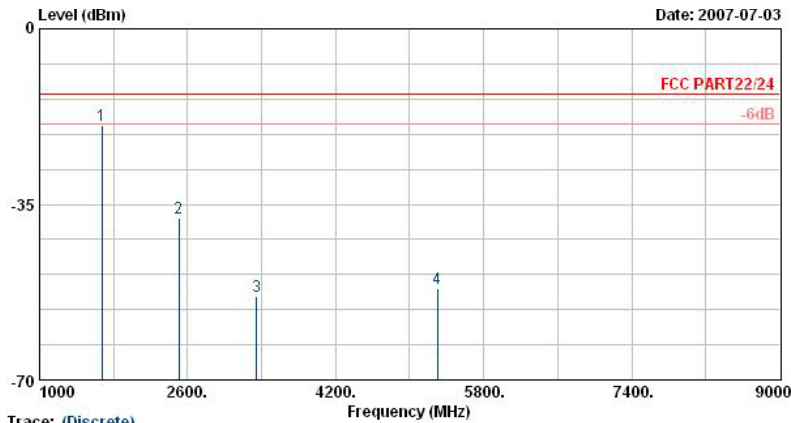

Trace: (Discrete)
Site : 03CH06-HY
Condition : HF-SPURIOUS HORIZONTAL
EUT : Mobile Phone
Power : 120Wac/60Hz
Model : FG 762206
Memo : GSM 850 Link Mode, CH189+Earphone
Plane : E2

Table with 9 columns: Freq (MHz), Level (dBm), Over Limit (dB), Limit Line (dBm), Read Level (dBm), Factor, Remark, Pol/Phase. Contains 4 rows of data for peaks 1-4.



Vertical Polarization

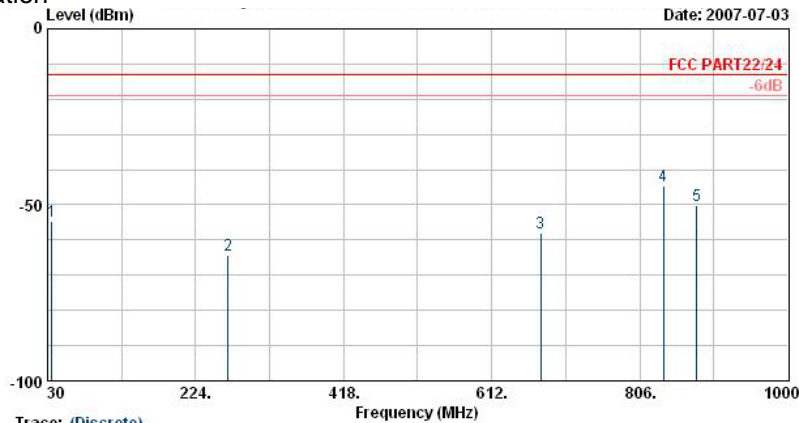

Trace: (Discrete)

Site : 03CH06-HY
 Condition : LP-SPURIOUS VERTICAL
 EUT : Mobile Phone
 Power : 120Wac/60Hz
 Model : FG 762206
 Memo : GSM 850 Link Mode, CH189+Earphone
 +Adaptor
 Plane : E2

	Freq	Level	Over	Limit	Read	Factor	Remark	Pol/Phase
	MHz	dBm	dB	dBm	dBm	dB		
1	35.9	-54.74	-41.74	-13.00	-44.02	-10.71	Peak	VERTICAL
2	266.8	-64.29	-51.29	-13.00	-57.12	-7.16	Peak	VERTICAL
3	675.9	-58.12	-45.12	-13.00	-57.32	-0.79	Peak	VERTICAL
4	836.9	-44.53			-45.90	1.36	Peak	VERTICAL
5	880.3	-50.37			-52.08	1.71	Peak	VERTICAL

Remark:

- #4: MS Signal
- #5: BS Signal

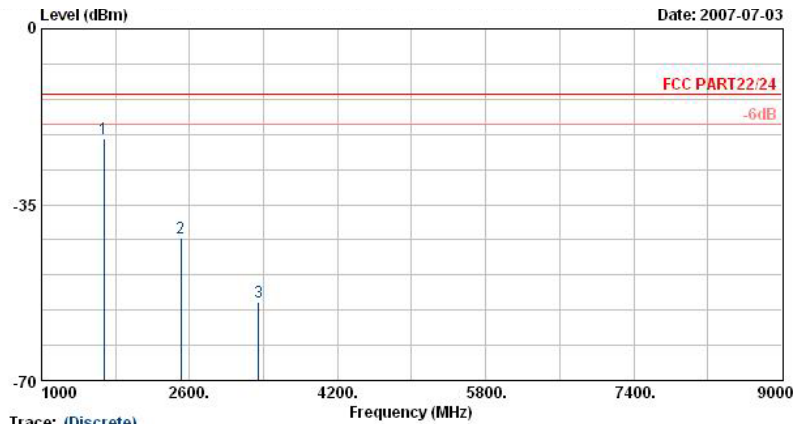

Trace: (Discrete)

Site : 03CH06-HY
 Condition : HF-SPURIOUS VERTICAL
 EUT : Mobile Phone
 Power : 120Wac/60Hz
 Model : FG 762206
 Memo : GSM 850 Link Mode, CH189+Earphone
 +Adaptor
 Plane : E2

	Freq	Level	Over	Limit	Read	Factor	Remark	Pol/Phase
	MHz	dBm	dB	dBm	dBm	dB		
1 @	1674.0	-21.95	-8.95	-13.00	-21.47	-0.48	Peak	VERTICAL
2	2508.0	-41.56	-28.56	-13.00	-43.83	2.27	Peak	VERTICAL
3	3344.0	-54.33	-41.33	-13.00	-58.80	4.47	Peak	VERTICAL



4.6.5.2 Mode 2
Horizontal Polarization

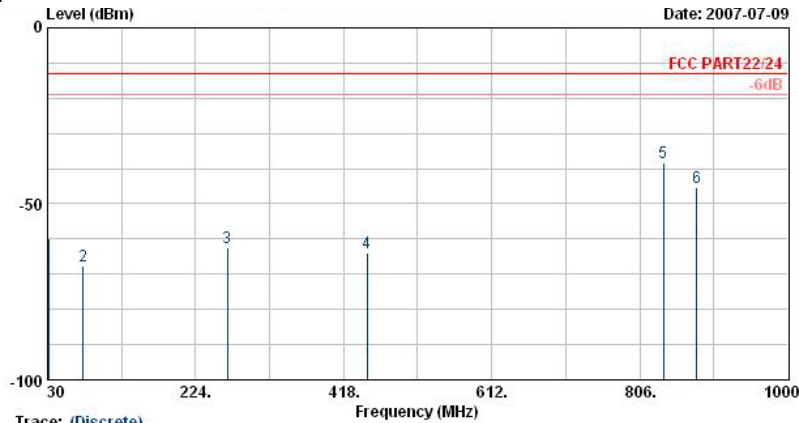

Trace: (Discrete)
 Site : 03CH06-HY
 Condition : LF-SPURIOUS HORIZONTAL
 EUT : Mobile Phone
 Power : 120Vac/60Hz
 Model : FG 762206
 Memo : EDGB(GSM850) Link Mode, Ch189+Earphone
 +Adaptcx
 Plane : E2

	Freq	Level	Over	Limit	Read	Factor	Remark	Pol/Phase
	MHz	dBm	dB	dBm	dBm	dB		
1	31.1	-60.01	-47.01	-13.00	-59.76	-0.25	Peak	HORIZONTAL
2	76.4	-67.49	-54.49	-13.00	-55.16	-12.33	Peak	HORIZONTAL
3	265.4	-62.58	-49.58	-13.00	-51.47	-11.12	Peak	HORIZONTAL
4	448.4	-63.97	-50.97	-13.00	-58.14	-5.83	Peak	HORIZONTAL
5 @	836.9	-38.41			-37.08	-1.33	Peak	HORIZONTAL
6	880.3	-45.22			-44.31	-0.91	Peak	HORIZONTAL

Remark:

- #5: MS Signal
- #6: BS Signal

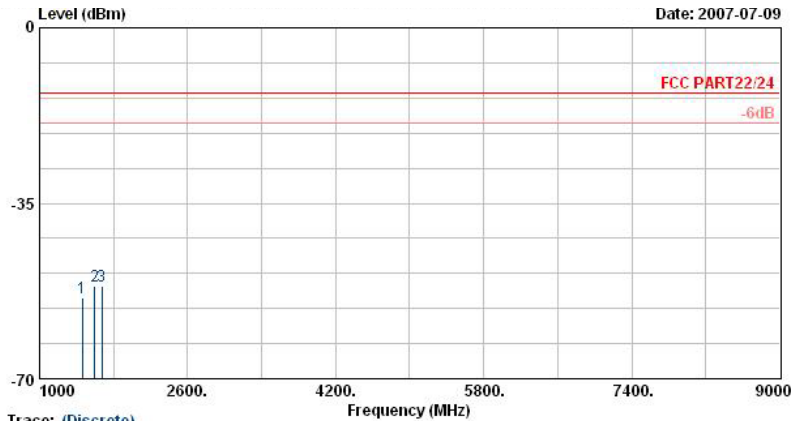

Trace: (Discrete)
 Site : 03CH06-HY
 Condition : HF-SPURIOUS HORIZONTAL
 EUT : Mobile Phone
 Power : 120Vac/60Hz
 Model : FG 762206
 Memo : EDGB(GSM850) Link Mode, Ch189+Earphone
 +Adaptcx
 Plane : E2

	Freq	Level	Over	Limit	Read	Factor	Remark	Pol/Phase
	MHz	dBm	dB	dBm	dBm	dB		
1	1464.0	-53.84	-40.84	-13.00	-54.37	0.53	Peak	HORIZONTAL
2	1598.0	-51.51	-38.51	-13.00	-51.89	0.37	Peak	HORIZONTAL
3	1674.0	-51.53	-38.53	-13.00	-51.75	0.22	Peak	HORIZONTAL



Vertical Polarization

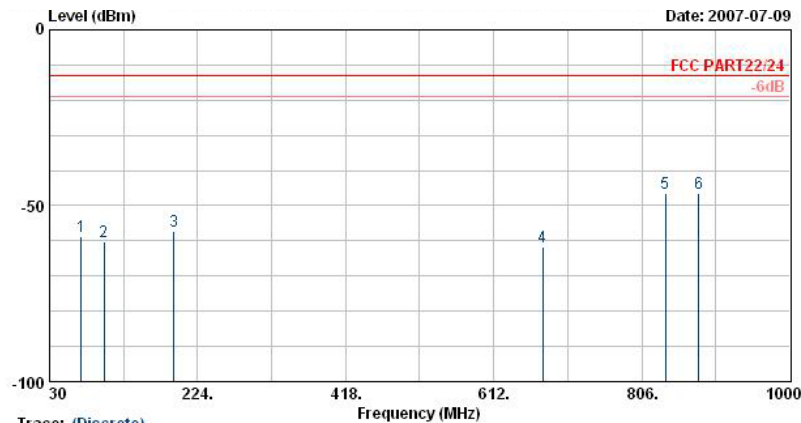

Trace: (Discrete)
 Site : 03CH06-HY
 Condition : HF-SFUROUS VERTICAL
 EUT : Mobile Phone
 Power : 120Wac/60Hz
 Model : FG 762206
 Memo : EDGB(GSM&3G) Link Mode,Ch189+Earphone
 : +Adaptor
 Plane : E2

	Freq	Level	Over	Limit	Read	Factor	Remark	Pol/Phase
	MHz	dBm	dB	dBm	dBm	dB		
1	71.6	-58.61	-45.61	-13.00	-46.86	-11.74	Peak	VERTICAL
2	101.3	-60.05	-47.05	-13.00	-52.35	-7.70	Peak	VERTICAL
3	192.5	-57.43	-44.43	-13.00	-48.90	-8.53	Peak	VERTICAL
4	675.9	-61.81	-48.81	-13.00	-61.02	-0.79	Peak	VERTICAL
5	836.9	-46.38			-47.74	1.36	Peak	VERTICAL
6	880.3	-46.48			-48.19	1.71	Peak	VERTICAL

Remark:

- #5: MS Signal
- #6: BS Signal

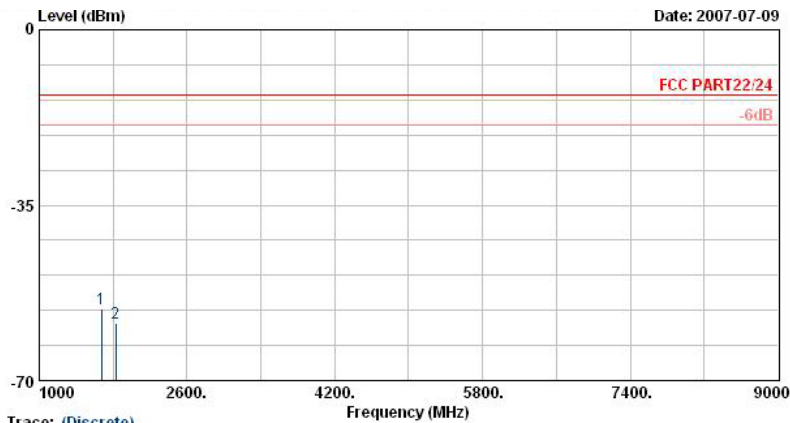

Trace: (Discrete)
 Site : 03CH06-HY
 Condition : HF-SFUROUS VERTICAL
 EUT : Mobile Phone
 Power : 120Wac/60Hz
 Model : FG 762206
 Memo : EDGB(GSM&3G) Link Mode,Ch189+Earphone
 : +Adaptor
 Plane : E2

	Freq	Level	Over	Limit	Read	Factor	Remark	Pol/Phase
	MHz	dBm	dB	dBm	dBm	dB		
1	1674.0	-55.59	-42.59	-13.00	-55.11	-0.48	Peak	VERTICAL
2	1828.0	-58.53	-45.53	-13.00	-58.22	-0.31	Peak	VERTICAL



4.6.5.3 Mode 3
Horizontal Polarization

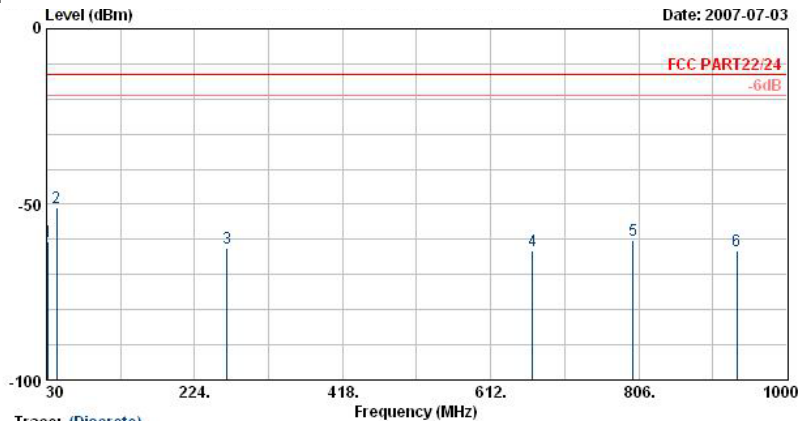

Trace: (Discrete)
 Site : 03CH06-HY
 Condition : LF-SPURIOUS HORIZONTAL
 EUT : Mobile Phone
 Power : 120Vac/60Hz
 Model : FG 762206
 Memo : PCS 1900 Link Mode, CM661+Exophone
 Plane : +Adaptor
 : E2

	Freq MHz	Level dBm	Over Limit dB	Limit Line dBm	Read Level dBm	Factor dB	Remark	Pol/Phase
1	31.9	-60.50	-47.50	-13.00	-59.65	-0.86	Peak	HORIZONTAL
2	43.2	-50.99	-37.99	-13.00	-42.83	-8.17	Peak	HORIZONTAL
3	266.8	-62.41	-49.41	-13.00	-51.32	-11.08	Peak	HORIZONTAL
4	666.8	-63.18	-50.18	-13.00	-60.12	-3.06	Peak	HORIZONTAL
5	798.4	-60.20	-47.20	-13.00	-58.49	-1.71	Peak	HORIZONTAL
6	934.9	-63.32	-50.32	-13.00	-62.94	-0.39	Peak	HORIZONTAL

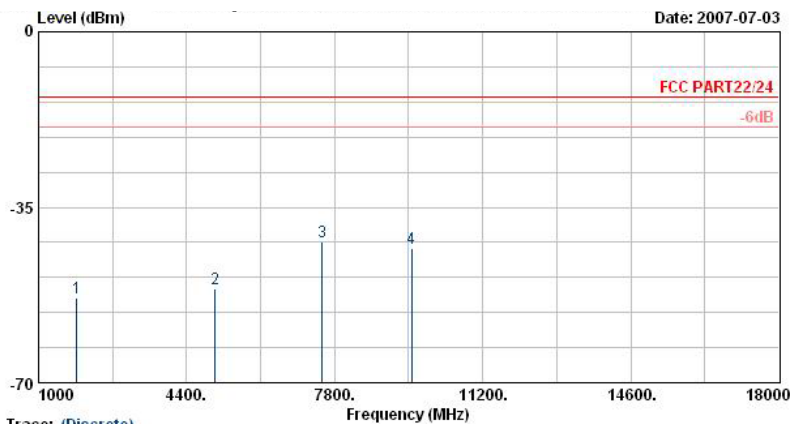

Trace: (Discrete)
 Site : 03CH06-HY
 Condition : HF-SPURIOUS HORIZONTAL
 EUT : Mobile Phone
 Power : 120Vac/60Hz
 Model : FG 762206
 Memo : PCS 1900 Link Mode, CM661+Exophone
 Plane : +Adaptor
 : E2

	Freq MHz	Level dBm	Over Limit dB	Limit Line dBm	Read Level dBm	Factor dB	Remark	Pol/Phase
1	1878.0	-53.12			-52.61	-0.51	Peak	HORIZONTAL
2	5048.0	-51.35	-38.35	-13.00	-61.53	10.18	Peak	HORIZONTAL
3	7518.0	-41.96	-28.96	-13.00	-57.77	15.80	Peak	HORIZONTAL
4	9564.0	-43.31	-30.31	-13.00	-61.60	18.28	Peak	HORIZONTAL

Remark:
 1. #1: MS Signal



Vertical Polarization

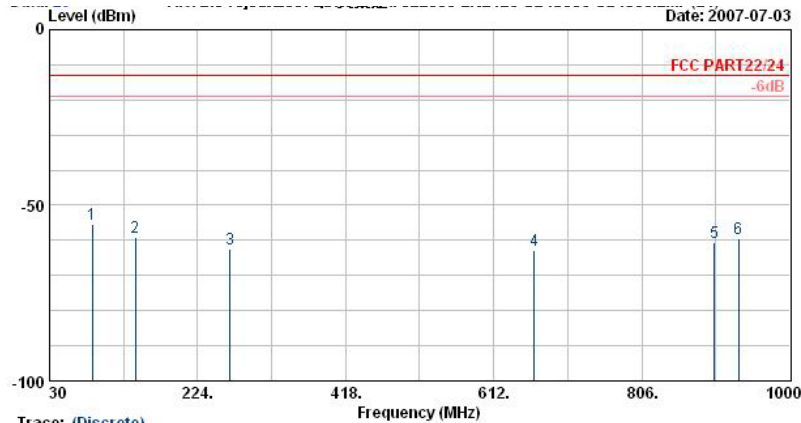

Trace: (Discrete)
 Site : 03CH06-HY
 Condition : LF-SPURIOUS VERTICAL
 EUT : Mobile Phone
 Power : 120Wac/60Hz
 Model : FG 762206
 Memo : FCS 1900 Link Mode, Ch661+Exaphone
 Plane : +Adaptor
 : E2

	Freq	Level	Over	Limit	Read	Factor	Remark	Pol/Phase
	MHz	dBm	dB	dBm	dBm	dB		
1	85.9	-55.57	-42.57	-13.00	-45.93	-9.65	Peak	VERTICAL
2	142.6	-59.29	-46.29	-13.00	-51.21	-8.07	Peak	VERTICAL
3	266.8	-62.52	-49.52	-13.00	-55.36	-7.16	Peak	VERTICAL
4	665.4	-62.70	-49.70	-13.00	-61.75	-0.95	Peak	VERTICAL
5	901.3	-60.62	-47.62	-13.00	-62.49	1.87	Peak	VERTICAL
6	932.8	-59.59	-46.59	-13.00	-61.72	2.13	Peak	VERTICAL

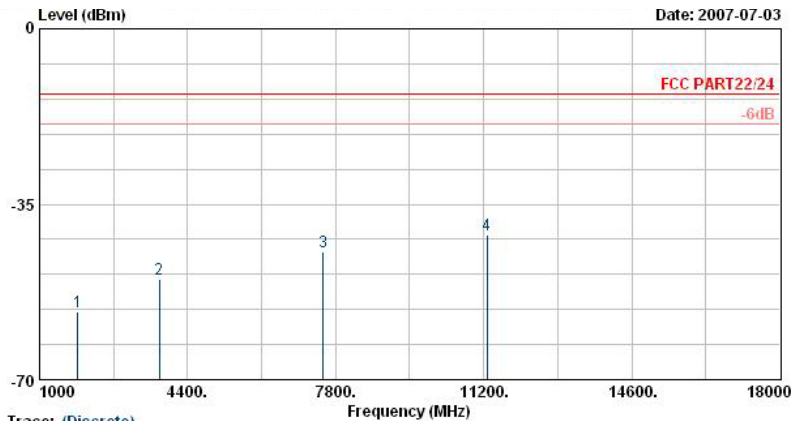

Trace: (Discrete)
 Site : 03CH06-HY
 Condition : HF-SPURIOUS VERTICAL
 EUT : Mobile Phone
 Power : 120Wac/60Hz
 Model : FG 762206
 Memo : FCS 1900 Link Mode, Ch661+Exaphone
 Plane : +Adaptor
 : E2

	Freq	Level	Over	Limit	Read	Factor	Remark	Pol/Phase
	MHz	dBm	dB	dBm	dBm	dB		
1	1878.0	-56.50			-56.10	-0.40	Peak	VERTICAL
2	3758.0	-49.96	-36.96	-13.00	-56.60	6.64	Peak	VERTICAL
3	7518.0	-44.55	-31.55	-13.00	-57.91	13.37	Peak	VERTICAL
4 @	11278.0	-41.22	-28.22	-13.00	-60.10	18.87	Peak	VERTICAL

Remark:

- #1: MS Signal



4.6.5.4 Mode 4
Horizontal Polarization

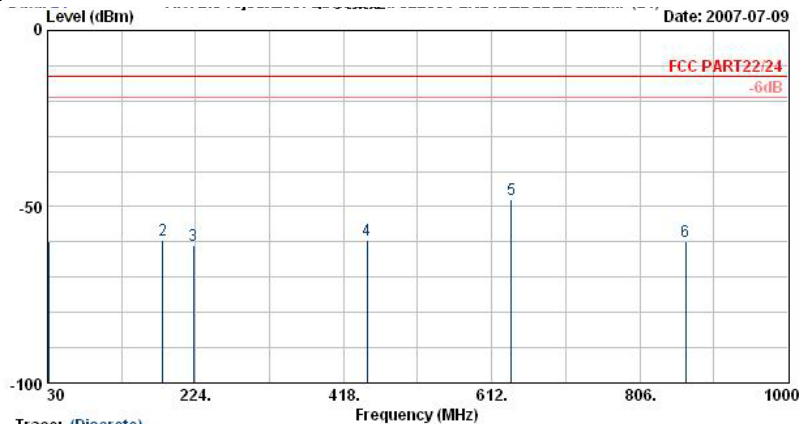

Trace: (Discrete)
 Site : 03CH06-HY
 Condition : LP-SPURIOUS HORIZONTAL
 EUT : Mobile Phone
 Power : 120Vac/60Hz
 Model : FG 762206
 Memo : EDGE(FCS 1900) Link Mode,Ch661+Earphone
 : +Adaptor
 Plane : E2

	Freq	Level	Over	Limit	Read	Factor	Remark	Pol/Phase
	MHz	dBm	dB	dBm	dBm	dB		
1	31.1	-59.93	-46.93	-13.00	-59.68	-0.25	Peak	HORIZONTAL
2	180.9	-59.40	-46.40	-13.00	-46.22	-13.18	Peak	HORIZONTAL
3	220.9	-61.06	-48.06	-13.00	-48.41	-12.65	Peak	HORIZONTAL
4	448.4	-59.47	-46.47	-13.00	-53.64	-5.83	Peak	HORIZONTAL
5 @	637.4	-48.03	-35.03	-13.00	-44.67	-3.36	Peak	HORIZONTAL
6	866.3	-59.74	-46.74	-13.00	-58.69	-1.05	Peak	HORIZONTAL

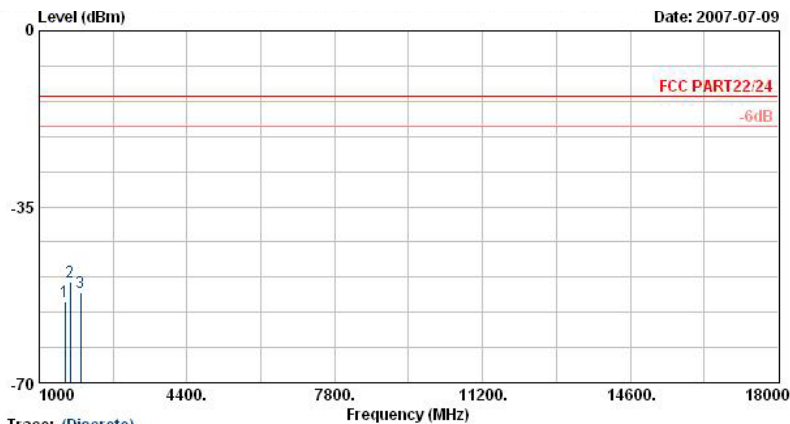

Trace: (Discrete)
 Site : 03CH06-HY
 Condition : HP-SPURIOUS HORIZONTAL
 EUT : Mobile Phone
 Power : 120Vac/60Hz
 Model : FG 762206
 Memo : EDGE(FCS 1900) Link Mode,Ch661+Earphone
 : +Adaptor
 Plane : E2

	Freq	Level	Over	Limit	Read	Factor	Remark	Pol/Phase
	MHz	dBm	dB	dBm	dBm	dB		
1 @	1598.0	-53.93	-40.93	-13.00	-54.30	0.37	Peak	HORIZONTAL
2 @	1718.0	-49.87	-36.87	-13.00	-49.94	0.08	Peak	HORIZONTAL
3 @	1958.0	-52.10			-50.99	-1.11	Peak	HORIZONTAL

Remark:

- #3: BS Signal



Vertical Polarization

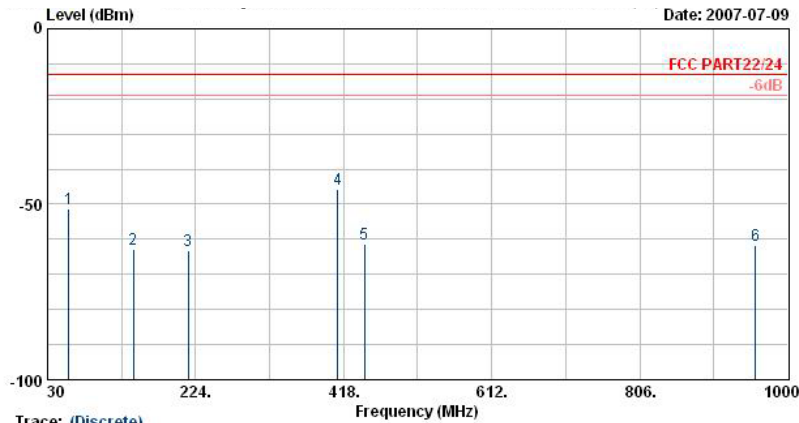

Trace: (Discrete)
 Site : 03CH06-HY
 Condition : HF-SPURIOUS VERTICAL
 EUT : Mobile Phone
 Power : 120Wac/60Hz
 Model : FG 762206
 Memo : EDGB(FCS 1900) Link Mode,Ch661+Earphone
 : +Adaptor
 Plane : E2

	Freq	Level	Over	Limit	Read	Factor	Remark	Pol/Phase
	MHz	dBm	dB	dBm	dBm	dB		
1 @	58.1	-51.21	-38.21	-13.00	-37.51	-13.70	Peak	VERTICAL
2	142.6	-62.73	-49.73	-13.00	-54.65	-8.07	Peak	VERTICAL
3	214.7	-63.08	-50.08	-13.00	-54.80	-8.28	Peak	VERTICAL
4 @	409.9	-45.70	-32.70	-13.00	-41.50	-4.20	Peak	VERTICAL
5	444.9	-61.29	-48.29	-13.00	-57.50	-3.79	Peak	VERTICAL
6	957.3	-61.65	-48.65	-13.00	-63.97	2.32	Peak	VERTICAL

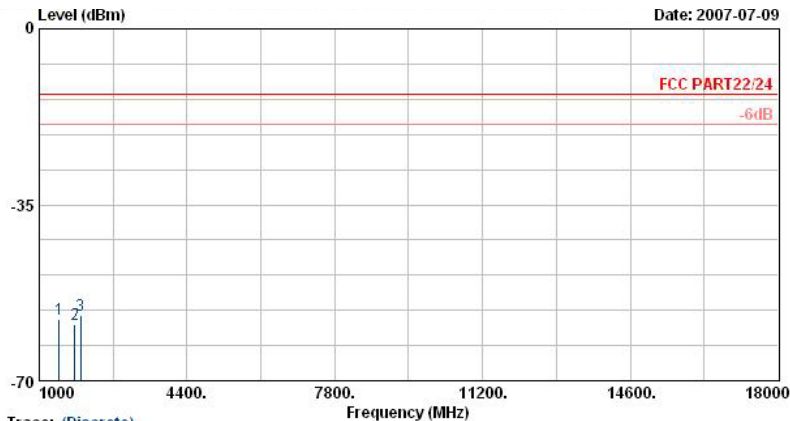

Trace: (Discrete)
 Site : 03CH06-HY
 Condition : HF-SPURIOUS VERTICAL
 EUT : Mobile Phone
 Power : 120Wac/60Hz
 Model : FG 762206
 Memo : EDGB(FCS 1900) Link Mode,Ch661+Earphone
 : +Adaptor
 Plane : E2

	Freq	Level	Over	Limit	Read	Factor	Remark	Pol/Phase
	MHz	dBm	dB	dBm	dBm	dB		
1	1464.0	-57.83	-44.83	-13.00	-56.90	-0.93	Peak	VERTICAL
2	1824.0	-58.85	-45.85	-13.00	-58.55	-0.31	Peak	VERTICAL
3 @	1958.0	-57.10			-56.51	-0.60	Peak	VERTICAL

Remark:

- #3: BS Signal



4.6.5.5 Mode 5
Horizontal Polarization

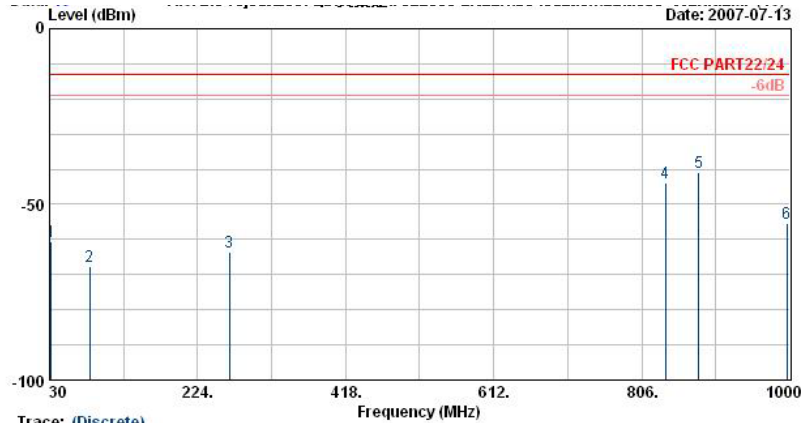

Trace: (Discrete)
 Site : 03CH06-HY
 Condition : LP-SPURIOUS HORIZONTAL
 EUT : Mobile Phone
 Power : 120Wac@0Hz
 Model : FG 761327
 Memo : GSM 850 Link Mode,CH189+Earphone
 : +WLAN 11g Tx_Ch11,2462MHz+Adaptor
 : E2
 Plane :

	Freq	Level	Over	Limit	Read	Factor	Remark	Pol/Phase
	MHz	dBm	dB	dBm	dBm	dB		
1	31.9	-60.52	-47.52	-13.00	-59.67	-0.86	Peak	HORIZONTAL
2	82.4	-67.55	-54.55	-13.00	-55.24	-12.31	Peak	HORIZONTAL
3	265.4	-63.74	-50.74	-13.00	-52.62	-11.12	Peak	HORIZONTAL
4	836.9	-43.91			-42.58	-1.33	Peak	HORIZONTAL
5 @	880.3	-40.75			-39.84	-0.91	Peak	HORIZONTAL
6	995.8	-55.31	-42.31	-13.00	-55.51	0.20	Peak	HORIZONTAL

Remark:

- #4: MS Signal
- #5: BS Signal

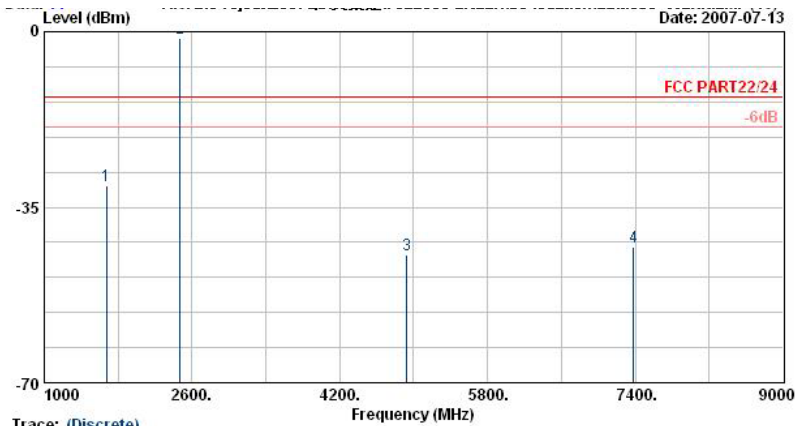

Trace: (Discrete)
 Site : 03CH06-HY
 Condition : HF-SPURIOUS HORIZONTAL
 EUT : Mobile Phone
 Power : 120Wac@0Hz
 Model : FG 761327
 Memo : GSM 850 Link Mode,CH189+Earphone
 : +WLAN 11g Tx_Ch11,2462MHz+Adaptor
 : E2
 Plane :

	Freq	Level	Over	Limit	Read	Factor	Remark	Pol/Phase
	MHz	dBm	dB	dBm	dBm	dB		
1 @	1674.0	-30.71	-17.71	-13.00	-30.93	0.22	Peak	HORIZONTAL
2 @	2468.0	-1.30			-2.46	1.16	Peak	HORIZONTAL
3	4928.0	-44.42	-31.42	-13.00	-55.24	10.83	Peak	HORIZONTAL
4	7378.0	-43.04	-30.04	-13.00	-57.86	14.82	Peak	HORIZONTAL

Remark:

- #2: WLAN Signal



Vertical Polarization

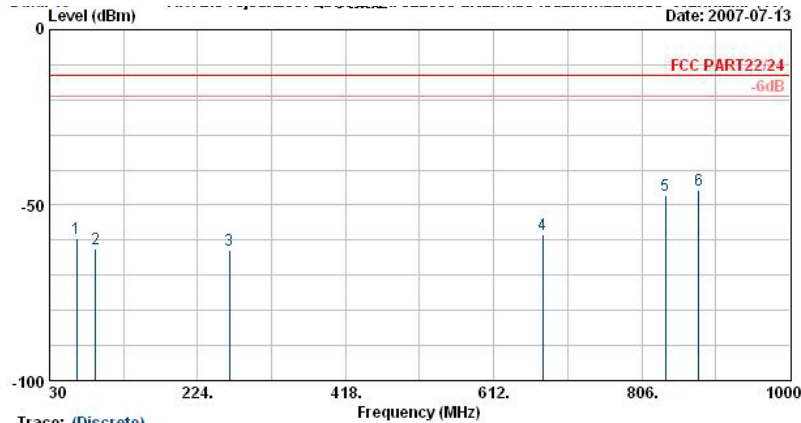

Trace: (Discrete)
 Site : 03CH06-HY
 Condition : LF-SPURIOUS VERTICAL
 EUT : Mobile Phone
 Power : 120Wac/60Hz
 Model : FG 761327
 Memo : GSM 850 Link Mode,Ch189+Earphone
 : +WLAN 11g Tx,Ch11,2462MHz+Adaptor
 : E2
 Plane :

	Freq	Level	Over	Limit	Read	Factor	Remark	Pol/Phase
	MHz	dBm	dB	dBm	dBm	dB		
1	65.6	-59.36	-46.36	-13.00	-46.78	-12.58	Peak	VERTICAL
2	90.5	-62.38	-49.38	-13.00	-53.29	-9.09	Peak	VERTICAL
3	266.0	-62.70	-49.70	-13.00	-55.51	-7.18	Peak	VERTICAL
4	675.9	-58.27	-45.27	-13.00	-57.48	-0.79	Peak	VERTICAL
5	836.9	-47.11			-48.48	1.36	Peak	VERTICAL
6	880.3	-45.58			-47.29	1.71	Peak	VERTICAL

Remark:

- #5: MS Signal
- #6: BS Signal

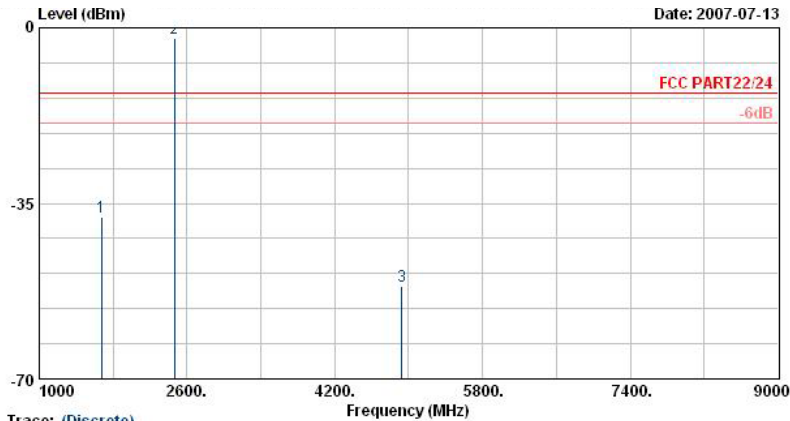

Trace: (Discrete)
 Site : 03CH06-HY
 Condition : HF-SPURIOUS VERTICAL
 EUT : Mobile Phone
 Power : 120Wac/60Hz
 Model : FG 761327
 Memo : GSM 850 Link Mode,Ch189+Earphone
 : +WLAN 11g Tx,Ch11,2462MHz+Adaptor
 : E2
 Plane :

	Freq	Level	Over	Limit	Read	Factor	Remark	Pol/Phase
	MHz	dBm	dB	dBm	dBm	dB		
1 @	1674.0	-37.64	-24.64	-13.00	-37.16	-0.48	Peak	VERTICAL
2 @	2464.0	-2.06			-4.21	2.16	Peak	VERTICAL
3	4928.0	-51.48	-38.48	-13.00	-60.94	9.46	Peak	VERTICAL

Remark:

- #2: WLAN Signal

4.7 Frequency Stability (Temperature Variation)

4.7.1 Measurement Instrument

As described in chapter 5 of this test report.

4.7.2 Test Procedure

1. The EUT and test equipment were set up as shown on the following section.
2. With all power removed, the temperature was decreased to -30°C and permitted to stabilize for three hours. Power was applied and the maximum change in frequency was noted within one minute.
3. With power OFF, the temperature was raised in 10°C steps. The sample was permitted to stabilize at each step for at least one-half hour. Power was applied and the maximum frequency change was noted within one minute.
4. The temperature tests were performed for the worst case.
5. Test data was recorded.

4.7.3 Test Setup Layout

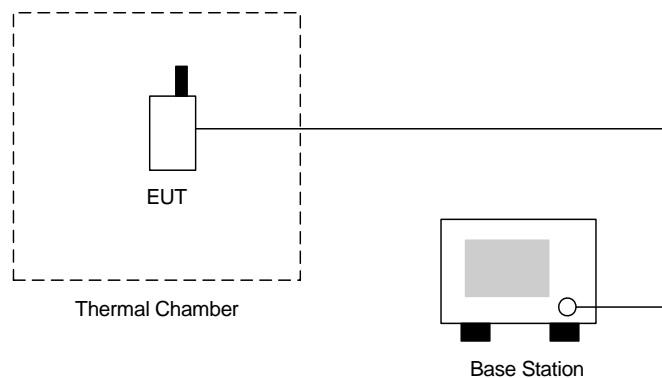

**4.7.4 Test Result**

- Test Mode : GSM850 (GSM) CH189

Temperature()	Change (Hz)	Change (ppm)	Limit (ppm)	Result
-30	-55	-0.03	2.5	Passed
-20	37	0.04		
-10	35	0.04		
0	-28	-0.03		
10	-26	-0.03		
20	-33	-0.04		
30	-36	-0.04		
40	42	0.05		
50	-45	-0.05		

- Test Mode : GSM850 (EDGE) CH189

Temperature()	Change (Hz)	Change (ppm)	Limit (ppm)	Result
-30	-66	-0.03	2.5	Passed
-20	-62	-0.07		
-10	57	0.07		
0	-28	-0.03		
10	31	0.04		
20	27	0.03		
30	-41	-0.05		
40	46	0.05		
50	48	0.06		

- Test Mode : PCS1900 (GSM) CH661

Temperature()	Change (Hz)	Change (ppm)	Limit (ppm)	Result
-30	38	0.02	2.5	Passed
-20	-26	-0.01		
-10	33	0.02		
0	-20	-0.01		
10	-25	-0.01		
20	21	0.01		
30	16	0.01		
40	-28	-0.01		
50	-27	-0.01		



▪ Test Mode : PCS1900 (EDGE) CH661

Temperature()	Change (Hz)	Change (ppm)	Limit (ppm)	Result
-30	-33	-0.02	2.5	Passed
-20	28	0.01		
-10	24	0.01		
0	-22	-0.01		
10	-25	-0.01		
20	31	0.02		
30	-33	-0.02		
40	35	0.02		
50	-42	-0.02		

4.8 Frequency Stability (Voltage Variation)

4.8.1 Measurement Instrument

As described in chapter 5 of this test report.

4.8.2 Test Procedure

1. The EUT was placed in a temperature chamber at $25\pm 5^{\circ}\text{C}$ and connected as the following section.
2. The power supply voltage to the EUT was varied from BEP to 115% of the nominal value measured at the input to the EUT.
3. The variation in frequency was measured for the worst case.

4.8.3 Test Setup Layout

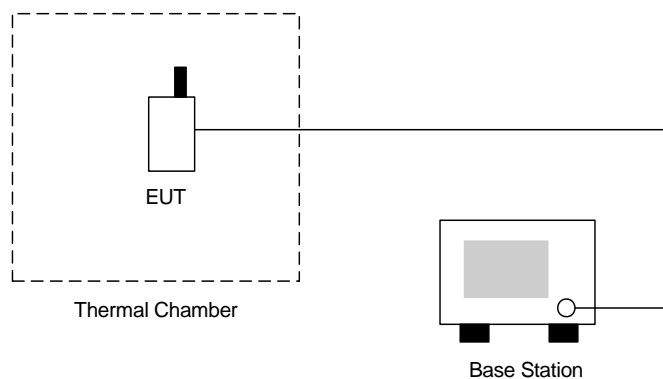

4.8.4 Test Result

- Test Mode : GSM850 (GSM) CH189

Voltage(Volt)	Change (Hz)	Change (ppm)	Limit (ppm)	Result
3.7	22.0	0.03	2.5	Passed
BEP	24.0	0.03		
4.2	25.0	0.03		

- Test Mode : GSM850 (EDGE) CH189

Voltage(Volt)	Change (Hz)	Change (ppm)	Limit (ppm)	Result
3.7	-15.0	-0.02	2.5	Passed
BEP	-18.0	-0.02		
4.2	-27.0	-0.03		



- Test Mode : PCS1900 (GSM) CH661

Voltage(Volt)	Change (Hz)	Change (ppm)	Limit (ppm)	Result
3.7	22.0	0.01	2.5	Passed
BEP	18.0	0.01		
4.2	-20.0	-0.01		

- Test Mode : PCS1900 (EDGE) CH661

Voltage(Volt)	Change (Hz)	Change (ppm)	Limit (ppm)	Result
3.7	21.0	0.01	2.5	Passed
BEP	-25.0	-0.01		
4.2	16.0	0.01		

Remark:

Normal Voltage=3.7V.
Battery End Point (BEP)= 3.4 V.



5 List of Measurement Equipments

Instrument	Manufacturer	Model No.	Serial No.	Characteristics	Calibration Date	Due Date	Remark
Thermal Chamber	Ten Million	TTH-D35P	TBN-930701	N/A	Jul. 24, 2006	Jul. 23, 2007	TH02-HY
Spectrum	R&S	FSP40	100055	9KHz~40GHz	Jun. 25, 2007	Jun. 24, 2008	TH02-HY
Bluetooth Test	ANRITSU	MT8852A	6K00003939	N/A	N/A	N/A	TH02-HY
POWER DIVIDER	ARRA	5200-1	3871	N/A	Oct. 07, 2006	Oct. 06, 2007	TH02-HY
DC POWER SUPPLY	TOPWARD	3303D	740889	N/A	May 25, 2005	May 24, 2009	TH02-HY
Power Meter	Agilent	E4416A	GB41292344	N/A	Feb. 08, 2007	Feb. 07, 2008	TH02-HY
Spectrum analyzer	Agilent	E4408B	MY44211030	9KHz-26.5GHz	Oct. 05, 2006	Oct. 04, 2007	Radiation (03CH06-HY)
EMI Test Receiver	R&S	ESCS30	100356	9KHz-2.75GHz	Jul. 13, 2007	Jul. 12, 2008	Radiation (03CH06-HY)
Bilog Antenna	SCHAFFNER	CBL6112B	2885	30MHz -2GHz	Nov. 20, 2006	Nov. 19, 2007	Radiation (03CH06-HY)
Double Ridge Horn Antenna	Com-Power	AH118	071025	1G~18G	Jun. 04, 2007	Jun. 03, 2008	Radiation (03CH06-HY)
SHF-EHF Horn	SCHWARZBECK	BBHA 9170	9170-249	14G - 40G	Nov. 20, 2006	Nov. 19, 2008	Radiation (03CH06-HY)
Pre Amplifier	Agilent	8449B	3008A01917	1G - 26.5G	Nov. 15, 2006	Nov. 14, 2007	Radiation (03CH06-HY)
Pre Amplifier	Mini Circuits	ZKL-2	D092004-1	10~2500MHz	Nov. 15, 2006	Nov. 14, 2007	Radiation (03CH06-HY)
Base Station Simulator	R & S	CMU200	106656	WCDMA	Nov. 20, 2006	Nov. 19, 2007	Radiation (03CH06-HY)



6 Uncertainty Evaluation

Uncertainty of Radiated Emission Measurement (30MHz ~ 1000MHz)

Contribution	Uncertainty of x_i		$u(x_i)$
	dB	Probability Distribution	
Receiver reading	0.41	Normal(k=2)	0.21
Antenna factor calibration	0.83	Normal(k=2)	0.42
Cable loss calibration	0.25	Normal(k=2)	0.13
Pre Amplifier Gain calibration	0.27	Normal(k=2)	0.14
RCV/SPA specification	2.50	Rectangular	0.72
Antenna Factor Interpolation for Frequency	1.00	Rectangular	0.29
Site imperfection	1.43	Rectangular	0.83
Mismatch	+0.39/-0.41	U-shaped	0.28
combined standard uncertainty Uc(y)	1.27		
Measuring uncertainty for a level of confidence of 95% U=2Uc(y)	2.54		

Uncertainty of Radiated Emission Measurement (1GHz ~ 40GHz)

Contribution	Uncertainty of x_i		$u(x_i)$	C_i	$C_i * u(x_i)$
	dB	Probability Distribution			
Receiver reading	±0.10	Normal(k=1)	0.10	1	0.10
Antenna factor calibration	±1.70	Normal(k=2)	0.85	1	0.85
Cable loss calibration	±0.50	Normal(k=2)	0.25	1	0.25
Receiver Correction	±2.00	Rectangular	1.15	1	1.15
Antenna Factor Directional	±1.50	Rectangular	0.87	1	0.87
Site imperfection	±2.80	Triangular	1.14	1	1.14
Mismatch Receiver VSWR $\Gamma_1 = 0.197$ Antenna VSWR $\Gamma_2 = 0.194$ Uncertainty = $20 \log(1 - \Gamma_1 * \Gamma_2 * \Gamma_3)$	+0.34/-0.35	U-shaped	0.244	1	0.244
Combined standard uncertainty Uc(y)	2.36				
Measuring uncertainty for a level of confidence of 95% U=2Ue(y)	4.72				

END OF TEST REPORT



Appendix A. External Photographs of EUT





762206





➤ Scanner 1

762206





➤ Scanner 2

762206





761417





762206

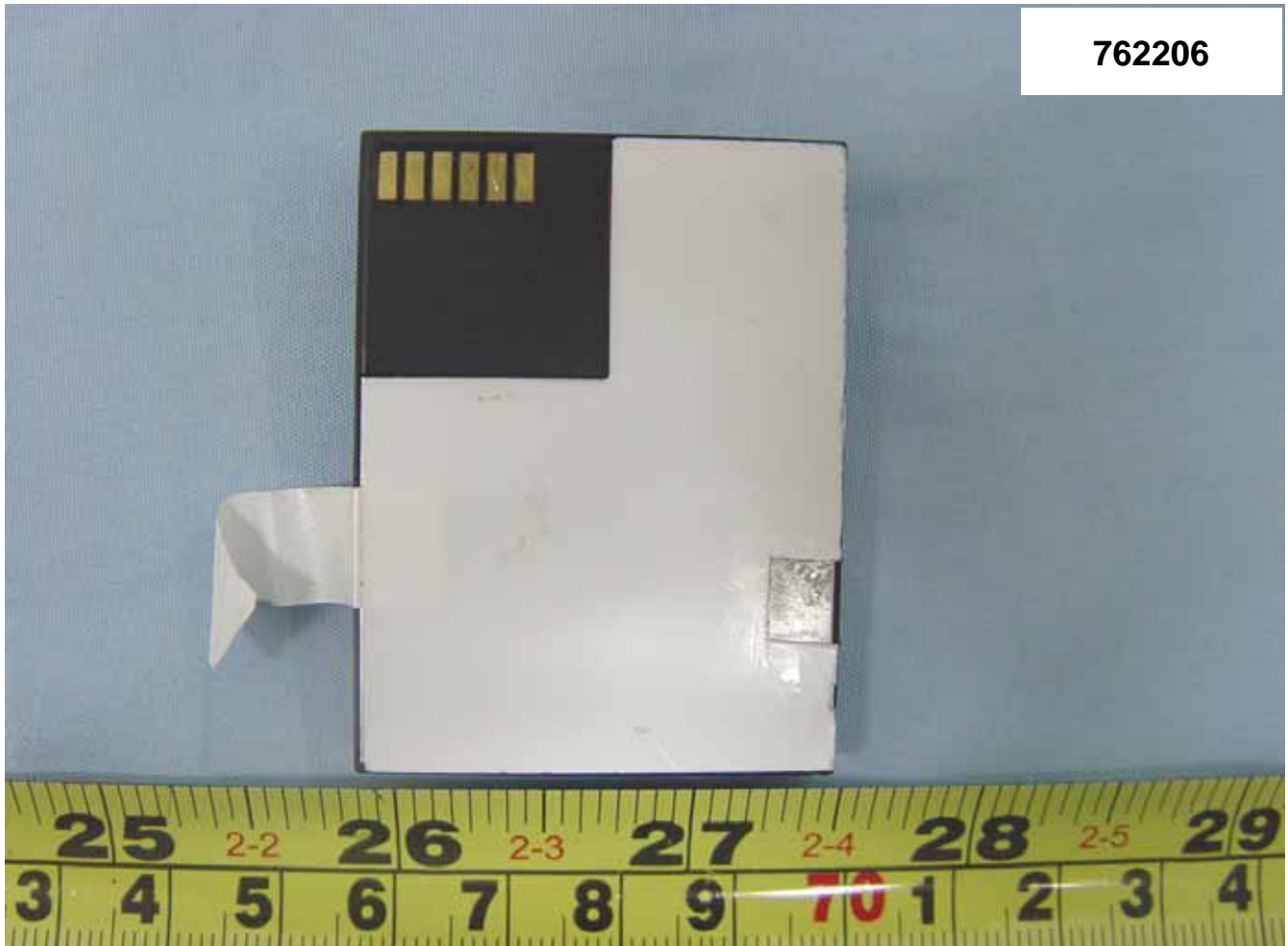



762206





762206





762206





762206





762206







762206





762206





762206





762206



Appendix B. External Photographs of EUT







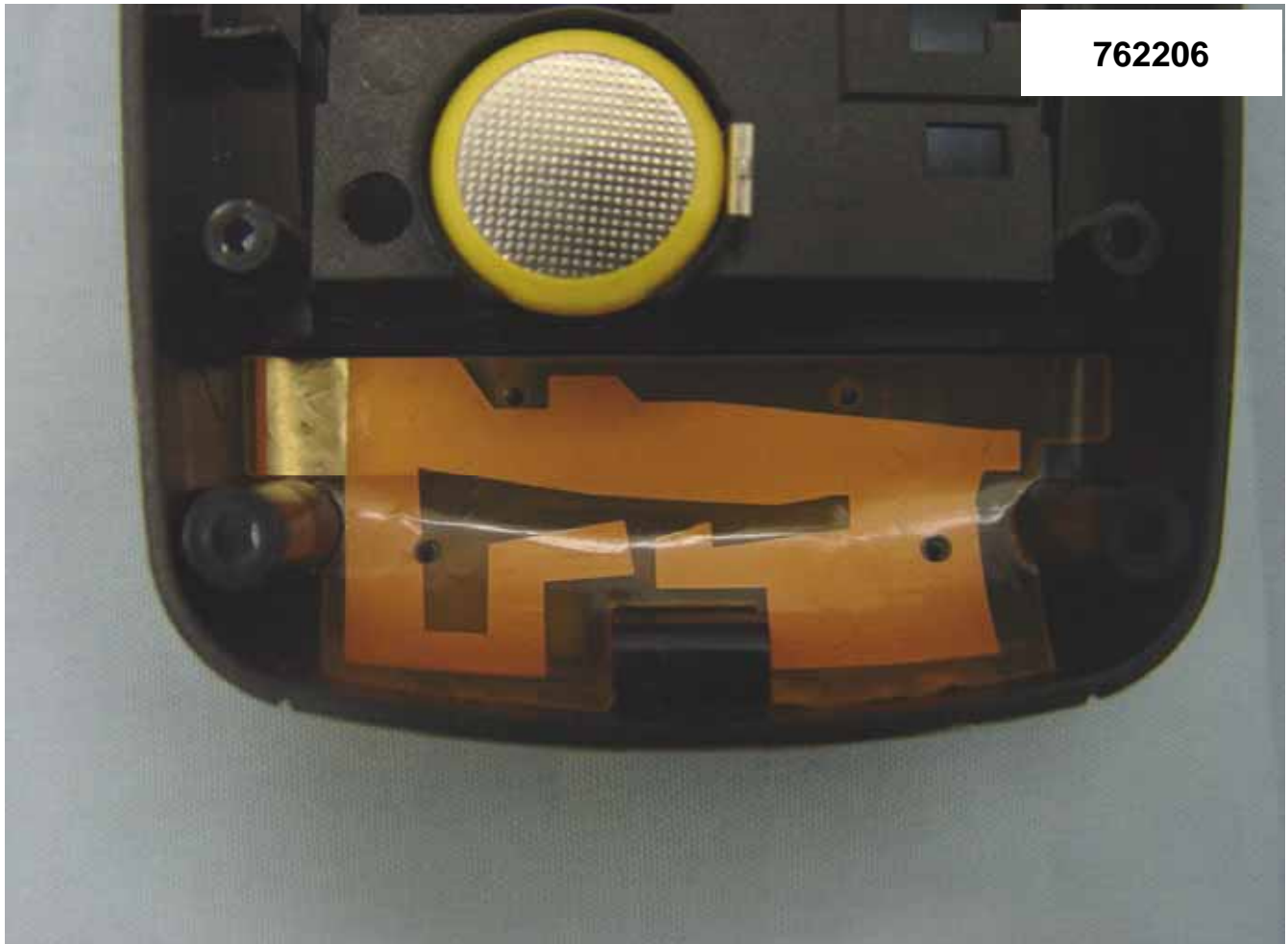

762206

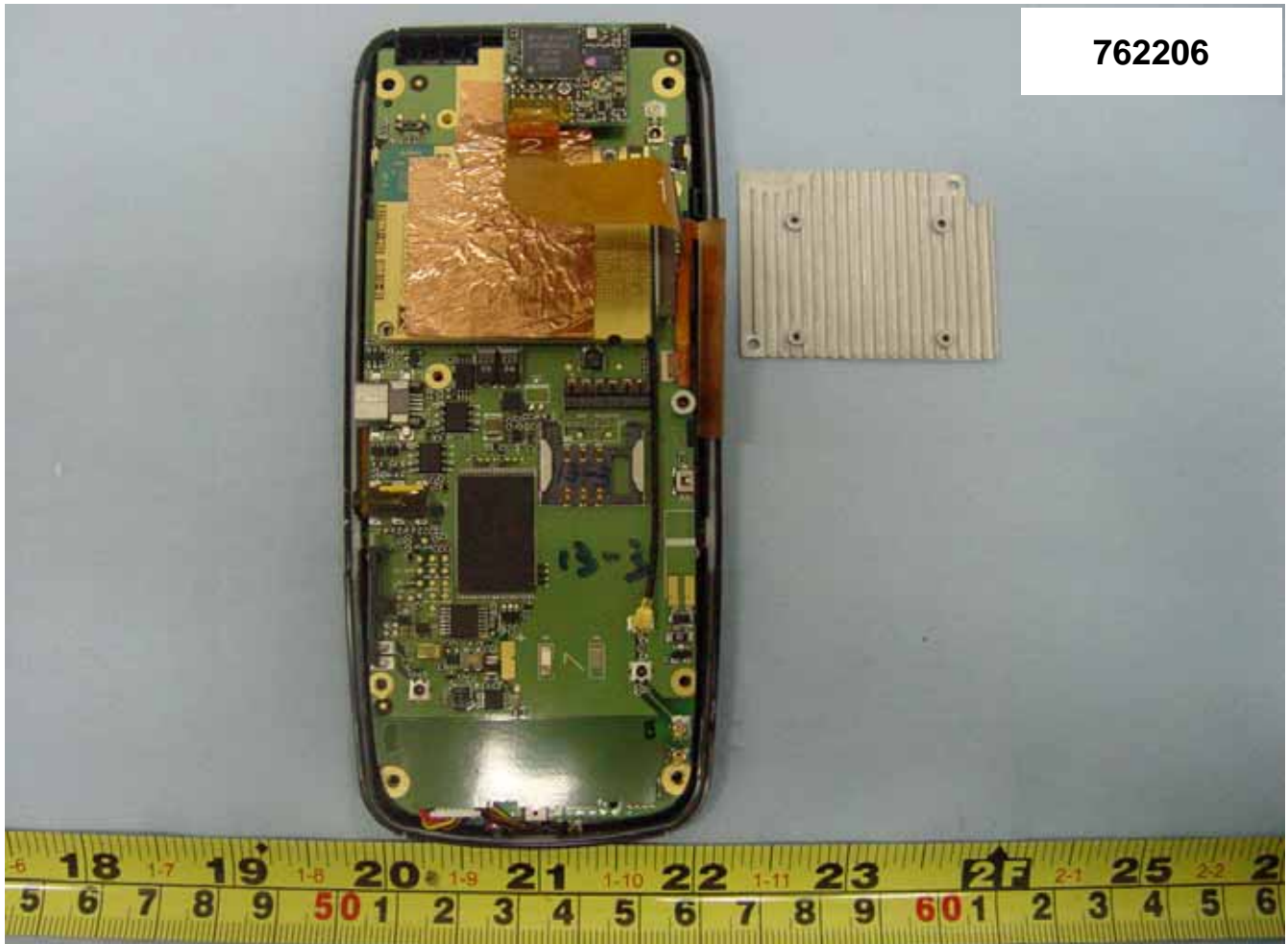



762206









762206





762206

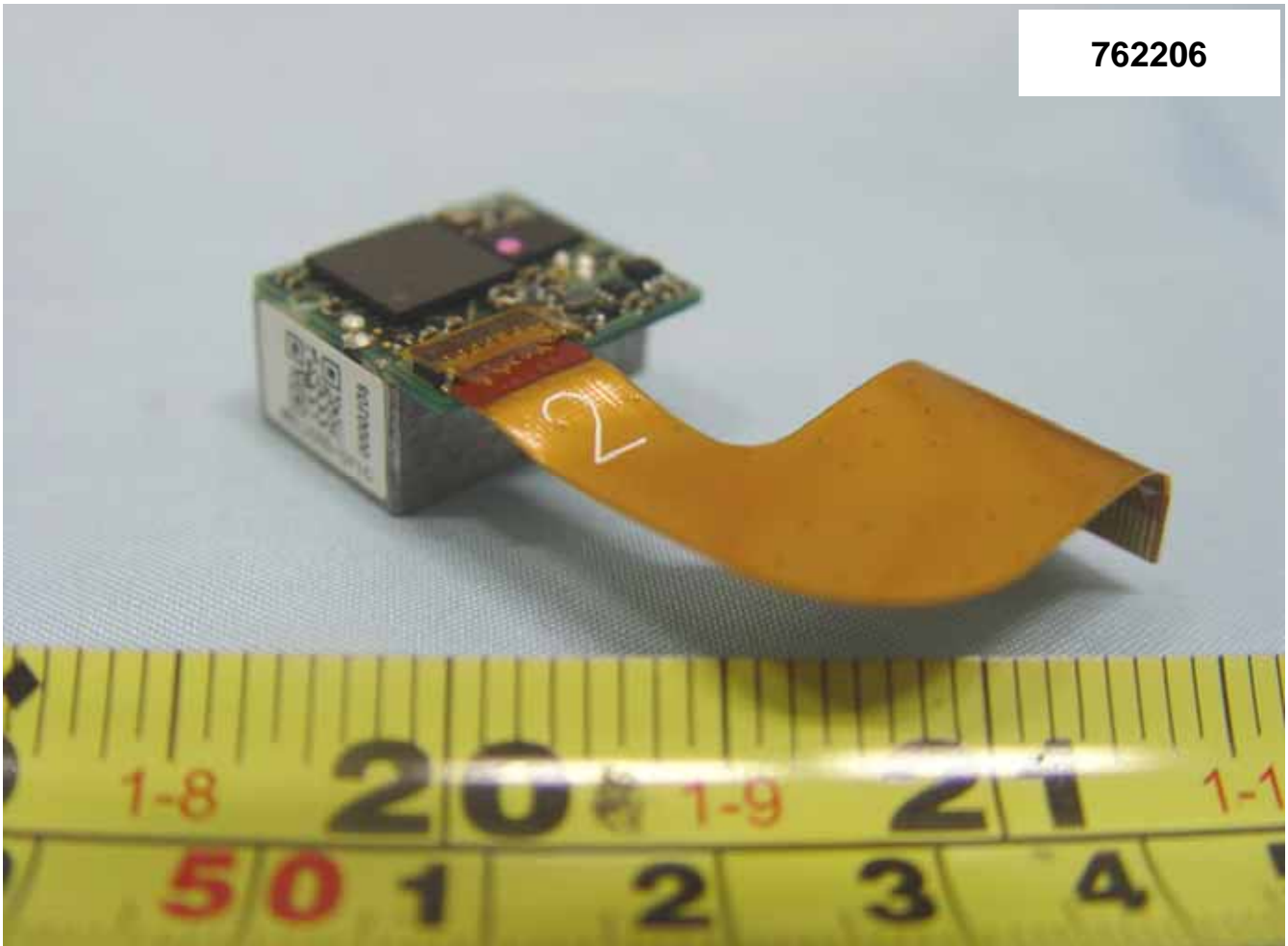



762206





762206

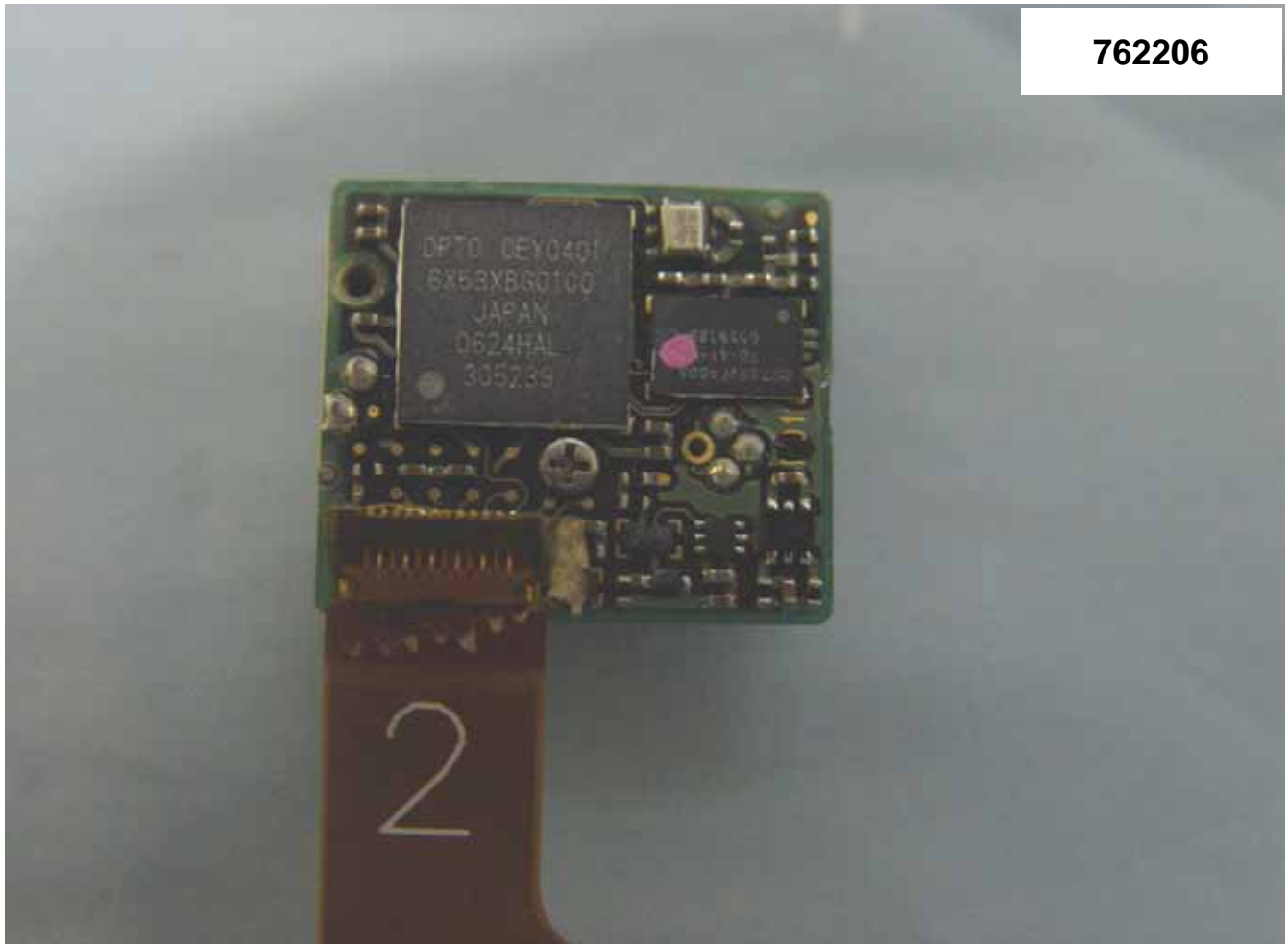



762206

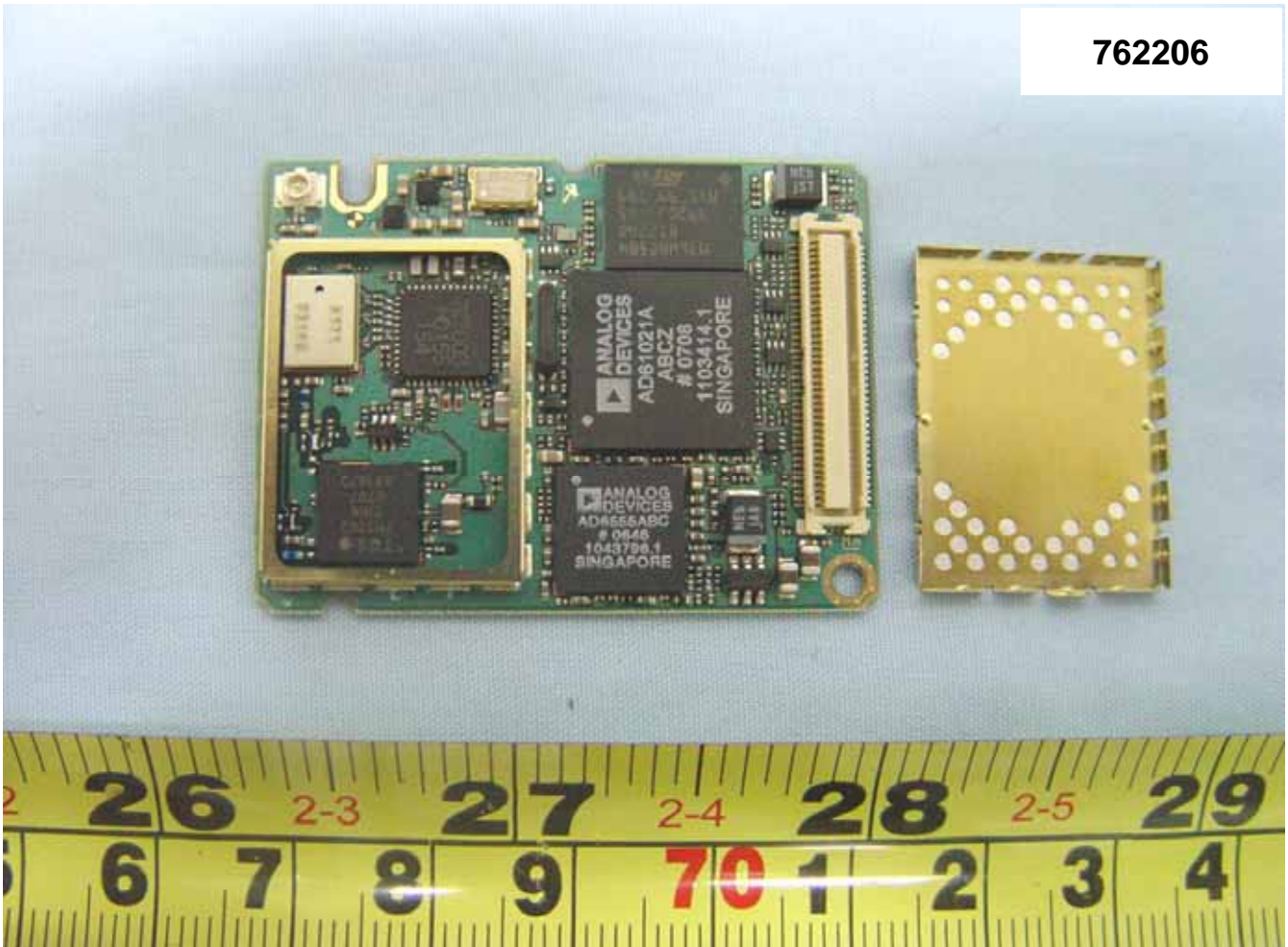



762206

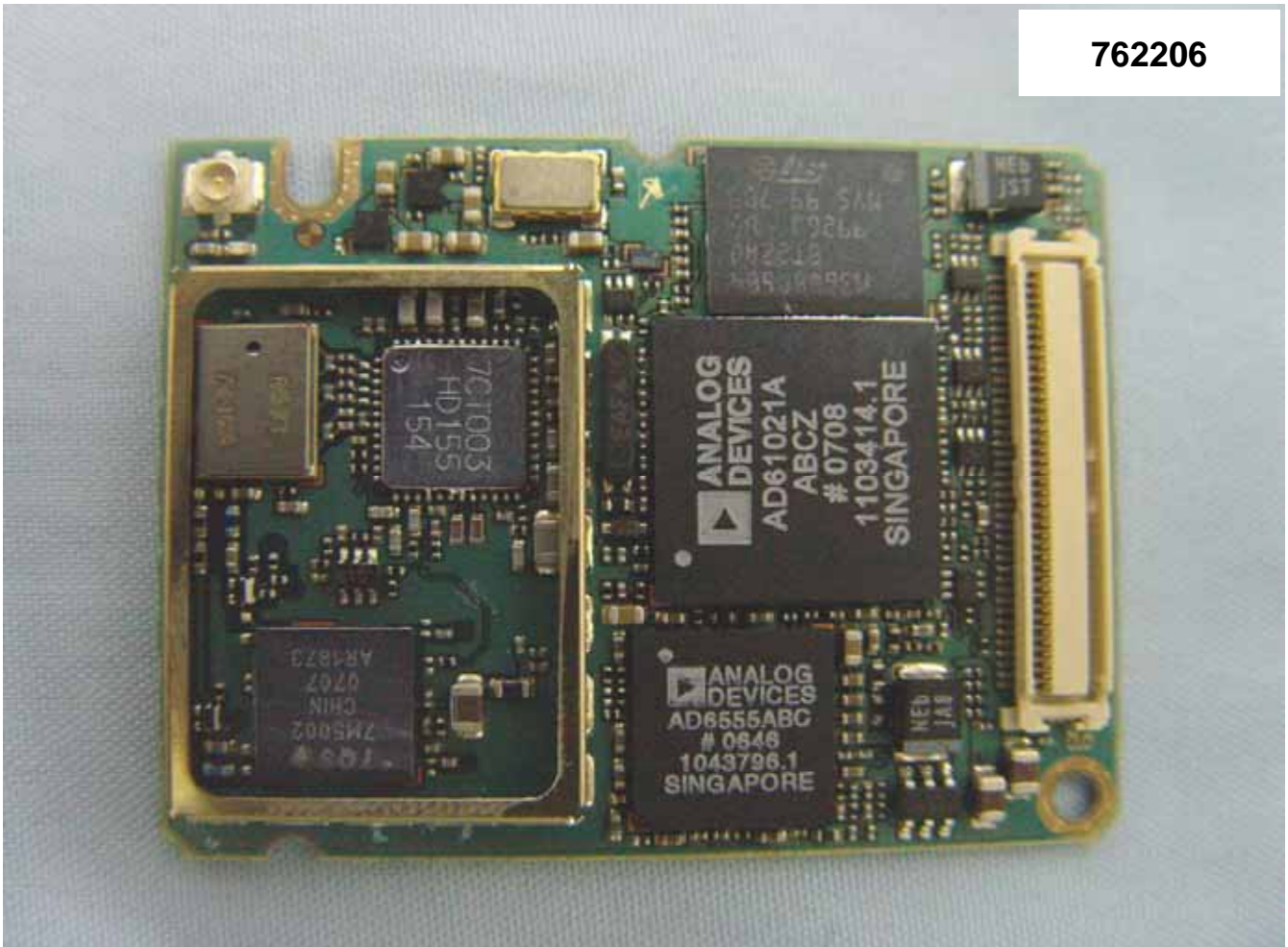

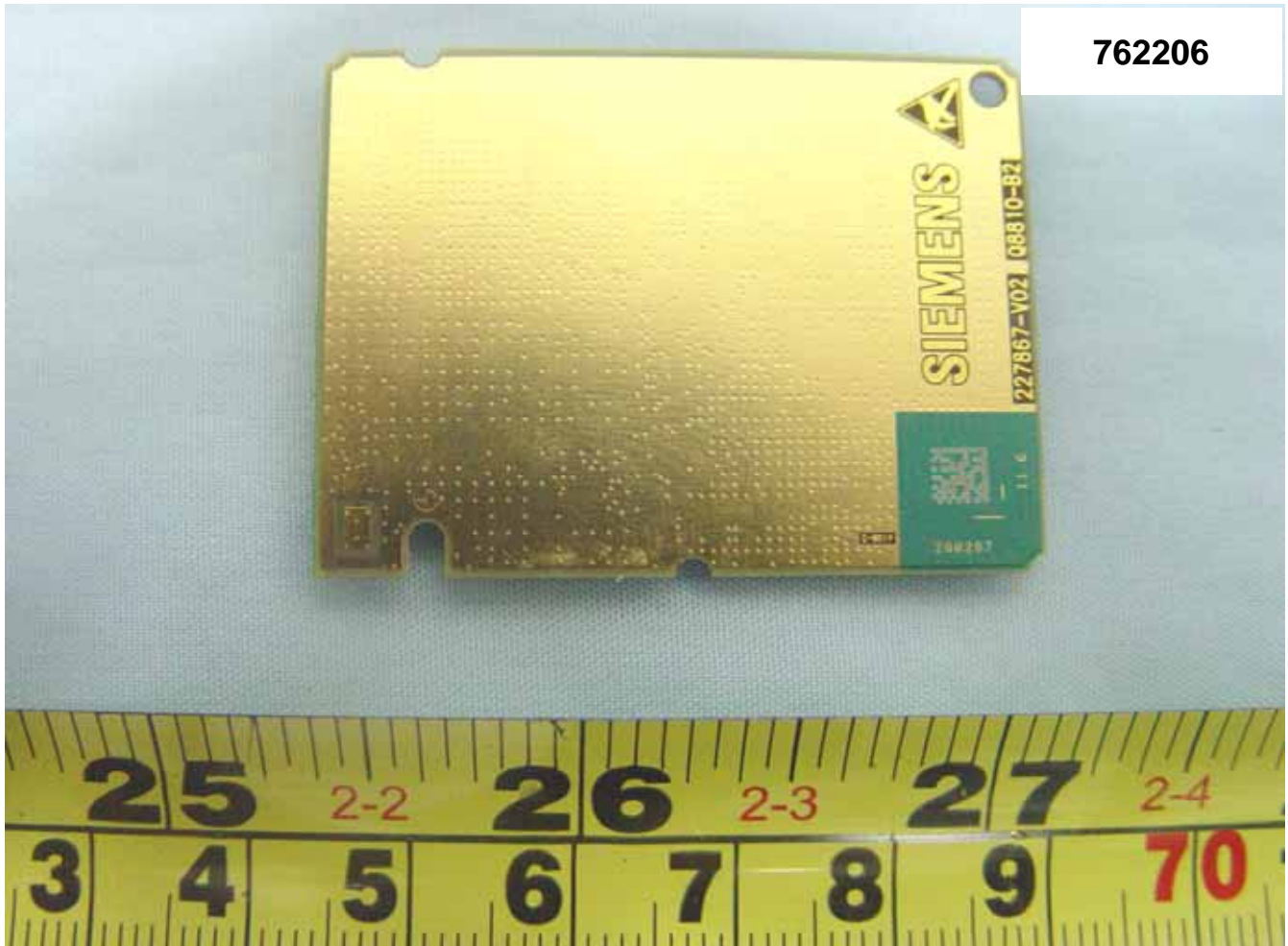

762206

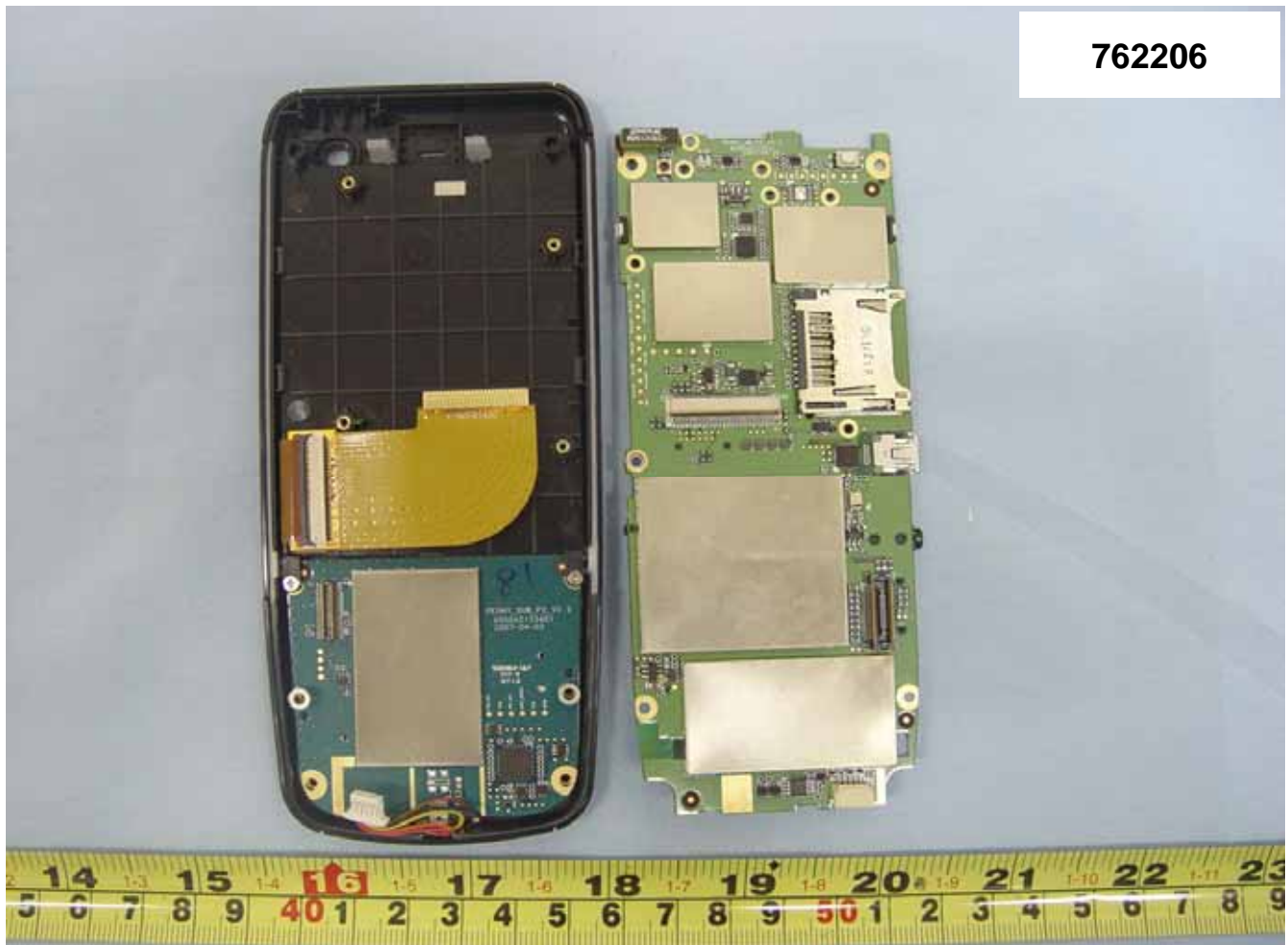

762206

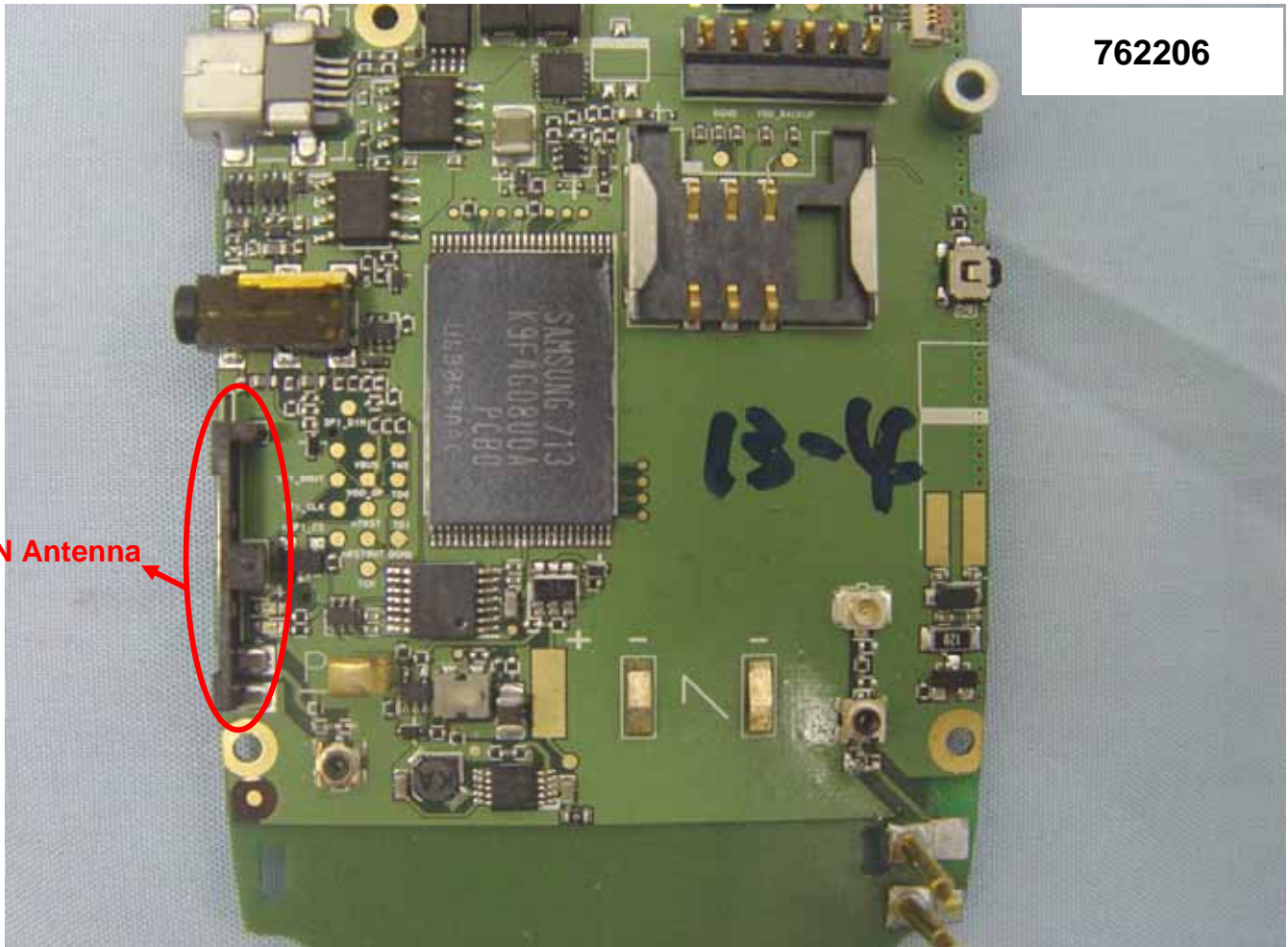

WLAN Antenna

762206

13-4

SAMSUNG 713
K9F4G0800A
PCB0

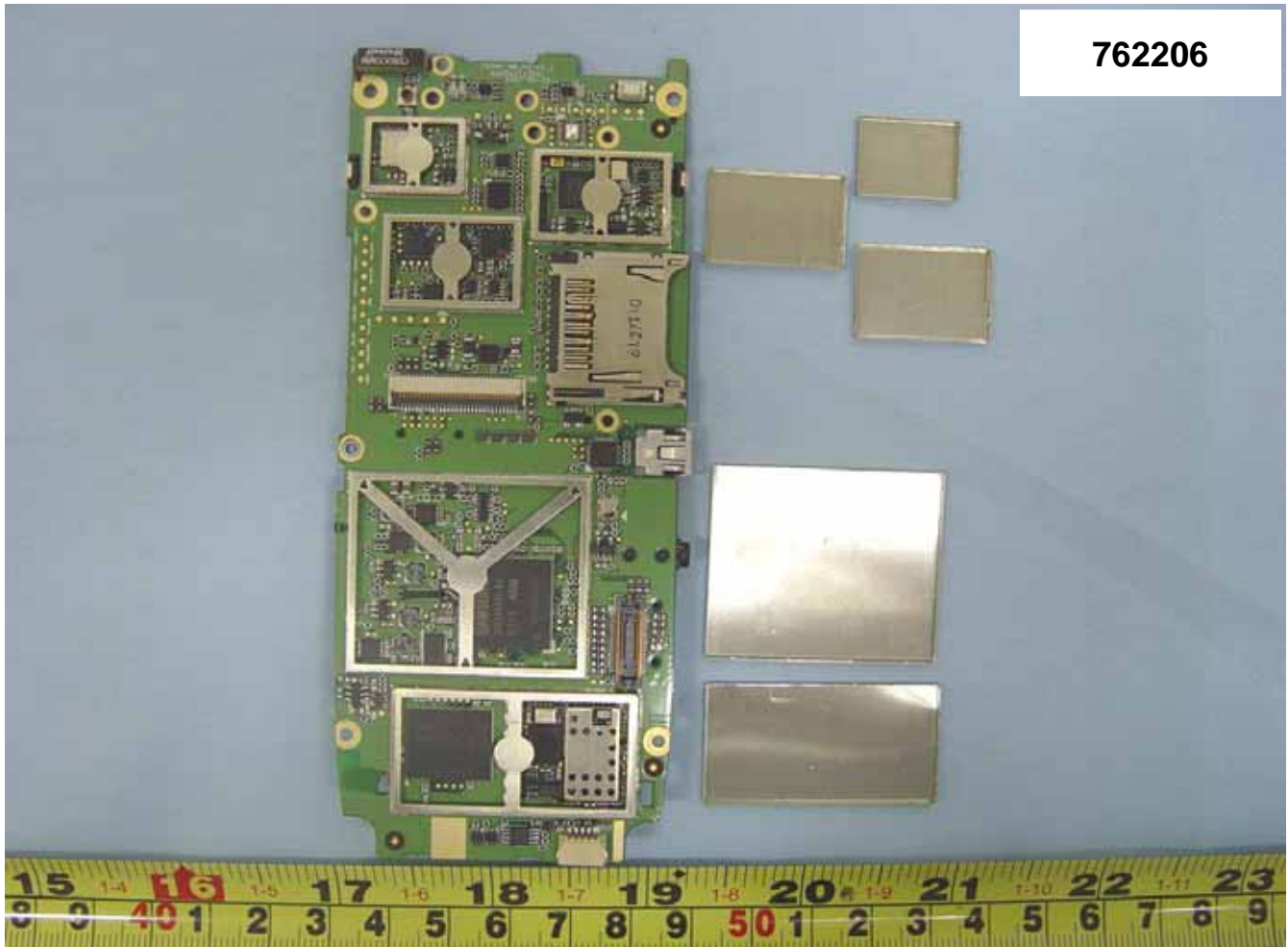



762206

Bluetooth Antenna

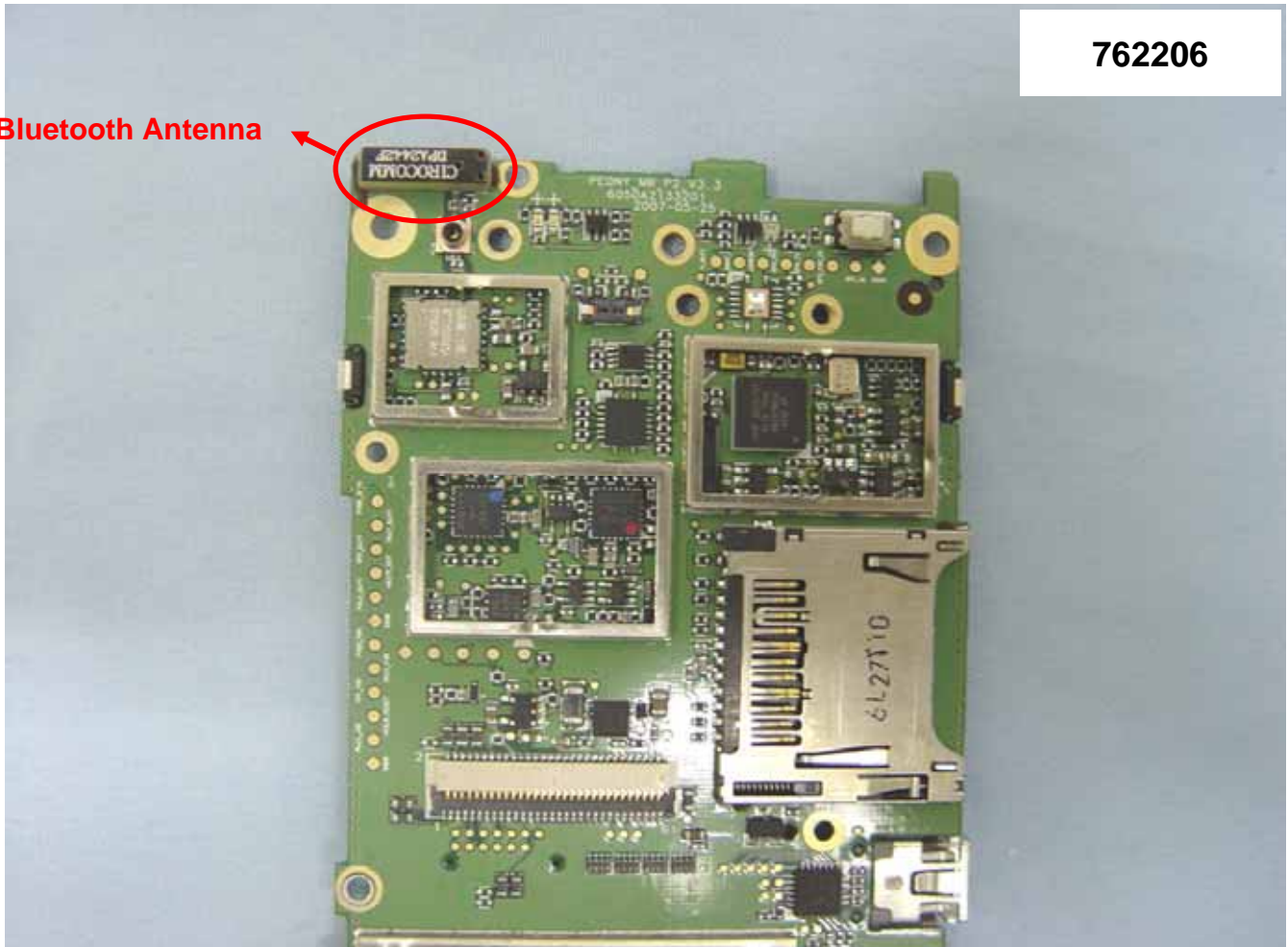
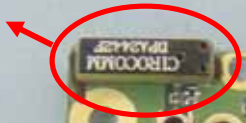

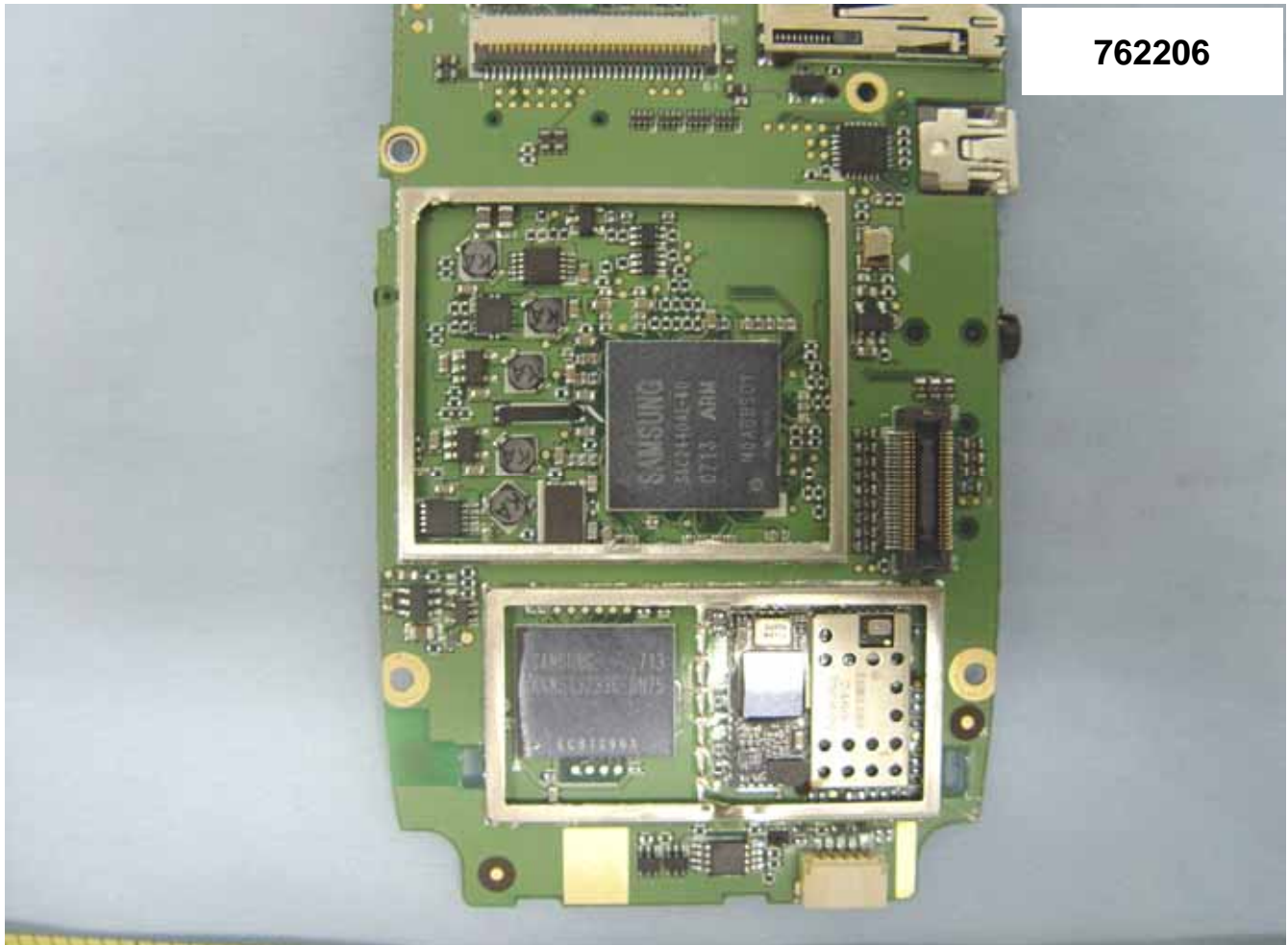

762206





762206

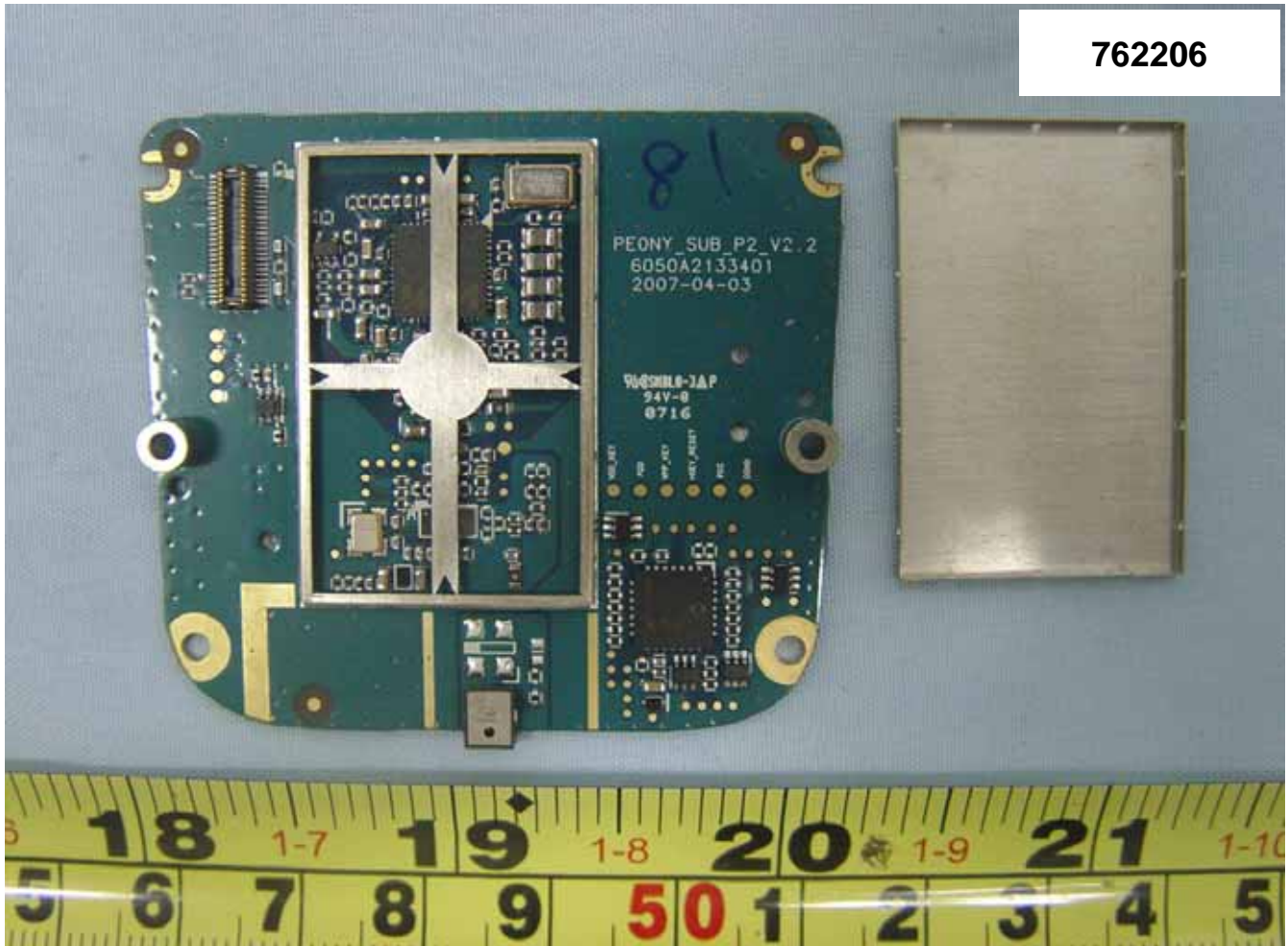



762206

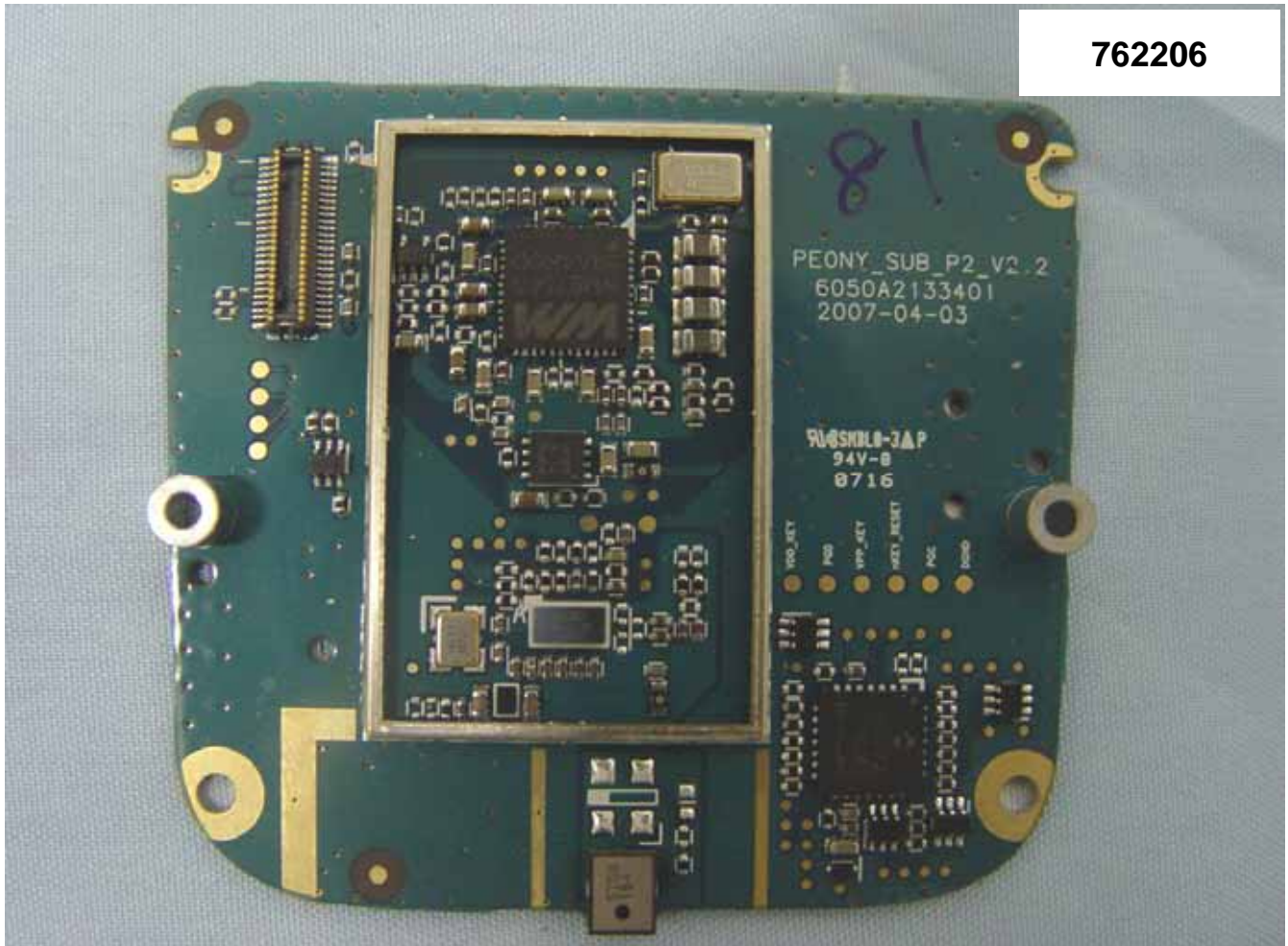



762206

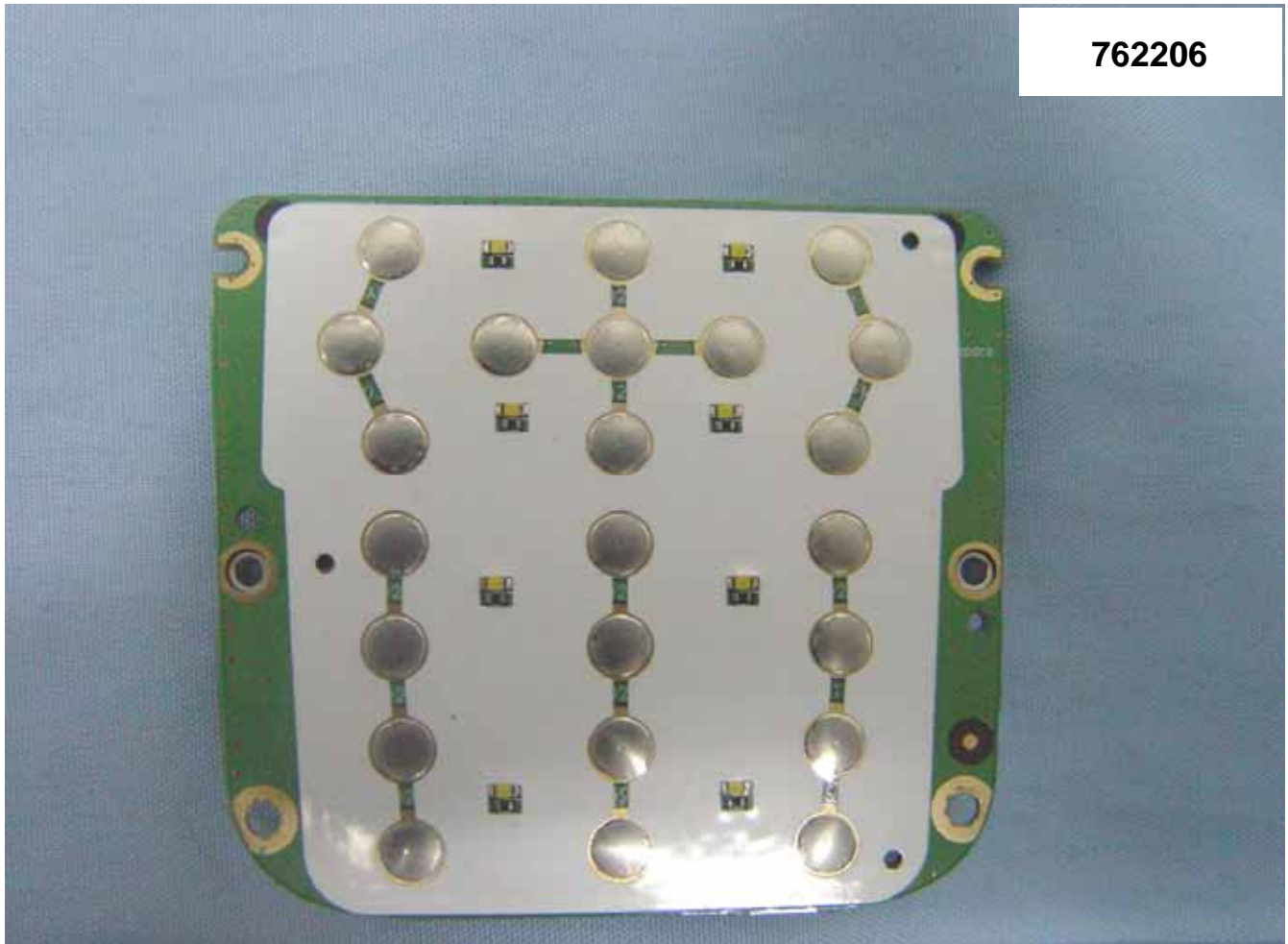



➤ Scanner 2

762206







762206





762206

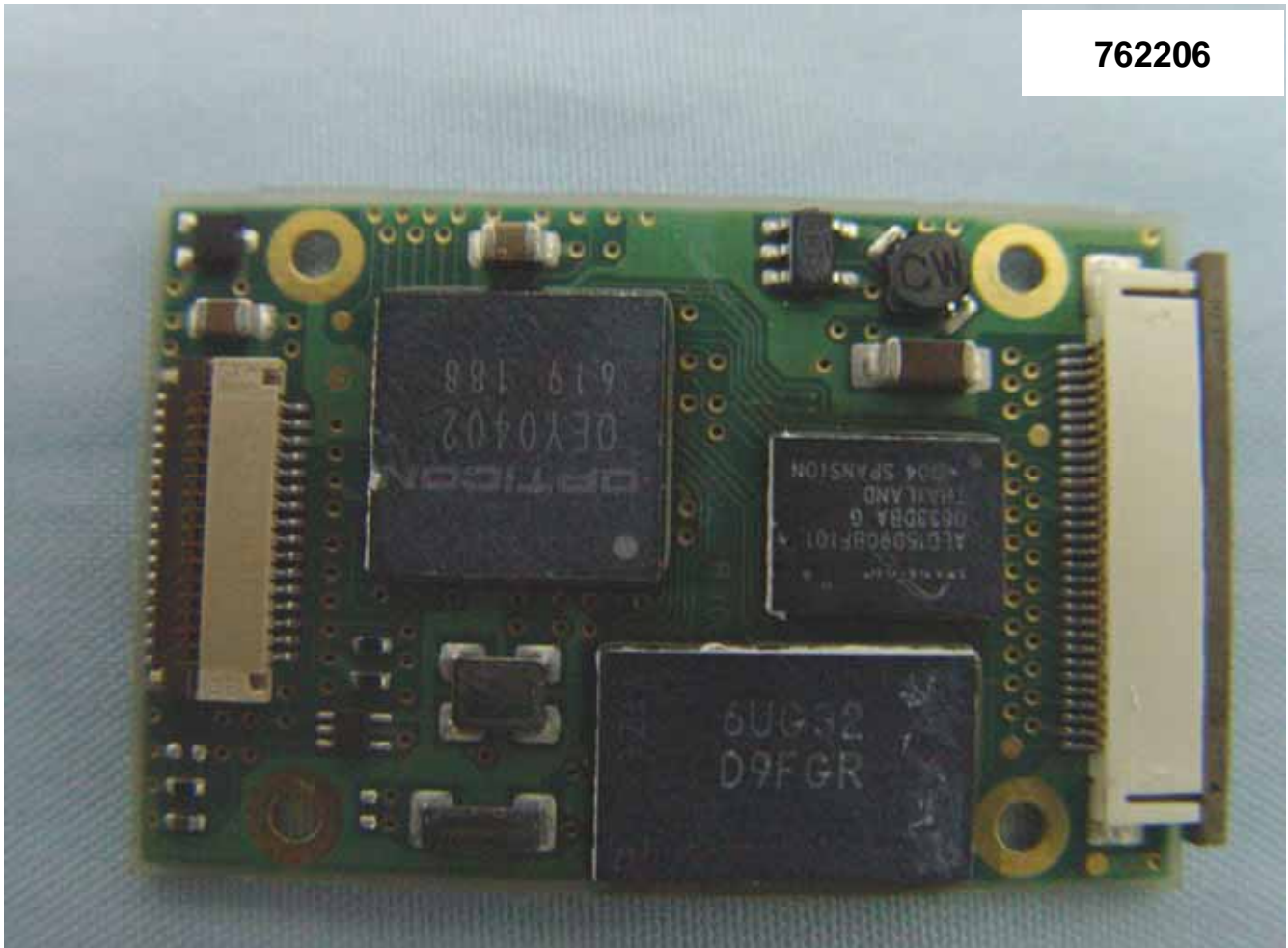

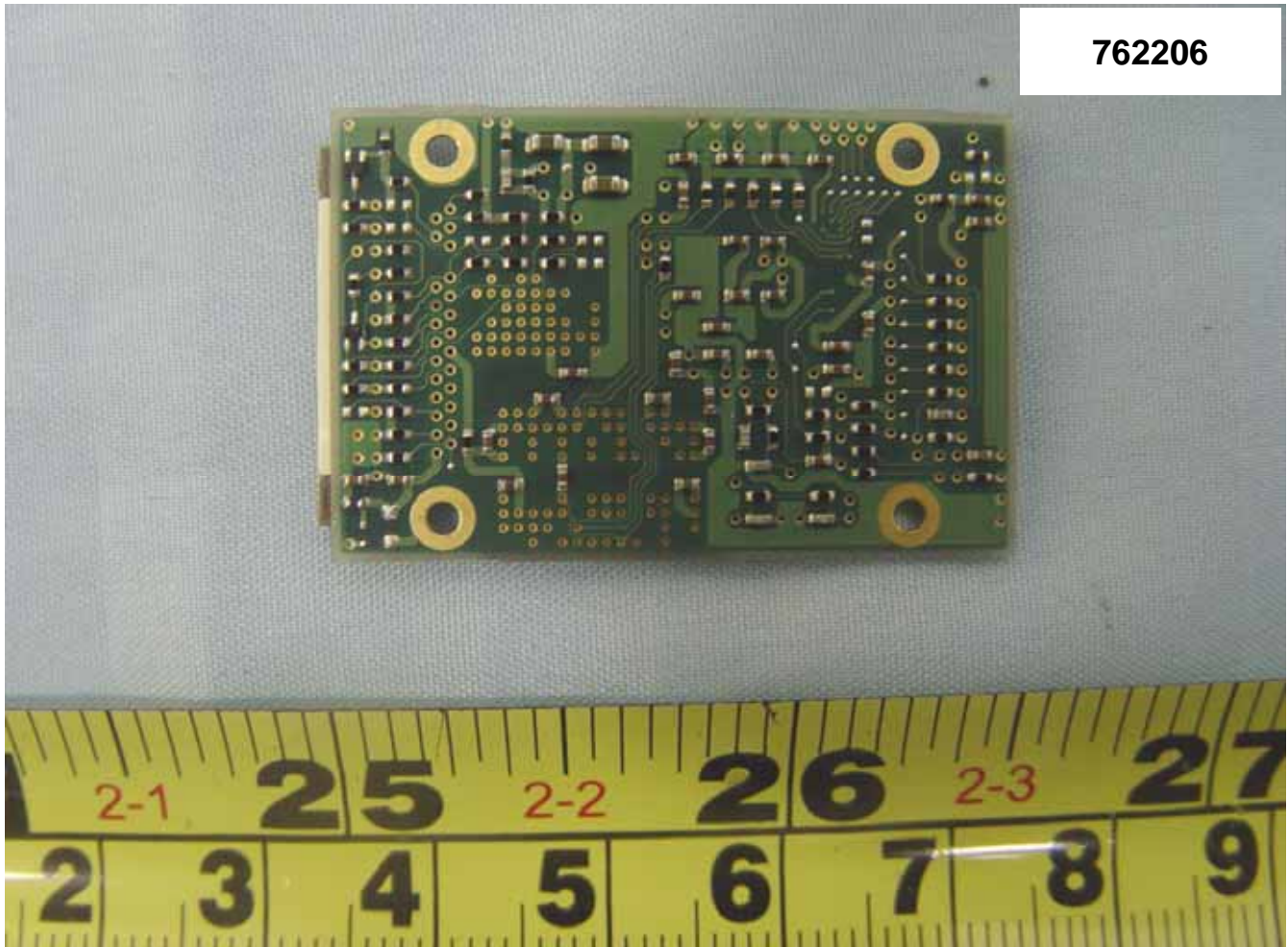



762206



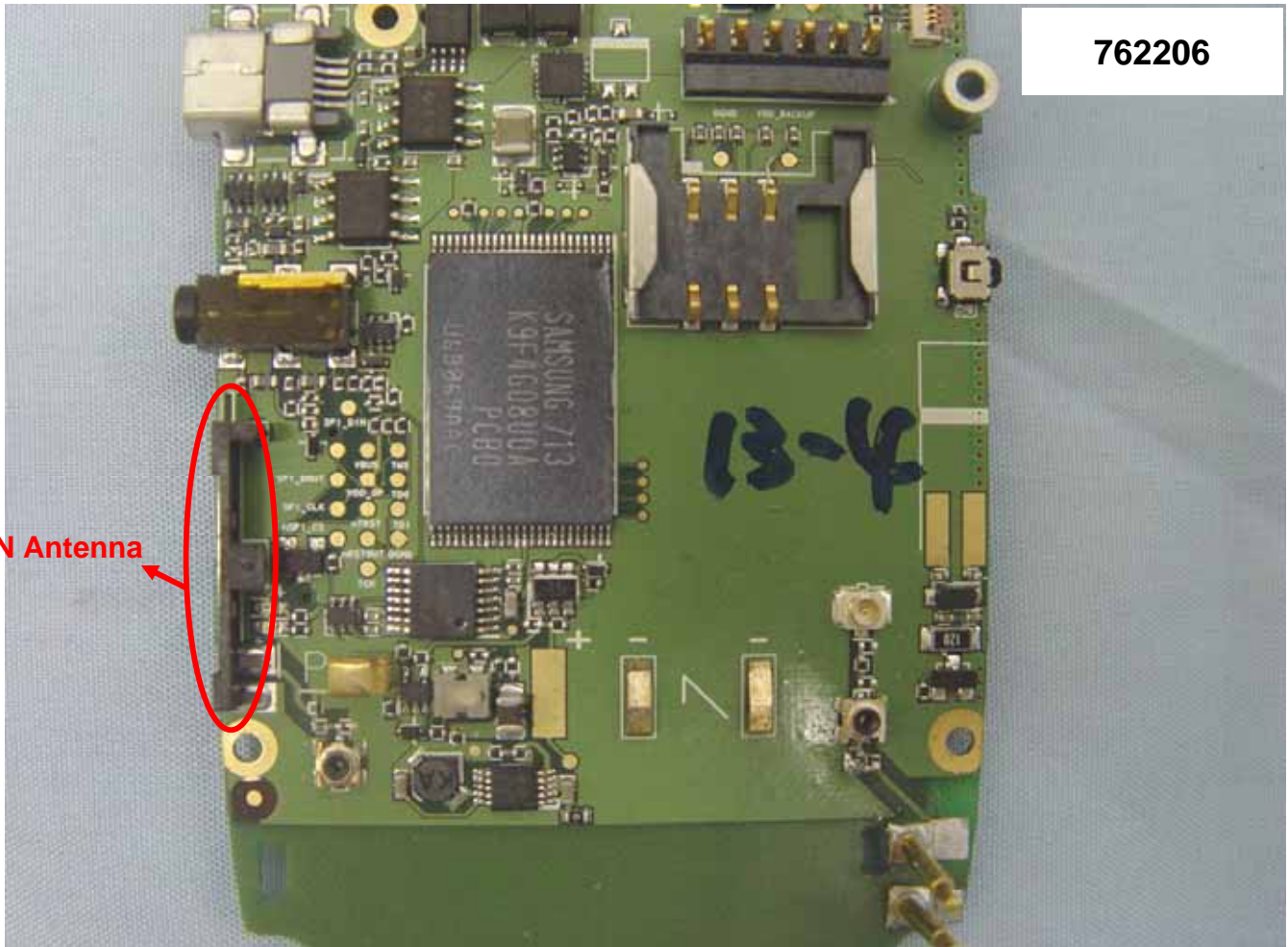

WLAN Antenna

762206

13-4

SAMSUNG 713
K9F4G0800A
PCB0



Bluetooth Antenna



762206

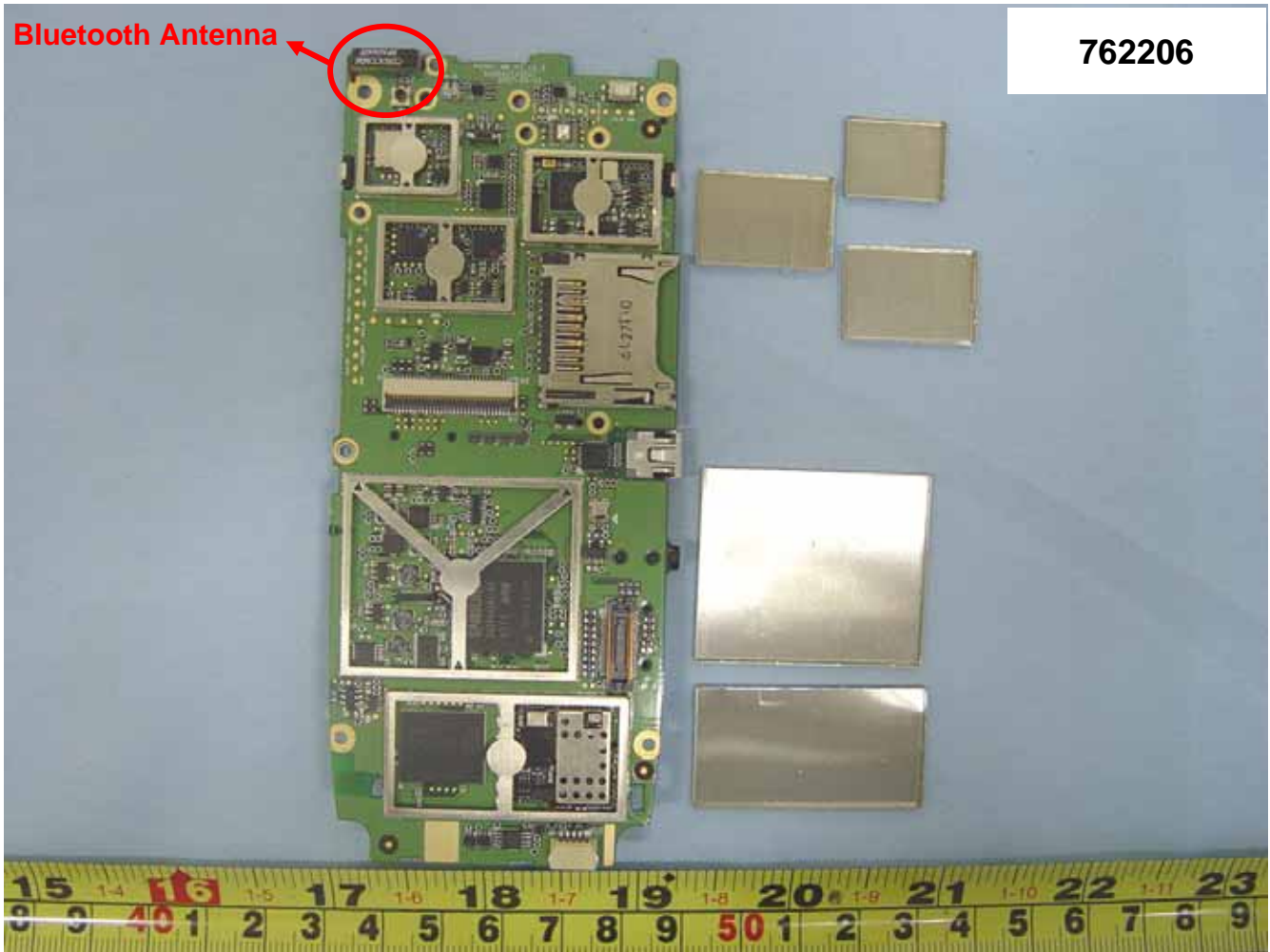



762206

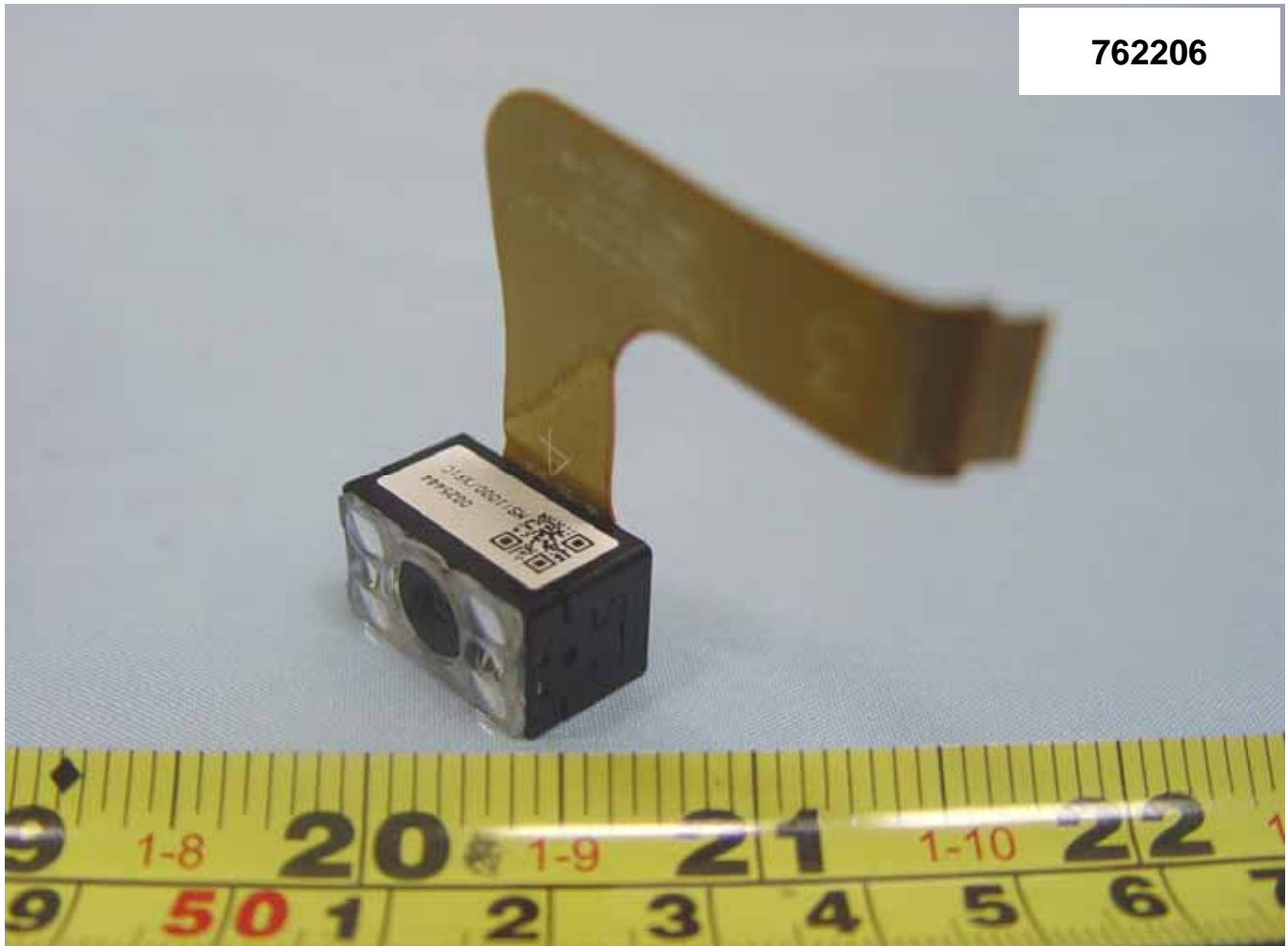



762206

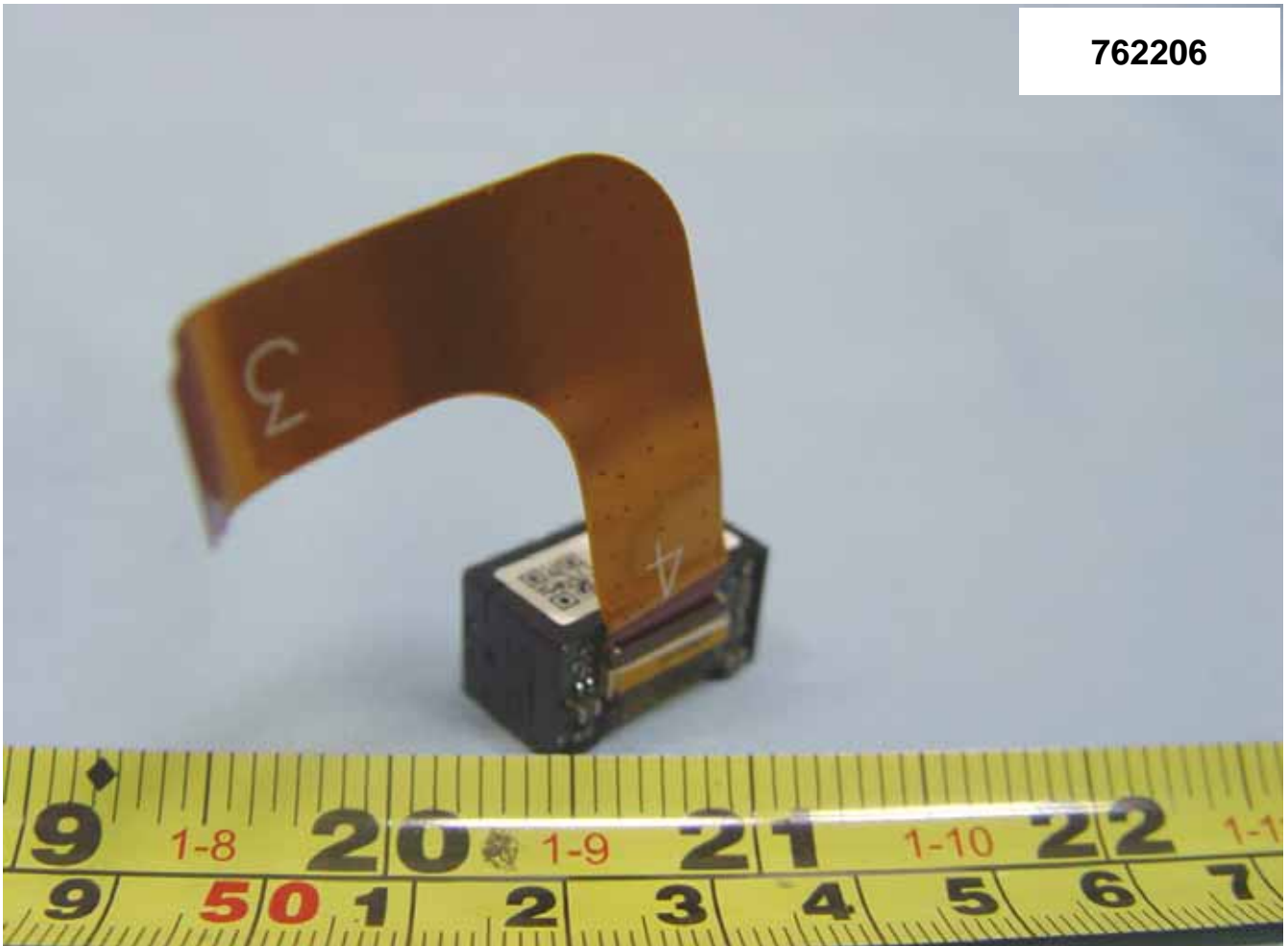





762206



Appendix C. Set up Photograph

Spurious Radiation

Model 1

FRONT VIEW

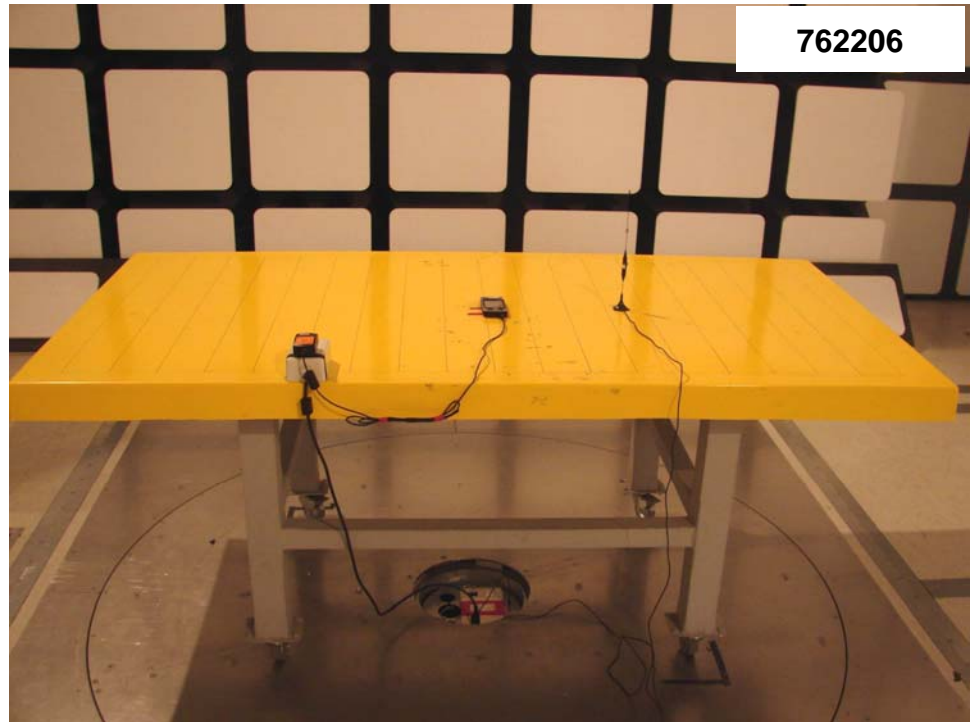

REAR VIEW



**Spurious Radiation
Model 2**

FRONT VIEW

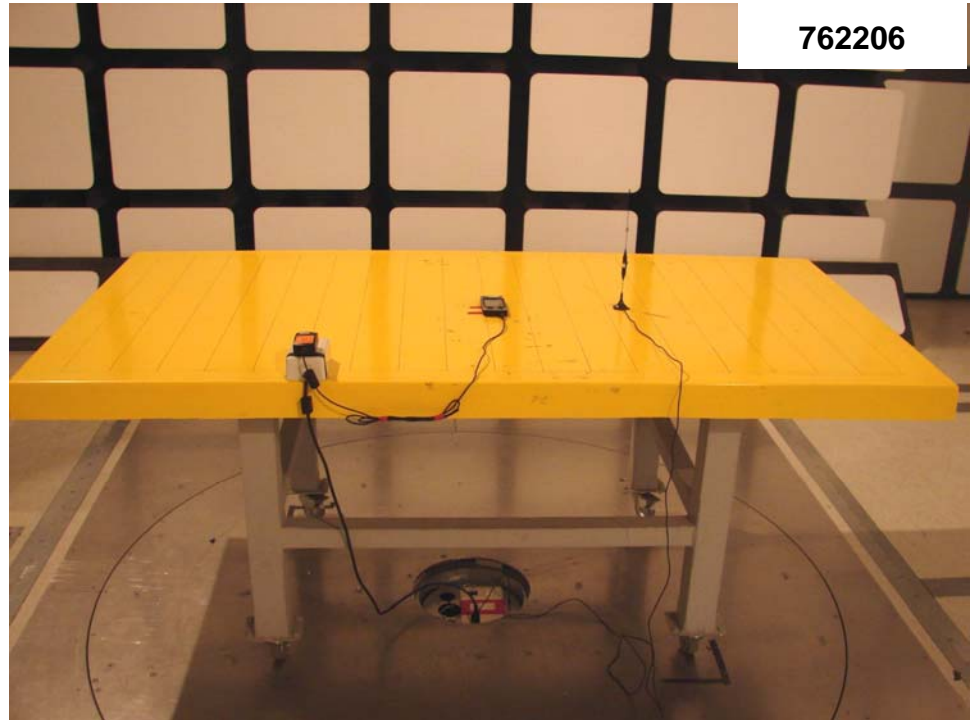

REAR VIEW



**Spurious Radiation
Model 3**

FRONT VIEW

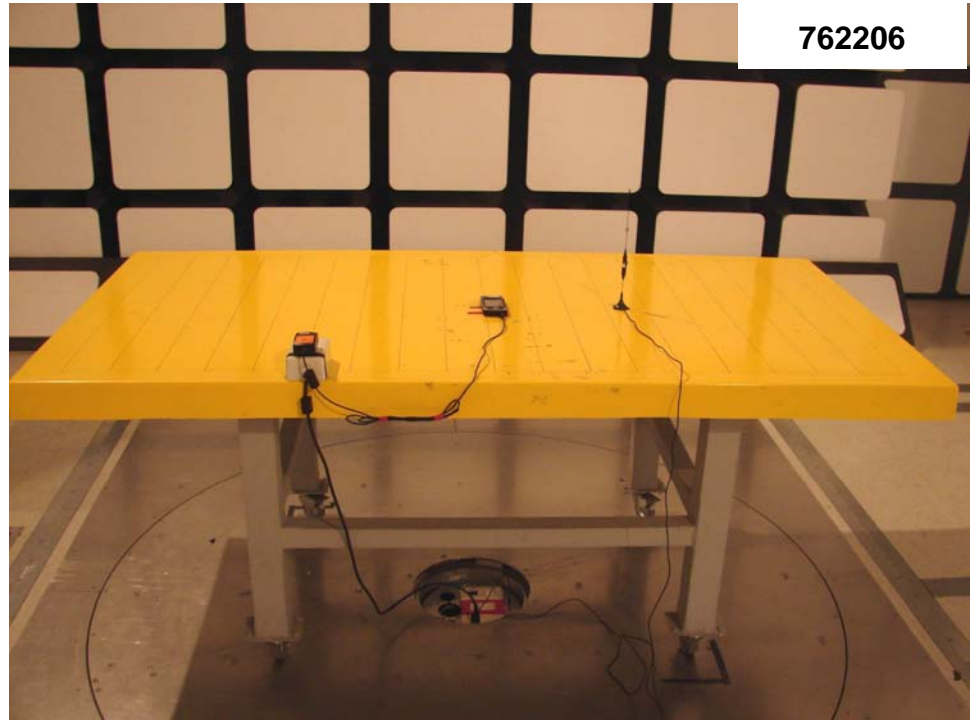

REAR VIEW

