



Specific Absorption Rate (SAR) Test Report
for
OPTOELECTRONICS CO., LTD.
on the
PDA Phone

Report No. : FA762206-2-2-01
Trade Name : Opticon
Model Name : H-19A, H-19B
FCC ID : UFOBC0164AAA390
Date of Testing : Aug. 14, 2007
Date of Report : Aug. 28, 2007
Date of Review : Aug. 28, 2007

- The test results refer exclusively to the presented test model/sample only.
- Without written approval of SPORTON International Inc., the test report shall not be reproduced except in full.
- Report Version: Rev.01.

SPORTON International Inc.

6F, No.106, Sec. 1, Hsin Tai Wu Rd., Hsi Chih, Taipei Hsien, Taiwan, R.O.C.



Table of Contents

- 1. **Statement of Compliance**----- 1
- 2. **Administration Data**----- 2
 - 2.1 Testing Laboratory----- 2
 - 2.2 Detail of Applicant----- 2
 - 2.3 Detail of Manufacturer----- 2
 - 2.4 Application Detail----- 2
- 3. **General Information**----- 3
 - 3.1 Description of Device Under Test (DUT)----- 3
 - 3.2 Applied Standards:----- 4
 - 3.3 Device Category and SAR Limits----- 4
 - 3.4 Test Conditions:----- 4
 - 3.4.1 Ambient Condition----- 4
 - 3.4.2 Test Configuration----- 5
- 4. **Specific Absorption Rate (SAR)**----- 6
 - 4.1 Introduction----- 6
 - 4.2 SAR Definition----- 6
- 5. **SAR Measurement Setup**----- 7
 - 5.1 DASY4 E-Field Probe System----- 8
 - 5.1.1 ET3DV6 E-Field Probe Specification----- 9
 - 5.1.2 ET3DV6 E-Field Probe Calibration----- 9
 - 5.2 DATA Acquisition Electronics (DAE)----- 10
 - 5.3 Robot----- 11
 - 5.4 Measurement Server----- 11
 - 5.5 SAM Twin Phantom----- 11
 - 5.6 Device Holder for SAM Twin Phantom----- 13
 - 5.7 Data Storage and Evaluation----- 14
 - 5.7.1 Data Storage----- 14
 - 5.7.2 Data Evaluation----- 14
 - 5.8 Test Equipment List----- 17
- 6. **Tissue Simulating Liquids**----- 18
- 7. **Uncertainty Assessment**----- 20
- 8. **SAR Measurement Evaluation**----- 22
 - 8.1 Purpose of System Performance check----- 22
 - 8.2 System Setup----- 22
 - 8.3 Validation Results----- 24
- 9. **Description for DUT Testing Position**----- 25
- 10. **Measurement Procedures**----- 27
 - 10.1 Spatial Peak SAR Evaluation----- 27
 - 10.2 Scan Procedures----- 28
 - 10.3 SAR Averaged Methods----- 28
- 11. **SAR Test Results**----- 29
 - 11.1 Right Cheek----- 29
 - 11.2 Right Tilted----- 29
 - 11.3 Left Cheek----- 30
 - 11.4 Left Tilted----- 30
 - 11.5 Keypad Up with 1.5cm Gap----- 31
 - 11.6 Keypad Down with 1.5cm Gap----- 32
 - 11.7 Keypad Up with Holster Touch----- 33
 - 11.8 Keypad Down with Holster Touch----- 34
- 12. **Reference**----- 36
- Appendix A - System Performance Check Data**
- Appendix B - SAR Measurement Data**
- Appendix C - Calibration Data**
- Appendix D - Product Photo**
- Appendix E - Test Setup Photo**



1. Statement of Compliance

The Specific Absorption Rate (SAR) maximum results found during testing for the OPTOELECTRONICS CO., LTD. PDA Phone Opticon H-19A, H-19B are as follows (with expanded uncertainty 20.6%):

DUT Configuration	Position Type	GSM850 (W/kg)	PCS1900 (W/Kg)	802.11b/g (W/Kg)
DUT with Scanner 1	Head	0.263	0.141	0.044
	Body (1.5cm Gap)	0.387	0.236	0.011
	Body (Holster Touch)	0.988	0.728	0.087
DUT with Scanner 2	Head	0.293	0.226	0.035
	Body (1.5cm Gap)	0.539	0.178	0.016
	Body (Holster Touch)	0.991	0.804	0.168
Remark : 1. For scanner 1, the largest summation of GSM/BT and WLAN for Head SAR is 0.307 W/kg and its position is right cheek. 2. For scanner 2, the largest summation of GSM/BT and WLAN for Head SAR is 0.328 W/kg and its position is right cheek. 3. For scanner 1, the largest summation of GSM/GPRS/EDGE/BT and WLAN for body SAR is 0.398 W/kg and its position is keypad down with 1.5cm gap, and body SAR is 0.555 W/kg and its position is keypad down with holster touch. 4. For scanner 2, the largest summation of GSM/GPRS/EDGE/BT and WLAN for body SAR is 1.075 W/kg and its position is keypad down with 1.5cm gap, and body SAR is 1.159 W/kg and its position is keypad down with holster touch.				

The co-location of GSM/GPRS/EDGE/Bluetooth and WLAN were also checked. They are in compliance with Specific Absorption Rate (SAR) for general population/uncontrolled exposure limits specified in FCC 47 CFR part 2 (2.1093) and ANSI/IEEE C95.1-1999 and had been tested in accordance with the measurement methods and procedures specified in OET Bulletin 65 Supplement C (Edition 01-01) and IEEE 1528-2003.

Approved by

Jones Tsai
Manager



2. Administration Data

2.1 Testing Laboratory

Company Name : Sporton International Inc.
Department : Antenna Design/SAR
Address : No.52, Hwa-Ya 1st RD., Hwa Ya Technology Park, Kwei-Shan Hsiang, TaoYuan Hsien, Taiwan, R.O.C.
Telephone Number : 886-3-327-3456
Fax Number : 886-3-328-4978

2.2 Detail of Applicant

Company Name : OPTOELECTRONICS CO., LTD.
Address : 12-17, Tsukagoshi 4-chome, Warabi-shi, Saitama, 335-0002, Japan

2.3 Detail of Manufacturer

Company Name : OPTOELECTRONICS CO., LTD.
Address : 12-17, Tsukagoshi 4-chome, Warabi-shi, Saitama, 335-0002, Japan

2.4 Application Detail

Date of reception of application: Jun. 22, 2007
Start of test : Jul. 08, 2007
End of test : Aug. 14, 2007



3. General Information

3.1 Description of Device Under Test (DUT)

DUT Type :	PDA Phone
Trade Name :	Opticon
Model Name :	H-19A, H-19B
FCC ID :	UFOBC0164AAA390
Tx Frequency :	GSM850 : 824 ~ 849 MHz PCS1900 : 1850 ~ 1910 MHz WLAN / Bluetooth : 2400 ~ 2483.5 MHz
Rx Frequency :	GSM850 : 869 ~ 894 MHz PCS1900 : 1930 ~ 1990 MHz WLAN / Bluetooth : 2400 ~ 2483.5 MHz
HW Version :	V4.4
SW Version :	070601
Type of Modulation :	GSM / GPRS : GMSK EDGE : 8PSK Bluetooth : GFSK WLAN : DSSS / OFDM
Maximum Output Power to Antenna :	<p>Phone with Scanner 1</p> <p>GSM850 : 32.23 dBm (GSM) ; 32.14 dBm (GPRS8) ; 30.37 dBm (GPRS10) 26.77 dBm (GPRS12) ; 26.26 dBm (EDGE8) ; 24.21 dBm (EDGE10) PCS1900 : 29.26 dBm (GSM) ; 29.29 dBm (GPRS8) ; 27.47 dBm (GPRS10) 23.8 dBm (GPRS12) ; 24.8 dBm (EDGE8) ; 22.84 dBm (EDGE10) WLAN : 15.11 dBm (802.11b) ; 13.85 dBm (802.11g) Bluetooth : 2.51 dBm</p> <p>Phone with Scanner 2</p> <p>GSM850 : 32.61 dBm (GSM) ; 32.5 dBm (GPRS8) ; 30.63 dBm (GPRS10) 26.88 dBm (GPRS12) ; 26.23 dBm (EDGE8) ; 24.16 dBm (EDGE10) PCS1900 : 28.29 dBm (GSM) ; 29.22 dBm (GPRS8) ; 27.37 dBm (GPRS10) 23.52 dBm (GPRS12) ; 24.96 dBm (EDGE8) ; 22.91 dBm (EDGE10) WLAN : 15.11 dBm (802.11b) ; 13.85 dBm (802.11g) Bluetooth : 2.51 dBm</p>
Antenna Type :	GSM850 / PCS1900: Fixed Internal Bluetooth: Chip Antenna WLAN: PIFA Antenna
Antenna Gain :	Bluetooth : -3 dBi WLAN : -3 dBi
DUT Stage :	Production Unit
Power Rating :	DC 3.7V
Application Type :	Certification
Accessory :	Battery : OPTICON, H-19 Scanner 1 : OPTOELECTRONICS, MDL-2000 Scanner 2 : OPTOELECTRONICS, MDI-1000 Holster : INV 057-21

Remark : Scanner 1 was used for H-19A, and scanner 2 was used for H-19B.



3.2 Applied Standards:

The Specific Absorption Rate (SAR) testing specification, method and procedure for this PDA Phone is in accordance with the following standards:

- RSS-102 Issued 2 (2005),
- 47 CFR Part 2 (2.1093),
- IEEE C95.1-1999,
- IEEE C95.3-2002,
- IEEE P1528-2003, and
- OET Bulletin 65 Supplement C (Edition 01-01)

3.3 Device Category and SAR Limits

This device belongs to portable device category because its radiating structure is allowed to be used within 20 centimeters of the body of the user.

Limit for General Population/Uncontrolled exposure should be applied for this device, it is 1.6 W/kg as averaged over any 1 gram of tissue.

3.4 Test Conditions:

3.4.1 Ambient Condition

Ambient Temperature (°C)	20-24°C					
Humidity (%)	<60%					
Item	HSL_850 2007/07/08	MSL_850 2007/07/10	HSL_1900 2007/07/08	MSL_1900 2007/07/14	HSL_2450 2007/07/17	MSL_2450 2007/07/17
Tissue simulating liquid temperature (°C)	21.4°C	21.2°C	21.3°C	21.5°C	21.4°C	21.5°C
Item	MSL_850 with holster 2007/08/14	MSL_1900 with holster 2007/08/13	MSL_2450 with holster 2007/08/14			
Tissue simulating liquid temperature (°C)	21.4°C	21.2°C	21.4°C			



3.4.2 Test Configuration

The device was controlled by using a base station emulator R&S CMU200. Communication between the device and the emulator was established by air link. The distance between the DUT and the antenna of the emulator is larger than 50 cm and the output power radiated from the emulator antenna is at least 30 dB smaller than the output power of DUT.

Measurements were performed on the lowest, middle, and highest channel for each testing position for head SAR testing. Measurements were performed only on the middle channel if the SAR is below 3 dB of limit for SAR testing.

The DUT was set from the emulator to radiate maximum output power during all tests.

The data rates for WLAN SAR testing are 11Mbps for 802.11b and 54Mbps for 802.11g. Engineering testing software installed on the EUT can provide continuous transmitting RF signal. This RF signal utilized in SAR measurement has almost 100% duty cycle and its crest factor is 1. The measurements were performed on the lowest, middle, and highest channel, i.e. channel 1, channel 6, and channel 11 for each testing position.

In addition, EUT is in GSM, GPRS/EDGE link mode. In GSM link mode, its crest factor is 8.3. In GPRS/EDGE link mode, its crest factor is 2 and 4, because EUT is GPRS class 12 and EDGE class 10 device.



4. Specific Absorption Rate (SAR)

4.1 Introduction

SAR is related to the rate at which energy is absorbed per unit mass in an object exposed to a radio field. The SAR distribution in a biological body is complicated and is usually carried out by experimental techniques or numerical modeling. The standard recommends limits for two tiers of groups, occupational/controlled and general population/uncontrolled, based on a person's awareness and ability to exercise control over his or her exposure. In general, occupational/controlled exposure limits are higher than the limits for general population/uncontrolled.

4.2 SAR Definition

The SAR definition is the time derivative (rate) of the incremental energy (dW) absorbed by (dissipated in) an incremental mass (dm) contained in a volume element (dv) of a given density (ρ). The equation description is as below:

$$\mathbf{SAR} = \frac{d}{dt} \left(\frac{dW}{dm} \right) = \frac{d}{dt} \left(\frac{dW}{\rho dv} \right)$$

SAR is expressed in units of Watts per kilogram (W/kg)

SAR measurement can be either related to the temperature elevation in tissue by

$$\mathbf{SAR} = C \frac{\delta T}{\delta t}$$

, where C is the specific heat capacity, δT is the temperature rise and δt the exposure duration,

or related to the electrical field in the tissue by

$$\mathbf{SAR} = \frac{\sigma |E|^2}{\rho}$$

, where σ is the conductivity of the tissue, ρ is the mass density of the tissue and E is the rms electrical field strength.

However for evaluating SAR of low power transmitter, electrical field measurement is typically applied.

5. SAR Measurement Setup

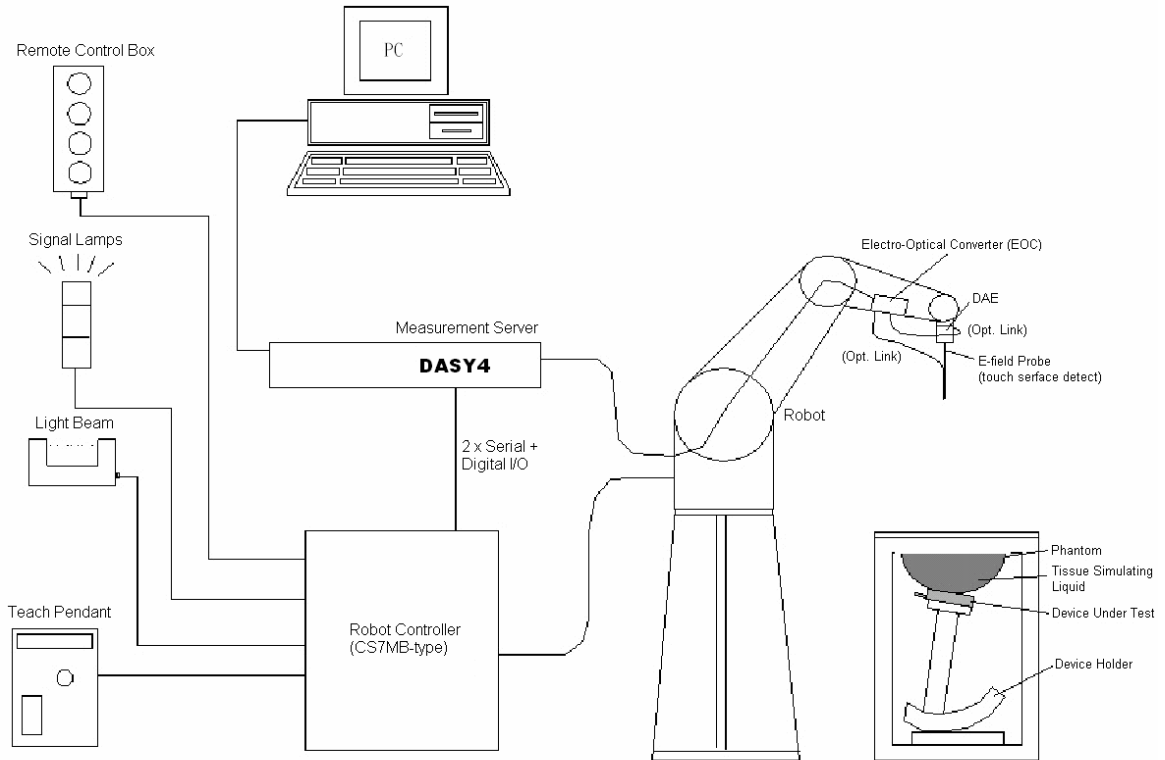

Fig. 5.1 DASY4 system



The DASY4 system for performance compliance tests is illustrated above graphically. This system consists of the following items:

- A standard high precision 6-axis robot with controller, a teach pendant and software
- A data acquisition electronic (DAE) attached to the robot arm extension
- A dosimetric probe equipped with an optical surface detector system
- The electro-optical converter (ECO) performs the conversion between optical and electrical signals
- A measurement server performs the time critical tasks such as signal filtering, control of the robot operation and fast movement interrupts.
- A probe alignment unit which improves the accuracy of the probe positioning
- A computer operating Windows XP
- DASY4 software
- Remote control with teach pendant and additional circuitry for robot safety such as warning lamps, etc.
- The SAM twin phantom
- A device holder
- Tissue simulating liquid
- Dipole for evaluating the proper functioning of the system

Some of the components are described in details in the following sub-sections.

5.1 DASY4 E-Field Probe System

The SAR measurement is conducted with the dosimetric probe ET3DV6 (manufactured by SPEAG). The probe is specially designed and calibrated for use in liquid with high permittivity. The dosimetric probe has special calibration in liquid at different frequency. This probe has a built in optical surface detection system to prevent from collision with phantom.

5.1.1 ET3DV6 E-Field Probe Specification

Construction	Symmetrical design with triangular core Built-in optical fiber for surface detection system Built-in shielding against static charges PEEK enclosure material (resistant to organic solvents)
Calibration	Simulating tissue at frequencies of 900MHz, 1.8GHz and 2.45GHz for brain and muscle (accuracy $\pm 8\%$)
Frequency	10 MHz to > 3 GHz
Directivity	± 0.2 dB in brain tissue (rotation around probe axis) ± 0.4 dB in brain tissue (rotation perpendicular to probe axis)
Dynamic Range	5μ W/g to > 100mW/g; Linearity: ± 0.2 dB
Surface Detection	± 0.2 mm repeatability in air and clear liquids on reflecting surface
Dimensions	Overall length: 330mm Tip length: 16mm Body diameter: 12mm Tip diameter: 6.8mm Distance from probe tip to dipole centers: 2.7mm
Application	General dosimetry up to 3GHz Compliance tests for mobile phones and Wireless LAN Fast automatic scanning in arbitrary phantoms



Fig. 5.2 Probe setup on robot

5.1.2 ET3DV6 E-Field Probe Calibration

Each probe needs to be calibrated according to a dosimetric assessment procedure with accuracy better than $\pm 10\%$. The spherical isotropy shall be evaluated and within ± 0.25 dB. The sensitivity parameters (NormX, NormY, and NormZ), the diode compression parameter (DCP) and the conversion factor (ConvF) of the probe are tested. The calibration data are as below:



➤ **ET3DV6 sn1788**

Sensitivity	X axis : 1.73 μ V		Y axis : 1.67 μ V	Z axis : 1.70 μ V
Diode compression point	X axis : 95 mV		Y axis : 101 mV	Z axis : 93 mV
Conversion factor (Head / Body)	Frequency (MHz)	X axis	Y axis	Z axis
	800~1000	6.60 / 6.33	6.60 / 6.33	6.60 / 6.33
	1710~1910	5.30 / 4.67	5.30 / 4.67	5.30 / 4.67
	2350~2550	4.66 / 4.11	4.66 / 4.11	4.66 / 4.11
Boundary effect (Head / Body)	Frequency (MHz)	Alpha	Depth	
	800~1000	0.49 / 0.45	1.94 / 2.12	
	1710~1910	0.48 / 0.59	2.74 / 2.89	
	2350~2550	0.68 / 0.60	1.96 / 1.70	

NOTE:

- The probe parameters have been calibrated by the SPEAG.

5.2 DATA Acquisition Electronics (DAE)

The data acquisition electronics (DAE) consists of a highly sensitive electrometer-grade preamplifier with auto-zeroing, a channel and gain-switching multiplexer, a fast 16 bit AD-converter and a command decoder and control logic unit. Transmission to the measurement server is accomplished through an optical downlink for data and status information as well as an optical uplink for commands and the clock.

The mechanical probe mounting device includes two different sensor systems for frontal and sideways probe contacts. They are used for mechanical surface detection and probe collision detection.

The input impedance of the DAE is 200M Ohm; the inputs are symmetrical and floating. Common mode rejection is above 80dB.



5.3 Robot

The DASY4 system uses the high precision robots RX90BL type out of the newer series from Stäubli SA (France). For the 6-axis controller DASYS system, the CS7MB robot controller version from Stäubli is used. The RX robot series have many features that are important for our application:

- High precision (repeatability 0.02 mm)
- High reliability (industrial design)
- Jerk-free straight movements
- Low ELF interference (the closed metallic construction shields against motor control fields)
- 6-axis controller

5.4 Measurement Server

The DASY4 measurement server is based on a PC/104 CPU board with
166 MHz CPU
32 MB chipset and
64 MB RAM.

Communication with
the DAE4 electronic box
the 16-bit AD-converter system for optical detection and digital I/O interface.

The measurement server performs all the real-time data evaluation for field measurements and surface detection, controls robot movements and handles safety operations.

5.5 SAM Twin Phantom

The SAM twin phantom is a fiberglass shell phantom with 2mm shell thickness (except the ear region where shell thickness increases to 6mm). It has three measurement areas:

- Left head
- Right head
- Flat phantom

The bottom plate contains three pair of bolts for locking the device holder. The device holder positions are adjusted to the standard measurement positions in the three sections.

A white cover is provided to tap the phantom during off-periods to prevent water evaporation and changes in the liquid parameters.

On the phantom top, three reference markers are provided to identify the phantom position with respect to the robot.

The phantom can be used with the following tissue simulating liquids:

*Water-sugar based liquid

*Glycol based liquids



Fig. 5.3 Top view of twin phantom



Fig. 5.4 Bottom view of twin phantom

5.6 Device Holder for SAM Twin Phantom

The SAR in the Phantom is approximately inversely proportional to the square of the distance between the source and the liquid surface. For a source in 5 mm distance, a positioning uncertainty of $\pm 0.5\text{mm}$ would produce a SAR uncertainty of $\pm 20\%$. An accurate device position is therefore crucial for accurate and repeatable measurement. The position in which the devices must be measured, are defined by the standards.

The DASY device holder is designed to cope with different positions given in the standard. It has two scales for the device rotation (with respect to the body axis) and the device inclination (with respect to the line between the ear reference points). The rotation centers for both scales is the ear reference point (EPR). Thus the device needs no repositioning when changing the angles.

The DASY device holder has been made out of low-loss POM material having the following dielectric parameters: relative permittivity $\epsilon_r=3$ and loss tangent $\delta=0.02$. The amount of dielectric material has been reduced in the closest vicinity of the device, since measurements have suggested that the influence of the clamp on the test results could thus be lowered.



Fig. 5.5 Device Holder



5.7 Data Storage and Evaluation

5.7.1 Data Storage

The DASY4 software stores the assessed data from the data acquisition electronics as raw data (in microvolt readings from the probe sensors), together with all the necessary software parameters for the data evaluation (probe calibration data, liquid parameters and device frequency and modulation data) in measurement files with the extension .DA4. The post-processing software evaluates the desired unit and format for output each time the data is visualized or exported. This allows verification of the complete software setup even after the measurement and allows correction of erroneous parameter settings. For example, if a measurement has been performed with an incorrect crest factor parameter in the device setup, the parameter can be corrected afterwards and the data can be reevaluated.

The measured data can be visualized or exported in different units or formats, depending on the selected probe type (e.g., [V/m], [A/m], [mW/g]). Some of these units are not available in certain situations or give meaningless results, e.g., a SAR-output in a non-loose media, will always be zero. Raw data can also be exported to perform the evaluation with other software packages.

5.7.2 Data Evaluation

The DASY4 post-processing software (SEMCAD) automatically executes the following procedures to calculate the field units from the microvolt readings at the probe connector. The parameters used in the evaluation are stored in the configuration modules of the software :

Probe parameters :	- Sensitivity	$Norm_i, a_{i0}, a_{i1}, a_{i2}$
	- Conversion factor	$ConvF_i$
	- Diode compression point	dcp_i
Device parameters :	- Frequency	f
	- Crest factor	cf
Media parameters :	- Conductivity	σ
	- Density	ρ

These parameters must be set correctly in the software. They can be found in the component documents or they can be imported into the software from the configuration files issued for the DASY components. In the direct measuring mode of the multi-meter option, the parameters of the actual system setup are used. In the scan visualization and export modes, the parameters stored in the corresponding document files are used.

The first step of the evaluation is a linearization of the filtered input signal to account for the compression characteristics of the detector diode. The compensation depends on the input signal, the diode type and the DC-transmission factor from the diode to the evaluation electronics. If the exciting field is pulsed, the crest factor of the signal must be known to correctly compensate for peak power. The formula for each channel can



be given as :

$$V_i = U_i + U_i^2 \cdot \frac{cf}{dcp_i}$$

with $V_i =$ compensated signal of channel i ($i = x, y, z$)
 $U_i =$ input signal of channel i ($i = x, y, z$)
 $cf =$ crest factor of exciting field (DASY parameter)
 $dcp_i =$ diode compression point (DASY parameter)

From the compensated input signals, the primary field data for each channel can be evaluated :

E-field probes : $E_i = \sqrt{\frac{V_i}{Norm_i ConvF}}$

H-field probes : $H_i = \sqrt{V_i \frac{a_{i0} + a_{i1}f + a_{i2}f^2}{f}}$

with $V_i =$ compensated signal of channel i ($i = x, y, z$)
 $Norm_i =$ sensor sensitivity of channel i ($i = x, y, z$)
 $\mu V/(V/m)^2$ for E-field Probes
 $ConvF =$ sensitivity enhancement in solution
 $a_{ij} =$ sensor sensitivity factors for H-field probes
 $f =$ carrier frequency [GHz]
 $E_i =$ electric field strength of channel i in V/m
 $H_i =$ magnetic field strength of channel i in A/m

The RSS value of the field components gives the total field strength (Hermitian magnitude) :

$$E_{tot} = \sqrt{E_x^2 + E_y^2 + E_z^2}$$

The primary field data are used to calculate the derived field units.

$$SAR = E_{tot}^2 \cdot \frac{\sigma}{\rho \cdot 1000}$$

with $SAR =$ local specific absorption rate in mW/g
 $E_{tot} =$ total field strength in V/m
 $\sigma =$ conductivity in [mho/m] or [Siemens/m]
 $\rho =$ equivalent tissue density in g/cm³



* Note that the density is set to 1, to account for actual head tissue density rather than the density of the tissue simulating liquid.

The power flow density is calculated assuming the excitation field to be a free space field.

$$P_{pwe} = \frac{E_{tot}^2}{3770} \quad \text{or} \quad P_{pwe} = H_{tot}^2 \cdot 37.7$$

with P_{pwe} = equivalent power density of a plane wave in mW/cm²
 E_{tot} = total electric field strength in V/m
 H_{tot} = total magnetic field strength in A/m



5.8 Test Equipment List

Manufacture	Name of Equipment	Type/Model	Serial Number	Calibration	
				Last Cal.	Due Date
SPEAG	Dosimetric E-Filed Probe	ET3DV6	1788	Sep. 19, 2006	Sep. 18, 2007
SPEAG	835MHz System Validation Kit	D835V2	499	Mar. 15, 2006	Mar. 14, 2008
SPEAG	1900MHz System Validation Kit	D1900V2	5d041	Mar. 21, 2006	Mar. 20, 2008
SPEAG	2450MHz System Validation Kit	D2450V2	736	Jul. 12, 2007	Jul. 11, 2009
SPEAG	Data Acquisition Electronics	DAE3	577	Nov. 21, 2006	Nov. 20, 2007
SPEAG	Device Holder	N/A	N/A	NCR	NCR
SPEAG	Phantom	QD 000 P40 C	TP-1150	NCR	NCR
SPEAG	Robot	Staubli RX90BL	F03/5W15A1/A/01	NCR	NCR
SPEAG	Software	DASY4 V4.7 Build 53	N/A	NCR	NCR
SPEAG	Software	SEMCAD V1.8 Build 172	N/A	NCR	NCR
SPEAG	Measurement Server	SE UMS 001 BA	1021	NCR	NCR
Agilent	ENA Series Network Analyzer	E5071C	MY46100746	Feb. 21, 2007	Feb. 20, 2008
Agilent	Dielectric Probe Kit	85070D	US01440205	NCR	NCR
Agilent	Dual Directional Coupler	778D	50422	NCR	NCR
Agilent	Power Amplifier	8449B	3008A01917	NCR	NCR
Agilent	Power Meter	E4416A	GB41292344	Feb. 08, 2007	Feb. 07, 2008
Agilent	Power Sensor	E9327A	US40441548	Feb. 08, 2007	Feb. 07, 2008
Agilent	Signal Generator	E8247C	MY43320596	Mar. 01, 2006	Feb. 28, 2008
Agilent	Wireless Communication Test Set	E5515C	GB46311322	Dec. 22, 2006	Dec. 21, 2008

Table 5.1 Test Equipment List

6. Tissue Simulating Liquids

For the measurement of the field distribution inside the SAM phantom with DASY4, the phantom must be filled with around 25 liters of homogeneous tissue simulating liquid. The liquid height from the ear reference point (ERP) of the phantom to the liquid top surface is (head SAR) or from the flat phantom to the liquid top surface (body SAR) is 15.2cm.

The following ingredients for tissue simulating liquid are used:

- **Water:** deionized water (pure H₂O), resistivity $\geq 16M\Omega$ - as basis for the liquid
- **Sugar:** refined sugar in crystals, as available in food shops – to reduce relative permittivity
- **Salt:** pure NaCl – to increase conductivity
- **Cellulose:** Hydroxyethyl-cellulose, medium viscosity (75-125 mPa.s, 2% in water, 20°C), CAS#54290-to increase viscosity and to keep sugar in solution.
- **Preservative:** Preventol D-7 Bayer AG, D-51368 Leverkusen, CAS#55965-84-9- to prevent the spread of bacteria and molds.
- **DGMBE:** Deithlenglycol-monobuthyl ether (DGMBE), Fluka Chemie GmbH, CAS#112-34-5 – to reduce relative permittivity.

Table 6.1 gives the recipes for one liter of head and body tissue simulating liquid for frequency band 1900 MHz.

Ingredient	HSL-850	MSL-850	HSL-1900	MSL-1900	HSL_2450	MSL-2450
Water	532.98 g	631.68 g	552.42 g	716.56 g	450.0 ml	698.3 ml
Cellulose	0 g	0 g	0 g	0 g	0 g	0 g
Salt	18.3 g	11.72 g	3.06 g	4.0 g	0 g	0 g
Preventol D-7	2.4 g	1.2 g	0 g	0 g	0 g	0 g
Sugar	766.0 g	600.0 g	0 g	0 g	0 g	0 g
DGMBE	0 g	0 g	444.52 g	300.67 g	550.0 ml	301.7 ml
Total amount	1 liter (1.3 kg)	1 liter	1 liter (1.0 kg)	1 liter (1.0 kg)	1 liter (1.0 kg)	1 liter (1.0 kg)
Dielectric Parameters at 22°	f = 835 MHz $\epsilon_r = 41.5 \pm 5\%$, $\sigma = 0.90 \pm 5\%$ S/m	f = 835 MHz $\epsilon_r = 55.2 \pm 5\%$, $\sigma = 0.97 \pm 5\%$ S/m	f = 1900 MHz $\epsilon_r = 40.0 \pm 5\%$, $\sigma = 1.4 \pm 5\%$ S/m	f = 1900 MHz $\epsilon_r = 53.3 \pm 5\%$, $\sigma = 1.52 \pm 5\%$ S/m	f = 2450MHz $\epsilon_r = 39.2 \pm 5\%$, σ = 1.8±5% S/m	f = 2450MHz $\epsilon_r = 52.7 \pm 5\%$, σ = 1.95±5% S/m

Table 6.1 Recipes of head and body tissue simulating liquid for band 850 MHz, 1900 MHz and 2450 MHz.

The dielectric parameters of the liquids were verified prior to the SAR evaluation using an Agilent 85070D Dielectric Probe Kit and an Agilent Network Analyzer.



Table 6.2 shows the measuring results for head and muscle simulating liquid.

	Bands	Frequency(MHz)	Permittivity (ϵ_r)	Conductivity (σ)	Measurement Date
Head	GSM850 (824 ~ 849 MHz)	824.2	40.3	0.889	Jul. 08, 2007
		836.4	40.1	0.901	
		848.8	40.0	0.914	
Body	GSM850 (824 ~ 849 MHz)	824.2	55.0	0.960	Jul. 10, 2007
		836.6	54.8	0.972	
		848.8	54.7	0.985	
Head	PCS1900 (1850 ~ 1910 MHz)	1850.2	39.4	1.34	Jul. 08, 2007
		1880.0	39.3	1.37	
		1909.8	39.2	1.40	
Body	PCS1900 (1850 ~ 1910 MHz)	1850.2	53.7	1.45	Jul. 14, 2007
		1880.0	53.7	1.48	
		1909.8	53.6	1.51	
Head	WLAN (2450MHz)	2412	38.6	1.73	Jul. 17, 2007
		2437	38.2	1.74	
		2462	38.0	1.78	
Body	WLAN (2450MHz)	2412	51.5	1.90	Jul. 17, 2007
		2437	51.5	1.92	
		2462	51.4	1.95	
Body	GSM850 (824 ~ 849 MHz)	824.2	54.3	0.956	Aug. 14, 2007
		836.6	54.1	0.969	
		848.8	54.0	0.982	
Body	PCS1900 (1850 ~ 1910 MHz)	1850.2	52.7	1.45	Aug. 14, 2007
		1880.0	52.6	1.48	
		1909.8	52.6	1.52	
Body	WLAN (2450MHz)	2412	51.6	1.91	Aug. 14, 2007
		2437	51.6	1.93	
		2462	51.6	1.95	

Table 6.2

The measuring data are consistent with $\epsilon_r = 41.5 \pm 5\%$ and $\sigma = 0.9 \pm 5\%$ for head GSM 850 band, $\epsilon_r = 55.2 \pm 5\%$ and $\sigma = 0.97 \pm 5\%$ for body GSM 850 band, $\epsilon_r = 40.0 \pm 5\%$, $\sigma = 1.4 \pm 5\%$ for head PCS 1900 band, $\epsilon_r = 53.3 \pm 5\%$, $\sigma = 1.52 \pm 5\%$ for body PCS 1900 band, $\epsilon_r = 39.2 \pm 5\%$, $\sigma = 1.80 \pm 5\%$ for head 2450 band, and $\epsilon_r = 52.7 \pm 5\%$, $\sigma = 1.95 \pm 5\%$ for body 2450 band.



7. Uncertainty Assessment

The component of uncertainty may generally be categorized according to the methods used to evaluate them. The evaluation of uncertainty by the statistical analysis of a series of observations is termed a Type A evaluation of uncertainty. The evaluation of uncertainty by means other than the statistical analysis of a series of observation is termed a Type B evaluation of uncertainty. Each component of uncertainty, however evaluated, is represented by an estimated standard deviation, termed standard uncertainty, which is determined by the positive square root of the estimated variance.

A Type A evaluation of standard uncertainty may be based on any valid statistical method for treating data. This includes calculating the standard deviation of the mean of a series of independent observations; using the method of least squares to fit a curve to the data in order to estimate the parameter of the curve and their standard deviations; or carrying out an analysis of variance in order to identify and quantify random effects in certain kinds of measurement.

A type B evaluation of standard uncertainty is typically based on scientific judgment using all of the relevant information available. These may include previous measurement data, experience and knowledge of the behavior and properties of relevant materials and instruments, manufacture’s specification, data provided in calibration reports and uncertainties assigned to reference data taken from handbooks. Broadly speaking, the uncertainty is either obtained from an outdoor source or obtained from an assumed distribution, such as the normal distribution, rectangular or triangular distributions indicated in Table 7.1

Uncertainty Distributions	Normal	Rectangular	Triangular	U-shape
Multiplying factor ^(a)	1/k ^(b)	1/√3	1/√6	1/√2

(a) standard uncertainty is determined as the product of the multiplying factor and the estimated range of variations in the measured quantity

(b) k is the coverage factor

Table 7.1 Standard Uncertainty for Assumed Distribution

The combined standard uncertainty of the measurement result represents the estimated standard deviation of the result. It is obtained by combining the individual standard uncertainties of both Type A and Type B evaluation using the usual “root-sum-squares” (RSS) methods of combining standard deviations by taking the positive square root of the estimated variances.

Expanded uncertainty is a measure of uncertainty that defines an interval about the measurement result within which the measured value is confidently believed to lie. It is obtained by multiplying the combined standard uncertainty by a coverage factor. Typically, the coverage factor ranges from 2 to 3. Using a coverage factor allows the true value of a measured quantity to be specified with a defined probability within the specified uncertainty range. For purpose of this document, a coverage factor two is used, which corresponds to confidence interval of about 95 %. The DASY4 uncertainty Budget is showed in Table 7.2.



Error Description	Uncertainty Value \pm %	Probability Distribution	Divisor	C_i $1/g$	Standard Unc. (1-g)	v_i or V_{eff}
Measurement System						
Probe Calibration	± 4.8	Normal	1	1	± 4.8	∞
Axial Isotropy	± 4.7	Rectangular	$\sqrt{3}$	$(1-C_p)^{1/2}$	± 1.9	∞
Hemispherical Isotropy	± 9.6	Rectangular	$\sqrt{3}$	$(C_p)^{1/2}$	± 3.9	∞
Boundary Effect	± 1.0	Rectangular	$\sqrt{3}$	1	± 0.6	∞
Linearity	± 4.7	Rectangular	$\sqrt{3}$	1	± 2.7	∞
System Detection Limit	± 1.0	Rectangular	$\sqrt{3}$	1	± 0.6	∞
Readout Electronics	± 1.0	Rectangular	1	1	± 1.0	∞
Response Time	± 0.8	Normal	$\sqrt{3}$	1	± 0.5	∞
Integration time	± 2.6	Rectangular	$\sqrt{3}$	1	± 1.5	∞
RF Ambient Conditions	± 3.0	Rectangular	$\sqrt{3}$	1	± 1.7	∞
Probe Positioner Mech. Tolerance	± 0.4	Rectangular	$\sqrt{3}$	1	± 0.2	∞
Probe Positioning with respect to Phantom Shell	± 2.9	Rectangular	$\sqrt{3}$	1	± 1.7	∞
Extrapolation and Interpolation Algorithms for Max. SAR Evaluation	± 1.0	Rectangular	$\sqrt{3}$	1	± 0.6	∞
Test sample Related						
Test sample Positioning	± 2.9	Normal	1	1	± 2.9	145
Device Holder Uncertainty	± 3.6	Normal	1	1	± 3.6	5
Output Power Variation-SAR drift measurement	± 2.5	Rectangular	$\sqrt{3}$	1	± 1.4	∞
Phantom and Tissue parameters						
Phantom uncertainty(Including shape and thickness tolerances)	± 4.0	Rectangular	$\sqrt{3}$	1	± 2.3	∞
Liquid Conductivity Target tolerance	± 5.0	Rectangular	$\sqrt{3}$	0.64	± 1.8	∞
Liquid Conductivity measurement uncertainty	± 2.5	Normal	1	0.64	± 1.6	∞
Liquid Permittivity Target tolerance	± 5.0	Rectangular	$\sqrt{3}$	0.6	± 1.7	∞
Liquid Permittivity measurement uncertainty	± 2.0	Normal	1	0.6	± 1.2	∞
Combined standard uncertainty					± 10.3	330
Coverage Factor for 95 %		K=2				
Expanded uncertainty (Coverage factor = 2)					± 20.6	

Table 7.2 Uncertainty Budget of DASY

8. SAR Measurement Evaluation

Each DASY system is equipped with one or more system validation kits. These units, together with the predefined measurement procedures within the DASY software, enable the user to conduct the system performance check and system validation. System validation kit includes a dipole, tripod holder to fix it underneath the flat phantom and a corresponding distance holder.

8.1 Purpose of System Performance check

The system performance check verifies that the system operates within its specifications. System and operator errors can be detected and corrected. It is recommended that the system performance check be performed prior to any usage of the system in order to guarantee reproducible results. The system performance check uses normal SAR measurements in a simplified setup with a well characterized source. This setup was selected to give a high sensitivity to all parameters that might fail or vary over time. The system check does not intend to replace the calibration of the components, but indicates situations where the system uncertainty is exceeded due to drift or failure.

8.2 System Setup

In the simplified setup for system evaluation, the DUT is replaced by a calibrated dipole and the power source is replaced by a continuous wave which comes from a signal generator at frequency 835 MHz and 1900 MHz and 2450 MHz. The calibrated dipole must be placed beneath the flat phantom section of the SAM twin phantom with the correct distance holder. The distance holder should touch the phantom surface with a light pressure at the reference marking and be oriented parallel to the long side of the phantom. The equipment setup is shown below:

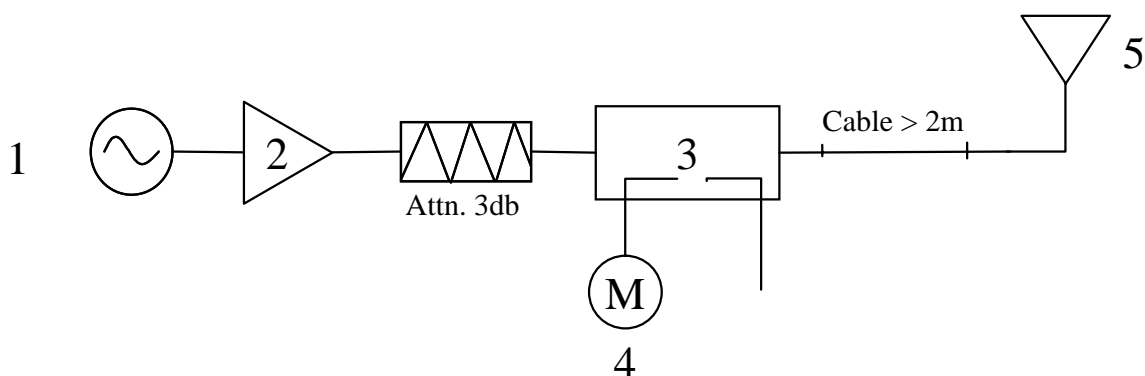

Fig. 8.1 System setup for system Evaluation

1. Signal Generator
2. Amplifier
3. Directional Coupler
4. Power Meter
5. 835 MHz or 1900 MHz or 2450 MHz Dipole

The output power on dipole port must be calibrated to 20dBm (100mW) before dipole is connected.



Fig 8.2 Dipole Setup



8.3 Validation Results

Comparing to the original SAR value provided by Speag, the validation data should be within its specification of 10 %. Table 8.1 shows the target SAR and measured SAR after normalized to 1W input power.

		Target (W/kg)	Measurement data (W/kg)	Variation	Measurement Date
GSM850 Band (835MHz) for head	SAR (1g)	9.24	9.48	2.6 %	Jul. 08, 2007
	SAR (10g)	6.07	6.28	3.5 %	
GSM850 Band (835MHz) for body	SAR (1g)	9.91	9.58	-3.3 %	Jul. 10, 2007
	SAR (10g)	6.55	6.31	-3.7 %	
PCS Band (1900MHz) for head	SAR (1g)	38.4	36.4	-5.2 %	Jul. 08, 2007
	SAR (10g)	20.5	19.6	-4.4 %	
PCS Band (1900MHz) for body	SAR (1g)	41.1	37.5	-8.8 %	Jul. 14, 2007
	SAR (10g)	21.8	20.1	-7.8 %	
WLAN (2450 MHz) for head	SAR (1g)	52.7	54	2.5 %	Jul. 17, 2007
	SAR (10g)	24.5	25.5	4.1 %	
WLAN (2450 MHz) for body	SAR (1g)	52.5	53.4	1.7 %	Jul. 17, 2007
	SAR (10g)	24.4	24.9	2.0 %	
GSM850 Band (835MHz) for body	SAR (1g)	9.91	9.55	-3.6 %	Aug. 14, 2007
	SAR (10g)	6.55	6.29	-4.0 %	
PCS Band (1900MHz) for body	SAR (1g)	41.1	37.6	-8.5 %	Aug. 13, 2007
	SAR (10g)	21.8	20.2	-7.3 %	
WLAN (2450 MHz) for body	SAR (1g)	52.5	56.2	7.0 %	Aug. 14, 2007
	SAR (10g)	24.4	26.2	7.4 %	

Table 8.1 Target and Measured SAR after Normalized

The table above indicates the system performance check can meet the variation criterion.



9. Description for DUT Testing Position

This DUT was tested in 6 different positions. They are left cheek, left tilted, right cheek, right tilted, body worn with keypad up and body worn with keypad down as illustrated below:

- 1) “Cheek Position”
 - i) To position the device with the vertical center line of the body of the device and the horizontal line crossing the center piece in a plane parallel to the sagittal plane of the phantom. While maintaining the device in this plane, align the vertical center line with the reference plane containing the three ear and mouth reference point (M, RE and LE) and align the center of the ear piece with the line RE-LE.
 - ii) To move the device towards the phantom with the ear piece aligned with the line LE-RE until the phone touched the ear. While maintaining the device in the reference plane and maintaining the phone contact with the ear, move the bottom of the phone until any point on the front side is in contact with the cheek of the phantom or until contact with the ear is lost (see Fig. 9.1).
- 2) “Tilted Position”
 - i) To position the device in the “cheek” position described above.
 - ii) While maintaining the device the reference plane described above and pivoting against the ear, move it outward away from the mouth by an angle of 15 degrees or until contact with the ear is lost (see Fig. 9.2).
- 3) “Body Worn”
 - i) To position the device parallel to the phantom surface.
 - ii) To adjust the phone parallel to the flat phantom.
 - iii) To adjust the distance between the EUT surface and the flat phantom to 1.5 cm or holster touch with the flat phantom.

Please refer to Appendix E for the test setup photo.

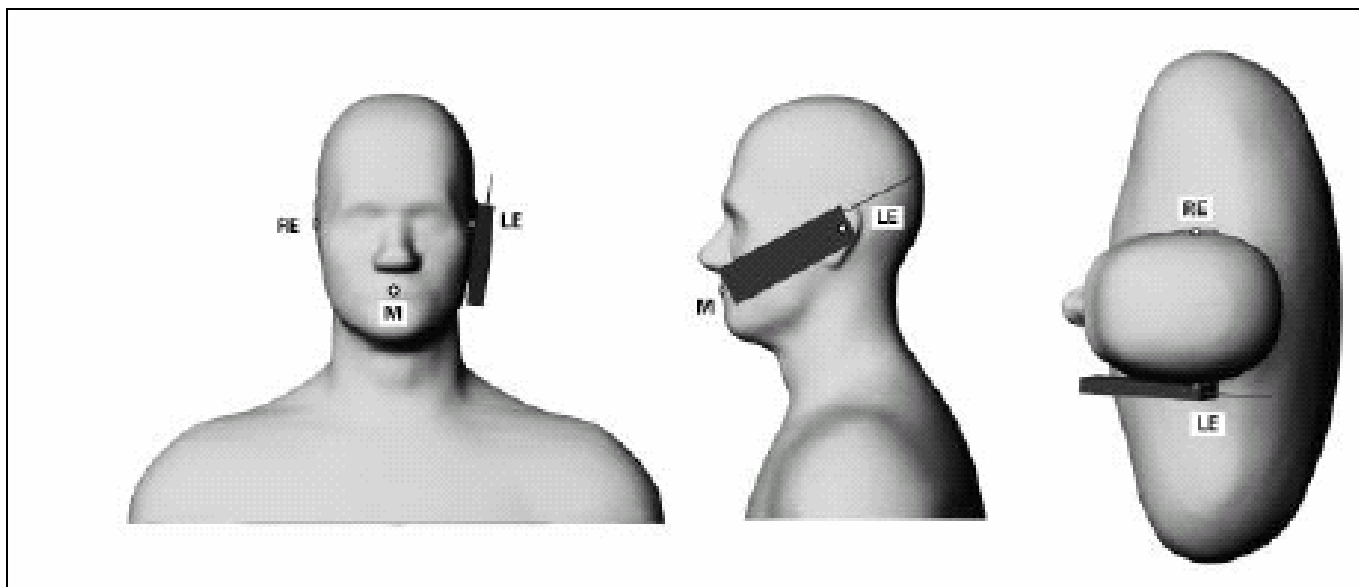

Fig. 9.1 Phone Position 1, “Cheek” or “Touch” Position. The reference points for the right ear (RE), left ear (LE) and mouth (M), which define the plane for phone positioning, are indicated.

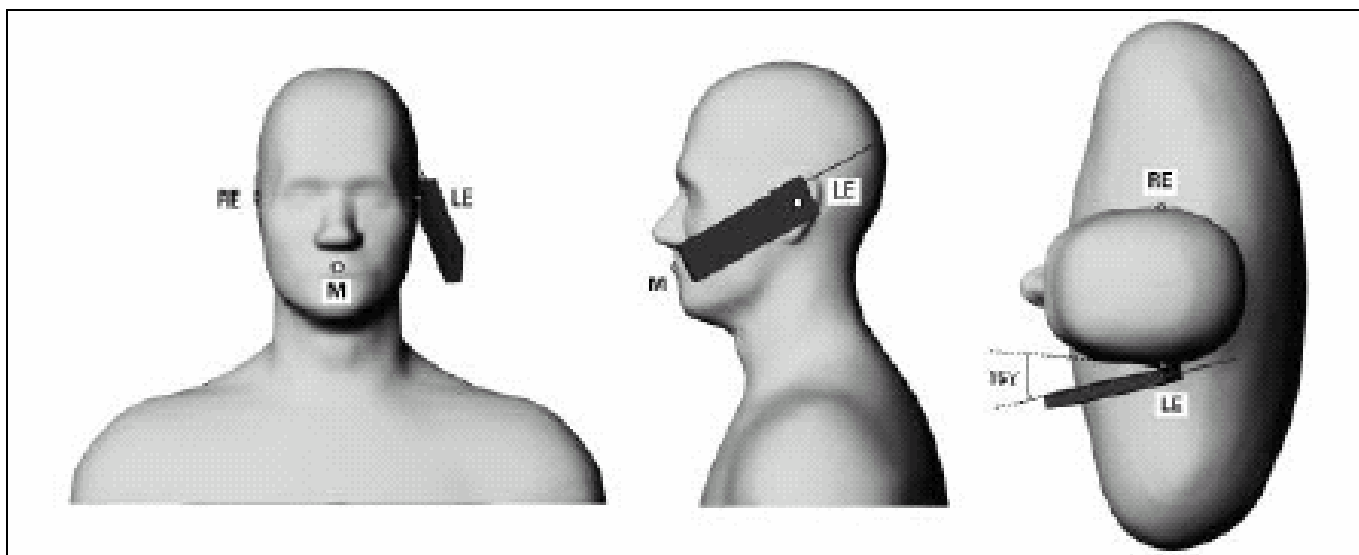

Fig. 9.2 Phone Position 2, “Tilted Position”. The reference point for the right ear (RE), left ear (LE) and mouth (M), which define the plane for phone positioning, are indicated.



10. Measurement Procedures

The measurement procedures are as follows:

- Linking DUT with base station emulator CMU200 in middle channel
- Setting base station to allow DUT to radiate maximum output power
- Measuring output power through RF cable and power meter
- Placing the DUT in the positions described in the last section
- Setting scan area, grid size and other setting on the DASY4 software
- Taking data for the lowest, middle, and highest channel on each testing position

According to the IEEE P1528 draft standard, the recommended procedure for assessing the peak spatial-average SAR value consists of the following steps:

- Power reference measurement
- Area scan
- Zoom scan
- Power reference measurement

10.1 Spatial Peak SAR Evaluation

The procedure for spatial peak SAR evaluation has been implemented according to the IEEE1528-2003 standard. It can be conducted for 1g and 10g, as well as for user-specific masses. The DASY4 software includes all numerical procedures necessary to evaluate the spatial peak SAR value.

Base on the Draft: SCC-34, SC-2, WG-2-Computational Dosimetry, IEEE P1528/D1.2 (Recommended Practice for Determining the Peak Spatial-Average Specific Absorption Rate (SAR) in the Human Head from Wireless Communications Devices: Measurement Techniques), a new algorithm has been implemented. The spatial-peak SAR can be computed over any required mass.

The base for the evaluation is a "cube" measurement. The measured volume must include the 1g and 10g cubes with the highest averaged SAR values. For that purpose , the center of the measured volume is aligned to the interpolated peak SAR value of a previously performed area scan.

The entire evaluation of the spatial peak values is performed within the post-processing engine (SEMCAD). The system always gives the maximum values for the 1g and 10g cubes. The algorithm to find the cube with highest averaged SAR is divided into the following stages:



- extraction of the measured data (grid and values) from the Zoom Scan
- calculation of the SAR value at every measurement point based on all stored data (A/D values and measurement parameters)
- generation of a high-resolution mesh within the measured volume

- interpolation of all measured values from the measurement grid to the high-resolution grid
- extrapolation of the entire 3-D field distribution to the phantom surface over the distance from sensor to surface
- calculation of the averaged SAR within masses of 1g and 10g

10.2 Scan Procedures

First **Area Scan** is used to locate the approximate location(s) of the local peak SAR value(s). The measurement grid within an Area Scan is defined by the grid extent, grid step size and grid offset. Next, in order to determine the EM field distribution in a three-dimensional spatial extension, Zoom Scan is required. The Zoom Scan measures 5x5x7 points with step size 8, 8 and 5 mm. The Zoom Scan is performed around the highest E-field value to determine the averaged SAR-distribution over 1 g.

10.3 SAR Averaged Methods

In DAS4, the interpolation and extrapolation are both based on the modified Quadratic Shepard's method. The interpolation scheme combines a least-square fitted function method and a weighted average method which are the two basic types of computational interpolation and approximation.

Extrapolation routines are used to obtain SAR values between the lowest measurement points and the inner phantom surface. The extrapolation distance is determined by the surface detection distance and the probe sensor offset. The uncertainty increases with the extrapolation distance. To keep the uncertainty within 1% for the 1 g and 10 g cubes, the extrapolation distance should not be larger than 5 mm.



11. SAR Test Results

11.1 Right Cheek

Mode	Scanner	Chan.	Freq (MHz)	Modulation Type	Conducted Power (dBm)	Power Drift (dB)	Measured 1g SAR (W/kg)	Limit (W/kg)	Results
GSM850	1	128	824.2 (Low)	GMSK	32.12	-0.073	0.088	1.6	Pass
		189	836.4 (Mid)	GMSK	32.19	-0.031	0.263	1.6	Pass
		251	848.8 (High)	GMSK	32.23	-0.138	0.119	1.6	Pass
GSM850 with BT On	1	189	836.4 (Mid)	GMSK	32.19	-0.013	0.09	1.6	Pass
GSM850	2	189	836.4 (Mid)	GMSK	32.44	-0.048	0.293	1.6	Pass
PCS1900	1	512	1850.2 (Low)	GMSK	28.75	0.151	0.134	1.6	Pass
		661	1880.0 (Mid)	GMSK	29.11	0.133	0.137	1.6	Pass
		810	1909.8 (High)	GMSK	29.26	-0.034	0.065	1.6	Pass
PCS1900 with BT On	1	661	1880.0 (Mid)	GMSK	29.11	-0.033	0.141	1.6	Pass
PCS1900	2	661	1880.0 (Mid)	GMSK	29.28	-0.142	0.226	1.6	Pass
802.11b	1	1	2412(Low)	CCK	14.02	0.152	0.00974	1.6	Pass
		6	2437(Mid)	CCK	13.86	-0.16	0.021	1.6	Pass
		11	2462(High)	CCK	14.06	-0.183	0.044	1.6	Pass
802.11b with BT On	1	11	2462(High)	CCK	14.06	-0.111	0.042	1.6	Pass
802.11b	2	11	2462(High)	CCK	14.06	-0.182	0.035	1.6	Pass
802.11g	1	1	2412(Low)	OFDM	17.94	-	-	-	-
		6	2437(Mid)	OFDM	18.83	-0.164	0.019	1.6	Pass
		11	2462(High)	OFDM	18.56	-	-	-	-

11.2 Right Tilted

Mode	Scanner	Chan.	Freq (MHz)	Modulation Type	Conducted Power (dBm)	Power Drift (dB)	Measured 1g SAR (W/kg)	Limit (W/kg)	Results
GSM850	1	128	824.2 (Low)	GMSK	32.12	-	-	-	-
		189	836.4 (Mid)	GMSK	32.19	-0.023	0.154	1.6	Pass
		251	848.8 (High)	GMSK	32.23	-	-	-	-
PCS1900	1	512	1850.2 (Low)	GMSK	28.75	-	-	-	-
		661	1880.0 (Mid)	GMSK	29.11	-0.081	0.033	1.6	Pass
		810	1909.8 (High)	GMSK	29.26	-	-	-	-
802.11b	1	1	2412(Low)	CCK	14.02	-	-	-	-
		6	2437(Mid)	CCK	13.86	-0.188	0.00966	1.6	Pass
		11	2462(High)	CCK	14.06	-	-	-	-
802.11g	1	1	2412(Low)	OFDM	17.94	-	-	-	-
		6	2437(Mid)	OFDM	18.83	-	-	-	-
		11	2462(High)	OFDM	18.56	-	-	-	-



11.3 Left Cheek

Mode	Scanner	Chan.	Freq (MHz)	Modulation Type	Conducted Power (dBm)	Power Drift (dB)	Measured 1g SAR (W/kg)	Limit (W/kg)	Results
GSM850	1	128	824.2 (Low)	GMSK	32.12	-	-	-	-
		189	836.4 (Mid)	GMSK	32.19	-0.118	0.246	1.6	Pass
		251	848.8 (High)	GMSK	32.23	-	-	-	-
PCS1900		512	1850.2 (Low)	GMSK	28.75	-	-	-	-
		661	1880.0 (Mid)	GMSK	29.11	-0.045	0.085	1.6	Pass
		810	1909.8 (High)	GMSK	29.26	-	-	-	-
802.11b		1	2412(Low)	CCK	14.02	-	-	-	-
		6	2437(Mid)	CCK	13.86	-0.151	0.016	1.6	Pass
		11	2462(High)	CCK	14.06	-	-	-	-
802.11g		1	2412(Low)	OFDM	17.94	-	-	-	-
		6	2437(Mid)	OFDM	18.83	-	-	-	-
	11	2462(High)	OFDM	18.56	-	-	-	-	

11.4 Left Tilted

Mode	Scanner	Chan.	Freq (MHz)	Modulation Type	Conducted Power (dBm)	Power Drift (dB)	Measured 1g SAR (W/kg)	Limit (W/kg)	Results
GSM850	1	128	824.2 (Low)	GMSK	32.12	-	-	-	-
		189	836.4 (Mid)	GMSK	32.19	-0.058	0.151	1.6	Pass
		251	848.8 (High)	GMSK	32.23	-	-	-	-
PCS1900		512	1850.2 (Low)	GMSK	28.75	-	-	-	-
		661	1880.0 (Mid)	GMSK	29.11	0.053	0.047	1.6	Pass
		810	1909.8 (High)	GMSK	29.26	-	-	-	-
802.11b		1	2412(Low)	CCK	14.02	-	-	-	-
		6	2437(Mid)	CCK	13.86	0.024	0.00842	1.6	Pass
		11	2462(High)	CCK	14.06	-	-	-	-
802.11g		1	2412(Low)	OFDM	17.94	-	-	-	-
		6	2437(Mid)	OFDM	18.83	-	-	-	-
	11	2462(High)	OFDM	18.56	-	-	-	-	



11.5 Keypad Up with 1.5cm Gap

Mode	Scanner	Chan.	Freq. (MHz)	Modulation Type	Conducted Power (dBm)	Power Drift (dB)	Measured 1g SAR (W/kg)	Limits (W/Kg)	Results
GSM850 (GPRS8)	1	128 (Low)	824.2	GMSK	32.03	-	-	-	-
		189 (Mid)	836.6	GMSK	32.10	-	-	-	-
		251 (High)	848.8	GMSK	32.14	-	-	-	-
GSM850 (GPRS10)		128 (Low)	824.2	GMSK	30.25	-	-	-	-
		189 (Mid)	836.6	GMSK	30.32	-	-	-	-
		251 (High)	848.8	GMSK	30.37	-	-	-	-
GSM850 (GPRS12)		128 (Low)	824.2	GMSK	26.62	-	-	-	-
		189 (Mid)	836.6	GMSK	26.70	-0.127	0.133	1.6	Pass
		251 (High)	848.8	GMSK	26.77	-	-	-	-
GSM850 (EDGE8)		128 (Low)	824.2	8PKS	26.30	-	-	-	-
		189 (Mid)	836.6	8PKS	26.26	-	-	-	-
		251 (High)	848.8	8PKS	26.18	-	-	-	-
GSM850 (EDGE10)		128 (Low)	824.2	8PKS	24.21	-	-	-	-
		189 (Mid)	836.6	8PKS	24.14	-	-	-	-
		251 (High)	848.8	8PKS	24.12	-	-	-	-
PCS1900 (GPRS8)		512 (Low)	1850.2	GMSK	28.76	-	-	-	-
		661 (Mid)	1880.0	GMSK	29.12	-	-	-	-
		810 (High)	1909.8	GMSK	29.29	-	-	-	-
PCS1900 (GPRS10)		512 (Low)	1850.2	GMSK	26.95	-	-	-	-
		661 (Mid)	1880.0	GMSK	27.31	-	-	-	-
		810 (High)	1909.8	GMSK	27.47	-	-	-	-
PCS1900 (GPRS12)		512 (Low)	1850.2	GMSK	23.28	-	-	-	-
		661 (Mid)	1880.0	GMSK	23.62	-0.149	0.07	1.6	Pass
		810 (High)	1909.8	GMSK	23.80	-	-	-	-
PCS1900 (EDGE8)		512 (Low)	1850.2	8PKS	24.80	-	-	-	-
		661 (Mid)	1880.0	8PKS	24.73	-	-	-	-
		810 (High)	1909.8	8PKS	24.71	-	-	-	-
PCS1900 (EDGE10)		512 (Low)	1850.2	8PKS	22.84	-	-	-	-
		661 (Mid)	1880.0	8PKS	22.76	-	-	-	-
		810 (High)	1909.8	8PKS	22.68	-	-	-	-
802.11b		1 (Low)	2412	CCK	14.02	-	-	-	-
	6 (Mid)	2437	CCK	13.86	0.103	0.00206	1.6	Pass	
	11 (High)	2462	CCK	14.06	-	-	-	-	
802.11g	1 (Low)	2412	OFDM	17.94	-	-	-	-	
	6 (Mid)	2437	OFDM	18.83	-	-	-	-	
		11 (High)	2462	OFDM	18.56	-	-	-	



11.6 Keypad Down with 1.5cm Gap

Mode	Scanner	Chan.	Freq. (MHz)	Modulation Type	Conducted Power (dBm)	Power Drift (dB)	Measured 1g SAR (W/kg)	Limits (W/Kg)	Results	
GSM850 (GPRS8)	1	128 (Low)	824.2	GMSK	32.03	-	-	-	-	
		189 (Mid)	836.6	GMSK	32.10	-0.183	0.172	1.6	Pass	
		251 (High)	848.8	GMSK	32.14	-	-	-	-	
GSM850 (GPRS10)		128 (Low)	824.2	GMSK	30.25	-0.123	0.296	1.6	Pass	
		189 (Mid)	836.6	GMSK	30.32	0.159	0.187	1.6	Pass	
		251 (High)	848.8	GMSK	30.37	-0.111	0.357	1.6	Pass	
GSM850 (GPRS10) with BT On		251 (High)	848.8	GMSK	30.37	-0.148	0.387	1.6	Pass	
GSM850 (GPRS10) with BT On		2	251 (High)	848.8	GMSK	30.63	-0.097	0.539	1.6	Pass
GSM850 (GPRS12)		1	128 (Low)	824.2	GMSK	26.62	-	-	-	-
	189 (Mid)		836.6	GMSK	26.70	-0.144	0.168	1.6	Pass	
	251 (High)		848.8	GMSK	26.77	-	-	-	-	
GSM850 (EDGE8)	128 (Low)		824.2	8PKS	26.30	-	-	-	-	
	189 (Mid)		836.6	8PKS	26.26	-0.045	0.132	1.6	Pass	
	251 (High)		848.8	8PKS	26.18	-	-	-	-	
GSM850 (EDGE10)	128 (Low)		824.2	8PKS	24.21	-	-	-	-	
	189 (Mid)		836.6	8PKS	24.14	-0.111	0.105	1.6	Pass	
	251 (High)		848.8	8PKS	24.12	-	-	-	-	
PCS1900 (GPRS8)	512 (Low)		1850.2	GMSK	28.76	-	-	-	-	
	661 (Mid)		1880.0	GMSK	29.12	-0.114	0.18	1.6	Pass	
	810 (High)		1909.8	GMSK	29.29	-	-	-	-	
PCS1900 (GPRS10)	512 (Low)		1850.2	GMSK	26.95	-0.02	0.159	1.6	Pass	
	661 (Mid)		1880.0	GMSK	27.31	0.019	0.236	1.6	Pass	
	810 (High)		1909.8	GMSK	27.47	0.16	0.106	1.6	Pass	
PCS1900 (GPRS10) with BT On	661 (Mid)		1880.0	GMSK	27.31	-0.199	0.17	1.6	Pass	
PCS1900 (GPRS10)	2		661 (Mid)	1880.0	GMSK	27.36	-0.056	0.178	1.6	Pass
PCS1900 (GPRS12)	1		512 (Low)	1850.2	GMSK	23.28	-	-	-	-
		661 (Mid)	1880.0	GMSK	23.62	-0.141	0.128	1.6	Pass	
		810 (High)	1909.8	GMSK	23.80	-	-	-	-	
PCS1900 (EDGE8)		512 (Low)	1850.2	8PKS	24.80	-	-	-	-	
		661 (Mid)	1880.0	8PKS	24.73	-0.101	0.076	1.6	Pass	
		810 (High)	1909.8	8PKS	24.71	-	-	-	-	
PCS1900 (EDGE10)		512 (Low)	1850.2	8PKS	22.84	-	-	-	-	
		661 (Mid)	1880.0	8PKS	22.76	-0.05	0.036	1.6	Pass	
		810 (High)	1909.8	8PKS	22.68	-	-	-	-	
802.11b		1 (Low)	2412	CCK	14.02	-0.104	0.00967	1.6	Pass	
		6 (Mid)	2437	CCK	13.86	0.142	0.011	1.6	Pass	
		11 (High)	2462	CCK	14.06	0.164	0.011	1.6	Pass	
802.11b with BT On		6 (Mid)	2437	CCK	13.86	0.174	0.00032	1.6	Pass	
802.11b		2	6 (Mid)	2437	CCK	13.86	-0.108	0.016	1.6	Pass
802.11g		1	1 (Low)	2412	OFDM	17.94	-	-	-	-
			6 (Mid)	2437	OFDM	18.83	0.171	0.00019	1.6	Pass
			11 (High)	2462	OFDM	18.56	-	-	-	-



11.7 Keypad Up with Holster Touch

Mode	Scanner	Chan.	Freq. (MHz)	Modulation Type	Conducted Power (dBm)	Power Drift (dB)	Measured 1g SAR (W/kg)	Limits (W/Kg)	Results
GSM850 (GPRS8)	2	128 (Low)	824.2	GMSK	32.13	-	-	-	-
		189 (Mid)	836.6	GMSK	32.32	-	-	-	-
		251 (High)	848.8	GMSK	32.50	-	-	-	-
GSM850 (GPRS10)		128 (Low)	824.2	GMSK	30.29	-	-	-	-
		189 (Mid)	836.6	GMSK	30.46	-	-	-	-
		251 (High)	848.8	GMSK	30.63	-	-	-	-
GSM850 (GPRS12)		128 (Low)	824.2	GMSK	26.52	-	-	-	-
		189 (Mid)	836.6	GMSK	26.71	-0.158	0.501	1.6	Pass
		251 (High)	848.8	GMSK	26.88	-	-	-	-
GSM850 (EDGE8)		128 (Low)	824.2	8PKS	26.22	-	-	-	-
		189 (Mid)	836.6	8PKS	26.23	-	-	-	-
		251 (High)	848.8	8PKS	26.18	-	-	-	-
GSM850 (EDGE10)		128 (Low)	824.2	8PKS	24.16	-	-	-	-
		189 (Mid)	836.6	8PKS	24.11	-	-	-	-
		251 (High)	848.8	8PKS	24.04	-	-	-	-
PCS1900 (GPRS8)		512 (Low)	1850.2	GMSK	28.85	-	-	-	-
		661 (Mid)	1880.0	GMSK	29.21	-	-	-	-
		810 (High)	1909.8	GMSK	29.22	-	-	-	-
PCS1900 (GPRS10)		512 (Low)	1850.2	GMSK	26.98	-	-	-	-
		661 (Mid)	1880.0	GMSK	27.36	-	-	-	-
		810 (High)	1909.8	GMSK	27.37	-	-	-	-
PCS1900 (GPRS12)		512 (Low)	1850.2	GMSK	23.12	-	-	-	-
		661 (Mid)	1880.0	GMSK	23.52	-0.122	0.564	1.6	Pass
		810 (High)	1909.8	GMSK	23.46	-	-	-	-
PCS1900 (EDGE8)		512 (Low)	1850.2	8PKS	24.96	-	-	-	-
		661 (Mid)	1880.0	8PKS	24.84	-	-	-	-
		810 (High)	1909.8	8PKS	24.71	-	-	-	-
PCS1900 (EDGE10)		512 (Low)	1850.2	8PKS	22.91	-	-	-	-
		661 (Mid)	1880.0	8PKS	22.83	-	-	-	-
		810 (High)	1909.8	8PKS	22.71	-	-	-	-
802.11b	1 (Low)	2412	CCK	14.02	-	-	-	-	
	6 (Mid)	2437	CCK	13.86	-0.121	0.026	1.6	Pass	
	11 (High)	2462	CCK	14.06	-	-	-	-	
802.11g	1 (Low)	2412	OFDM	17.94	-	-	-	-	
	6 (Mid)	2437	OFDM	18.83	-	-	-	-	
	11 (High)	2462	OFDM	18.56	-	-	-	-	



11.8 Keypad Down with Holster Touch

Mode	Scanner	Chan.	Freq. (MHz)	Modulation Type	Conducted Power (dBm)	Power Drift (dB)	Measured 1g SAR (W/kg)	Limits (W/Kg)	Results	
GSM850 (GPRS8)	2	128 (Low)	824.2	GMSK	32.13	-	-	-	-	
		189 (Mid)	836.6	GMSK	32.32	-0.137	0.68	1.6	Pass	
		251 (High)	848.8	GMSK	32.50	-	-	-	-	
GSM850 (GPRS10)		128 (Low)	824.2	GMSK	30.29	-0.167	0.864	1.6	Pass	
		189 (Mid)	836.6	GMSK	30.46	-0.078	0.873	1.6	Pass	
		251 (High)	848.8	GMSK	30.63	-0.087	0.991	1.6	Pass	
GSM850 (GPRS10) with BT On			251 (High)	848.8	GMSK	30.63	-0.148	0.941	1.6	Pass
GSM850 (GPRS10)		1	251 (High)	848.8	GMSK	30.37	-0.187	0.988	1.6	Pass
GSM850 (GPRS12)		2	128 (Low)	824.2	GMSK	26.52	-	-	-	-
	189 (Mid)		836.6	GMSK	26.71	0.002	0.728	1.6	Pass	
	251 (High)		848.8	GMSK	26.88	-	-	-	-	
GSM850 (EDGE8)	128 (Low)		824.2	8PKS	26.22	-	-	-	-	
	189 (Mid)		836.6	8PKS	26.23	-0.106	0.2	1.6	Pass	
	251 (High)		848.8	8PKS	26.18	-	-	-	-	
GSM850 (EDGE10)	128 (Low)		824.2	8PKS	24.16	-	-	-	-	
	189 (Mid)		836.6	8PKS	24.11	-0.105	0.245	1.6	Pass	
	251 (High)		848.8	8PKS	24.04	-	-	-	-	
PCS1900 (GPRS8)	512 (Low)		1850.2	GMSK	28.85	-	-	-	-	
	661 (Mid)		1880.0	GMSK	29.21	0.06	0.484	1.6	Pass	
	810 (High)		1909.8	GMSK	29.22	-	-	-	-	
PCS1900 (GPRS10)	512 (Low)	1850.2	GMSK	26.98	-0.089	0.804	1.6	Pass		
	661 (Mid)	1880.0	GMSK	27.36	-0.155	0.641	1.6	Pass		
	810 (High)	1909.8	GMSK	27.37	0.043	0.586	1.6	Pass		
PCS1900 (GPRS10) with BT On		512 (Low)	1850.2	GMSK	26.98	0.118	0.784	1.6	Pass	
PCS1900 (GPRS10)	1	512 (Low)	1850.2	GMSK	27.31	-0.17	0.728	1.6	Pass	
PCS1900 (GPRS12)	2	512 (Low)	1850.2	GMSK	23.12	-	-	-	-	
		661 (Mid)	1880.0	GMSK	23.52	-0.107	0.564	1.6	Pass	
		810 (High)	1909.8	GMSK	23.46	-	-	-	-	
PCS1900 (EDGE8)		512 (Low)	1850.2	8PKS	24.96	-	-	-	-	
		661 (Mid)	1880.0	8PKS	24.84	0.176	0.249	1.6	Pass	
		810 (High)	1909.8	8PKS	24.71	-	-	-	-	
PCS1900 (EDGE10)		512 (Low)	1850.2	8PKS	22.91	-	-	-	-	
		661 (Mid)	1880.0	8PKS	22.83	0.026	0.309	1.6	Pass	
		810 (High)	1909.8	8PKS	22.71	-	-	-	-	
802.11b		1	1 (Low)	2412	CCK	14.02	0.135	0.031	1.6	Pass
			6 (Mid)	2437	CCK	13.86	0.128	0.053	1.6	Pass
			11 (High)	2462	CCK	14.06	0.05	0.168	1.6	Pass
802.11b with BT On			11 (High)	2462	CCK	14.06	-0.15	0.164	1.6	Pass
802.11b			11 (High)	2462	CCK	14.06	0.131	0.087	1.6	Pass
802.11g	2		1 (Low)	2412	OFDM	17.94	-	-	-	-
			6 (Mid)	2437	OFDM	18.83	0.148	0.016	1.6	Pass
			11 (High)	2462	OFDM	18.56	-	-	-	-



Remark :

1. For scanner 1, the largest summation of GSM/BT and WLAN for Head SAR is 0.307 W/kg and its position is right cheek.
2. For scanner 2, the largest summation of GSM/BT and WLAN for Head SAR is 0.328 W/kg and its position is right cheek.
3. For scanner 1, the largest summation of GSM/GPRS/EDGE/BT and WLAN for body SAR is 0.398 W/kg and its position is keypad down with 1.5cm gap, and body SAR is 0.555 W/kg and its position is keypad down with holster touch.
4. For scanner 2, the largest summation of GSM/GPRS/EDGE/BT and WLAN for body SAR is 1.075 W/kg and its position is keypad down with 1.5cm gap, and body SAR is 1.159 W/kg and its position is keypad down with holster touch.

Test Engineer : Eric Huang , Jason Wang , Gordon Lin and John Tsai



12. Reference

- [1] FCC 47 CFR Part 2 “Frequency Allocations and Radio Treaty Matters; General Rules and Regulations”
- [2] IEEE Std. P1528-2003, “Recommended Practice for Determining the Peak Spatial-Average Specific Absorption Rate (SAR) in the Human Head from Wireless Communications Devices: Measurement Techniques”, April 21, 2003
- [3] Supplement C (Edition 01-01) to OET Bulletin 65 (Edition 97-01), “Additional Information for Evaluating Compliance of Mobile and Portable Devices with FCC Limits for Human Exposure to RF Emissions”, June 2001
- [4] IEEE Std. C95.3-2002, “IEEE Recommended Practice for the Measurement of Potentially Hazardous Electromagnetic Fields-RF and Microwave”, 2002
- [5] IEEE Std. C95.1-1999, “IEEE Standard for Safety Levels with Respect to Human Exposure to Radio Frequency Electromagnetic Fields, 3 kHz to 300 GHz”, 1999
- [6] Robert J. Renka, “Multivariate Interpolation Of Large Sets Of Scattered Data”, University of North Texas ACM Transactions on Mathematical Software, vol. 14, no. 2, June 1988, pp. 139-148
- [7] DAYS4 System Handbook
- [8] RSS-102 Issued 2, “Radio Frequency Exposure Compliance of Radiocommunication Apparatus (All Frequency Bands)”, November 2005



Appendix A - System Performance Check Data

Test Laboratory: Sporton International Inc. SAR Testing Lab

Date : 2007/7/8

System Check_Head_835MHz

DUT: Dipole 835 MHz

Communication System: CW; Frequency: 835 MHz; Duty Cycle: 1:1

Medium: HSL_850 Medium parameters used: $f = 835$ MHz; $\sigma = 0.9$ mho/m; $\epsilon_r = 40.1$; $\rho = 1000$ kg/m³

Ambient Temperature : 22.8 °C; Liquid Temperature : 21.4 °C

DASY4 Configuration:

- Probe: ET3DV6 - SN1788; ConvF(6.6, 6.6, 6.6); Calibrated: 2006/9/19

- Sensor-Surface: 4mm (Mechanical And Optical Surface Detection) Sensor-Surface: 4mm (Mechanical Surface Detection)

- Electronics: DAE3 Sn577; Calibrated: 2006/11/21

- Phantom: SAM-A; Type: QD 000 P40 C; Serial: TP-1303

- Measurement SW: DASY4, V4.7 Build 53; Postprocessing SW: SEMCAD, V1.8 Build 172

Pin=100mW/Area Scan (61x61x1): Measurement grid: dx=15mm, dy=15mm

Maximum value of SAR (interpolated) = 1.05 mW/g

Pin=100mW/Zoom Scan (7x7x7)/Cube 0: Measurement grid: dx=5mm, dy=5mm, dz=5mm

Reference Value = 35.6 V/m; Power Drift = -0.056 dB

Peak SAR (extrapolated) = 1.40 W/kg

SAR(1 g) = 0.948 mW/g; SAR(10 g) = 0.628 mW/g

Maximum value of SAR (measured) = 1.03 mW/g

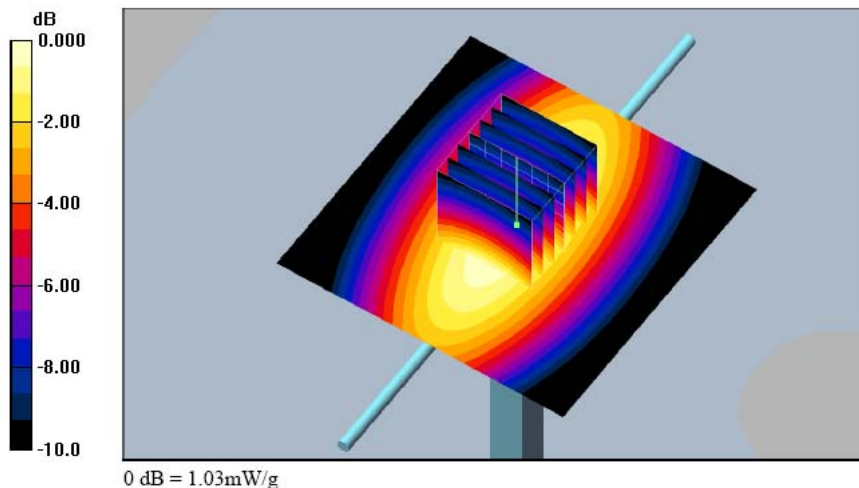



Test Laboratory: Sporton International Inc. SAR Testing Lab

Date : 2007/7/8

System Check_Head_1900MHz

DUT: Dipole 1900 MHz

Communication System: CW; Frequency: 1900 MHz; Duty Cycle: 1:1
Medium: HSL_1900 Medium parameters used: $f = 1900$ MHz; $\sigma = 1.39$ mho/m; $\epsilon_r = 39.3$; $\rho = 1000$ kg/m³
Ambient Temperature : 22.6 °C; Liquid Temperature : 21.3 °C

DASY4 Configuration:

- Probe: ET3DV6 - SN1788; ConvF(5.3, 5.3, 5.3); Calibrated: 2006/9/19
- Sensor-Surface: 4mm (Mechanical And Optical Surface Detection) Sensor-Surface: 4mm (Mechanical Surface Detection)
- Electronics: DAE3 Sn577; Calibrated: 2006/11/21
- Phantom: SAM-B; Type: QD 000 P40 C; Serial: TP-1383
- Measurement SW: DASY4, V4.7 Build 53; Postprocessing SW: SEMCAD, V1.8 Build 172

Pin=100mW/Area Scan (91x91x1): Measurement grid: dx=10mm, dy=10mm
Maximum value of SAR (interpolated) = 4.20 mW/g

Pin=100mW/Zoom Scan (7x7x7)/Cube 0: Measurement grid: dx=5mm, dy=5mm, dz=5mm
Reference Value = 57.8 V/m; Power Drift = 0.019 dB
Peak SAR (extrapolated) = 6.08 W/kg
SAR(1 g) = 3.64 mW/g; SAR(10 g) = 1.96 mW/g
Maximum value of SAR (measured) = 4.14 mW/g

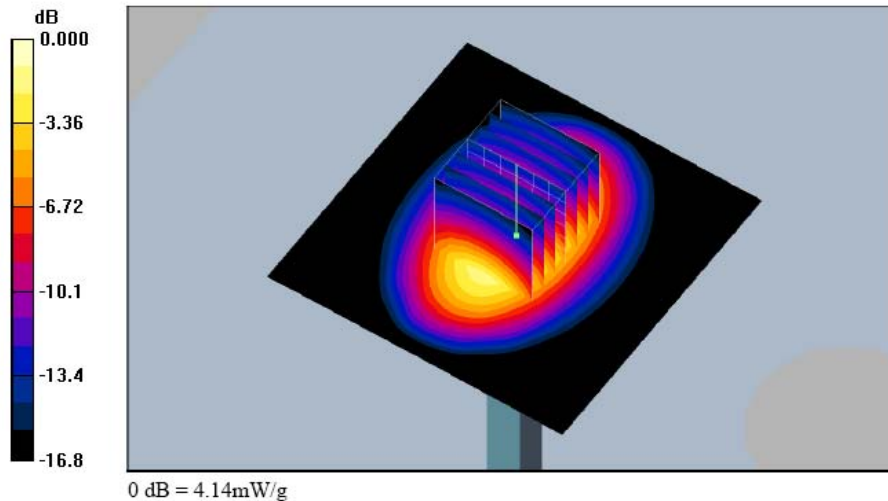



Test Laboratory: Sporton International Inc. SAR Testing Lab

Date: 2007/7/17

System Check_Head_2450MHz

DUT: Dipole 2450 MHz

Communication System: CW; Frequency: 2450 MHz; Duty Cycle: 1:1
Medium: HSL_2450 Medium parameters used: $f = 2450$ MHz; $\sigma = 1.76$ mho/m; $\epsilon_r = 38.1$; $\rho = 1000$ kg/m³
Ambient Temperature : 23.3 °C ; Liquid Temperature : 21.4 °C

DASY4 Configuration:

- Probe: ET3DV6 - SN1788; ConvF(4.66, 4.66, 4.66); Calibrated: 2006/9/19
- Sensor-Surface: 4mm (Mechanical And Optical Surface Detection)
- Electronics: DAE3 Sn577; Calibrated: 2006/11/21
- Phantom: SAM-B; Type: QD 000 P40 C; Serial: TP-1383
- Measurement SW: DASY4, V4.7 Build 53; Postprocessing SW: SEMCAD, V1.8 Build 172

2450MHz/Area Scan (41x41x1): Measurement grid: dx=20mm, dy=20mm
Maximum value of SAR (interpolated) = 5.83 mW/g

2450MHz/Zoom Scan (7x7x7)/Cube 0: Measurement grid: dx=5mm, dy=5mm, dz=5mm
Reference Value = 57.8 V/m; Power Drift = -0.036 dB
Peak SAR (extrapolated) = 11.4 W/kg
SAR(1 g) = 5.4 mW/g; SAR(10 g) = 2.55 mW/g
Maximum value of SAR (measured) = 6.11 mW/g

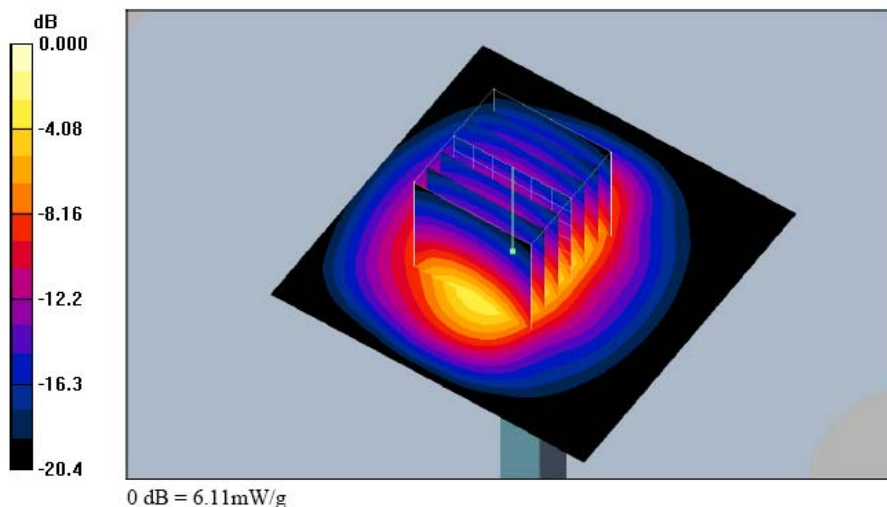



Test Laboratory: Sporton International Inc. SAR Testing Lab

Date : 2007/7/10

System Check_Body_835MHz

DUT: Dipole 835 MHz

Communication System: CW; Frequency: 835 MHz; Duty Cycle: 1:1

Medium: MSL_850 Medium parameters used: $f = 835 \text{ MHz}$; $\sigma = 0.971 \text{ mho/m}$; $\epsilon_r = 54.8$; $\rho = 1000 \text{ kg/m}^3$

Ambient Temperature : 22.6 °C; Liquid Temperature : 21.2 °C

DASY4 Configuration:

- Probe: ET3DV6 - SN1788; ConvF(6.33, 6.33, 6.33); Calibrated: 2006/9/19

- Sensor-Surface: 4mm (Mechanical And Optical Surface Detection) Sensor-Surface: 4mm (Mechanical Surface Detection)

- Electronics: DAE3 Sn577; Calibrated: 2006/11/21

- Phantom: SAM-A; Type: QD 000 P40 C; Serial: TP-1303

- Measurement SW: DASY4, V4.7 Build 53; Postprocessing SW: SEMCAD, V1.8 Build 172

Pin=100mW/Area Scan (61x61x1): Measurement grid: dx=15mm, dy=15mm

Maximum value of SAR (interpolated) = 1.05 mW/g

Pin=100mW/Zoom Scan (7x7x7)/Cube 0: Measurement grid: dx=5mm, dy=5mm, dz=5mm

Reference Value = 33.8 V/m; Power Drift = -0.025 dB

Peak SAR (extrapolated) = 1.39 W/kg

SAR(1 g) = 0.958 mW/g; SAR(10 g) = 0.631 mW/g

Maximum value of SAR (measured) = 1.04 mW/g

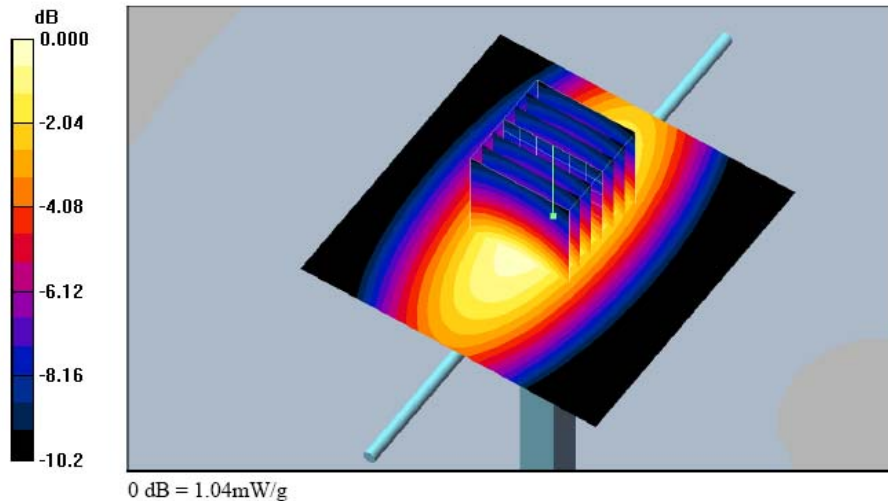



Test Laboratory: Sporton International Inc. SAR Testing Lab

Date: 2007/7/14

System Check_Body_1900MHz

DUT: Dipole 1900 MHz

Communication System: CW; Frequency: 1900 MHz; Duty Cycle: 1:1
Medium: MSL_1900 Medium parameters used: $f = 1900$ MHz; $\sigma = 1.5$ mho/m; $\epsilon_r = 53.6$; $\rho = 1000$ kg/m³
Ambient Temperature : 23.4 °C; Liquid Temperature : 21.5 °C

DASY4 Configuration:
- Probe: ET3DV6 - SN1788; ConvF(4.67, 4.67, 4.67); Calibrated: 2006/9/19
- Sensor-Surface: 4mm (Mechanical And Optical Surface Detection) Sensor-Surface: 4mm (Mechanical Surface Detection)
- Electronics: DAE3 Sn577; Calibrated: 2006/11/21
- Phantom: SAM-B; Type: QD 000 P40 C; Serial: TP-1383
- Measurement SW: DASY4, V4.7 Build 53; Postprocessing SW: SEMCAD, V1.8 Build 172

Pin=100mW/Area Scan (91x91x1): Measurement grid: dx=10mm, dy=10mm
Maximum value of SAR (interpolated) = 4.42 mW/g

Pin=100mW/Zoom Scan (7x7x7)/Cube 0: Measurement grid: dx=5mm, dy=5mm, dz=5mm
Reference Value = 52.2 V/m; Power Drift = -0.010 dB
Peak SAR (extrapolated) = 6.08 W/kg
SAR(1 g) = 3.75 mW/g; SAR(10 g) = 2.01 mW/g
Maximum value of SAR (measured) = 4.30 mW/g

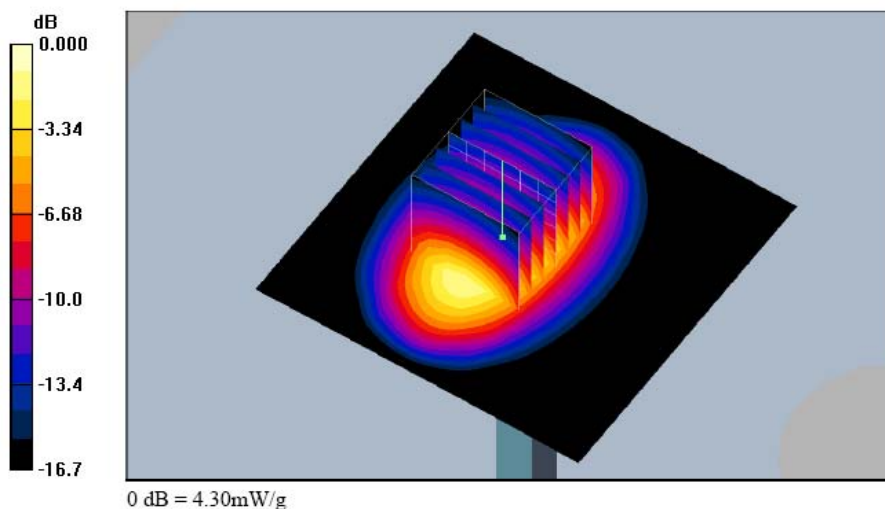



Test Laboratory: Sporton International Inc. SAR Testing Lab

Date : 2007/7/17

System Check_Body_2450MHz

DUT: Dipole 2450 MHz

Communication System: CW; Frequency: 2450 MHz; Duty Cycle: 1:1
Medium: MSL_2450 Medium parameters used: $f = 2450$ MHz; $\sigma = 1.93$ mho/m; $\epsilon_r = 51.5$; $\rho = 1000$ kg/m³
Ambient Temperature : 23.0 °C; Liquid Temperature : 21.5 °C

DASY4 Configuration:
- Probe: ET3DV6 - SN1788; ConvF(4.11, 4.11, 4.11); Calibrated: 2006/9/19
- Sensor-Surface: 4mm (Mechanical And Optical Surface Detection) Sensor-Surface: 4mm (Mechanical Surface Detection)
- Electronics: DAE3 Sn577; Calibrated: 2006/11/21
- Phantom: SAM-A; Type: QD 000 P40 C; Serial: TP-1303
- Measurement SW: DASY4, V4.7 Build 53; Postprocessing SW: SEMCAD, V1.8 Build 172

Pin=100mW/Area Scan (91x91x1): Measurement grid: dx=10mm, dy=10mm
Maximum value of SAR (interpolated) = 6.15 mW/g

Pin=100mW/Zoom Scan (7x7x7)/Cube 0: Measurement grid: dx=5mm, dy=5mm, dz=5mm
Reference Value = 57.2 V/m; Power Drift = 0.007 dB
Peak SAR (extrapolated) = 12.4 W/kg
SAR(1 g) = 5.34 mW/g; SAR(10 g) = 2.49 mW/g
Maximum value of SAR (measured) = 5.91 mW/g

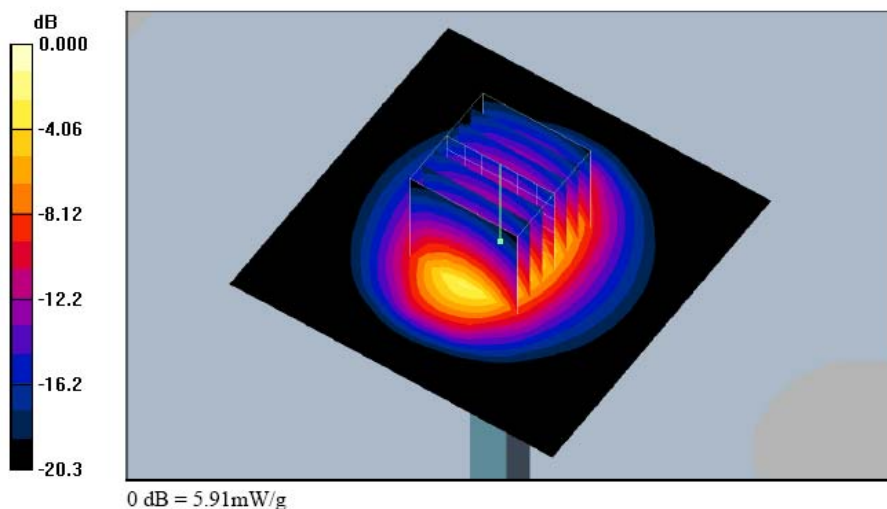



Test Laboratory: Sporton International Inc. SAR Testing Lab

Date : 2007/8/14

System Check_Body_835MHz

DUT: Dipole 835 MHz

Communication System: CW; Frequency: 835 MHz; Duty Cycle: 1:1

Medium: MSL_850 Medium parameters used: $f = 835 \text{ MHz}$; $\sigma = 0.967 \text{ mho/m}$; $\epsilon_r = 54.2$; $\rho = 1000 \text{ kg/m}^3$

Ambient Temperature : 22.9 °C; Liquid Temperature : 21.4 °C

DASY4 Configuration:

- Probe: ET3DV6 - SN1788; ConvF(6.33, 6.33, 6.33); Calibrated: 2006/9/19

- Sensor-Surface: 4mm (Mechanical And Optical Surface Detection) Sensor-Surface: 4mm (Mechanical Surface Detection)

- Electronics: DAE3 Sn577; Calibrated: 2006/11/21

- Phantom: SAM-A; Type: QD 000 P40 C; Serial: TP-1303

- Measurement SW: DASY4, V4.7 Build 53; Postprocessing SW: SEMCAD, V1.8 Build 172

Pin=100mW/Area Scan (61x61x1): Measurement grid: dx=15mm, dy=15mm

Maximum value of SAR (interpolated) = 1.03 mW/g

Pin=100mW/Zoom Scan (7x7x7)/Cube 0: Measurement grid: dx=5mm, dy=5mm, dz=5mm

Reference Value = 33.6 V/m; Power Drift = 0.105 dB

Peak SAR (extrapolated) = 1.37 W/kg

SAR(1 g) = 0.955 mW/g; SAR(10 g) = 0.629 mW/g

Maximum value of SAR (measured) = 1.03 mW/g

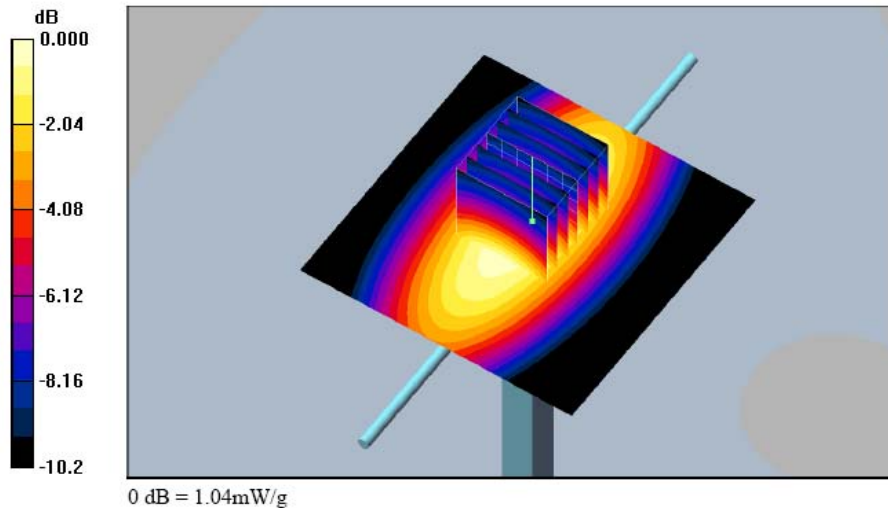



Test Laboratory: Sporton International Inc. SAR Testing Lab

Date: 2007/8/13

System Check_Body_1900MHz

DUT: Dipole 1900 MHz

Communication System: CW; Frequency: 1900 MHz; Duty Cycle: 1:1
Medium: MSL_1900 Medium parameters used: $f = 1900 \text{ MHz}$; $\sigma = 1.5 \text{ mho/m}$; $\epsilon_r = 52.6$; $\rho = 1000 \text{ kg/m}^3$
Ambient Temperature : 22.9 °C; Liquid Temperature : 21.2 °C

- DASY4 Configuration:
- Probe: ET3DV6 - SN1788; ConvF(4.67, 4.67, 4.67); Calibrated: 2006/9/19
 - Sensor-Surface: 4mm (Mechanical And Optical Surface Detection) Sensor-Surface: 4mm (Mechanical Surface Detection)
 - Electronics: DAE3 Sn577; Calibrated: 2006/11/21
 - Phantom: SAM-B; Type: QD 000 P40 C; Serial: TP-1383
 - Measurement SW: DASY4, V4.7 Build 53; Postprocessing SW: SEMCAD, V1.8 Build 172

Pin=100mW/Area Scan (91x91x1): Measurement grid: dx=10mm, dy=10mm
Maximum value of SAR (interpolated) = 4.43 mW/g

Pin=100mW/Zoom Scan (7x7x7)/Cube 0: Measurement grid: dx=5mm, dy=5mm, dz=5mm
Reference Value = 52.3 V/m; Power Drift = 0.121 dB
Peak SAR (extrapolated) = 6.09 W/kg
SAR(1 g) = 3.76 mW/g; SAR(10 g) = 2.02 mW/g
Maximum value of SAR (measured) = 4.31 mW/g

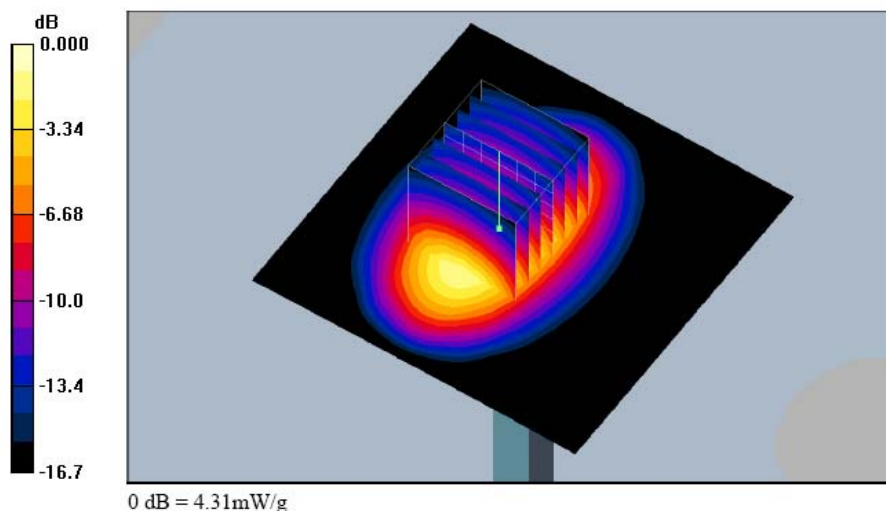



Test Laboratory: Sporton International Inc. SAR Testing Lab

Date: 2007/8/14

System Check_Body_2450MHz

DUT: Dipole 2450 MHz

Communication System: CW; Frequency: 2450 MHz; Duty Cycle: 1:1
Medium: MSL_2450 Medium parameters used: $f = 2450 \text{ MHz}$; $\sigma = 1.94 \text{ mho/m}$; $\epsilon_r = 51.6$; $\rho = 1000 \text{ kg/m}^3$
Ambient Temperature : 22.9 °C; Liquid Temperature : 21.4 °C

DASY4 Configuration:

- Probe: ET3DV6 - SN1788; ConvF(4.11, 4.11, 4.11); Calibrated: 2006/9/19
- Sensor-Surface: 4mm (Mechanical And Optical Surface Detection) Sensor-Surface: 4mm (Mechanical Surface Detection)
- Electronics: DAE3 Sn577; Calibrated: 2006/11/21
- Phantom: SAM-B; Type: QD 000 P40 C; Serial: TP-1383
- Measurement SW: DASY4, V4.7 Build 53; Postprocessing SW: SEMCAD, V1.8 Build 172

Pin=100mW/Area Scan (91x91x1): Measurement grid: dx=10mm, dy=10mm
Maximum value of SAR (interpolated) = 6.46 mW/g

Pin=100mW/Zoom Scan (7x7x7)/Cube 0: Measurement grid: dx=5mm, dy=5mm, dz=5mm
Reference Value = 58.5 V/m; Power Drift = -0.009 dB
Peak SAR (extrapolated) = 13.1 W/kg
SAR(1 g) = 5.62 mW/g; SAR(10 g) = 2.62 mW/g
Maximum value of SAR (measured) = 6.21 mW/g

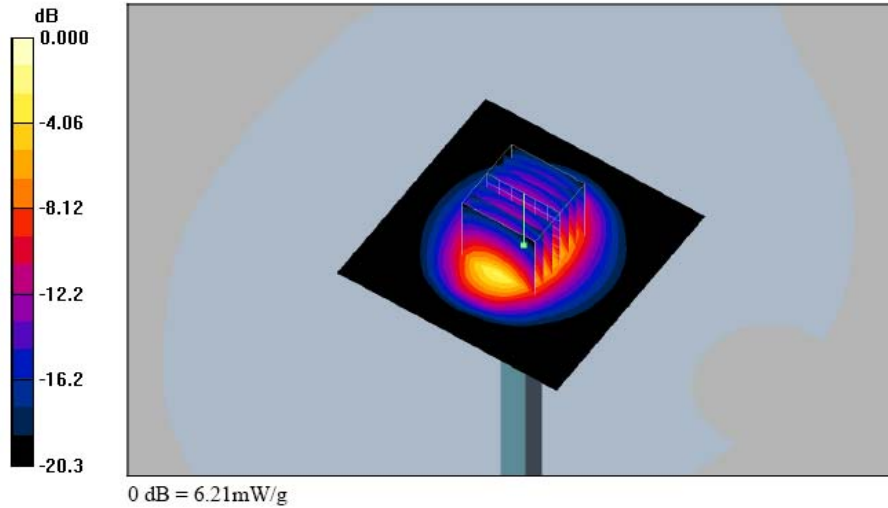



Appendix B - SAR Measurement Data

Test Laboratory: Sporton International Inc. SAR Testing Lab

Date: 2007/7/8

Right Cheek_GSM850 Ch189_Scanner1

DUT: 762206

Communication System: GSM850; Frequency: 836.4 MHz; Duty Cycle: 1:8.3

Medium: HSL_850 Medium parameters used : $f = 836.4$ MHz; $\sigma = 0.901$ mho/m; $\epsilon_r = 40.1$; $\rho = 1000$ kg/m³

Ambient Temperature : 22.8 °C; Liquid Temperature : 21.4 °C

DASY4 Configuration:

- Probe: ET3DV6 - SN1788; ConvF(6.6, 6.6, 6.6); Calibrated: 2006/9/19

- Sensor-Surface: 4mm (Mechanical Surface Detection)

- Electronics: DAE3 Sn577; Calibrated: 2006/11/21

- Phantom: SAM-A; Type: QD 000 P40 C; Serial: TP-1303

- Measurement SW: DASY4, V4.7 Build 53; Postprocessing SW: SEMCAD, V1.8 Build 172

Ch189/Area Scan (51x111x1): Measurement grid: dx=15mm, dy=15mm

Maximum value of SAR (interpolated) = 0.285 mW/g

Ch189/Zoom Scan (5x5x7)/Cube 0: Measurement grid: dx=8mm, dy=8mm, dz=5mm

Reference Value = 5.85 V/m; Power Drift = -0.031 dB

Peak SAR (extrapolated) = 0.335 W/kg

SAR(1 g) = 0.263 mW/g; SAR(10 g) = 0.197 mW/g

Maximum value of SAR (measured) = 0.273 mW/g

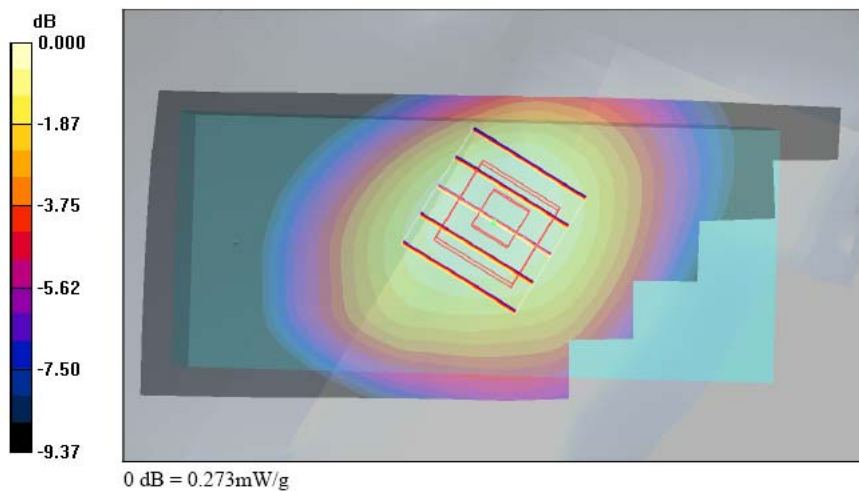



Test Laboratory: Sporton International Inc. SAR Testing Lab

Date: 2007/7/8

Right Tilted_GSM850 Ch189_Scanner1

DUT: 762206

Communication System: GSM850; Frequency: 836.4 MHz; Duty Cycle: 1:8.3

Medium: HSL_850 Medium parameters used : $f = 836.4$ MHz; $\sigma = 0.901$ mho/m; $\epsilon_r = 40.1$; $\rho = 1000$ kg/m³

Ambient Temperature : 22.8 °C; Liquid Temperature : 21.4 °C

DASY4 Configuration:

- Probe: ET3DV6 - SN1788; ConvF(6.6, 6.6, 6.6); Calibrated: 2006/9/19
- Sensor-Surface: 4mm (Mechanical Surface Detection)
- Electronics: DAE3 Sn577; Calibrated: 2006/11/21
- Phantom: SAM-A; Type: QD 000 P40 C; Serial: TP-1303
- Measurement SW: DASY4, V4.7 Build 53; Postprocessing SW: SEMCAD, V1.8 Build 172

Ch189/Area Scan (51x111x1): Measurement grid: dx=15mm, dy=15mm

Maximum value of SAR (interpolated) = 0.166 mW/g

Ch189/Zoom Scan (5x5x7)/Cube 0: Measurement grid: dx=8mm, dy=8mm, dz=5mm

Reference Value = 8.60 V/m; Power Drift = -0.023 dB

Peak SAR (extrapolated) = 0.187 W/kg

SAR(1 g) = 0.154 mW/g; SAR(10 g) = 0.116 mW/g

Maximum value of SAR (measured) = 0.163 mW/g

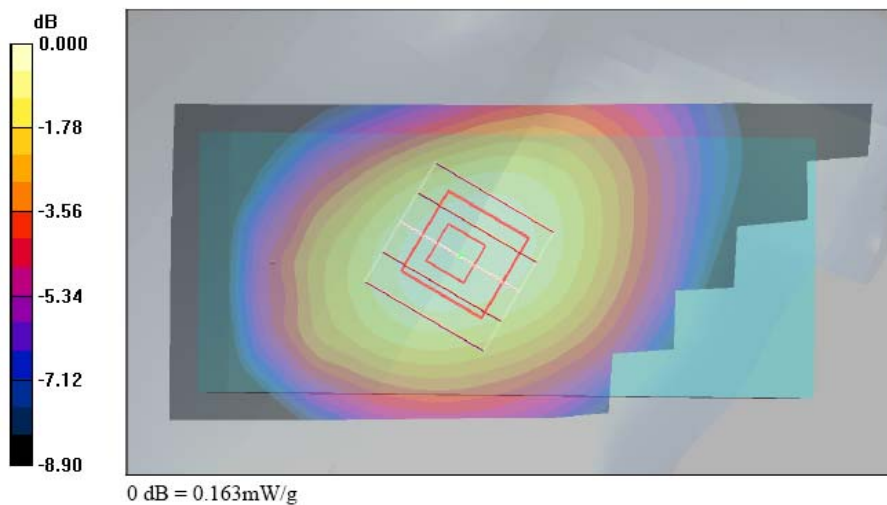



Test Laboratory: Sporton International Inc. SAR Testing Lab

Date : 2007/7/8

Left Cheek_GSM850 Ch189_Scanner1

DUT: 762206

Communication System: GSM850; Frequency: 836.4 MHz; Duty Cycle: 1:8.3

Medium: HSL_850 Medium parameters used: $f = 836.4$ MHz; $\sigma = 0.901$ mho/m; $\epsilon_r = 40.1$; $\rho = 1000$ kg/m³

Ambient Temperature : 22.8 °C; Liquid Temperature : 21.4 °C

DASY4 Configuration:

- Probe: ET3DV6 - SN1788; ConvF(6.6, 6.6, 6.6); Calibrated: 2006/9/19

- Sensor-Surface: 4mm (Mechanical Surface Detection)

- Electronics: DAE3 Sn577; Calibrated: 2006/11/21

- Phantom: SAM-A; Type: QD 000 P40 C; Serial: TP-1303

- Measurement SW: DASY4, V4.7 Build 53; Postprocessing SW: SEMCAD, V1.8 Build 172

Ch189/Area Scan (51x111x1): Measurement grid: dx=15mm, dy=15mm

Maximum value of SAR (interpolated) = 0.261 mW/g

Ch189/Zoom Scan (5x5x7)/Cube 0: Measurement grid: dx=8mm, dy=8mm, dz=5mm

Reference Value = 5.66 V/m; Power Drift = -0.118 dB

Peak SAR (extrapolated) = 0.323 W/kg

SAR(1 g) = 0.246 mW/g; SAR(10 g) = 0.180 mW/g

Maximum value of SAR (measured) = 0.261 mW/g

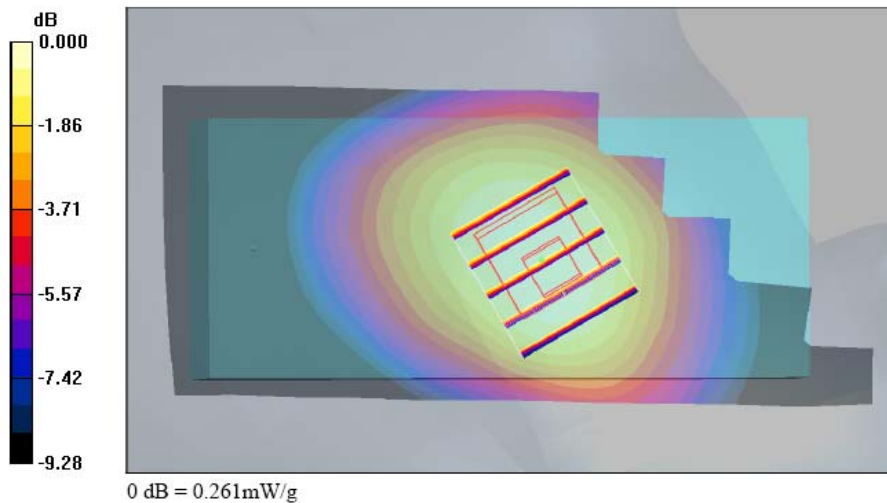



Test Laboratory: Sporton International Inc. SAR Testing Lab

Date : 2007/7/8

Left Tilted_GSM850 Ch189_Scanner1

DUT: 762206

Communication System: GSM850; Frequency: 836.4 MHz; Duty Cycle: 1:8.3

Medium: HSL_850 Medium parameters used: $f = 836.4$ MHz; $\sigma = 0.901$ mho/m; $\epsilon_r = 40.1$; $\rho = 1000$ kg/m³

Ambient Temperature : 22.8 °C; Liquid Temperature : 21.4 °C

DASY4 Configuration:

- Probe: ET3DV6 - SN1788; ConvF(6.6, 6.6, 6.6); Calibrated: 2006/9/19

- Sensor-Surface: 4mm (Mechanical Surface Detection)

- Electronics: DAE3 Sn577; Calibrated: 2006/11/21

- Phantom: SAM-A; Type: QD 000 P40 C; Serial: TP-1303

- Measurement SW: DASY4, V4.7 Build 53; Postprocessing SW: SEMCAD, V1.8 Build 172

Ch189/Area Scan (51x111x1): Measurement grid: dx=15mm, dy=15mm

Maximum value of SAR (interpolated) = 0.161 mW/g

Ch189/Zoom Scan (5x5x7)/Cube 0: Measurement grid: dx=8mm, dy=8mm, dz=5mm

Reference Value = 8.61 V/m; Power Drift = -0.058 dB

Peak SAR (extrapolated) = 0.182 W/kg

SAR(1 g) = 0.151 mW/g; SAR(10 g) = 0.116 mW/g

Maximum value of SAR (measured) = 0.159 mW/g

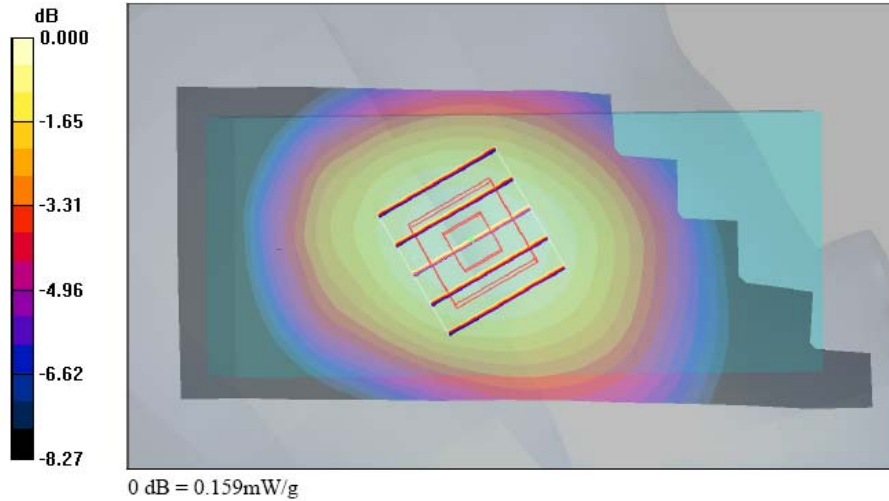



Test Laboratory: Sporton International Inc. SAR Testing Lab Date : 2007/7/8

Right Cheek_GSM850_Ch189_Scanner1_Bluetooth On

DUT: 762206

Communication System: GSM850; Frequency: 836.4 MHz; Duty Cycle: 1:8.3
Medium: HSL_850 Medium parameters used: $f = 836.4 \text{ MHz}$; $\sigma = 0.901 \text{ mho/m}$; $\epsilon_r = 40.1$; $\rho = 1000 \text{ kg/m}^3$
Ambient Temperature : 22.8 °C; Liquid Temperature : 21.4 °C

DASY4 Configuration:

- Probe: ET3DV6 - SN1788; ConvF(6.6, 6.6, 6.6); Calibrated: 2006/9/19
- Sensor-Surface: 4mm (Mechanical Surface Detection)
- Electronics: DAE3 Sn577; Calibrated: 2006/11/21
- Phantom: SAM-A; Type: QD 000 P40 C; Serial: TP-1303
- Measurement SW: DASY4, V4.7 Build 53; Postprocessing SW: SEMCAD, V1.8 Build 172

Ch189/Area Scan (51x111x1): Measurement grid: dx=15mm, dy=15mm
Maximum value of SAR (interpolated) = 0.097 mW/g

Ch189/Zoom Scan (5x5x7)/Cube 0: Measurement grid: dx=8mm, dy=8mm, dz=5mm
Reference Value = 4.43 V/m; Power Drift = -0.013 dB
Peak SAR (extrapolated) = 0.112 W/kg
SAR(1 g) = 0.090 mW/g; SAR(10 g) = 0.068 mW/g
Maximum value of SAR (measured) = 0.095 mW/g

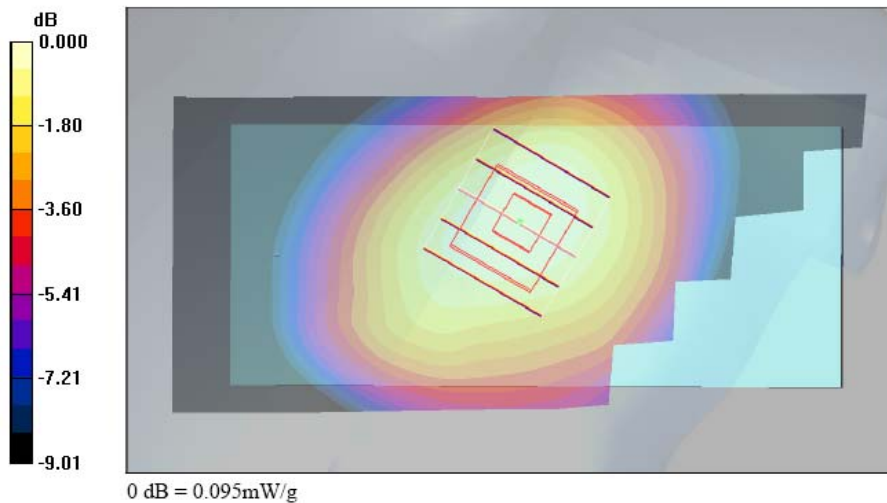



Test Laboratory: Sporton International Inc. SAR Testing Lab

Date: 2007/7/8

Right Cheek_GSM850 Ch189_Scanner2

DUT: 762206

Communication System: GSM850; Frequency: 836.4 MHz; Duty Cycle: 1:8.3

Medium: HSL_850 Medium parameters used: $f = 836.4$ MHz; $\sigma = 0.901$ mho/m; $\epsilon_r = 40.1$; $\rho = 1000$ kg/m³

Ambient Temperature : 22.8 °C; Liquid Temperature : 21.4 °C

DASY4 Configuration:

- Probe: ET3DV6 - SN1788; ConvF(6.6, 6.6, 6.6); Calibrated: 2006/9/19

- Sensor-Surface: 4mm (Mechanical Surface Detection)

- Electronics: DAE3 Sn577; Calibrated: 2006/11/21

- Phantom: SAM-A; Type: QD 000 P40 C; Serial: TP-1303

- Measurement SW: DASY4, V4.7 Build 53; Postprocessing SW: SEMCAD, V1.8 Build 172

Ch189/Area Scan (51x111x1): Measurement grid: dx=15mm, dy=15mm

Maximum value of SAR (interpolated) = 0.322 mW/g

Ch189/Zoom Scan (5x5x7)/Cube 0: Measurement grid: dx=8mm, dy=8mm, dz=5mm

Reference Value = 8.63 V/m; Power Drift = -0.048 dB

Peak SAR (extrapolated) = 0.404 W/kg

SAR(1 g) = 0.293 mW/g; SAR(10 g) = 0.210 mW/g

Maximum value of SAR (measured) = 0.314 mW/g

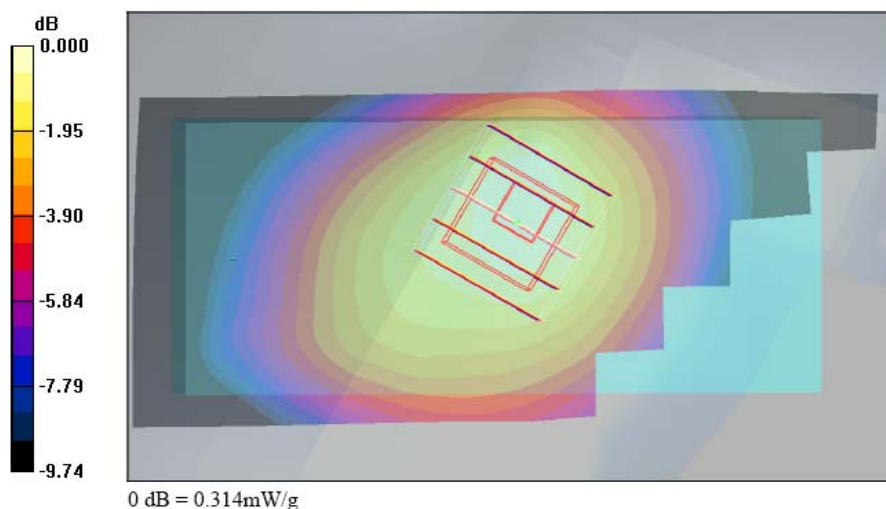



Test Laboratory: Sporton International Inc. SAR Testing Lab

Date : 2007/7/8

Right Cheek_PCS Ch661_Scanner1

DUT: 762206

Communication System: PCS; Frequency: 1880 MHz; Duty Cycle: 1:8.3

Medium: HSL_1900 Medium parameters used: $f = 1880$ MHz; $\sigma = 1.37$ mho/m; $\epsilon_r = 39.3$; $\rho = 1000$ kg/m³

Ambient Temperature : 22.6 °C; Liquid Temperature : 21.3 °C

DASY4 Configuration:

- Probe: ET3DV6 - SN1788; ConvF(5.3, 5.3, 5.3); Calibrated: 2006/9/19

- Sensor-Surface: 4mm (Mechanical Surface Detection)

- Electronics: DAE3 Sn577; Calibrated: 2006/11/21

- Phantom: SAM-B; Type: QD 000 P40 C; Serial: TP-1383

- Measurement SW: DASY4, V4.7 Build 53; Postprocessing SW: SEMCAD, V1.8 Build 172

Ch661/Area Scan (51x111x1): Measurement grid: dx=15mm, dy=15mm

Maximum value of SAR (interpolated) = 0.156 mW/g

Ch661/Zoom Scan (5x5x7)/Cube 0: Measurement grid: dx=8mm, dy=8mm, dz=5mm

Reference Value = 2.93 V/m; Power Drift = 0.133 dB

Peak SAR (extrapolated) = 0.186 W/kg

SAR(1 g) = 0.137 mW/g; SAR(10 g) = 0.089 mW/g

Maximum value of SAR (measured) = 0.145 mW/g

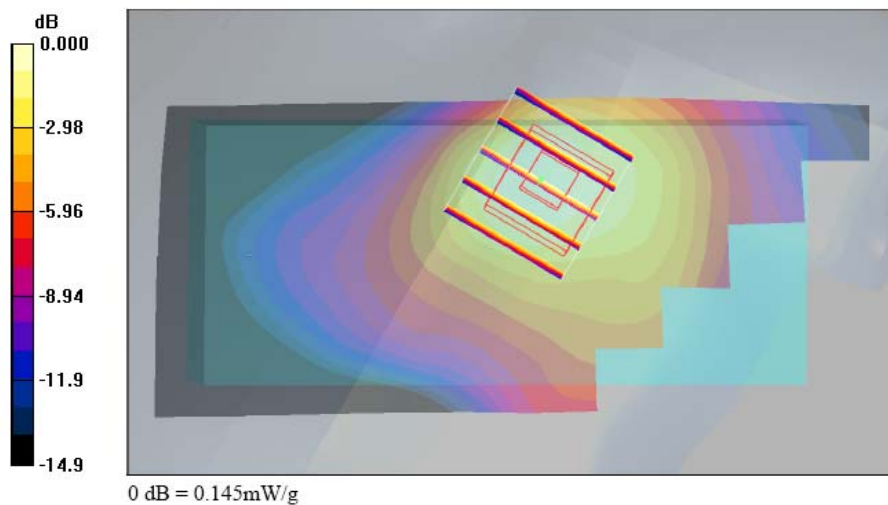



Test Laboratory: Sporton International Inc. SAR Testing Lab

Date : 2007/7/8

Right Tilted_PCS Ch661_Scanner1

DUT: 762206

Communication System: PCS; Frequency: 1880 MHz; Duty Cycle: 1:8.3

Medium: HSL_1900 Medium parameters used: $f = 1880$ MHz; $\sigma = 1.37$ mho/m; $\epsilon_r = 39.3$; $\rho = 1000$ kg/m³

Ambient Temperature : 22.7 °C; Liquid Temperature : 21.3 °C

DASY4 Configuration:

- Probe: ET3DV6 - SN1788; ConvF(5.3, 5.3, 5.3); Calibrated: 2006/9/19

- Sensor-Surface: 4mm (Mechanical Surface Detection)

- Electronics: DAE3 Sn577; Calibrated: 2006/11/21

- Phantom: SAM-B; Type: QD 000 P40 C; Serial: TP-1383

- Measurement SW: DASY4, V4.7 Build 53; Postprocessing SW: SEMCAD, V1.8 Build 172

Ch661/Area Scan (51x111x1): Measurement grid: dx=15mm, dy=15mm

Maximum value of SAR (interpolated) = 0.038 mW/g

Ch661/Zoom Scan (5x5x7)/Cube 0: Measurement grid: dx=8mm, dy=8mm, dz=5mm

Reference Value = 5.16 V/m; Power Drift = -0.081 dB

Peak SAR (extrapolated) = 0.046 W/kg

SAR(1 g) = 0.033 mW/g; SAR(10 g) = 0.022 mW/g

Maximum value of SAR (measured) = 0.036 mW/g





Test Laboratory: Sporton International Inc. SAR Testing Lab

Date : 2007/7/8

Left Cheek_PCS Ch661_Scanner1

DUT: 762206

Communication System: PCS; Frequency: 1880 MHz; Duty Cycle: 1:8.3

Medium: HSL_1900 Medium parameters used: $f = 1880$ MHz; $\sigma = 1.37$ mho/m; $\epsilon_r = 39.3$; $\rho = 1000$ kg/m³

Ambient Temperature : 22.6 °C; Liquid Temperature : 21.3 °C

DASY4 Configuration:

- Probe: ET3DV6 - SN1788; ConvF(5.3, 5.3, 5.3); Calibrated: 2006/9/19

- Sensor-Surface: 4mm (Mechanical Surface Detection)

- Electronics: DAE3 Sn577; Calibrated: 2006/11/21

- Phantom: SAM-B; Type: QD 000 P40 C; Serial: TP-1383

- Measurement SW: DASY4, V4.7 Build 53; Postprocessing SW: SEMCAD, V1.8 Build 172

Ch661/Area Scan (51x111x1): Measurement grid: dx=15mm, dy=15mm

Maximum value of SAR (interpolated) = 0.090 mW/g

Ch661/Zoom Scan (5x5x7)/Cube 0: Measurement grid: dx=8mm, dy=8mm, dz=5mm

Reference Value = 2.72 V/m; Power Drift = -0.045 dB

Peak SAR (extrapolated) = 0.113 W/kg

SAR(1 g) = 0.085 mW/g; SAR(10 g) = 0.059 mW/g

Maximum value of SAR (measured) = 0.091 mW/g

Ch661/Zoom Scan (5x5x7)/Cube 1: Measurement grid: dx=8mm, dy=8mm, dz=5mm

Reference Value = 2.72 V/m; Power Drift = -0.045 dB

Peak SAR (extrapolated) = 0.097 W/kg

SAR(1 g) = 0.075 mW/g; SAR(10 g) = 0.052 mW/g

Maximum value of SAR (measured) = 0.079 mW/g

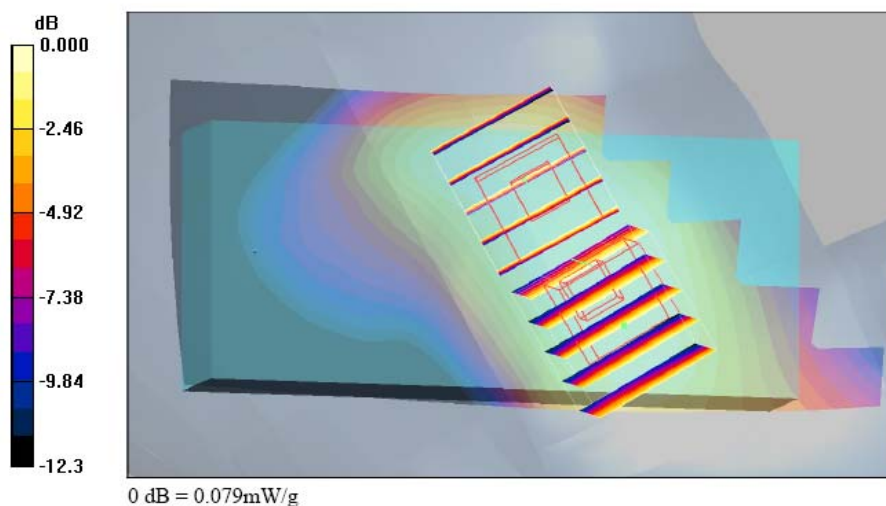



Test Laboratory: Sporton International Inc. SAR Testing Lab

Date : 2007/7/8

Left Tilted_PCS Ch661_Scanner1

DUT: 762206

Communication System: PCS; Frequency: 1880 MHz; Duty Cycle: 1:8.3

Medium: HSL_1900 Medium parameters used: $f = 1880 \text{ MHz}$; $\sigma = 1.37 \text{ mho/m}$; $\epsilon_r = 39.3$; $\rho = 1000 \text{ kg/m}^3$

Ambient Temperature : 22.6 °C; Liquid Temperature : 21.3 °C

DASY4 Configuration:

- Probe: ET3DV6 - SN1788; ConvF(5.3, 5.3, 5.3); Calibrated: 2006/9/19

- Sensor-Surface: 4mm (Mechanical Surface Detection)

- Electronics: DAE3 Sn577; Calibrated: 2006/11/21

- Phantom: SAM-B; Type: QD 000 P40 C; Serial: TP-1383

- Measurement SW: DASY4, V4.7 Build 53; Postprocessing SW: SEMCAD, V1.8 Build 172

Ch661/Area Scan (51x111x1): Measurement grid: dx=15mm, dy=15mm

Maximum value of SAR (interpolated) = 0.055 mW/g

Ch661/Zoom Scan (5x5x7)/Cube 0: Measurement grid: dx=8mm, dy=8mm, dz=5mm

Reference Value = 4.99 V/m; Power Drift = 0.053 dB

Peak SAR (extrapolated) = 0.066 W/kg

SAR(1 g) = 0.047 mW/g; SAR(10 g) = 0.031 mW/g

Maximum value of SAR (measured) = 0.051 mW/g

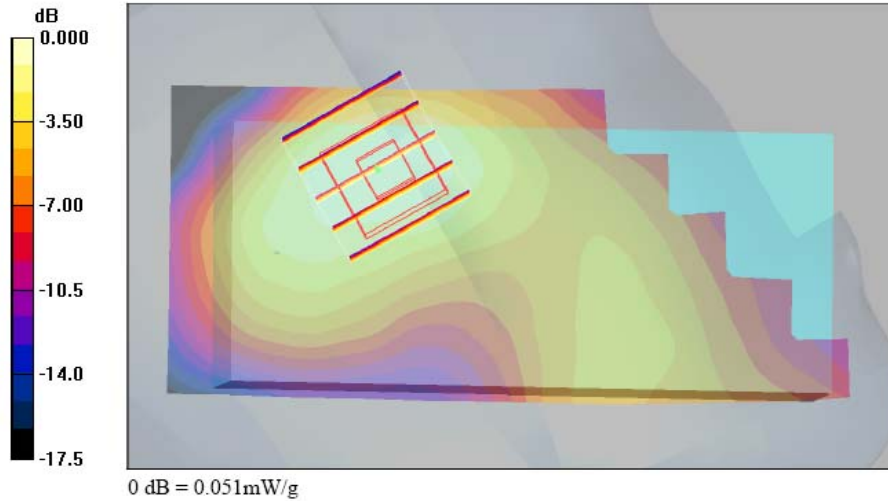



Test Laboratory: Sporton International Inc. SAR Testing Lab

Date : 2007/7/8

Right Cheek_PCS Ch661_Scanner1_Bluetooth On

DUT: 762206

Communication System: PCS; Frequency: 1880 MHz; Duty Cycle: 1:8.3

Medium: HSL_1900 Medium parameters used: $f = 1880$ MHz; $\sigma = 1.37$ mho/m; $\epsilon_r = 39.3$; $\rho = 1000$ kg/m³

Ambient Temperature : 22.6 °C; Liquid Temperature : 21.3 °C

DASY4 Configuration:

- Probe: ET3DV6 - SN1788; ConvF(5.3, 5.3, 5.3); Calibrated: 2006/9/19

- Sensor-Surface: 4mm (Mechanical Surface Detection)

- Electronics: DAE3 Sn577; Calibrated: 2006/11/21

- Phantom: SAM-B; Type: QD 000 P40 C; Serial: TP-1383

- Measurement SW: DASY4, V4.7 Build 53; Postprocessing SW: SEMCAD, V1.8 Build 172

Ch661/Area Scan (51x111x1): Measurement grid: dx=15mm, dy=15mm

Maximum value of SAR (interpolated) = 0.161 mW/g

Ch661/Zoom Scan (5x5x7)/Cube 0: Measurement grid: dx=8mm, dy=8mm, dz=5mm

Reference Value = 3.13 V/m; Power Drift = -0.033 dB

Peak SAR (extrapolated) = 0.195 W/kg

SAR(1 g) = 0.141 mW/g; SAR(10 g) = 0.091 mW/g

Maximum value of SAR (measured) = 0.154 mW/g

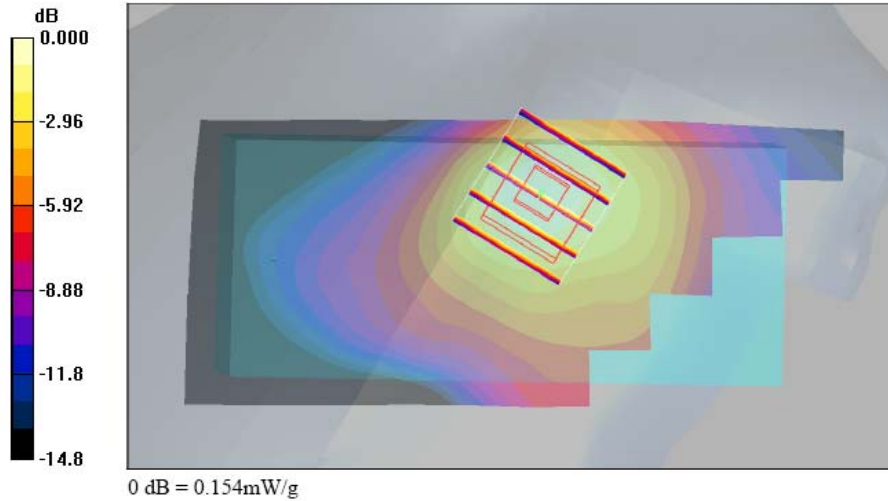



Test Laboratory: Sporton International Inc. SAR Testing Lab

Date: 2007/7/8

Right Cheek_PCS Ch661_Scanner2_Bluetooth On

DUT: 762206

Communication System: PCS; Frequency: 1880 MHz; Duty Cycle: 1:8.3

Medium: HSL_1900 Medium parameters used: $f = 1880$ MHz; $\sigma = 1.37$ mho/m; $\epsilon_r = 39.3$; $\rho = 1000$ kg/m³

Ambient Temperature : 22.6 °C; Liquid Temperature : 21.3 °C

DASY4 Configuration:

- Probe: ET3DV6 - SN1788; ConvF(5.3, 5.3, 5.3); Calibrated: 2006/9/19

- Sensor-Surface: 4mm (Mechanical Surface Detection)

- Electronics: DAE3 Sn577; Calibrated: 2006/11/21

- Phantom: SAM-B; Type: QD 000 P40 C; Serial: TP-1383

- Measurement SW: DASY4, V4.7 Build 53; Postprocessing SW: SEMCAD, V1.8 Build 172

Ch661/Area Scan (51x111x1): Measurement grid: dx=15mm, dy=15mm

Maximum value of SAR (interpolated) = 0.258 mW/g

Ch661/Zoom Scan (5x5x7)/Cube 0: Measurement grid: dx=8mm, dy=8mm, dz=5mm

Reference Value = 5.86 V/m; Power Drift = -0.142 dB

Peak SAR (extrapolated) = 0.307 W/kg

SAR(1 g) = 0.226 mW/g; SAR(10 g) = 0.151 mW/g

Maximum value of SAR (measured) = 0.249 mW/g

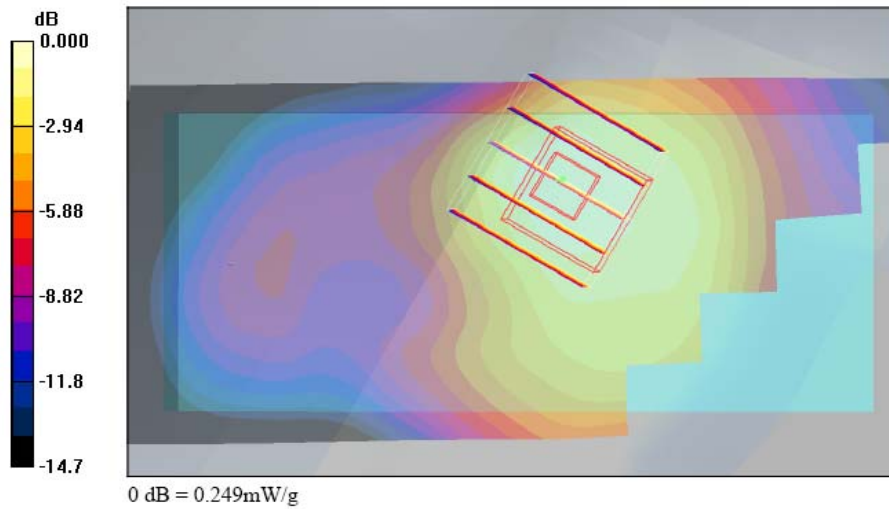



Test Laboratory: Sporton International Inc. SAR Testing Lab

Date: 2007/7/17

Right Cheek_802.11b Ch11_Scanner1

DUT: 762206

Communication System: 802.11b ; Frequency: 2462 MHz;Duty Cycle: 1:1

Medium: HSL_2450 Medium parameters used: $f = 2462$ MHz; $\sigma = 1.78$ mho/m; $\epsilon_r = 38$; $\rho = 1000$ kg/m³

Ambient Temperature : 23.0 °C; Liquid Temperature : 21.4 °C

DASY4 Configuration:

- Probe: ET3DV6 - SN1788; ConvF(4.66, 4.66, 4.66); Calibrated: 2006/9/19

- Sensor-Surface: 4mm (Mechanical Surface Detection)

- Electronics: DAE3 Sn577; Calibrated: 2006/11/21

- Phantom: SAM-B; Type: QD 000 P40 C; Serial: TP-1383

- Measurement SW: DASY4, V4.7 Build 53; Postprocessing SW: SEMCAD, V1.8 Build 172

Ch11/Area Scan (51x111x1): Measurement grid: dx=15mm, dy=15mm

Maximum value of SAR (interpolated) = 0.048 mW/g

Ch11/Zoom Scan (5x5x7)/Cube 0: Measurement grid: dx=8mm, dy=8mm, dz=5mm

Reference Value = 2.68 V/m; Power Drift = -0.183 dB

Peak SAR (extrapolated) = 0.092 W/kg

SAR(1 g) = 0.044 mW/g; SAR(10 g) = 0.024 mW/g

Maximum value of SAR (measured) = 0.048 mW/g

Ch11/Zoom Scan (5x5x7)/Cube 1: Measurement grid: dx=8mm, dy=8mm, dz=5mm

Reference Value = 2.68 V/m; Power Drift = -0.183 dB

Peak SAR (extrapolated) = 0.067 W/kg

SAR(1 g) = 0.034 mW/g; SAR(10 g) = 0.019 mW/g

Maximum value of SAR (measured) = 0.039 mW/g

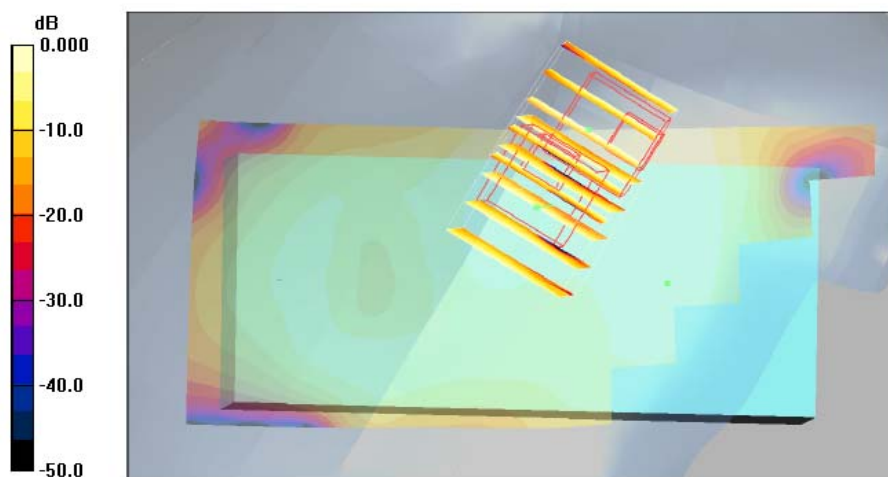



Test Laboratory: Sporton International Inc. SAR Testing Lab

Date: 2007/7/17

Right Tilted_802.11b Ch6_Scanner1

DUT: 762206

Communication System: 802.11b ; Frequency: 2437 MHz;Duty Cycle: 1:1

Medium: HSL_2450 Medium parameters used: $f = 2437$ MHz; $\sigma = 1.74$ mho/m; $\epsilon_r = 38.2$; $\rho = 1000$ kg/m³

Ambient Temperature : 23.2 °C; Liquid Temperature : 21.4 °C

DASY4 Configuration:

- Probe: ET3DV6 - SN1788; ConvF(4.66, 4.66, 4.66); Calibrated: 2006/9/19

- Sensor-Surface: 4mm (Mechanical Surface Detection)

- Electronics: DAE3 Sn577; Calibrated: 2006/11/21

- Phantom: SAM-B; Type: QD 000 P40 C; Serial: TP-1383

- Measurement SW: DASY4, V4.7 Build 53; Postprocessing SW: SEMCAD, V1.8 Build 172

Ch6/Area Scan (51x111x1): Measurement grid: dx=15mm, dy=15mm

Maximum value of SAR (interpolated) = 0.013 mW/g

Ch6/Zoom Scan (5x5x7)/Cube 0: Measurement grid: dx=8mm, dy=8mm, dz=5mm

Reference Value = 2.81 V/m; Power Drift = -0.188 dB

Peak SAR (extrapolated) = 0.029 W/kg

SAR(1 g) = 0.00966 mW/g; SAR(10 g) = 0.00405 mW/g

Maximum value of SAR (measured) = 0.011 mW/g

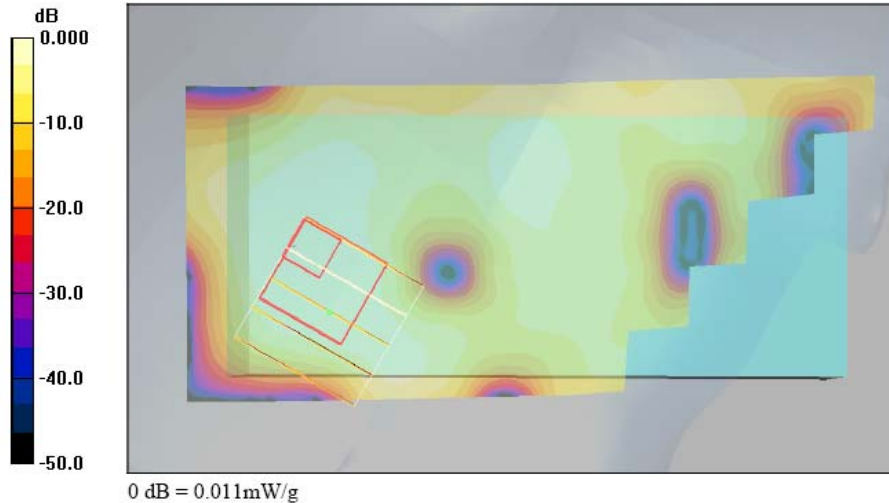



Test Laboratory: Sporton International Inc. SAR Testing Lab

Date: 2007/7/17

Left Cheek_802.11b Ch6_Scanner1

DUT: 762206

Communication System: 802.11b ; Frequency: 2437 MHz;Duty Cycle: 1:1

Medium: HSL_2450 Medium parameters used: $f = 2437$ MHz; $\sigma = 1.74$ mho/m; $\epsilon_r = 38.2$; $\rho = 1000$ kg/m³

Ambient Temperature : 22.8 °C; Liquid Temperature : 21.4 °C

DASY4 Configuration:

- Probe: ET3DV6 - SN1788; ConvF(4.66, 4.66, 4.66); Calibrated: 2006/9/19

- Sensor-Surface: 4mm (Mechanical Surface Detection)

- Electronics: DAE3 Sn577; Calibrated: 2006/11/21

- Phantom: SAM-B; Type: QD 000 P40 C; Serial: TP-1383

- Measurement SW: DASY4, V4.7 Build 53; Postprocessing SW: SEMCAD, V1.8 Build 172

Ch6/Area Scan (51x111x1): Measurement grid: dx=15mm, dy=15mm

Maximum value of SAR (interpolated) = 0.018 mW/g

Ch6/Zoom Scan (5x5x7)/Cube 0: Measurement grid: dx=8mm, dy=8mm, dz=5mm

Reference Value = 1.76 V/m; Power Drift = -0.151 dB

Peak SAR (extrapolated) = 0.025 W/kg

SAR(1 g) = 0.016 mW/g; SAR(10 g) = 0.00869 mW/g

Maximum value of SAR (measured) = 0.018 mW/g

Ch6/Zoom Scan (5x5x7)/Cube 1: Measurement grid: dx=8mm, dy=8mm, dz=5mm

Reference Value = 1.76 V/m; Power Drift = -0.151 dB

Peak SAR (extrapolated) = 0.021 W/kg

SAR(1 g) = 0.013 mW/g; SAR(10 g) = 0.00697 mW/g

Maximum value of SAR (measured) = 0.014 mW/g

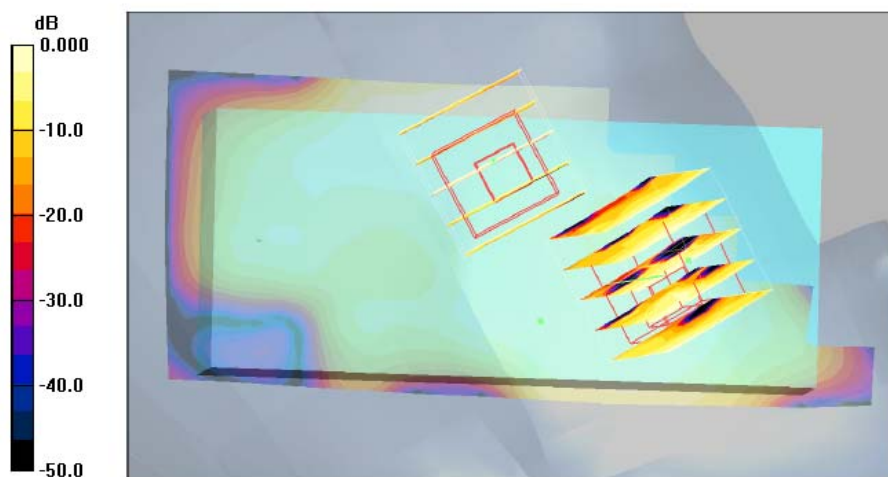



Test Laboratory: Sporton International Inc. SAR Testing Lab

Date: 2007/7/17

Left Tilted_802.11b Ch6_Scanner1

DUT: 762206

Communication System: 802.11b ; Frequency: 2437 MHz;Duty Cycle: 1:1
Medium: HSL_2450 Medium parameters used: $f = 2437$ MHz; $\sigma = 1.74$ mho/m; $\epsilon_r = 38.2$; $\rho = 1000$ kg/m³
Ambient Temperature : 22.9 °C; Liquid Temperature : 21.4 °C

DASY4 Configuration:

- Probe: ET3DV6 - SN1788; ConvF(4.66, 4.66, 4.66); Calibrated: 2006/9/19
- Sensor-Surface: 4mm (Mechanical Surface Detection)
- Electronics: DAE3 Sn577; Calibrated: 2006/11/21
- Phantom: SAM-B; Type: QD 000 P40 C; Serial: TP-1383
- Measurement SW: DASY4, V4.7 Build 53; Postprocessing SW: SEMCAD, V1.8 Build 172

Ch6/Area Scan (51x111x1): Measurement grid: dx=15mm, dy=15mm
Maximum value of SAR (interpolated) = 0.010 mW/g

Ch6/Zoom Scan (5x5x7)/Cube 0: Measurement grid: dx=8mm, dy=8mm, dz=5mm
Reference Value = 2.49 V/m; Power Drift = 0.024 dB
Peak SAR (extrapolated) = 0.019 W/kg
SAR(1 g) = 0.00842 mW/g; SAR(10 g) = 0.00381 mW/g
Maximum value of SAR (measured) = 0.009 mW/g

Ch6/Zoom Scan (5x5x7)/Cube 1: Measurement grid: dx=8mm, dy=8mm, dz=5mm
Reference Value = 2.49 V/m; Power Drift = 0.024 dB
Peak SAR (extrapolated) = 0.013 W/kg
SAR(1 g) = 0.00815 mW/g; SAR(10 g) = 0.00397 mW/g

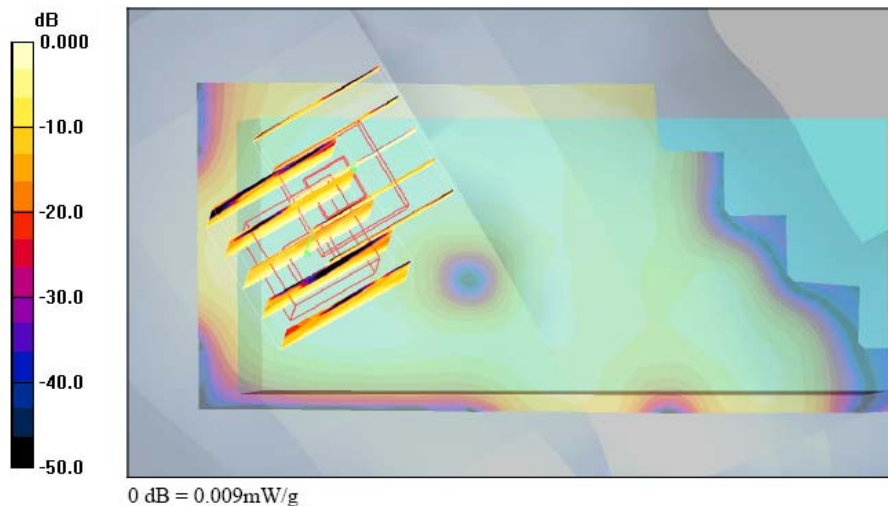



Test Laboratory: Sporton International Inc. SAR Testing Lab

Date: 2007/7/17

Right Cheek_802.11b Ch11_Scanner1_Bluetooth On

DUT: 762206

Communication System: 802.11b ; Frequency: 2462 MHz;Duty Cycle: 1:1

Medium: HSL_2450 Medium parameters used: $f = 2462$ MHz; $\sigma = 1.78$ mho/m; $\epsilon_r = 38$; $\rho = 1000$ kg/m³

Ambient Temperature : 23.0 °C; Liquid Temperature : 21.5 °C

DASY4 Configuration:

- Probe: ET3DV6 - SN1788; ConvF(4.66, 4.66, 4.66); Calibrated: 2006/9/19

- Sensor-Surface: 4mm (Mechanical Surface Detection)

- Electronics: DAE3 Sn577; Calibrated: 2006/11/21

- Phantom: SAM-B; Type: QD 000 P40 C; Serial: TP-1383

- Measurement SW: DASY4, V4.7 Build 53; Postprocessing SW: SEMCAD, V1.8 Build 172

Ch11/Area Scan (51x111x1): Measurement grid: dx=15mm, dy=15mm

Maximum value of SAR (interpolated) = 0.045 mW/g

Ch11/Zoom Scan (5x5x7)/Cube 0: Measurement grid: dx=8mm, dy=8mm, dz=5mm

Reference Value = 2.46 V/m; Power Drift = -0.111 dB

Peak SAR (extrapolated) = 0.090 W/kg

SAR(1 g) = 0.042 mW/g; SAR(10 g) = 0.022 mW/g

Maximum value of SAR (measured) = 0.045 mW/g

Ch11/Zoom Scan (5x5x7)/Cube 1: Measurement grid: dx=8mm, dy=8mm, dz=5mm

Reference Value = 2.46 V/m; Power Drift = -0.111 dB

Peak SAR (extrapolated) = 0.063 W/kg

SAR(1 g) = 0.033 mW/g; SAR(10 g) = 0.018 mW/g

Maximum value of SAR (measured) = 0.036 mW/g

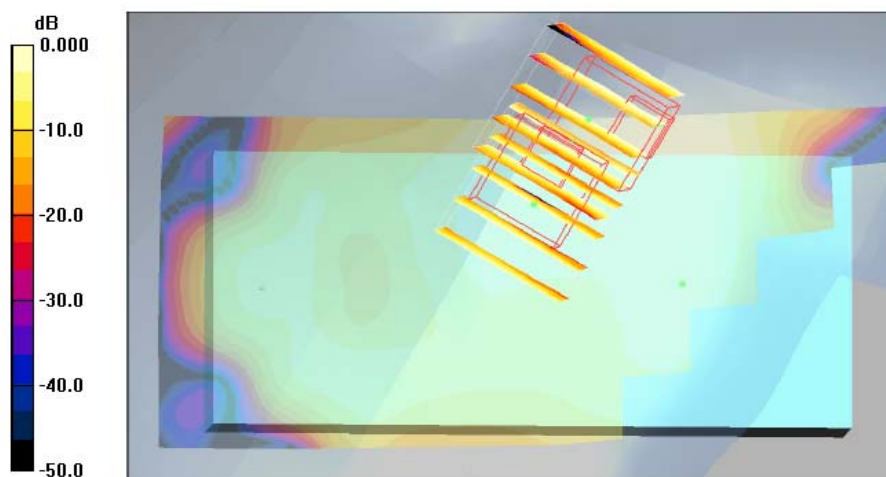

0 dB = 0.036mW/g



Test Laboratory: Sporton International Inc. SAR Testing Lab

Date: 2007/7/17

Right Cheek_802.11b Ch11_Scanner2

DUT: 762206

Communication System: 802.11b ; Frequency: 2462 MHz;Duty Cycle: 1:1

Medium: HSL_2450 Medium parameters used: $f = 2462$ MHz; $\sigma = 1.78$ mho/m; $\epsilon_r = 38$; $\rho = 1000$ kg/m³

Ambient Temperature : 23.0 °C; Liquid Temperature : 21.4 °C

DASY4 Configuration:

- Probe: ET3DV6 - SN1788; ConvF(4.66, 4.66, 4.66); Calibrated: 2006/9/19

- Sensor-Surface: 4mm (Mechanical Surface Detection)

- Electronics: DAE3 Sn577; Calibrated: 2006/11/21

- Phantom: SAM-B; Type: QD 000 P40 C; Serial: TP-1383

- Measurement SW: DASY4, V4.7 Build 53; Postprocessing SW: SEMCAD, V1.8 Build 172

Ch11/Area Scan (51x111x1): Measurement grid: dx=15mm, dy=15mm

Maximum value of SAR (interpolated) = 0.038 mW/g

Ch11/Zoom Scan (5x5x7)/Cube 0: Measurement grid: dx=8mm, dy=8mm, dz=5mm

Reference Value = 2.16 V/m; Power Drift = -0.182 dB

Peak SAR (extrapolated) = 0.076 W/kg

SAR(1 g) = 0.035 mW/g; SAR(10 g) = 0.018 mW/g

Maximum value of SAR (measured) = 0.039 mW/g

Ch11/Zoom Scan (5x5x7)/Cube 1: Measurement grid: dx=8mm, dy=8mm, dz=5mm

Reference Value = 2.16 V/m; Power Drift = -0.182 dB

Peak SAR (extrapolated) = 0.045 W/kg

SAR(1 g) = 0.026 mW/g; SAR(10 g) = 0.014 mW/g

Maximum value of SAR (measured) = 0.029 mW/g

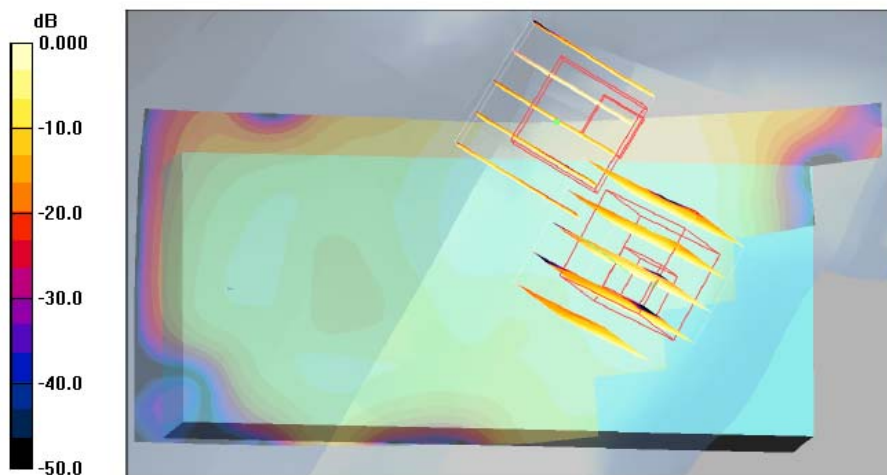



Test Laboratory: Sporton International Inc. SAR Testing Lab

Date: 2007/7/17

Right Cheek_802.11g Ch6_Scanner1

DUT: 762206

Communication System: 802.11g; Frequency: 2437 MHz; Duty Cycle: 1:1
Medium: HSL_2450 Medium parameters used: $f = 2437$ MHz; $\sigma = 1.74$ mho/m; $\epsilon_r = 38.2$; $\rho = 1000$ kg/m³
Ambient Temperature : 22.9 °C; Liquid Temperature : 21.4 °C

DASY4 Configuration:

- Probe: ET3DV6 - SN1788; ConvF(4.66, 4.66, 4.66); Calibrated: 2006/9/19
- Sensor-Surface: 4mm (Mechanical Surface Detection)
- Electronics: DAE3 Sn577; Calibrated: 2006/11/21
- Phantom: SAM-B; Type: QD 000 P40 C; Serial: TP-1383
- Measurement SW: DASY4, V4.7 Build 53; Postprocessing SW: SEMCAD, V1.8 Build 172

Ch6/Area Scan (51x111x1): Measurement grid: dx=15mm, dy=15mm
Maximum value of SAR (interpolated) = 0.024 mW/g

Ch6/Zoom Scan (5x5x7)/Cube 0: Measurement grid: dx=8mm, dy=8mm, dz=5mm
Reference Value = 1.54 V/m; Power Drift = -0.164 dB
Peak SAR (extrapolated) = 0.028 W/kg
SAR(1 g) = 0.019 mW/g; SAR(10 g) = 0.010 mW/g
Maximum value of SAR (measured) = 0.022 mW/g

Ch6/Zoom Scan (5x5x7)/Cube 1: Measurement grid: dx=8mm, dy=8mm, dz=5mm
Reference Value = 1.54 V/m; Power Drift = -0.164 dB
Peak SAR (extrapolated) = 0.028 W/kg
SAR(1 g) = 0.016 mW/g; SAR(10 g) = 0.00819 mW/g
Maximum value of SAR (measured) = 0.018 mW/g

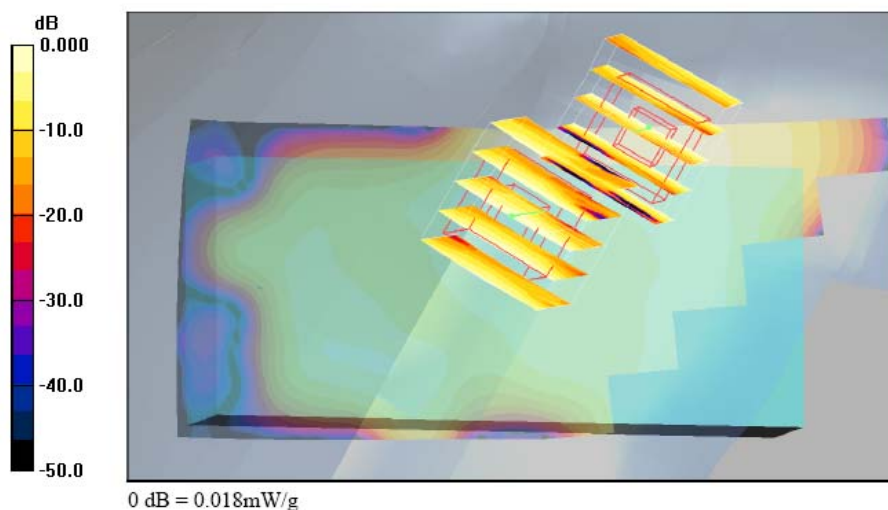



Test Laboratory: Sporton International Inc. SAR Testing Lab

Date : 2007/7/10

Body_GSM850 Ch189_Keypad Up with 1.5cm Gap_GPRS12_Scanner1

DUT: 762206

Communication System: GSM850; Frequency: 836.4 MHz; Duty Cycle: 1:2

Medium: MSL_850 Medium parameters used: $f = 836.4$ MHz; $\sigma = 0.972$ mho/m; $\epsilon_r = 54.8$; $\rho = 1000$ kg/m³

Ambient Temperature : 22.6 °C; Liquid Temperature : 21.2 °C

DASY4 Configuration:

- Probe: ET3DV6 - SN1788; ConvF(6.33, 6.33, 6.33); Calibrated: 2006/9/19

- Sensor-Surface: 4mm (Mechanical Surface Detection)

- Electronics: DAE3 Sn577; Calibrated: 2006/11/21

- Phantom: SAM-A; Type: QD 000 P40 C; Serial: TP-1303

- Measurement SW: DASY4, V4.7 Build 53; Postprocessing SW: SEMCAD, V1.8 Build 172

Ch189/Area Scan (51x111x1): Measurement grid: dx=15mm, dy=15mm

Maximum value of SAR (interpolated) = 0.142 mW/g

Ch189/Zoom Scan (5x5x7)/Cube 0: Measurement grid: dx=8mm, dy=8mm, dz=5mm

Reference Value = 5.59 V/m; Power Drift = -0.127 dB

Peak SAR (extrapolated) = 0.165 W/kg

SAR(1 g) = 0.133 mW/g; SAR(10 g) = 0.098 mW/g

Maximum value of SAR (measured) = 0.140 mW/g

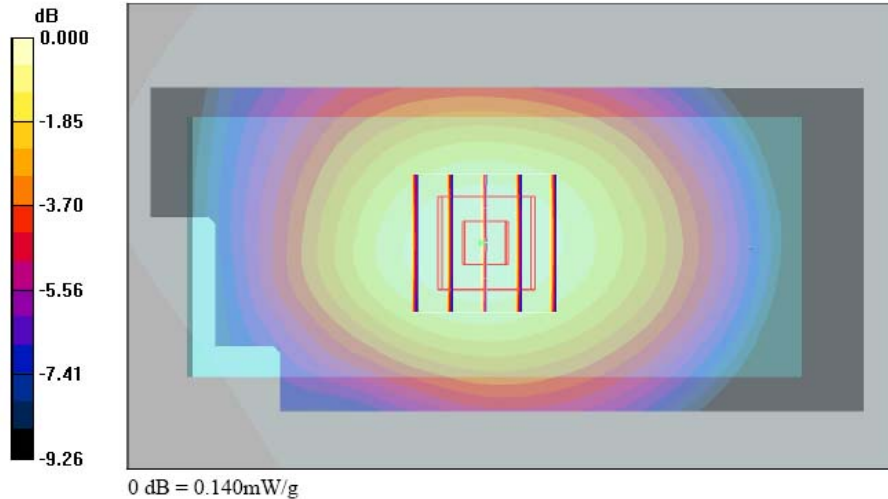



Test Laboratory: Sporton International Inc. SAR Testing Lab

Date: 2007/7/10

Body_GSM850 Ch189_Keypad Down with 1.5cm Gap_GPRS8_Scanner1

DUT: 762206

Communication System: GSM850; Frequency: 836.4 MHz; Duty Cycle: 1:8.3

Medium: MSL_850 Medium parameters used : $f = 836.4$ MHz; $\sigma = 0.972$ mho/m; $\epsilon_r = 54.8$; $\rho = 1000$ kg/m³

Ambient Temperature : 22.6 °C; Liquid Temperature : 21.2 °C

DASY4 Configuration:

- Probe: ET3DV6 - SN1788; ConvF(6.33, 6.33, 6.33); Calibrated: 2006/9/19
- Sensor-Surface: 4mm (Mechanical Surface Detection)
- Electronics: DAE3 Sn577; Calibrated: 2006/11/21
- Phantom: SAM-A; Type: QD 000 P40 C; Serial: TP-1303
- Measurement SW: DASY4, V4.7 Build 53; Postprocessing SW: SEMCAD, V1.8 Build 172

Ch189/Area Scan (51x111x1): Measurement grid: dx=15mm, dy=15mm

Maximum value of SAR (interpolated) = 0.184 mW/g

Ch189/Zoom Scan (5x5x7)/Cube 0: Measurement grid: dx=8mm, dy=8mm, dz=5mm

Reference Value = 12.3 V/m; Power Drift = -0.183 dB

Peak SAR (extrapolated) = 0.218 W/kg

SAR(1 g) = 0.172 mW/g; SAR(10 g) = 0.127 mW/g

Maximum value of SAR (measured) = 0.181 mW/g

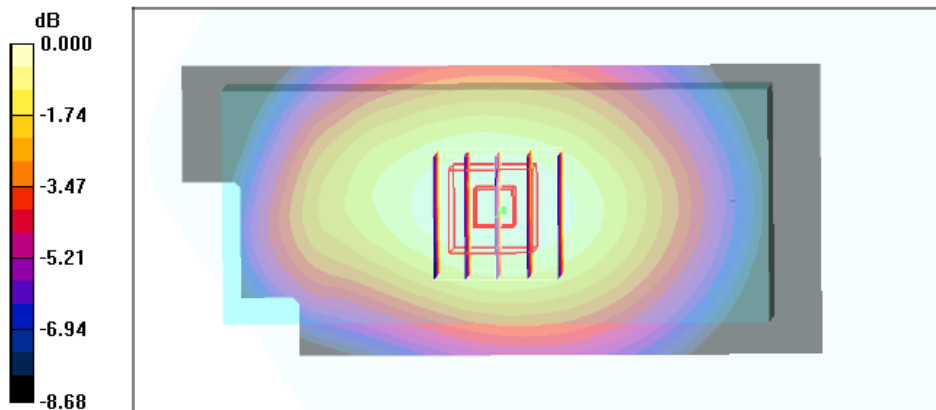

0 dB = 0.181mW/g



Test Laboratory: Sporton International Inc. SAR Testing Lab

Date : 2007/7/10

Body_GSM850 Ch251_Keypad Down with 1.5cm Gap_GPRS10_Scanner1

DUT: 762206

Communication System: GSM850; Frequency: 848.8 MHz; Duty Cycle: 1:4

Medium: MSL_850 Medium parameters used: $f = 849$ MHz; $\sigma = 0.985$ mho/m; $\epsilon_r = 54.7$; $\rho = 1000$ kg/m³

Ambient Temperature : 22.6 °C; Liquid Temperature : 21.2 °C

DASY4 Configuration:

- Probe: ET3DV6 - SN1788; ConvF(6.33, 6.33, 6.33); Calibrated: 2006/9/19

- Sensor-Surface: 4mm (Mechanical Surface Detection)

- Electronics: DAE3 Sn577; Calibrated: 2006/11/21

- Phantom: SAM-A; Type: QD 000 P40 C; Serial: TP-1303

- Measurement SW: DASY4, V4.7 Build 53; Postprocessing SW: SEMCAD, V1.8 Build 172

Ch251/Area Scan (51x111x1): Measurement grid: dx=15mm, dy=15mm

Maximum value of SAR (interpolated) = 0.379 mW/g

Ch251/Zoom Scan (5x5x7)/Cube 0: Measurement grid: dx=8mm, dy=8mm, dz=5mm

Reference Value = 10.2 V/m; Power Drift = -0.111 dB

Peak SAR (extrapolated) = 0.449 W/kg

SAR(1 g) = 0.357 mW/g; SAR(10 g) = 0.263 mW/g

Maximum value of SAR (measured) = 0.377 mW/g

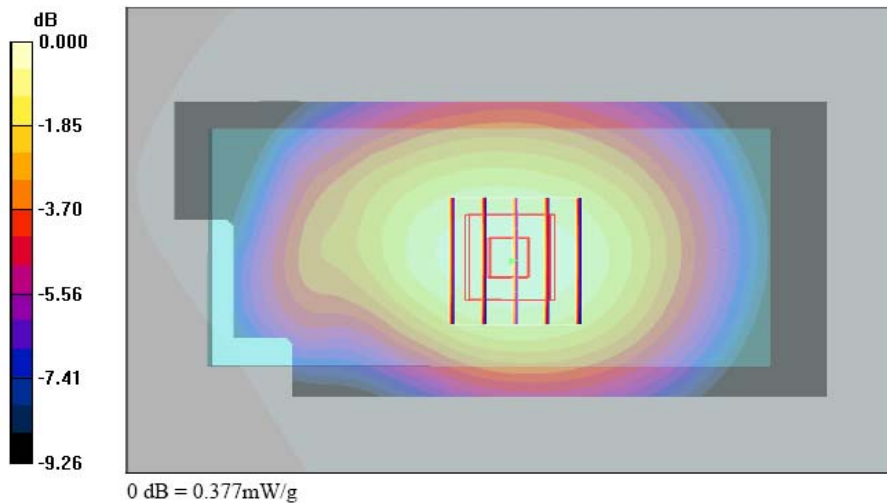



Test Laboratory: Sporton International Inc. SAR Testing Lab

Date : 2007/7/10

Body_GSM850 Ch251_Keypad Down with 1.5cm Gap_GPRS10_Scanner1_Bluetooth On

DUT: 762206

Communication System: GSM850; Frequency: 848.8 MHz; Duty Cycle: 1:4

Medium: MSL_850 Medium parameters used: $f = 849$ MHz; $\sigma = 0.985$ mho/m; $\epsilon_r = 54.7$; $\rho = 1000$ kg/m³

Ambient Temperature : 22.6 °C; Liquid Temperature : 21.2 °C

DASY4 Configuration:

- Probe: ET3DV6 - SN1788; ConvF(6.33, 6.33, 6.33); Calibrated: 2006/9/19

- Sensor-Surface: 4mm (Mechanical Surface Detection)

- Electronics: DAE3 Sn577; Calibrated: 2006/11/21

- Phantom: SAM-A; Type: QD 000 P40 C; Serial: TP-1303

- Measurement SW: DASY4, V4.7 Build 53; Postprocessing SW: SEMCAD, V1.8 Build 172

Ch251/Area Scan (51x111x1): Measurement grid: dx=15mm, dy=15mm

Maximum value of SAR (interpolated) = 0.413 mW/g

Ch251/Zoom Scan (5x5x7)/Cube 0: Measurement grid: dx=8mm, dy=8mm, dz=5mm

Reference Value = 8.61 V/m; Power Drift = -0.148 dB

Peak SAR (extrapolated) = 0.495 W/kg

SAR(1 g) = 0.387 mW/g; SAR(10 g) = 0.285 mW/g

Maximum value of SAR (measured) = 0.411 mW/g

